

# PCNL Percutaneous Nephrolithotomy



Your system for stone management

# MINI PCNL SYSTEM



12  
CHARR.

MINI PCNL



Closure system

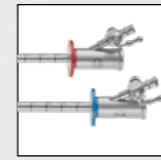

Mini PCNL sheaths with additional part

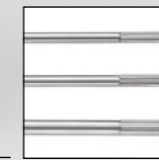

One-Step-Dilators in different sizes



Mini Scope with minimal diameter for the maximum visualization

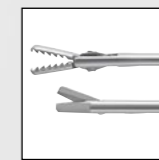

The right instrument for all stones

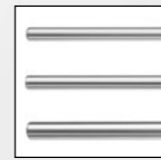

Long mini PCNL sheaths for the vacuum cleaner effect

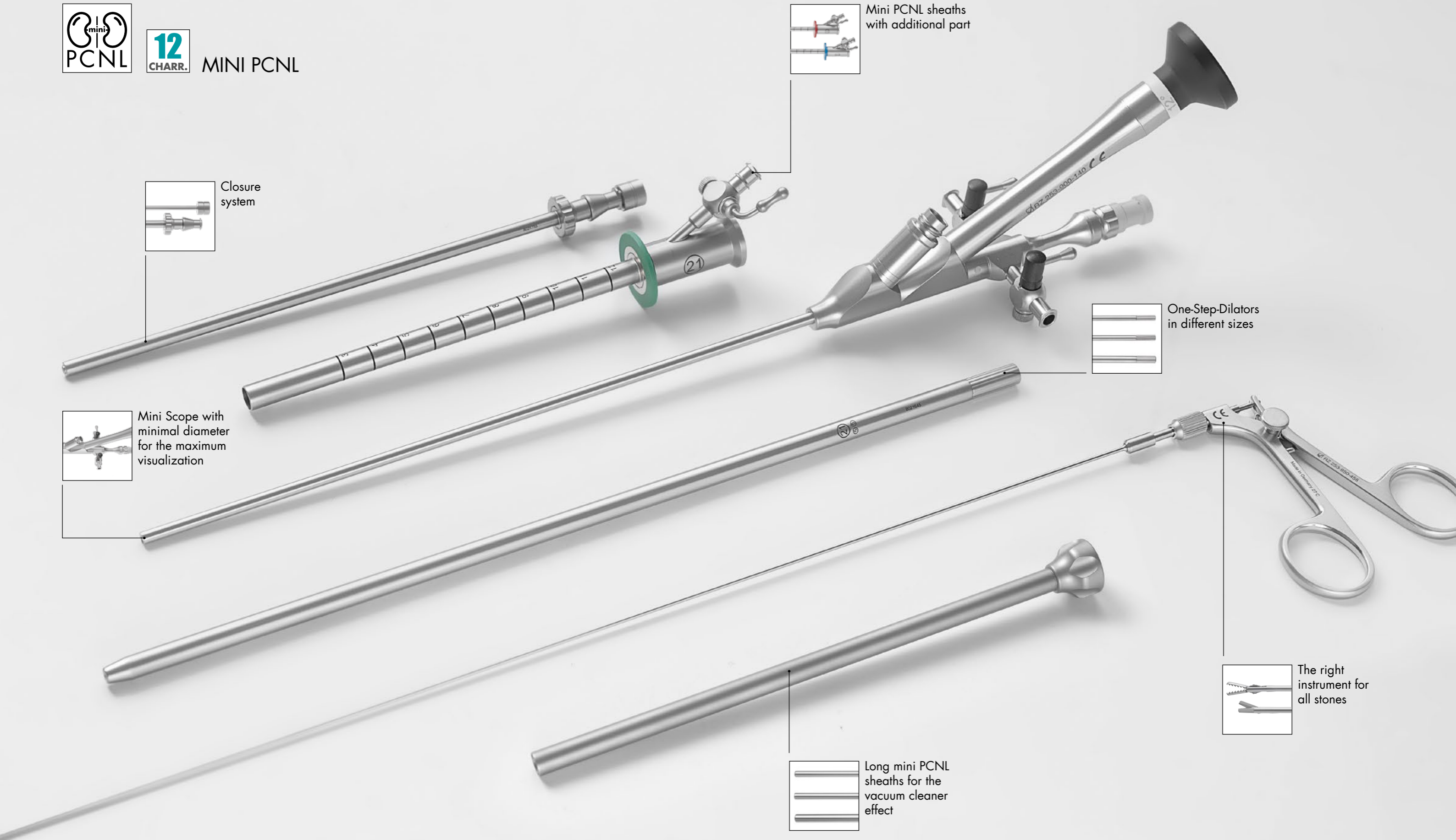

# MINI PCNL SYSTEM



## 12 Charr. MINI NEPHROSCOPE

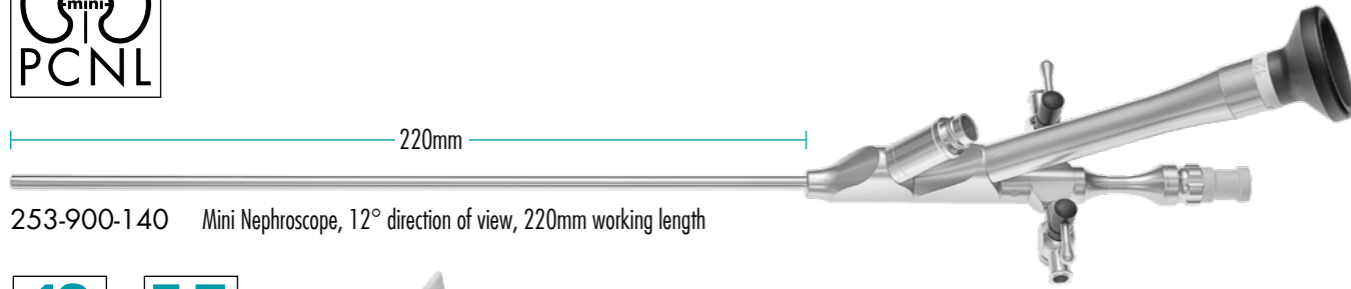

253-900-140 Mini Nephroscope, 12° direction of view, 220mm working length

**12**  
CHARR.  
Ø SHAFT

**7.5**  
CHARR.  
WORKING CHANNEL\*

\* for use with instruments up to 5 Charr.



253-905-400  
Silicone Valve,  
package with 5 pieces



253-900-010  
Silicone Valve, package with 10 pieces,  
for use with very delicate instruments  
from 0.5 – 1.6mm diameter.

### Mini PCNL Operating Sheaths with valve



253-900-141 15.0 Charr. ●



253-900-142 16.5 Charr. ●

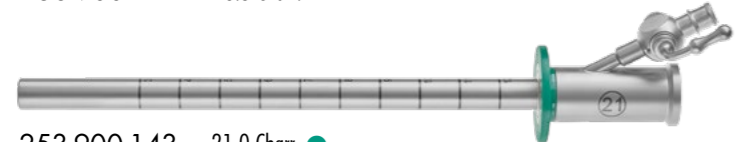

253-900-143 21.0 Charr. ●

### Mini PCNL Sheaths

253-900-171 15.0 Charr.  
253-900-175 16.5 Charr.  
253-900-173 21.0 Charr.

### One-Step Dilators with 1 central guide wire channel

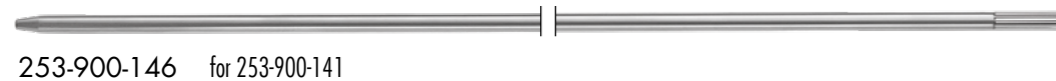

253-900-146 for 253-900-141

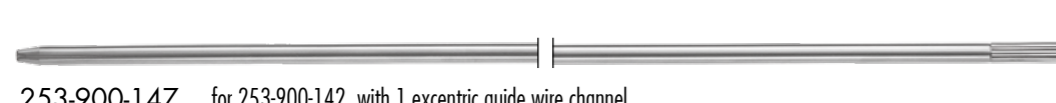

253-900-147 for 253-900-142, with 1 excentric guide wire channel

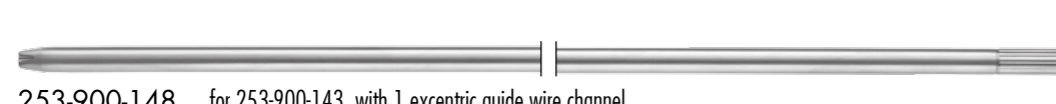

253-900-148 for 253-900-143, with 1 excentric guide wire channel



253-900-145 2-piece Sealing Adapter with sheath  
and obturator for use with 253-900-141

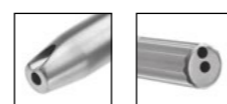
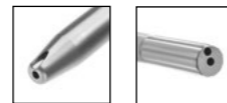
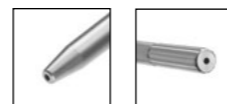

## RZ NEPHROSCOPY INSTRUMENTS

semi-rigid, 5 Charr.

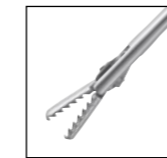
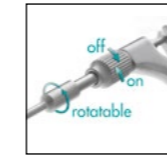
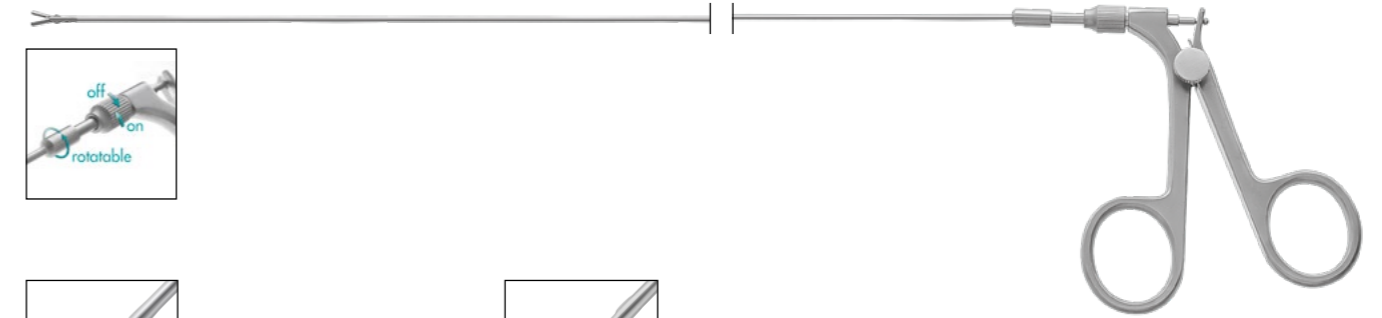

Stone Grasping Forceps,  
double action jaws, retrograde serration  
253-950-455 450mm working length

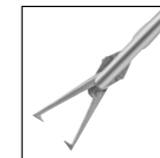

Stone Grasping Forceps  
for large stones, double action jaws, 1 x 1 teeth  
253-952-455\* 450mm working length



Hamada Long Stone Grasping Forceps,  
double action jaws, fine serrated  
253-954-455 450mm working length

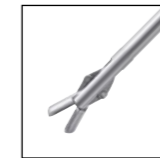

Biopsy Forceps,  
double action jaws  
253-956-455 450mm working length

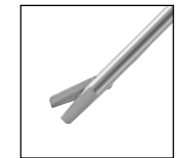

Scissors,  
single action jaws  
253-958-455 450mm working length

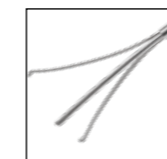

253-960-360 Stone grasping forceps, rigid, 5 Charr., 400mm,  
for grasping of bigger stones&fragments  
triple toothed jaw, U-spring handle

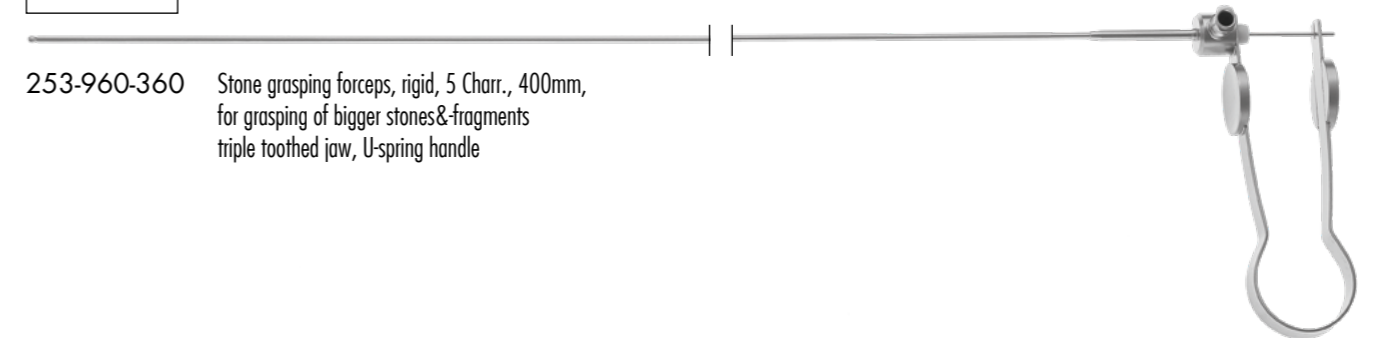

253-900-200 Sterile disposable Guide wire, J-tip, flexible, 150cm length



# COMPACT NEPHROSCOPE



## COMPACT NEPHROSCOPE



### COMPACT NEPHROSCOPE COMPONENTS

- 1 Compact Nephroscope, 12°/30°, with adapter
- 2 Shaft with Obturator (23 Charr)
- 3 Nephroscope Instruments

# COMPACT NEPHROSCOPE

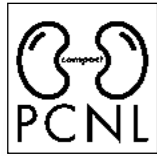

## RZ COMPACT NEPHROSCOPE

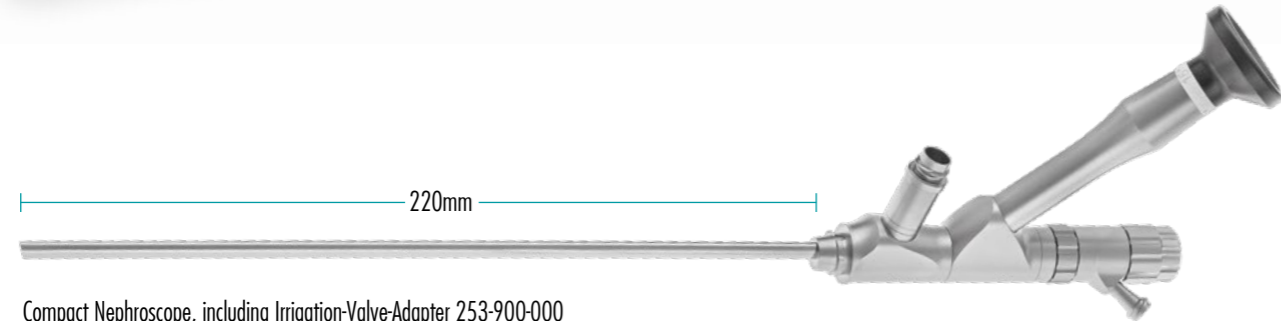
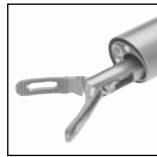

Compact Nephroscope, including Irrigation-Valve-Adapter 253-900-000  
 18.8 Charr., 12.9 Charr working channel  
 253-900-815 15°  
 253-900-830 30°

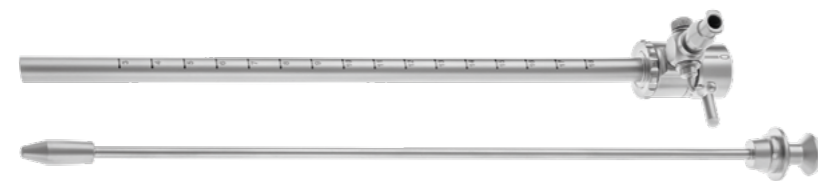

Suitable Shaft, with obturator, 23 Charr., 220mm working length  
 253-900-888



253-900-000  
 Irrigation-Valve-Adapter

# STANDARD PCNL

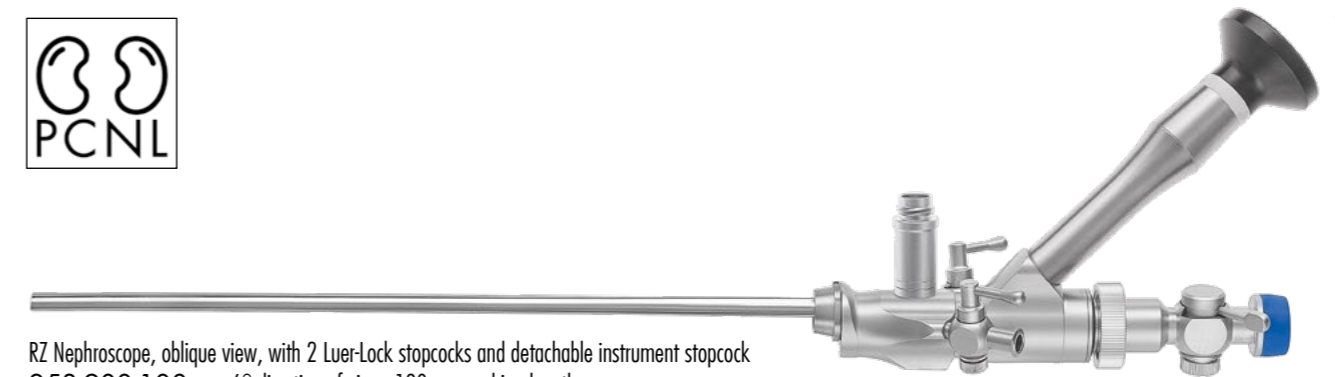
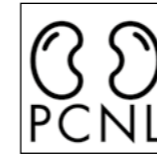

RZ Nephroscope, oblique view, with 2 Luer-Lock stopcocks and detachable instrument stopcock  
 253-900-100 6° direction of view, 190mm working length  
 253-900-120 6° direction of view, 250mm working length  
 253-900-150 15° direction of view, 190mm working length  
 253-900-160 15° direction of view, 250mm working length



253-900-105 Stopcock, only for use with RZ Nephrosopes

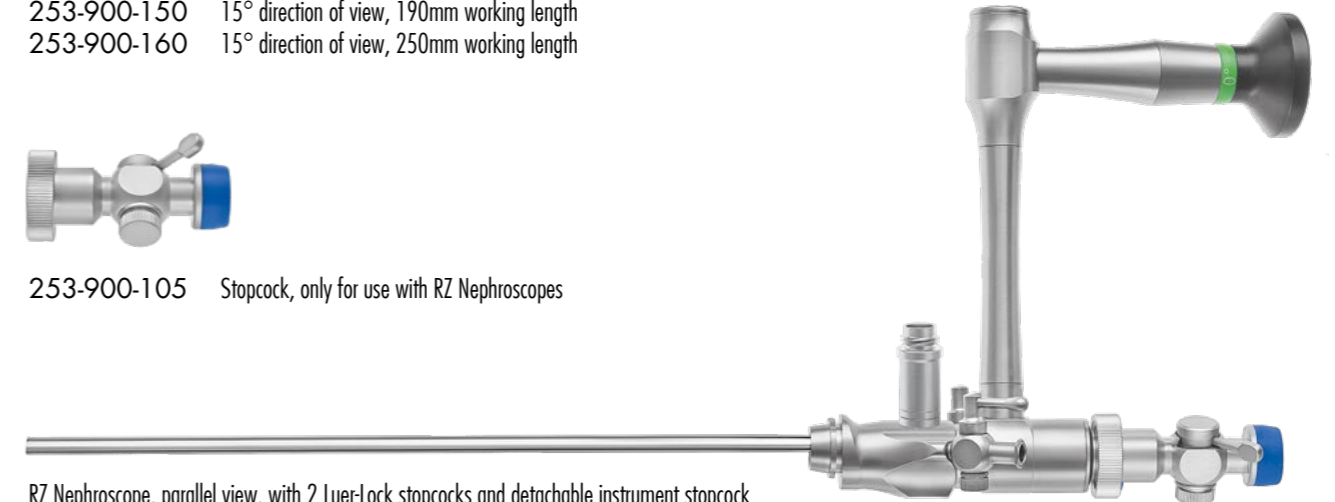

RZ Nephroscope, parallel view, with 2 Luer-Lock stopcocks and detachable instrument stopcock  
 253-900-101 6° direction of view, 190mm working length  
 253-900-121 6° direction of view, 250mm working length  
 253-900-151 15° direction of view, 190mm working length  
 253-900-161 15° direction of view, 250mm working length



Operating Sheaths  
 253-900-110 26 Charr., 190mm working length ●  
 253-900-111 24 Charr., 190mm working length ●  
 253-900-130 26 Charr., 250mm working length ●  
 253-900-131 24 Charr., 250mm working length ●



Hollow Obturators  
 253-900-115 26 Charr., 190mm working length ●  
 253-900-116 24 Charr., 190mm working length ●  
 253-900-135 26 Charr., 250mm working length ●  
 253-900-136 24 Charr., 250mm working length ●



# STANDARD PCNL

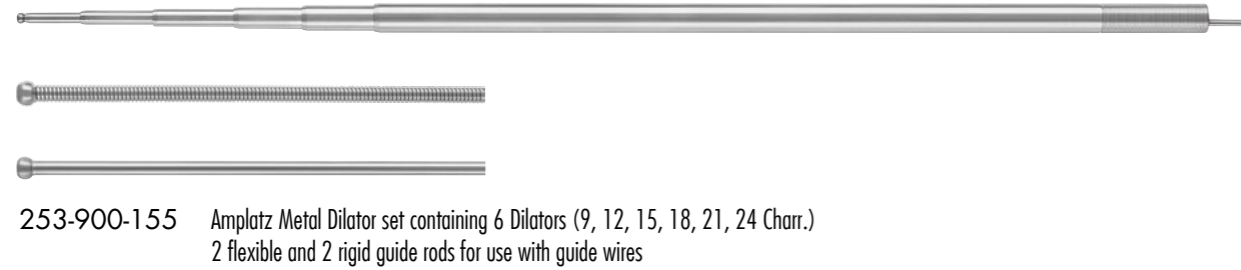

253-900-155 Amplatz Metal Dilator set containing 6 Dilators (9, 12, 15, 18, 21, 24 Charr.)  
2 flexible and 2 rigid guide rods for use with guide wires



Amplatz Metal Dilator  
253-900-156 27 Charr.  
253-900-157 30 Charr.

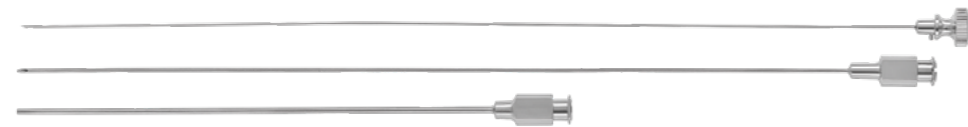

253-900-201 Puncture Cannula with inner and outer cannula



253-900-202 Dilation Cannula, 3mm  $\varnothing$  with inner and outer cannula



253-900-200 Sterile disposable Guide wire, J-tip, flexible, 150cm length

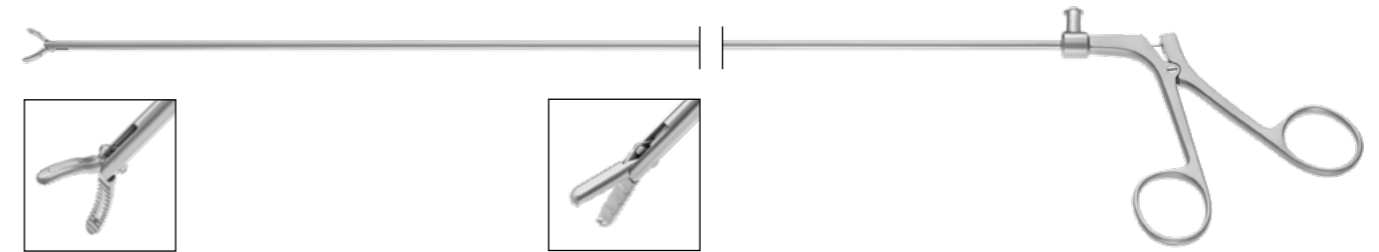

Stone Grasping forceps with fenestrated jaws,  
double action, with flushing port  
253-900-210\* 360mm working length  
253-900-250\* 430mm working length



Stone Grasping forceps with coarse serrated jaws,  
double action  
253-900-212\* 360mm working length  
253-900-252\* 430mm working length



Biopsy forceps with sharp cup,  
single action  
253-900-211 360mm working length  
253-900-251 430mm working length

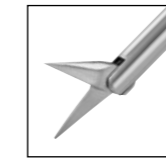

Scissors, sharp tip,  
single action  
253-900-213 360mm working length  
253-900-253 430mm working length

Stone Grasping Forceps with spring handle and finger platform  
 $\varnothing$  4mm, Luer-Lock connection

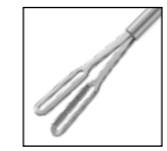

Fenestrated jaws  
253-900-205 360mm  
253-900-245 450mm



3 prongs  
253-900-206 360mm  
253-900-246 450mm

Knives, with three-ring-handle, 10.5Charr., 360mm length



253-900-238  
Straight Knife



253-900-239  
Sickle Knife



## RZ Medizintechnik GmbH

Unter Hasslen 20  
78532 Tuttlingen, Germany

Phone: +49 (0)7462/9470-0  
Fax: +49 (0)7462/9470-50

[sales@rz-medizintechnik.com](mailto:sales@rz-medizintechnik.com)  
[www.rz-medizintechnik.com](http://www.rz-medizintechnik.com)



Products marked with this symbol  
are not available with RZ-marking,  
and not the CE sign/CE number  
of RZ.

