

THORACIC & VASCULAR SURGERY

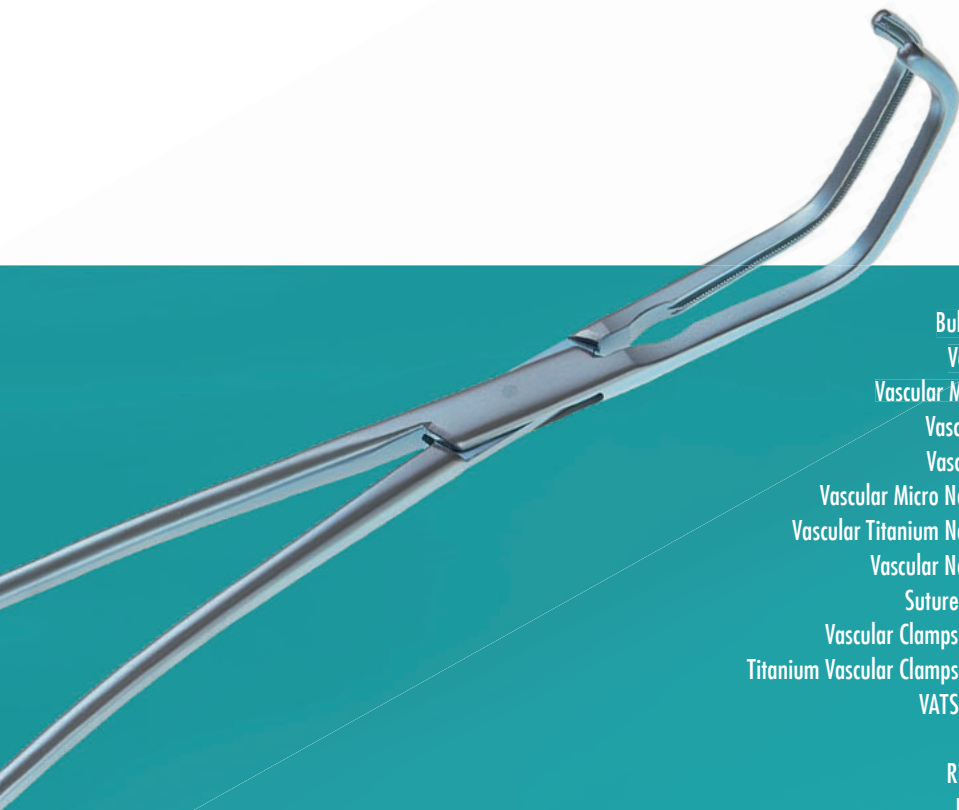

Bulldog Clamps
Vessel Clamps
Vascular Micro Scissors
Vascular Scissors
Vascular Forceps
Vascular Micro Needle Holder
Vascular Titanium Needle Holder
Vascular Needle Holder
Suture Instruments
Vascular Clamps and Forceps
Titanium Vascular Clamps and Forceps
VATS Instruments
Rib Shears
Rib Raspatory
Rib Spreader
Phlebectomy Instruments
Vessel Probes
Dilators
Intima Instruments
Tourniquets
Punches
Probes and Retractors

Ss



DIEFFENBACH

Bulldog Clamp, stainless steel, extra delicate serrations, straight

35mm	140-114-035
40mm	140-114-040
50mm	140-114-050
60mm	140-114-060
curved	
35mm	140-115-035
40mm	140-115-050
50mm	140-115-055
60mm	140-115-060

Ss



JOHNS HOPKINS

Bulldog Clamp, stainless steel, straight

38mm	140-050-038
48mm	140-050-050
56mm	140-050-057
63mm	140-050-063
70mm	140-050-070
80mm	140-050-076
90mm	140-050-090
curved	
38mm	140-051-038
48mm	140-051-050
56mm	140-051-057
63mm	140-051-063
70mm	140-051-070
80mm	140-051-076
90mm	140-051-090

Suitable for Applying Forceps: 140-152-230

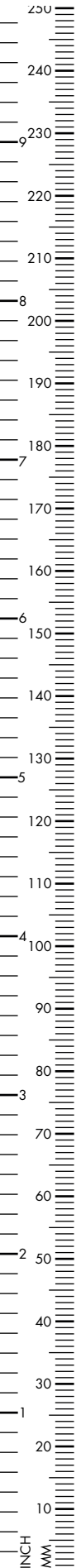



CLOSING PRESSURE

V (Vein): 110g (±10g)
A (Artery): 220g (±10g)

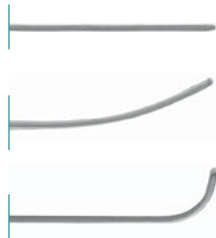

Ti

MINI GLOVER

Bulldog Clamp, Titanium

very delicate serrations, straight

(V) 30mm/9mm	140-116-030
(A) 30mm/9mm	140-116-130
(V) 35mm/13mm	140-116-035
(A) 35mm/13mm	140-116-135
(V) 40mm/14mm	140-116-040
(A) 40mm/14mm	140-116-140
(V) 50mm/23mm	140-116-050
(A) 50mm/23mm	140-116-150

slightly curved

(V) 30mm/9mm	140-117-030
(A) 30mm/9mm	140-117-130
(V) 35mm/13mm	140-117-035
(A) 35mm/13mm	140-117-135
(V) 40mm/14mm	140-117-040
(A) 40mm/14mm	140-117-140
(V) 50mm/23mm	140-117-050
(A) 50mm/23mm	140-117-150

strongly curved

(V) 30mm/9mm	140-118-030
(A) 30mm/9mm	140-118-130
(V) 35mm/13mm	140-118-035
(A) 35mm/13mm	140-118-135
(V) 40mm/14mm	140-118-040
(A) 40mm/14mm	140-118-140
(V) 50mm/23mm	140-118-050
(A) 50mm/23mm	140-118-150

Ss

MINI GLOVER

Bulldog Clamp, Stainless Steel

very delicate serrations, straight

(V) 30mm/9mm	140-130-030
(A) 30mm/9mm	140-130-130
(V) 35mm/13mm	140-130-035
(A) 35mm/13mm	140-130-135
(V) 40mm/14mm	140-130-040
(A) 40mm/14mm	140-130-140
(V) 50mm/23mm	140-130-050
(A) 50mm/23mm	140-130-150

slightly curved

(V) 30mm/9mm	140-131-030
(A) 30mm/9mm	140-131-130
(V) 35mm/13mm	140-131-035
(A) 35mm/13mm	140-131-135
(V) 40mm/14mm	140-131-040
(A) 40mm/14mm	140-131-140
(V) 50mm/23mm	140-131-050
(A) 50mm/23mm	140-131-150

strongly curved

(V) 30mm/9mm	140-132-030
(A) 30mm/9mm	140-132-130
(V) 35mm/13mm	140-132-035
(A) 35mm/13mm	140-132-135
(V) 40mm/14mm	140-132-040
(A) 40mm/14mm	140-132-140
(V) 50mm/23mm	140-132-050
(A) 50mm/23mm	140-132-150

Suitable for Applying Forceps: 140-130-240

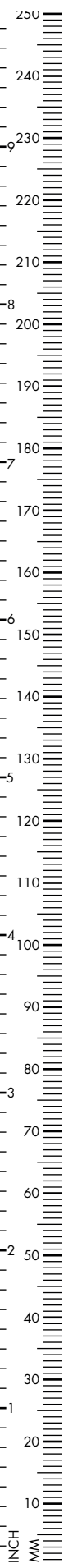

DEBAKEY

Bulldog Clamp, stainless steel,
delicate atraumatic serrations, straight

75mm	140-120-075
85mm	140-120-085
100mm	140-120-105
120mm	140-120-120
curved	
75mm	140-119-075
85mm	140-119-085
100mm	140-119-105
120mm	140-119-120

COOLEY

Bulldog Clamp, stainless steel,
Cooley serrations, straight

75mm	290-440-075
85mm	290-440-085
100mm	290-440-100
120mm	290-440-120
curved	
75mm	290-441-075
85mm	290-441-085
100mm	290-441-100
120mm	290-441-120

Suitable for Applying Forceps: 140-152-250



DEBAKEY DIETHRICH

Micro Coronary Bulldog Clamp, stainless steel,
atraumatic serrations, straight

10mm/45mm	290-120-010
14mm/50mm	290-120-014
20mm/60mm	290-120-020

curved

10mm/45mm	290-122-010
14mm/50mm	290-122-014
20mm/60mm	290-122-020

CLOSING PRESSURE

Debakey: 180g (±10g)
Diethrich: 50g (±10g)



DIETHRICH

Micro Coronary Bulldog Clamp, stainless steel,
straight

8mm/45mm	140-125-080
12mm/50mm	140-125-120
20mm/60mm	140-125-200

curved

8mm/45mm	140-122-080
12mm/50mm	140-122-120
20mm/60mm	140-122-200

angled

10mm/35mm	290-121-010
14mm/45mm	290-121-014
20mm/60mm	290-121-020

angled

8mm/35mm	140-121-080
12mm/45mm	140-121-120
20mm/60mm	140-121-200

Ss



DIETRICH

Micro Coronary Bulldog Clamp, stainless steel,
without serrations, straight

8mm/45mm	140-008-045
12mm/50mm	140-012-050
20mm/60mm	140-020-060

curved

8mm/45mm	140-208-045
12mm/50mm	140-212-050
20mm/60mm	140-220-060

angled

8mm/35mm	140-108-045
12mm/45mm	140-112-050
20mm/60mm	140-120-060

Ss

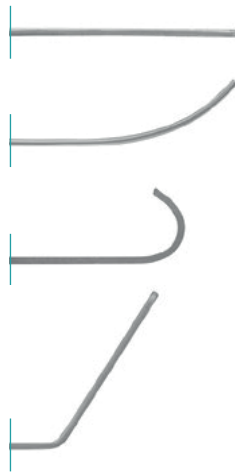

WELDON

Bulldog Clamp, stainless steel,
very delicate serrations, straight

35mm	140-013-035
45mm	140-022-045
slightly curved	
35mm	140-015-035
45mm	140-023-045

strongly curved

35mm	140-016-035
45mm	140-024-045

angled

35mm	140-017-035
45mm	140-025-045

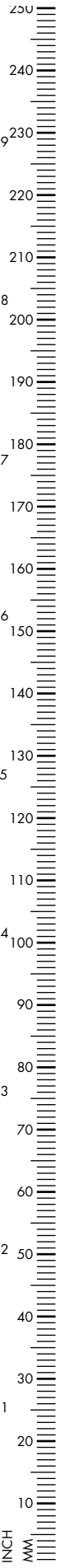

Ss



CLOSING PRESSURE
adjustable



DEBAKEY GLOVER

Bulldog Clamp, stainless steel,
delicate atraumatic serrations, straight

20mm/60mm	140-130-060
30mm/75mm	140-130-070
43mm/90mm	140-130-090
56mm/110mm	140-130-110

curved

20mm/60mm	140-131-060
30mm/75mm	140-131-070
43mm/90mm	140-131-090
56mm/110mm	140-131-110

angled

27mm/55mm	140-132-060
-----------	-------------



COOLEY GLOVER

Bulldog Clamp, stainless steel,
Cooley serrations, straight

20mm/60mm	290-432-060
30mm/75mm	290-432-075
43mm/90mm	290-432-090
56mm/110mm	290-432-110

curved

20mm/60mm	290-433-060
30mm/75mm	290-433-075
43mm/90mm	290-433-090
56mm/110mm	290-433-110

CLOSING PRESSURE
adjustable

Ss

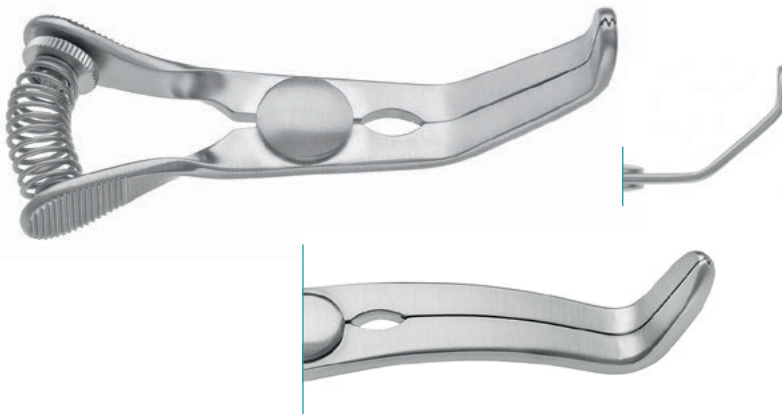

DEBAKEY GLOVER SATINSKY

Bulldog Clamp, stainless steel,
delicate atraumatic serrations,
double angulation

38mm/70mm	140-133-060
63mm/100mm	140-133-100

S_s

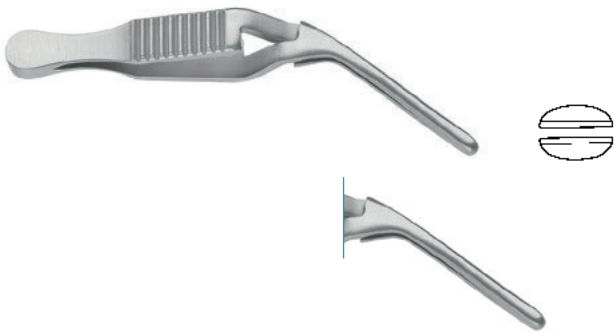

HESS

Bulldog Clamp, stainless steel,
delicate serrations, angled

20mm jaw	140-056-020
30mm jaw	140-056-030

S_s

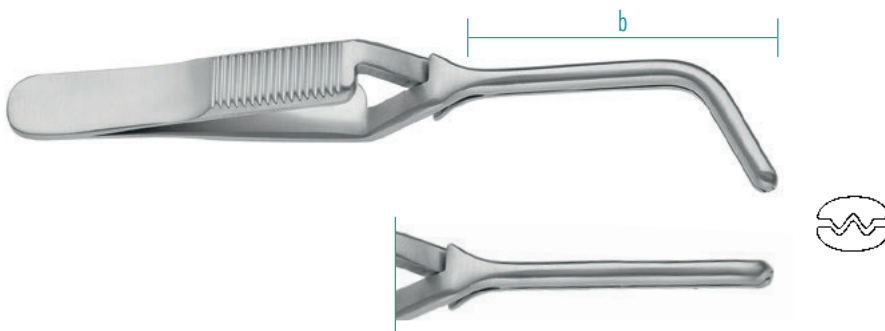

DEBAKEY GREGORY SOFT

Bulldog Clamp, stainless steel,
delicate atraumatic serrations, straight

Total length: 90mm b = 27mm	140-015-090
Total length: 110mm b = 44mm	140-015-110
angled	
Total length: 90mm b = 55mm	140-014-090
Total length: 110mm b = 60mm	140-014-110

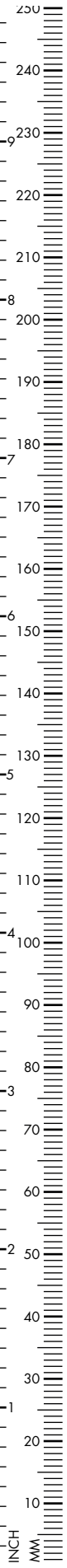

Ss

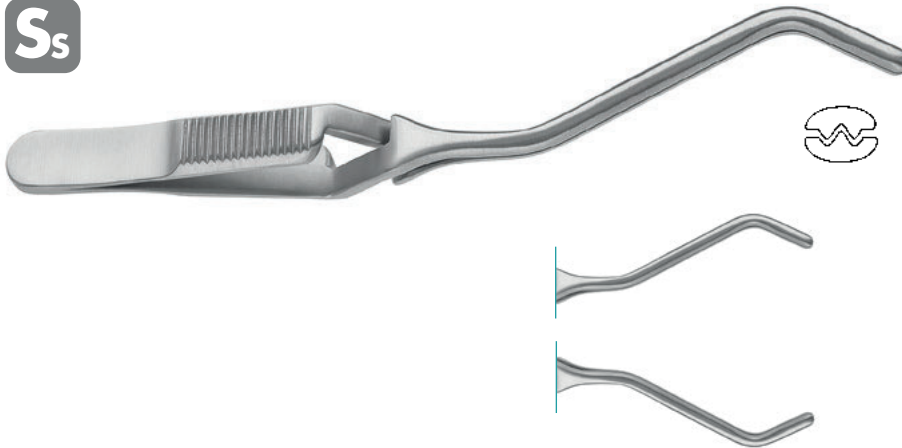

DEBAKEY GREGORY

Bulldog Clamp, stainless steel,
delicate atraumatic serrations, left angled

Total length: 110mm 140-014-025

right angled

Total length: 110mm 140-114-025

Ss



DEBAKEY SANTULLI

Bulldog Clamp, stainless steel,
delicate atraumatic serrations, curved

Total length: 70mm 140-135-070

S_s

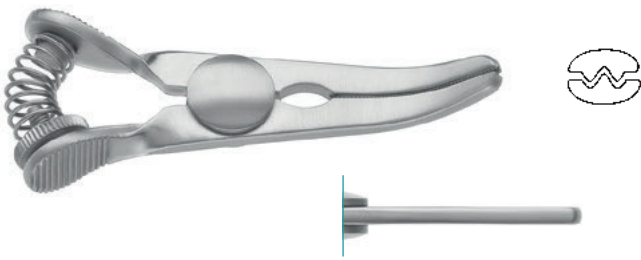

CLOSING PRESSURE
adjustable

DEBAKEY GLOVER DELICATE

Bulldog Clamp, stainless steel,
extra delicate atraumatic serrations, straight

20mm/50mm 290-410-050

S_s

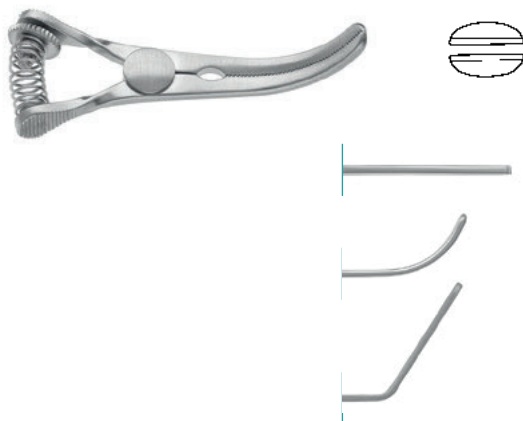

CLOSING PRESSURE
adjustable

POTTS (JACOBSON)

Bulldog Clamp, stainless steel,
very delicate serrations, 45mm

straight 290-410-045

curved 290-411-045

angled 290-412-045

S_s

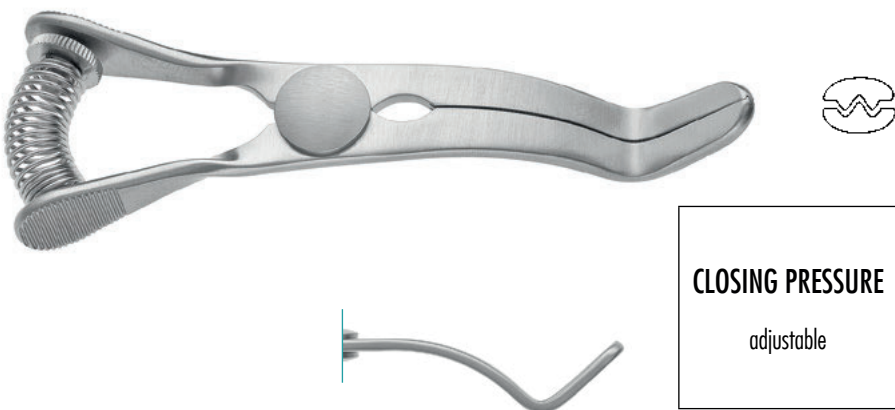

CLOSING PRESSURE
adjustable

DEBAKEY CAROTID

Bulldog Clamp, stainless steel,
delicate atraumatic serrations, special curved

90mm 140-133-095

S_s

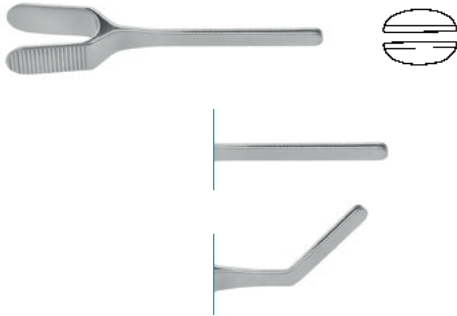

CLOSING PRESSURE

30g

FEATHERLIGHT

Bulldog Clamp, stainless steel, very delicate serrations, straight

10mm/30mm	140-310-030
14mm/35mm	140-314-035
18mm/40mm	140-318-040

angled

10mm/30mm	140-410-030
14mm/35mm	140-414-035
18mm/40mm	140-418-040

T_i



TITANIUM SHUNT

Bulldog Clamp, titanium, smooth jaw without any serrations, 95mm, 3³/₄" , 10Fr

10°	290-795-010
25°	290-795-025
45°	290-795-045
60°	290-795-060

12Fr

10°	290-795-210
25°	290-795-225
45°	290-795-245
60°	290-795-260

14Fr

10°	290-795-410
25°	290-795-425
45°	290-795-445
60°	290-795-460

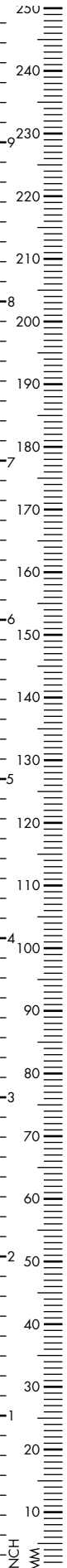

Ti

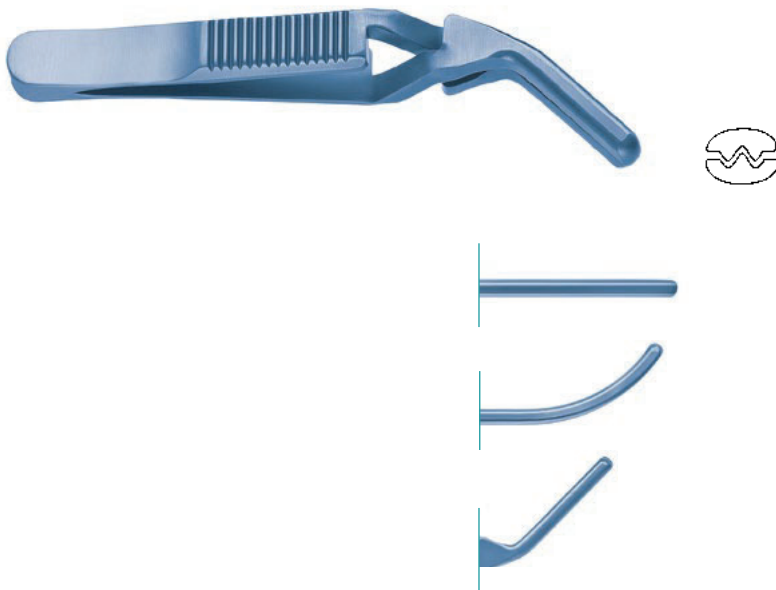

DEBAKEY ATRAUMA TITANIUM

Bulldog Clamp, titanium,
extra delicate atraumatic serrations,
straight

70mm	290-740-070
80mm	290-740-080
90mm	290-740-090
100mm	290-740-100
110mm	290-740-110
120mm	290-740-120
130mm	290-740-130

curved

70mm	290-743-070
80mm	290-743-080
90mm	290-743-090
100mm	290-743-100
110mm	290-743-110
120mm	290-743-120
130mm	290-743-130

angled

70mm	290-745-070
80mm	290-745-080
90mm	290-745-090
100mm	290-745-100
110mm	290-745-110
120mm	290-745-120
130mm	290-745-130

Ti



DEBAKEY DIETRICH

Bulldog Clamp, titanium,
extra delicate atraumatic serrations, straight

10mm	290-760-010
14mm	290-760-014
20mm	290-760-020

curved

10mm	290-762-010
14mm	290-762-014
20mm	290-762-020

angled

10mm	290-761-010
14mm	290-761-014
20mm	290-761-020



DIETRICH

Extra delicate serrations, straight

8mm	140-760-008
12mm	140-760-012
20mm	140-760-020

curved

8mm	140-762-008
12mm	140-762-012
20mm	140-762-020

angled

8mm	140-761-008
12mm	140-761-012
20mm	140-761-020

Ss



WICKHAM

Bulldog Clamp, stainless steel,
very delicate serrations, straight

13mm/49mm	140-108-013
18mm/54mm	140-108-018
25mm/61mm	140-108-025

curved

13mm/47mm	140-109-013
18mm/51mm	140-109-018
25mm/65mm	140-109-025

angled

13mm/48mm	140-110-013
18mm/52mm	140-110-018
25mm/49mm	140-110-026

CLOSING PRESSURE

150g (±10g)

Suitable for Applying Forceps: 140-108-230

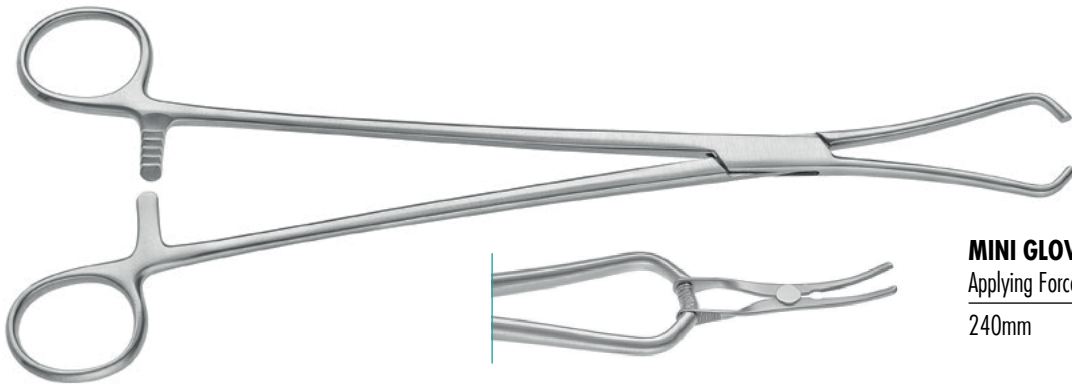

MINI GLOVER

Applying Forceps

240mm

140-130-240

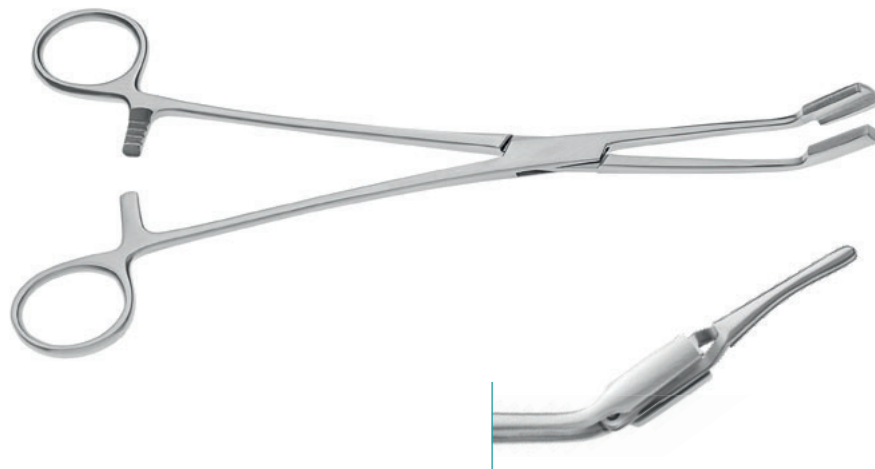

JOHNS HOPKINS

Applying Forceps

230mm

140-152-230

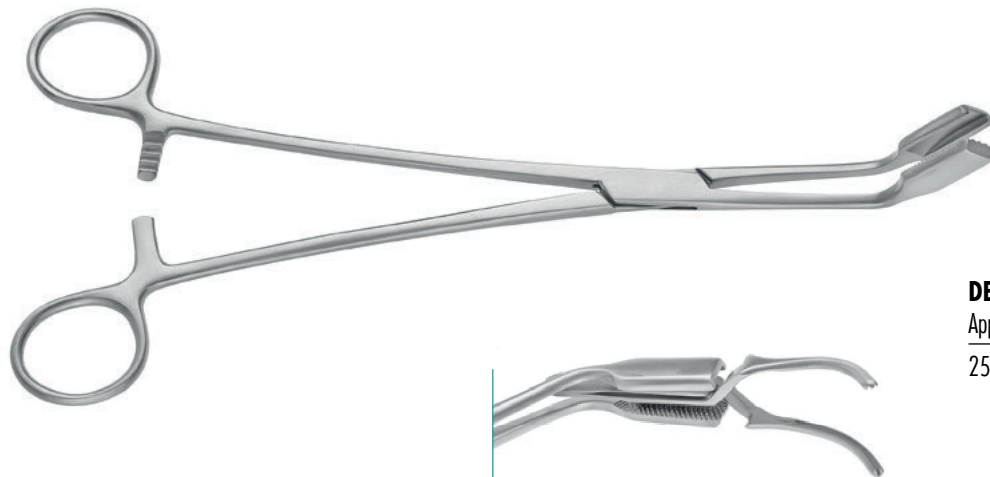

DEBAKEY ATRAUMA

Applying Forceps

250mm

140-152-250



WICKHAM

Applying Forceps

230mm

140-108-230

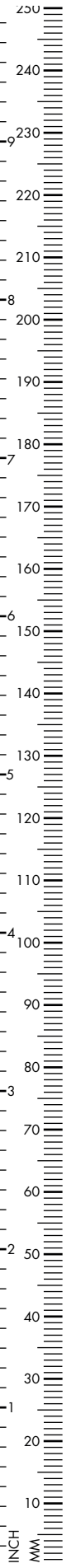

**CLOSING
PRESSURE**
300 - 375g

Titanium Bulldog Clamp, straight,
Code V (Vein), blue

17mm jaw	300-100-773TV
25mm jaw	300-100-774TV
45mm jaw	300-100-771TV
60mm jaw	300-100-772TV



**CLOSING
PRESSURE**
475 - 500g

Titanium Bulldog Clamp, straight,
Code A (Artery), red

17mm jaw	300-100-773TA
25mm jaw	300-100-774TA
45mm jaw	300-100-771TA
60mm jaw	300-100-772TA



Vascular Bulldog Clamp, curved

17mm jaw	300-100-776
25mm jaw	300-100-777
45mm jaw	300-100-778
60mm jaw	300-100-779



**CLOSING
PRESSURE**
450 - 475g

Vascular Bulldog Clamp, straight

17mm jaw	300-100-773
25mm jaw	300-100-774
45mm jaw	300-100-771
60mm jaw	300-100-772



**CLOSING
PRESSURE**
450 - 475g

SATINSKY

Vascular Bulldog Clamp, upwards angled

60mm jaw	300-100-786
----------	-------------



**CLOSING
PRESSURE**
450 - 475g

SATINSKY

Vascular Bulldog Clamp

60mm jaw	300-100-789
----------	-------------

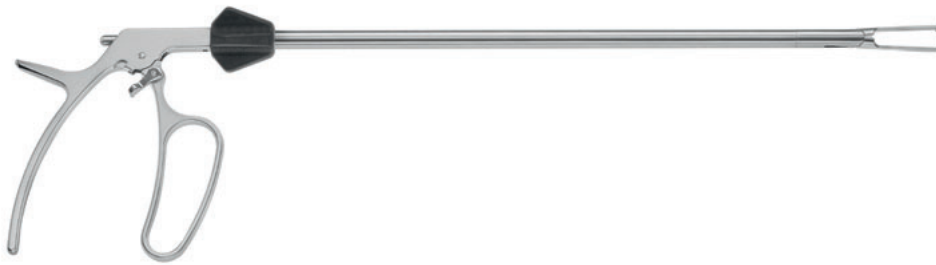

Endoscopic Bulldog Clamp Applier,
detachable, 10mm, rotating

330mm, 13" 300-410-775



Endoscopic Bulldog Clamp Applier,
detachable (insert only)

300-401-775

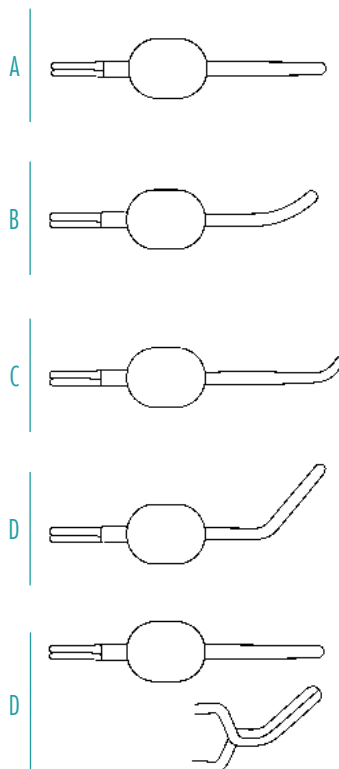

MÜLLER

Vessel Clip, atraumatic,
50g closing pressure

A straight	250-065-010
B curved	250-065-011
C curved tip	250-065-012
D angled to side	250-065-013
E knee-bent	250-065-014

80g closing pressure

A straight	250-065-020
B curved	250-065-021
D angled to side	250-065-023
E knee-bent	250-065-024



MÜLLER

Vessel Clip, atraumatic, straight

250g closing pressure	250-065-030
-----------------------	-------------

350g closing pressure	250-065-040
-----------------------	-------------



MÜLLER

Vessel Clip, atraumatic, angled

250g closing pressure	250-065-031
-----------------------	-------------

350g closing pressure	250-065-041
-----------------------	-------------



MÜLLER

Vessel Clip, atraumatic, curved

250g closing pressure	250-065-032
-----------------------	-------------

350g closing pressure	250-065-042
-----------------------	-------------



MÜLLER

Vessel Clip, atraumatic, knee bent

250g closing pressure	250-065-034
-----------------------	-------------

350g closing pressure	250-065-044
-----------------------	-------------

SINGLE CLAMPS (PACKED IN PAIRS)

FIG. 1 8mm, Vessel \varnothing 0.3-1.0mm

(A) matt	270-001-001
(A) black	270-001-101
(V) matt	270-101-001
(V) black	270-101-101



FIG. 2 11mm, Vessel \varnothing 0.6-1.4mm

(A) matt	270-001-002
(A) black	270-001-102
(V) matt	270-101-002
(V) black	270-101-102



FIG. 3 16mm, Vessel \varnothing 1.0-2.2mm

(A) matt	270-001-003
(A) black	270-001-103
(V) matt	270-101-003
(V) black	270-101-103



FIG. 4 24mm, Vessel \varnothing 1.5-3.3mm

(A) matt	270-001-004
(A) black	270-001-104
(V) matt	270-101-004
(V) black	270-101-104



FIG. 5 35mm, Vessel \varnothing 2.0-5.0mm

(A) matt	270-001-005
(A) black	270-001-105
(V) matt	270-101-005
(V) black	270-101-105



DOUBLE CLAMPS APPROXIMATOR, ADJUSTABLE

FIG. 1 8mm, Vessel \varnothing 0.3-1.0mm

(A) matt	270-002-001
(A) black	270-002-101
(V) matt	270-102-001
(V) black	270-102-101



FIG. 2 11mm, Vessel \varnothing 0.6-1.4mm

(A) matt	270-002-002
(A) black	270-002-102
(V) matt	270-102-002
(V) black	270-102-102



FIG. 3 16mm, Vessel \varnothing 1.0-2.2mm

(A) matt	270-002-003
(A) black	270-002-103
(V) matt	270-102-003
(V) black	270-102-103



FIG. 4 24mm, Vessel \varnothing 1.5-3.3mm

(A) matt	270-002-004
(A) black	270-002-104
(V) matt	270-102-004
(V) black	270-102-104



FIG. 5 35mm, Vessel \varnothing 2.0-5.0mm

(A) matt	270-002-005
(A) black	270-002-105
(V) matt	270-102-005
(V) black	270-102-105

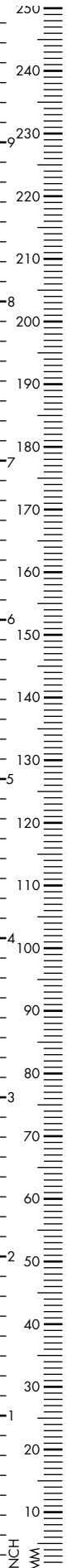

DOUBLE CLAMPS APPROXIMATOR WITH FRAME, ADJUSTABLE



FIG. 1 8mm, Vessel \varnothing 0.3-1.0mm

(A) matt	270-003-001
(A) black	270-003-101
(V) matt	270-103-001
(V) black	270-103-101



FIG. 2 11mm, Vessel \varnothing 0.6-1.4mm

(A) matt	270-003-002
(A) black	270-003-102
(V) matt	270-103-002
(V) black	270-103-102



FIG. 3 16mm, Vessel \varnothing 1.0-2.2mm

(A) matt	270-003-003
(A) black	270-003-103
(V) matt	270-103-003
(V) black	270-103-103



CLAMP APPLYING FORCEPS

140mm, 5¹/₂" , without ratchet, straight

For Fig. 1+2	270-103-140
For Fig. 3	270-104-160

with ratchet, straight

For Fig. 1+2	270-108-140
For Fig. 3	270-105-160

without ratchet, 30° angled

For Fig. 1+2	270-104-140
For Fig. 3	270-106-140

with ratchet, 30° angled

For Fig. 1+2	270-105-140
For Fig. 3	270-107-140

DOUBLE CLAMPS WITH FRAME



FIG. 1 8mm, Vessel \varnothing 0.3-1.0mm

(A) matt	270-004-001
(A) black	270-004-101
(V) matt	270-104-001
(V) black	270-104-101



FIG. 2 11mm, Vessel \varnothing 0.6-1.4mm

(A) matt	270-004-002
(A) black	270-004-102
(V) matt	270-104-002
(V) black	270-104-102



FIG. 3 16mm, Vessel \varnothing 1.0-2.2mm

(A) matt	270-004-003
(A) black	270-004-103
(V) matt	270-104-003
(V) black	270-104-103

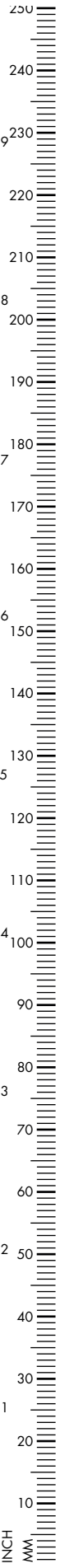

RZ DC-SINGLE CLAMP, ARTERY (PACKED IN PAIRS)

8mm, Vessel \varnothing 0.3-1.0mm



(A) matt	270-005-001
(A) black	270-005-101
(V) matt	270-105-001
(V) black	270-105-101

11mm, Vessel \varnothing 0.6-1.4mm



(A) matt	270-005-002
(A) black	270-005-102
(V) matt	270-105-002
(V) black	270-105-102

16mm, Vessel \varnothing 1.0-2.2mm



(A) matt	270-005-003
(A) black	270-005-103
(V) matt	270-105-003
(V) black	270-105-103

RADIAL CLAMPS



RZ-1 8mm, Vessel \varnothing 0.3-1.0mm

matt	270-010-001
black	270-110-001



RZ-2 11mm, Vessel \varnothing 0.6-1.4mm

matt	270-010-002
black	270-110-002



RZ-6 16mm, Vessel \varnothing 1.0-2.2mm

matt	270-010-003
black	270-110-003



RZ-6 8mm, Vessel \varnothing 0.3-1.0mm, straight

(A) matt	270-010-004
(A) black	270-110-004



BIEMER

Micro Approximator
 jaw length: 6mm, opening: 4mm

250-064-571



BIEMER MÜLLER

Approximator, 9mm jaw,
 25-30g closing pressure

straight 250-064-611

angled 250-064-612



BIEMER

Vessel Clip, jaw opening 4.0mm
 Length of jaw 6.0mm

30-40g closing pressure 250-064-560

Jaw opening 5.0mm

Length of jaw 9.0mm

30-40g closing pressure 250-064-561

Jaw opening 5.0mm

Length of jaw 9.0mm

20-25g closing pressure 250-064-562



BIEMER

Applying Forceps, 145mm, 5³/₄"

without lock 250-064-568

with lock 250-064-569

DOUBLE CLAMPS APPROXIMATOR WITH FRAME, ADJUSTABLE



Fig. 1, 8mm, Vessel \varnothing 0.3 - 0.8mm

(A) matt 270-003-201

(V) matt 270-103-201

Fig. 2, 11mm, Vessel \varnothing 0.6 - 1.4mm

(A) matt 270-003-202

(V) matt 270-103-202

Fig. 3, 16mm, Vessel \varnothing 1.0 - 2.2mm

(A) matt 270-003-203

(V) matt 270-103-203

DOUBLE CLAMPS WITH FRAME



Fig. 1, 8mm, Vessel \varnothing 0.3 - 0.8mm

(A) matt 270-004-201

(V) matt 270-104-201

Fig. 2, 11mm, Vessel \varnothing 0.6 - 1.4mm

(A) matt 270-004-202

(V) matt 270-104-202

Fig. 3, 16mm, Vessel \varnothing 1.0 - 2.2mm

(A) matt 270-004-203

(V) matt 270-104-203

MICRO VASCULAR SINGLE CLAMPS (PACKED IN PAIRS)



Fig. 1, 8mm, Vessel \varnothing 0.3 - 0.8mm

(A) matt 270-001-201

(V) matt 270-101-201

Fig. 2, 11mm, Vessel \varnothing 0.6 - 1.4mm

(A) matt 270-001-202

(V) matt 270-101-202

Fig. 3, 16mm, Vessel \varnothing 1.0 - 2.2mm

(A) matt 270-001-203

(V) matt 270-101-203

Fig. 4, 24mm, Vessel \varnothing 1.5 - 3.3mm

(A) matt 270-001-204

(V) matt 270-101-204

Fig. 5, 35mm, Vessel \varnothing 2.0 - 4.0mm

(A) matt 270-001-205

(V) matt 270-101-205

DOUBLE CLAMPS APPROXIMATOR, ADJUSTABLE



Fig. 1, 8mm, Vessel \varnothing 0.3 - 0.8mm

(A) matt 270-002-201

(V) matt 270-102-201

Fig. 2, 11mm, Vessel \varnothing 0.6 - 1.4mm

(A) matt 270-002-202

(V) matt 270-102-202

Fig. 3, 16mm, Vessel \varnothing 1.0 - 2.2mm

(A) matt 270-002-203

(V) matt 270-102-203

Fig. 4, 24mm, Vessel \varnothing 1.5 - 3.3mm

(A) matt 270-002-204

(V) matt 270-102-204

Fig. 5, 35mm, Vessel \varnothing 2.0 - 5.0mm

(A) matt 270-002-205

(V) matt 270-102-205

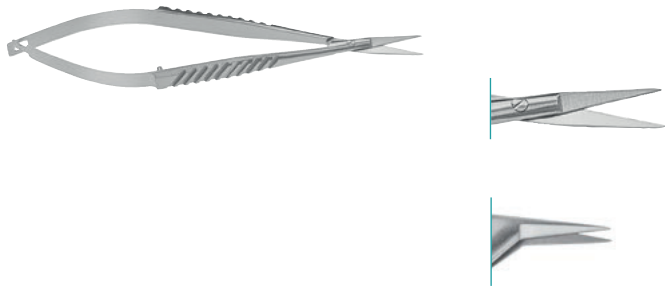

Adventitia Scissors, flat handle, straight
110mm, 4¹/₃"

13mm jaw 251-550-100

19mm jaw 251-550-110

150mm, 6"

15mm jaw 251-554-150

19mm jaw 251-550-150

19mm jaw (nerve) 251-552-150

180mm, 7"

20mm jaw 251-550-180

20mm jaw (nerve) 251-552-180

Adventitia Scissors, flat handle,
45° angled, 150mm, 6"

8mm jaw 251-563-150

45° angled, 180mm, 7"

12mm jaw 251-563-180

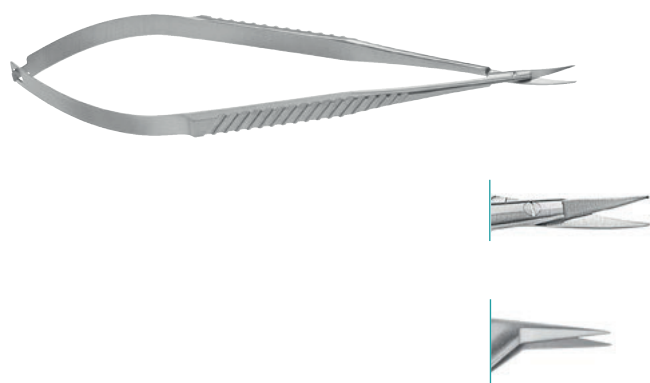

Dissecting Scissors, flat handle, curved
110mm, 4¹/₃"

13mm jaw 251-551-100

19mm jaw 251-551-110

20mm jaw (Westcott) 251-551-111

150mm, 6"

15mm jaw 251-555-150

19mm jaw 251-551-150

19mm jaw (nerve) 251-553-150

22mm jaw (Westcott) 251-551-151

180mm, 7"

20mm jaw 251-551-180

20mm jaw (nerve) 251-553-181

20mm (Westcott) 251-551-181

Dissecting Scissors, flat handle,
45° angled, 150mm, 6"

8mm jaw 251-556-150

45° angled, 180mm, 7"

12mm jaw 251-556-180

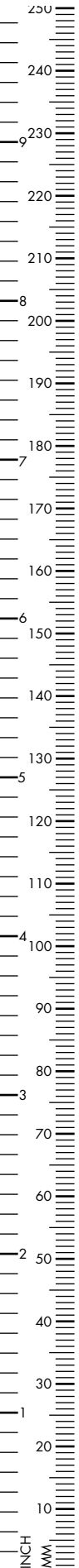

Ultra Fine Dissecting Scissors, flat handle,
12mm very delicate blade, 8mm handle width,
straight

150mm, 6" 251-566-150



Ultra Fine Adventitia Scissors, flat handle,
14mm very delicate blade, 8mm handle width,
straight

150mm, 6" 251-565-150



Dissecting Scissors, very delicate
curved, 12mm blade, Ø 8mm round handle

150mm, 6" 251-546-150

180mm, 7" 251-546-180



Adventitia Scissors, very delicate
straight, 14mm blade, Ø 8mm round handle

150mm, 6" 251-545-150

180mm, 7" 251-545-180

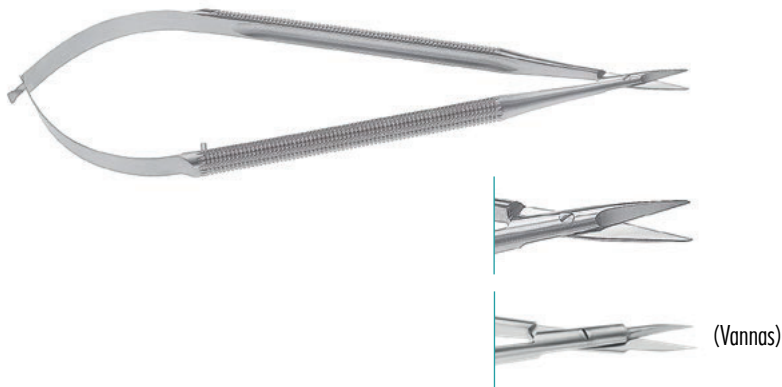

Adventitia Scissors, 7mm round handle, straight
120mm, 4^{3/4}"

11mm jaw 251-540-120

8mm round handle,
150mm, 6"

12mm jaw 251-540-150

12mm jaw (nerve) 251-542-150

12mm (Vannas) 251-560-150

8mm round handle,
170mm, 6^{2/3}"

10mm jaw 251-580-170

8mm round handle,
180mm, 7"

14mm jaw 120-178-180

14mm jaw (nerve) 251-542-180

10mm round handle,
180mm, 7"

14mm jaw 251-558-180

8mm round handle,
180mm, 7"

21mm jaw 251-540-210

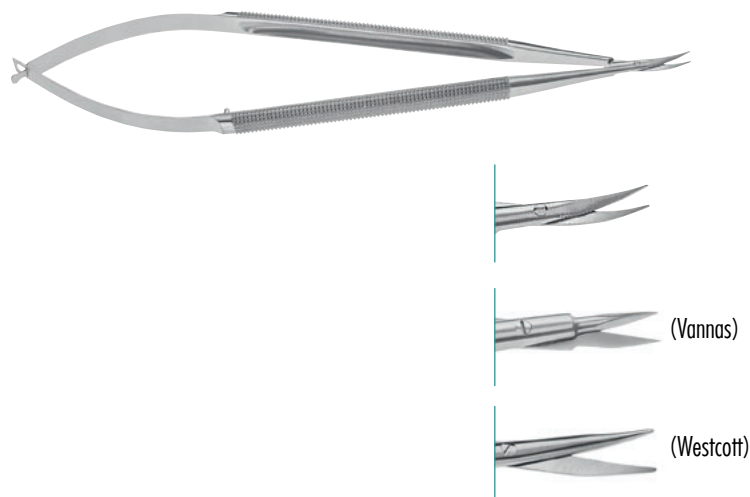

Dissecting Scissors, 7mm round handle, curved
120mm, 4^{3/4}"

11mm jaw 251-541-120

8mm round handle,
150mm, 6"

12mm jaw 251-541-150

12mm jaw (nerve) 251-543-150

12mm (Vannas) 251-559-150

20mm (Westcott) 251-541-151

8mm round handle,
180mm, 7"

14mm jaw 251-541-180

14mm jaw (nerve) 251-543-180

20mm (Westcott) 251-541-181

10mm round handle,
180mm, 7"

14mm jaw 251-557-180

8mm round handle,
210mm, 8^{1/4}"

21mm jaw 251-541-210

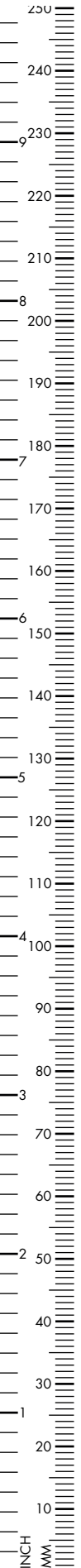

JACOBSON

Micro Scissors, 160mm, 6¹/₄"
sharp blades, 8mm round handle
7mm micro blades, angled

25°	120-164-025
45°	120-164-045
60°	120-164-060
90°	120-164-090
125°	120-164-125

10mm micro blades, angled

25°	120-164-225
45°	120-164-245
60°	120-164-260
90°	120-164-290
125°	120-164-325



JACOBSON

Micro Scissors, 180mm, 7"
sharp blades, 8mm round handle
14mm blades

25°	120-184-225
45°	120-184-245
60°	120-184-260
90°	120-184-290
125°	120-184-325

ball tip blades

25°	120-184-425
45°	120-184-445
60°	120-184-460
90°	120-184-490
125°	120-184-425



POTTS

Ø 3.5mm, 45° angled, single action
working length:

170mm, 6 ² / ₃ "	295-034-045
250mm, 9 ⁷ / ₈ "	295-035-045
300mm, 11 ⁷ / ₈ "	295-037-045



POTTS

Ø 3.5mm, 90° angled, single action
working length:

170mm, 6 ² / ₃ "	295-034-090
250mm, 9 ⁷ / ₈ "	295-035-090
300mm, 11 ⁷ / ₈ "	295-037-090



POTTS

Ø 3.5mm, 125° angled, single action
working length:

170mm, 6 ² / ₃ "	295-034-125
250mm, 9 ⁷ / ₈ "	295-035-125
300mm, 11 ⁷ / ₈ "	295-037-125



POTTS

Ø 5.0mm, 125° angled, single action
working length:

170mm, 6 ² / ₃ "	295-048-125
250mm, 9 ⁷ / ₈ "	295-050-125
300mm, 11 ⁷ / ₈ "	295-052-125



METZENBAUM

Ø 5.0mm, straight, single action
working length:

170mm, 6 ² / ₃ "	295-048-000
250mm, 9 ⁷ / ₈ "	295-050-000
300mm, 11 ⁷ / ₈ "	295-052-000



METZENBAUM

Ø 5.0mm, straight, double action
working length:

170mm, 6 ² / ₃ "	295-048-010
250mm, 9 ⁷ / ₈ "	295-050-010
300mm, 11 ⁷ / ₈ "	295-052-010



METZENBAUM

Ø 5.0mm, 15° curved, double action
working length:

170mm, 6 ² / ₃ "	295-048-015
250mm, 9 ⁷ / ₈ "	295-050-015
300mm, 11 ⁷ / ₈ "	295-052-015



JAMESON

Ø 5.0mm, 15° curved, double action
working length:

170mm, 6 ² / ₃ "	295-048-020
250mm, 9 ⁷ / ₈ "	295-050-020
300mm, 11 ⁷ / ₈ "	295-052-020



METZENBAUM

Ø 5.0mm, 30° curved, double action
working length:

170mm, 6 ² / ₃ "	295-048-030
250mm, 9 ⁷ / ₈ "	295-050-030
300mm, 11 ⁷ / ₈ "	295-052-030



METZENBAUM

Ø 5.0mm, 70° curved, double action
working length:

170mm, 6 ² / ₃ "	295-048-070
250mm, 9 ⁷ / ₈ "	295-050-070
300mm, 11 ⁷ / ₈ "	295-052-070



METZENBAUM

Ø 7.0mm, 15° curved, double action
working length:

170mm, 6 ² / ₃ "	295-069-015
250mm, 9 ⁷ / ₈ "	295-070-015
300mm, 11 ⁷ / ₈ "	295-071-015

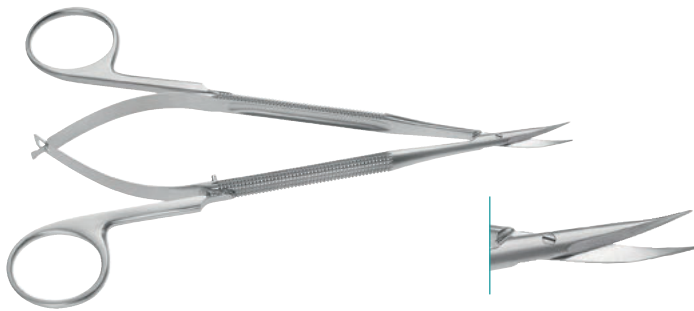

WESTCOTT

Dissecting Scissors, 8mm handle, curved
150mm, 6"

15mm jaw 251-570-150

20mm jaw 251-571-150

180mm, 7"

15mm jaw 251-570-180



LINCOLN

Vascular Scissors, straight

170mm, 6²/₃" 120-260-170

curved

170mm, 6²/₃" 120-261-170

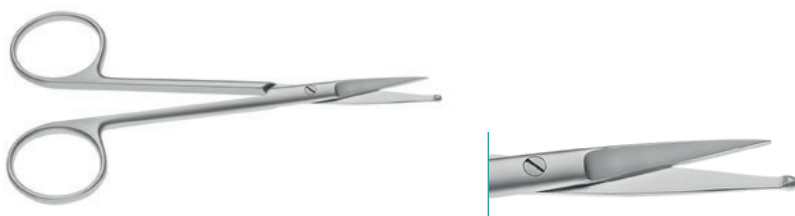

Coronary Scissors, probe-pointed tip

115mm, 4¹/₂" 120-420-115



DEBAKEY

Endarterectomy Scissors, 180mm, 7"

slightly curved	120-319-180
strongly curved	120-320-180

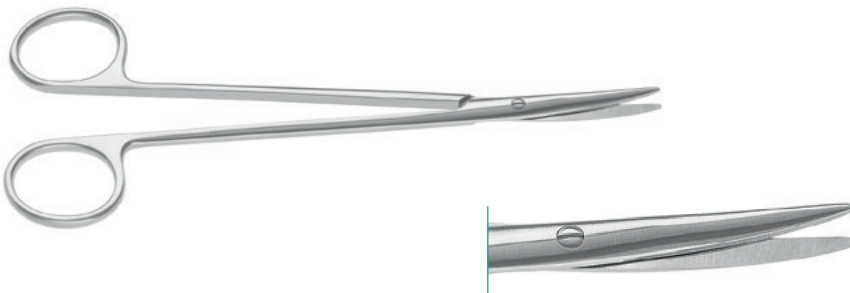

DE MARTEL

Vascular Scissors, 175mm, 6⁷/₈"

blunt	120-261-175
sharp	120-263-175

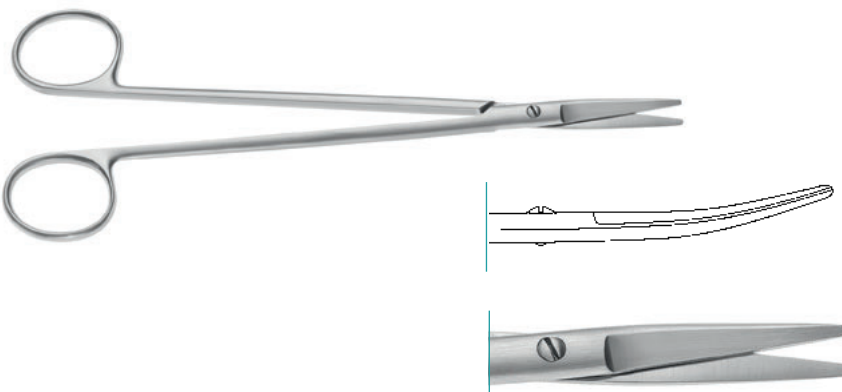

CHURCH

Vascular Scissors, slightly curved

170mm, 6 ² / ₃ "	120-255-170
255mm, 10"	120-255-255



THOMPSON

Valve Scissors, strong curved

250mm, 9⁷/₈"

120-205-250

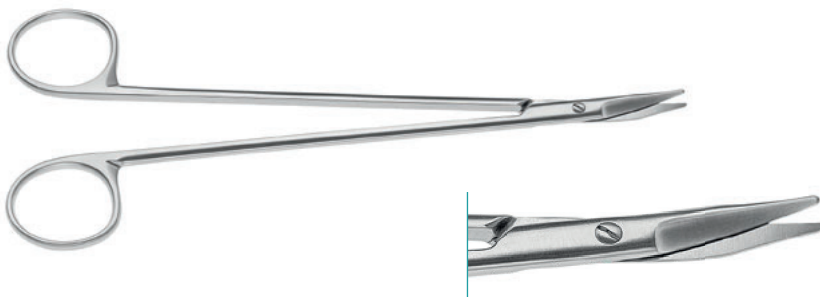

LAINÉ KINDAL

curved, tenotomy tip

180mm, 7"

125-282-778

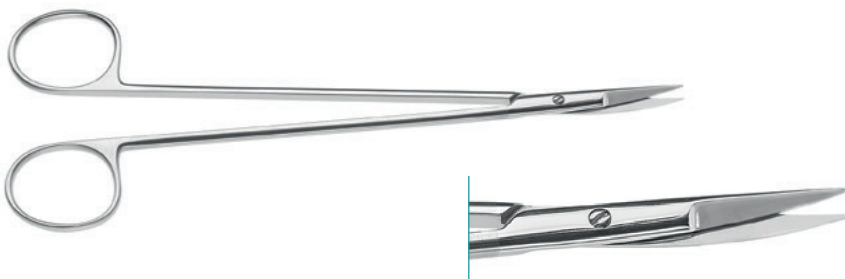

LAINÉ KINDAL

curved, sharp tip

180mm, 7"

125-282-776

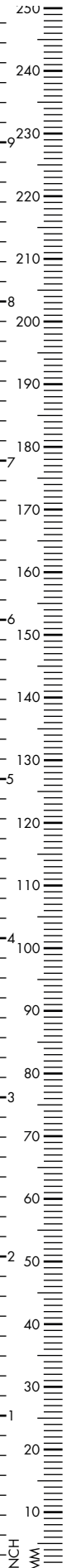



HOHENFELLER

S-curved

180mm, 7"	120-060-180
210mm, 8 ^{1/4} "	120-060-210
240mm, 9 ^{1/2} "	120-060-240



COOLEY

Vascular Scissors, curved

180mm, 7"	120-134-180
230mm, 9"	120-134-230



SATINSKY

Vascular Scissors, curved

245mm, 9 ^{2/3} "	120-203-245
---------------------------	-------------

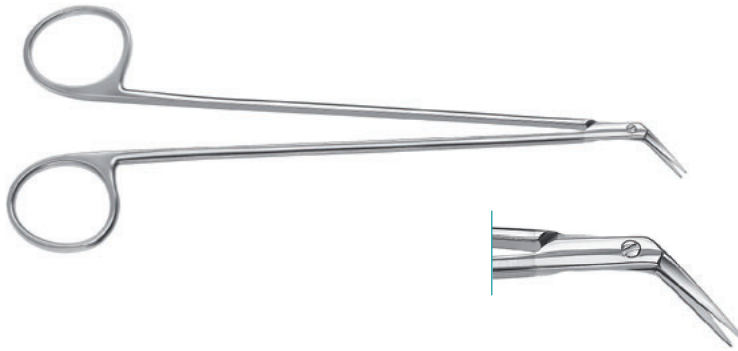

DIETRICH

sharp, extra delicate, 14mm, 180mm, 7"

25° 125-170-025

45° 125-170-045

60° 125-170-060

90° 125-170-090

125° 125-170-125

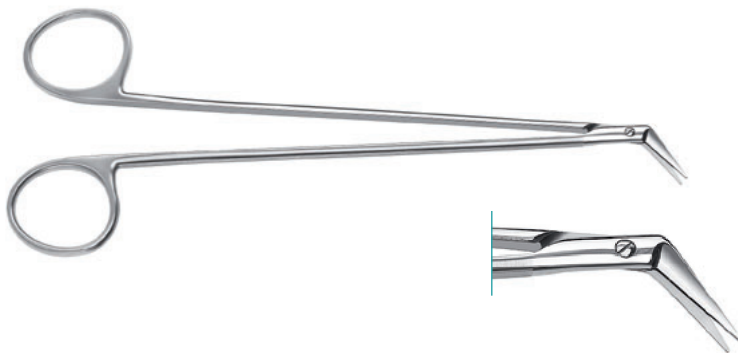

DIETRICH

delicate, 14mm, 180mm, 7"

25° 125-175-025

45° 125-175-045

60° 125-175-060

90° 125-175-090

125° 125-175-125

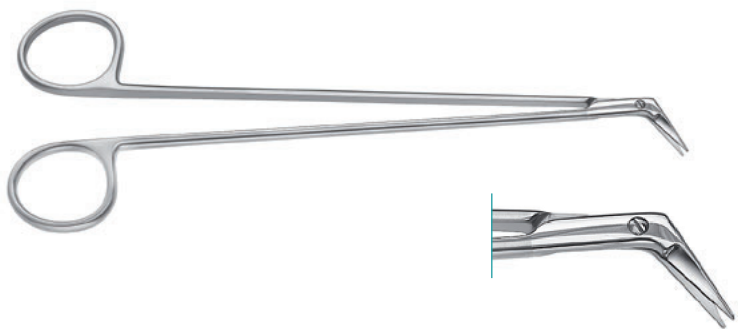

DIETRICH HEGEMANN

13mm, 180mm, 7"

25° 125-180-025

45° 125-180-045

60° 125-180-060

90° 125-180-090

125° 125-180-125



DIETRICH

Peripheral, 130mm, 5 1/8"

25°	125-130-025
45°	125-130-045
60°	125-130-060
90°	125-130-090
125°	125-130-125

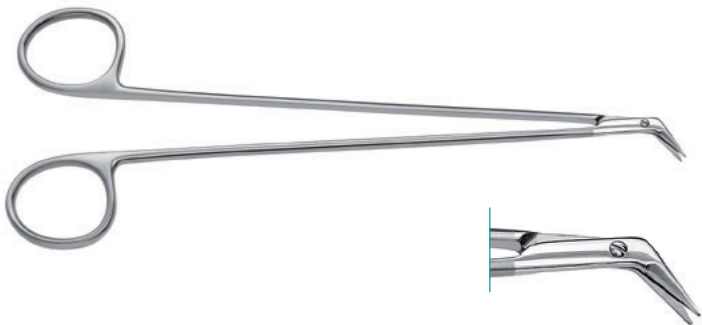

DIETRICH

sharp blade, 9mm, 180mm, 7"

25°	125-178-025
45°	125-178-045
60°	125-178-060
90°	125-178-090
125°	125-178-125

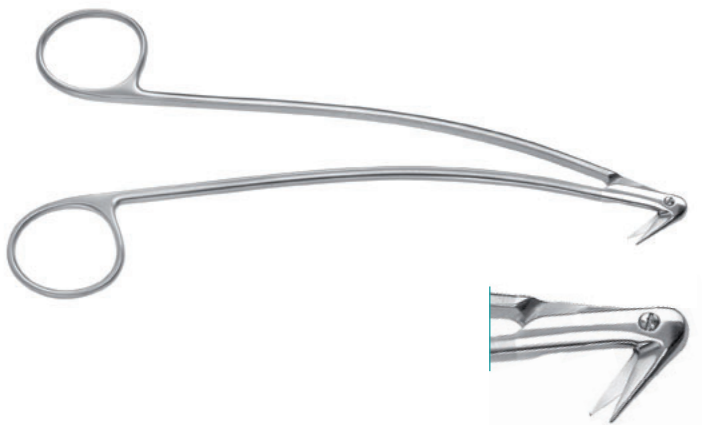

DIETRICH FAVALORO

13mm, 180mm, 7"

125°	125-185-125
------	-------------

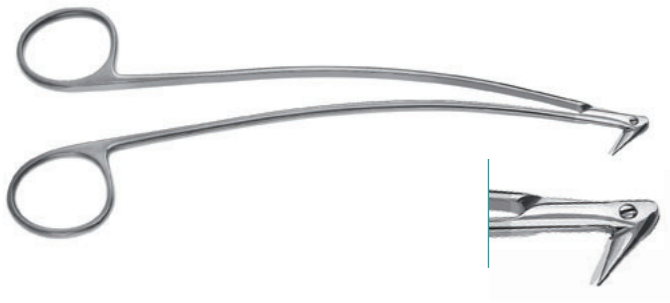

DIETHRICH FAVALORO

9mm, 170mm, 6³/₄"

125° 125-168-125

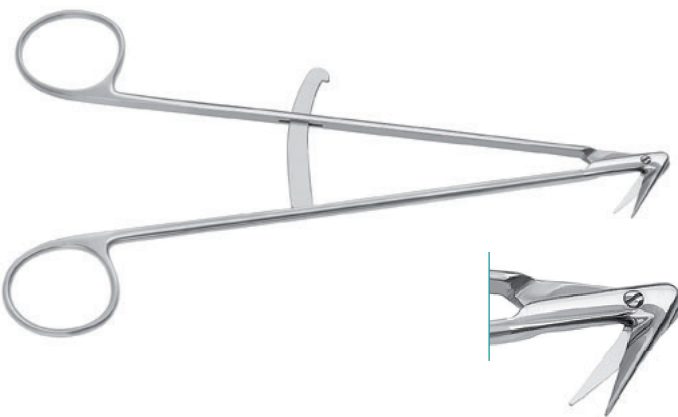

DIETHRICH ARTERY

13mm, 180mm, 7"

125° 125-200-125



BEALL

Circumflex, 150mm, 6"

115° 125-300-115

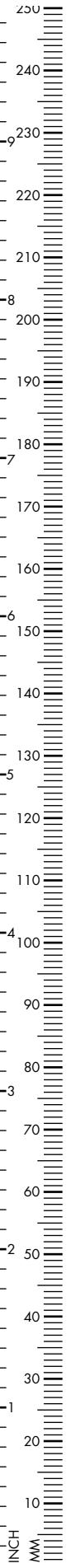

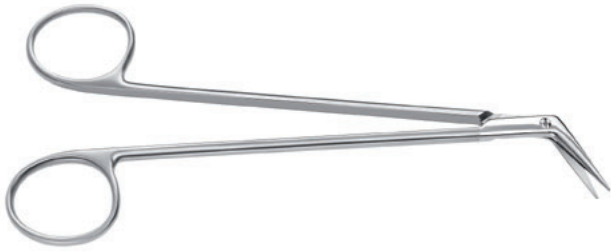

DIETHRICH

26mm, 160mm, 6¹/₄"

25°, blunt tip	125-216-025
25°, sharp tip	125-217-025
45°, blunt tip	125-216-045
45°, sharp tip	125-217-045

225mm, 8⁷/₈"

25°, blunt tip	125-220-025
25°, sharp tip	125-221-025
45°, blunt tip	125-220-045
45°, sharp tip	125-221-045
60°, blunt tip	125-220-060
60°, sharp tip	125-221-060

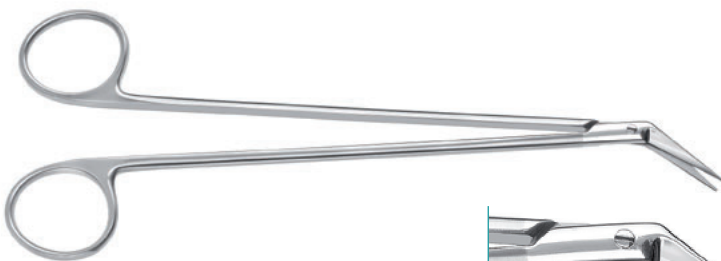

POTTS SMITH

22mm, 190mm, 7¹/₂"

25°	125-490-025
45°	125-490-045
60°	125-490-060



POTTS SMITH

22mm, 140mm, 5¹/₂"

25°	125-440-025
45°	125-440-045
60°	125-440-060

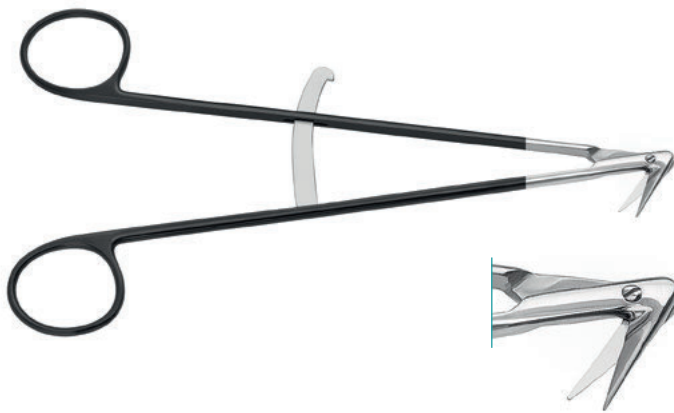
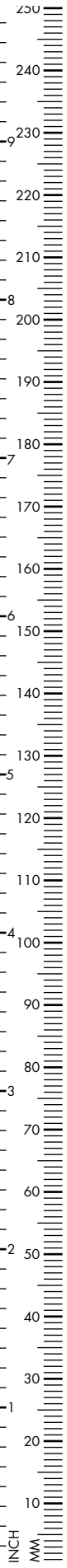

DIETHRICH SC

13mm, with guide, 180mm, 7"

125°	126-200-125
------	-------------



DIETHRICH HEGEMANN SC

13mm, 180mm, 7"

25°	126-180-025
45°	126-180-045
60°	126-180-060
90°	126-180-090
125°	126-180-125



DIETHRICH SC

Peripheral, 13mm, 130mm, 5 1/8"

25°	126-130-025
45°	126-130-045
60°	126-130-060
90°	126-130-090
125°	126-130-125

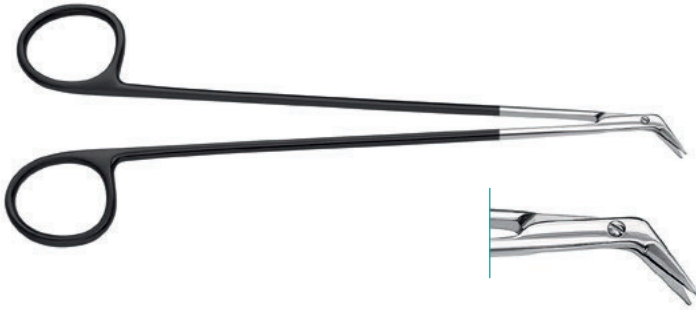

DIETRICH SC

9mm, 130mm, 5¹/₈"

25°	126-178-025
45°	126-178-045
60°	126-178-060
90°	126-178-090
125°	126-178-125

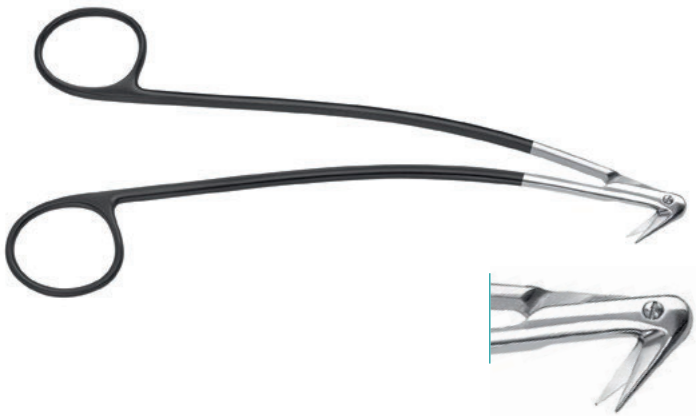

DIETRICH FAVALORO SC

13mm, 180mm, 7"

125°	126-185-125
------	-------------

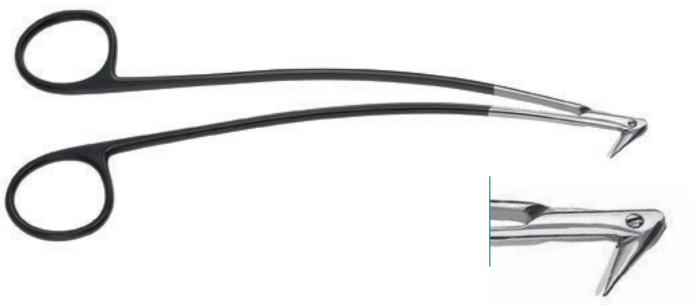

DIETRICH FAVALORO SC

9mm, 170mm, 6²/₃"

125°	126-168-125
------	-------------

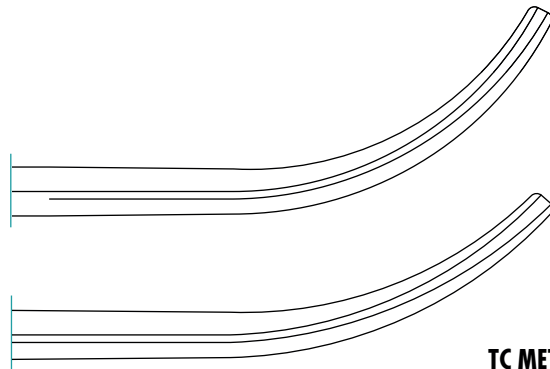

TC METZENBAUM

70mm blade length, double action,
slightly curved

325mm, 12³/₄" 295-120-000

365mm, 14¹/₃" 295-120-002

strongly curved

325mm, 12³/₄" 295-120-001

365mm, 14¹/₃" 295-120-003



Dissecting Scissors, slightly curved, single action
180mm working length, Ø 5mm shaft

285mm, 11¹/₄" 295-123-180



Micro Forceps, flat handle, Ø 0.3mm tip,
9mm handle width

A 110mm, 4¹/₃" 251-613-110

B 120mm, 4³/₄" 251-611-120

B 7mm handle width, 135mm, 5¹/₃"
251-612-130

with tying platform 251-617-130

B 9mm handle width, 135mm, 5¹/₃"
251-611-130

with tying platform 251-621-135

A 9mm handle width
150mm, 6" 251-613-150

B 9mm handle width, 180mm, 7"
251-611-180

with tying platform 251-611-181



Micro Forceps, flat, smooth handle,
9mm handle width, 110mm, 4¹/₃"

Ø 0.4mm tip 251-600-040

Ø 0.6mm tip 251-600-060

Ø 0.8mm tip 251-600-080



Micro Forceps, flat handle,
Ø 0.4mm tip, 9mm handle width

120mm, 4³/₄" 251-618-120

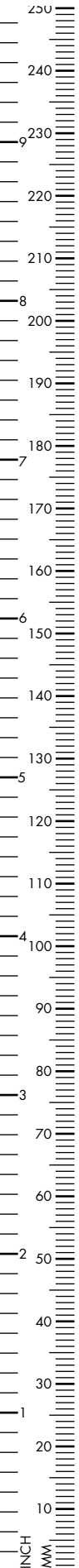

Fine Micro Forceps, flat handle,
 Ø 0.1mm tip, 9mm handle width

A	110mm, 4 ¹ / ₃ "	251-609-110
B	135mm, 5 ¹ / ₃ "	251-613-130



Micro Forceps, flat handle, 45° angled
 Ø 0.3mm tip, 9mm handle width

110mm, 4 ¹ / ₃ "	251-616-110
135mm, 5 ¹ / ₃ "	
7mm	251-615-130
9mm	251-603-135
150mm, 6"	
9mm	251-616-150
180mm, 7"	
9mm	251-613-180
with tying platform	251-613-181
90° angled Ø 0.3mm tip, 9mm handle width	
110mm, 4 ¹ / ₃ "	251-617-110



PIERSE

Micro Forceps, flat handle, 9mm handle width
120mm, 4³/₄"

Ø 0.3mm tip 251-615-120

Ø 0.65mm tip 251-613-120

Ø 0.1mm tip 251-616-120

135mm, 5¹/₃"

Ø 0.3mm tip 251-610-135

180mm, 7"

Ø 0.65mm tip 251-612-180



BANIS

Micro Forceps, flat handle, 9mm handle width
Ø 0.3mm tip

135mm, 5¹/₃" 251-607-135

180mm, 7" 251-607-180



Tubing Introducer Forceps, 9mm handle width

120mm, 4³/₄" 251-715-120

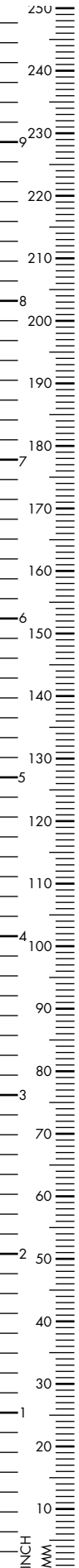

Micro Forceps, flat handle,
 \varnothing 0.3mm diamond dusted tip,
 9mm handle width, straight

110mm, 4¹/₃" 251-713-110

7mm handle width, 135mm, 5¹/₃"
 251-712-130

with tying platform 251-717-130

9mm handle width, 135mm, 5¹/₃"
 251-711-130

with tying platform 251-721-135

9mm handle width
 180mm, 7" 251-711-180

Curved, \varnothing 0.4mm tip,
 9mm handle width

120mm, 4³/₄" 251-718-120

45° angled, \varnothing 0.3mm tip,
 9mm handle width

110mm, 4¹/₃" 251-619-110

135mm, 5¹/₃" 251-703-135

180mm, 7" 251-713-180

7mm handle width

135mm, 5¹/₃" 251-619-130

ADSON

Fixation Forceps, \varnothing 0.3mm tip,
 120mm, 4³/₄"

A 45° angled teeth 251-662-120

B 90° angled teeth 130-554-120

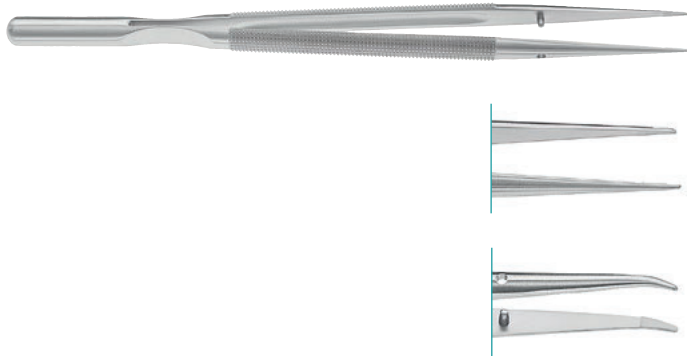

Balanced Micro Forceps, diamond dusted tip,
with tying platform, straight
Ø 0.7mm tip

150mm, 6"	251-657-150
-----------	-------------

210mm, 8 ¹ / ₄ "	251-657-210
--	-------------

Ø 0.5mm tip

180mm, 7"	251-657-180
-----------	-------------

Ø 0.7mm tip

210mm, 8 ¹ / ₄ "	251-660-210
--	-------------

curved, Ø 0.7mm tip

210mm, 8 ¹ / ₄ "	251-661-210
--	-------------

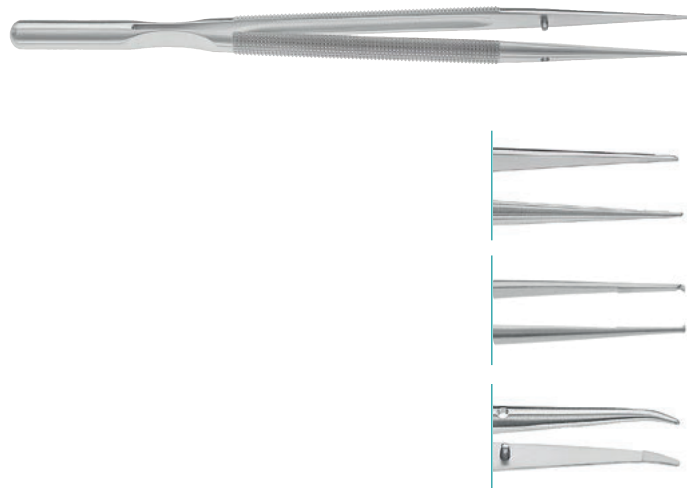

Balanced Micro Forceps, with tying platform,
straight
Ø 0.3mm tip

150mm, 6"	251-650-150
-----------	-------------

Ø 0.5mm tip

180mm, 7"	251-650-180
-----------	-------------

210mm, 8 ¹ / ₄ "	251-650-210
--	-------------

straight, with 1x2 teeth, Ø 0.3mm tip

150mm, 6"	251-658-150
-----------	-------------

180mm, 7"	251-658-180
-----------	-------------

straight, with 1x2teeth, Ø 0.7mm tip

210mm, 8 ¹ / ₄ "	251-658-210
--	-------------

curved, Ø 0.3mm tip

150mm, 6"	251-653-150
-----------	-------------

curved, Ø 0.5mm tip

180mm, 7"	251-653-180
-----------	-------------

210mm, 8 ¹ / ₄ "	251-653-210
--	-------------



DEBAKEY

Micro Forceps, Ø 8mm handle,
Ø 1.2mm tip

150mm, 6"	250-653-150
-----------	-------------

Ø 1.0mm tip

180mm, 7"	250-653-180
-----------	-------------

210mm, 8 ¹ / ₄ "	250-653-210
--	-------------



PIERSE

Micro Fixation Forceps, Ø 8mm handle,
Ø 0.3mm tip

150mm, 6"	251-652-150
-----------	-------------

Ø 0.6mm tip

180mm, 6"	251-652-180
-----------	-------------

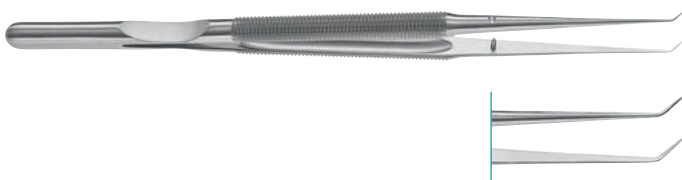

Micro Forceps, 45° angled, Ø 8mm handle,
Ø 0.2mm tip

150mm, 6"	251-655-150
-----------	-------------

180mm, 7"	251-654-180
-----------	-------------

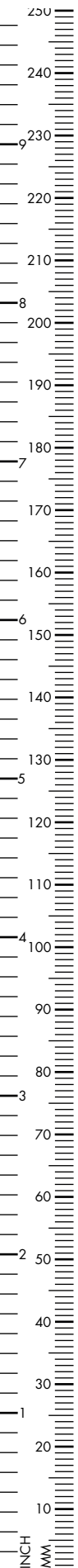



Micro Forceps, 45° angled, Ø 8mm handle,
Ø 0.3mm tip

150mm, 6"	251-656-150
180mm, 7"	251-656-180



 Micro Ring Forceps with diamond dusted tip,
straight, Ø 8mm handle,
Ø 1 x 0.5mm ring

150mm, 6"	251-655-145
180mm, 7"	251-655-180
210mm, 8 ^{1/4} "	251-655-210



Micro Ring Forceps, Titan,
with diamond dusted tip,
straight, Ø 8mm handle, without weight
Ø 1 x 0.5mm ring

150mm, 6"	250-364-705
Ø 2 x 1mm ring	
180mm, 7"	250-364-706
210mm, 8 ^{1/4} "	250-364-707
with weight Ø 1 x 0.5mm ring	
150mm, 6"	250-764-715
180mm, 7"	250-764-718
210mm, 8 ^{1/4} "	250-764-721

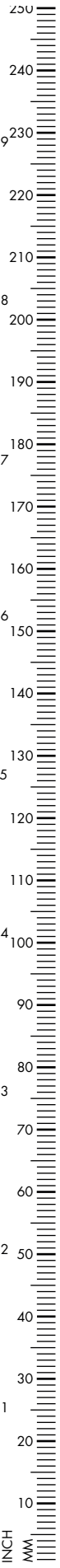

GERALD DEBAKEY

Vascular Tissue Forceps, straight, extra delicate
1.0mm tip, DeBakey serrations

175mm, 6 ⁷ / ₈ "	130-520-175
200mm, 8"	130-520-200
240mm, 9 ¹ / ₂ "	130-520-240



DIETHRICH DEBAKEY

Vascular Tissue Forceps, straight, extra delicate
1.5mm tip, DeBakey serrations

160mm, 6 ¹ / ₄ "	130-468-150
200mm, 8"	130-468-200
240mm, 9 ¹ / ₂ "	130-468-240

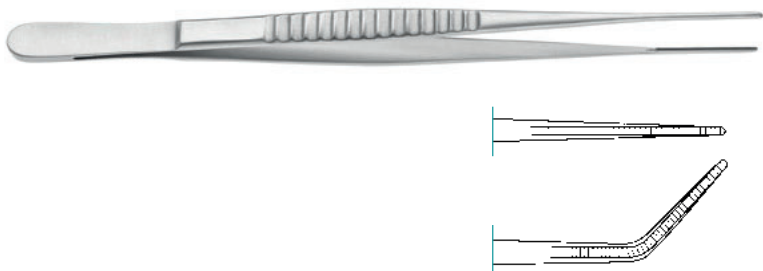

DEBAKEY

Vascular Tissue Forceps, straight, 1.5mm tip,
DeBakey serrations,
straight

160mm, 6 ¹ / ₄ "	290-550-160
200mm, 8"	290-550-200
240mm, 9 ¹ / ₂ "	290-550-240
300mm, 11 ⁷ / ₈ "	290-550-300

angled

160mm, 6 ¹ / ₄ "	290-551-160
200mm, 8"	290-551-200
240mm, 9 ¹ / ₂ "	290-551-240
300mm, 11 ⁷ / ₈ "	290-551-300

DEBAKEY

Vascular Tissue Forceps, straight, 2.0mm tip, DeBakey serrations, straight

160mm, 6 ¹ / ₄ "	290-552-160
200mm, 8"	290-552-200
240mm, 9 ¹ / ₂ "	290-552-240
300mm, 11 ⁷ / ₈ "	290-552-300

angled, 2.0mm

160mm, 6 ¹ / ₄ "	290-553-160
200mm, 8"	290-553-200
240mm, 9 ¹ / ₂ "	290-553-240
300mm, 11 ⁷ / ₈ "	290-553-300

straight, 3.5mm

160mm, 6 ¹ / ₄ "	290-554-160
200mm, 8"	290-554-200
240mm, 9 ¹ / ₂ "	290-554-240
300mm, 11 ⁷ / ₈ "	290-554-300

DEBAKEY

Vascular Tissue Forceps, straight, 2.4mm tip, DeBakey serrations

160mm, 6 ¹ / ₄ "	290-557-160
200mm, 8"	290-557-200
240mm, 9 ¹ / ₂ "	290-557-240
300mm, 11 ⁷ / ₈ "	290-557-300

DEBAKEY

Vascular Tissue Forceps, straight, 2.8mm step-down tip, DeBakey serrations

160mm, 6 ¹ / ₄ "	290-558-160
200mm, 8"	290-558-200
240mm, 9 ¹ / ₂ "	290-558-240
300mm, 11 ⁷ / ₈ "	290-558-300

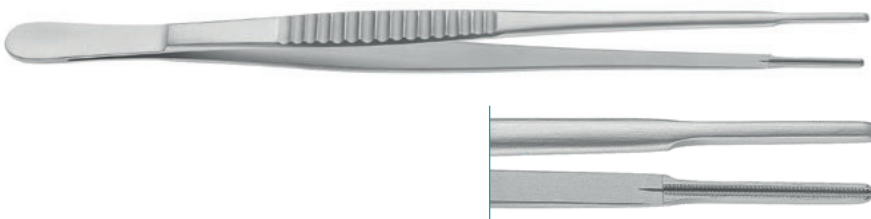
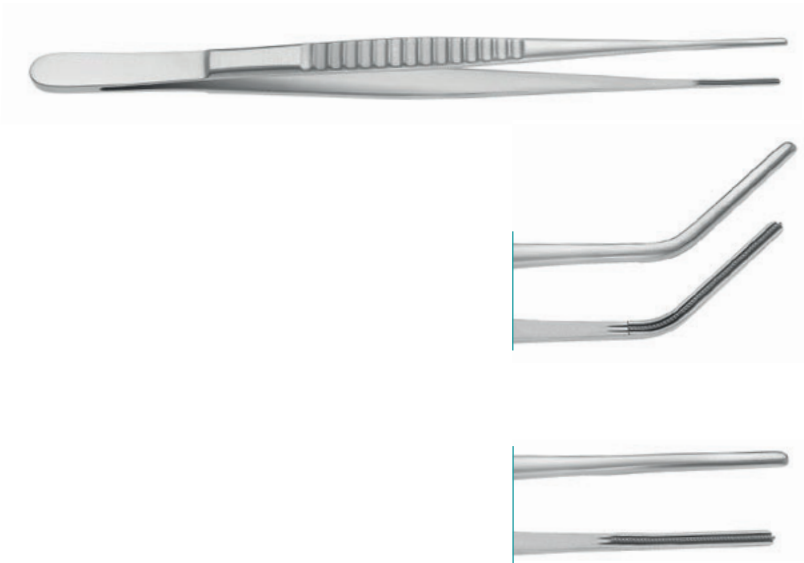

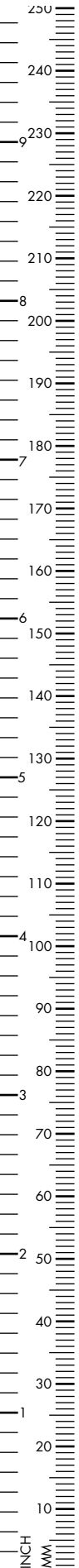

COOLEY

Vascular Tissue Forceps, straight,
delicate 1.5mm tip, DeBailey serrations

150mm, 6" 290-556-150

2.0mm tip

160mm, 6¹/₄" 290-556-160

200mm, 8" 290-556-200

240mm, 9¹/₂" 290-556-240



ADSON DEBAKEY

Vascular Tissue Forceps, straight, 2.0mm tip

120mm, 4³/₄" 130-527-120



Micro Dialtor

10° angled, 110mm, 4¹/₃", 9mm handle

Ø 0.2mm tip 251-602-110

9mm tip

Ø 0.3mm tip, 251-601-110

4mm tip

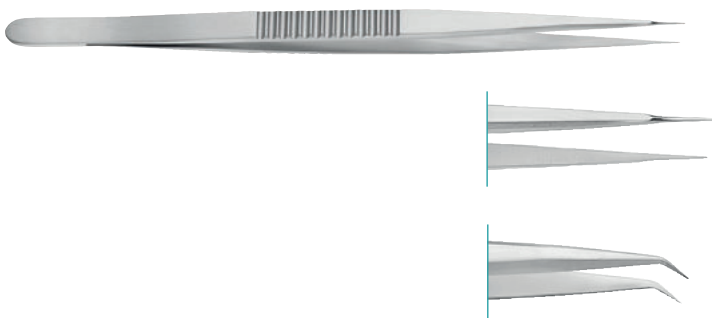

Micro Dilator, flat handle, straight,
135mm, 5¹/₃" , 6mm tip length

Ø 0.2mm tip 7mm handle	251-611-131
---------------------------	-------------

Ø 0.2mm tip, 9mm handle	251-611-132
----------------------------	-------------

4mm tip length

Ø 0.3mm tip, 9mm handle	251-611-133
----------------------------	-------------

180mm, 7" , 6mm tip length

Ø 0.1mm tip 9mm handle	251-611-187
---------------------------	-------------

Ø 0.2mm tip, 9mm handle	251-611-186
----------------------------	-------------

4mm tip length

Ø 0.3mm tip, 9mm handle	251-611-185
----------------------------	-------------

45° angled, 135mm, 5¹/₃" , 9mm handle

Ø 0.3mm tip 4mm tip	251-608-135
------------------------	-------------



Micro Dilator, round handle, straight,
Ø 0.3mm tip, 4mm tip, 8mm handle

150mm, 6"	251-640-150
-----------	-------------

180mm, 7"	251-640-180
-----------	-------------



Micro Needle Holder, flat handle, Ø 0.4mm tip, 140mm, 5 ¹ / ₂ " , straight	
with ratchet	250-064-153
without ratchet	250-064-149
curved	
with ratchet	250-064-151
without ratchet	250-064-150



Micro Needle Holder, round handle, Ø 0.4mm tip, without ratchet, Ø 8mm handle, straight	
130mm, 5 ¹ / ₈ "	250-064-138
180mm, 7"	250-064-244



Ø 0.2mm tip, Ø 8mm handle, curved, 150mm, 6"	
without ratchet	250-064-144

Ø 8mm handle, curved, 130mm, 5 ¹ / ₈ "	
without ratchet	250-064-142
with ratchet	250-064-147

Ø 0.5mm tip Ø 10mm handle, curved, 130mm, 5 ¹ / ₈ "	
without ratchet	250-064-146
with ratchet	250-064-145

Ø 0.4mm tip Ø 8mm handle, curved, 150mm, 6"	
without ratchet	250-064-148

Ø 0.4mm tip Ø 8mm handle, curved, 180mm, 7"	
without ratchet	250-064-245

Ø 0.5mm tip Ø 10mm handle, curved, 180mm, 7"	
without ratchet	250-064-248

Balanced Micro Needle Holder, Ø 8mm handle, curved, with tying platform Ø 0.4mm tip	
150mm, 6"	251-660-150

Ø 0.6mm tip	
180mm, 7"	251-660-180

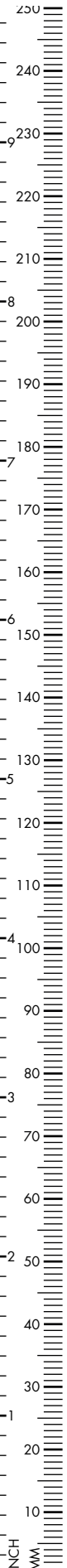

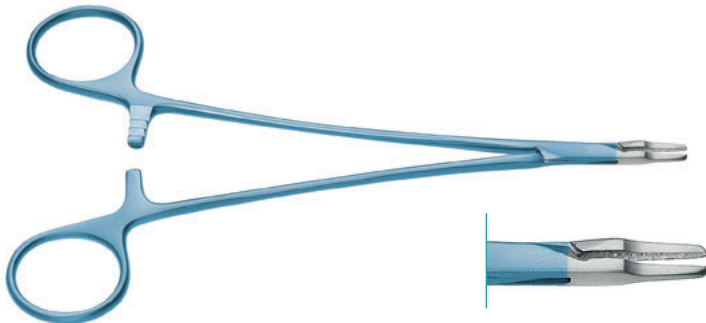

RYDER
Needle Holder

150mm, 6"	180-660-150
170mm, 6 ² / ₃ "	180-660-170
190mm, 7 ¹ / ₂ "	180-660-190

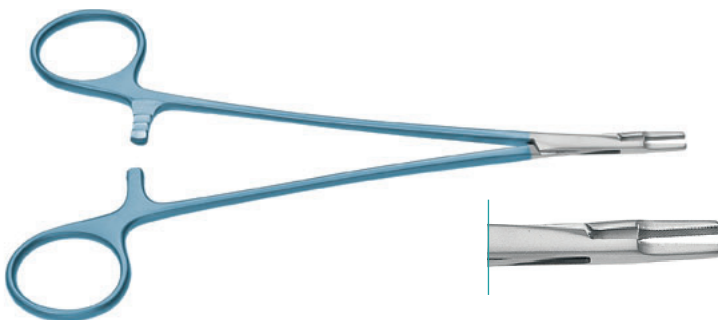

RYDER
Needle Holder, TC jaw, delicate

150mm, 6"	180-661-150
170mm, 6 ² / ₃ "	180-661-170
190mm, 7 ¹ / ₂ "	180-661-190

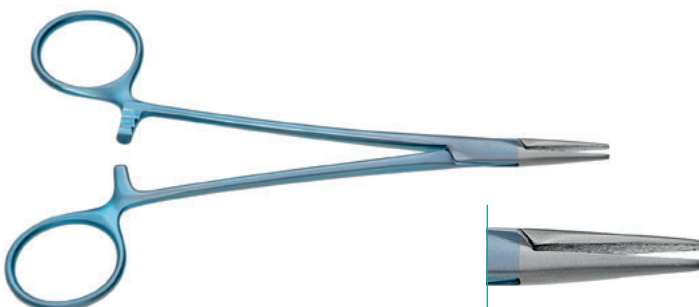

RYDER
Vascular Needle Holder, TC jaw

160mm, 6 ¹ / ₄ "	180-674-160
180mm, 7"	180-674-180
200mm, 8"	180-674-200
220mm, 8 ² / ₃ "	180-674-220
250mm, 9 ⁷ / ₈ "	180-674-250

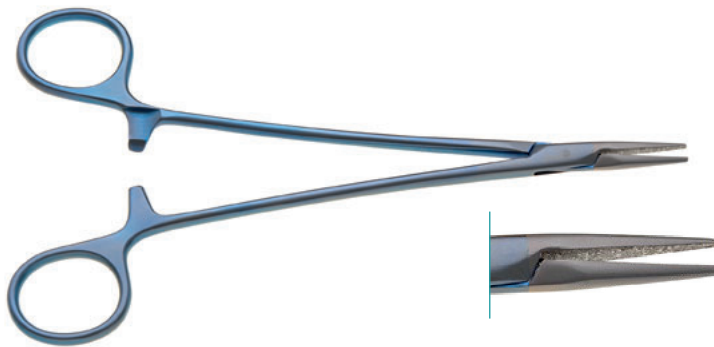

DEBAKEY
Needle Holder

160mm, 6 ¹ / ₄ "	180-675-160
180mm, 7"	180-675-180
200mm, 8"	180-675-200
220mm, 8 ² / ₃ "	180-675-220
250mm, 9 ⁷ / ₈ "	180-675-250

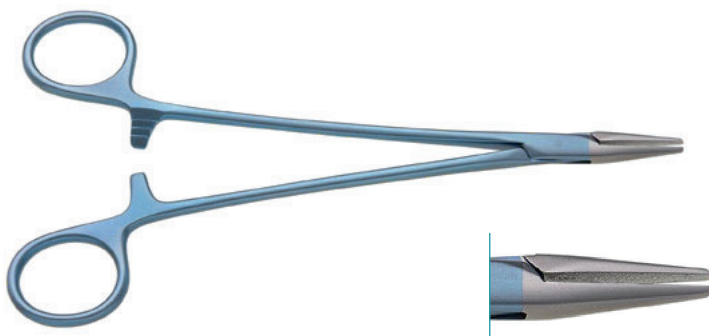

MAYO-HEGAR
Needle Holder
1.8mm fine jaw

160mm, 6 ¹ / ₄ "	180-680-160
180mm, 7"	180-680-180
200mm, 8"	180-680-200
220mm, 8 ² / ₃ "	180-680-220
250mm, 9 ⁷ / ₈ "	180-680-250

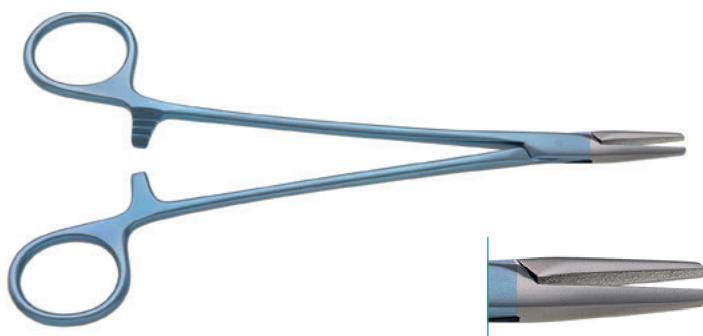

MAYO-HEGAR
Needle Holder
2.8mm broad jaw

160mm, 6 ¹ / ₄ "	180-690-160
180mm, 7"	180-690-180
200mm, 8"	180-690-200
220mm, 8 ² / ₃ "	180-690-220
250mm, 9 ⁷ / ₈ "	180-690-250

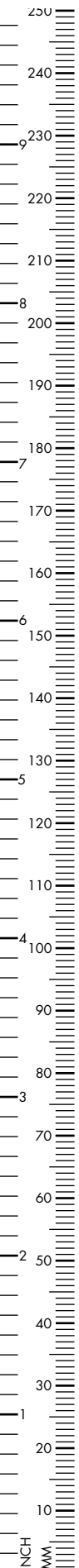



Ø 3.5mm shaft, 2x6mm, with ratchet, TC straight

170mm, 6 ² / ₃ "	295-034-200
250mm, 9 ⁷ / ₈ "	295-035-200
300mm, 11 ⁷ / ₈ "	295-037-200



Ø 3.5mm shaft, 2x6mm, with ratchet, TC curved

170mm, 6 ² / ₃ "	295-034-201
250mm, 9 ⁷ / ₈ "	295-035-201
300mm, 11 ⁷ / ₈ "	295-037-201



Ø 5.0mm shaft, 3x10mm, with ratchet, TC straight

170mm, 6 ² / ₃ "	295-048-200
250mm, 9 ⁷ / ₈ "	295-050-200
300mm, 11 ⁷ / ₈ "	295-052-200



Ø 5.0mm shaft, 3x10mm, with ratchet, TC curved left

170mm, 6 ² / ₃ "	295-048-201
250mm, 9 ⁷ / ₈ "	295-050-201
300mm, 11 ⁷ / ₈ "	295-052-201



Ø 5.0mm shaft, 3x10mm, with ratchet, TC curved right

170mm, 6 ² / ₃ "	295-048-202
250mm, 9 ⁷ / ₈ "	295-050-202
300mm, 11 ⁷ / ₈ "	295-052-202



RYDER
Ø 5.0mm shaft, 1x8mm, with ratchet, TC straight

170mm, 6 ² / ₃ "	295-048-210
250mm, 9 ⁷ / ₈ "	295-050-210
300mm, 11 ⁷ / ₈ "	295-052-210



RYDER
Ø 5.0mm shaft, 1x10mm, with ratchet, TC straight

170mm, 6 ² / ₃ "	295-048-212
250mm, 9 ⁷ / ₈ "	295-050-212
300mm, 11 ⁷ / ₈ "	295-052-212



Ø 5.0mm shaft, 2x8mm, with ratchet, TC straight

170mm, 6 ² / ₃ "	295-048-214
250mm, 9 ⁷ / ₈ "	295-050-214
300mm, 11 ⁷ / ₈ "	295-052-214



Ø 5.0mm shaft, 3x10mm, with ratchet, diamond dusted, straight

170mm, 6 ² / ₃ "	295-048-216
250mm, 9 ⁷ / ₈ "	295-050-216
300mm, 11 ⁷ / ₈ "	295-052-216



Ø 5.0mm shaft, 3x10mm, with ratchet, diamond dusted, curved left

170mm, 6 ² / ₃ "	295-048-217
250mm, 9 ⁷ / ₈ "	295-050-217
300mm, 11 ⁷ / ₈ "	295-052-217



CRILE WOOD
Ø 5.0mm shaft, 3x10mm, with ratchet, TC curved left

170mm, 6 ² / ₃ "	295-048-219
250mm, 9 ⁷ / ₈ "	295-050-219
300mm, 11 ⁷ / ₈ "	295-052-219



CHITWOOD

Suture Cutter, Ø 5mm shaft

180mm, 7" 295-121-180

230mm, 9" 295-121-230

280mm, 11" 295-121-280



SLIDER

Needle Holder, straight, max. 4-0 suture,
210mm working length, Ø 7mm shaft
345mm, 12³/₄"

straight 295-180-000

curved 295-180-001

Ø 10mm shaft

straight 295-180-002

curved 295-180-003



Knot Pusher for valve surgery
Ø 8.0mm tip

345mm, 12³/₄" 295-000-020

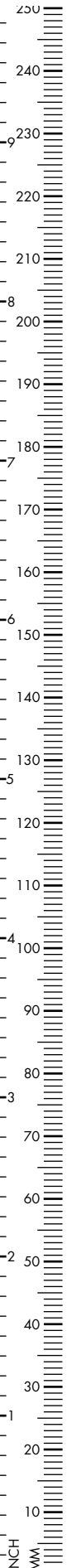



Cardioplegia Needle
310mm, 12¹/₄"

Ø 2.0mm	295-165-002
---------	-------------

Ø 3.0mm	295-165-003
---------	-------------



Magnetic Retriever

370mm, 14 ¹ / ₂ "	295-300-000
---	-------------



Suture Ruler, 0 - 60mm measuring range

430mm, 17"	295-100-350
------------	-------------



Suture Catcher for valve surgery
2mm tip width

350mm, 14" 295-000-010



Suture Catcher
2mm tip width

320mm, 12¹/₂" 295-000-110



Ø 4.0mm shaft, Valve Rongeur, oval, 4mm,
single action, straight

170mm, 6²/₃" 295-039-300

250mm, 9⁷/₈" 295-040-300

300mm, 11⁷/₈" 295-041-300



Ø 4.0mm shaft, Valve Rongeur, oval, 4mm,
single action, 30° angled

170mm, 6²/₃" 295-039-301

250mm, 9⁷/₈" 295-040-301

300mm, 11⁷/₈" 295-041-301

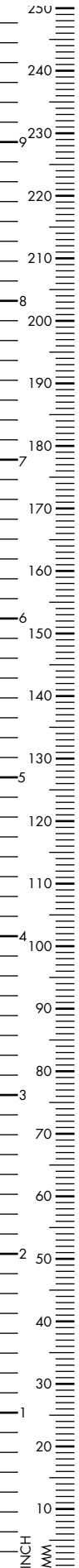



DEBAKEY

Ø 3.5mm shaft, 2x1 teeth, 2.8 x 14mm, double action, 45° lateral angled without ratchet

170mm, 6 ² / ₃ "	295-034-253
250mm, 9 ⁷ / ₈ "	295-035-253
300mm, 11 ⁷ / ₈ "	295-037-253

with ratchet

170mm, 6 ² / ₃ "	295-033-253
250mm, 9 ⁷ / ₈ "	295-036-253
300mm, 11 ⁷ / ₈ "	295-038-253



DEBAKEY

Ø 5.0mm shaft, 2x1 teeth, 1.5 x 14mm, single action, straight without ratchet

170mm, 6 ² / ₃ "	295-048-252
250mm, 9 ⁷ / ₈ "	295-050-252
300mm, 11 ⁷ / ₈ "	295-052-252

with ratchet

170mm, 6 ² / ₃ "	295-049-252
250mm, 9 ⁷ / ₈ "	295-051-252
300mm, 11 ⁷ / ₈ "	295-053-252



DEBAKEY

Ø 5.0mm shaft, 2x1 teeth, 1.5 x 10mm, double action, straight without ratchet

170mm, 6 ² / ₃ "	295-048-250
250mm, 9 ⁷ / ₈ "	295-050-250
300mm, 11 ⁷ / ₈ "	295-052-250

with ratchet

170mm, 6 ² / ₃ "	295-049-250
250mm, 9 ⁷ / ₈ "	295-051-250
300mm, 11 ⁷ / ₈ "	295-053-250



DEBAKEY

Ø 5.0mm shaft, 2x1 teeth, 1.5 x 14mm, single action, 45° angled without ratchet

170mm, 6 ² / ₃ "	295-048-253
250mm, 9 ⁷ / ₈ "	295-050-253
300mm, 11 ⁷ / ₈ "	295-052-253

with ratchet

170mm, 6 ² / ₃ "	295-049-253
250mm, 9 ⁷ / ₈ "	295-051-253
300mm, 11 ⁷ / ₈ "	295-053-253



DEBAKEY

Ø 5.0mm shaft, 2x1 teeth, 2.8 x 10mm, double action, straight without ratchet

170mm, 6 ² / ₃ "	295-048-251
250mm, 9 ⁷ / ₈ "	295-050-251
300mm, 11 ⁷ / ₈ "	295-052-251

with ratchet

170mm, 6 ² / ₃ "	295-049-251
250mm, 9 ⁷ / ₈ "	295-051-251
300mm, 11 ⁷ / ₈ "	295-053-251



DEBAKEY

Ø 5.0mm shaft, 3x2 teeth, 4.8 x 10mm, double action, straight without ratchet

170mm, 6 ² / ₃ "	295-048-254
250mm, 9 ⁷ / ₈ "	295-050-254
300mm, 11 ⁷ / ₈ "	295-052-254

with ratchet

170mm, 6 ² / ₃ "	295-049-254
250mm, 9 ⁷ / ₈ "	295-051-254
300mm, 11 ⁷ / ₈ "	295-053-254



DEBAKEY

Ø 5.0mm shaft, 2x1 teeth, 2.8 x 28mm, single action, 45° lateral angled without ratchet

170mm, 6 ² / ₃ "	295-048-255
250mm, 9 ⁷ / ₈ "	295-050-255
300mm, 11 ⁷ / ₈ "	295-052-255

with ratchet

170mm, 6 ² / ₃ "	295-049-255
250mm, 9 ⁷ / ₈ "	295-051-255
300mm, 11 ⁷ / ₈ "	295-053-255



Ø 5.0mm shaft, Knot Pusher single action, 45° angled without ratchet

170mm, 6 ² / ₃ "	295-048-260
250mm, 9 ⁷ / ₈ "	295-050-260
300mm, 11 ⁷ / ₈ "	295-052-260

with ratchet

170mm, 6 ² / ₃ "	295-049-260
250mm, 9 ⁷ / ₈ "	295-051-260
300mm, 11 ⁷ / ₈ "	295-053-260



RESANO

Ø 5.0mm shaft, Grasping Forceps single action, straight without ratchet

170mm, 6 ² / ₃ "	295-048-265
250mm, 9 ⁷ / ₈ "	295-050-265
300mm, 11 ⁷ / ₈ "	295-052-265

with ratchet

170mm, 6 ² / ₃ "	295-049-265
250mm, 9 ⁷ / ₈ "	295-051-265
300mm, 11 ⁷ / ₈ "	295-053-265



RESANO

Ø 5.0mm shaft, Grasping Forceps double action, conical shape without ratchet

170mm, 6 ² / ₃ "	295-048-270
250mm, 9 ⁷ / ₈ "	295-050-270
300mm, 11 ⁷ / ₈ "	295-052-270

with ratchet

170mm, 6 ² / ₃ "	295-049-270
250mm, 9 ⁷ / ₈ "	295-051-270
300mm, 11 ⁷ / ₈ "	295-053-270



GEMINI

Ø 5.0mm shaft, smooth double action, curved without ratchet

170mm, 6 ² / ₃ "	295-048-280
250mm, 9 ⁷ / ₈ "	295-050-280
300mm, 11 ⁷ / ₈ "	295-052-280

with ratchet

170mm, 6 ² / ₃ "	295-049-280
250mm, 9 ⁷ / ₈ "	295-051-280
300mm, 11 ⁷ / ₈ "	295-053-280

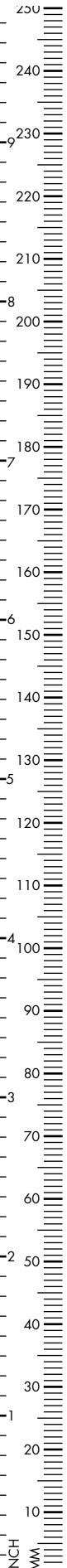

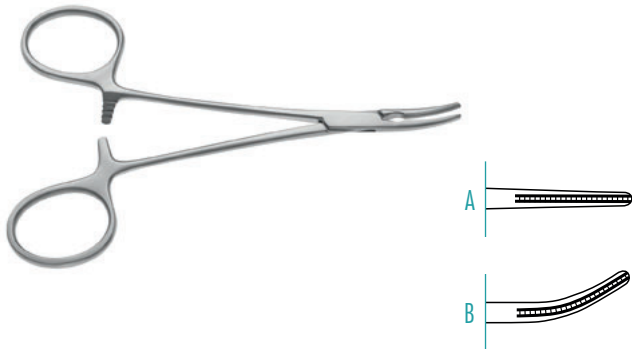

DEBAKEY MOSQUITO

Hemostatic Forceps, 120mm, 4³/₄"

A straight	290-438-120
B curved	290-439-120

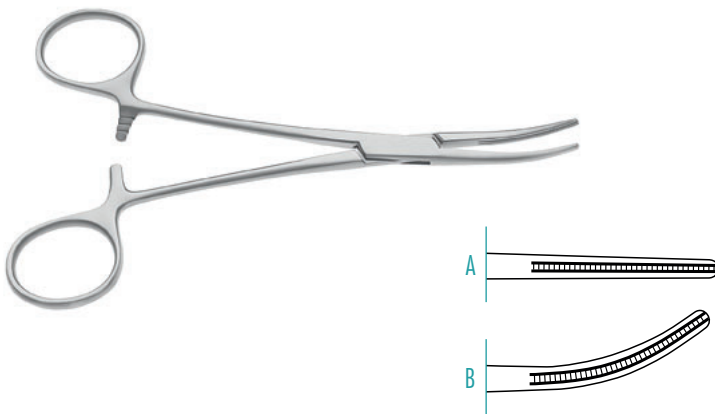

DEBAKEY KELLY

Atraumatic Forceps, 140mm, 5¹/₂"

A straight	290-410-140
B curved	290-411-140

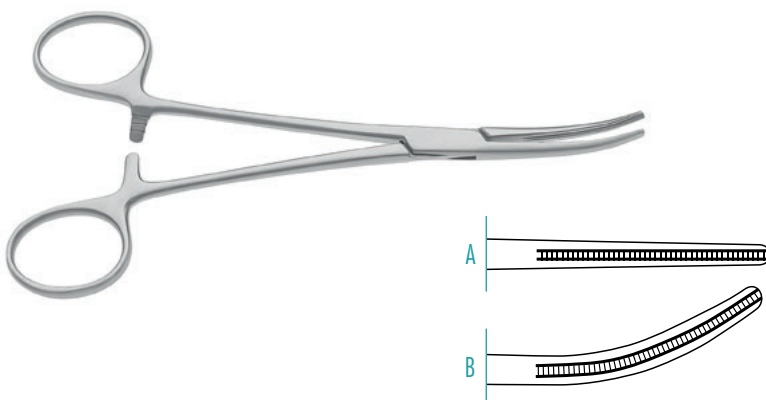

DEBAKEY RANKIN

Hemostatic Forceps, 160mm, 6¹/₄"

A straight	290-300-160
B curved	290-301-160

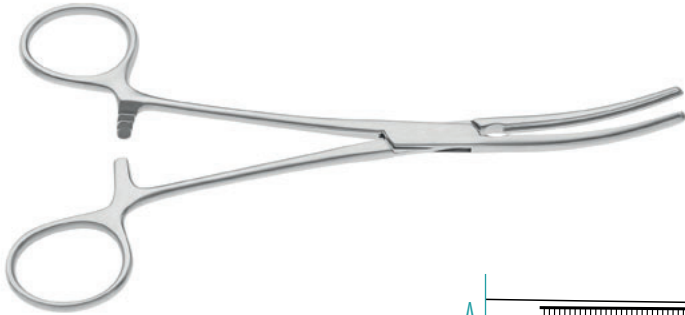

DEBAKEY PEAN

Hemostatic Forceps, straight

A	140mm, 5 ¹ / ₂ "	290-438-140
B	160mm, 6 ¹ / ₄ "	290-438-160
C	180mm, 7"	290-438-180
D	200mm, 8"	290-438-200
E	260mm, 10 ¹ / ₄ "	290-438-260
F	280mm, 11"	290-438-280

curved

G	140mm, 5 ¹ / ₂ "	290-439-140
H	160mm, 6 ¹ / ₄ "	290-439-160
I	180mm, 7"	290-439-180
J	200mm, 8"	290-439-200
K	260mm, 10 ¹ / ₄ "	290-439-260
L	280mm, 11"	290-439-280

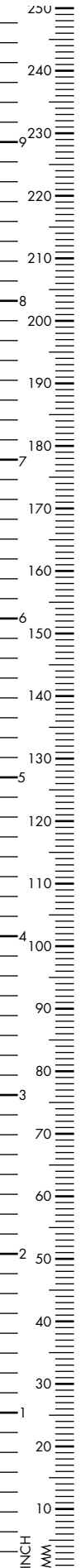
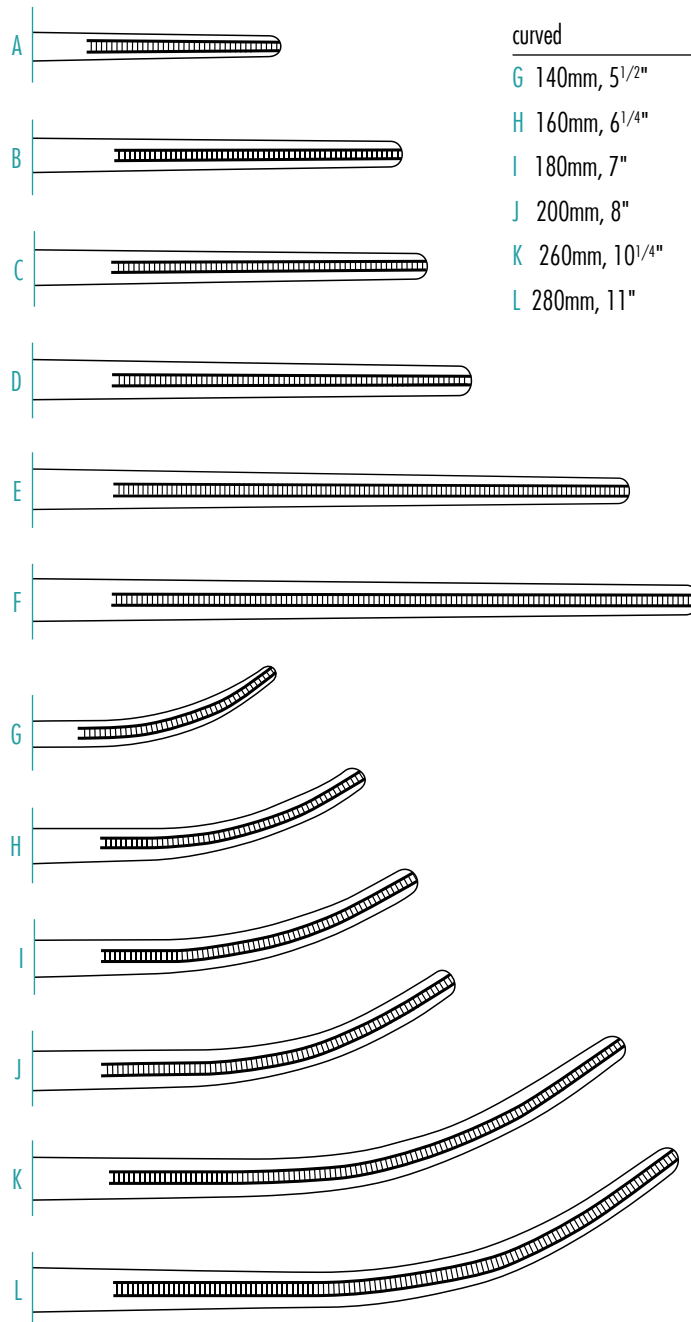

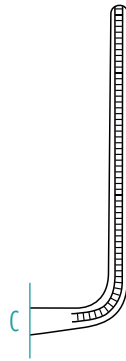
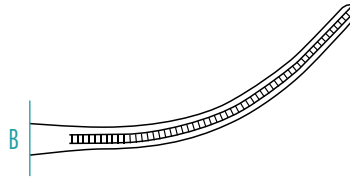
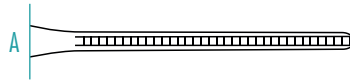

DEBAKEY

Clamp, straight shanks,

A straight jaw	290-458-120
120mm, 4 ³ / ₄ "	
B curved jaw	290-458-110
110mm, 4 ¹ / ₃ "	
C angled jaw	290-458-100
100mm, 4"	

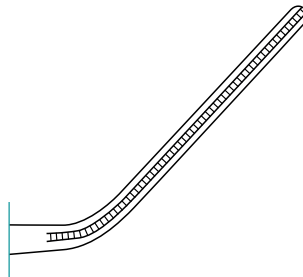

Shanks curved backwards

130mm, 5 ¹ / ₈ "	290-459-130
--	-------------

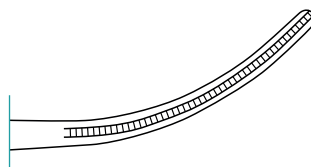
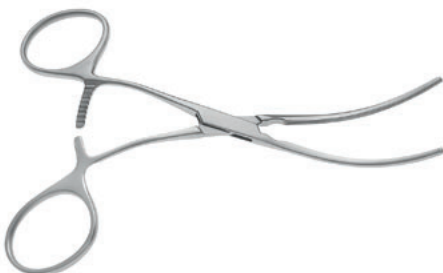

S-curved shanks

125mm, 5"	290-459-120
-----------	-------------

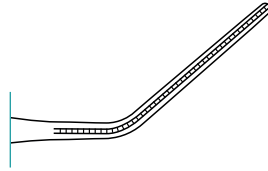
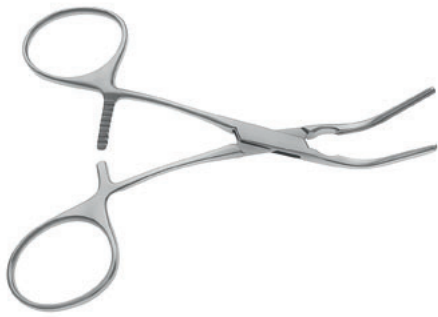
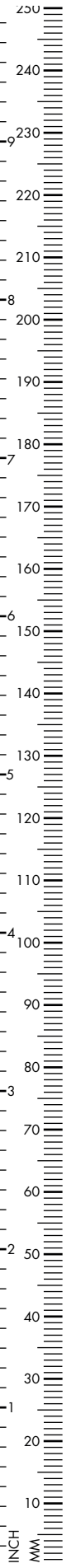

NOON

A.V. Fistula Clamp, 1x2 draft, 50° angled

110mm, 4¹/₃" 290-460-110

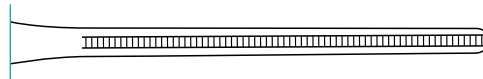

DEMOS

Tibial Artery Clamp, 60° angled shanks

200mm, 8" 290-407-200

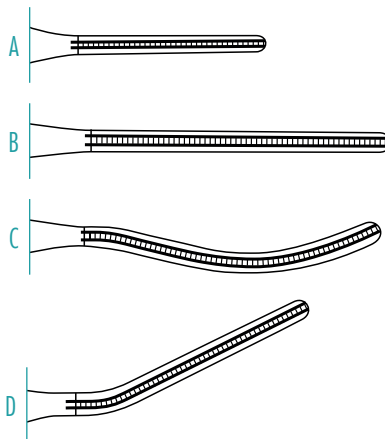

DEBAKEY

Pediatric Forceps, straight shanks

A 160mm, 6¹/₄" 290-440-160

B 170mm, 6²/₃" 290-440-170

C 165mm, 6¹/₂" 290-451-170

D 155mm, 6¹/₈" 290-442-150

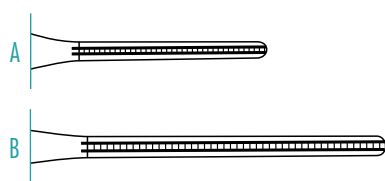

shanks angled forward

A 155mm, 6¹/₈" 290-447-155

B 170mm, 6²/₃" 290-447-170

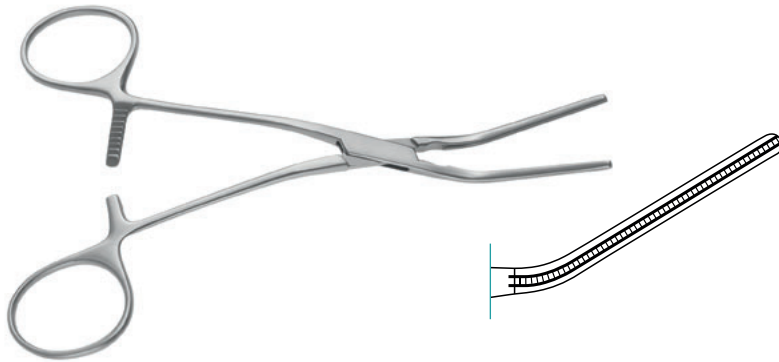

DEBAKEY

Pediatric Forceps,
shanks curved backwards, 30° angled

160mm, 6¹/₄"

290-441-160

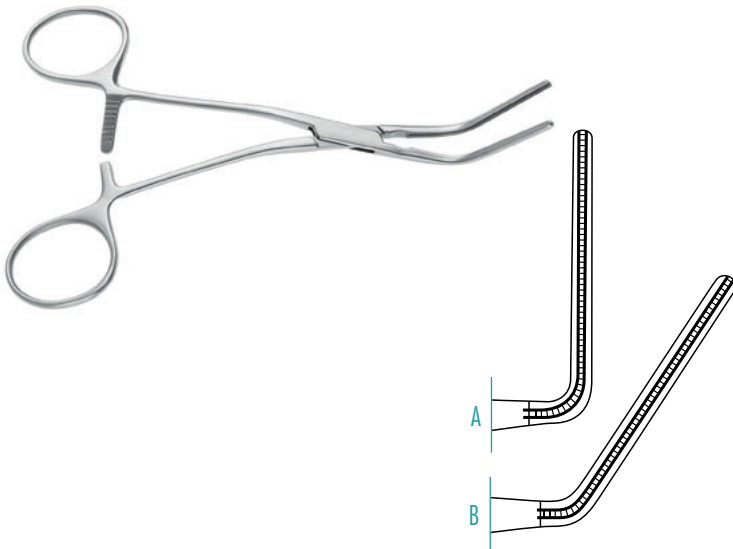

DEBAKEY

Pediatric Forceps, 150mm, 6"

A 90°

290-445-150

B 60°

290-443-150



SAROT

Bronchus Clamp with pins, 230mm, 9"

Teeth left 290-237-230

Teeth right 290-238-230



LEES

Bronchus Clamp

A 230mm, 9" 290-427-230

Bronchus Clamp

B 250mm, 9⁷/₈" 290-429-250

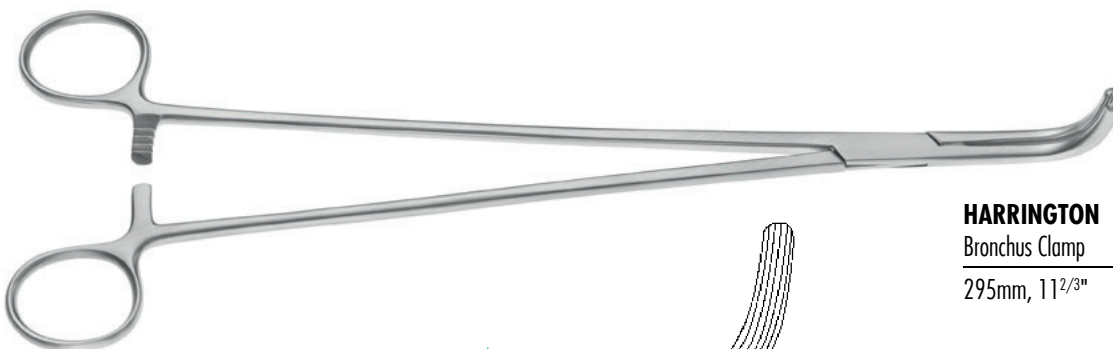
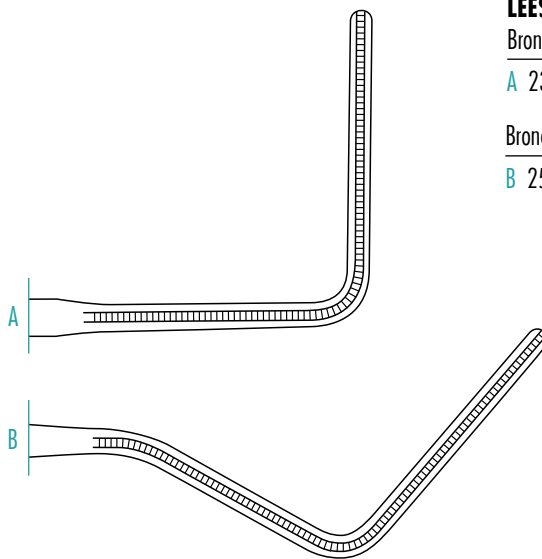

HARRINGTON

Bronchus Clamp

295mm, 11²/₃" 290-271-295

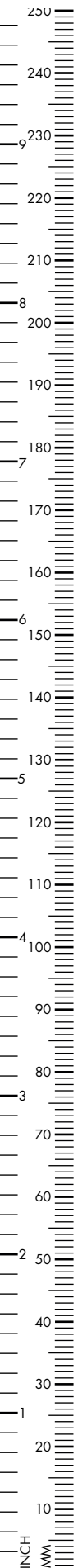

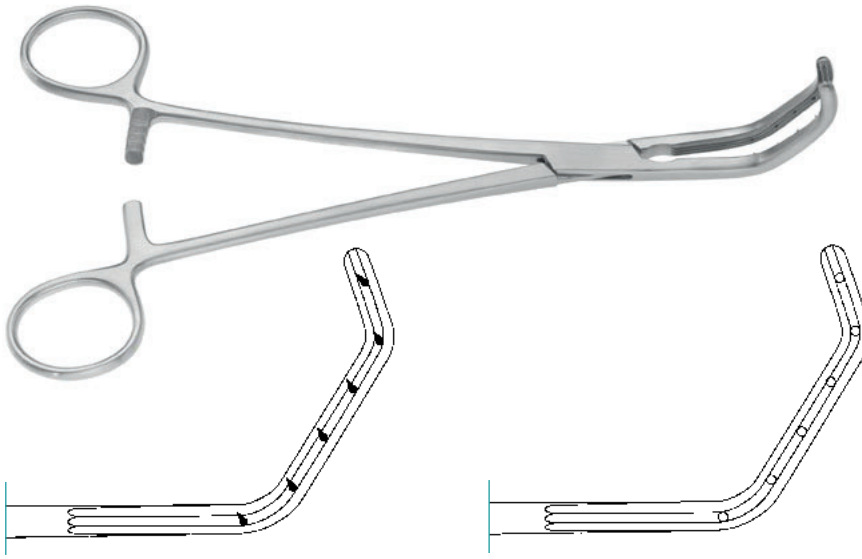

PRICE THOMAS

Bronchus Forceps, 220mm, 8²/₃"

Fig. 1, teeth left 290-245-220

Fig. 2, teeth right 290-247-220

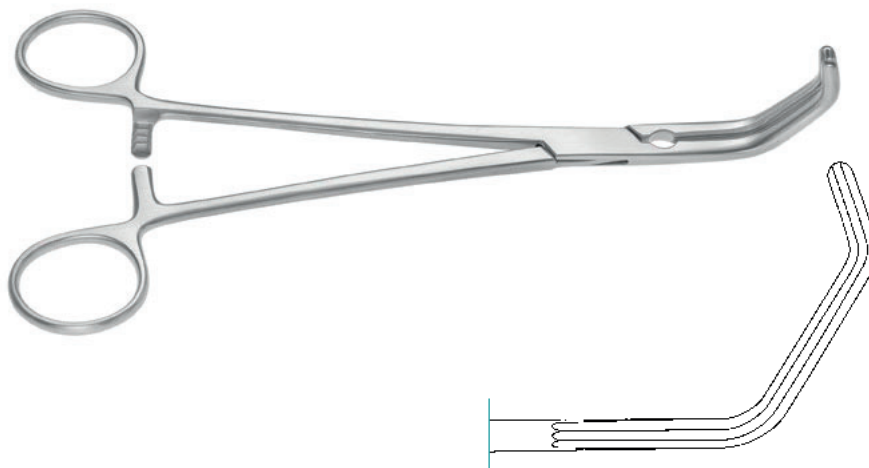

PRICE THOMAS

Bronchus Forceps

220mm, 8²/₃" 290-241-220

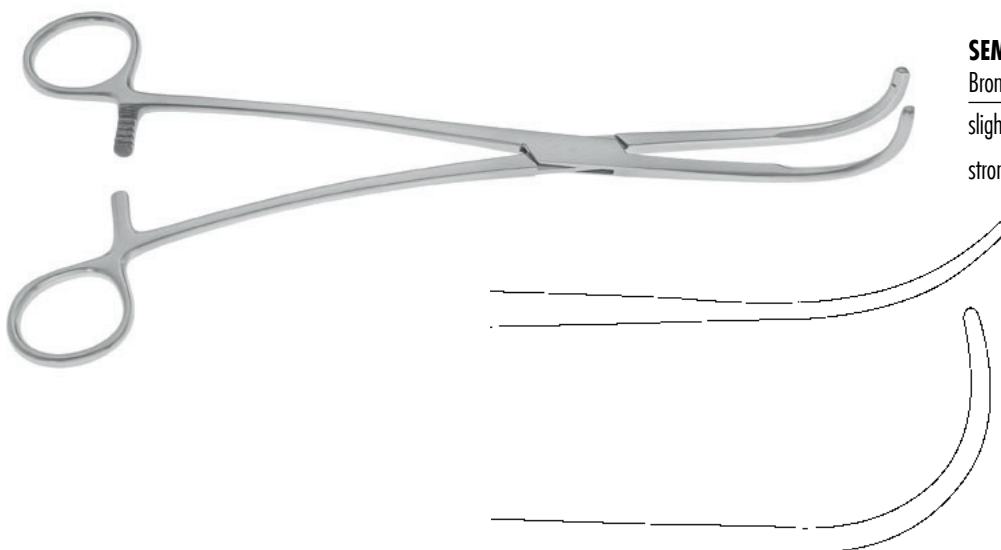

SEMB

Bronchus Forceps, 250mm, 9⁷/₈"

slightly curved 290-265-240

strongly curved 290-267-240

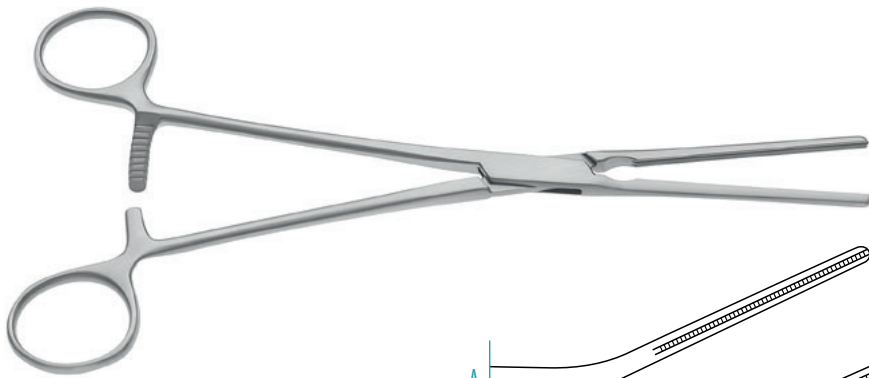

POTTS

Clamp/Forceps,
straight, angled jaw

A	205mm, 8 ¹ / ₈ "	290-401-210
B	220mm, 8 ² / ₃ "	290-401-220

straight jaw

C	205mm, 8 ¹ / ₈ "	290-400-210
D	220mm, 8 ² / ₃ "	290-400-220
E	260mm, 10 ¹ / ₄ "	290-400-260

DEBAKEY POTTS

Clamp, straight shanks

F	220mm, 8 ² / ₃ "	290-400-225
G	195mm, 7 ³ / ₄ "	290-400-195

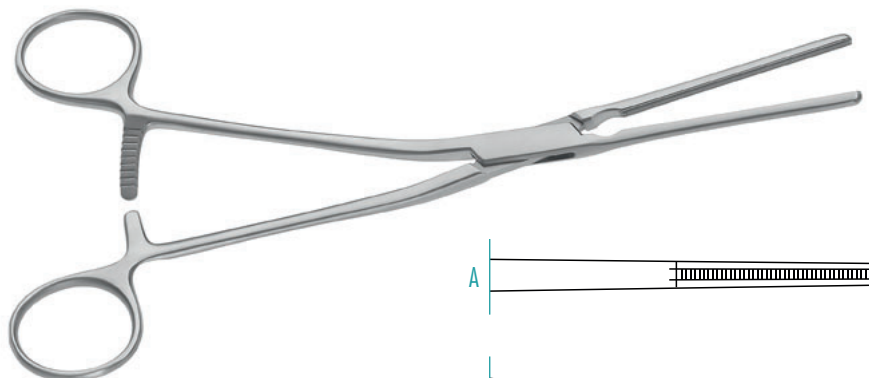
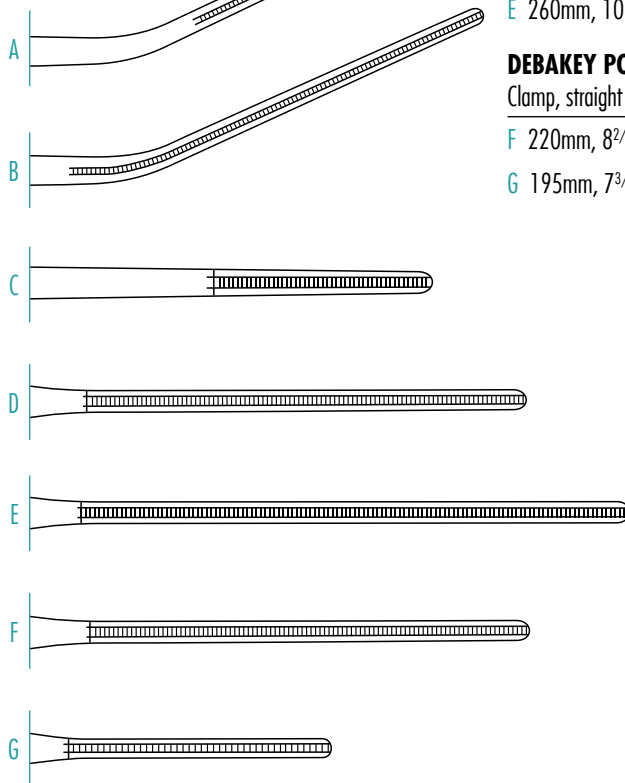

POTTS

Clamp/Forceps, angled, straight jaw

A	210mm, 8 ¹ / ₄ "	290-403-210
B	220mm, 8 ² / ₃ "	290-403-220
C	260mm, 10 ¹ / ₄ "	290-403-260

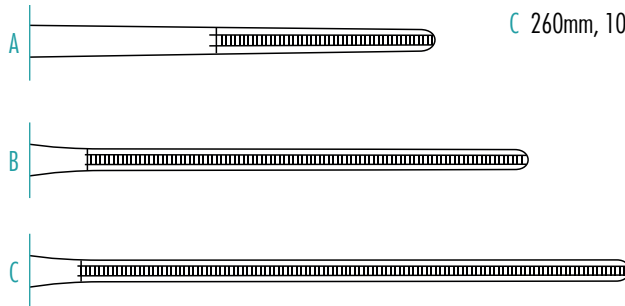

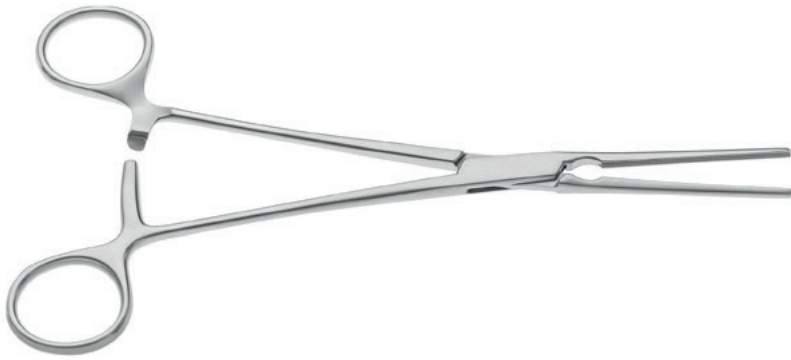

DEBAKEY

Clamp, straight jaw

A	215mm, 8 ¹ / ₂ "	290-434-210
B	230mm, 9"	290-434-230
C	270mm, 10 ² / ₃ "	290-434-270
D	315mm, 12 ¹ / ₂ "	290-434-310

curved jaw

E	215mm, 8 ¹ / ₂ "	290-435-210
F	230mm, 9"	290-435-230
G	270mm, 10 ² / ₃ "	290-435-270
H	315mm, 12 ¹ / ₂ "	290-435-310

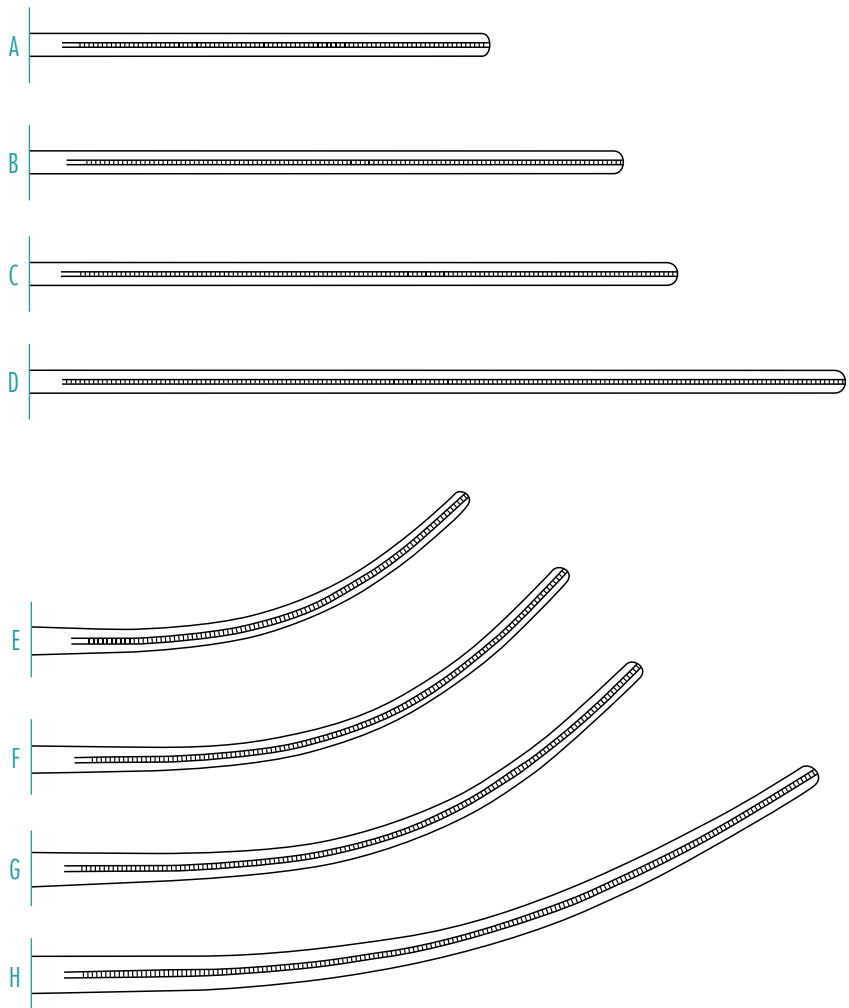

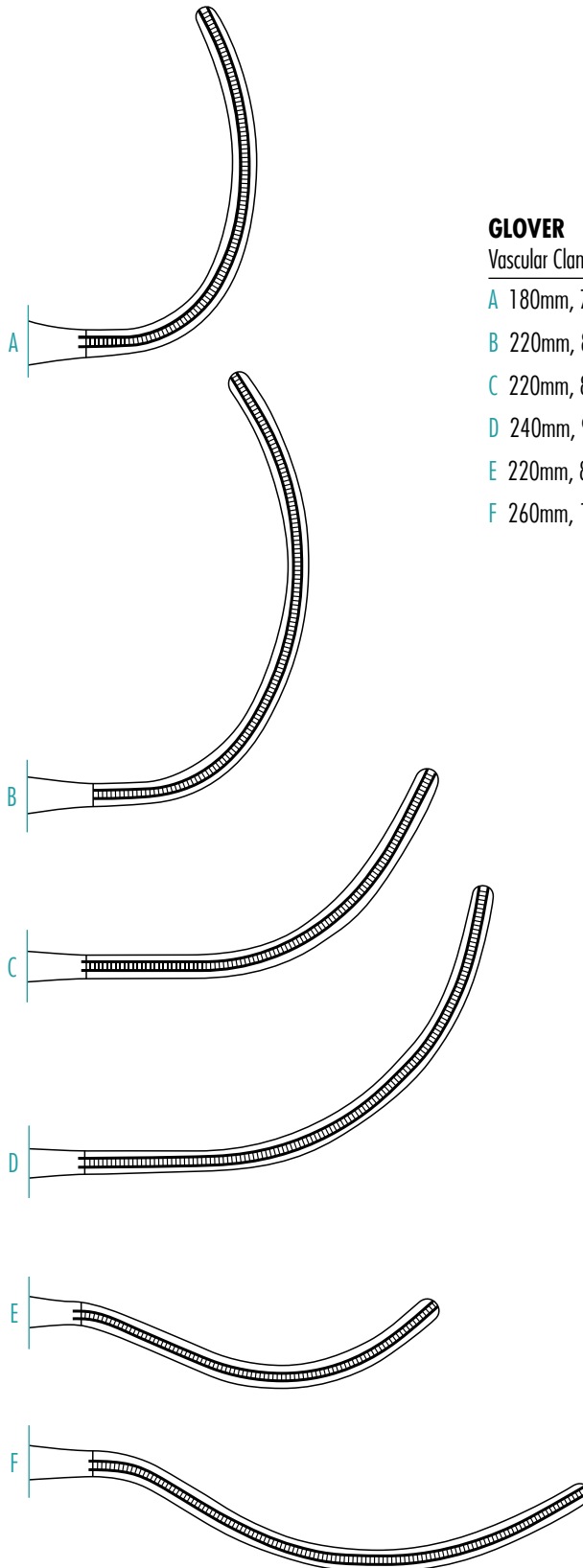

GLOVER

Vascular Clamp

A	180mm, 7"	290-405-195
B	220mm, 8 ² / ₃ "	290-405-210
C	220mm, 8 ² / ₃ "	290-451-215
D	240mm, 9 ¹ / ₂ "	290-451-240
E	220mm, 8 ² / ₃ "	290-412-220
F	260mm, 10 ¹ / ₄ "	290-412-260

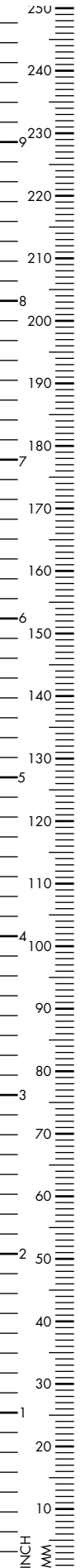



DEBAKEY

Peripheral Vascular Clamp

A	160mm, 6 ¹ / ₄ "	290-409-160
B	190mm, 7 ¹ / ₂ "	290-411-190
C	200mm, 8"	290-411-200

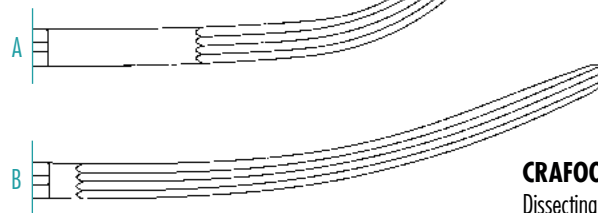
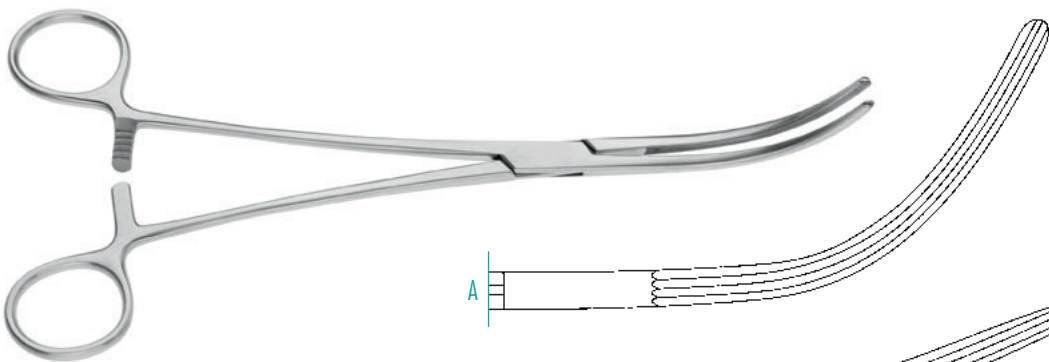
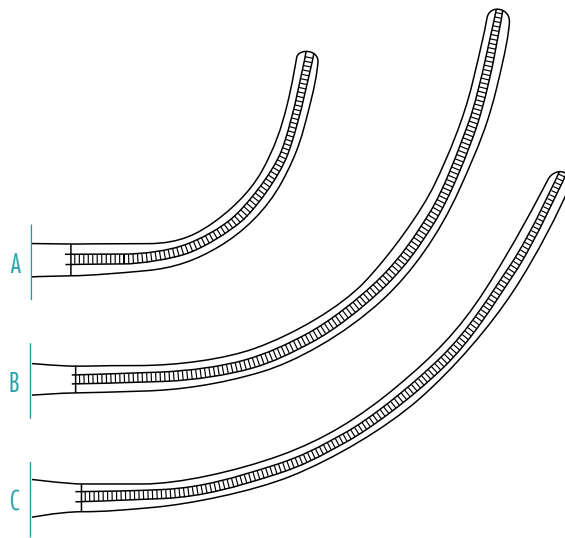

CRAFORD SELLORS

Dissecting Forceps

A	230mm, 9"	140-383-230
B	240mm, 9 ¹ / ₂ "	140-385-240



DEBAKEY BAINBRIDGE

Vascular Forceps

A	150mm, 6"	290-414-150
B	180mm, 7"	290-414-180
C	150mm, 6"	290-415-150
D	180mm, 7"	290-415-180

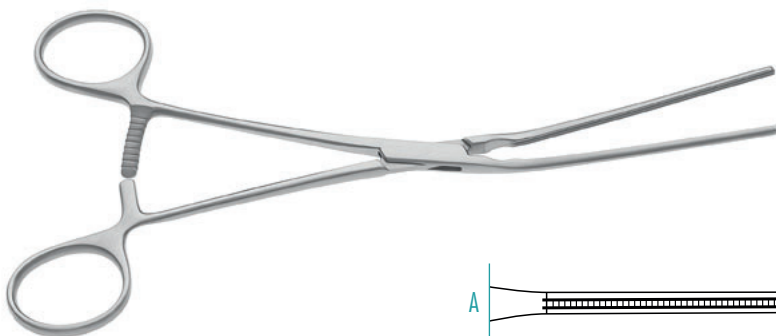
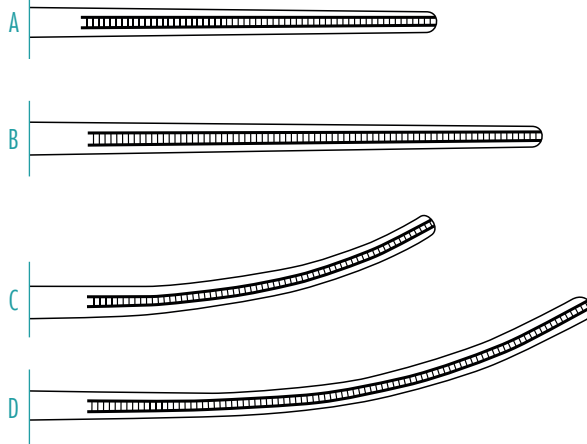

LELAND JONES

Peripheral Vascular Forceps, straight

A	200mm, 8"	290-413-195
15° angled		
B	200mm, 8"	290-413-200
30° angled		
C	190mm, 7 ¹ / ₂ "	290-413-190

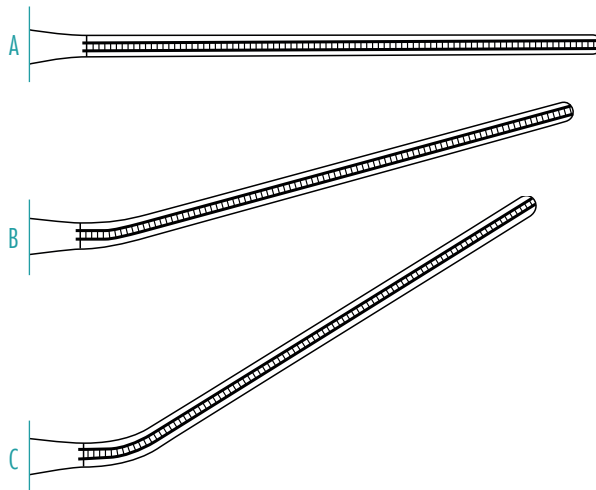

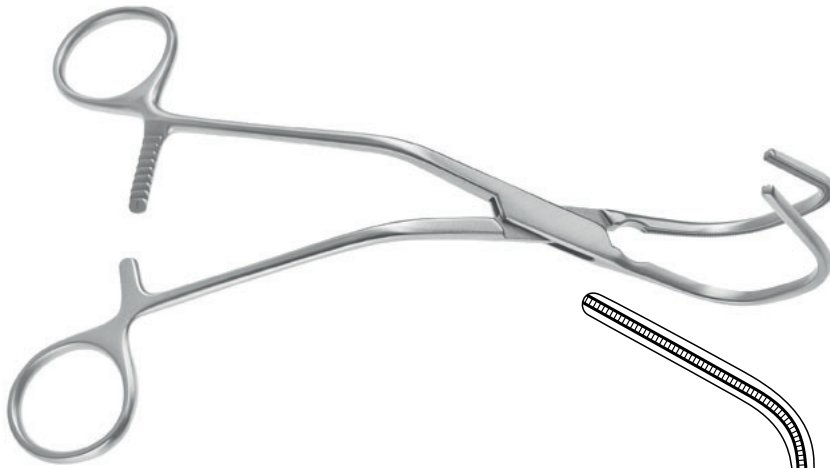

KAY LAMBERT

Clamp

A	220mm, 8 ² / ₃ "	290-430-220
B	210mm, 8 ¹ / ₄ "	290-430-210

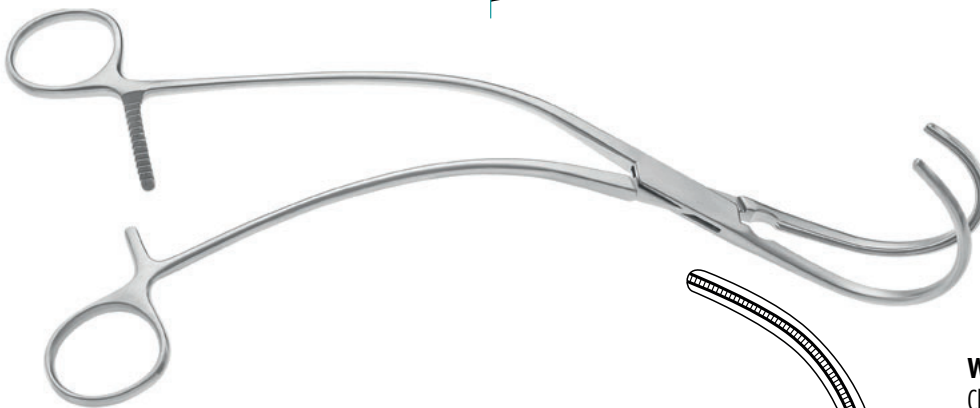
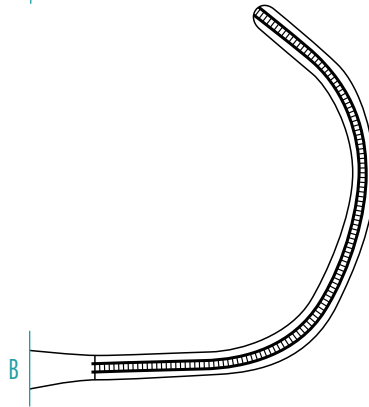
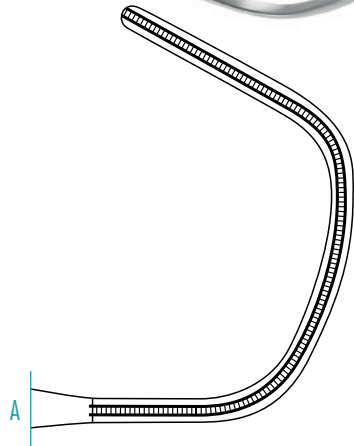

WEBER

Clamp, 260mm, 10¹/₄"

curved left	290-424-001
curved right	290-424-002

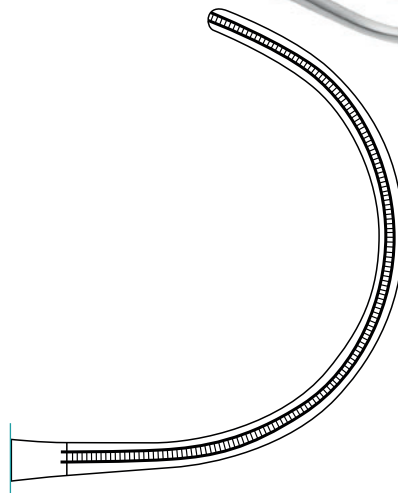

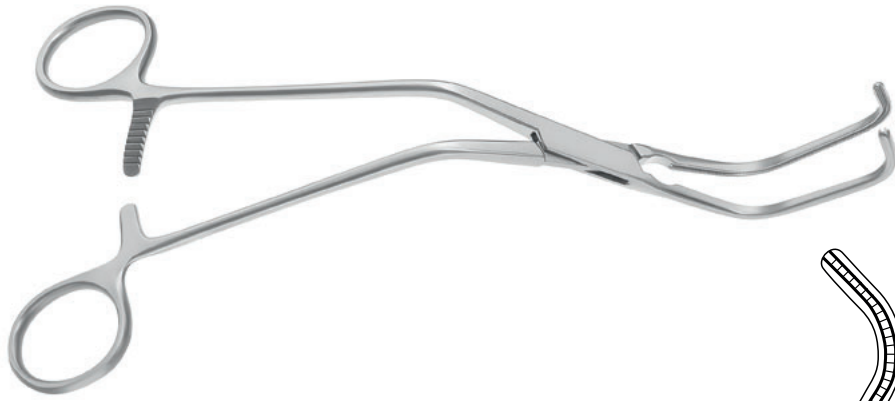

OCHSNER

Clamp

235mm, 9¹/₄"

290-317-230



LIDDLE

Clamp

270mm, 10²/₃"

290-318-270

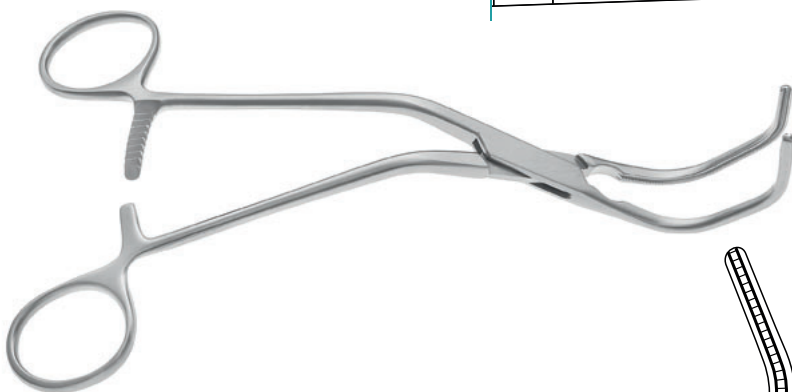

DIETRICH

Clamp

210mm, 8¹/₄"

290-319-210

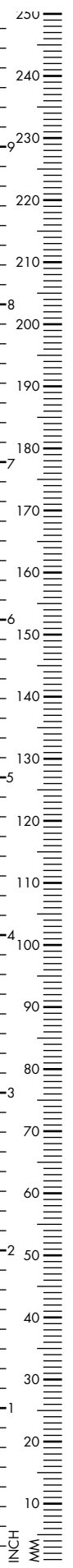

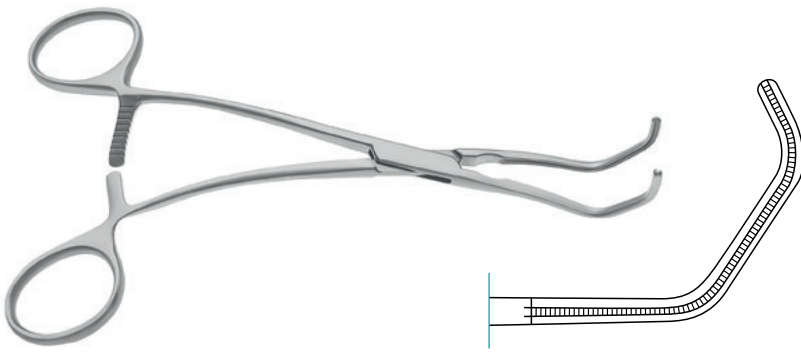

HONGKONG DERRA

Vascular Clamp

170mm, 6²/₃"

290-432-170



BEIJING SATINSKY

Vascular Clamp

225mm, 8⁷/₈"

290-425-220

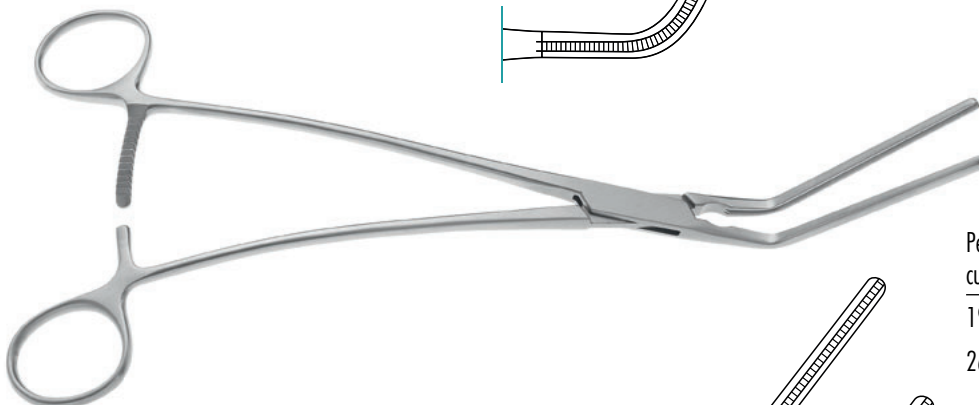

Peripheral Vascular Clamp
curved shanks, angled jaw

190mm, 7¹/₂"

290-402-190

265mm, 10¹/₂"

290-402-260

A

B

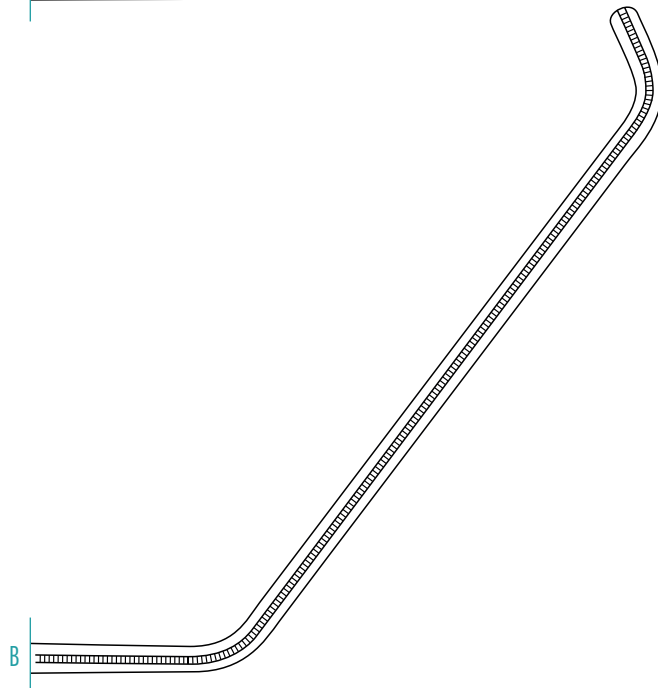
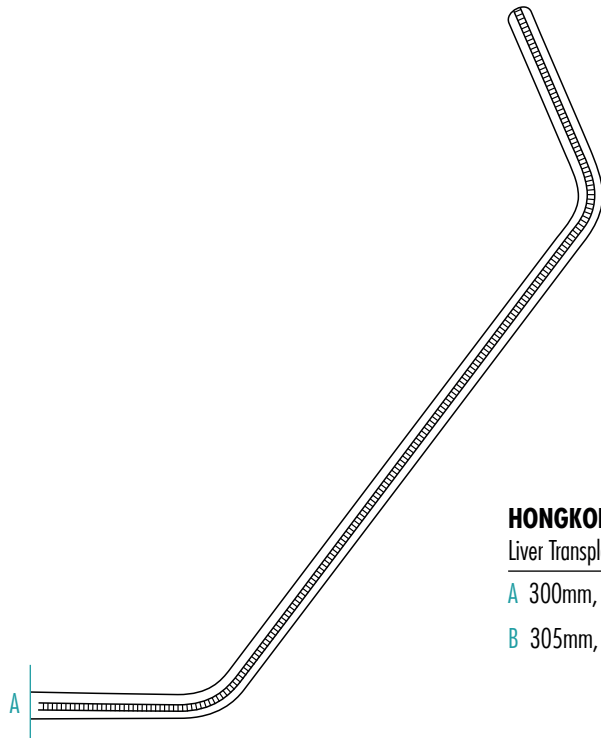

HONGKONG SATINSKY

Liver Transplant Clamp

A 300mm, 11⁷/₈" 290-426-300

B 305mm, 12" 290-426-305

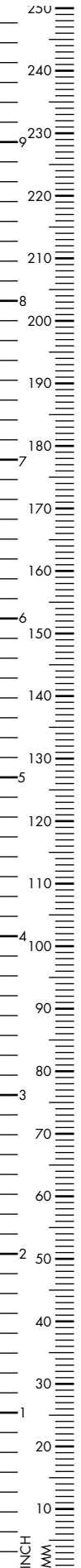

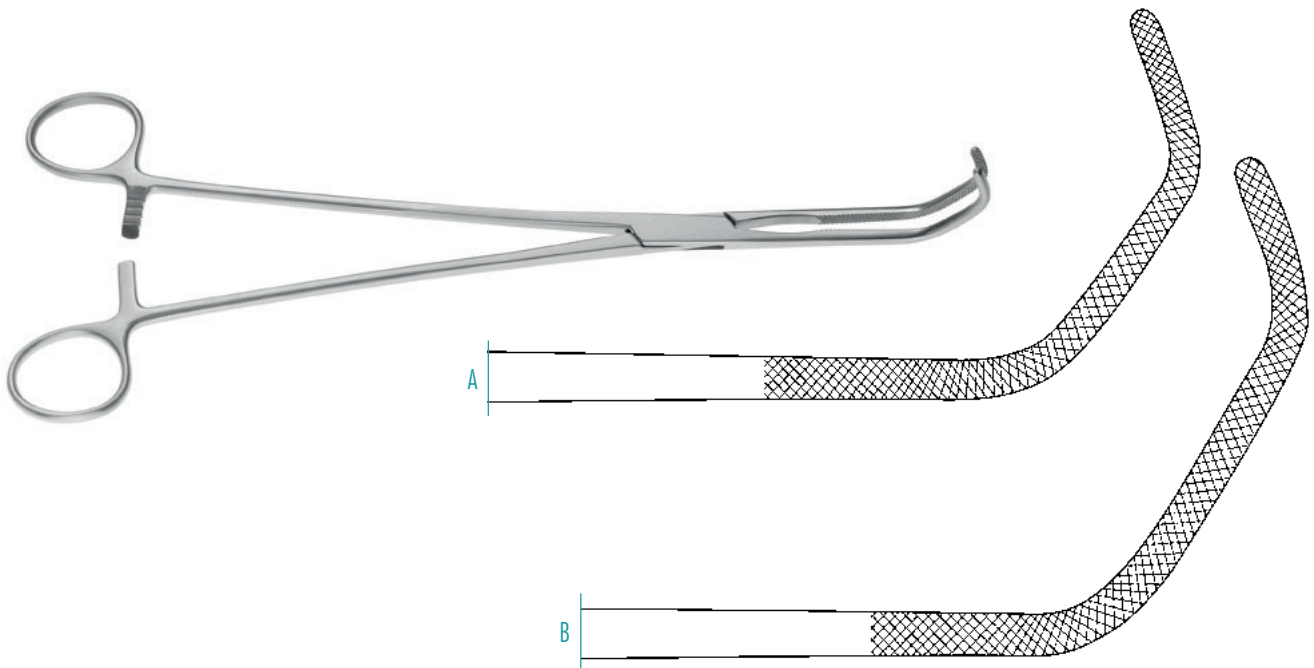

SATINSKY

Anastomosis Clamp, 260mm, 10¹/₄"

A Fig. 1 290-321-260

B Fig. 2 290-323-260

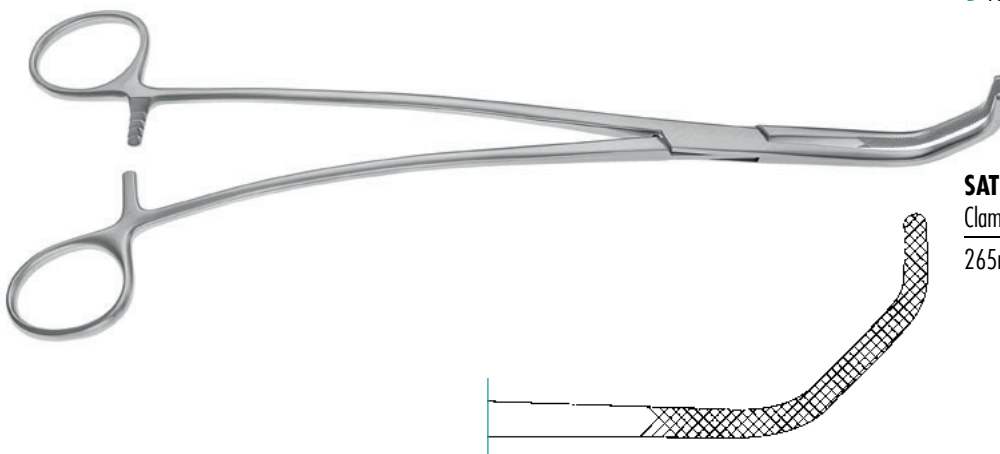

SATINSKY

Clamp S, Fig. 1

265mm, 10¹/₂" 290-325-260

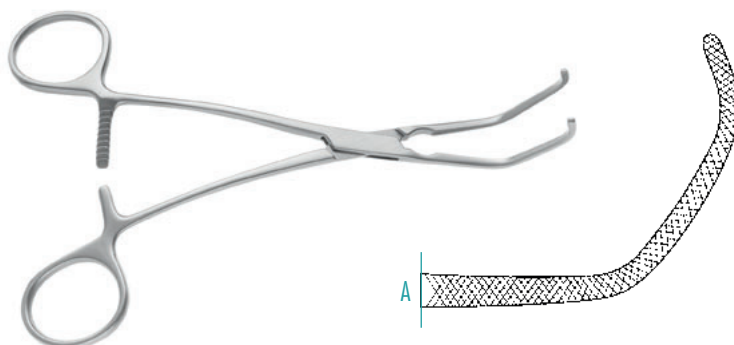

SATINSKY

Anastomosis Clamps, curved

150mm, 6" 290-331-150

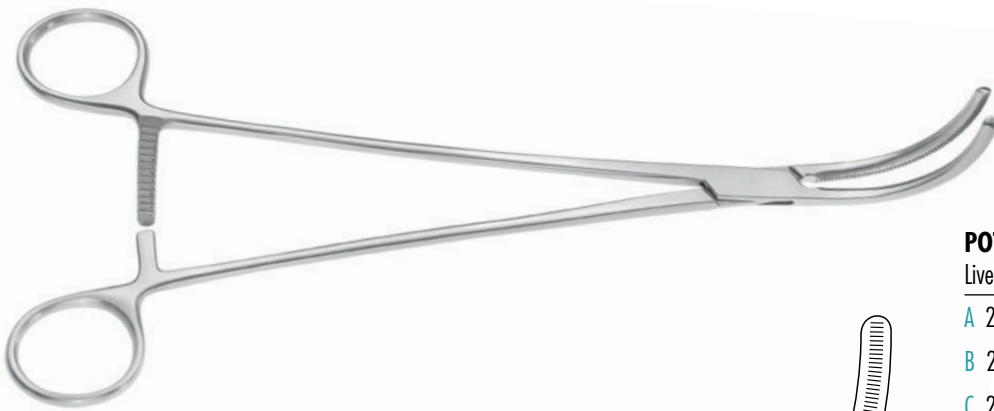

POTTS

Liver Transplant Clamp

A	255mm, 10"	290-755-255
B	255mm, 10"	290-756-255
C	270mm, 10 ² / ₃ "	290-757-270
D	280mm, 11"	290-758-280

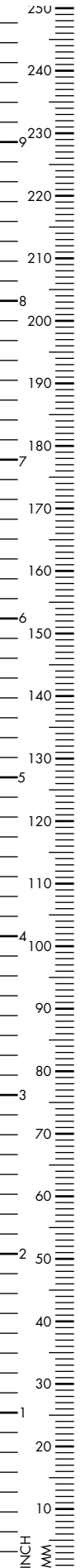
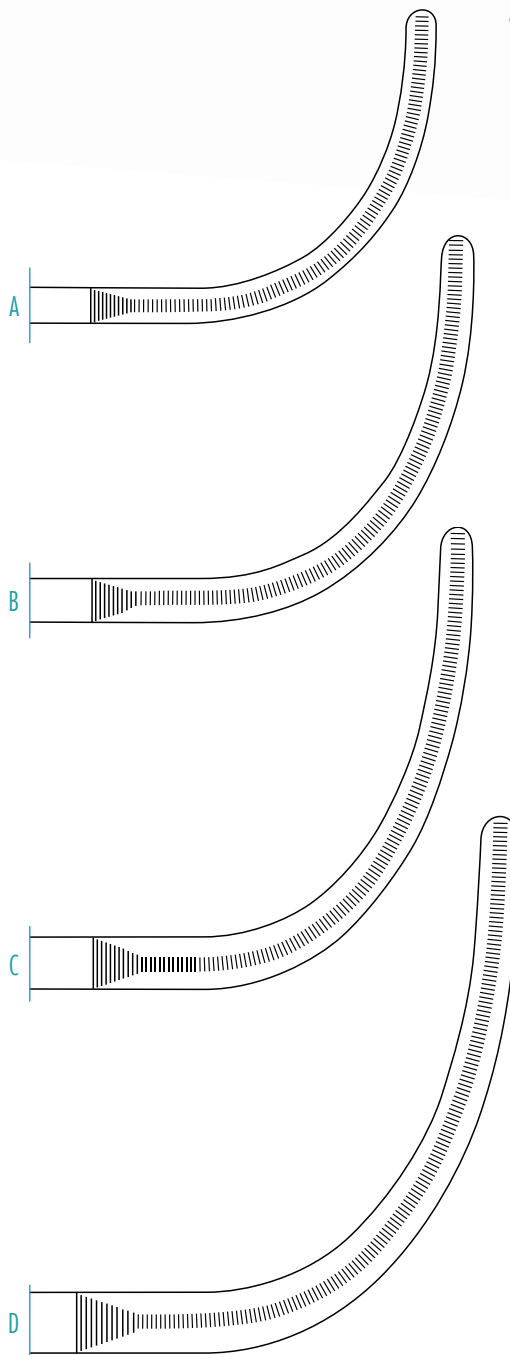

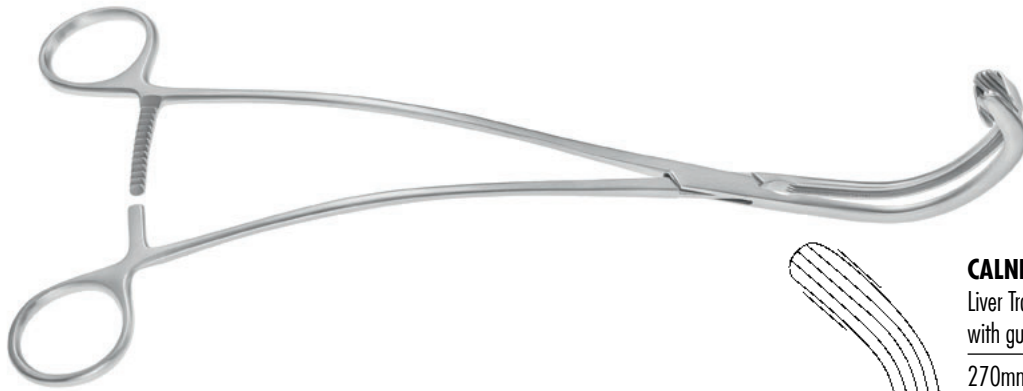

CALNE

Liver Transplant Clamp
with guide lock, DeBakey jaws

270mm, 10²/₃" 290-418-270

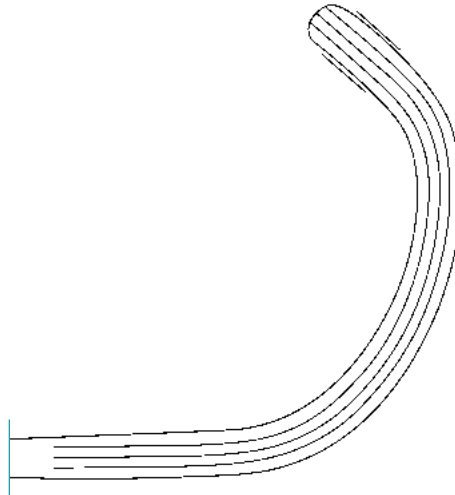

KLINTMALM

Liver Transplant Clamp
medium

215mm, 8¹/₂" 290-680-215

large

255mm, 10" 290-695-255

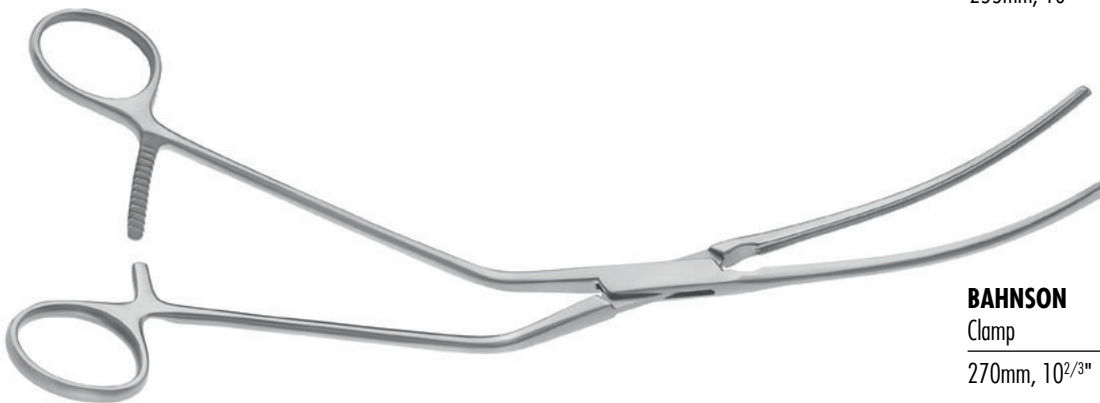
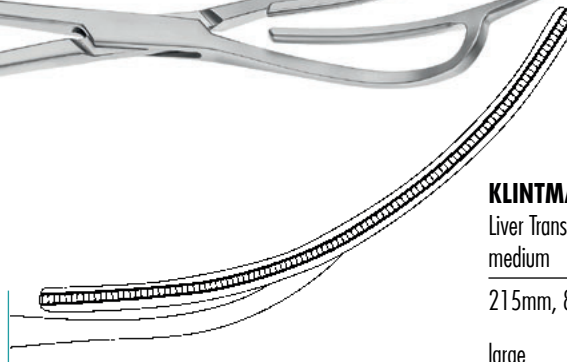

BAHNSON

Clamp

270mm, 10²/₃" 290-418-280

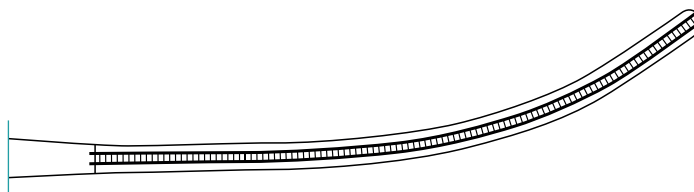



DEBAKEY BAHNSON

Clamp

A	255mm, 10"	290-433-230
B	265mm, 10 ^{1/2} "	290-433-250
C	280mm, 11"	290-433-270

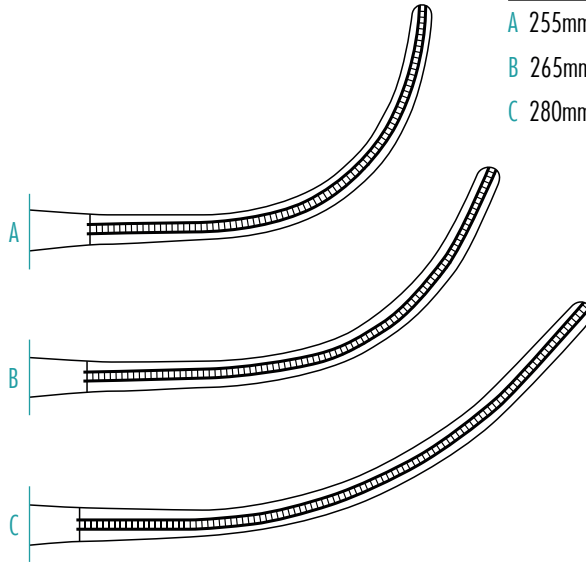

DEBAKEY

Clamp

	260mm, 10 ^{1/4} "	290-423-260
--	----------------------------	-------------

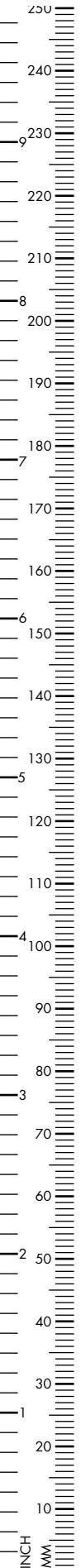
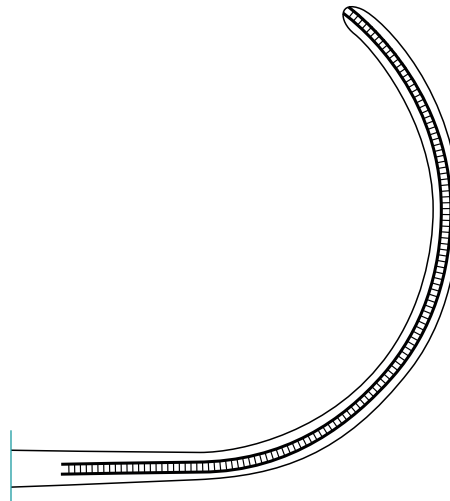

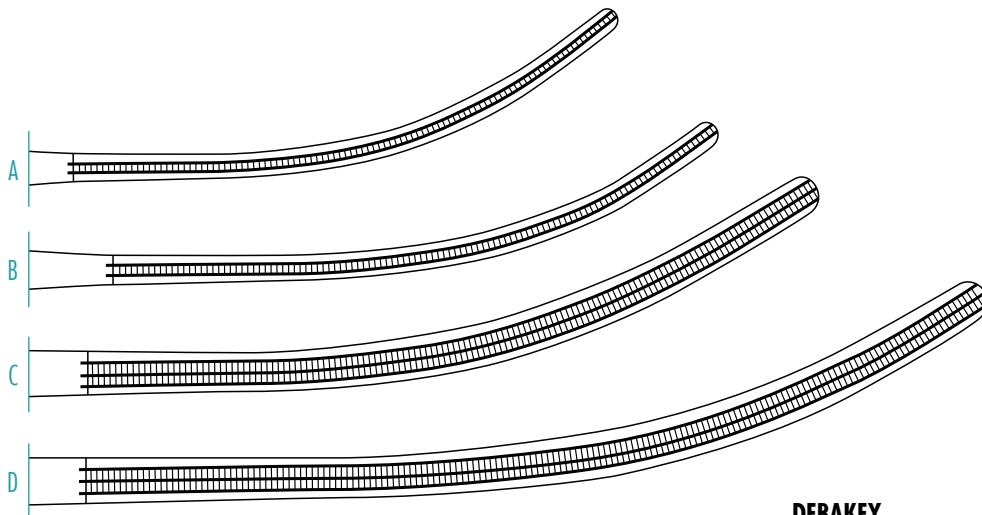

DEBAKEY

Clamp, c-curved,
1x2 teeth

A 260mm, 10^{1/4}" 290-417-260

B 270mm, 10^{2/3}" 290-417-300

2x3 teeth

C 310mm, 12^{1/4}" 290-418-310

D 335mm, 13" 290-418-330

s-curved, 2x3 teeth

B 270mm, 10^{2/3}" 290-420-300

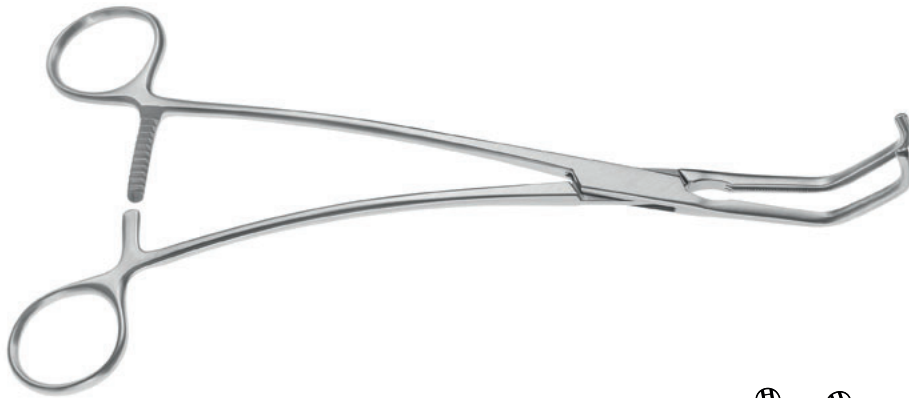

SATINSKY
Tangential Clamp

A	200mm, 8"	290-425-200
B	240mm, 9 ¹ / ₂ "	290-425-240
C	250mm, 9 ⁷ / ₈ "	290-425-250
D	265mm, 10 ¹ / ₂ "	290-425-260
E	285mm, 11 ¹ / ₄ "	290-425-275

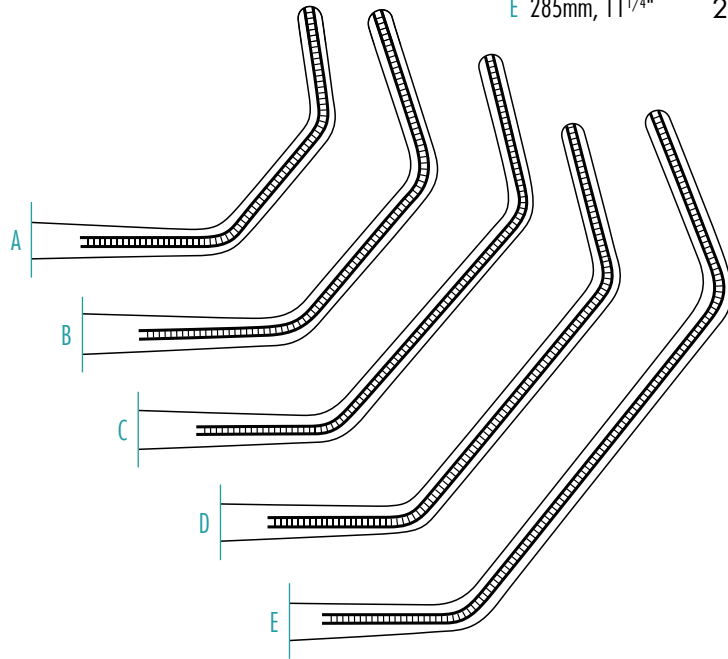

SATINSKY
Tangential Occlusion Clamp

A	235mm, 9 ¹ / ₄ "	290-511-235
B	240mm, 9 ¹ / ₂ "	290-511-240
C	245mm, 9 ² / ₃ "	290-511-245

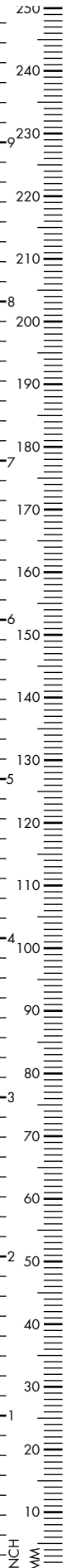
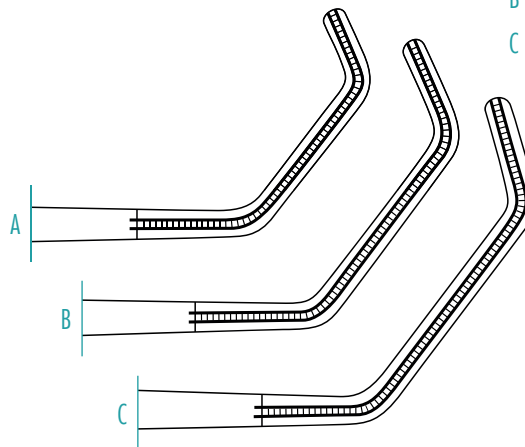

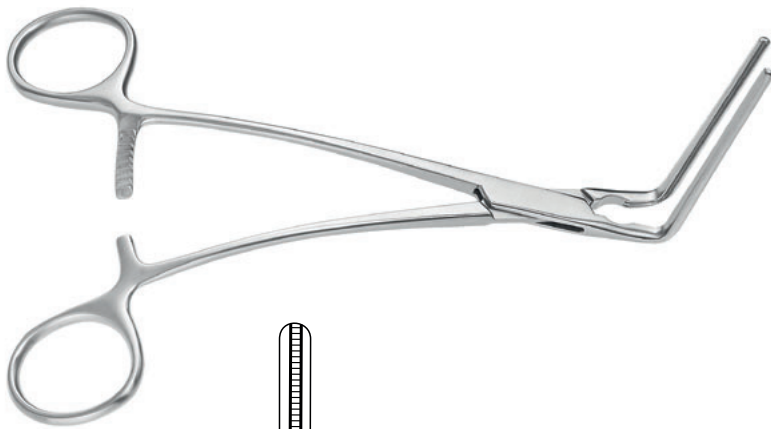

DEBAKEY

Multi-Purpose Clamps

A	180mm, 7"	290-436-180
B	190mm, 7 ¹ / ₂ "	290-436-190
C	225mm, 8 ⁷ / ₈ "	290-436-230
D	270mm, 10 ² / ₃ "	290-436-270
E	200mm, 8"	290-437-200
F	210mm, 8 ¹ / ₄ "	290-437-210
G	290mm, 11 ¹ / ₂ "	290-437-290
H	250mm, 9 ⁷ / ₈ "	290-437-250
I	180mm, 7"	290-442-180
J	190mm, 7 ¹ / ₂ "	290-442-190
K	210mm, 8 ¹ / ₄ "	290-442-210

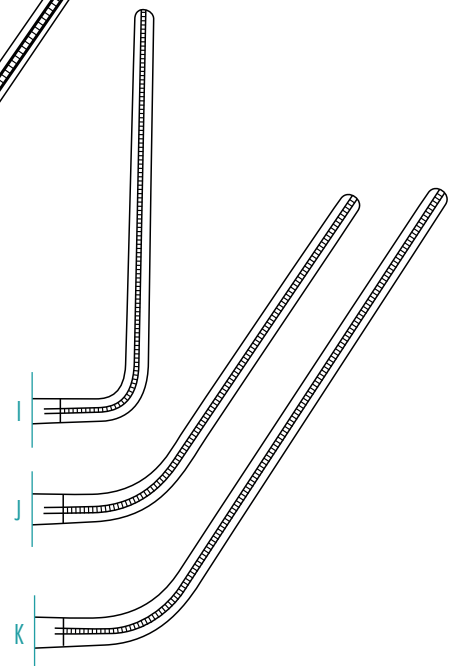
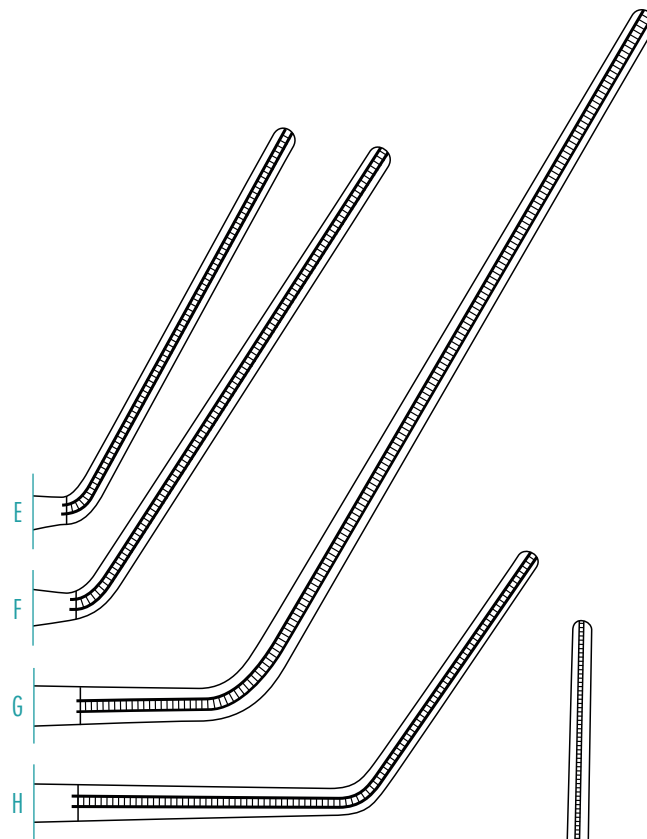
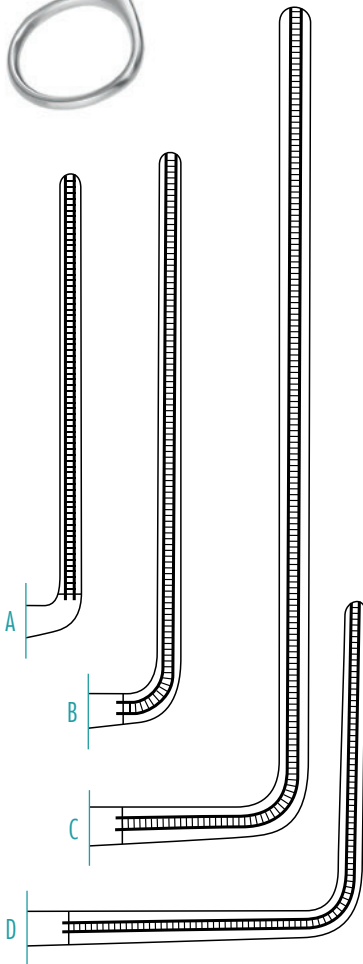

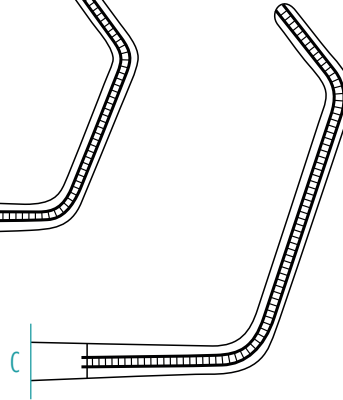
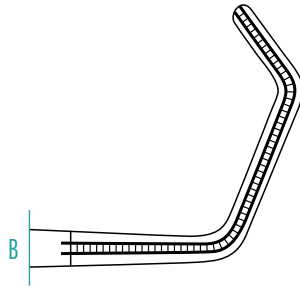
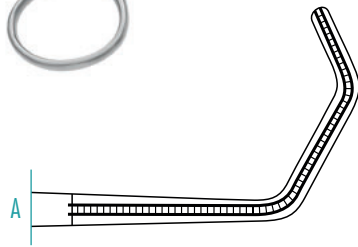
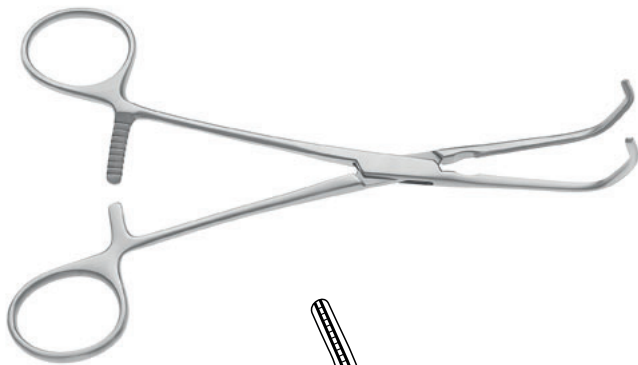

DEBAKEY BECK Clamp

A	170mm, 6 ² / ₃ "	290-457-170
B	195mm, 7 ³ / ₄ "	290-457-190
C	210mm, 8 ¹ / ₄ "	290-457-210

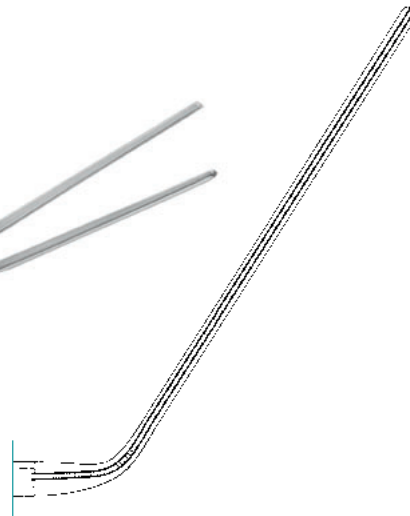
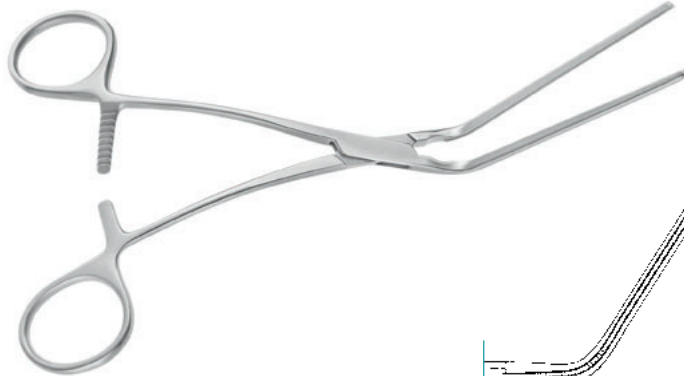

LELAND JONES

Peripheral Vascular Clamps,
shanks curved backwards,
60° angled backwards

180mm, 7"	290-413-180
-----------	-------------

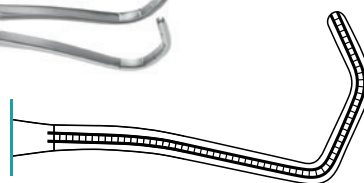
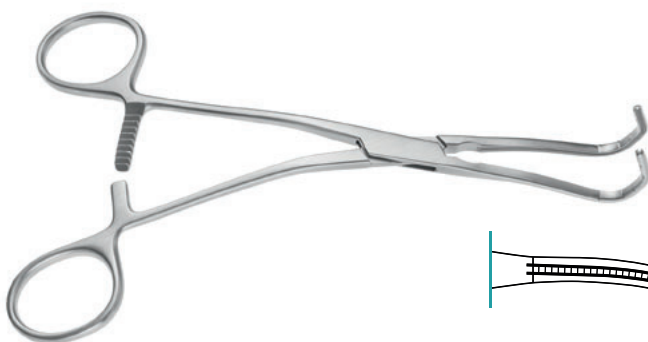

DEBAKEY

Anastomosis Clamp

170mm, 6 ² / ₃ "	290-431-170
--	-------------

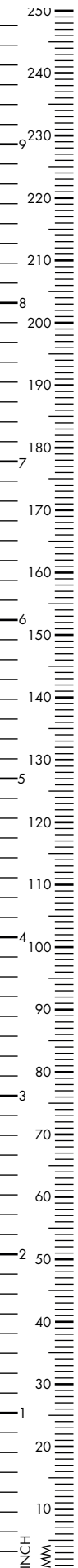

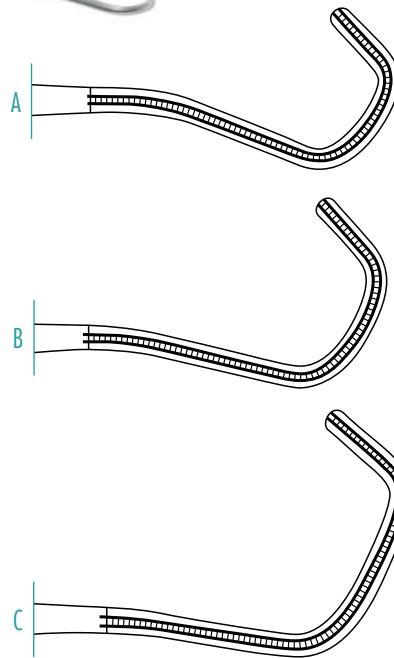

DEBAKEY DERRA

Anastomosis Clamp

A	160mm, 6 ¹ / ₄ "	290-456-160
B	170mm, 6 ² / ₃ "	290-456-170
C	180mm, 7"	290-456-180

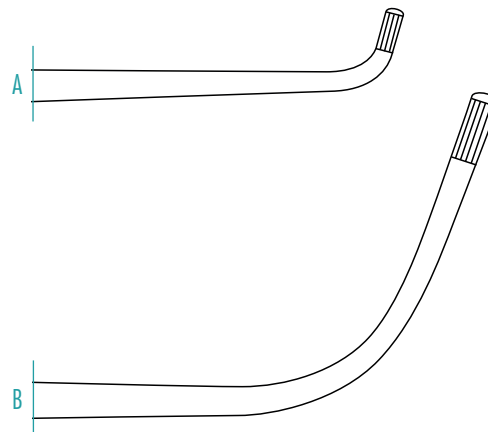
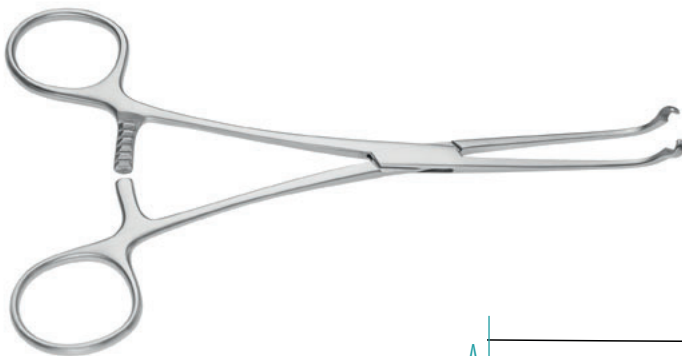

JAVID

Clamp, 180mm, 7"

A	290-343-180
B	290-343-190

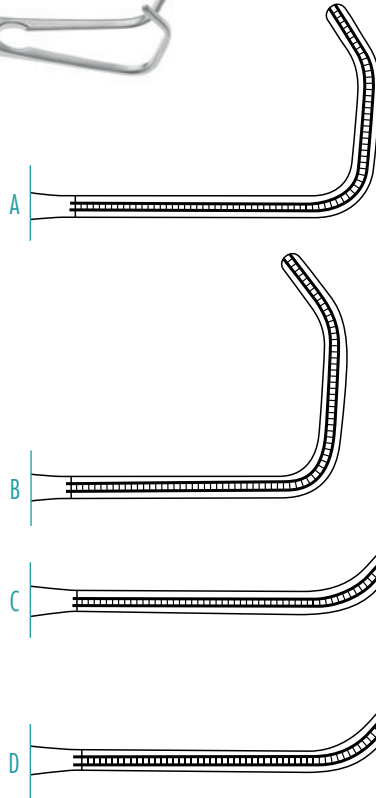
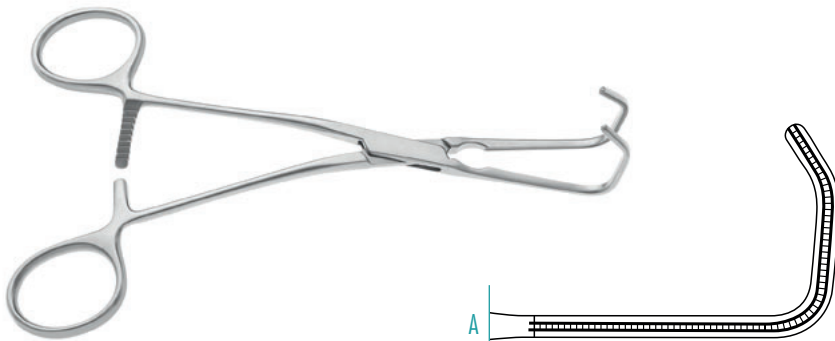

DEBAKEY REYNOLDS

Anastomosis Clamp

A	165mm, 6 ¹ / ₂ ", small	290-429-001
B	165mm, 6 ¹ / ₂ ", large	290-429-002
C	180mm, 7", small	290-429-003
D	180mm, 7", large	290-429-004

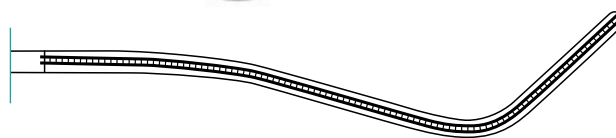
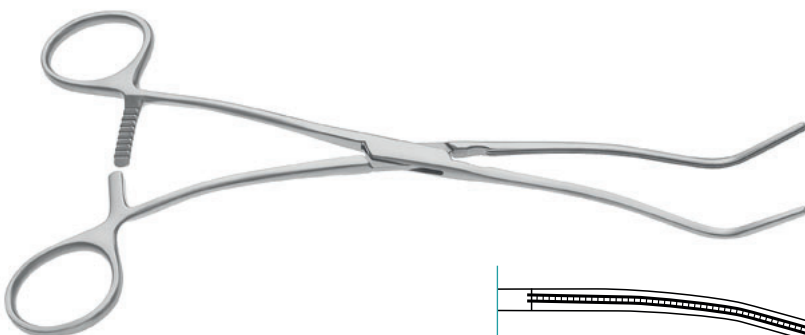

DEBAKEY

Renal Artery Clamp

200mm, 8"	290-416-200
-----------	-------------

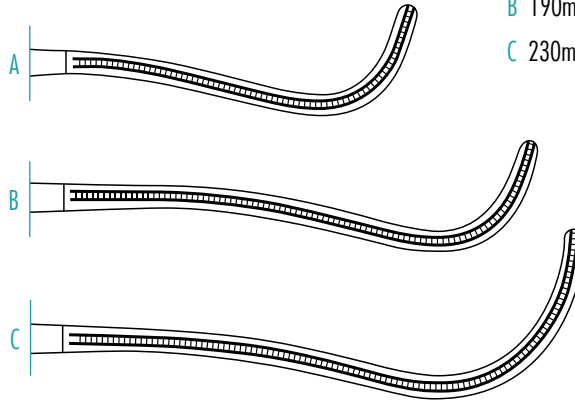
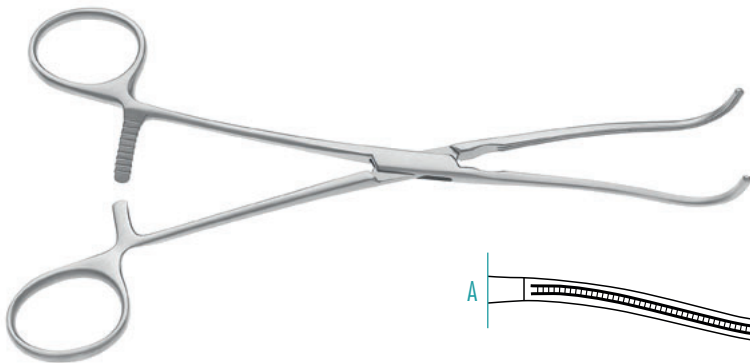

DEBAKEY

Dissecting and Ligature Forceps

A	230mm, 9"	290-409-230
B	190mm, 7 ¹ / ₂ "	290-408-190
C	230mm, 9"	290-408-230

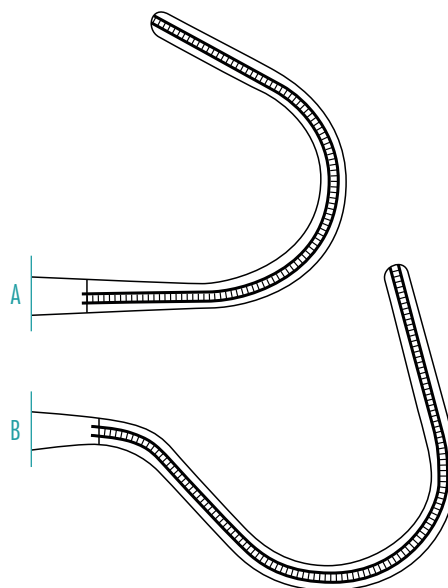

WYLIE

Vascular Clamp

A	210mm, 8 ¹ / ₄ "	290-453-210
B	220mm, 8 ² / ₃ "	290-453-220



DALE

Peripheral Vascular Clamp

A	170mm, 6 ² / ₃ "	290-341-170
B	180mm, 7"	290-341-180
C	185mm, 7 ¹ / ₄ "	290-341-190
D	180mm, 7"	290-340-180

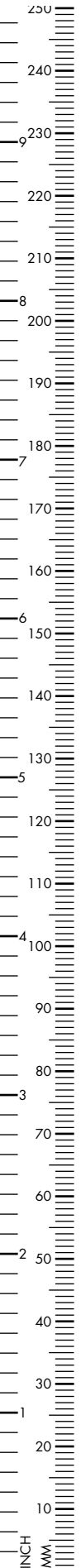
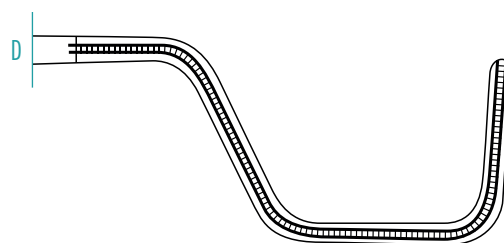
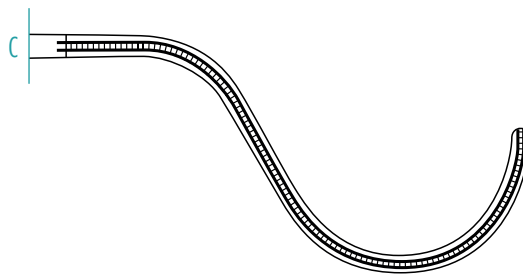
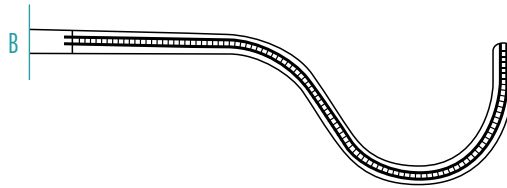
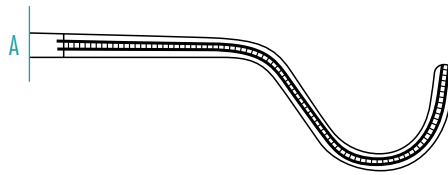

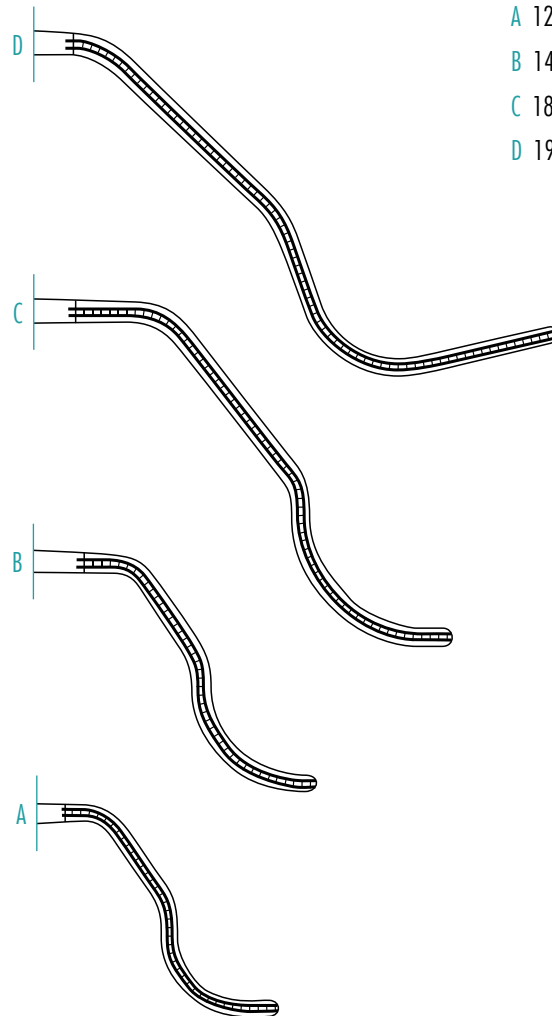

GREGORY

Profunda Clamp

A	120mm, 4 ³ / ₄ "	290-342-120
B	140mm, 5 ¹ / ₂ "	290-342-140
C	180mm, 7"	290-342-160
D	190mm, 7 ¹ / ₂ "	290-342-180

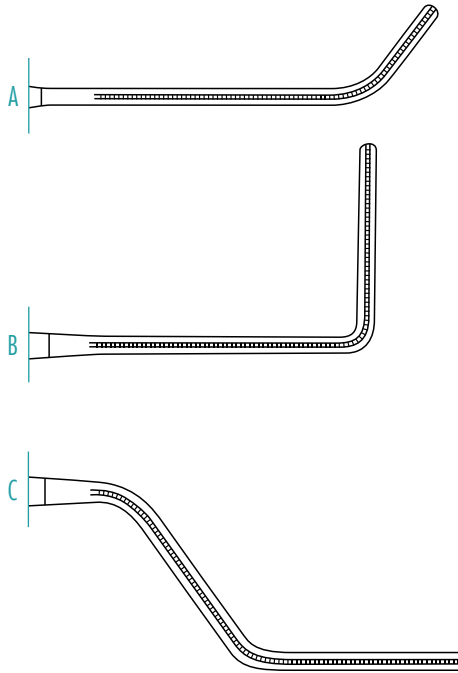
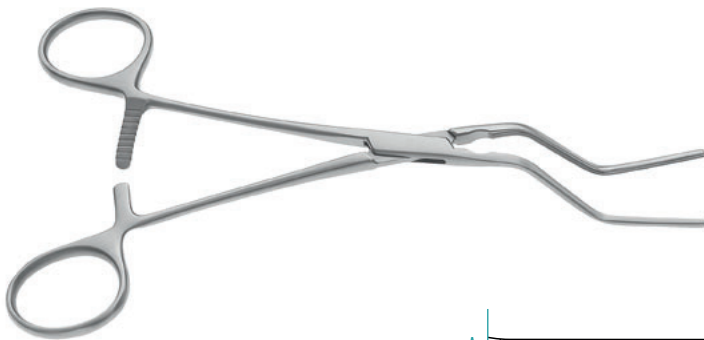

HUSFELDT
Carotid Profunda Clamp

A	180mm, 7"	290-594-175
B	170mm, 6 ² / ₃ "	290-594-170
C	180mm, 7"	290-594-180

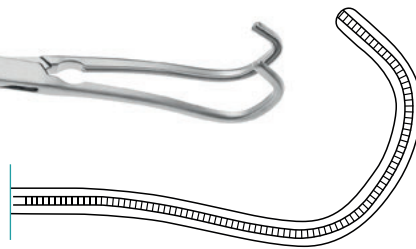
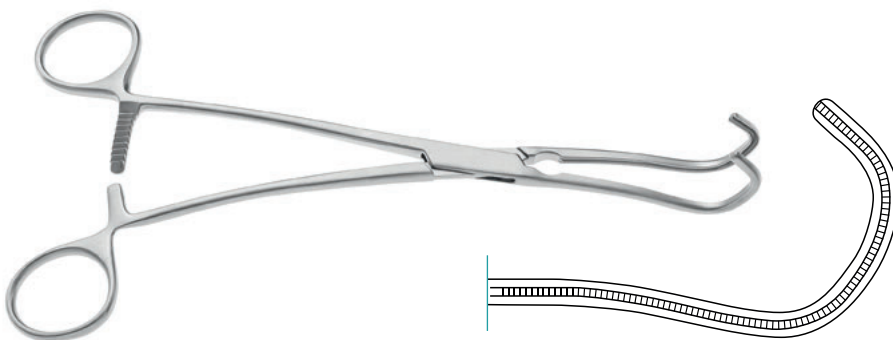

MITCHELL
Clamp

200mm, 8"	290-424-200
-----------	-------------

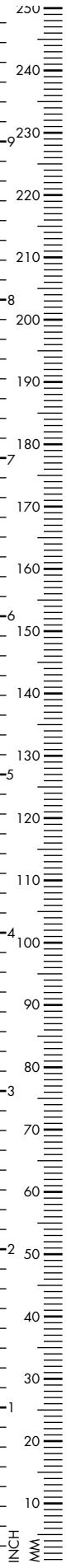

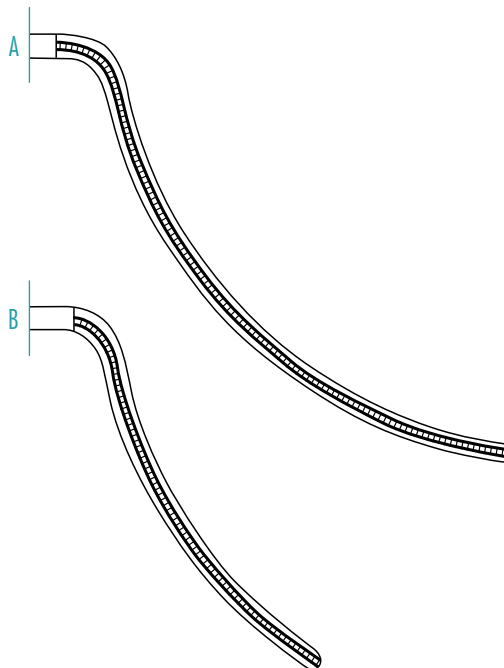

WYLIE

Vascular Clamps, shanks curved up

A 160mm, 6¹/₄" 290-344-160

B 180mm, 7" 290-344-180

shanks curved down

A 170mm, 6²/₃" 290-344-170

B 200mm, 8" 290-344-200

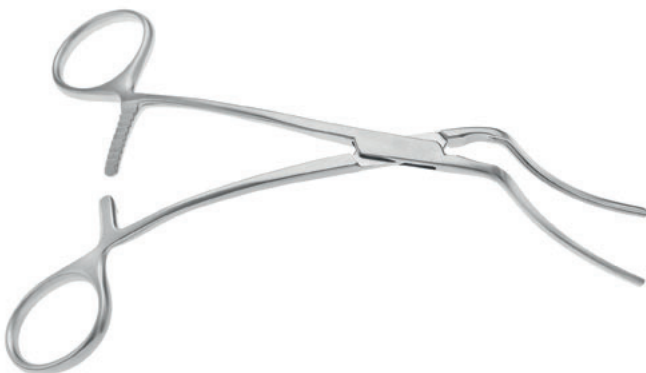

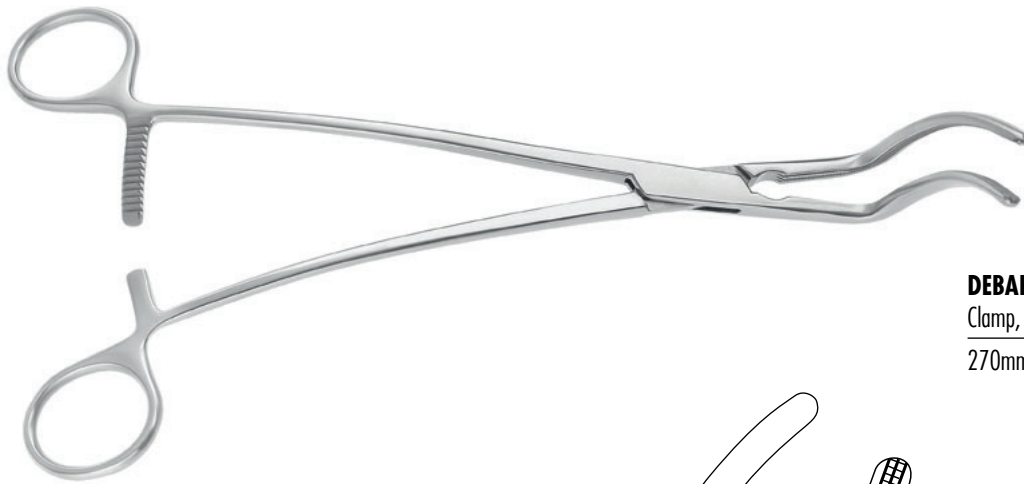

DEBAKEY

Clamp, 2x3 teeth

270mm, 10²/₃"

290-420-270

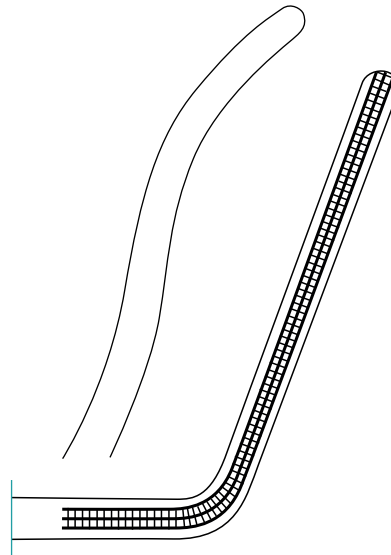

GRANT

Abdominal Clamp, 2x3 teeth

245mm, 9²/₃"

290-431-230

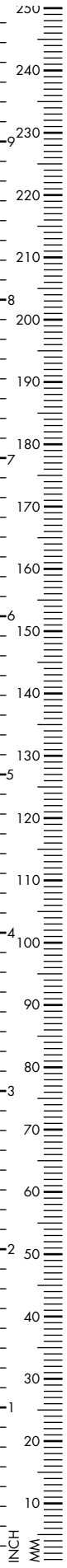



DEBAKEY
Ligature Clamp

A	270mm, 10 ² / ₃ "	290-423-250
B	240mm, 9 ¹ / ₂ "	290-421-240

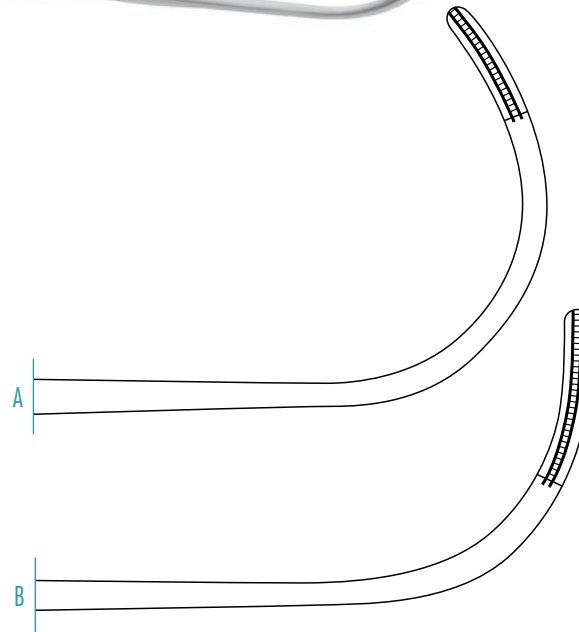

DEBAKEY
Ligature Clamp

A	160mm, 6 ¹ / ₄ "	290-455-170
B	160mm, 6 ¹ / ₄ "	290-453-160

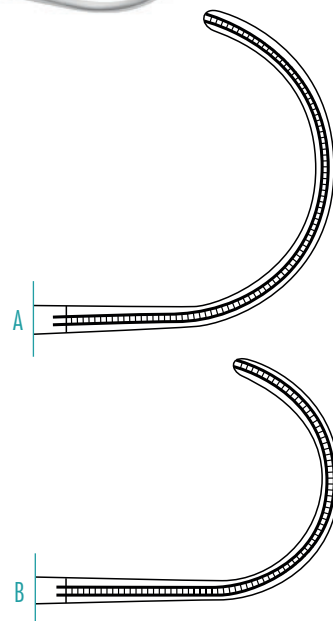



DEBAKEY HARKEN

Auricle Clamp, 240mm, 9¹/₂"

A Fig. 1	290-426-001
B Fig. 2	290-426-002
C Fig. 3	290-426-003
D Fig. 4	290-426-004

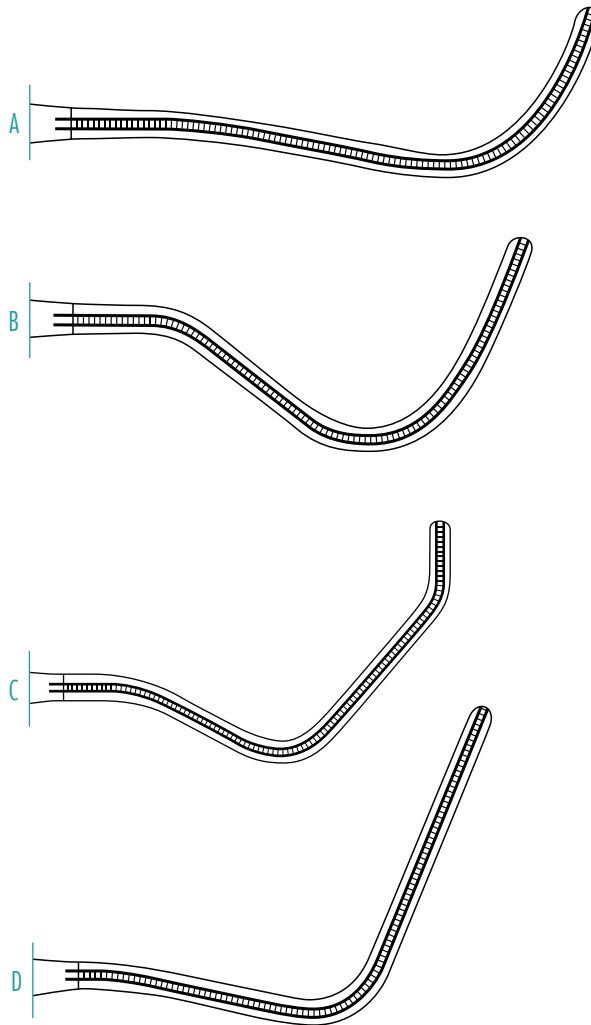

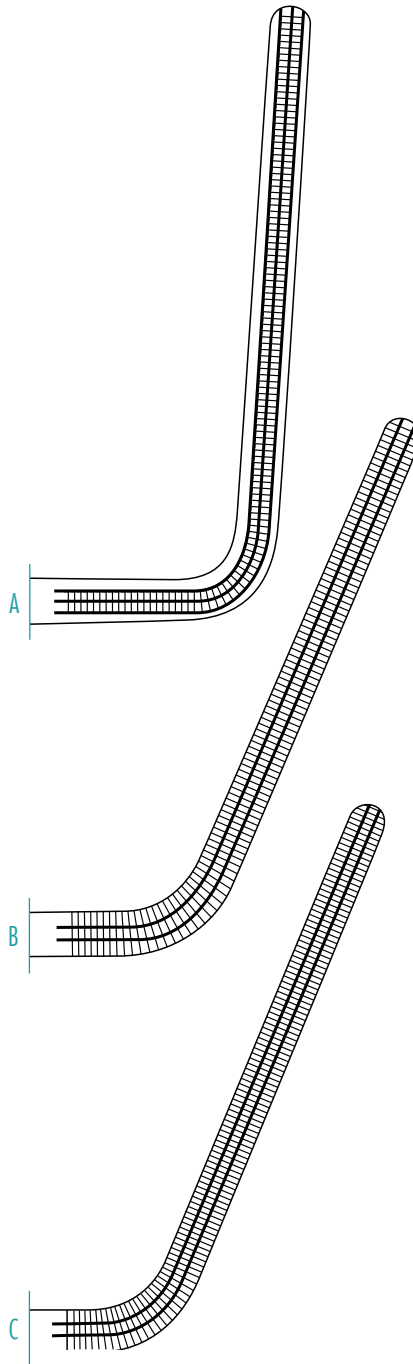

MORRIS

Clamp, 2x3 teeth

A	230mm, 9"	290-432-230
B	250mm, 9 ⁷ / ₈ "	290-432-250
C	200mm, 8"	290-432-200



ZANGER

Abdominal Clamp

A	215mm, 8 ¹ / ₂ "	290-413-220
	1x2 teeth	
B	250mm, 9 ⁷ / ₈ "	290-413-250
	1x2 teeth	
C	305mm, 12"	290-414-310
	2x3 teeth	

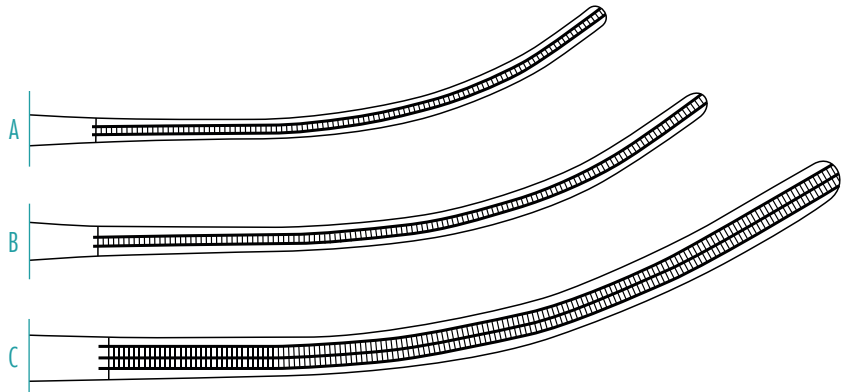

WYLIE

Hypogastric and Abdominal Clamp

A	240mm, 9 ¹ / ₂ "	290-454-260
B	240mm, 9 ¹ / ₂ "	290-454-240
B	280mm, 11"	290-454-280

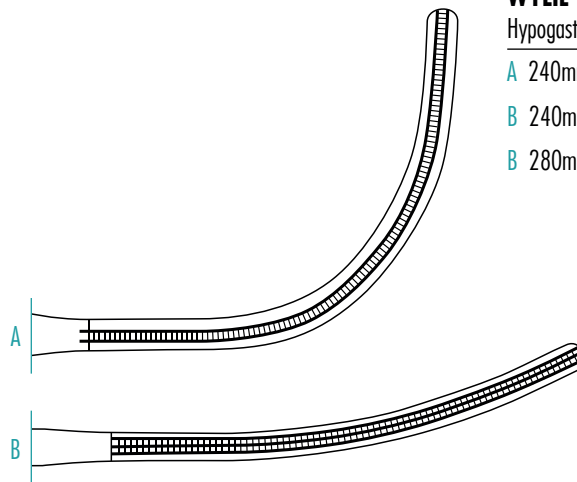

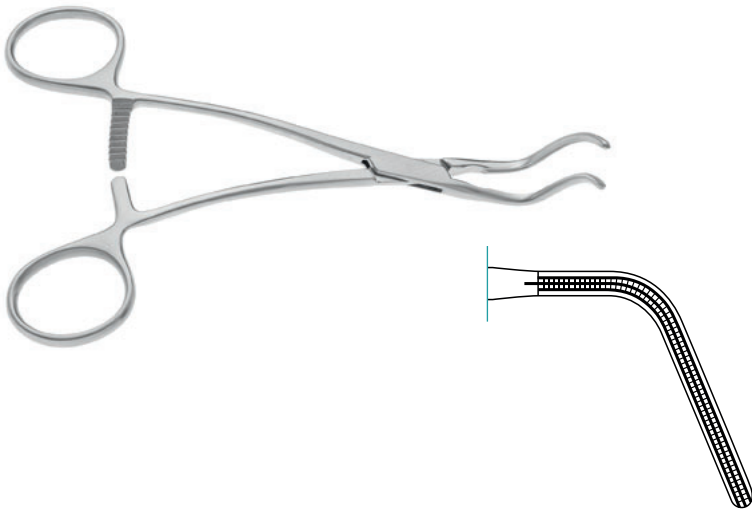

SUBRAMANIAN
Miniature Clamp

160mm, 6¹/₄" 290-559-150

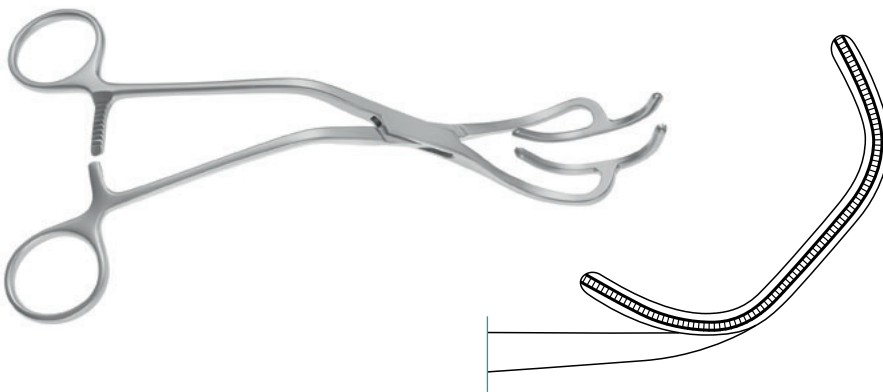

STRONG
Clamp, 175mm, 6⁷/₈"

41x16mm jaw 290-175-410

45x23mm jaw 290-175-450

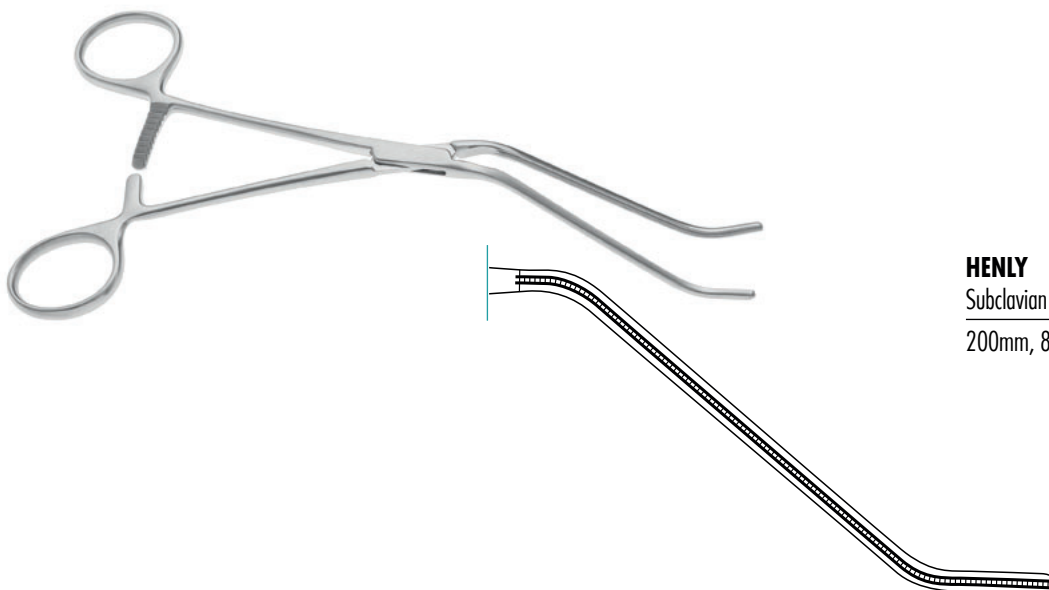

HENLY
Subclavian Artery Clamp

200mm, 8" 290-460-200



DEBAKEY EXTRA FINE
Pediatric Vessel Clamp

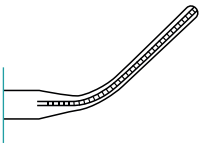

Angled shanks 45°
105mm, 4¹/₈" 290-599-001

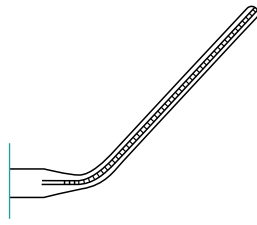

Angled shanks 45°
125mm, 5" 290-599-002

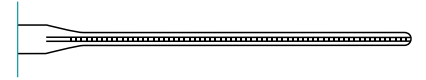

Straight shanks
140mm, 5¹/₂" 290-599-003

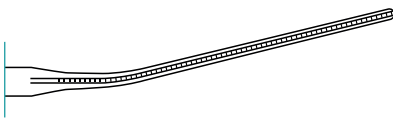

Curved shanks 15°
140mm, 5¹/₂" 290-599-004

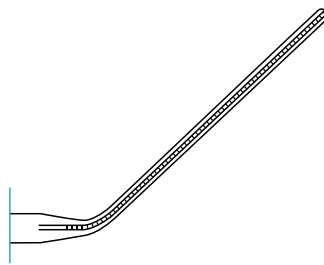

Curved shanks 45°
140mm, 5¹/₂" 290-599-005

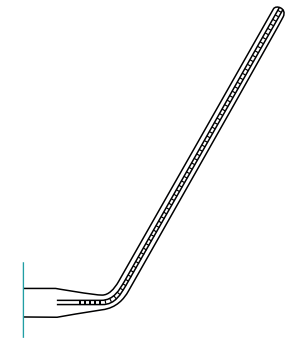

Angled shanks 90°
140mm, 5¹/₂" 290-599-006

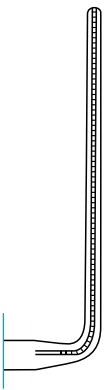

Angled shanks 90°
140mm, 5¹/₂" 290-599-007

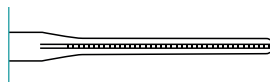

Straight shanks
155mm, 6¹/₈" 290-599-008

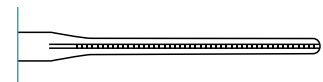

20° angled shanks
155mm, 6¹/₈" 290-599-009

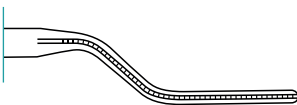

Curved shanks
150mm, 6" 290-599-010

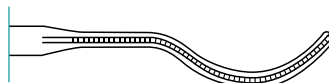

Straight shanks
150mm, 6" 290-599-011

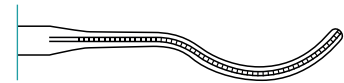

Angled shanks
145mm, 5³/₄" 290-599-012

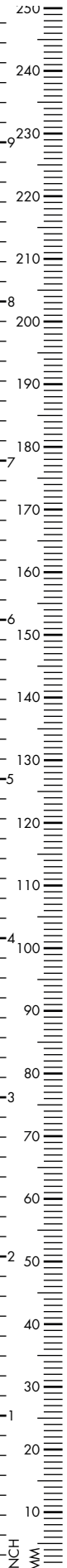



DEBAKEY EXTRA FINE
Pediatric Vessel Clamp

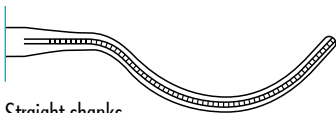

Straight shanks
155mm, 6¹/₈" 290-599-013

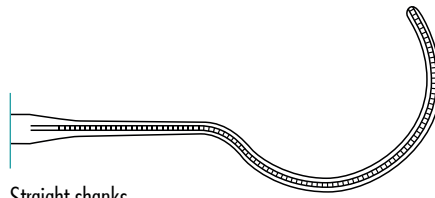

Straight shanks
170mm, 6³/₄" 290-599-014

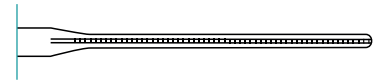

Straight shanks
165mm, 6¹/₂" 290-599-015



Angled shanks
165mm, 6¹/₂" 290-599-016

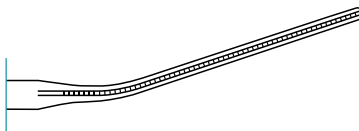

Straight shanks, 15°
155mm, 6¹/₈" 290-599-017

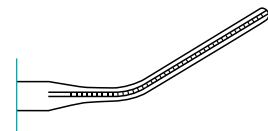

Straight shanks, 30°
145mm, 5³/₄" 290-599-018

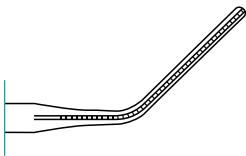

Straight shanks, 45°
145mm, 5³/₄" 290-599-019

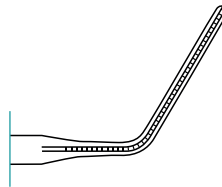

Straight shanks, 60°
145mm, 5³/₄" 290-599-020

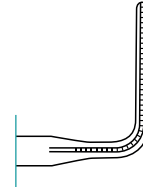

Straight shanks, 90°
140mm, 5¹/₂" 290-599-021

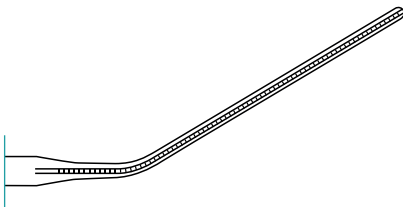

Curved shanks, 30°
160mm, 6¹/₄" 290-599-022

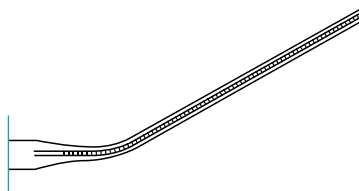

Curved shanks, 45°
160mm, 6¹/₄" 290-599-023

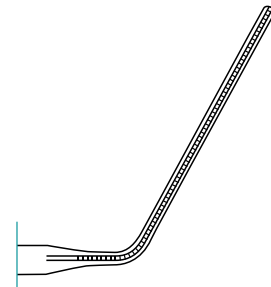

Curved shanks, 60°
145mm, 5³/₄" 290-599-024



DEBAKEY EXTRA FINE
Pediatric Vessel Clamp

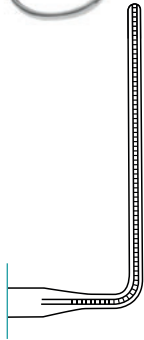

Curved shanks, 90°
130mm, 5¹/₈" 290-599-025

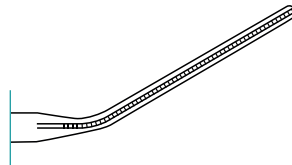

Straight shanks, 30°
120mm, 4³/₄" 290-599-026

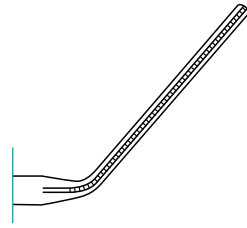

Straight shanks, 50°
120mm, 4³/₄" 290-599-027

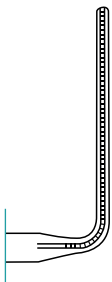

Straight shanks, 90°
105mm, 4¹/₈" 290-599-028

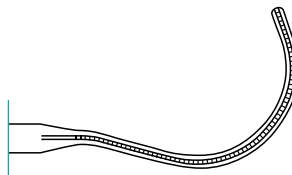

Curved shanks
120mm, 4³/₄" 290-599-029

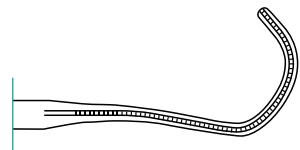

Curved shanks
145mm, 5³/₄" 290-599-030

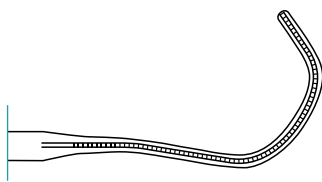

Curved shanks
145mm, 5³/₄" 290-599-031

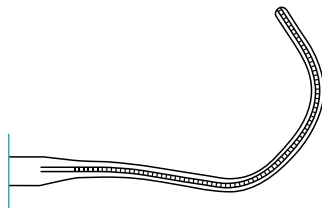

Curved shanks
160mm, 6¹/₄" 290-599-032

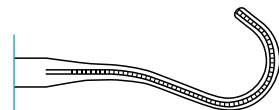

Angled shanks
115mm, 4¹/₂" 290-599-033

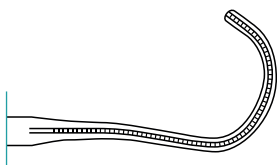

Angled shanks
115mm, 4¹/₂" 290-599-034

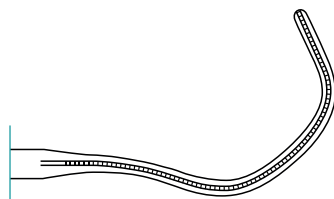

Angled shanks
150mm, 6" 290-599-035

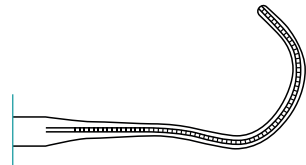

Curved shanks
115mm, 4¹/₂" 290-599-036

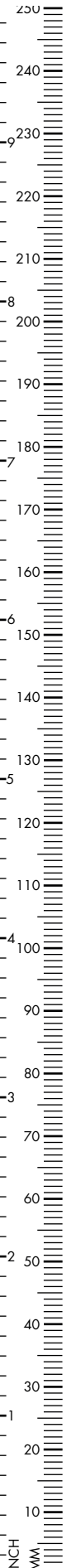



DEBAKEY EXTRA FINE
Pediatric Vessel Clamp

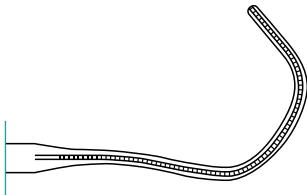

Curved shanks
150mm, 6" 290-599-037

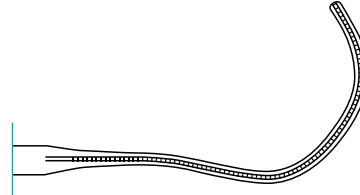

Curved shanks
160mm, 6¹/₄" 290-599-038

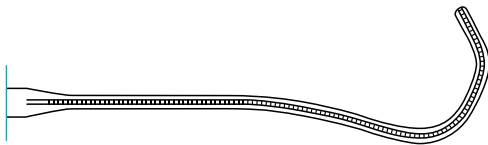

Curved shanks
180mm, 7" 290-599-039

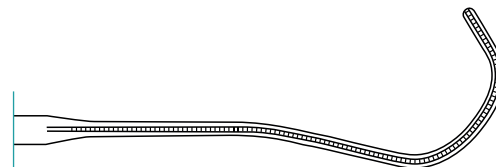

Curved shanks
180mm, 7" 290-599-040

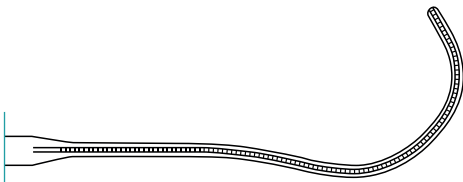

Curved shanks
180mm, 7" 290-599-041

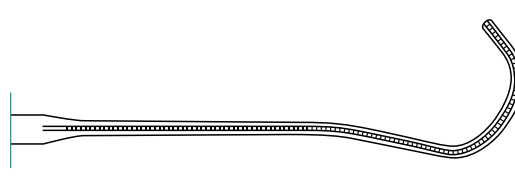

Angled shanks
180mm, 7" 290-599-042

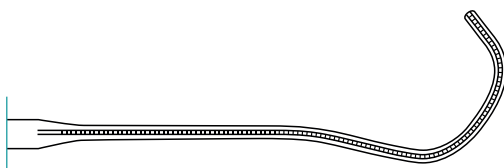

Angled shanks
180mm, 7" 290-599-043

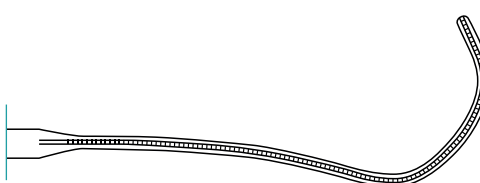

Angled shanks
180mm, 7" 290-599-044



DEBAKEY EXTRA FINE
Pediatric Vessel Clamp

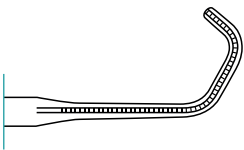

Curved shanks

115mm, 4¹/₂"

290-599-045

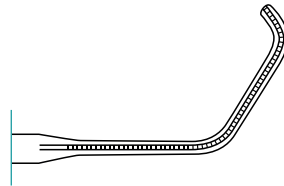

Angled shanks

120mm, 4³/₄"

290-599-046

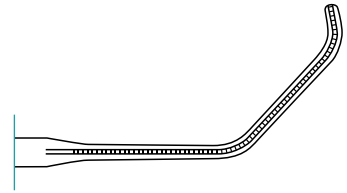

Angled shanks

150mm, 6"

290-599-047



Curved shanks

170mm, 6²/₃"

290-599-048



Curved shanks

175mm, 6⁷/₈"

290-599-049



Curved shanks

180mm, 7"

290-599-050

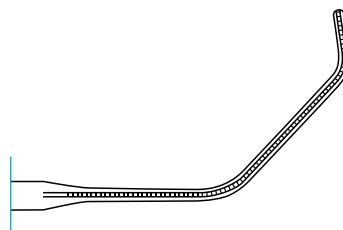

Curved shanks, carotid

150mm, 6"

290-599-051



DEBAKEY

Premature Baby Vascular Clamp,
ultrafine

105mm, 4¹/₈"



Shanks angled backwards

290-587-001

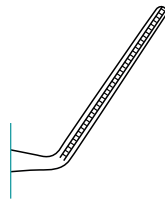

Angled shanks

290-587-002

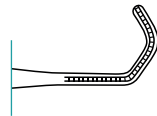

Shanks slightly angled backwards

290-587-003



Straight shanks

290-587-004

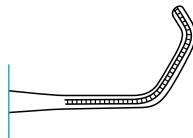

Shanks slightly curved backwards

290-587-005

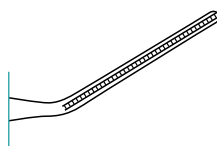

Straight shanks

290-587-006

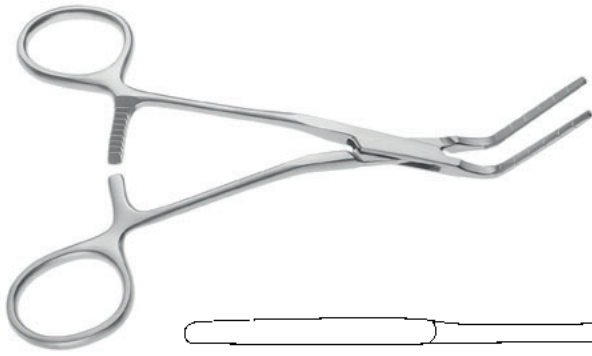

CASTANEDA

Castaneda Neonatal Clamp, fine
155mm, 6¹/₈"

- 1 Straight shanks
- 2 Slightly curved shanks
- 3 Slightly angled shanks
- 4 Strongly angled shanks

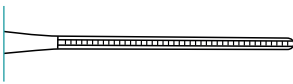
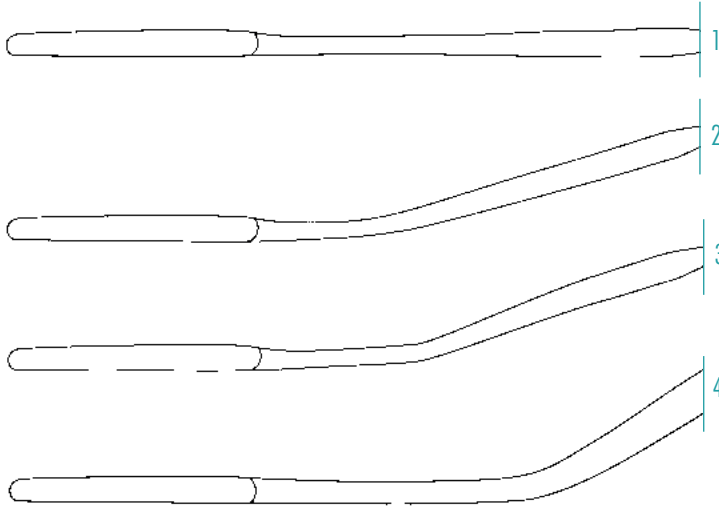

Straight jaw

1	290-594-001
2	290-598-001
3	290-596-001
4	290-597-001

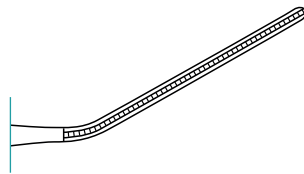

Angled jaw, 30°

1	290-594-002
2	290-598-002
3	290-596-002
4	290-597-002

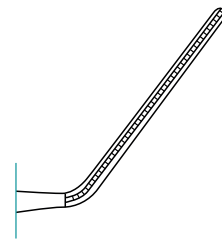

Angled jaw, 45°

1	290-594-003
2	290-598-003
3	290-596-003
4	290-597-003

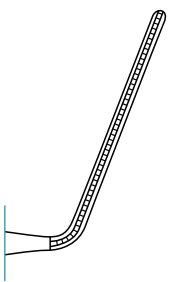

Angled jaw, 60°

1	290-594-004
2	290-598-004
3	290-596-004
4	290-597-004

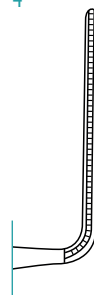

Angled jaw, 90°

1	290-594-005
2	290-598-005
3	290-596-005
4	290-597-005

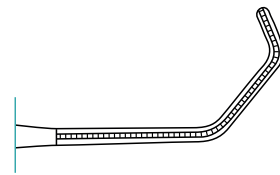

Angled jaw

1	290-594-006
2	290-598-006
3	290-596-006
4	290-597-006

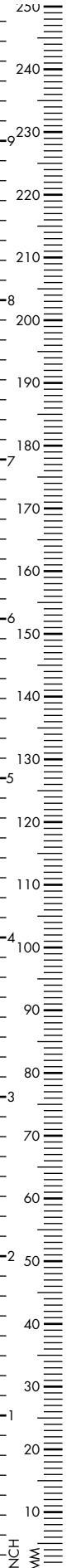

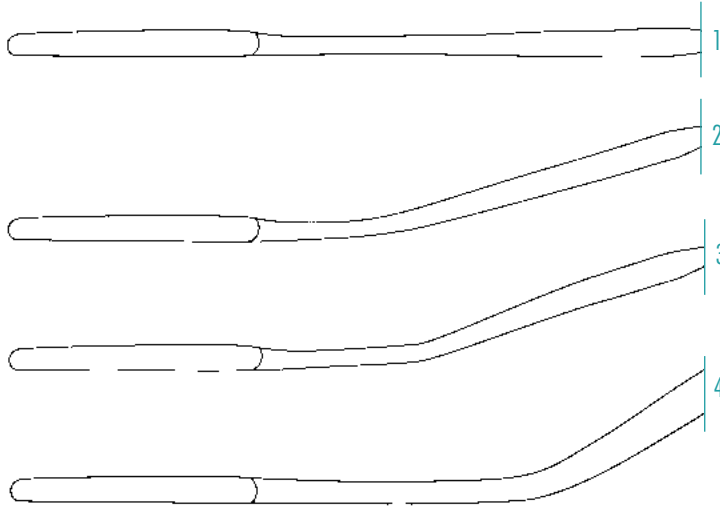
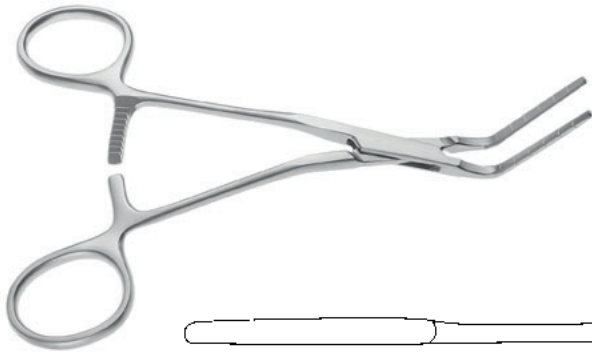

CASTANEDA

Castaneda Neonatal Clamp, fine
155mm, 6¹/₈"

- 1 Straight shanks
- 2 Slightly curved shanks
- 3 Slightly angled shanks
- 4 Strongly angled shanks

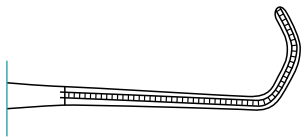

Angled jaw

1	290-594-007
2	290-598-007
3	290-596-007
4	290-597-007

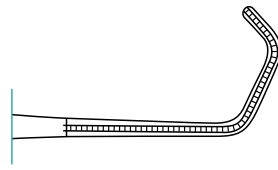

Angled jaw

1	290-594-008
2	290-598-008
3	290-596-008
4	290-597-008

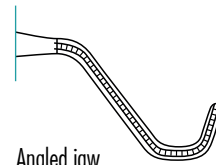

Angled jaw

1	290-594-009
2	290-598-009
3	290-596-009

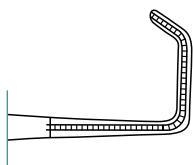

Angled jaw

1	290-594-010
2	290-598-010
3	290-596-010

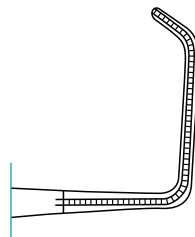

Angled jaw

1	290-594-011
2	290-598-011
3	290-596-011

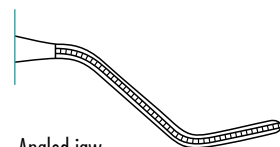

Angled jaw

1	290-594-012
2	290-598-012
3	290-596-012
4	290-597-012

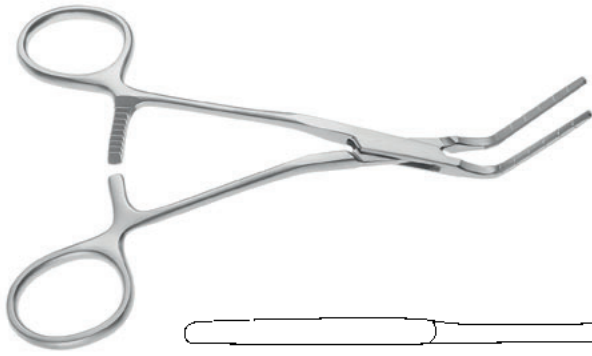

CASTANEDA

Castaneda Neonatal Clamp, fine
110mm, 6^{1/8}"

- 1 Straight shanks
- 2 Slightly curved shanks
- 3 Slightly angled shanks
- 4 Strongly angled shanks

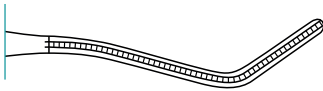
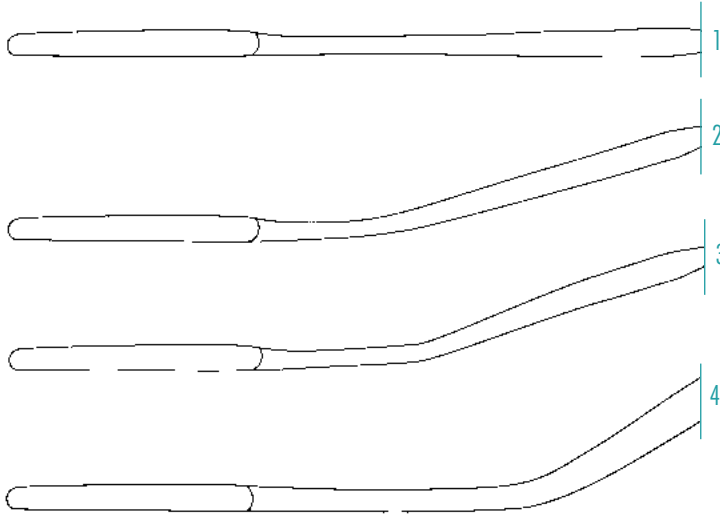

Angled jaw

1	290-594-013
2	290-598-013
3	290-596-013

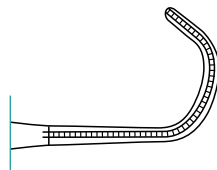

Curved jaw

1	290-594-014
2	290-598-014
3	290-596-014

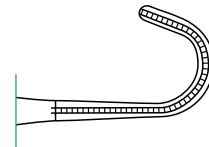

Curved jaw

1	290-594-015
2	290-598-015
3	290-596-015

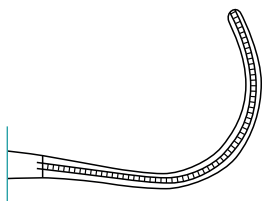

Curved jaw

1	290-594-016
2	290-598-016

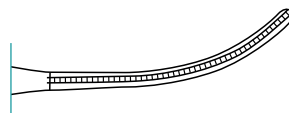

Curved jaw

1	290-594-017
2	290-598-017
3	290-596-017



Curved jaw

1	290-594-018
2	290-598-018

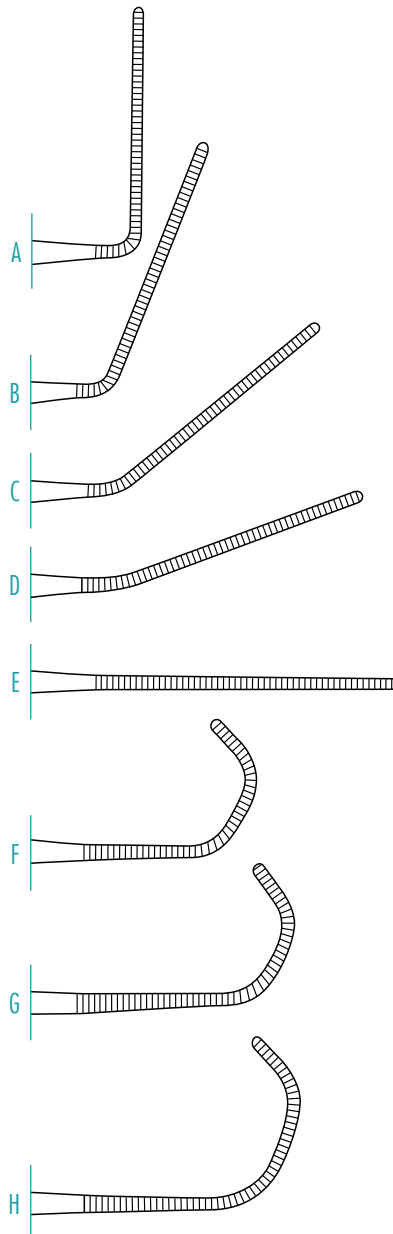

CASTANEDA

Neonatal Clamp, extra delicate, graduated, shanks curved backwards

A	130mm, 5 ¹ / ₈ "	290-593-003
B	130mm, 5 ¹ / ₈ "	290-593-002
C	130mm, 5 ¹ / ₈ "	290-593-001
D	130mm, 5 ¹ / ₈ "	290-593-000
E	130mm, 5 ¹ / ₈ "	290-593-004
F	150mm, 6"	290-595-001
G	150mm, 6"	290-595-002
H	150mm, 6"	290-595-003

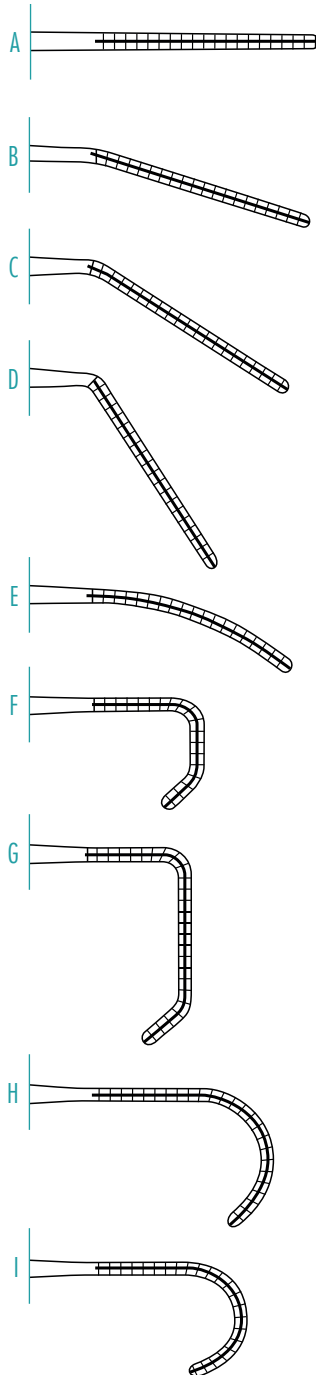

BABY COOLEY

Pediatric Clamp, shanks curved backwards
140mm, 5^{1/2}"

A straight	290-573-001
B angled 15°	290-573-002
C angled 45°	290-573-003
D angled 60°	290-573-004
125mm, 5"	
E curved	290-573-005
130mm, 5 ^{1/8} "	
F angled	290-573-006
140mm, 5 ^{1/2} "	
G angled	290-573-007
H curved	290-573-008
I curved	290-573-009

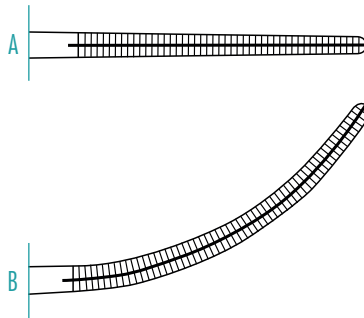

COOLEY

Atrauma Clamp, straight shanks

A	140mm, 5 ¹ / ₂ "	290-465-000
B	120mm, 4 ³ / ₄ "	290-465-002

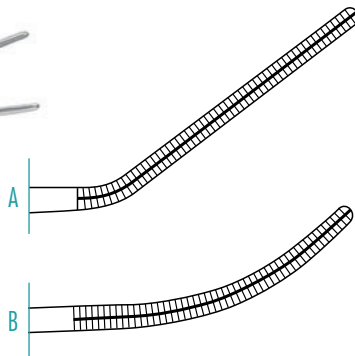
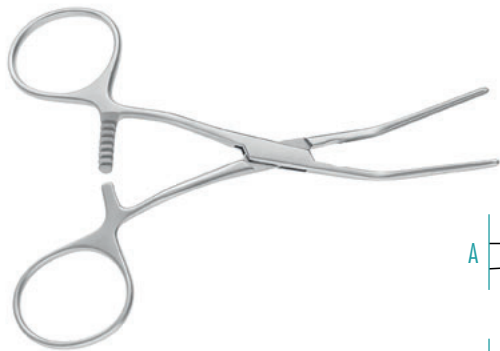

curved shanks

A	125mm, 5"	290-465-004
B	120mm, 4 ³ / ₄ "	290-465-003

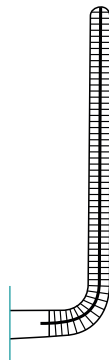

straight shanks

100mm, 4"	290-465-007
-----------	-------------

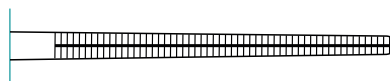

angled shanks

125mm, 5"	290-465-001
-----------	-------------

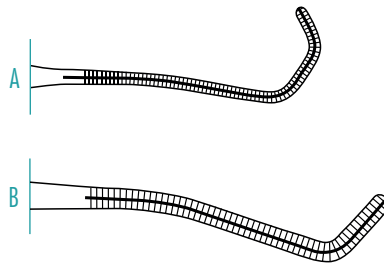

COOLEY

Atrauma Clamp, s-angled

A 120mm, 4³/₄" 290-465-008

B 120mm, 4³/₄" 290-465-005

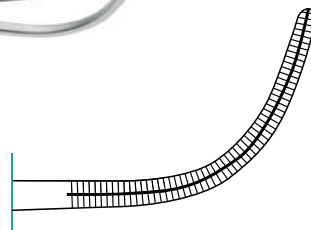

COOLEY

Vascular Clamp

160mm, 6¹/₄" 290-469-160

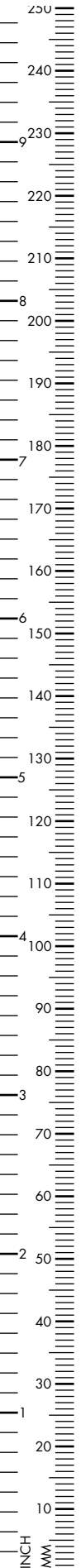

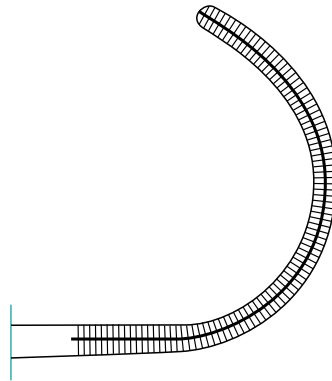

COOLEY

Multi-Purpose Clamp

200mm, 8"

290-480-200

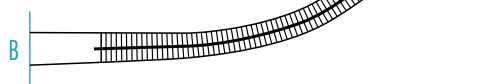
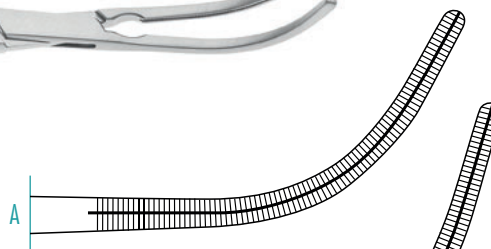
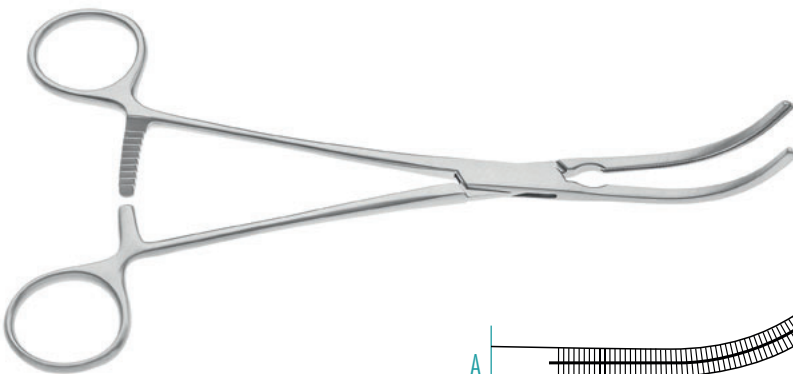

COOLEY

Multi-Purpose Clamp

A 215mm, 8¹/₂"

290-471-215

B 245mm, 9²/₃"

290-471-245

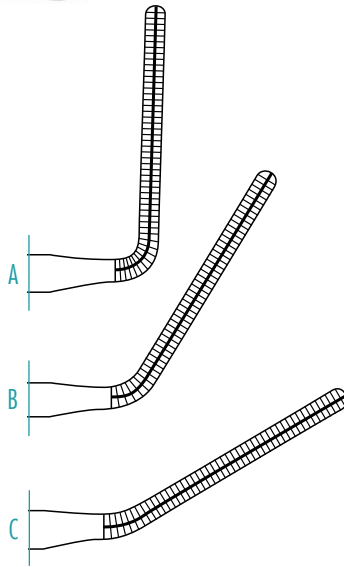

COOLEY

Multi Purpose Forceps

A	150mm, 6"	290-472-150
B	160mm, 6 ¹ / ₄ "	290-472-155
C	170mm, 6 ² / ₃ "	290-472-160

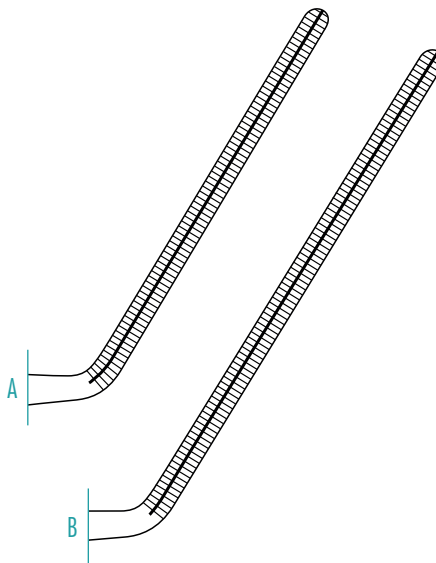

COOLEY

Multi-Purpose Clamp

A	205mm, 8 ¹ / ₈ "	290-509-200
B	240mm, 9 ¹ / ₂ "	290-509-240

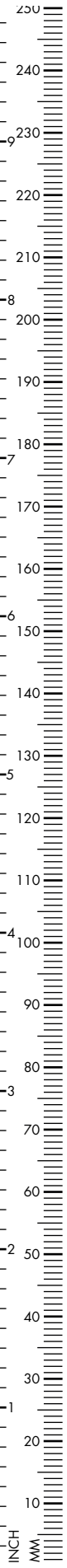



COOLEY PARRY
Anastomosis Clamp,
shanks angled backwards

A	180mm, 7"	290-481-001
B	235mm, 9 ¹ / ₄ "	290-481-002

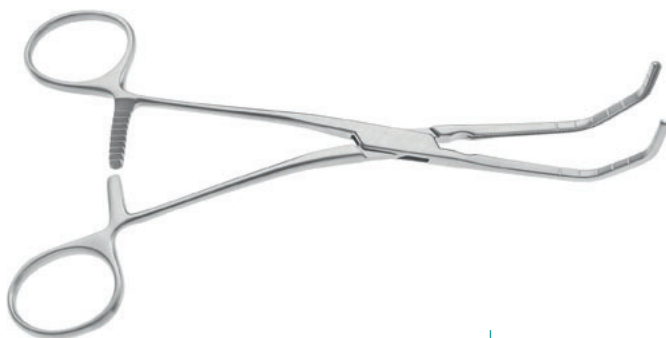
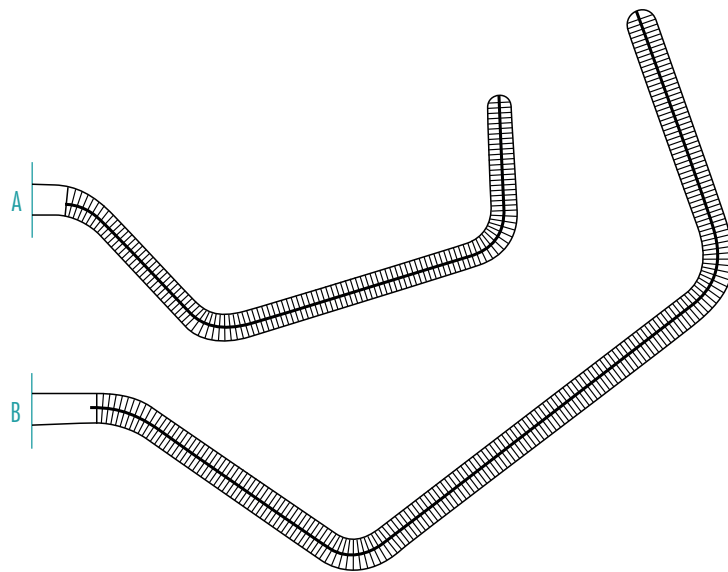

COOLEY
Anastomosis Clamp

A	175mm, 6 ⁷ / ₈ "	290-721-165
B	175mm, 6 ⁷ / ₈ "	290-722-165

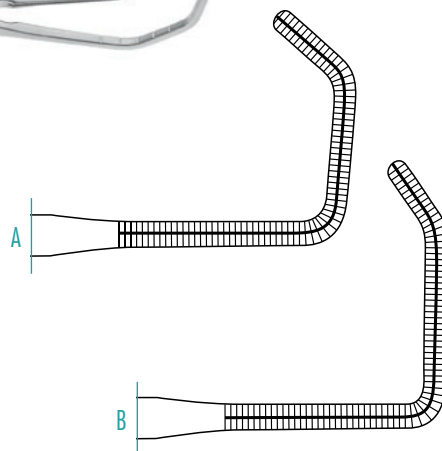

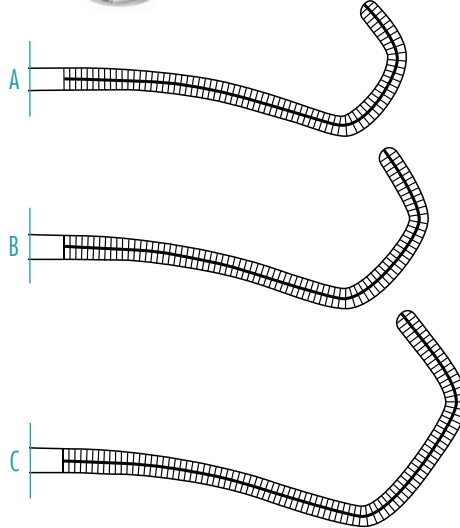
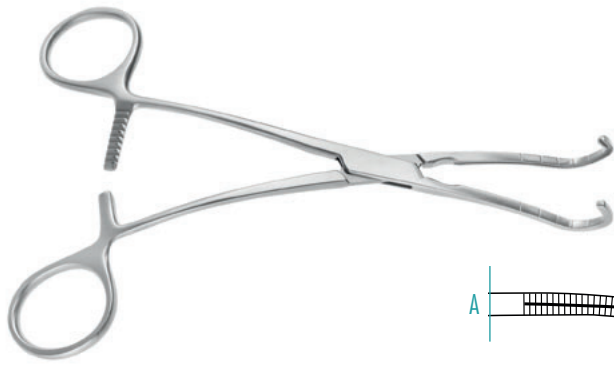

COOLEY DERRA

Anastomosis Clamp

A	160mm, 6 ¹ / ₄ "	290-478-160
B	170mm, 6 ² / ₃ "	290-478-170
C	180mm, 7"	290-478-180

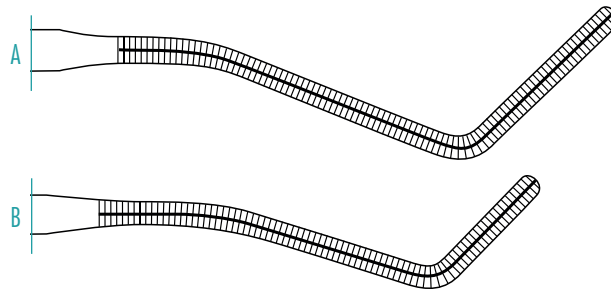
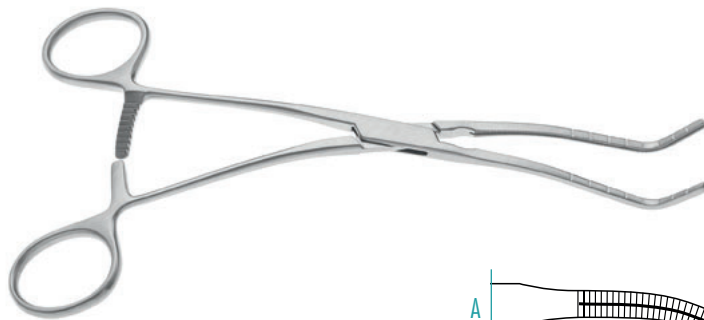

COOLEY

Clamp

A	195mm, 7 ³ / ₄ "	290-469-200
B	185mm, 7 ¹ / ₄ "	290-469-185

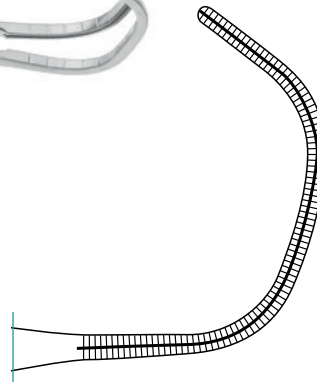

COOLEY LEITZ

Anastomosis Clamp

	195mm, 7 ³ / ₄ "	290-508-190
--	--	-------------

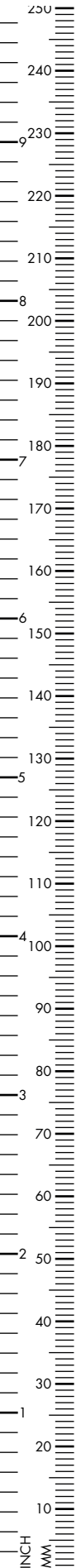

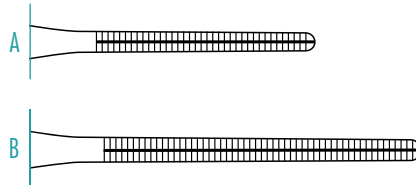

COOLEY

Forceps, shanks angled

A	160mm, 6 ¹ / ₄ "	290-473-160
B	170mm, 6 ² / ₃ "	290-473-170

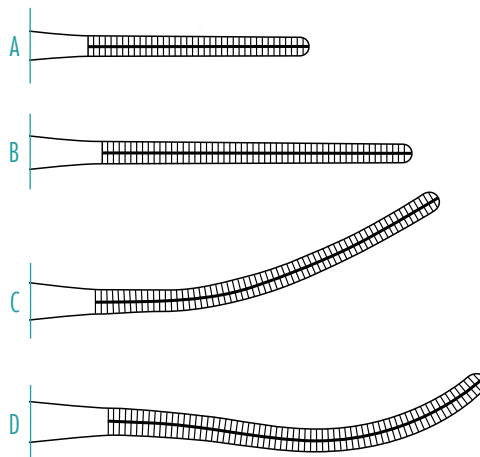
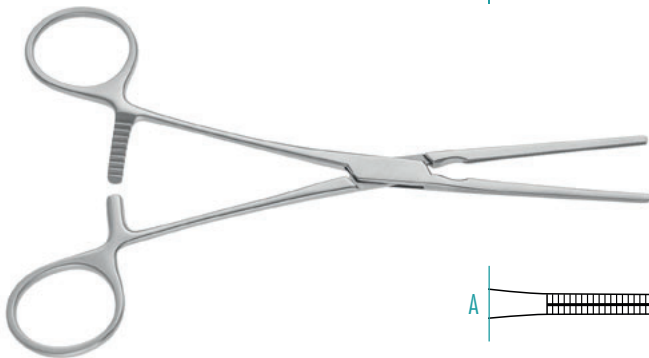

COOLEY

Forceps, straight

A	160mm, 6 ¹ / ₄ "	290-468-160
B	170mm, 6 ² / ₃ "	290-468-170
C	170mm, 6 ² / ₃ "	290-474-170
D	170mm, 6 ² / ₃ "	290-476-170

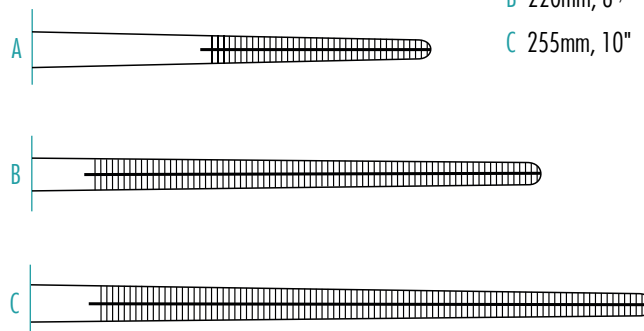
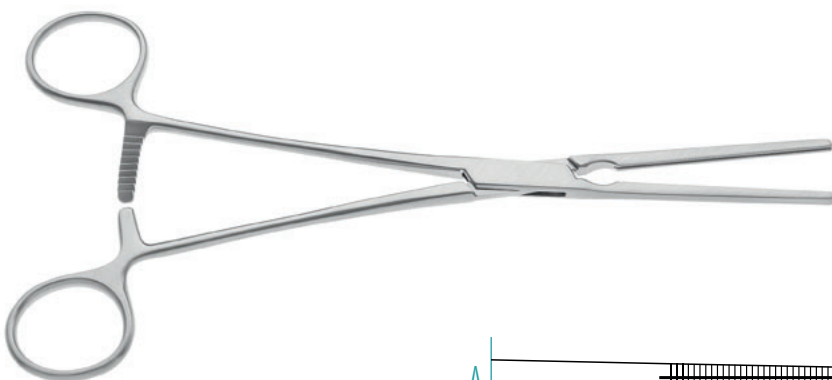

COOLEY

Clamp,
straight shanks

A	210mm, 8 ¹ / ₄ "	290-450-210
B	220mm, 8 ² / ₃ "	290-450-220
C	260mm, 10 ¹ / ₄ "	290-450-260

angled shanks

A	205mm, 8 ¹ / ₈ "	290-452-200
B	220mm, 8 ² / ₃ "	290-452-220
C	255mm, 10"	290-452-250

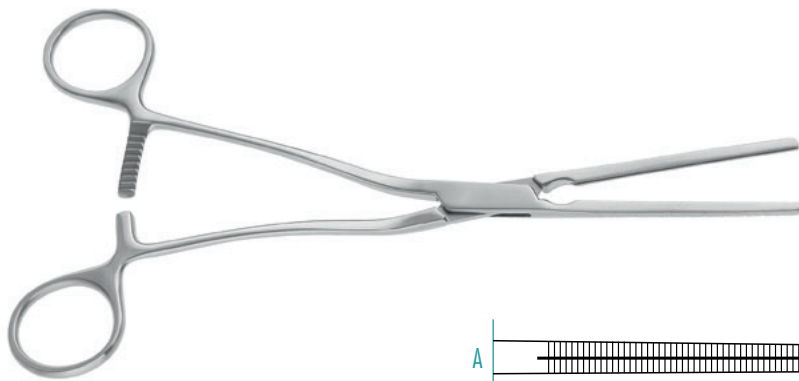

COOLEY

Iliac Clamp, straight,
shanks strongly angled

A 210mm, 8¹/₄" 290-467-210

B 250mm, 9⁷/₈" 290-467-255

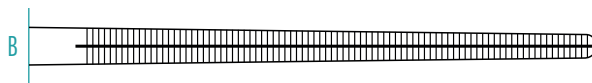
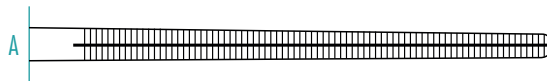

COOLEY

Clamp, wide curved,
shanks curved backwards

275mm, 10⁷/₈" 290-512-270

shanks curved backwards

240mm, 9¹/₂" 290-519-240

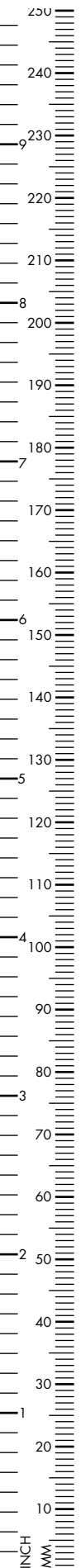
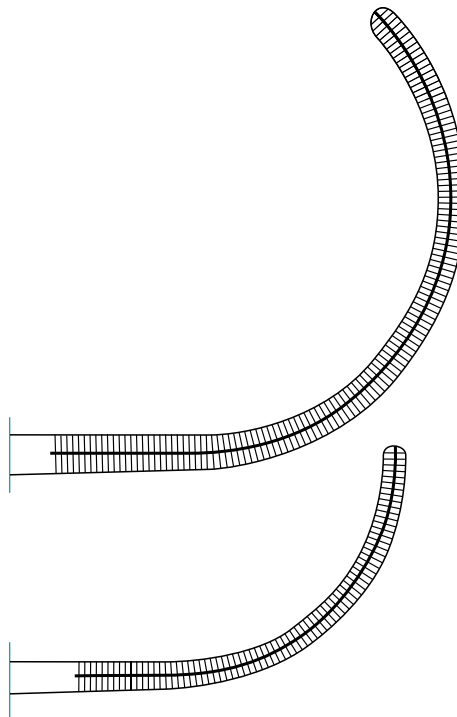



COOLEY

Clamp, 3x3teeth, shanks s-curved

310mm, 12¹/₄"

290-512-315

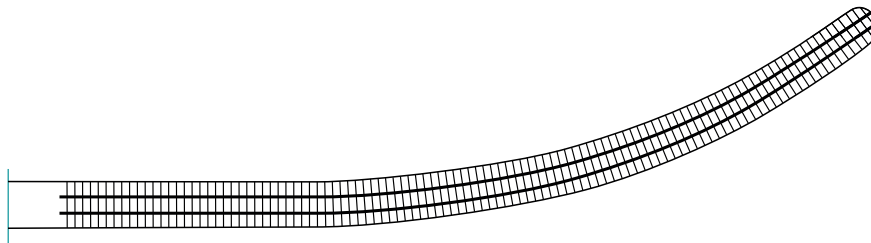

COOLEY

Clamp, curved, 3x3 teeth

A 335mm, 13"

290-515-330

2x2 teeth

B 265mm, 10¹/₂"

290-514-260

C 190mm, 7¹/₂"

290-514-190

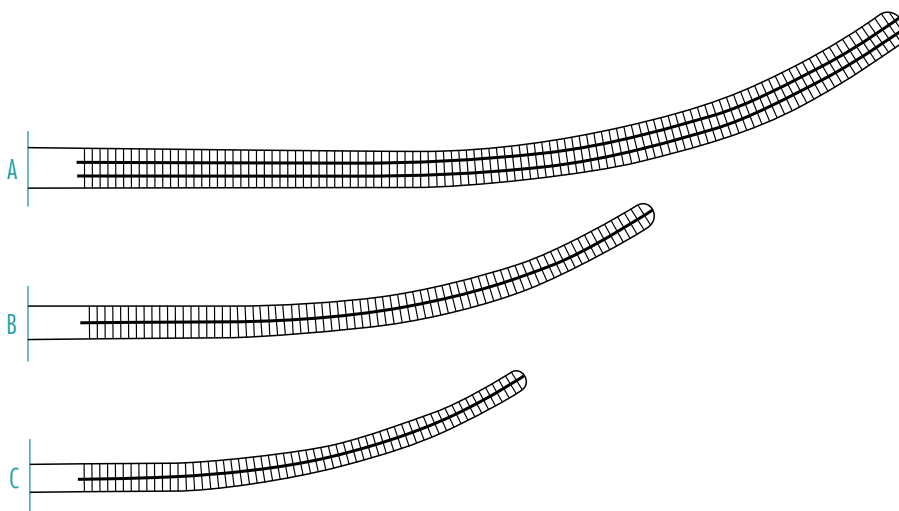



COOLEY
Clamp

225mm, 8 ⁷ / ₈ "	290-516-220
260mm, 10 ¹ / ₄ "	290-516-260
270mm, 10 ² / ₃ "	290-516-270

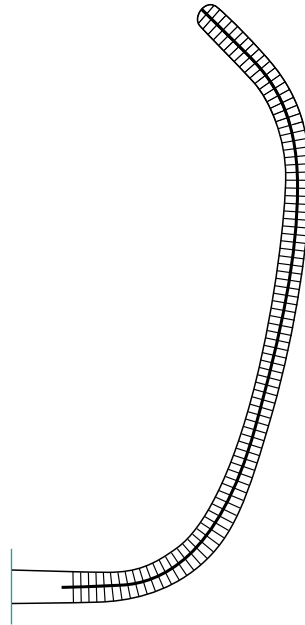

COOLEY

Clamp, shanks strongly curved backwards

A 200mm, 8"	290-517-200
B 210mm, 8 ¹ / ₄ "	290-517-210
C 255mm, 10"	290-517-250

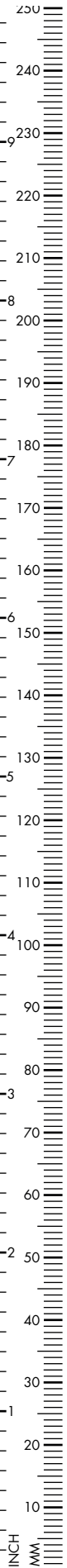
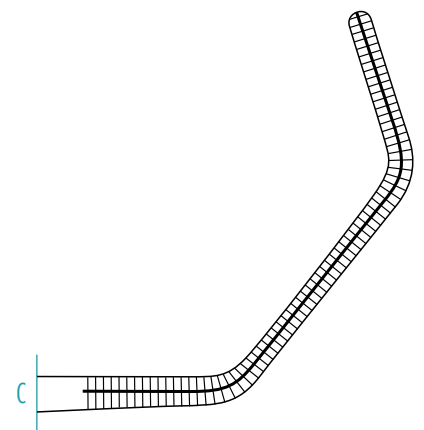
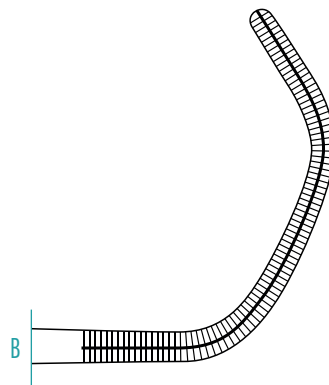
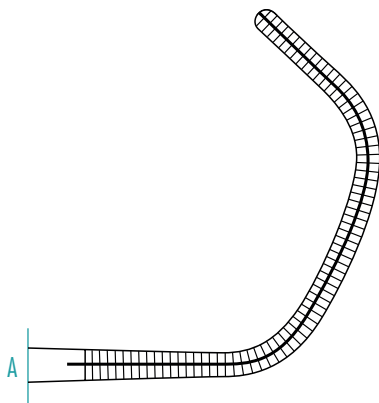

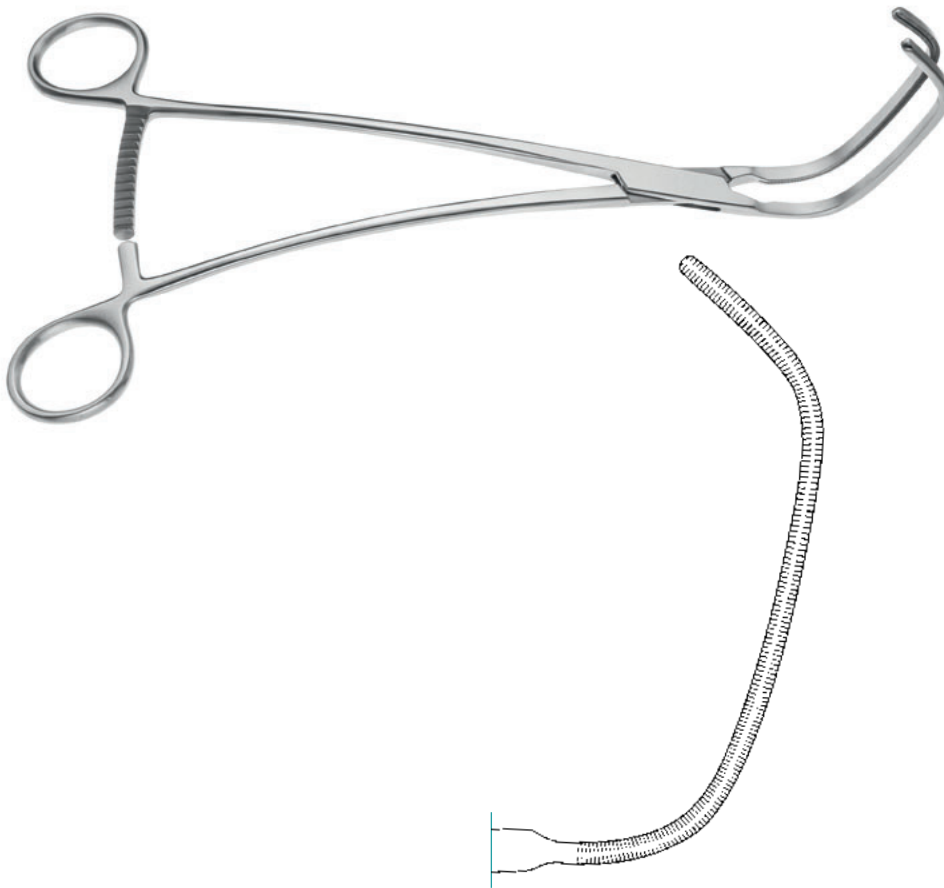

COOLEY

Clamp, double curved,
shanks curved backwards

270mm, 10²/₃"

290-518-270

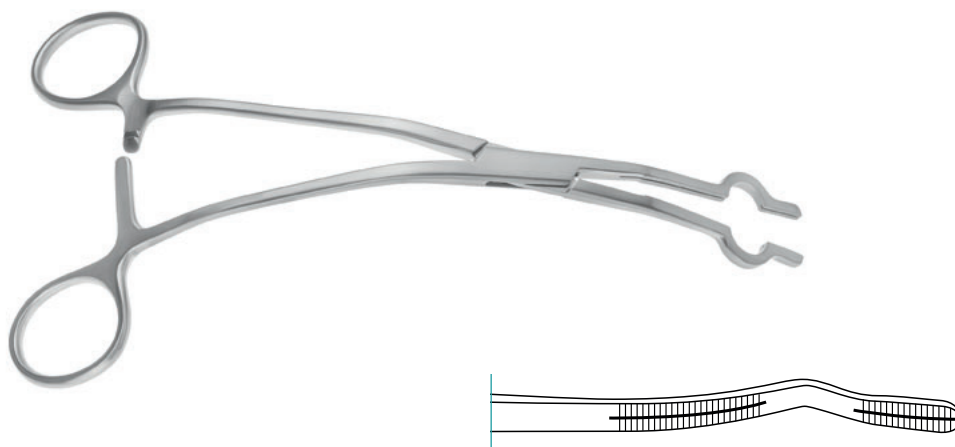

COOLEY

Clamp, 170mm, 6²/₃"

20 Charr. 290-350-010

24 Charr. 290-350-001

26 Charr. 290-350-002

28 Charr. 290-350-003

30 Charr. 290-350-004

32 Charr. 290-350-005

36 Charr. 290-350-007

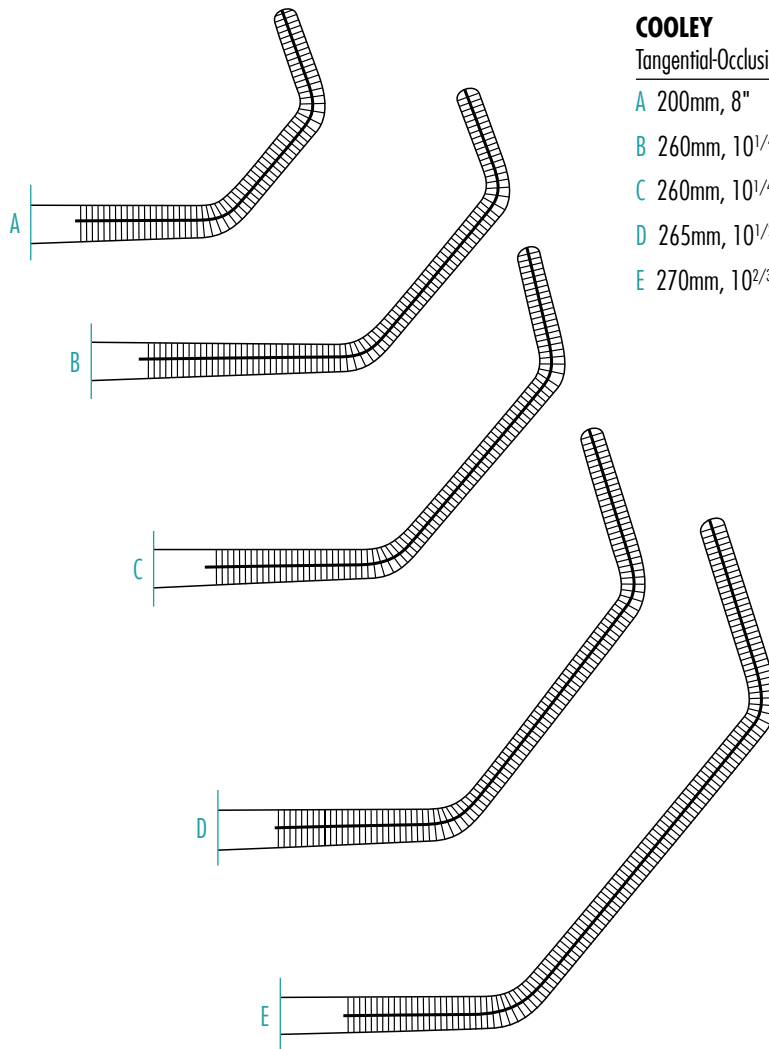
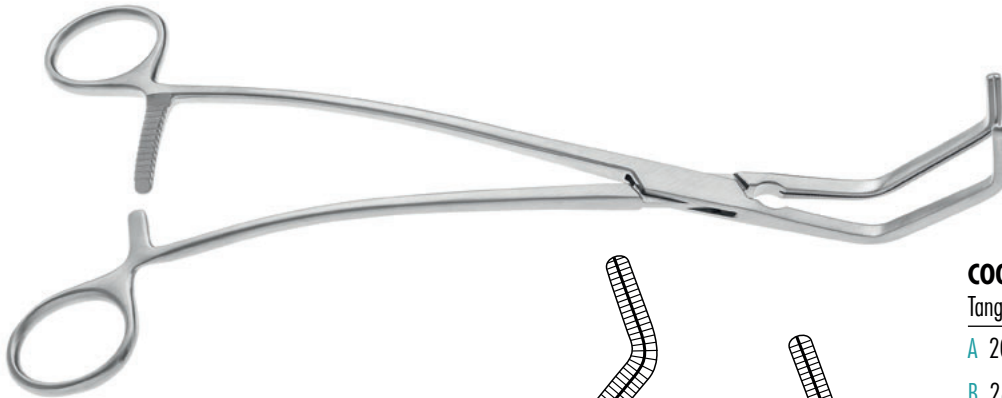

COOLEY

Tangential-Occlusion Clamp

A	200mm, 8"	290-521-200
B	260mm, 10 ^{1/4} "	290-521-250
C	260mm, 10 ^{1/4} "	290-521-260
D	265mm, 10 ^{1/2} "	290-521-265
E	270mm, 10 ^{2/3} "	290-521-270

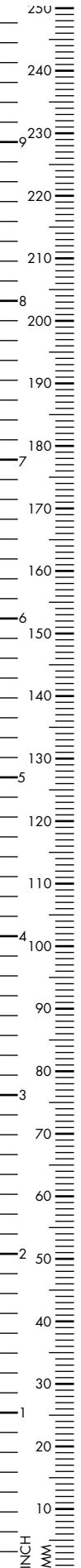

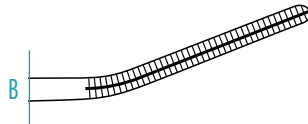

COOLEY

Pediatric Clamp, 140mm, 5¹/₂"

A	290-466-001
B	290-466-002
C	290-466-005

shanks angled

290-466-003

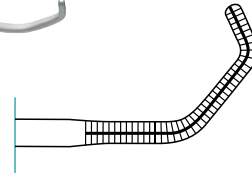
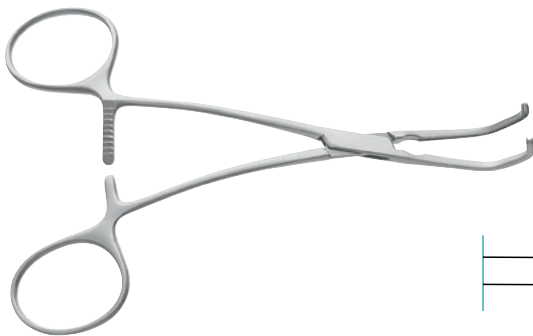

COOLEY

Pediatric Clamp
shanks curved backwards

140mm, 5 ¹ / ₂ "	290-466-004
--	-------------



COOLEY

Pediatric Clamp

A 165mm, 6 ¹ / ₂ "	290-468-001
B 175mm, 6 ⁷ / ₈ "	290-468-002
C 185mm, 7 ¹ / ₄ "	290-468-003

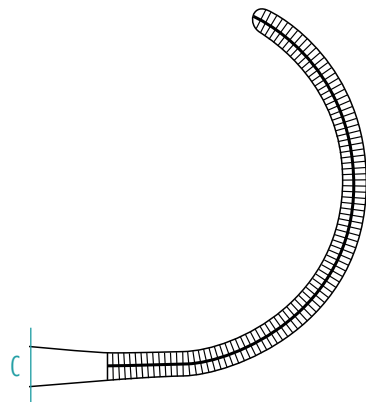
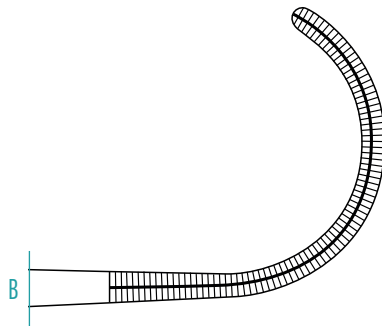
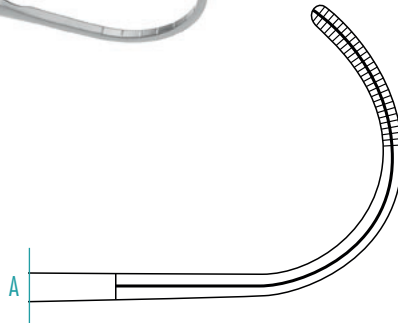

COOLEY

Forceps, shanks backwards

A	170mm, 6 ² / ₃ "	290-477-150
B	160mm, 6 ¹ / ₄ "	290-477-160
C	170mm, 6 ² / ₃ "	290-477-170

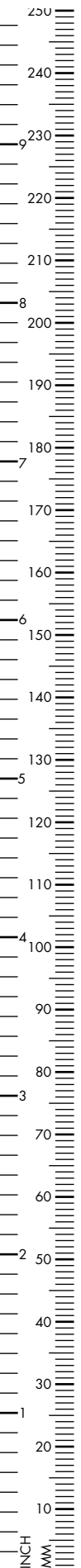



COOLEY

Clamp, shanks curved backwards

270mm, 10²/₃"

290-513-270

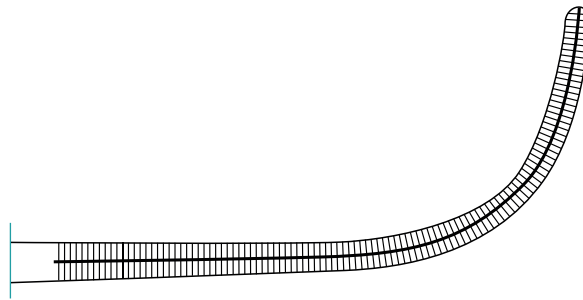

COOLEY

Clamp, shanks curved backwards

A 170mm, 6²/₃"

290-470-170

B 170mm, 6²/₃"

290-471-160

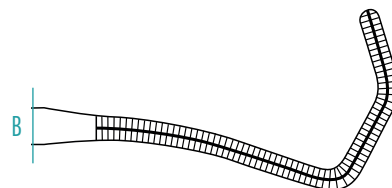

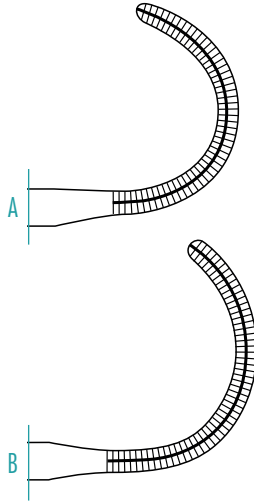

COOLEY BECK

Vessel Clamp, 150mm, 6"
narrow curved

A 290-478-150

wide curved

B 290-478-155

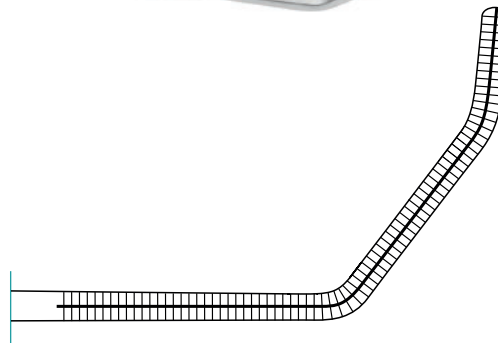

COOLEY

Clamp, s-angled, shanks curved backwards

250mm, 9⁷/₈" 290-513-240

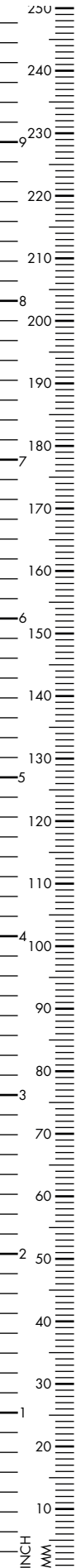



FOGARTY

Clamp

33mm, 170mm, 6 ² / ₃ "	290-487-170
---	-------------

61mm, 290mm, 11 ¹ / ₂ "	290-487-290
--	-------------

86mm, 300mm, 11 ⁷ / ₈ "	290-487-300
--	-------------



FOGARTY

Clamp, 60° curved

33mm, 160mm, 6 ¹ / ₄ "	290-488-160
---	-------------

61mm, 260mm, 10 ¹ / ₄ "	290-488-260
--	-------------



FOGARTY

Clamp, curved

33mm, 170mm, 6 ² / ₃ "	290-489-170
---	-------------

61mm, 260mm, 10 ¹ / ₄ "	290-489-260
--	-------------

86mm, 290mm, 11 ¹ / ₂ "	290-489-290
--	-------------

INSERTS FOR FOGARTY CLAMPS

1 pack = 2x10 pair



Hydrajaw inserts for delicate and fragile vessels, resterilizable

33mm	290-480-133
61mm	290-480-161
86mm	290-480-186

Softjaw inserts for damaged vessels, single use

33mm	290-480-233
61mm	290-480-261
86mm	290-480-286

Safejaw and hydrajaw insert, single use

33mm	290-480-333
61mm	290-480-361
86mm	290-480-386

Safejaw and softjaw inserts, single use

33mm	290-480-433
61mm	290-480-461
86mm	290-480-486

Hydrajaw and tractionjaw inserts, resterilizable

33mm	290-480-533
61mm	290-480-561
86mm	290-480-586

Two safejaw inserts, single use

33mm	290-480-633
61mm	290-480-661
86mm	290-480-686

Softjaw and tractionjaw inserts, single use

33mm	290-480-733
61mm	290-480-761
86mm	290-480-786

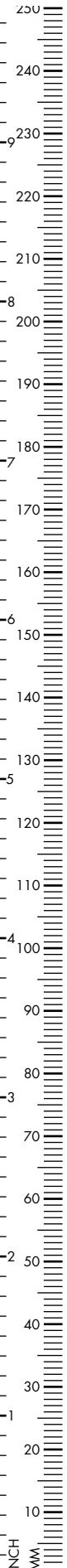

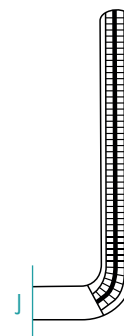
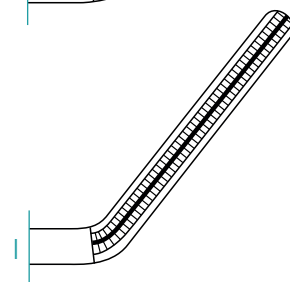
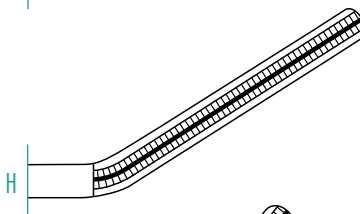
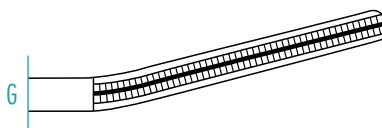
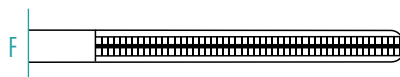
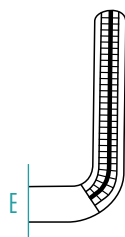
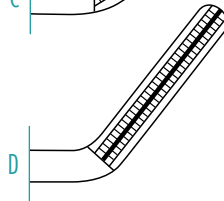
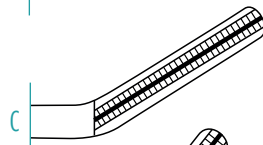
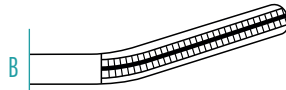
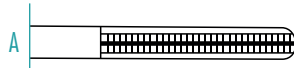

DARDIK

Multi-Purpose Clamp, 38mm

A	130mm, 5 ¹ / ₈ "	290-336-000
B	145mm, 5 ³ / ₄ "	290-336-015
C	150mm, 6"	290-336-030
D	150mm, 6"	290-336-045
E	150mm, 6"	290-336-090

58mm

F	135mm, 5 ¹ / ₃ "	290-338-000
G	160mm, 6 ¹ / ₄ "	290-338-015
H	170mm, 6 ² / ₃ "	290-338-030
I	170mm, 6 ² / ₃ "	290-338-045
J	170mm, 6 ² / ₃ "	290-338-090

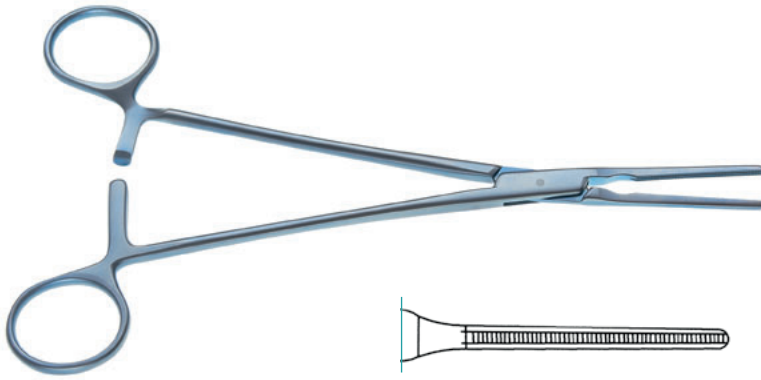

GLOVER

Clamp,
straight shanks

200mm, 8" 290-700-200

angled shanks

200mm, 8" 290-701-200



straight shanks

200mm, 8" 290-700-201

angled shanks

200mm, 8" 290-701-201



straight shanks

210mm, 8^{1/4}" 290-700-210

angled shanks

210mm, 8^{1/4}" 290-701-210



straight shanks

220mm, 8^{2/3}" 290-700-220

angled shanks

220mm, 8^{2/3}" 290-701-220

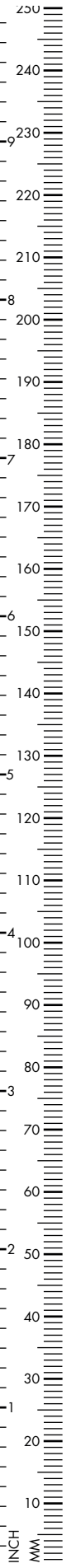

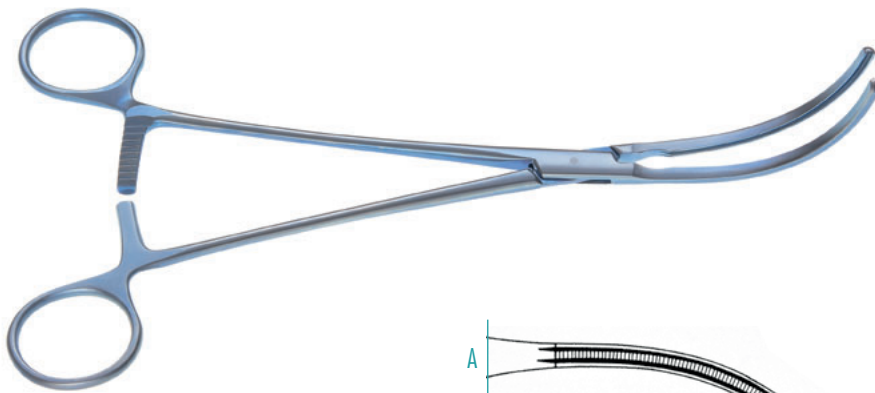

GLOVER

Clamp

A	210mm, 8 ¹ / ₄ "	290-719-210
B	240mm, 9 ¹ / ₂ "	290-719-240
C	150mm, 6"	290-719-150
D	210mm, 8 ¹ / ₄ "	290-721-210
E	240mm, 9 ¹ / ₂ "	290-721-240

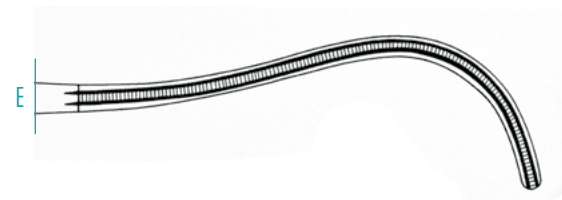
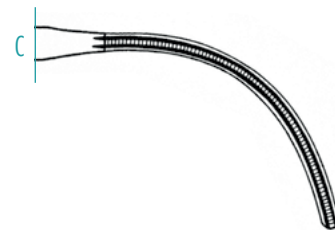
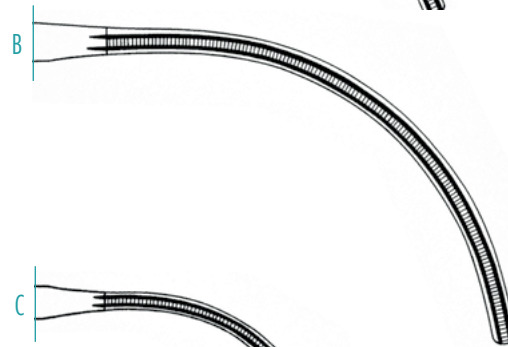
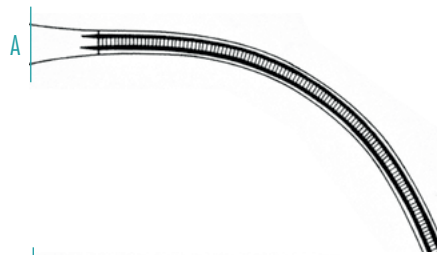

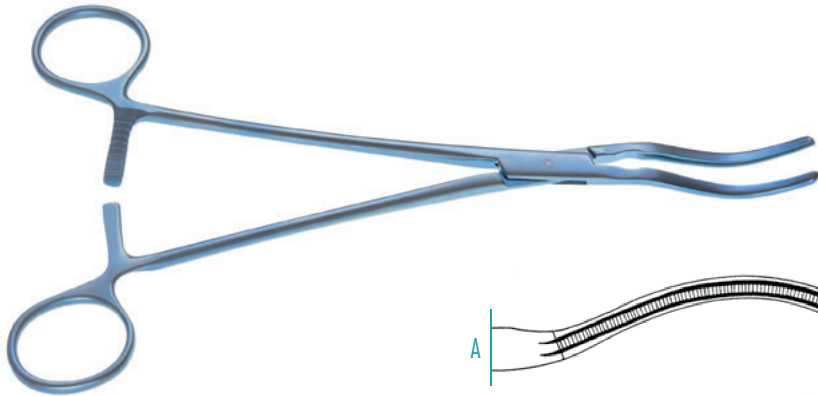

GLOVER

Clamp, spoon shaped

A 215mm, 8¹/₂" 290-703-210

B 260mm, 10¹/₄" 290-703-260

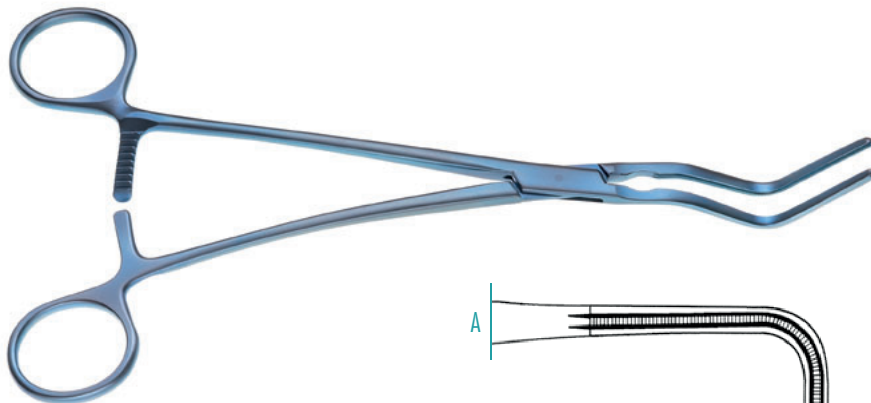

LEES

Bronchus Clamp, 220mm, 8²/₃"

A 290-707-220

B 290-707-230

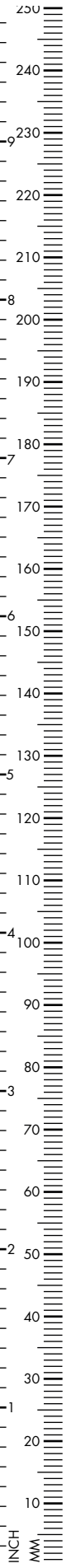
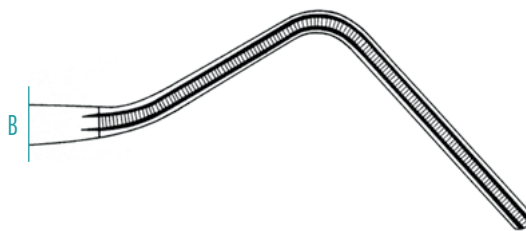
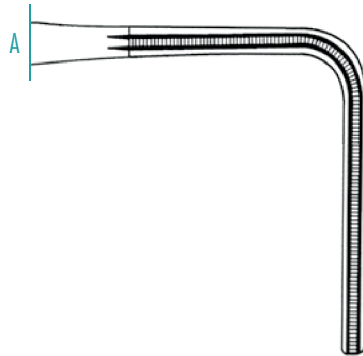

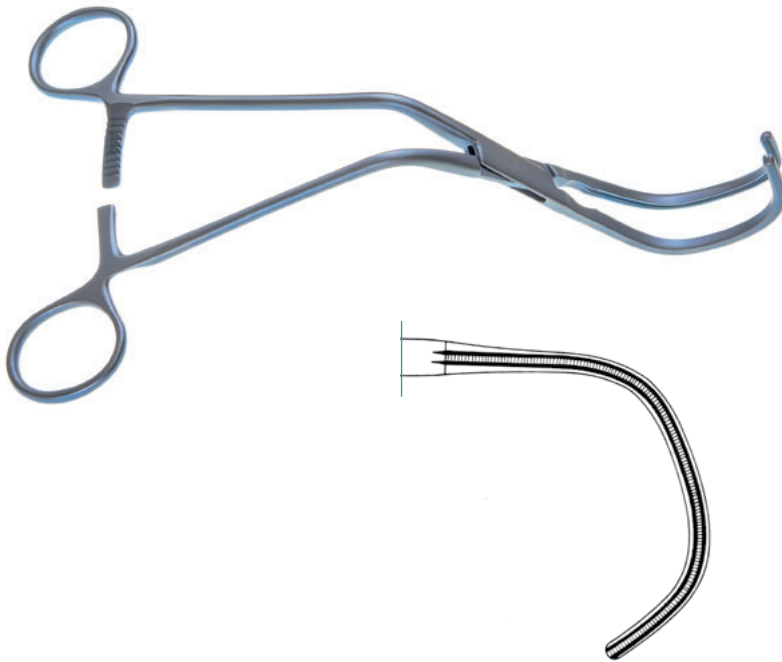

LAMBERT-KAY

Clamp

200mm, 8"

290-730-210

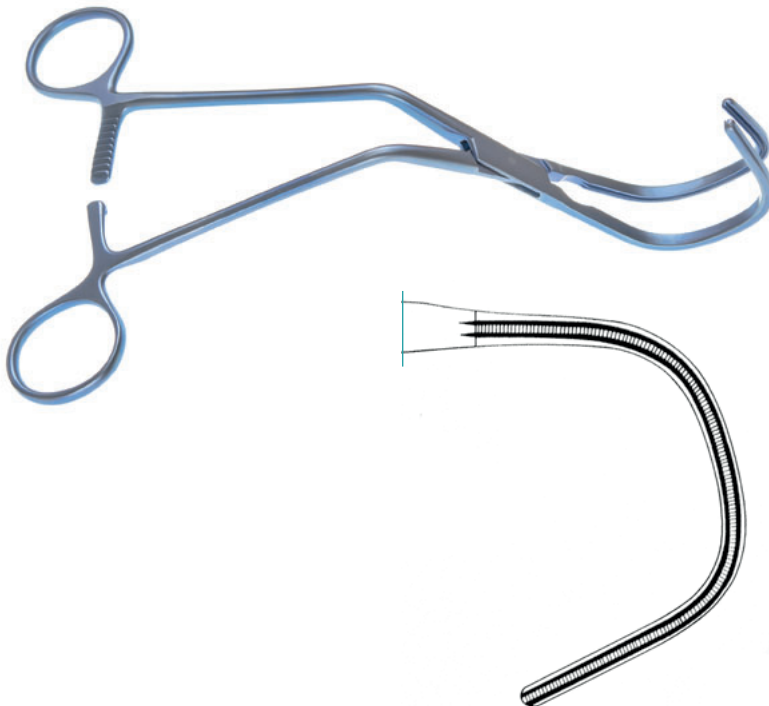

KAY

Clamp

200mm, 8"

290-711-200

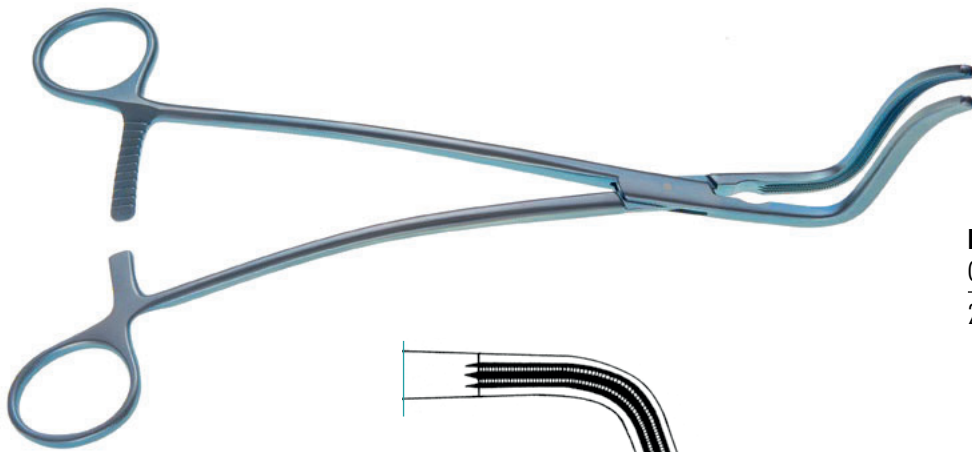

DEBAKEY
Clamp

265mm, 10¹/₂" 290-713-260

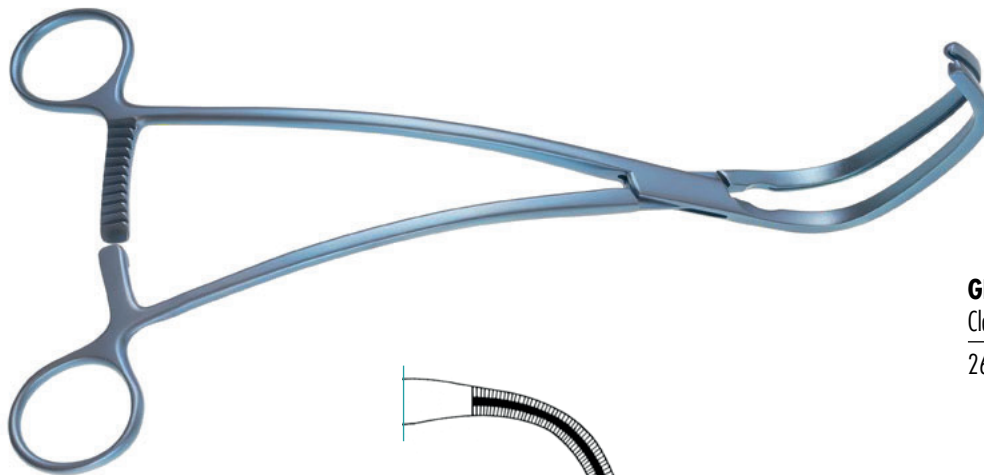
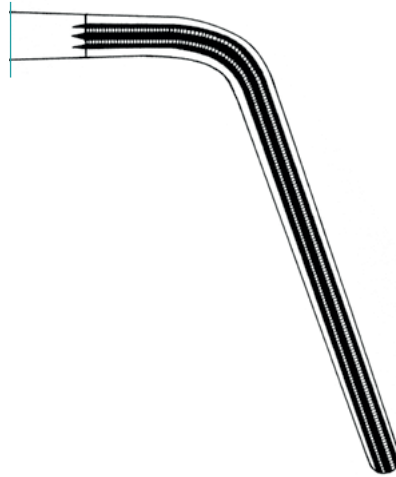

GLOVER
Clamp

265mm, 10¹/₂" 290-715-260

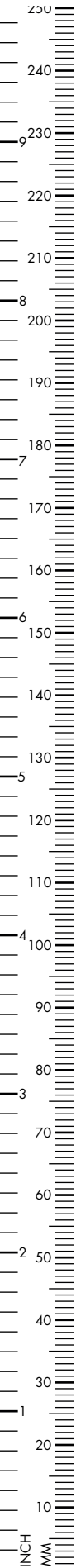

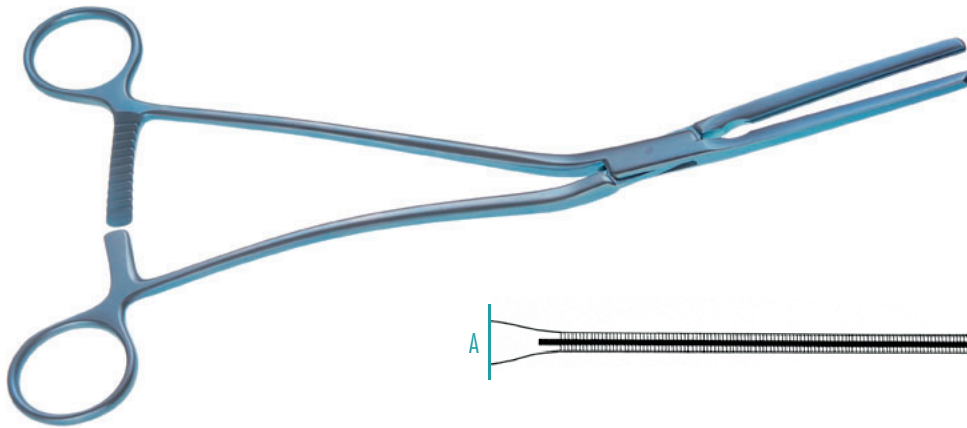

COOLEY
Clamp

A	215mm, 8 ¹ / ₂ "	290-717-210
B	260mm, 10 ¹ / ₄ "	290-717-260

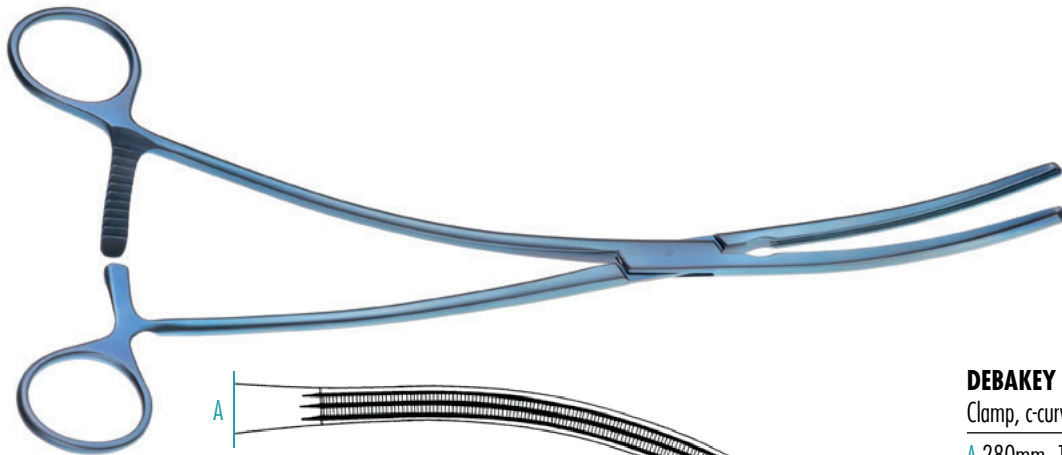

DEBAKEY
Clamp, c-curved

A	280mm, 11"	290-723-280
B	300mm, 11 ⁷ / ₈ "	290-723-300
C	320mm, 12 ⁵ / ₈ "	290-723-320
D	340mm, 13 ¹ / ₃ "	290-723-340

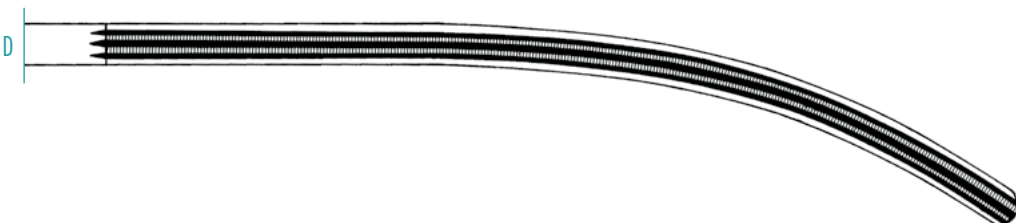
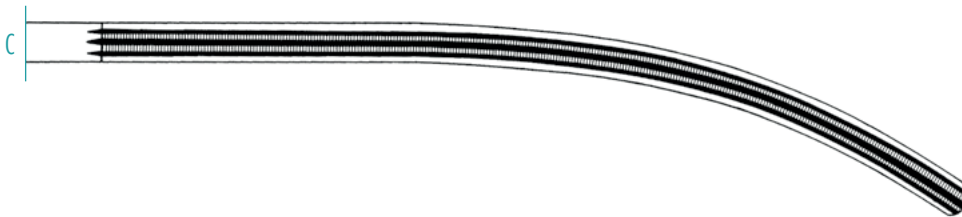
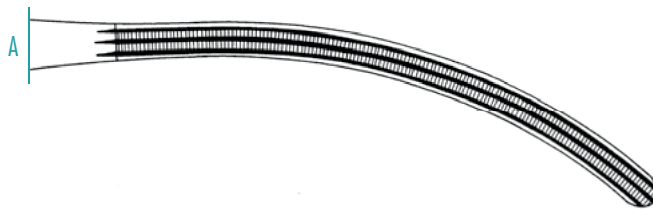

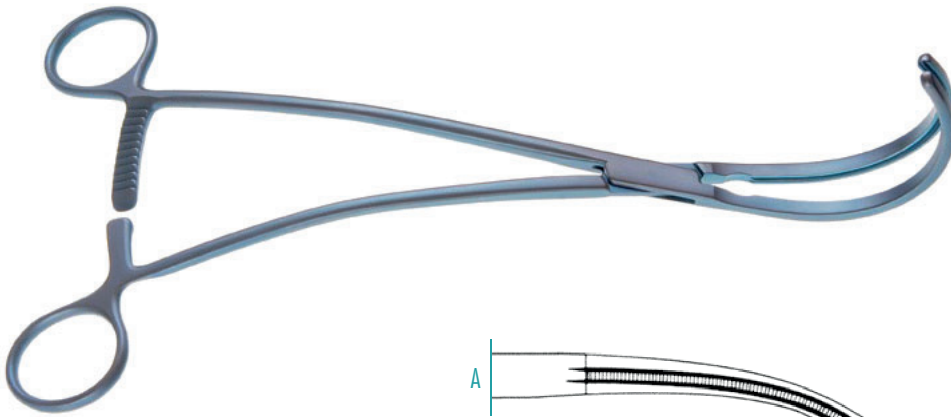

DEBAKEY
Clamp

A	265mm, 10 ¹ / ₂ "	290-727-270
B	260mm, 10 ¹ / ₄ "	290-727-260
C	180mm, 7"	290-729-180

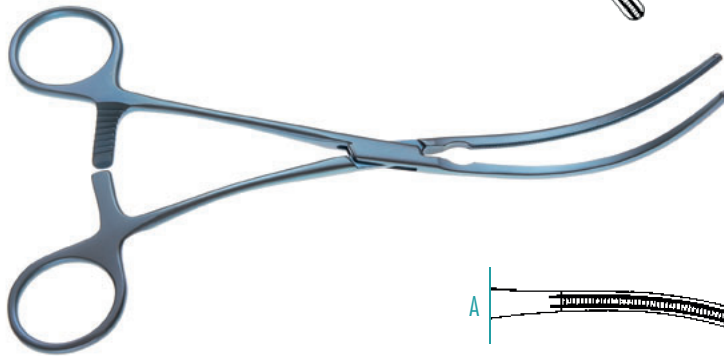
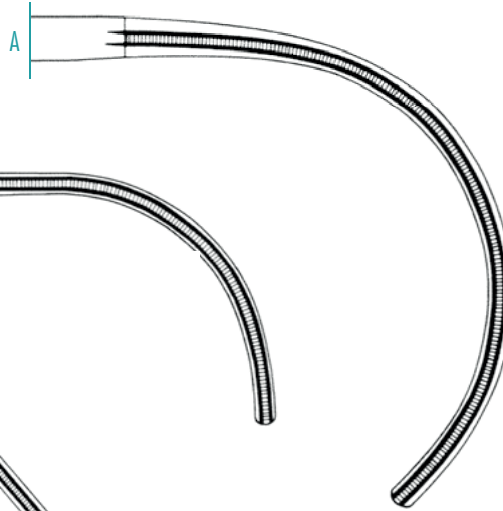

DEBAKEY
Clamp

A	200mm, 8"	290-727-200
B	185mm, 7 ¹ / ₄ "	290-727-180

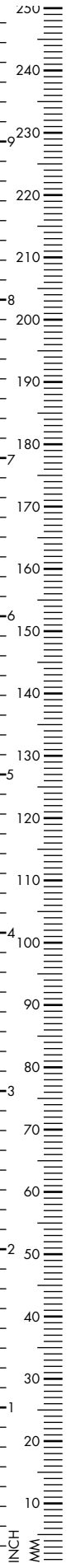
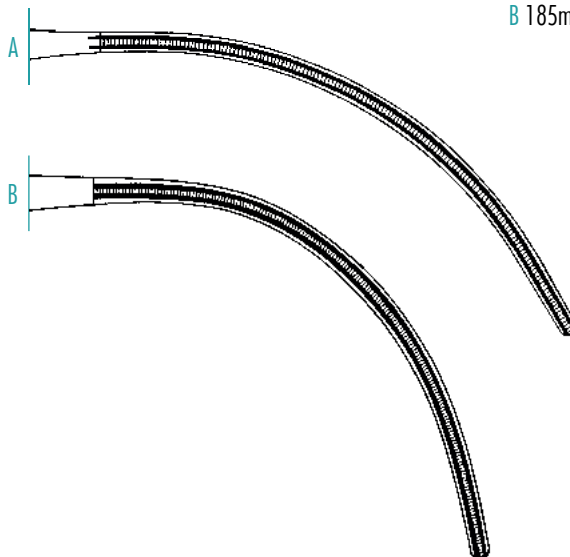

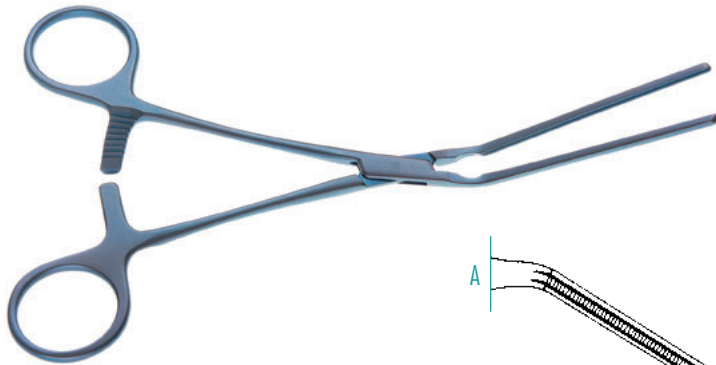

LELAND JONES

Vascular Clamp

A	190mm, 7 ¹ / ₂ "	290-731-190
B	200mm, 8"	290-731-200
C	205mm, 8 ¹ / ₈ "	290-731-210

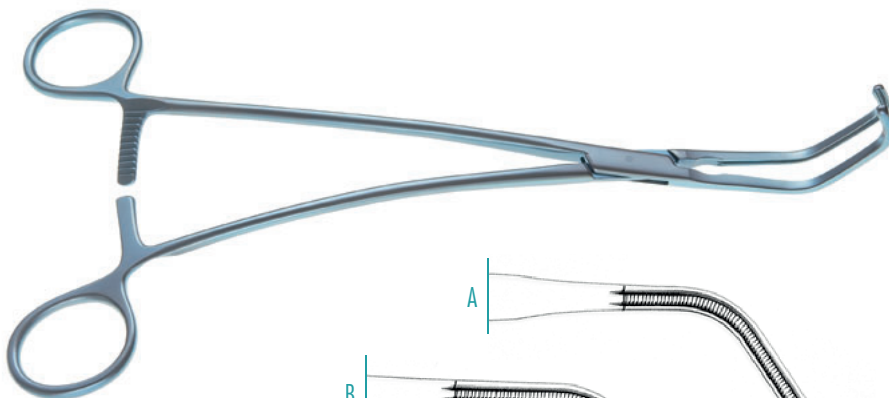
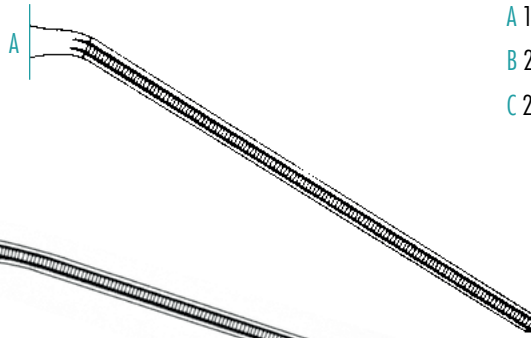

SATINSKY

Clamp, 250mm, 9⁷/₈"

A		290-735-001
B		290-735-002
C		290-735-003

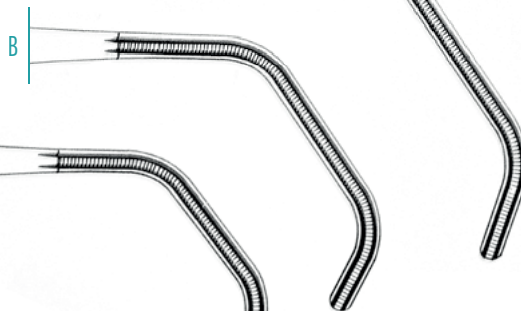
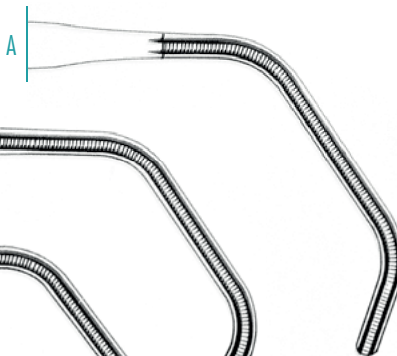

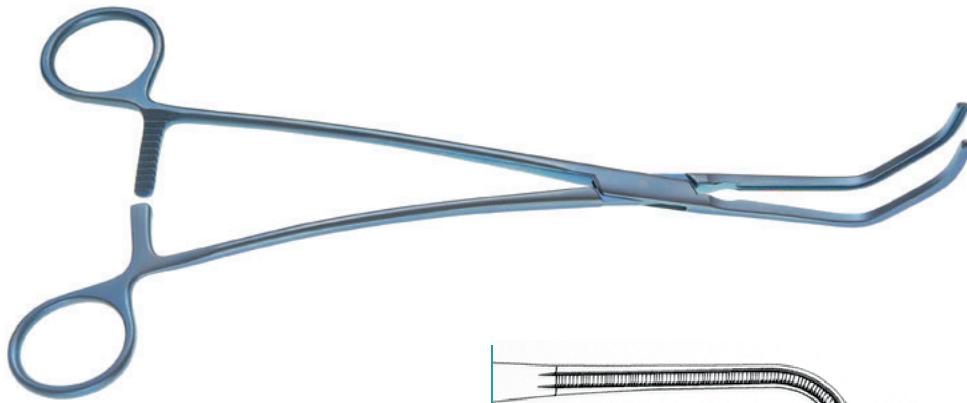

GLOVER
Tangential Clamp

250mm, 9⁷/₈" 290-735-250

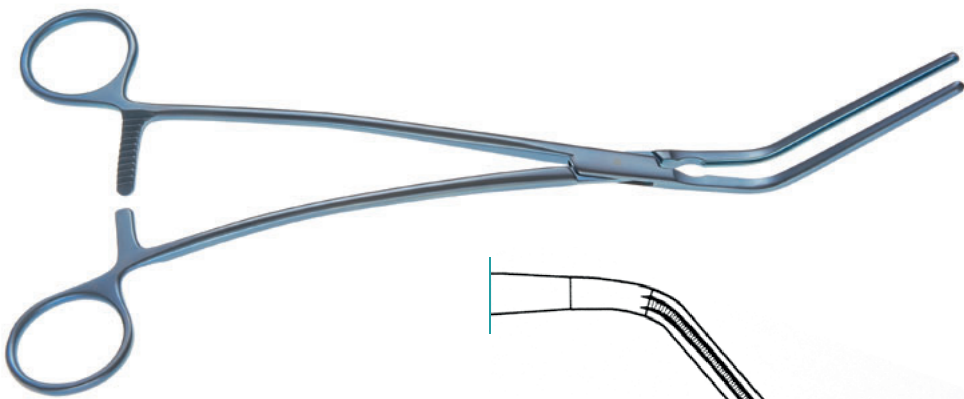
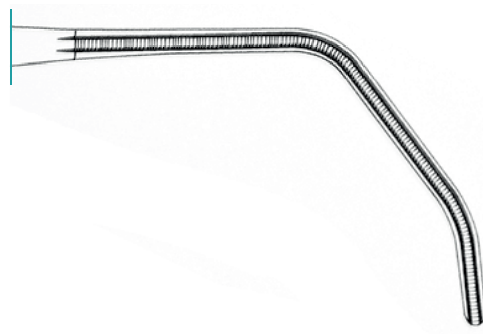

DEBAKEY
Clamp

250mm, 9⁷/₈" 290-737-260

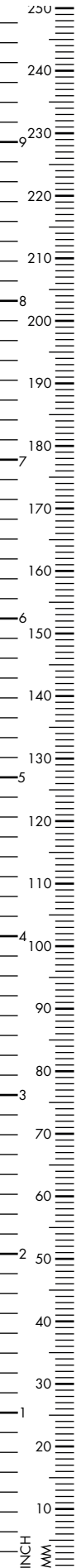
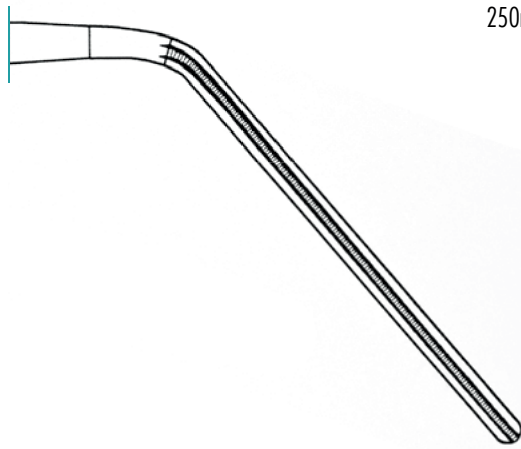

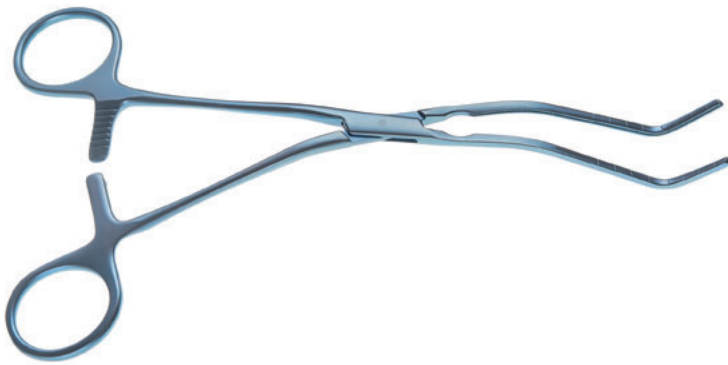

COOLEY

Renal Artery Clamp

A	190mm, 7 ¹ / ₂ "	290-739-190
B	200mm, 8"	290-739-200
C	270mm, 10 ² / ₃ "	290-739-270

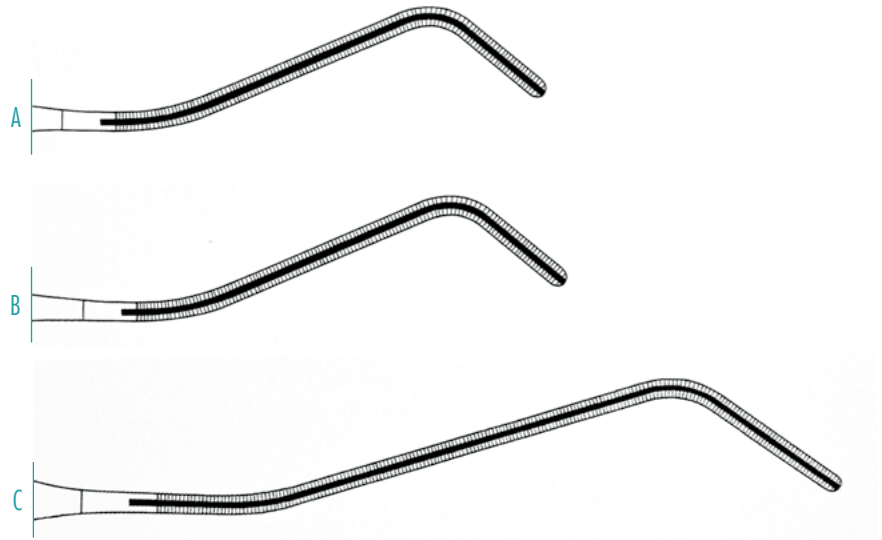

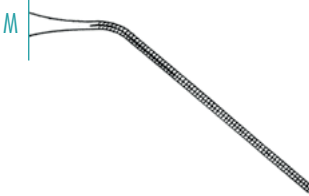
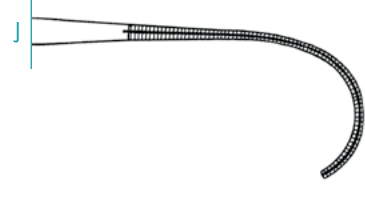
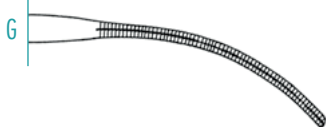
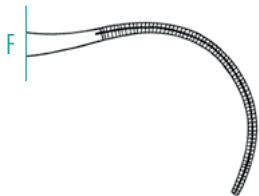
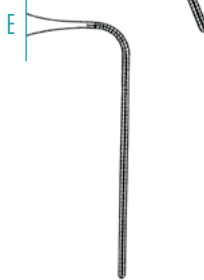
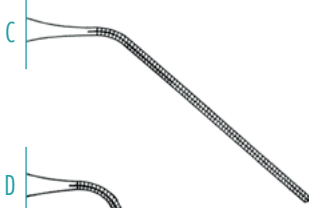
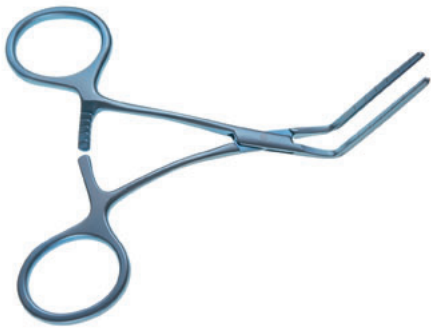

CASTANEDA
Pediatric Clamp

A	130mm, 5 ¹ / ₈ "	290-732-130
B	130mm, 5 ¹ / ₈ "	290-734-130
C	130mm, 5 ¹ / ₈ "	290-735-130
D	120mm, 4 ³ / ₄ "	290-734-120
E	110mm, 4 ¹ / ₃ "	290-732-110
F	120mm, 4 ³ / ₄ "	290-793-120
G	130mm, 5 ¹ / ₈ "	290-794-130
H	150mm, 6"	290-796-150
I	150mm, 6"	290-795-150
J	150mm, 6"	290-797-150
K	160mm, 6 ¹ / ₄ "	290-798-160
L	160mm, 6 ¹ / ₄ "	290-799-160
M	150mm, 6"	290-798-150
N	150mm, 6"	290-799-150
O	140mm, 5 ¹ / ₂ "	290-798-140

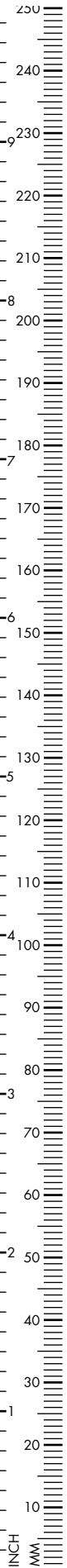

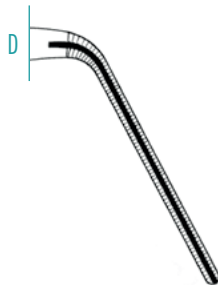
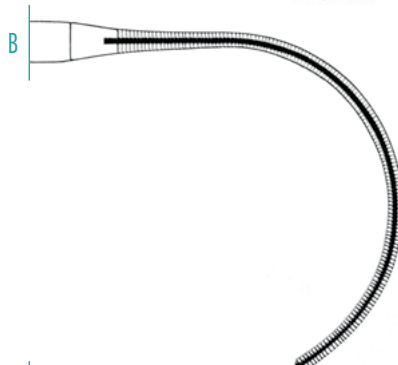
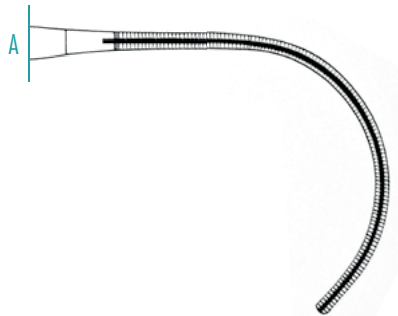
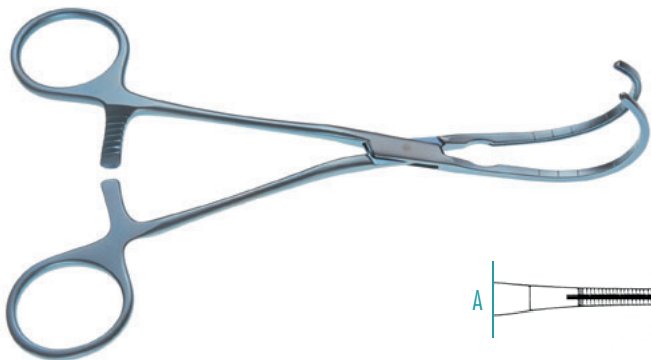

COOLEY

Pediatric Clamp

A	165mm, 6 ¹ / ₂ "	290-760-165
B	170mm, 6 ² / ₃ "	290-760-170
C	170mm, 6 ² / ₃ "	290-761-170
D	165mm, 6 ¹ / ₂ "	290-761-165
E	150mm, 6"	290-761-150

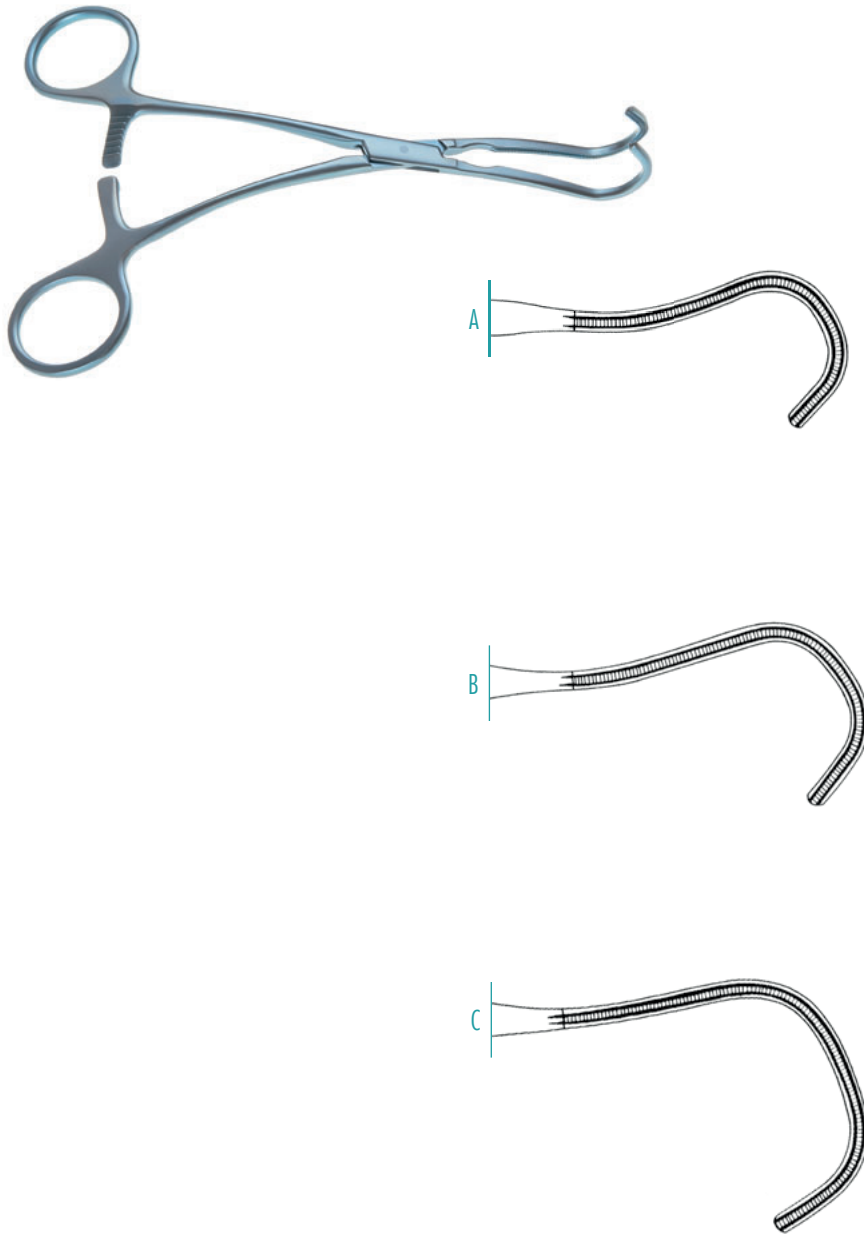

DERRA

Anastomosis Pediatric Clamp

A	165mm, 6 ^{1/2} "	290-758-165
B	170mm, 6 ^{2/3} "	290-758-170
C	180mm, 7"	290-759-180

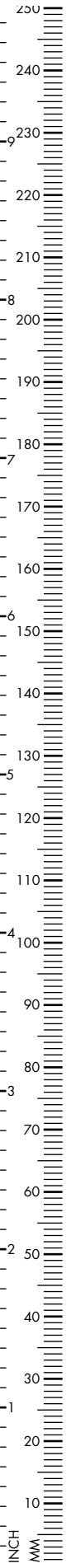

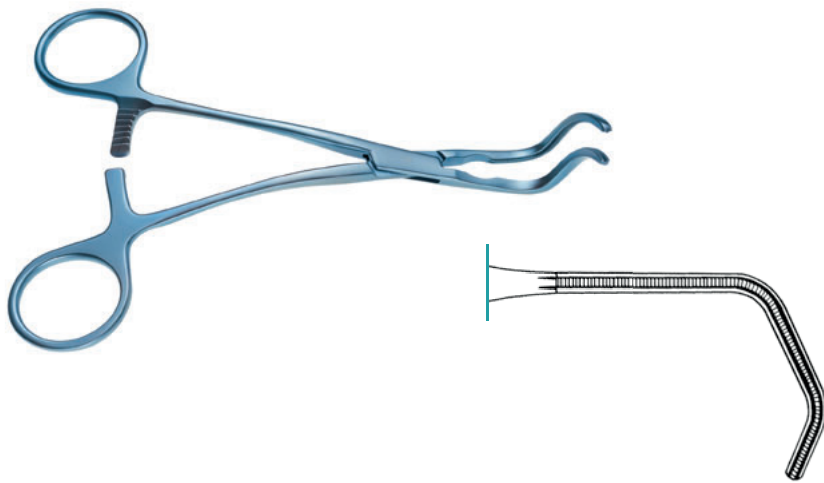

SUBRAMANIAN
Clamp

160mm, 6 ¹ / ₄ "	290-733-160
--	-------------

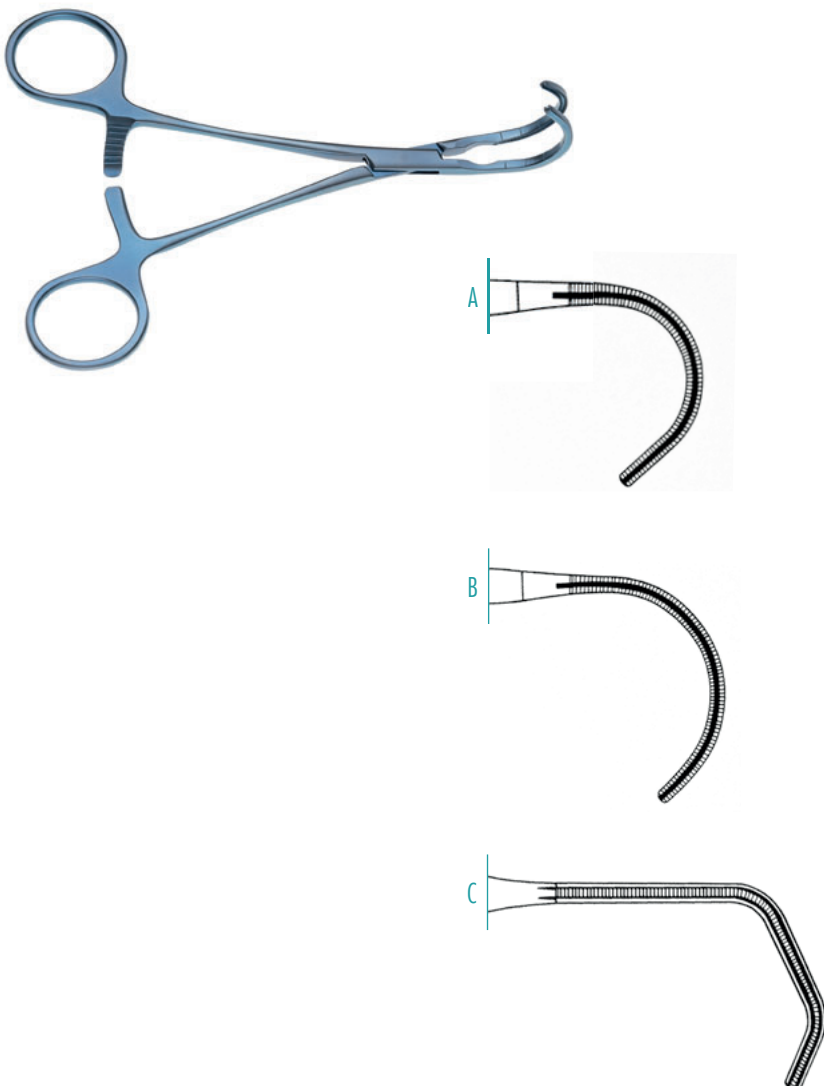

BECK

Pediatric Clamp, 150mm, 6"

A small jaw	290-734-150
B large jaw	290-735-150
C 165mm, 6 ¹ / ₂ "	290-732-165



COOLEY

Pediatric Clamp

A	170mm, 6 ² / ₃ "	290-762-170
B	180mm, 7"	290-762-180
C	170mm, 6 ² / ₃ "	290-763-170
D	175mm, 6 ⁷ / ₈ "	290-763-175

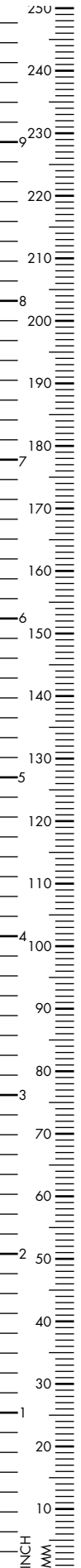
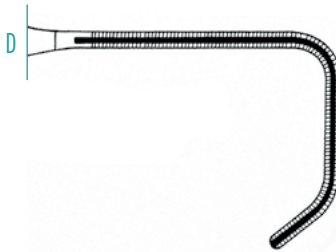
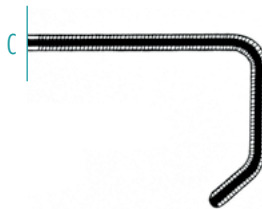
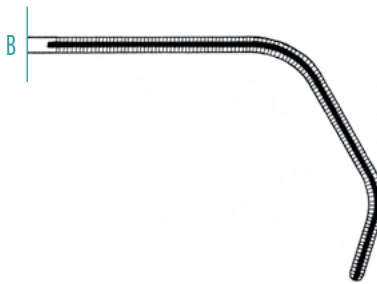
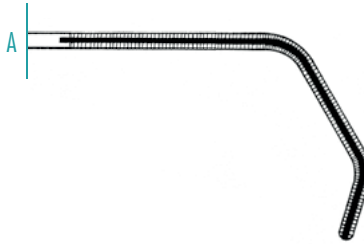
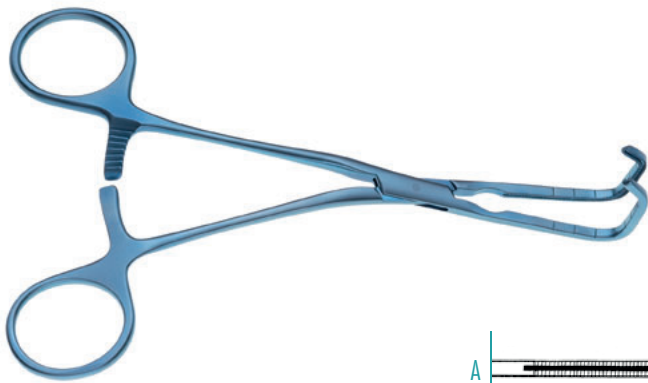

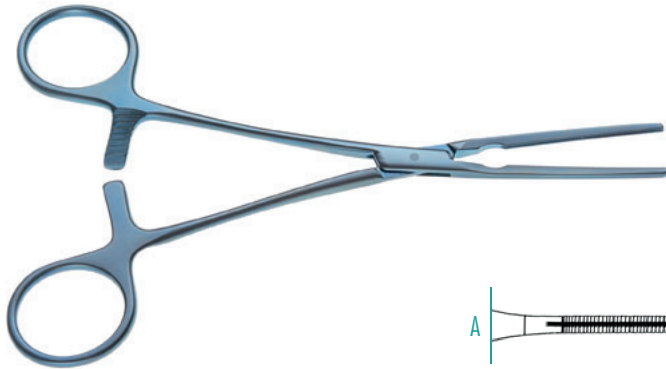

COOLEY

Pediatric Clamp, straight shanks

A 160mm, 6¹/₄" 290-764-160

angled shanks

A 160mm, 6¹/₄" 290-765-160

straight shanks

B 170mm, 6²/₃" 290-764-170

straight shanks

B 170mm, 6²/₃" 290-765-170

straight shanks, curved jaw

C 170mm, 6²/₃" 290-766-170

straight shanks, spoon-shaped jaw

D 170mm, 6²/₃" 290-767-170

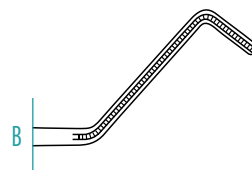
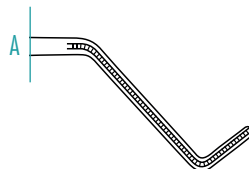

KITZMILLER

Pediatric Clamp, 110mm, 4¹/₃"

A left angled 290-723-110

B right angled 290-725-110



DEBAKEY FOERSTER

Clamp, DeBakey serrations,
with gold rings, straight

320mm, 12^{5/8}"

290-000-320



DEBAKEY FOERSTER

Clamp, DeBakey serrations,
with gold rings, curved

320mm, 12^{5/8}"

290-000-321

**KÖNIG**

Ring forceps for thoracic surgery

310mm, 12¹/₄"

290-000-315

**KÖNIG**

Clamp with DeBakey serration

310mm, 12¹/₄"

290-000-310

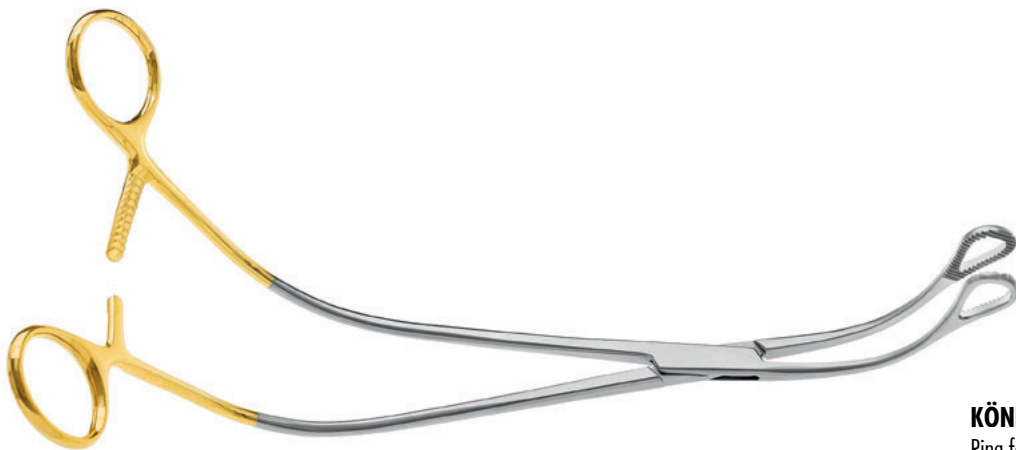

KÖNIG

Ring forceps for thoracic surgery

255mm, 10"

290-000-255



KÖNIG

T-Clamp with DeBaKey serration

305mm, 12"

290-000-305

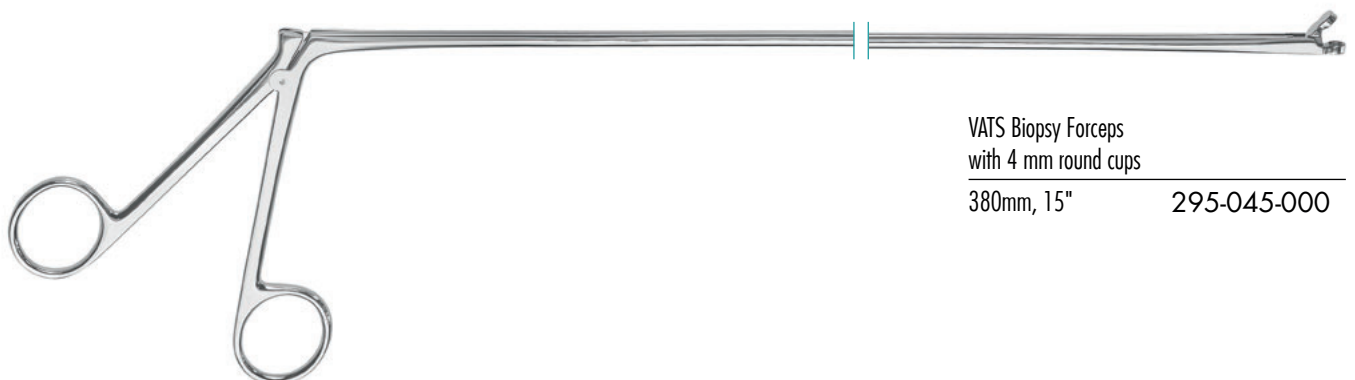

VATS Biopsy Forceps
with 4 mm round cups

380mm, 15"

295-045-000

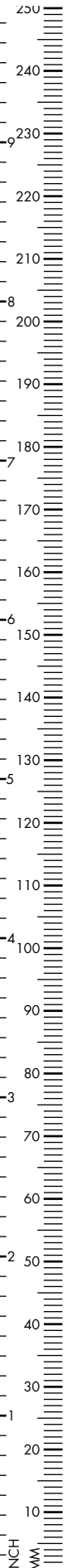



Chest Tube Passer, Ø 10mm shaft,
160mm working length, without ratchet

250mm, 9 ⁷ / ₈ "	295-080-150
280mm, 11"	295-080-280

155mm working length, with ratchet

240mm, 9 ¹ / ₂ "	295-080-170
--	-------------

280mm working length, with ratchet

355mm, 14"	295-080-281
------------	-------------



FOERSTER

left curved, oval shape,

Ø 7mm shaft, 230mm working length

335mm, 13 ¹ / ₄ "	295-150-012
---	-------------

Ø 10mm shaft, 240mm working length

340mm, 13 ¹ / ₃ "	295-150-020
---	-------------



DUVAL

left curved, triangular shape, 10mm jaw width

Ø 10mm shaft, 230mm working length

330mm, 13"	295-310-001
------------	-------------

25mm jaw width

235mm working length

330mm, 13"	295-310-002
------------	-------------



Dissecting Forceps, left curved,

Ø 7mm shaft, 230mm working length

340mm, 13 ¹ / ₃ "	295-100-230
---	-------------

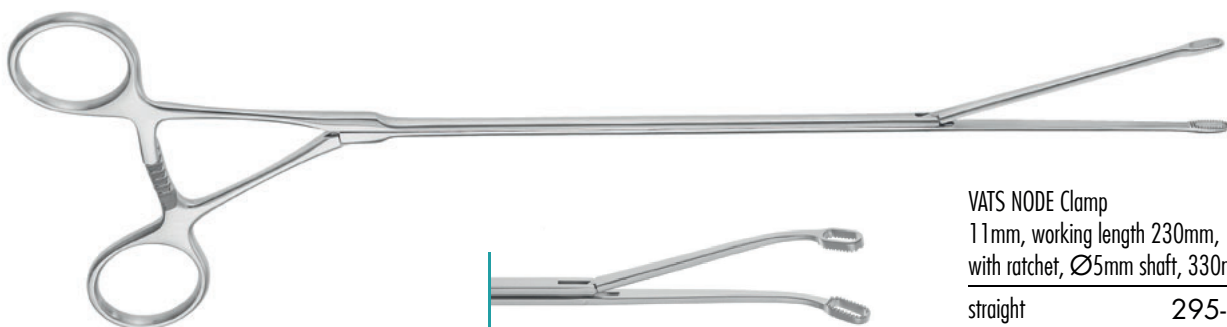

VATS NODE Clamp

11mm, working length 230mm,

with ratchet, Ø5mm shaft, 330mm, 13"

straight	295-150-222
----------	-------------

left curved	295-150-223
-------------	-------------



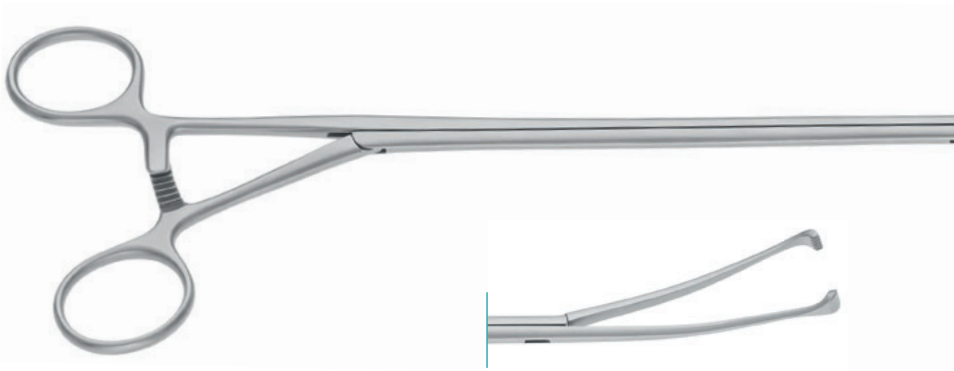

ALLIS

left curved, 6mm jaw width
 Ø 7mm shaft, 240mm working length

330mm, 13" 295-310-100



DEBAKEY

1x2 teeth, Ø 10mm shaft,
 65mm jaw length, 230mm working length

330mm, 13" 295-290-065

75mm jaw length, 250mm working length

340mm, 13¹/₃" 295-290-075

100mm jaw length, 255mm working length

360mm, 14¹/₄" 295-290-100



2x3 teeth,
 100mm jaw length, 250mm working length

350mm, 14" 295-290-101

COOLEY

1x2 teeth, Ø 10mm shaft,
 240mm working length, 345mm, 13¹/₂"

with ratchet 295-290-300

without ratchet 295-290-301



HARKEN

1x2 teeth, Ø 10mm shaft, without ratchet,
 250mm working length, Fig. 1

355mm, 14" 295-290-001

270mm working length, without ratchet, Fig. 2

370mm, 14¹/₂" 295-290-002

1x2 teeth, Ø 10mm shaft, with ratchet
 250mm working length, Fig. 1

355mm, 14" 295-290-010

270mm working length, with ratchet, Fig. 2

370mm, 14¹/₂" 295-290-012

Fig.1



Fig.2



D'AMICO

Ø 10mm shaft, 110mm jaw length
 270mm working length, 370mm, 14¹/₂"

straight 295-290-200

curved 295-290-201

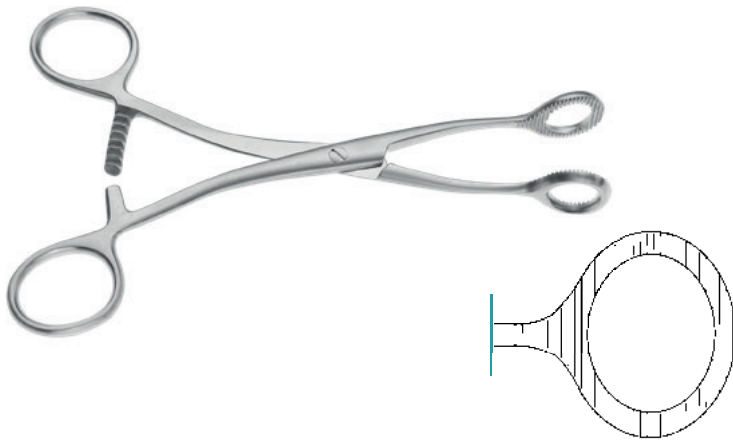

COLLIN

Hemostatic Forceps

160mm, 6¹/₄"

140-236-160

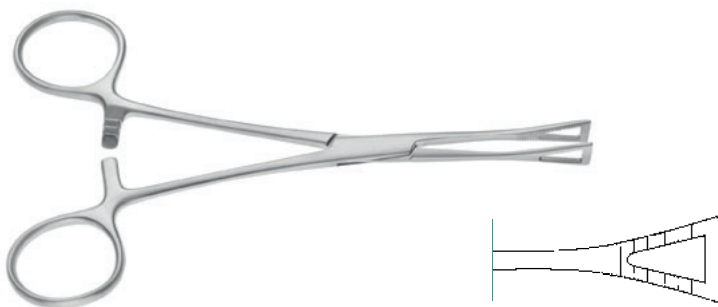

PENNINGTON

Tissue Holding Forceps

155mm, 6¹/₈"

140-240-155

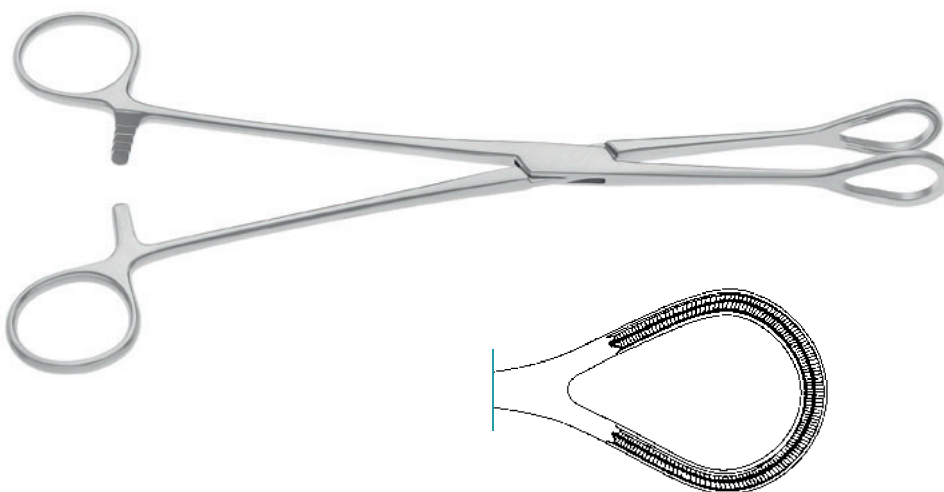

DEBAKEY

Intestinal and Organ Grasping Forceps,
atraumatic serrations, small ring

260mm, 10¹/₄"

140-220-260

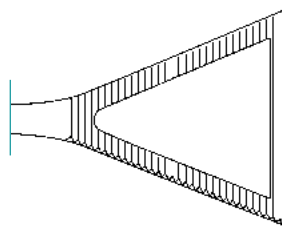
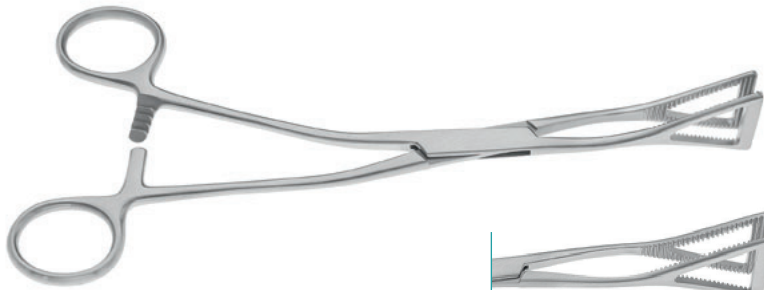

LOVELACE

Lung Grasping Forceps, 200mm, 8"

straight 290-286-200

curved 290-287-200

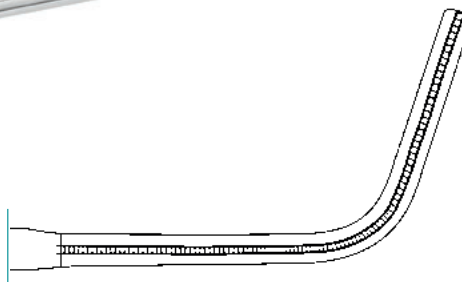

DEBAKEY MIXTER

Thoracic Forceps, strong serration

280mm, 11" 290-600-230

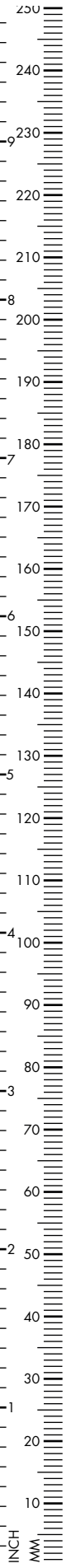

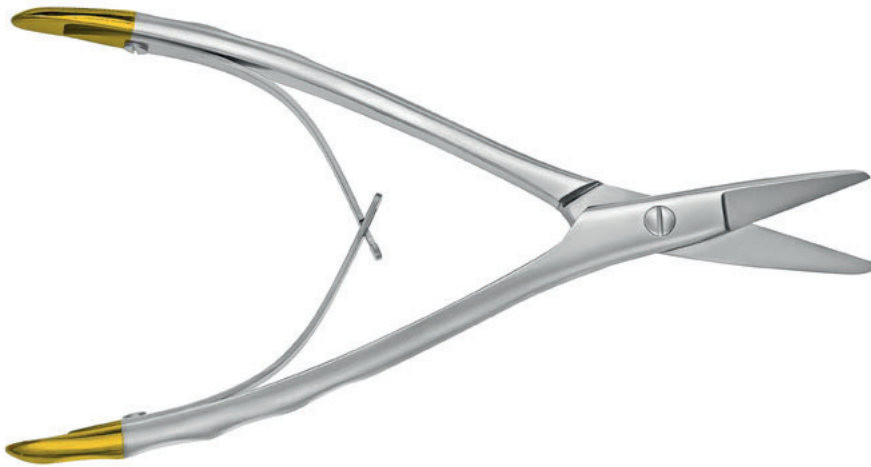

Rib Shears	
230mm, 9"	290-100-230



Rib Shears	
220mm, 8 ² / ₃ "	290-101-220



GLUCK Bone / Rib Shears	
220mm, 8 ² / ₃ "	290-107-220



BETHUNE

Rib Shears

345mm, 13⁵/₈"

290-126-340

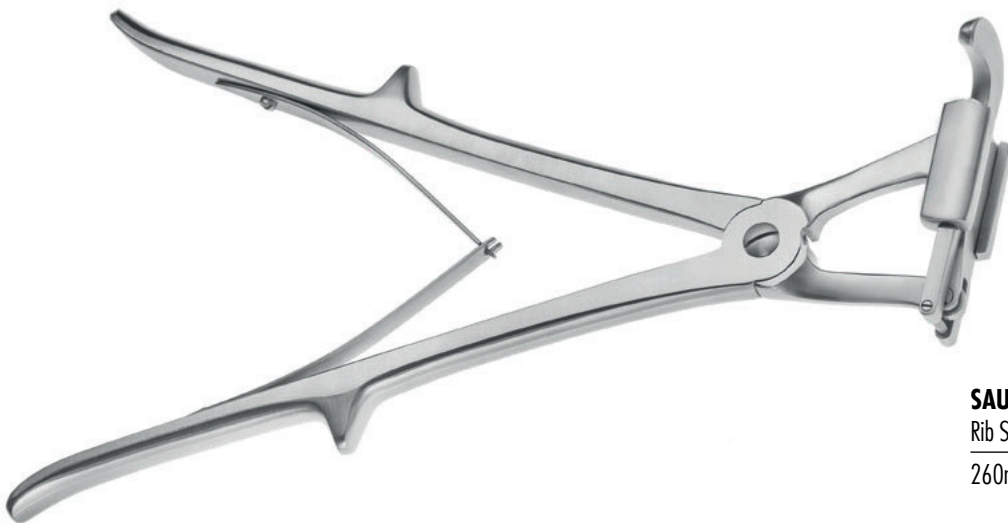

SAUERBRUCH

Rib Shears

260mm, 10¹/₄"

290-131-260



GIERTZ STILLE

Rib Shears, double action

250mm, 9⁷/₈"

290-137-270

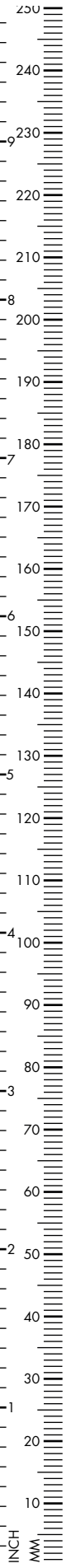

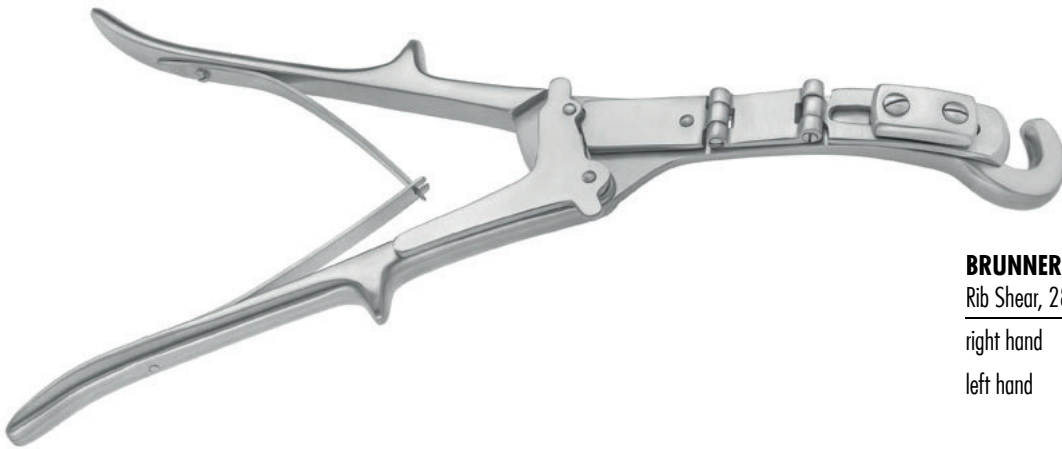

BRUNNER

Rib Shear, 280mm, 11"

right hand	290-147-280
left hand	290-149-280



VEHMEHREN (TUDOR EDWARDS)

Costotome

240mm, 9 ^{1/2} "	290-110-240
---------------------------	-------------



SWEET

Sternum Punch

230mm, 9"	290-158-245
-----------	-------------

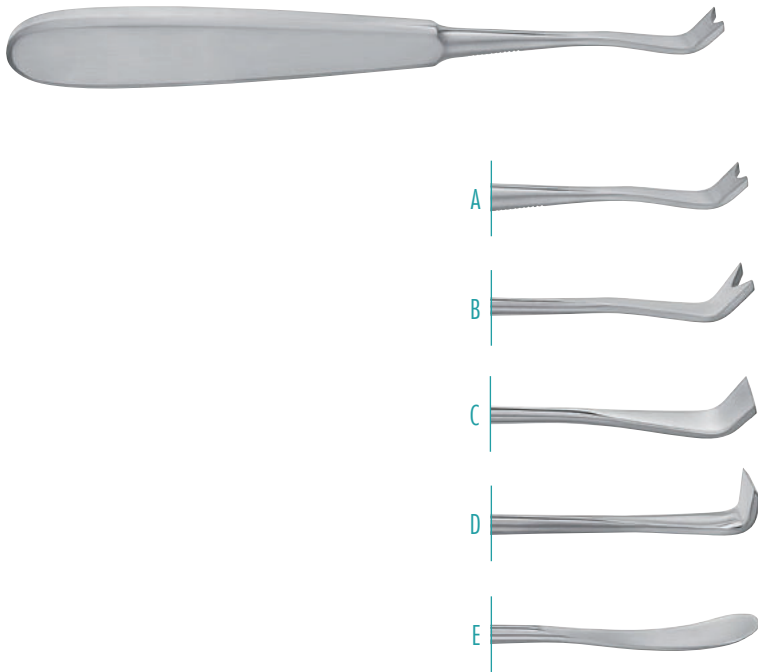

SEMB

Raspatory, hollow handle, 190mm, 7¹/₂"

A 12mm 210-450-001

230mm, 9"

B 12mm 210-450-002

C 13mm 210-450-003

D 13mm 210-450-004

E 15mm 210-450-005

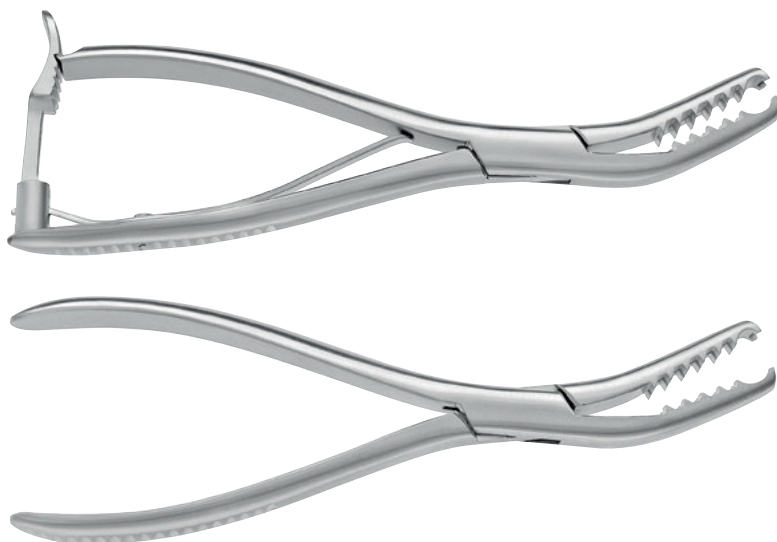

SEMB

Bone Holding Forceps, laterally curved
with ratchet

190mm, 7¹/₂" 210-624-190

without ratchet

190mm, 7¹/₂" 210-623-190



LEBSCHÉ

Sternum Chisel

245mm, 9²/₃"

290-151-240

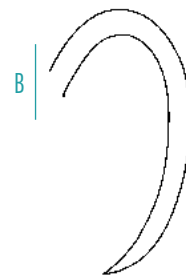

DOYEN

Rib Raspatory, 175mm, 6⁷/₈"

A right, adults

210-331-170

B left, adults

210-333-170

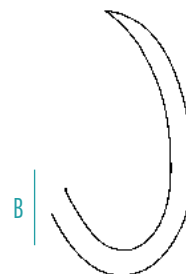

DOYEN

Rib Raspatory, 175mm, 6⁷/₈"

A right, children

210-335-170

B left, children

210-337-170



Mini Thoracotomy Retractor,
double hinge, set with 2 blades pairs
36 x 55 / 36 x 40mm, detachable crossbar

290-156-000

Blade Pair

40 x 70mm 290-156-001

Blades, 280mm length

95 x 18mm 290-156-004

95 x 22mm 290-156-005

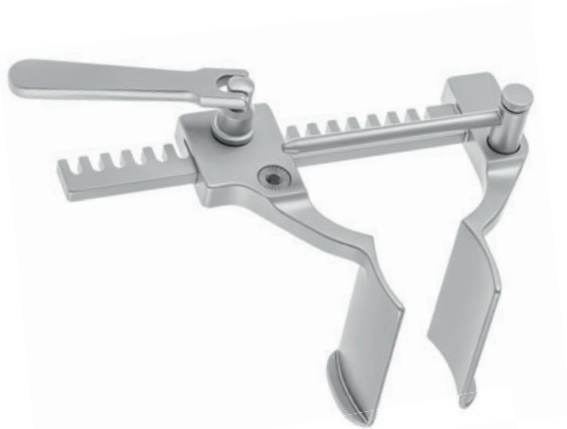

Mini Thoracotomy Retractor

36 x 45mm blades 290-155-045

36 x 60mm blades 290-155-060

36 x 80mm blades 290-155-080

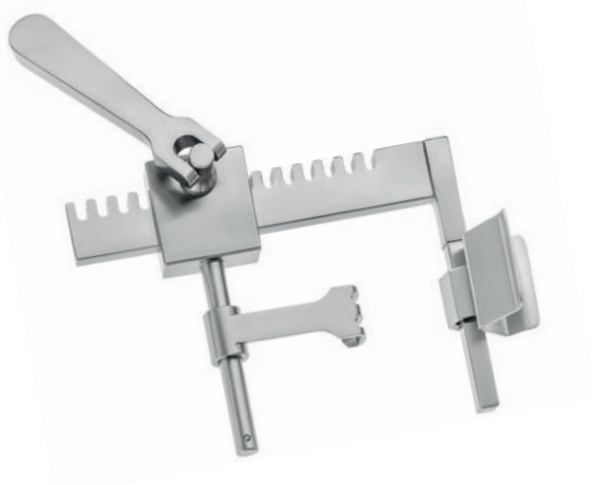

IMA Mini-Sternotomy Retractor,
complete with U-Blade 38mm, 2x french hooks

120mm, 4^{3/4}" 290-184-030

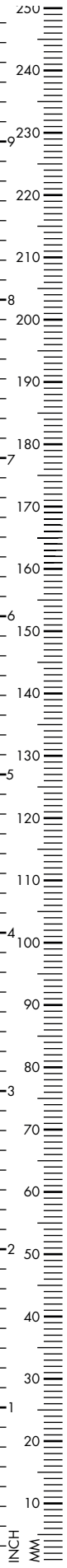



FINOCHIETTO

Micro Neonatal Rib Spreader

27 x 12 x 10mm (length/width/depth)

35mm spread 290-177-035



FINOCHIETTO BABY

Rib Spreader, straight arms

51 x 15 x 13mm (length/width/depth)

55mm spread 290-177-055

51 x 15 x 13mm (length/width/depth)

75mm spread 290-177-070

60 x 21 x 18mm (length/width/depth)

80mm spread 290-177-075



FINOCHIETTO BABY

Rib Spreader, curved arms

60 x 21 x 18mm (length/width/depth)

80mm spread 290-179-075

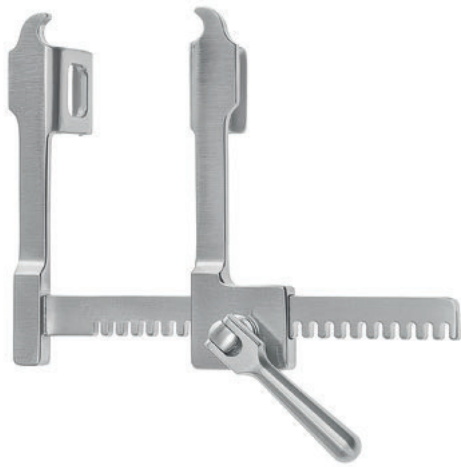
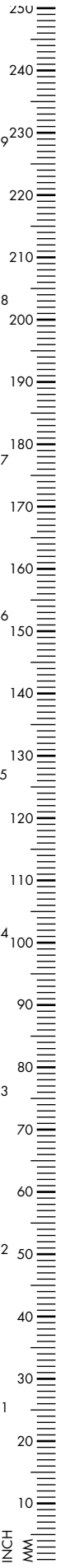

FINOCHIETTO BABY

Rib Spreader, with contractor
68 x 21 x 19mm (length/width/depth)

80mm spread 290-178-075



HAIGHT FINOCHIETTO BABY

Rib Spreader, Aluminium
76 x 31 x 31mm (length/width/depth)

98mm spread 290-161-002



HAIGHT

Rib Spreader, small
64 x 31 x 32mm (length/width/depth)

126mm spread 290-168-060

large
90 x 31 x 32mm (length/width/depth)

126mm spread 290-168-090



BAILEY FINOCHIETTO

Rib Spreader, Aluminium

58 x 14 x 12mm (length/width/depth)

74mm spread 290-179-000

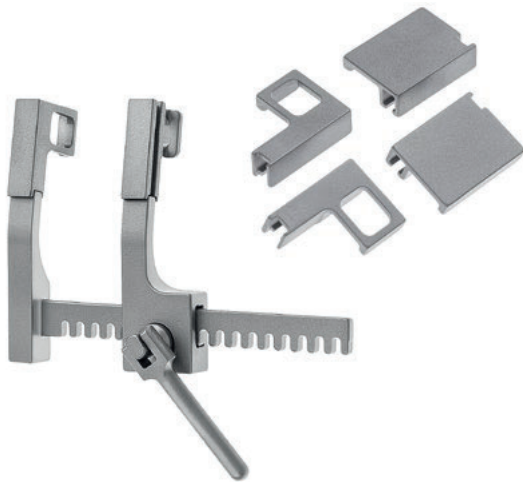

Mini Thorax Spreader, Titanium,

40mm length

39mm spread 290-187-000

Spare Valves, paired

20 x 15mm (width/depth)

290-187-001

Spare Valves, paired

10 x 15mm (width/depth)

290-187-002



MORSE

Rib Spreader, small, black coated,
movable valves

56 x 40 x 12mm (length/width/depth)

65mm spread 290-300-255



CASTANEDA

Rib Spreader, Aluminium

60 x 34 x 11mm (length/width/depth)

74mm spread 290-166-001

80 x 45 x 13mm (length/width/depth)

80mm spread 290-166-002

126 x 60 x 17.5mm (length/width/depth)

110mm spread 290-166-003



COOLEY CLARKE

Rib Spreader, Infants

70 x 15 x 10mm (length/width/depth)

65mm spread 290-160-010



HAIGHT BABY

Rib Spreader

73 x 35 x 31.5mm (length/width/depth)

90mm spread 290-168-050



COOLEY

Rib Spreader, Aluminium, Children, with points

77 x 20.5 x 17mm (length/width/depth)

97mm spread 290-160-000



COOLEY

Rib Spreader, Aluminium, Children

58 x 17 x 11mm (length/width/depth)

74mm spread 290-160-001

80 x 30 x 17mm (length/width/depth)

101mm spread 290-160-002



ANKENEY

Rib Spreader, Aluminium, 4 fixed swivel valves
114 x 19 x 23mm (length/width/depth)

139mm spread 290-177-000



RIENHOFF

Rib Spreader
116 x 33 x 30mm (length/width/depth)

140mm spread 290-169-000

146 x 45 x 47mm (length/width/depth)

140mm spread 290-169-010



BADGLEY

Rib Spreader, 4 prongs

108 x 45 x 50mm (length/width/depth)

165mm spread 170-905-000



FINOCHIETTO

Rib Spreader, curved arms, circular fenestration

111 x 32 x 28mm (length/width/depth)

150mm spread 290-181-180



MORSE

Rib Spreader, Children, movable valves

125 x 22 x 15mm (length/width/depth)

154mm spread 290-300-300

148 x 29 x 23mm (length/width/depth)

212mm spread 290-300-400



DEBAKEY

Rib Spreader, Children, incl. 3 paired valves

144mm length

152mm spread 290-180-001

Spare Valves

30 x 30mm (width/depth)

290-180-030

40 x 40mm (width/depth)

290-180-040

50 x 50mm (width/depth)

290-180-050



TUFFIER

Rib Spreader, toothed valves

180 x 45 x 48mm (length/width/depth)

178mm spread 290-174-000

serrated valves

180 x 45 x 48mm (length/width/depth)

178mm spread 290-174-010



COOLEY

Rib Spreader,

112 x 46 x 25mm (length/width/depth)

137mm spread 290-160-003

140 x 52 x 34mm (length/width/depth)

170mm spread 290-160-004

158 x 102 x 29mm (length/width/depth)

194mm spread 290-160-005

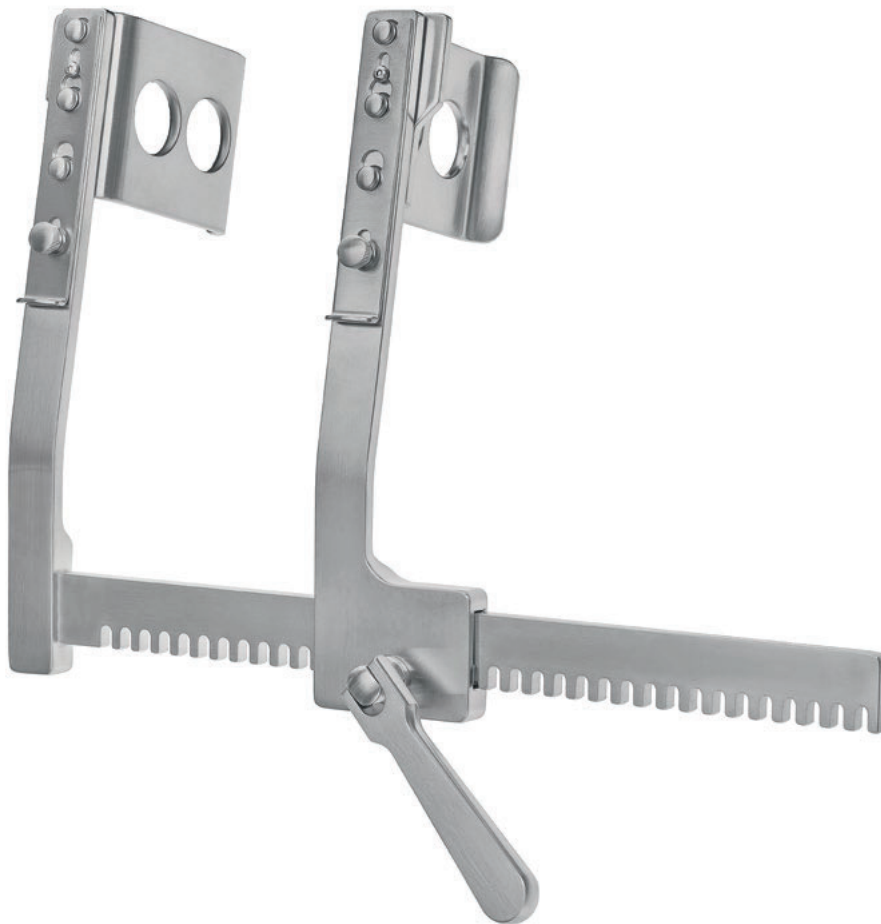

BURFORD

Rib Spreader, Children, incl. 4 paired valves
108mm length

157mm spread 290-181-020

Spare Valves
44 x 47mm (width/depth)

290-181-021

45 x 31mm (width/depth)

290-181-022

33 x 30mm (width/depth)

290-181-023

23 x 22mm (width/depth)

290-181-024



BURFORD-FINOCCHIETTO

Rib Spreader, Aluminium, incl. 2 paired valves
113mm length

135mm spread 290-164-000

Spare Valves, paired
42 x 34mm (width/depth)

290-165-102

42 x 48mm (width/depth)

290-165-103

DUBOST

Rib Spreader, incl. 3 paired valves
140mm length

160mm spread	290-186-010
--------------	-------------

Spare Valves, paired
100 x 30mm (width/depth)

290-186-011

100 x 40mm (width/depth)

290-186-012

100 x 50mm (width/depth)

290-186-013

DUBOST

Rib Spreader, incl. 3 pair valves,
fixation and Mammary valve
140mm length

160mm spread	290-186-000
--------------	-------------

Spare Valves, paired
100 x 30mm (width/depth)

290-186-011

Spare Valves, paired
100 x 40mm (width/depth)

290-186-012

Spare Valves, paired
100 x 50mm (width/depth)

290-186-013



DEBAQUEY

Rib Spreader, incl. 3 paired valves
153mm length

192mm spread 290-185-220

Spare Valves, paired
30 x 30mm (width/depth)

290-185-030

40 x 40mm (width/depth)

290-185-040

50 x 50mm (width/depth)

290-185-050

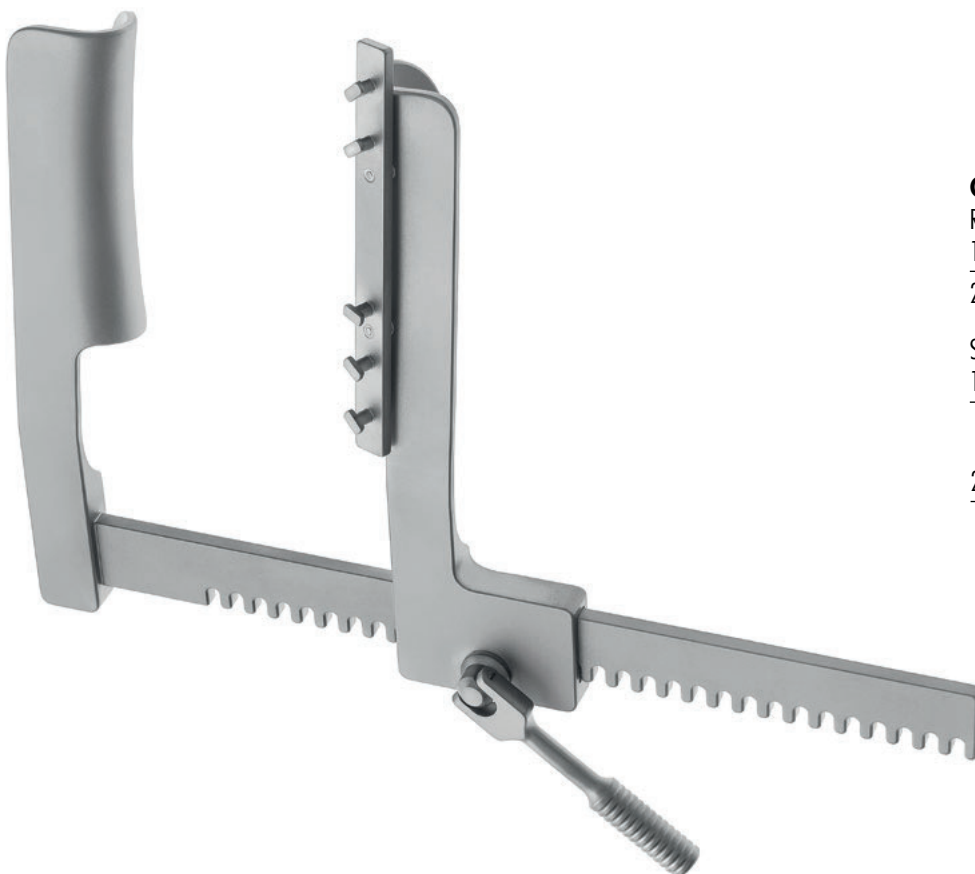

CARPENTIER

Rib Spreader, incl. 2 paired sternal valves
165 x 100 x 36mm (length/width/depth)

200mm spread 290-188-000

Spare Valves, paired
15 x 25mm (width/depth)

290-188-001

25 x 25mm (width/depth)

290-188-002



FINOCHIETTO

Rib Spreader, curved arms

130 x 45 x 40mm (length/width/depth)

148mm spread 290-178-165

180 x 65 x 50mm (length/width/depth)

200mm spread 290-178-200

180 x 65 x 70mm (length/width/depth)

250mm spread 290-178-250

180 x 65 x 50mm (length/width/depth)

265mm spread 290-179-255

180 x 65 x 50mm (length/width/depth)

310mm spread 290-179-310



straight arms

FINOCHIETTO

Rib Spreader, straight arms

186 x 66 x 51mm (length/width/depth)

200mm spread 290-177-200

265mm spread 290-177-255

310mm spread 290-177-310



BIRNBAUM

Rib Spreader, movable blades

198 x 60 x 40mm (length/width/depth)

185mm spread

290-189-000



IMA FRENCH

Rib Spreader, incl. 3 paired valves
150mm length

290-184-020

Spare Valves, paired
50 x 22mm (width/depth)

290-184-021

40 x 22mm (width/depth)

290-184-022

100mm width

290-184-023



DEBAKEY

Rib Spreader, incl. 3 paired valves
170mm length

240mm spread 290-185-285

Spare Valves, paired
60 x 60mm (width/depth)

290-181-060

80 x 50mm (width/depth)

290-181-050

100 x 40mm (width/depth)

290-181-040

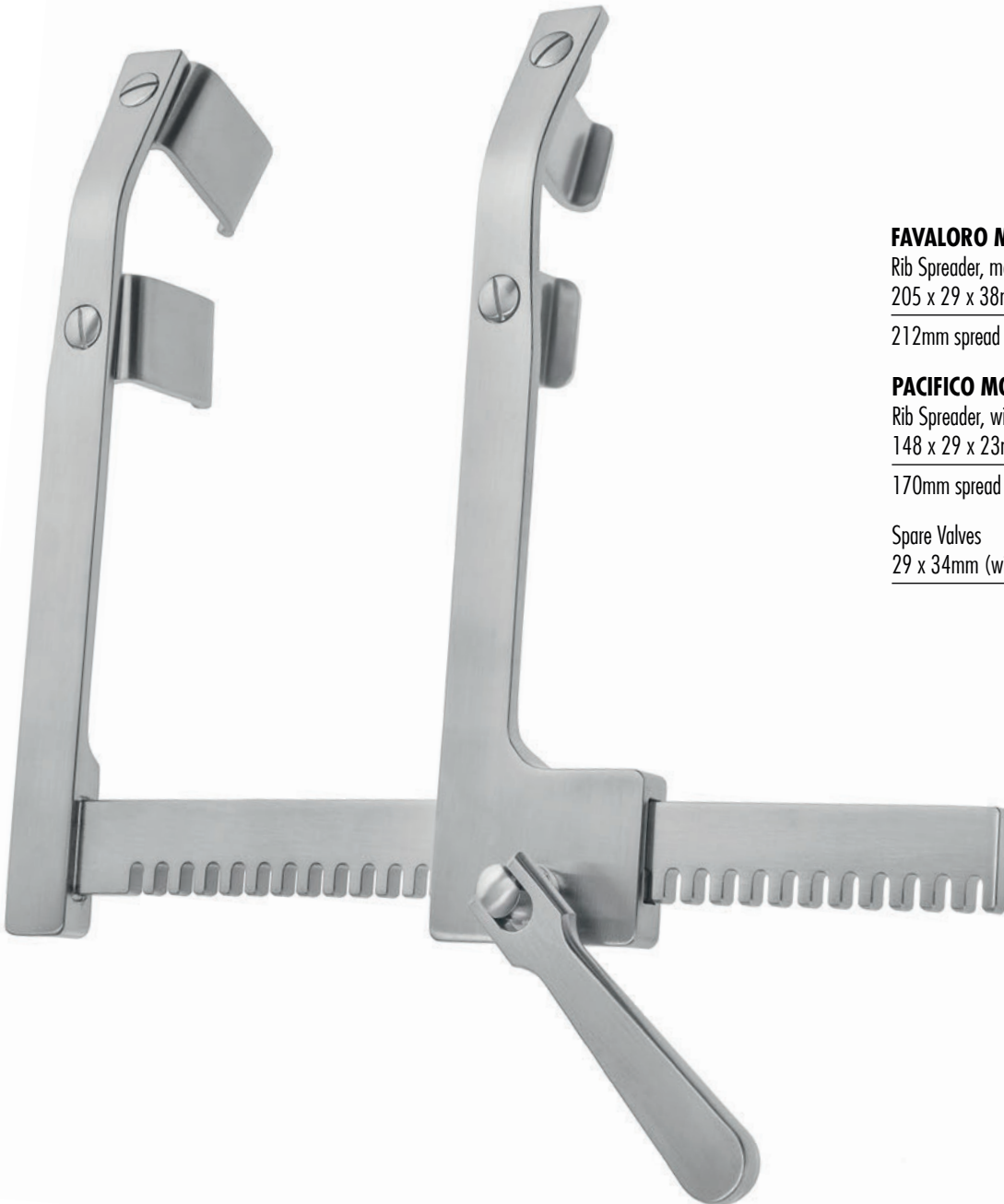

FAVALORO MORSE

Rib Spreader, movable valves

205 x 29 x 38mm (length/width/depth)

212mm spread 290-310-000

PACIFICO MORSE

Rib Spreader, with 2 pair valves

148 x 29 x 23mm (length/width/depth)

170mm spread 290-300-150

Spare Valves

29 x 34mm (width/depth)

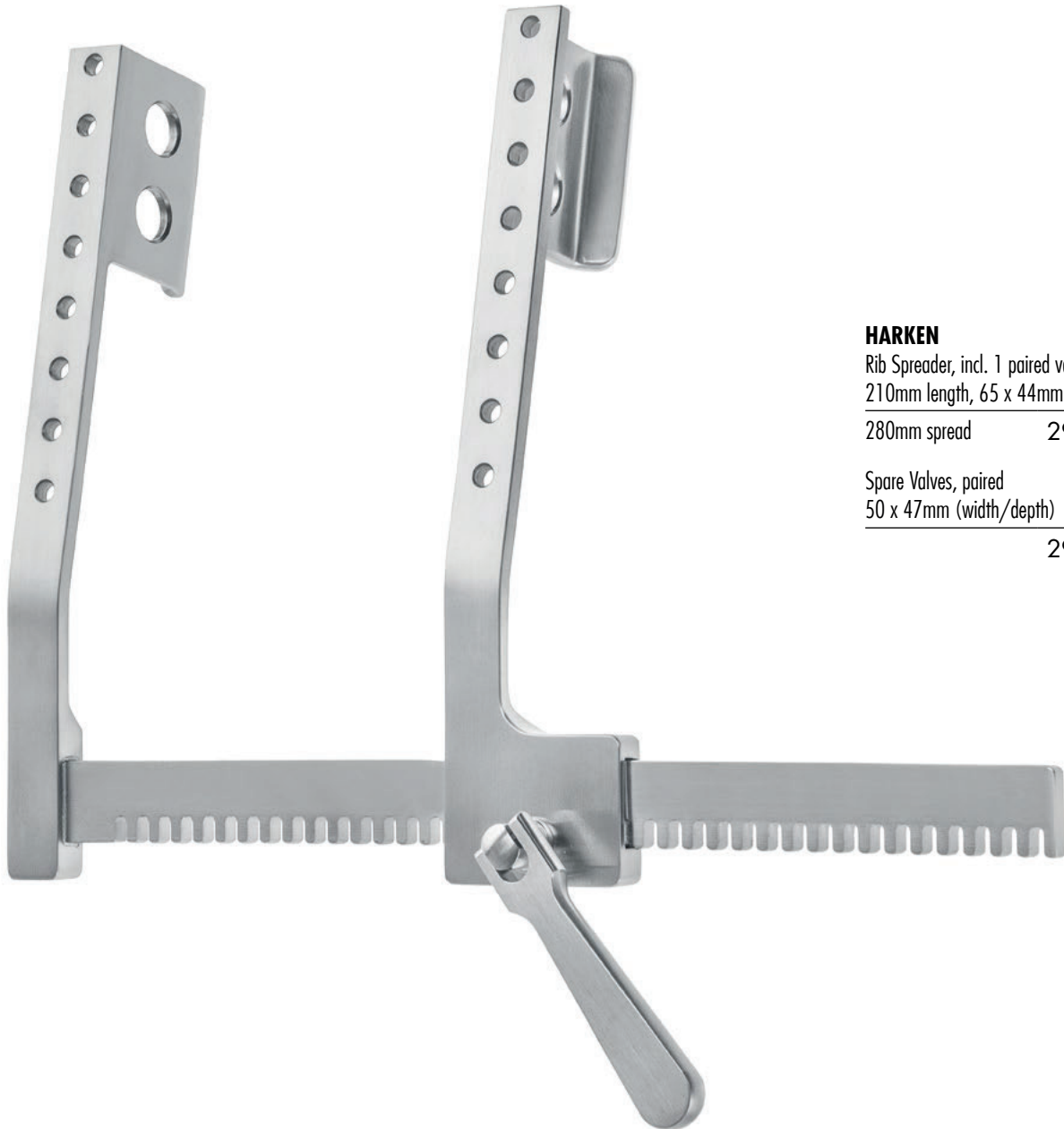

HARKEN

Rib Spreader, incl. 1 paired valves
210mm length, 65 x 44mm

280mm spread	290-183-000
--------------	-------------

Spare Valves, paired
50 x 47mm (width/depth)

	290-183-001
--	-------------

**ANKENEY**

Rib Spreader, Adult, 6 fixed swivel valves
289 x 35 x 35mm (length/width/depth)

195mm spread

290-178-000

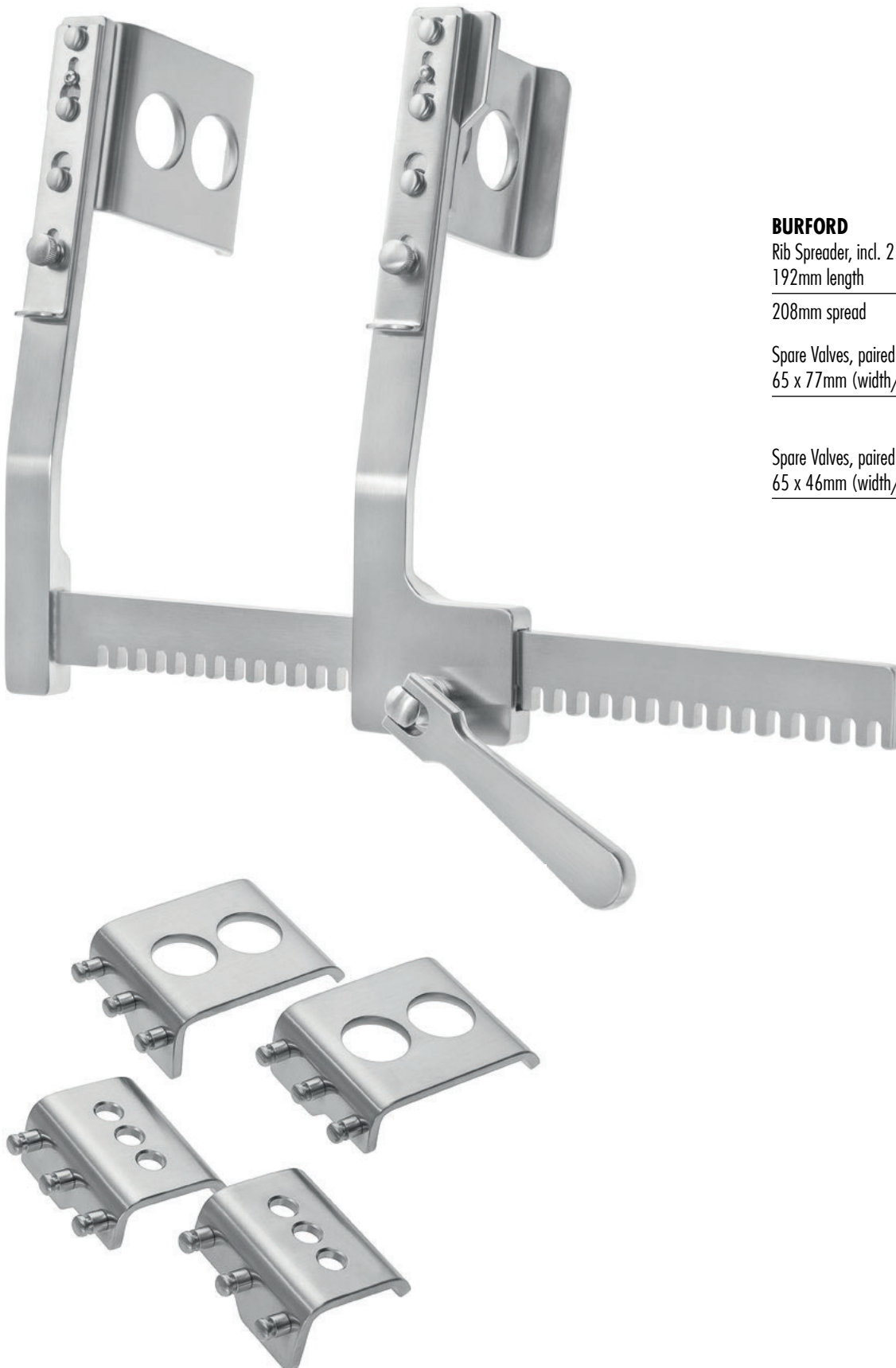

BURFORD

Rib Spreader, incl. 2 pair valves
192mm length

208mm spread 290-181-000

Spare Valves, paired
65 x 77mm (width/depth)

290-181-001

Spare Valves, paired
65 x 46mm (width/depth)

290-181-002

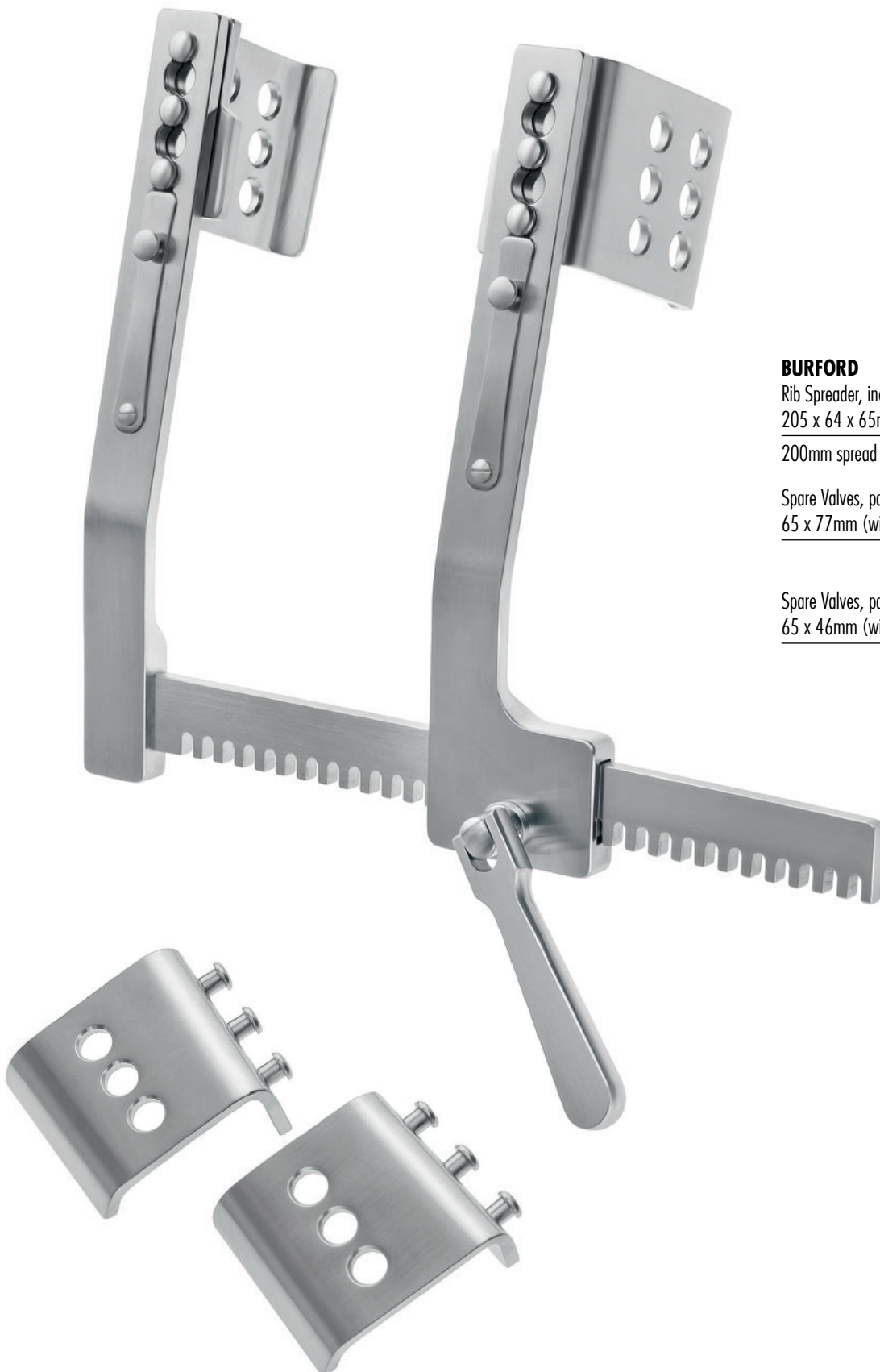

BURFORD

Rib Spreader, incl. 2 pair valves
205 x 64 x 65mm (length/width/depth)

200mm spread 290-181-010

Spare Valves, paired
65 x 77mm (width/depth)

290-181-011

Spare Valves, paired
65 x 46mm (width/depth)

290-181-012

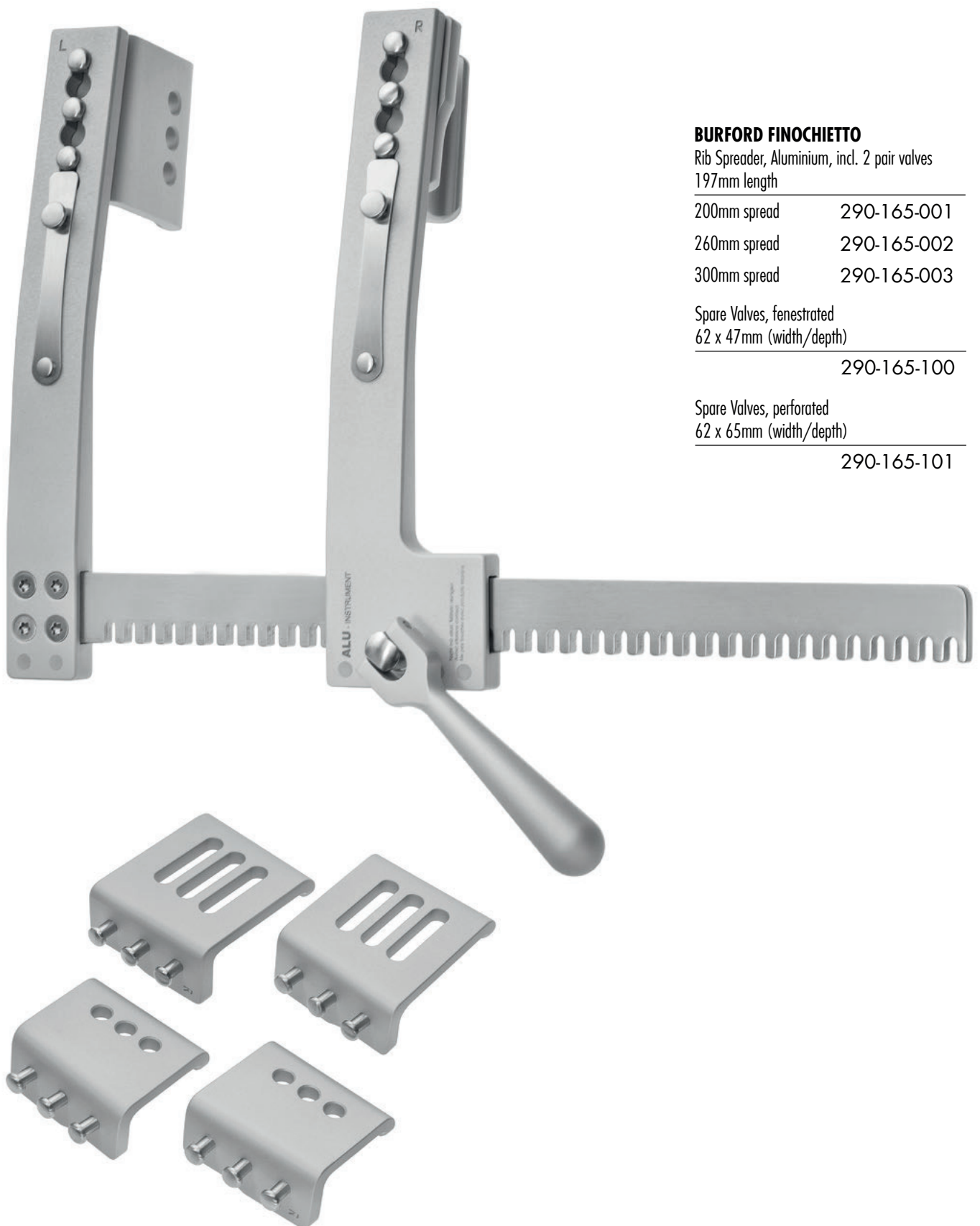

BURFORD FINOCHIETTO

Rib Spreader, Aluminium, incl. 2 pair valves
197mm length

200mm spread 290-165-001

260mm spread 290-165-002

300mm spread 290-165-003

Spare Valves, fenestrated
62 x 47mm (width/depth)

290-165-100

Spare Valves, perforated
62 x 65mm (width/depth)

290-165-101

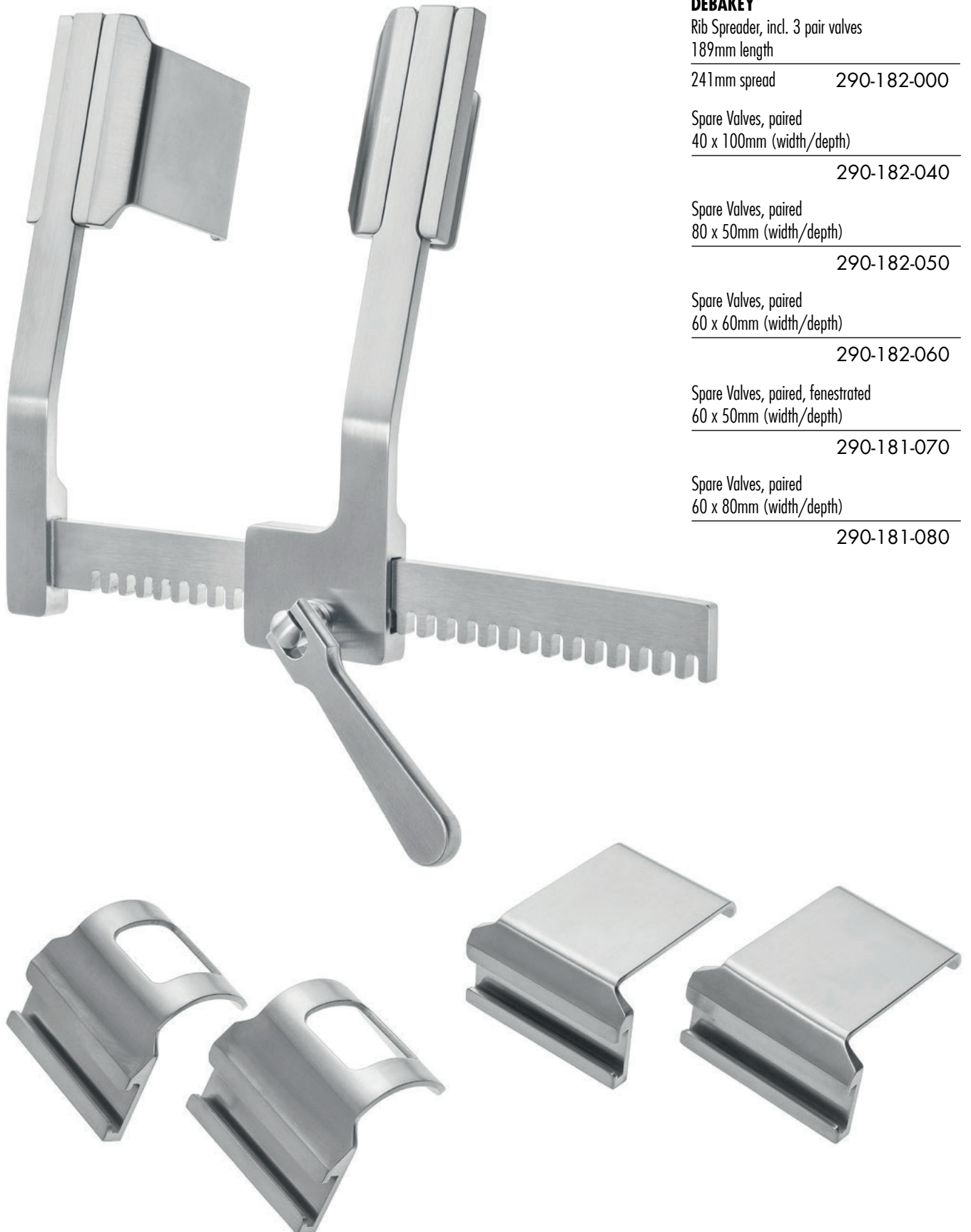

DEBAKEY

Rib Spreader, incl. 3 pair valves
189mm length

241mm spread 290-182-000

Spare Valves, paired
40 x 100mm (width/depth)

290-182-040

Spare Valves, paired
80 x 50mm (width/depth)

290-182-050

Spare Valves, paired
60 x 60mm (width/depth)

290-182-060

Spare Valves, paired, fenestrated
60 x 50mm (width/depth)

290-181-070

Spare Valves, paired
60 x 80mm (width/depth)

290-181-080

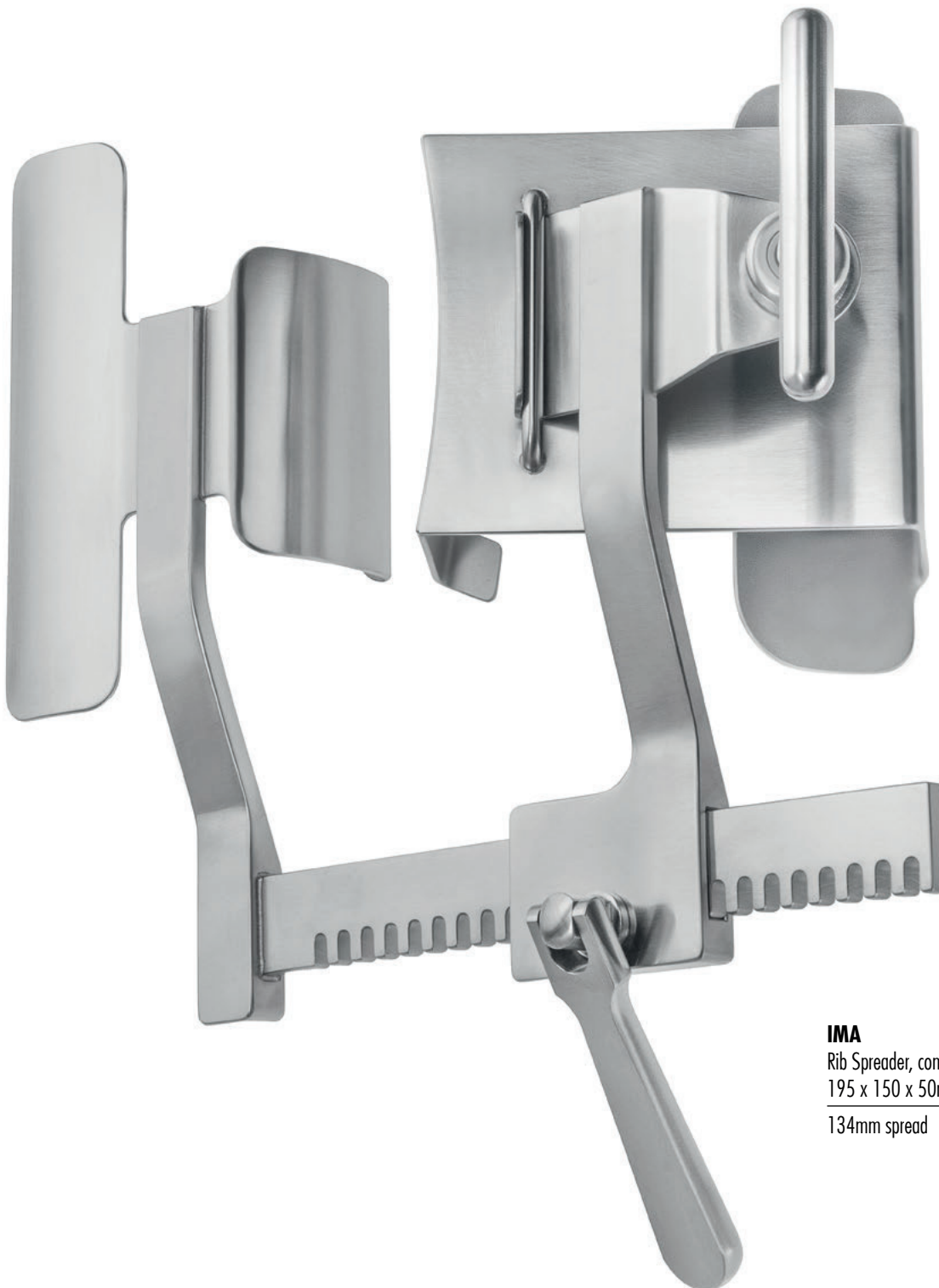

IMA

Rib Spreader, complete with Mammary blade
195 x 150 x 50mm (length/width/depth)

134mm spread 290-184-010

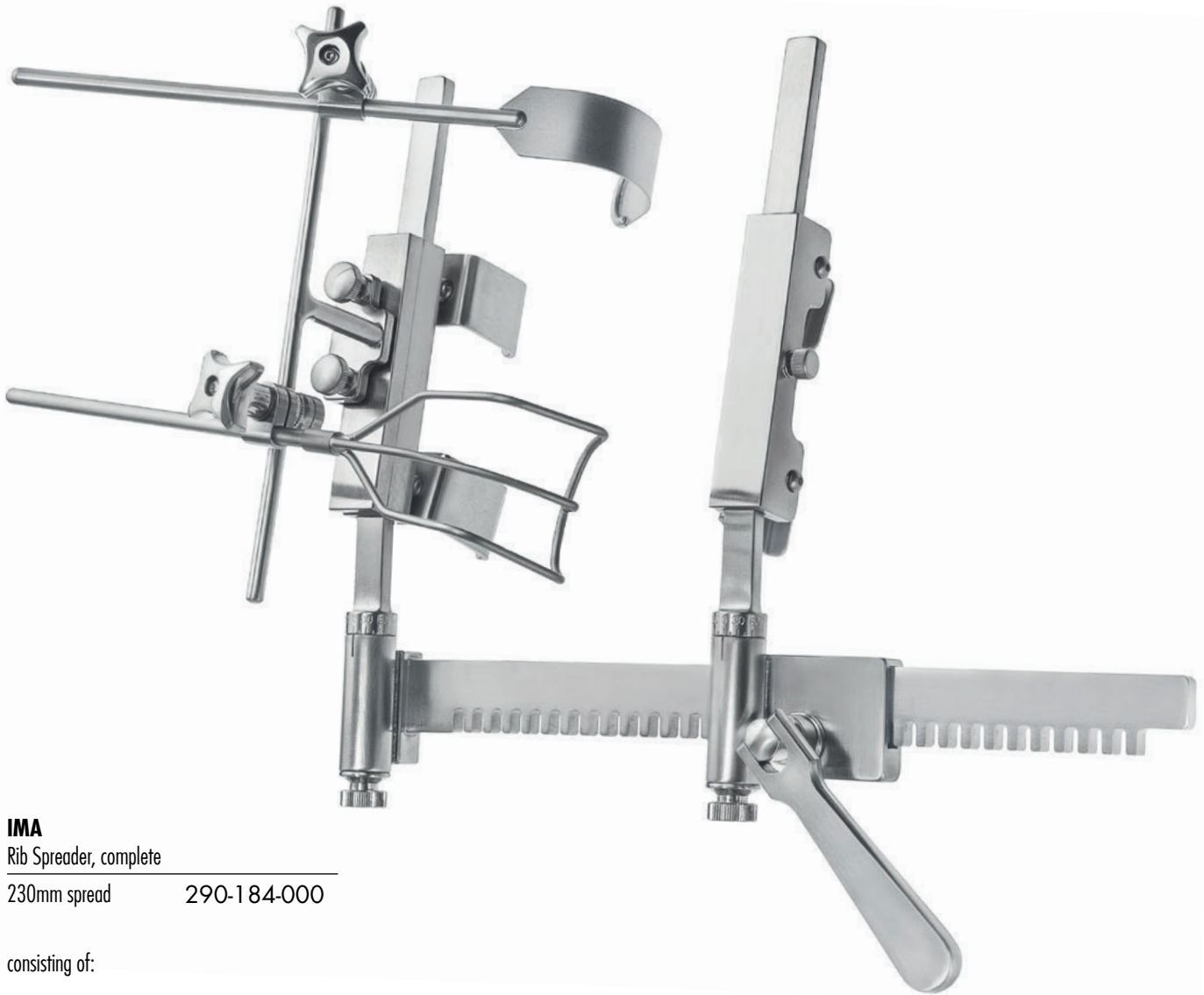

IMA

Rib Spreader, complete

230mm spread 290-184-000

consisting of:

Double fixation valves

290-184-001

Double fixation valves with notch

290-184-002

T-Clamp

290-184-003

Universal Clamp

290-184-004

COOLEY

Valve Retractor

small, 25mm 290-184-005

medium, 40mm 290-184-006

large, 50mm 290-184-007

Ribbon malleable valve

290-184-008





QUERVAIN

Rib Spreader, complete

160mm spread	290-190-000
--------------	-------------

consisting of:

Spare Valves, paired,
50 x 70mm (width/depth)

left	290-190-001
------	-------------

50 x 70mm (width/depth)

right	290-190-002
-------	-------------

70 x 70mm (width/depth)

left	290-190-003
------	-------------

70 x 70mm (width/depth)

right	290-190-004
-------	-------------

70 x 70mm (width/depth)

left, curved	290-190-005
--------------	-------------

70 x 70mm (width/depth)

right, curved	290-190-006
---------------	-------------

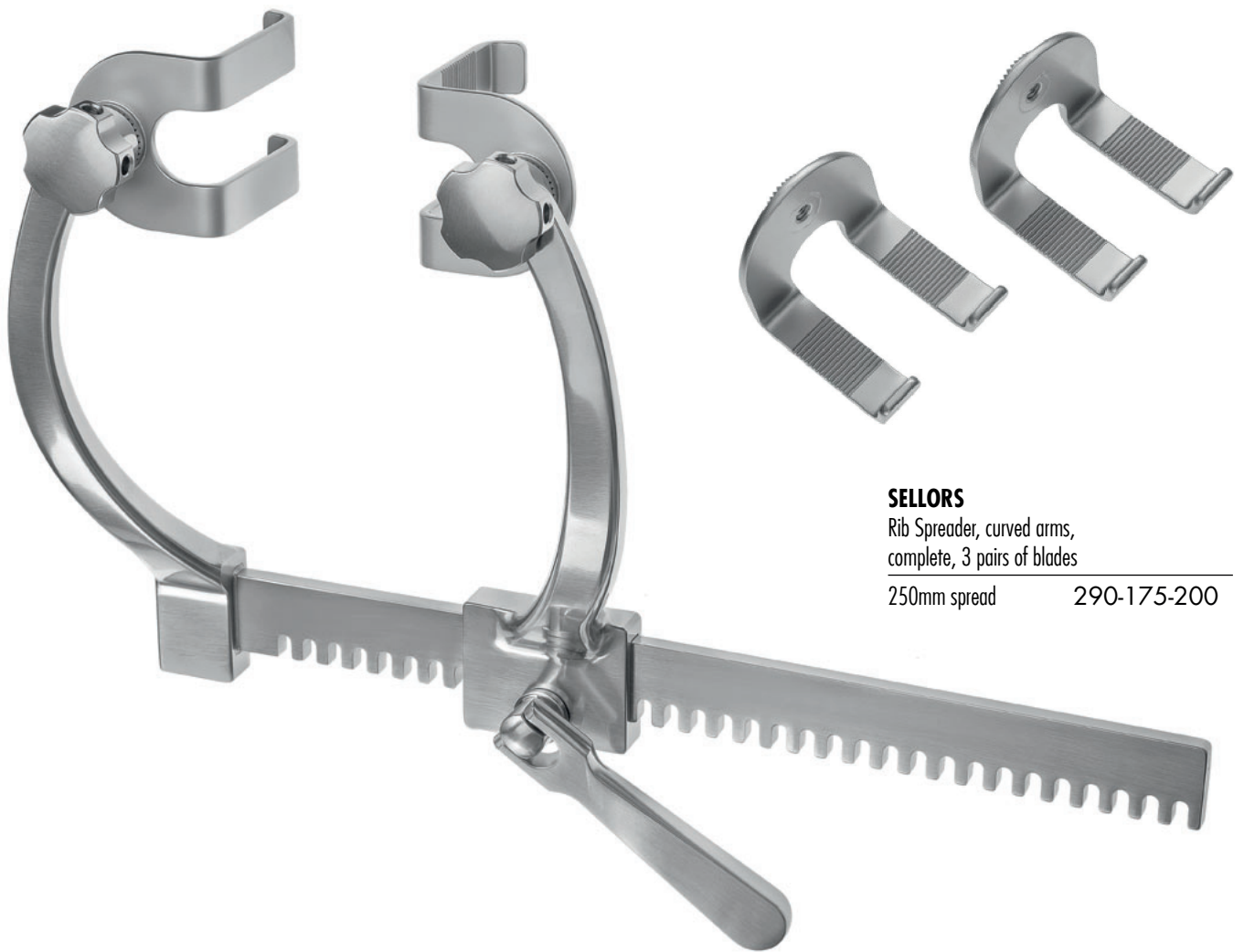

SELLORS

Rib Spreader, curved arms,
complete, 3 pairs of blades

250mm spread

290-175-200



BAILEY BABY

Rib Contractor, 3 prongs, 18mm depth

140mm length 290-501-140



BAILEY

Rib Contractor, 3 prongs, 19mm depth

180mm length 290-502-160



BAILEY GIBBON

Rib Contractor, 3 prongs, 29mm depth

180mm length 290-503-160



LEMMON

Rib Contractor, Children

145mm length 290-504-140

Adults

180mm length 290-504-180



ÖSCH

Phlebectomy Hook, right handed

Fig. 1	290-150-501
Fig. 2	290-150-502
Fig. 3	290-150-503
Set	290-150-500

left handed

Fig. 1	290-150-601
Fig. 2	290-150-602
Fig. 3	290-150-603
Set	290-150-600



MÜLLER

Phlebectomy Hook, right handed

Fig. 1	290-150-001
Fig. 2	290-150-002
Fig. 3	290-150-003
Fig. 4	290-150-004
Set	290-150-000

Phlebectomy Hook, left handed

Fig. 1	290-150-101
Fig. 2	290-150-102
Fig. 3	290-150-103
Fig. 4	290-150-104
Set	290-150-000

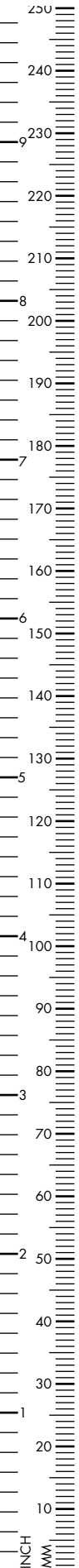

Fig. 1

Fig. 2

Fig. 3

LOEPRECHT

Phlebectomy Hook and Spatula
2.0mm wide spatula with small hook

Fig. 1 160-253-001

2.5mm wide spatula with medium hook

Fig. 2 160-253-002

3.0mm wide spatula with large hook

Fig. 3 160-253-003



Fig. 1

Fig. 2

VARADY

Phlebectomy Dissector

180mm, 7" 160-252-001

Phleboextractor, with hook 180mm, 7"

Fig. 1 160-252-002

Fig. 2 160-252-003



VARADY

Micro Spatula

175mm, 6⁷/₈" 160-252-004



A

B

VARADY

Micro Phleboextractor, 170mm, 6²/₃"

A 160-252-005

B 160-252-006

Set 160-252-000



Probe, malleable

400mm, 15 ³ / ₄ "	160-210-400
500mm, 19 ³ / ₄ "	160-210-500
650mm, 25 ¹ / ₂ "	160-210-650
800mm, 31 ¹ / ₂ "	160-210-800



NABATOFF

Vein Stripper Set consisting of:

Probe tip, plastic	160-250-002
Stripper head, 3mm	160-250-003
Stripper head, 6mm	160-250-006
Stripper head, 9mm	160-250-009
Stripper head, 12mm	160-250-012
T-Handle	160-250-080
Sterilization Box	160-250-095
Set complete	160-250-000



MYERS

Vein Stripper

Ø 6mm	160-245-006
Ø 9mm	160-245-009
Ø 12.5mm	160-245-125
Ø 16mm	160-245-016

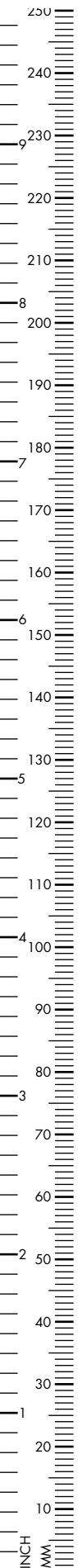

Vessel Probes, 110mm, 4¹/₃"

Ø 0.5mm	290-704-105
Ø 1.0mm	290-704-110
Ø 1.5mm	290-704-115
Ø 2.0mm	290-704-120
Ø 2.5mm	290-704-125
Ø 3.0mm	290-704-130
Ø 3.5mm	290-704-135

Set

290-704-100

140mm, 5¹/₂"

Ø 0.5mm	290-704-405
Ø 1.0mm	290-704-410
Ø 1.5mm	290-704-415
Ø 2.0mm	290-704-420
Ø 2.5mm	290-704-425
Ø 3.0mm	290-704-430
Ø 3.5mm	290-704-435

Set

290-704-200

210mm, 8¹/₄"

Ø 0.5mm	290-704-205
Ø 1.0mm	290-704-210
Ø 1.5mm	290-704-215
Ø 2.0mm	290-704-220
Ø 2.5mm	290-704-225
Ø 3.0mm	290-704-230
Ø 3.5mm	290-704-235

Set

290-704-300



GARRETT

Vascular Dilator, malleable, Ø 0.5mm

140mm, 5 ¹ / ₂ "	290-195-105
210mm, 8 ¹ / ₄ "	290-195-000
190mm, 7 ¹ / ₂ "	290-195-205
350mm, 14"	290-195-305

Ø 1.0mm

140mm, 5 ¹ / ₂ "	290-195-110
210mm, 8 ¹ / ₄ "	290-195-010
190mm, 7 ¹ / ₂ "	290-195-210
350mm, 14"	290-195-310

Ø 1.5mm

140mm, 5 ¹ / ₂ "	290-195-115
210mm, 8 ¹ / ₄ "	290-195-015
190mm, 7 ¹ / ₂ "	290-195-215
350mm, 14"	290-195-315

Ø 2.0mm

140mm, 5 ¹ / ₂ "	290-195-120
210mm, 8 ¹ / ₄ "	290-195-020
190mm, 7 ¹ / ₂ "	290-195-220
350mm, 14"	290-195-320

Ø 2.5mm

140mm, 5 ¹ / ₂ "	290-195-125
210mm, 8 ¹ / ₄ "	290-195-025
190mm, 7 ¹ / ₂ "	290-195-225
350mm, 14"	290-195-325

Ø 3.0mm

140mm, 5 ¹ / ₂ "	290-195-130
210mm, 8 ¹ / ₄ "	290-195-030
190mm, 7 ¹ / ₂ "	290-195-230
350mm, 14"	290-195-330

Ø 3.5mm

140mm, 5 ¹ / ₂ "	290-195-135
210mm, 8 ¹ / ₄ "	290-195-035
190mm, 7 ¹ / ₂ "	290-195-235
350mm, 14"	290-195-335

Ø 4.0mm

140mm, 5 ¹ / ₂ "	290-195-140
210mm, 8 ¹ / ₄ "	290-195-040
190mm, 7 ¹ / ₂ "	290-195-240
350mm, 14"	290-195-340

Ø 4.5mm

140mm, 5 ¹ / ₂ "	290-195-145
210mm, 8 ¹ / ₄ "	290-195-045
190mm, 7 ¹ / ₂ "	290-195-245
350mm, 14"	290-195-345

Ø 5.0mm

140mm, 5 ¹ / ₂ "	290-195-150
210mm, 8 ¹ / ₄ "	290-195-050
190mm, 7 ¹ / ₂ "	290-195-250
350mm, 14"	290-195-350

Set

140mm, 5 ¹ / ₂ "	290-195-100
210mm, 8 ¹ / ₄ "	290-195-000
190mm, 7 ¹ / ₂ "	290-195-200
350mm, 14"	290-195-300



DEBAKEY

Vascular Dilator, malleable, Ø 0.5mm

190mm, 7¹/₂" 290-705-050

350mm, 14" 290-706-050

Ø 2.0mm

190mm, 7¹/₂" 290-705-200

350mm, 14" 290-706-200

Ø 3.5mm

190mm, 7¹/₂" 290-705-350

350mm, 14" 290-706-350

Ø 5.0mm

190mm, 7¹/₂" 290-705-500

350mm, 14" 290-706-500

Ø 1.0mm

190mm, 7¹/₂" 290-705-100

350mm, 14" 290-706-100

Ø 2.5mm

190mm, 7¹/₂" 290-705-250

350mm, 14" 290-706-250

Ø 4.0mm

190mm, 7¹/₂" 290-705-400

350mm, 14" 290-706-400

Ø 7.0mm

190mm, 7¹/₂" 290-705-700

350mm, 14" 290-706-700

Ø 1.5mm

190mm, 7¹/₂" 290-705-150

350mm, 14" 290-706-150

Ø 3.0mm

190mm, 7¹/₂" 290-705-300

350mm, 14" 290-706-300

Ø 4.5mm

190mm, 7¹/₂" 290-705-450

350mm, 14" 290-706-450

Ø 9.0mm

190mm, 7¹/₂" 290-705-900

350mm, 14" 290-706-900



COOLEY

Vascular Dilator, malleable, Ø 0.5mm

130mm, 5¹/₈" 290-703-005

190mm, 7¹/₂" 290-703-105

Ø 2.0mm

130mm, 5¹/₈" 290-703-020

190mm, 7¹/₂" 290-703-120

Ø 4.0mm

130mm, 5¹/₈" 290-703-040

190mm, 7¹/₂" 290-703-140

Ø 1.0mm

130mm, 5¹/₈" 290-703-010

190mm, 7¹/₂" 290-703-110

Ø 2.5mm

130mm, 5¹/₈" 290-703-025

190mm, 7¹/₂" 290-703-125

Ø 5.0mm

130mm, 5¹/₈" 290-703-050

190mm, 7¹/₂" 290-703-150

Ø 1.5mm

130mm, 5¹/₈" 290-703-015

190mm, 7¹/₂" 290-703-115

Ø 3.0mm

130mm, 5¹/₈" 290-703-030

190mm, 7¹/₂" 290-703-130

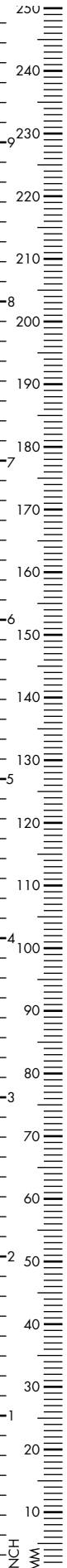



Endarterectomy Stripper, 550mm, 22"

A	2mm	160-251-002
B	3mm	160-251-003
C	4mm	160-251-004
D	6mm	160-251-006
E	7mm	160-251-007
F	8mm	160-251-008
G	10mm	160-251-010
H	12mm	160-251-012
I	14mm	160-251-014

Handle for Endarterectomy Stripper

160-251-030

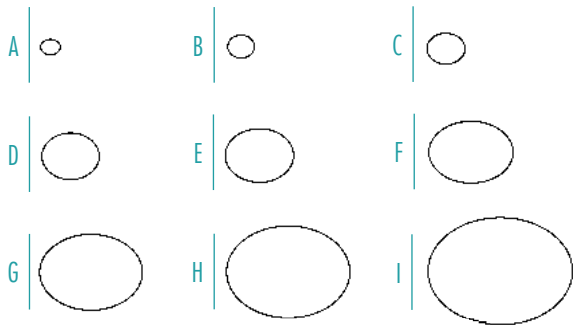

SCHMID

Vessel irrigating cannula, malleable

A	Ø 3mm	165-700-003
B	Ø 4mm	165-700-004
C	Ø 5mm	165-700-005
D	Ø 6mm	165-700-006

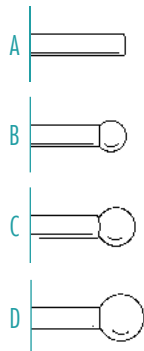

Cannula, venous

18G x 3 1/8"	165-705-120
(1.2 x 80mm)	
17G x 3 1/8"	165-705-150
(1.5 x 80mm)	



MOCK

Heparin Flushing Needle

60mm, 2 3/8"	165-710-060
--------------	-------------





TUBBS

Dilator, adult size
for mitral valve blade opening 8-42mm

290-482-000

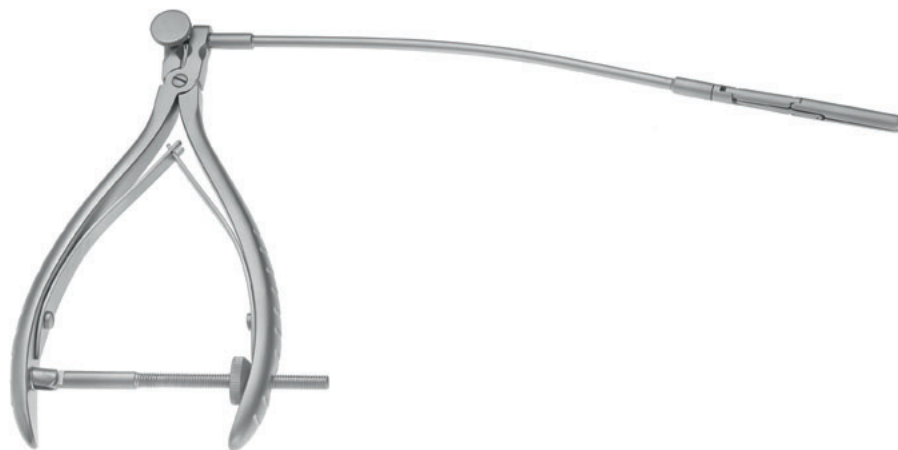

COOLEY

Dilator, child size

290-484-000

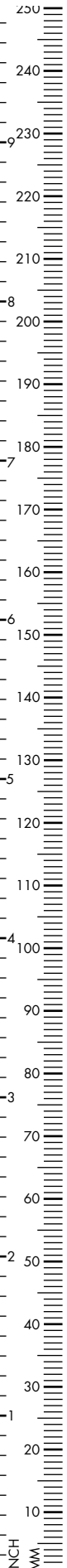



Intima Spatula, 3mm	
180mm, 7"	290-535-180
210mm, 8 ¹ / ₄ "	290-535-210
4mm	
140mm, 5 ¹ / ₂ "	290-537-140
5.5mm	
240mm, 9 ¹ / ₂ "	290-537-240

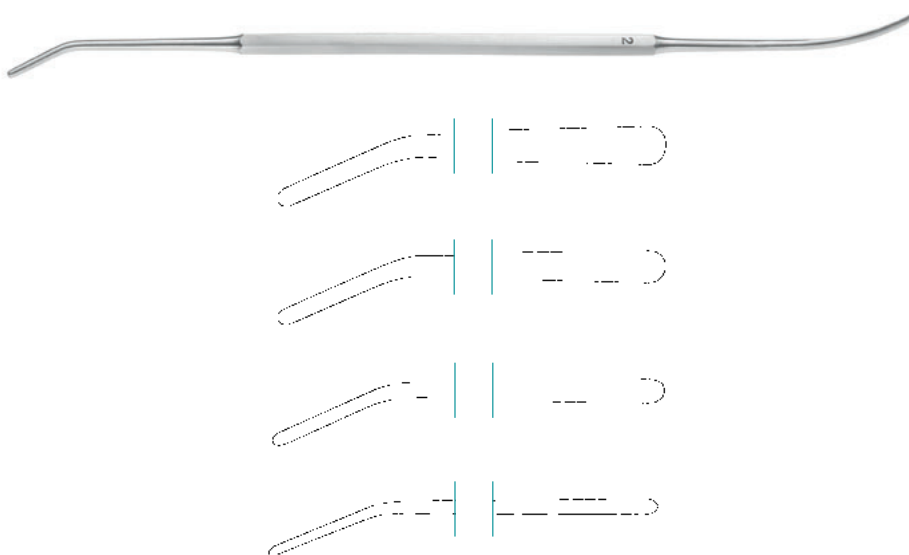

ROBB	
Dissector, 240mm, 9 ¹ / ₂ "	
Fig. 1, 5 / 2.5mm	290-539-001
Fig. 2, 4 / 2.0mm	290-539-002
Fig. 3, 3 / 1.5mm	290-539-003
Fig. 4, 2 / 1.0mm	290-539-004



LEMMON	
Intima Dissector, 165mm, 6 ¹ / ₂ "	
4mm wide	290-707-165
8mm wide	290-708-165
15mm wide	290-709-165

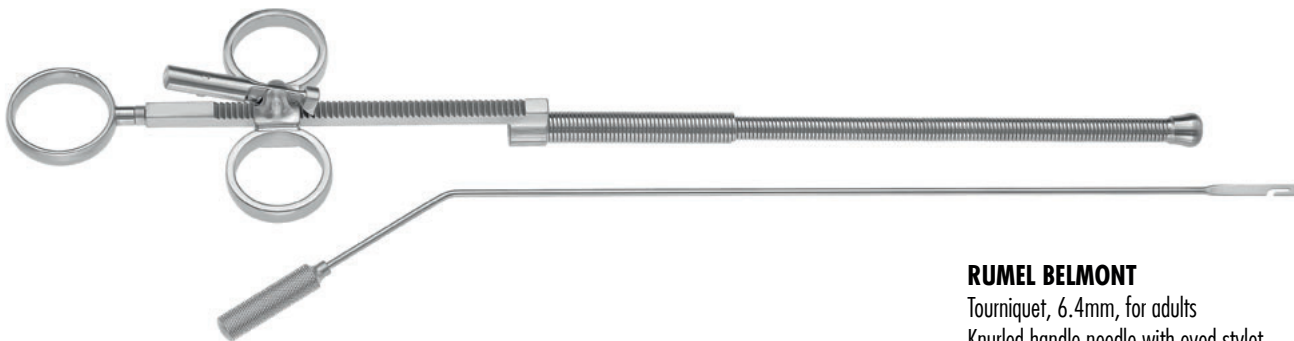

RUMEL BELMONT

Tourniquet, 6.4mm, for adults
Knurled handle needle with eyed stylet

complete	290-558-330
Stylet	290-558-331

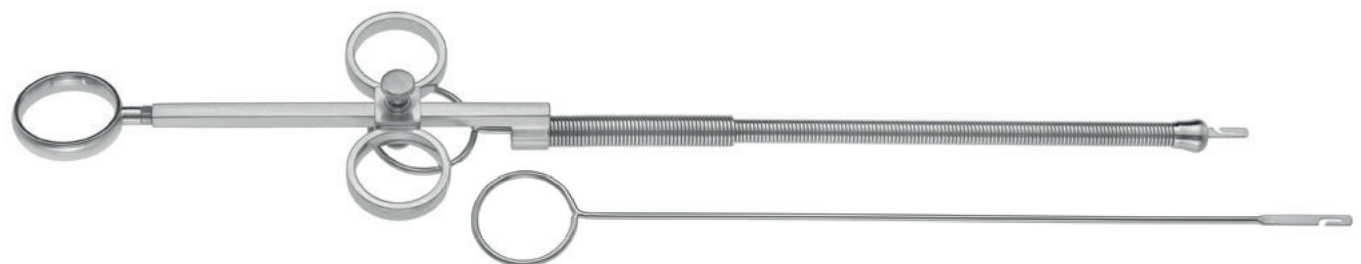

RUMEL BELMONT

Tourniquet, 6.5mm, for adults, flexible,
without ratchet,
Ring handle needle with eyed stylet

complete	290-564-305
Stylet	290-564-306

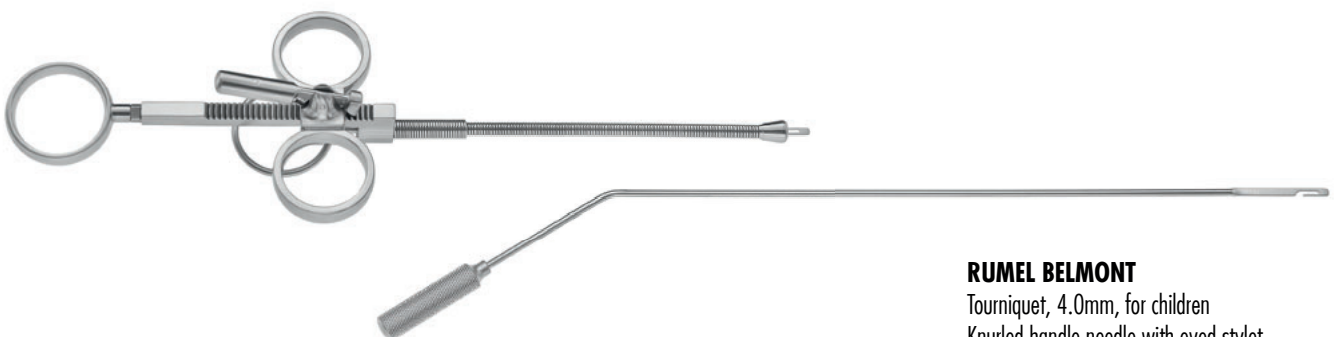

RUMEL BELMONT

Tourniquet, 4.0mm, for children
Knurled handle needle with eyed stylet

complete	290-556-330
Stylet	290-556-331

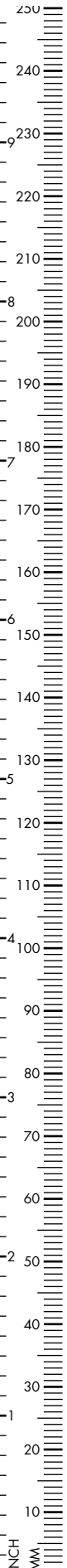

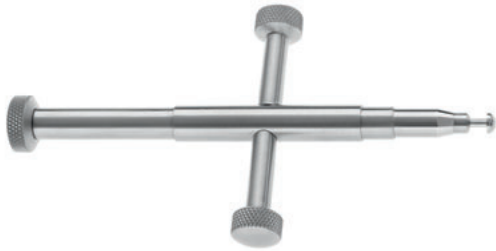

Punch	
120mm, 4 ^{3/4} "	
Ø 3mm	290-712-030
Ø 4mm	290-712-040
Ø 4.5mm	290-712-045
Ø 5mm	290-712-050
Ø 6mm	290-712-060
150mm, 6"	
Ø 3mm	290-715-030
Ø 4mm	290-715-040
Ø 4.5mm	290-715-045
Ø 5mm	290-715-050
Ø 6mm	290-715-060

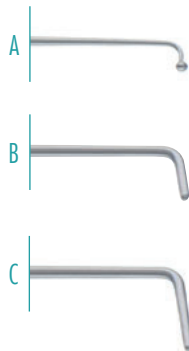

Nerve and Vessel Hook for valve surgery	
A 4.5mm tip length, Ø 1.5mm tip	
350mm, 14"	295-000-001
B 5.0mm tip length, Ø 1.0mm tip	
350mm, 14"	295-000-002
C 9.0mm tip length, Ø 1.5mm tip	
350mm, 14"	295-000-003

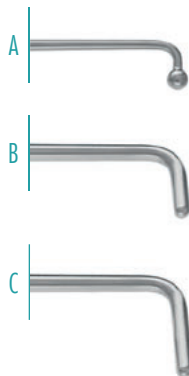

Nerve and Vessel Hook for valve surgery	
A 5.0mm tip length, Ø 3.0mm tip	
330mm, 13"	295-000-101
B 5.0mm tip length, Ø 1.4mm tip	
330mm, 13"	295-000-102
C 9.0mm tip length, Ø 2.3mm tip	
330mm, 13"	295-000-103

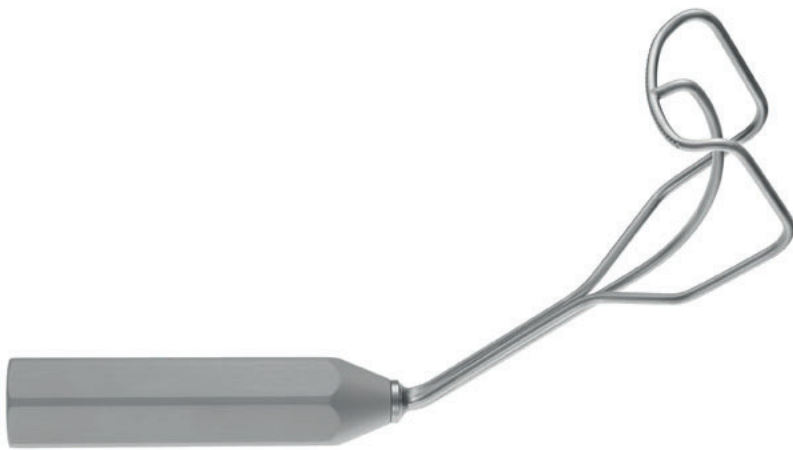

COOLEY

Retractor, serrated, Aluminium handle, right

25 x 35mm	290-485-201
40 x 35mm	290-485-202
50 x 35mm	290-485-203

left

50 x 10mm	290-485-204
-----------	-------------



ROSS

Retractor, 270mm, 10^{2/3}"

Fig. 1 15 x 16mm	170-475-001
Fig. 2 13 x 23mm	170-475-002
Fig. 3 25 x 18mm	170-475-003
Fig. 4 29 x 13mm	170-475-004
Fig. 5 29 x 29mm	170-475-005
Fig. 6 35 x 21mm	170-475-006



DAVIDSON

Scapular Retractor, 160mm, 6^{1/4}"

75 x 50mm	170-463-001
75 x 90mm	170-463-002



CORYLLOS

Retractor, 240mm, 9^{1/2}"

82 x 22mm	170-461-001
108 x 43mm	170-461-002
115 x 65mm	170-461-003

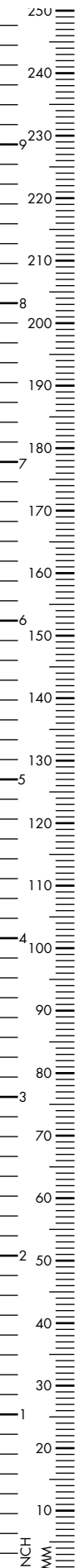



BOROWSKI

Retractor, malleable

17 x 21mm	290-485-301
16 x 23mm	290-485-302
20 x 25mm	290-485-303
24 x 27mm	290-485-304
28 x 20mm	290-485-305
28 x 29mm	290-485-306



ALLISON

Lung Spatula, 40mm

300mm, 11 ⁷ / ₈ "	290-505-300
53mm	
320mm, 12 ¹ / ₂ "	290-505-320

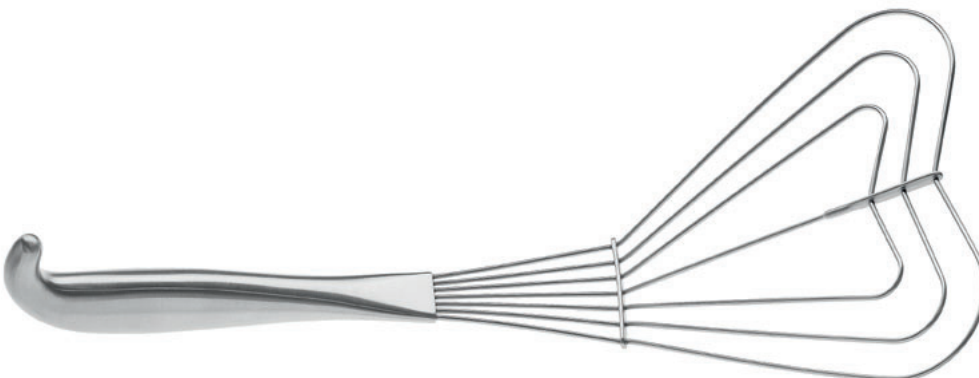

Lung Spatula

300mm, 11 ⁷ / ₈ "	290-511-260
---	-------------

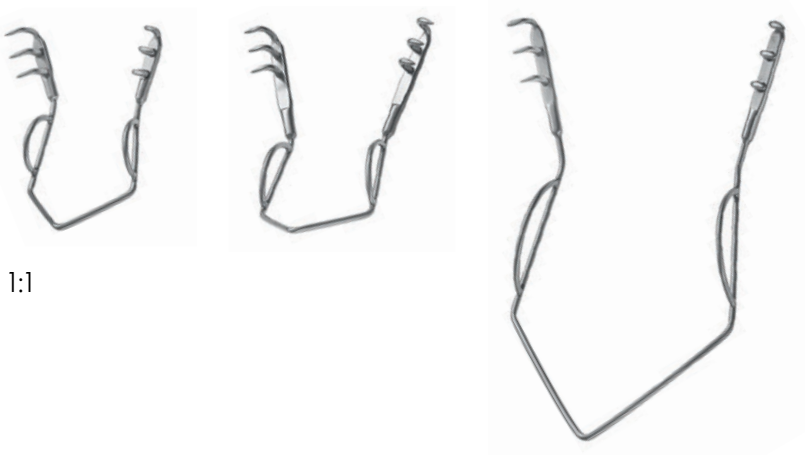

1:1

PARSONNET

Retractor, 3x3 teeth

25mm	290-233-025
32mm	290-233-030
50mm	290-233-047



A

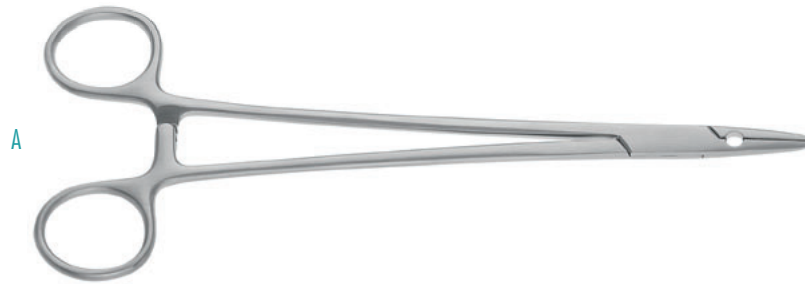

Valve Set

consisting of: 295-130-000

A Clamp

230mm 295-130-008

B Stick

190mm 295-130-001

C Valve

30 x 35mm 295-130-002

40 x 35mm 295-130-003

50 x 35mm 295-130-004

50 x 45mm 295-130-005

60 x 45mm 295-130-006

75 x 45mm 295-130-007

B



C



