

SUCTION TUBES



Suction Tubes



POOLE

Suction Tube, straight, 220mm, 8^{2/3}"

∅ 6mm 165-549-220

∅ 10mm 165-550-220

curved

∅ 6mm 165-552-220

∅ 10mm 165-551-220

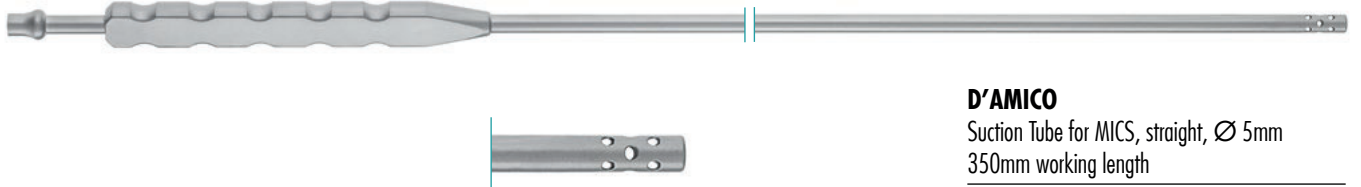

D'AMICO

Suction Tube for MICS, straight, ∅ 5mm
350mm working length

475mm, 18^{3/4}" 295-165-475



ANDREWS PYNCHON

Suction Tube, curved, ∅ 6mm

235mm, 9^{1/4}" 165-066-000

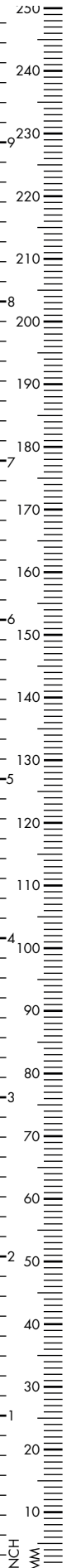

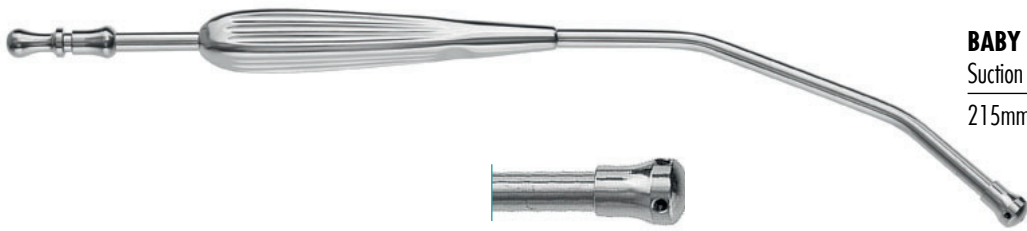

BABY YANKAUER

Suction Tube

215mm, 8¹/₂"

165-543-215

YANKAUER

Suction Tube

270mm, 10⁷/₈"

165-543-270

355mm, 14"

165-543-355

410mm, 16"

165-543-410

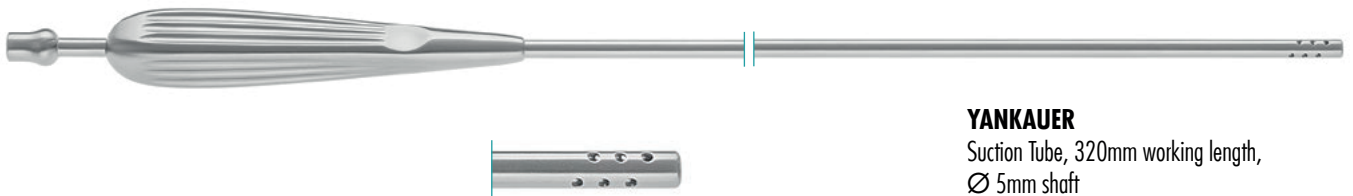

YANKAUER

Suction Tube, 320mm working length,
Ø 5mm shaft

450mm, 17³/₄"

165-544-450

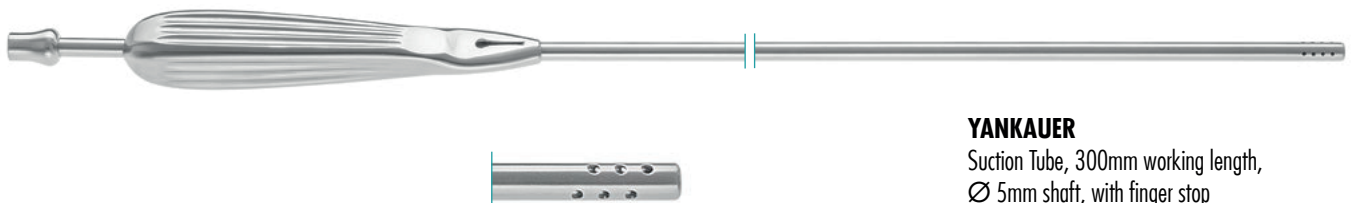

YANKAUER

Suction Tube, 300mm working length,
Ø 5mm shaft, with finger stop

435mm, 17¹/₈"

165-544-435



Olive only

165-543-000

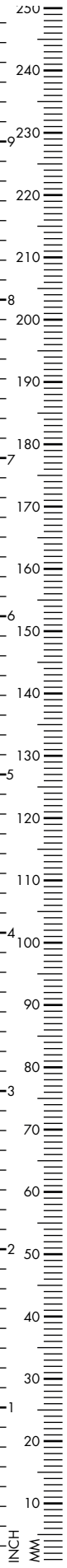

GRECO

Suction Tube, 90° angled,
basket detachable, 160mm, 6¹/₄"

Ø 3.3mm shaft	165-533-331
Ø 5.0mm shaft	165-533-330



GRECO

Suction Tube, 45° angled, 180mm, 7"

Ø 3.3mm shaft	165-533-321
Ø 5.0mm shaft	165-533-322



GRECO

Suction Tube, without basket,
60° angled, 180mm, 7"

Ø 3.3mm shaft	165-533-332
45° angled, 210mm, 8 ¹ / ₄ "	
Ø 3.3mm shaft	165-533-310
Ø 5.0mm shaft	165-533-311



A

DEBAKEY

A Suction Tube, lateral slots,
 \varnothing 9mm

280mm, 11" 165-065-270



B

B \varnothing 5mm

160mm, 6¹/₄" 165-065-160



COOLEY

Suction Tube, without basket, \varnothing 8mm

350mm, 14" 165-552-350

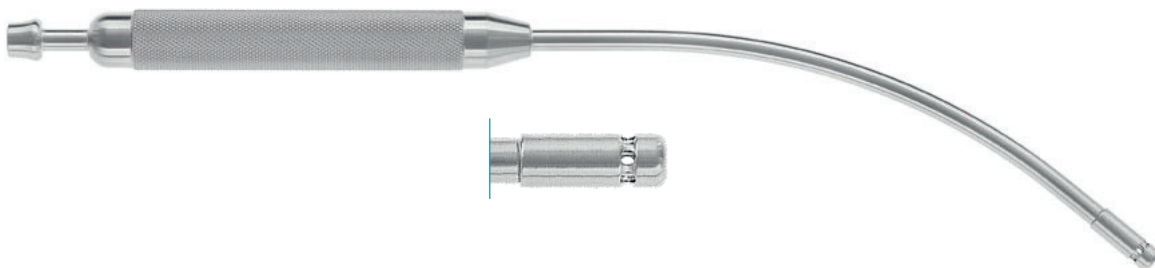

COOLEY

Suction Tube, with basket, \varnothing 7mm

300mm, 11⁷/₈" 165-552-300

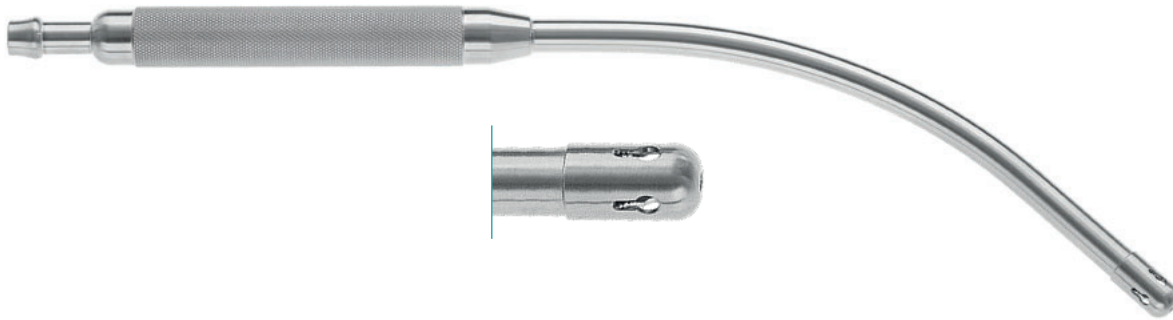

COOLEY

Suction Tube, \varnothing 10mm

310mm, 12^{1/4}"

165-552-310



COOLEY

Suction Tube, removable tube,
30°, \varnothing 8mm

330mm, 13"

165-552-330

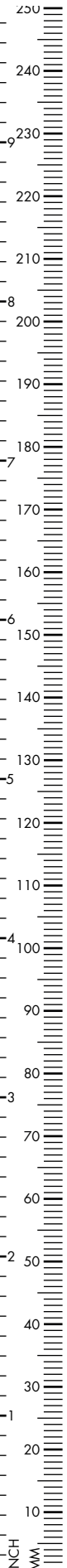

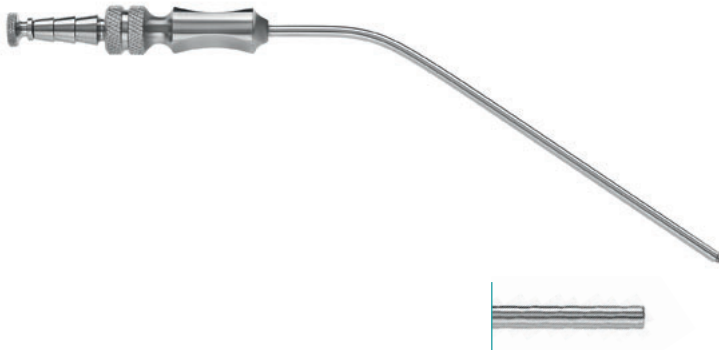

FRAZIER

Suction Tube, 190mm, 7¹/₂"

∅ 1.6mm, 5 Charr.	165-523-005
∅ 2.0mm, 6 Charr.	165-523-006
∅ 2.3mm, 7 Charr.	165-523-007
∅ 2.5mm, 8 Charr.	165-523-008
∅ 3.0mm, 9 Charr.	165-523-009
∅ 3.3mm, 10 Charr.	165-523-010
∅ 3.6mm, 11 Charr.	165-523-011
∅ 4.0mm, 12 Charr.	165-523-012
∅ 5.0mm, 15 Charr.	165-523-015

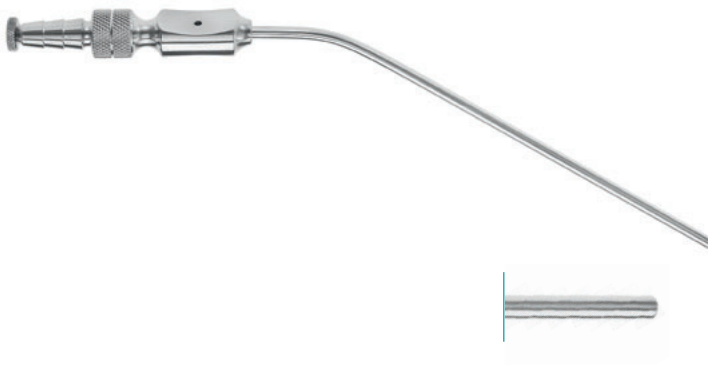

FERGUSSON

Suction Tube, 180mm, 7"

∅ 1.6mm, 5 Charr.	165-525-005
∅ 2.0mm, 6 Charr.	165-525-006
∅ 2.3mm, 7 Charr.	165-525-007
∅ 2.5mm, 8 Charr.	165-525-008
∅ 3.0mm, 9 Charr.	165-525-009
∅ 3.3mm, 10 Charr.	165-525-010
∅ 3.6mm, 11 Charr.	165-525-011
∅ 4.0mm, 12 Charr.	165-525-012
∅ 5.0mm, 15 Charr.	165-525-015

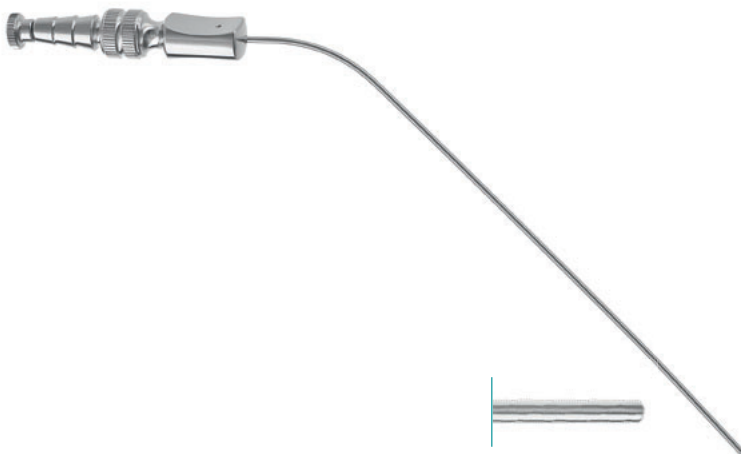

FERGUSSON

Suction Tube, 230mm, 9"

1 x 2.0mm, 5 Charr.	165-525-205
1 x 2.5mm, 7 Charr.	165-525-207
1 x 3.0mm, 9 Charr.	165-525-209
1 x 4.0mm, 12 Charr.	165-525-212



RANDALL

Suction Biopsy Curette, Ø 4mm

240mm, 9^{1/2}" 350-602-240



RHOTON MERZ

Suction Tube, curved down, 130mm, 5^{1/8}"

5 Charr. 165-066-005

7 Charr. 165-066-007

straight, 100mm, 4"

3 Charr. 165-067-003

5 Charr. 165-067-005

7 Charr. 165-067-007

10 Charr. 165-067-010

12 Charr. 165-067-012

angled, 130mm, 5^{1/8}"

5 Charr. 165-068-005

7 Charr. 165-068-007

10 Charr. 165-068-010

curved up, 130mm, 5^{1/8}"

5 Charr. 165-069-005

7 Charr. 165-069-007

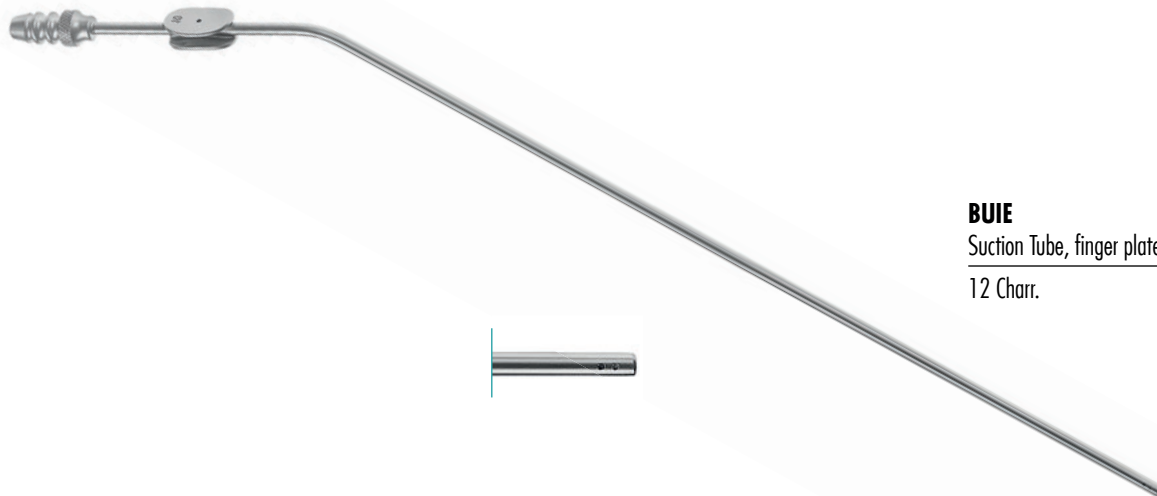

BUIE

Suction Tube, finger plate, 400mm, 15^{3/4}"

12 Charr. 165-530-012

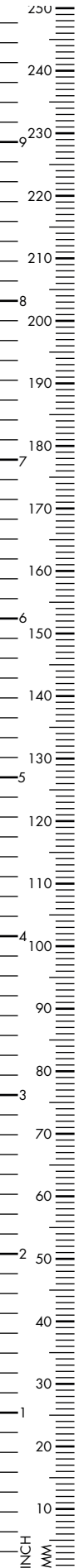



Suction Cannula, fibre-optic light carrier,
190mm, 7¹/₂"

10 Fr.	165-523-110
12 Fr.	165-523-112



YASARGIL

Suction Cannula, Ø 1.5mm

130mm, 5 ¹ / ₈ "	250-064-152
150mm, 6"	250-064-154
180mm, 7"	250-064-156
220mm, 8 ² / ₃ "	250-064-158

Ø 2.0mm

130mm, 5 ¹ / ₈ "	250-064-162
150mm, 6"	250-064-164
180mm, 7"	250-064-166
220mm, 8 ² / ₃ "	250-064-168

Ø 2.5mm

130mm, 5 ¹ / ₈ "	250-064-172
150mm, 6"	250-064-174
180mm, 7"	250-064-176
220mm, 8 ² / ₃ "	250-064-178

Ø 3.5mm

130mm, 5 ¹ / ₈ "	250-064-182
150mm, 6"	250-064-184
180mm, 7"	250-064-186
220mm, 8 ² / ₃ "	250-064-188

Ø 4.5mm

180mm, 7"	250-064-189
-----------	-------------

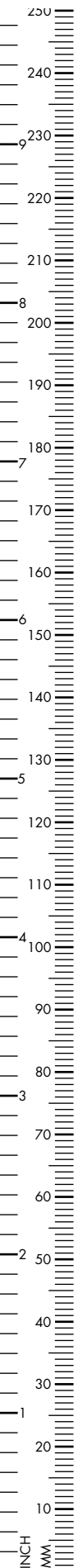

FUKUSHIMA

Suction Tube, conical, malleable,
165mm, 6^{1/2}"

3 Charr.	165-533-163
4 Charr.	165-533-164
5 Charr.	165-533-165
6 Charr.	165-533-166



FUKUSHIMA

Suction Tube, conical, malleable,
180mm, 7"

3 Charr.	165-533-183
4 Charr.	165-533-184
5 Charr.	165-533-185
6 Charr.	165-533-186
7 Charr.	165-533-187
8 Charr.	165-533-188
9 Charr.	165-533-189

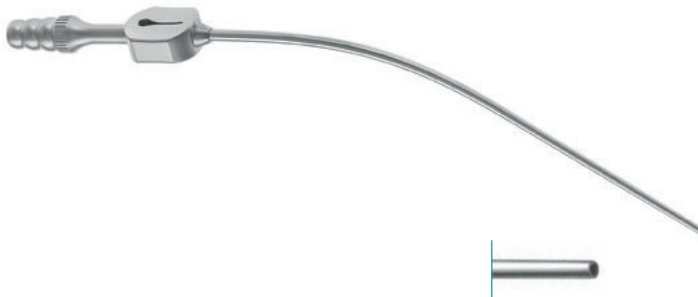

FUKUSHIMA

Suction Tube, conical, malleable,
205mm, 8^{1/8}"

3 Charr.	165-533-203
4 Charr.	165-533-204
5 Charr.	165-533-205
6 Charr.	165-533-206
7 Charr.	165-533-207
8 Charr.	165-533-208
9 Charr.	165-533-209
10 Charr.	165-533-210
12 Charr.	165-533-212

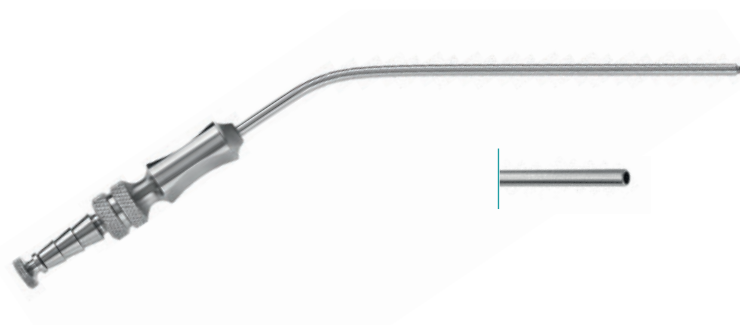

FRAZIER

Suction tube, 30° angled,
190mm, 7^{1/2}" overall length

5 Charr.	165-523-005
6 Charr.	165-523-006
7 Charr.	165-523-007
8 Charr.	165-523-008
9 Charr.	165-523-009
10 Charr.	165-523-010
11 Charr.	165-523-011
12 Charr.	165-523-012
15 Charr.	165-523-015



FRAZIER

Suction tube, straight,
130mm, 5^{1/8}" working length

6 Charr.	165-522-106
8 Charr.	165-522-108
10 Charr.	165-522-110
12 Charr.	165-522-112



BARON

Suction tube, finger cut-off, stylet, 100mm, 4"

3 Charr.	165-539-003
5 Charr.	165-539-005
7 Charr.	165-539-007



ADSON

Suction tube, Ø 4mm, 210mm, 8^{1/4}"

12 Charr.	165-521-004
-----------	-------------

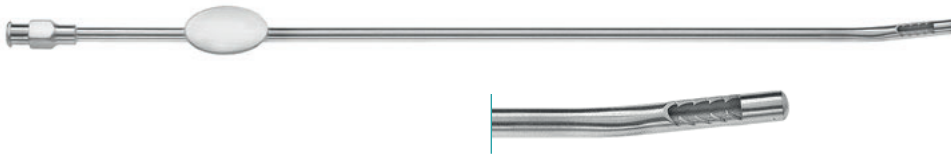
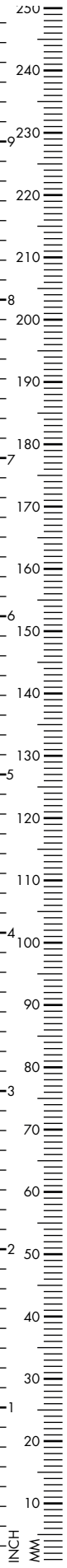

NOVAK

Biopsy Curette, 250mm, 9 7/8"

Ø 1mm	350-601-230
Ø 2mm	350-602-230
Ø 3mm	350-603-230
Ø 4mm	350-604-230



RANDALL

Suction Biopsy Curette, 240mm, 9 1/2"

Ø 1mm	350-601-240
Ø 4mm	350-602-240

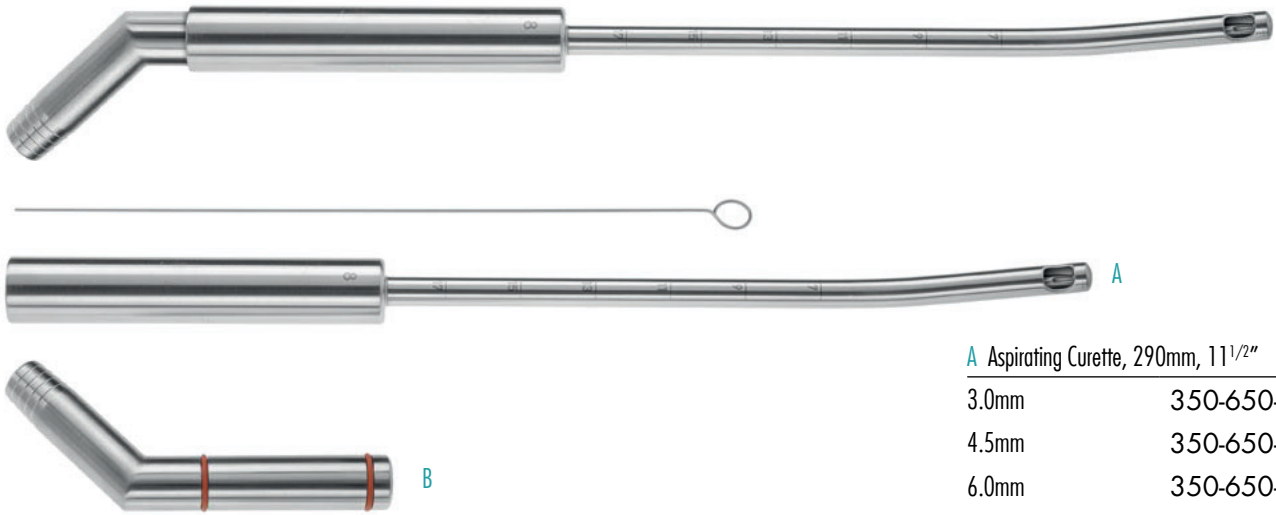

A Aspirating Curette, 290mm, 11 1/2"

3.0mm	350-650-030
4.5mm	350-650-045
6.0mm	350-650-060
8.0mm	350-650-080
10.0mm	350-650-100
12.0mm	350-650-120
14.0mm	350-650-140

B Coupling Piece

350-650-000

