

OBSTETRICS & GYNECOLOGY

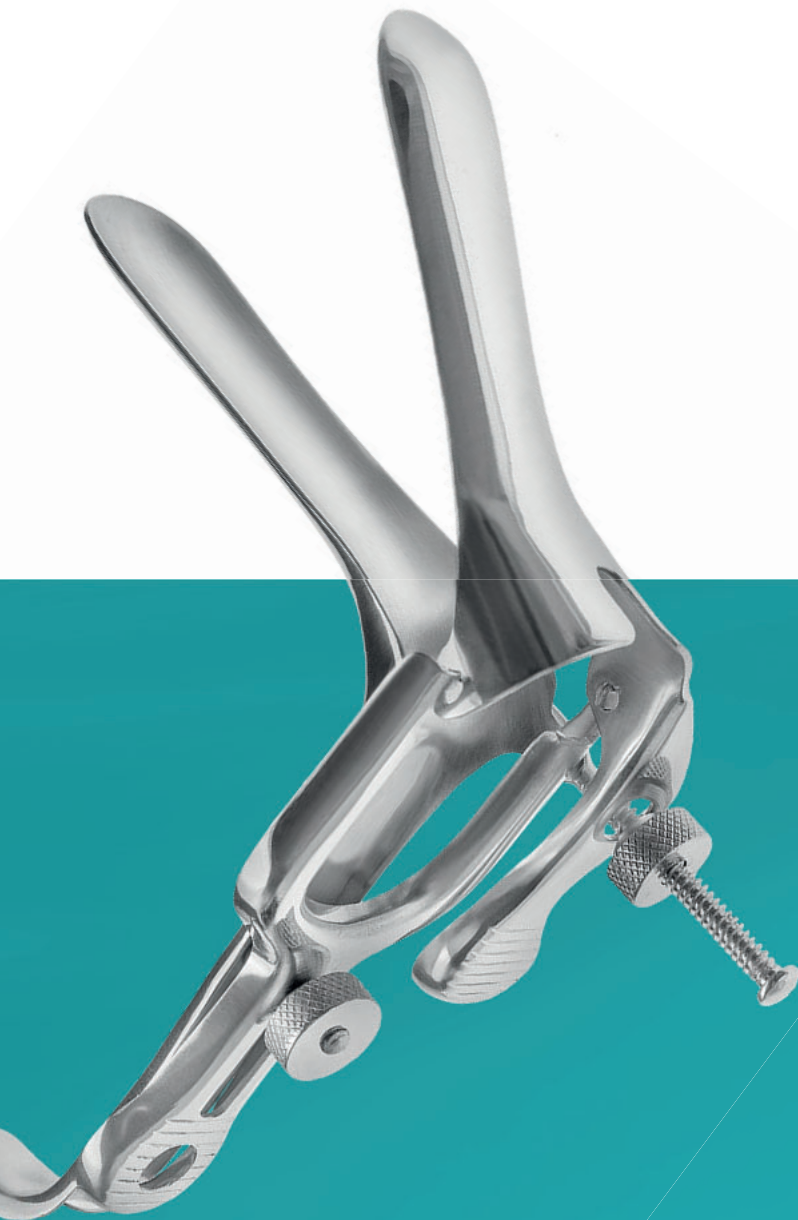

Scissors
Clamps and Forceps
Hysterectomy Forceps
Uterus Forceps
Tenaculum Forceps
Uterine / Placenta Forceps
Obstetrical Forceps
Myoma Screws
Curettes
Amniotome
Uterine Scoops/Curettes
Biopsy Forceps
Probes/Dilators
Retractors/Specula
Pelvimeter

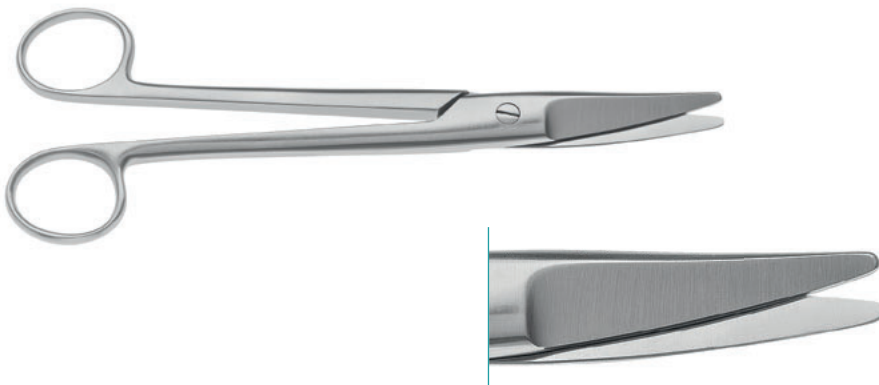

MAYO NOBLE

Scissors, curved

170mm, 6²/₃"

120-049-170

190mm, 7¹/₂"

120-049-190

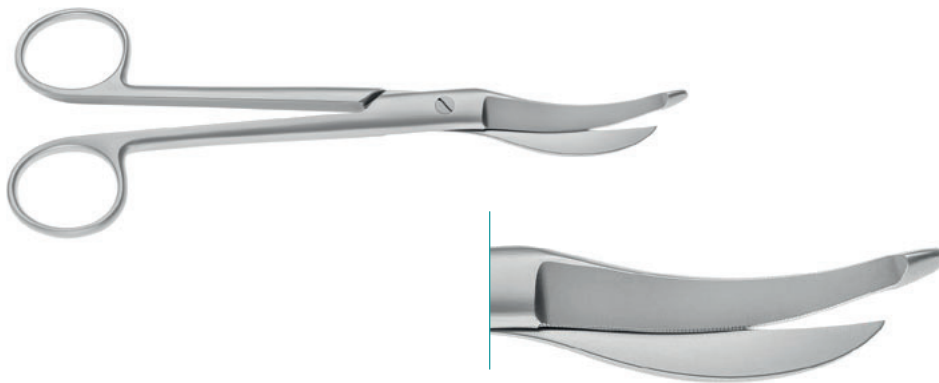

WALDMANN

Episiotomy Scissors, curved, serrated

180mm, 7"

120-231-180



BRAUN STADLER

Episiotomy Scissors

145mm, 5³/₄"

120-225-145

200mm, 8"

120-225-200

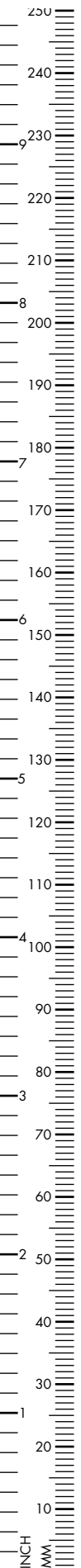

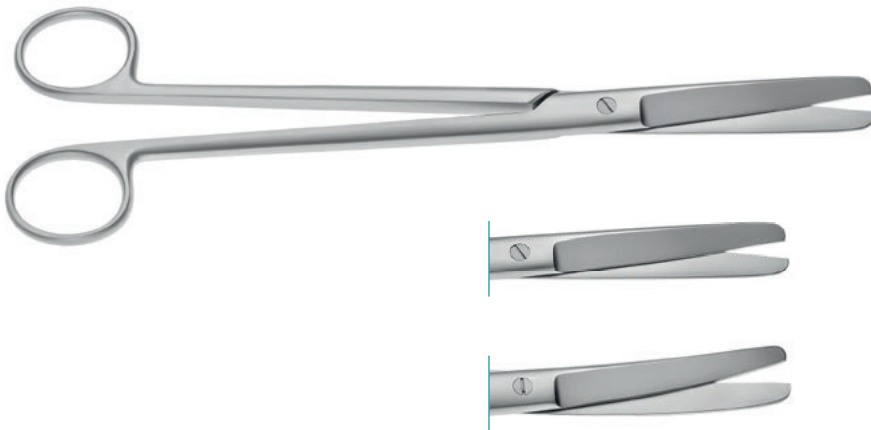

SIMS

Gynecological Scissors, straight, blunt/blunt

200mm, 8" 120-062-200

230mm, 9" 120-062-230

curved

200mm, 8" 120-063-200

230mm, 9" 120-063-230



SIEBOLD

Gynecological Scissors, s-curved

240mm, 9^{1/2}" 120-061-240

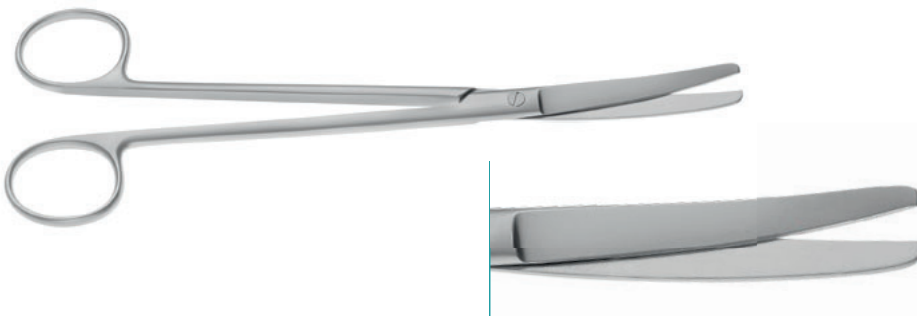

WERTHEIM

Preparation Scissors, curved

195mm, 7^{3/4}" 120-053-195

225mm, 8^{7/8}" 120-053-225

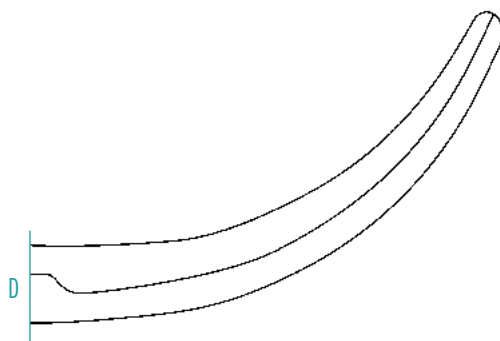
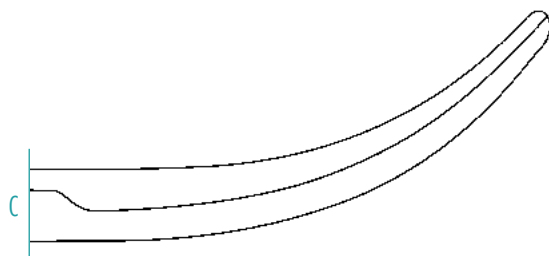
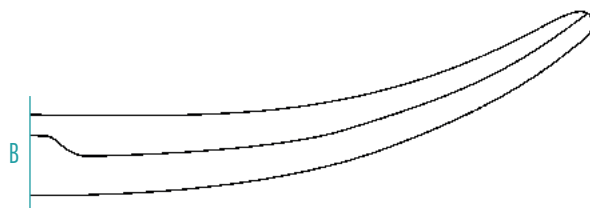

Parametrium Scissors, TC
230mm, 9"

A straight	120-537-001
B slightly curved	120-537-002
C strongly curved	120-537-003
D angled	120-537-004

265mm, 10^{1/2}"

A straight	120-536-001
B slightly curved	120-536-002
C strongly curved	120-536-003
D angled	120-536-004

Parametrium Scissors, TC
305mm, 12"

A straight	120-538-001
B slightly curved	120-538-002
C strongly curved	120-538-003
D angled	120-538-004

Parametrium Scissors, TC
350mm, 14"

A straight	120-539-001
B slightly curved	120-539-002
C strongly curved	120-539-003
D angled	120-539-004

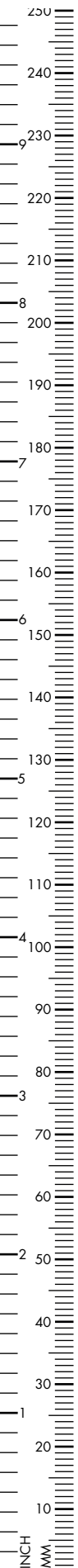



MODEL USA

Umbilical Cord Scissors

105mm, 4¹/₃"

120-233-105



BUSCH

Umbilical Cord Scissors, lateral curved

160mm, 6¹/₄"

120-229-160



SCHUMACHER

Umbilical Cord Scissors

160mm, 6¹/₄"

120-227-160

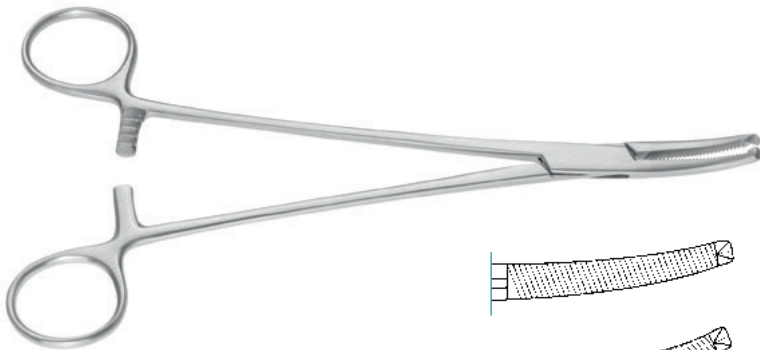

FAURE

Peritoneal Forceps, 200mm, 8"

Fig. 1 140-551-200
slightly curved

Fig. 2 140-553-200
strongly curved

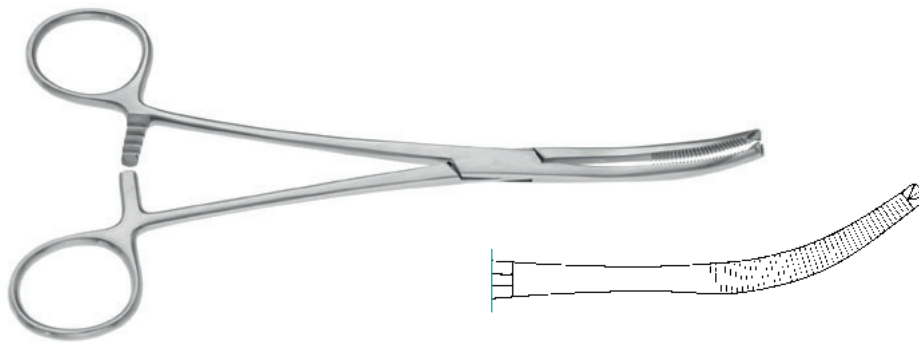

MIKULICZ

Peritoneal Forceps, strongly curved, 1x2 teeth

180mm, 7" 140-549-185

200mm, 8" 140-549-200

laterally curved, 1x2 teeth

180mm, 7" 140-549-180



MIKULICZ

Peritoneal Forceps, curved, 1x2 teeth

180mm, 7" 140-548-180

200mm, 8" 140-548-200

245mm, 9²/₃" 140-548-245

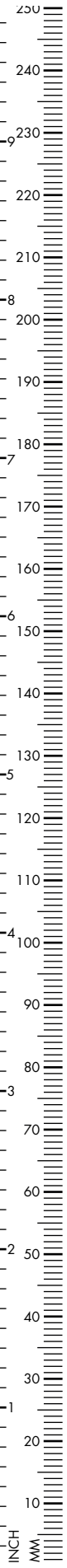

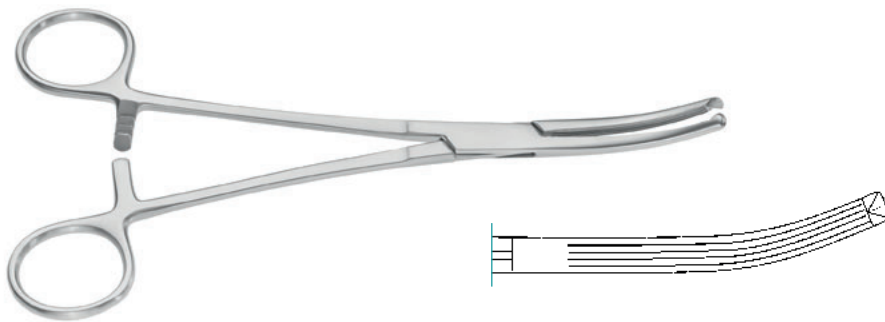

LONG

Hysterectomy Forceps, 1x2 teeth

190mm, 7^{1/2}"

140-652-190

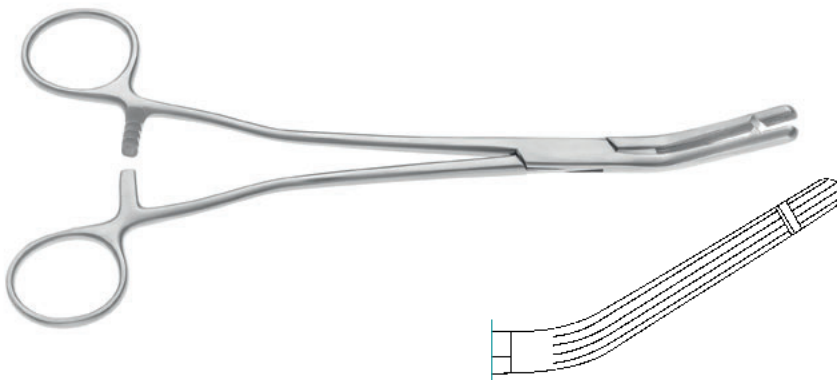

GARLAND

Hysterectomy Forceps, 1x2 teeth

210mm, 8^{1/4}"

140-639-210

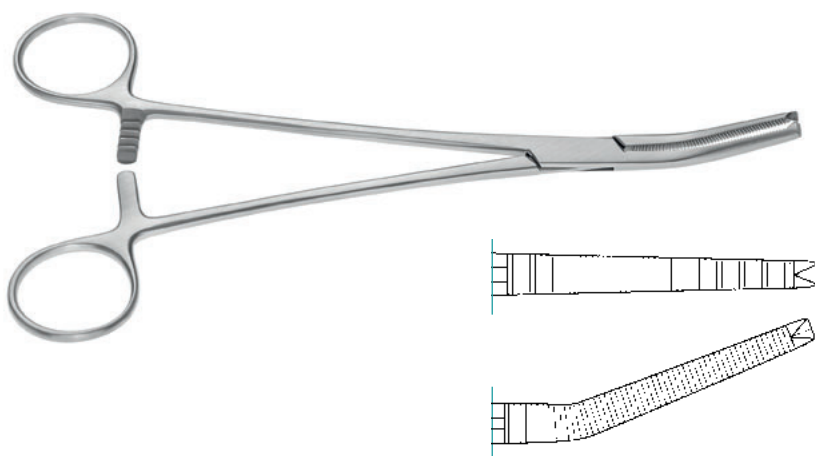

PHANEUF

Peritoneal Forceps, 1x2 teeth,
straight

215mm, 8^{1/2}"

140-520-210

curved

210mm, 8^{1/4}"

140-521-210

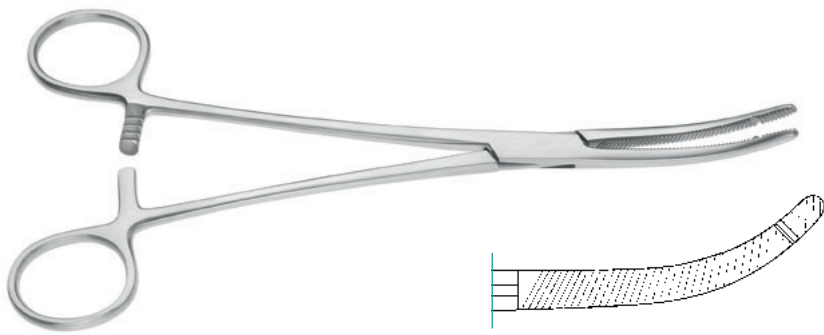

HEANEY

Hysterectomy Forceps, delicate, single tooth, curved

210mm, 8¹/₄"

140-612-210

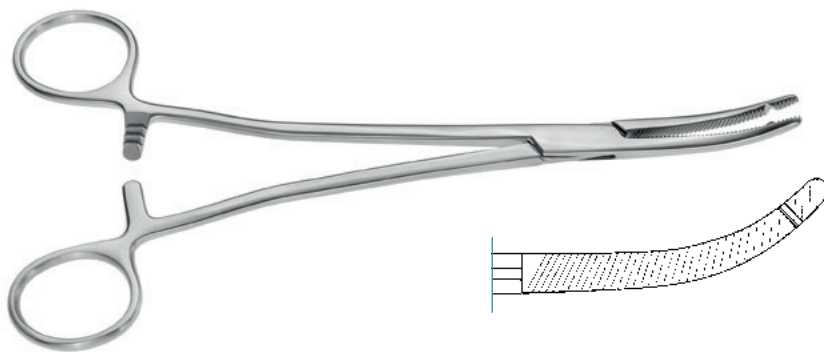

HEANEY

Hysterectomy Forceps, single tooth, curved

210mm, 8¹/₄"

140-613-210

230mm, 9"

140-613-230

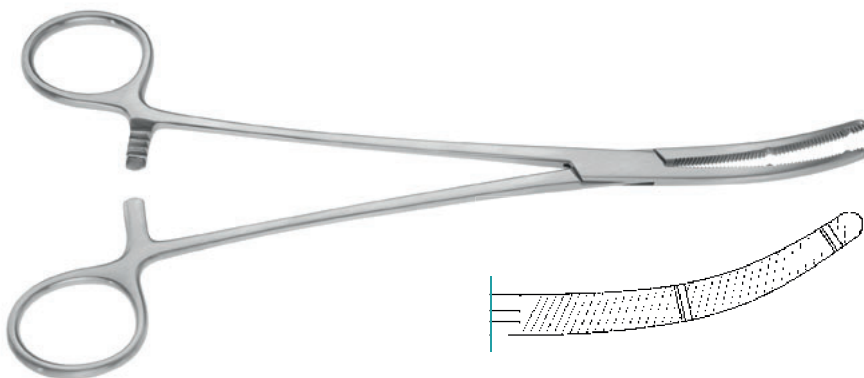

HEANEY

Hysterectomy Forceps, double tooth, curved

210mm, 8¹/₄"

140-615-210

230mm, 9"

140-615-230

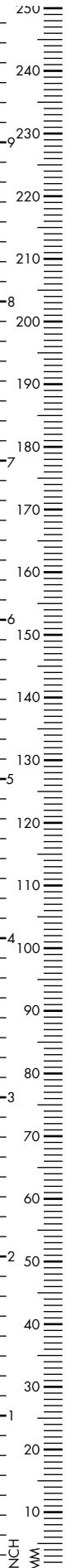

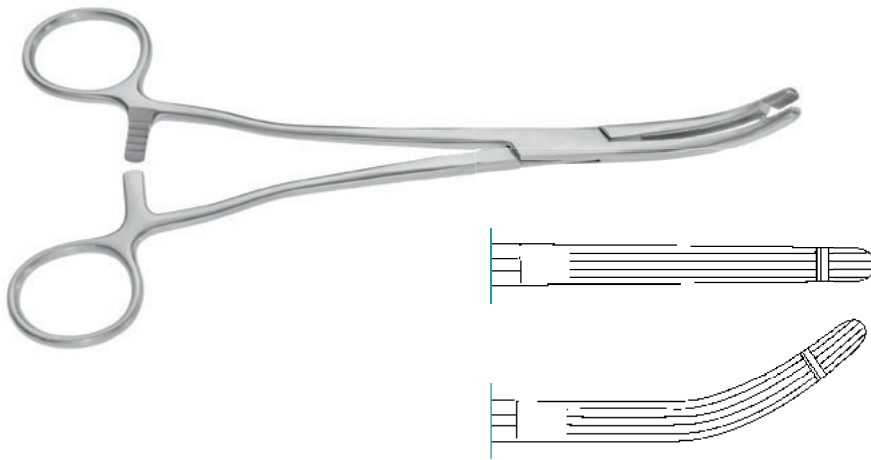

BALLANTINE

Hysterectomy Forceps, straight, single tooth

210mm, 8¹/₄" 140-617-210

300mm, 11⁷/₈" 140-617-300

curved

210mm, 8¹/₄" 140-618-210

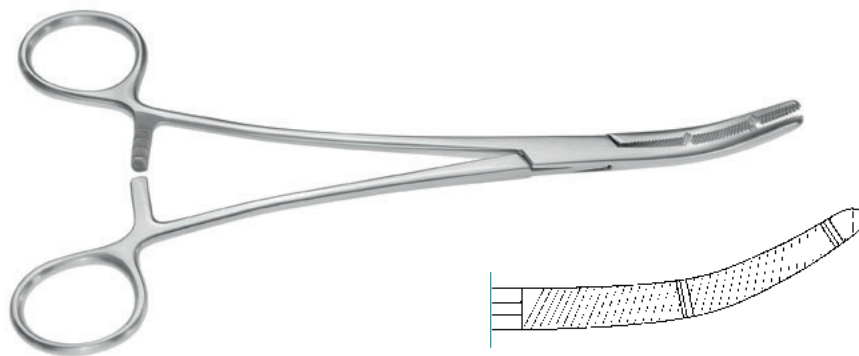

HEANEY KANTER

Hysterectomy Forceps, curved, single tooth

210mm, 8¹/₄" 140-619-210

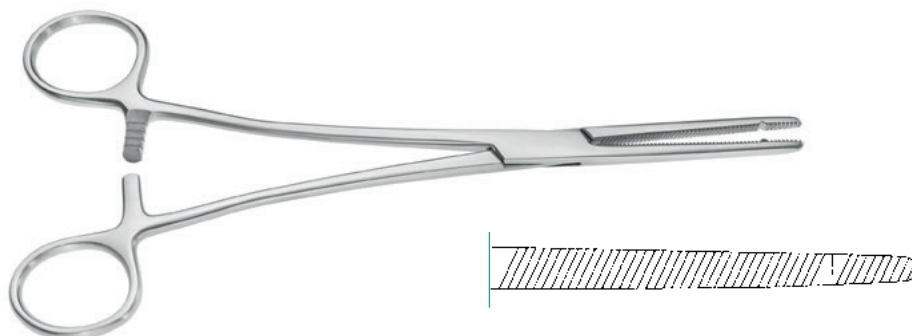

HEANEY REZEK

Hysterectomy Forceps, straight, single tooth

210mm, 8¹/₄" 140-627-210

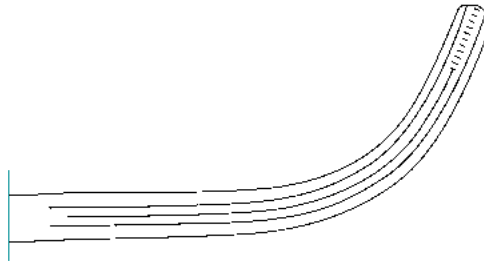

GUPTA FRANK

Forceps, s-curved, 80mm jaw length

240mm, 9¹/₂" 140-707-240

270mm, 10²/₃" 140-707-270

320mm, 12¹/₂" 140-707-320

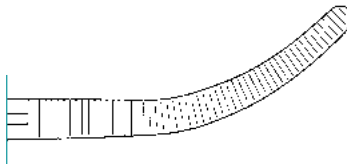
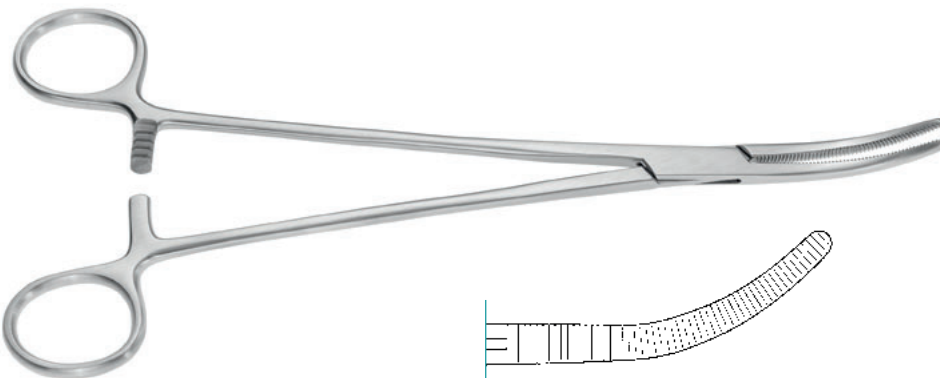

WERTHEIM

Hysterectomy Forceps, serrated, curved

250mm, 9⁷/₈" 140-697-250

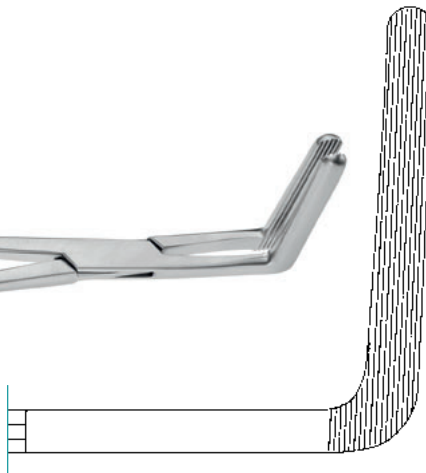
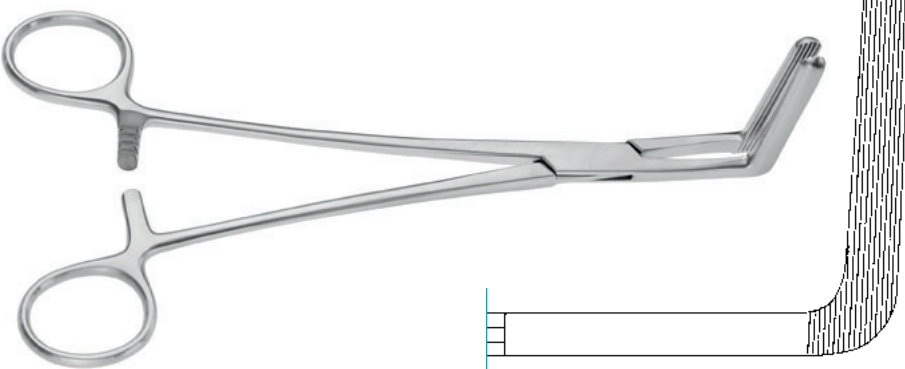

WERTHEIM CULLEN

Hysterectomy Forceps, 90° angled

215mm, 8¹/₂" 140-641-215

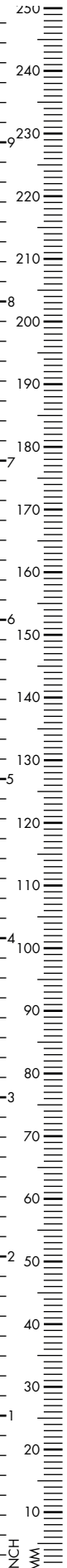

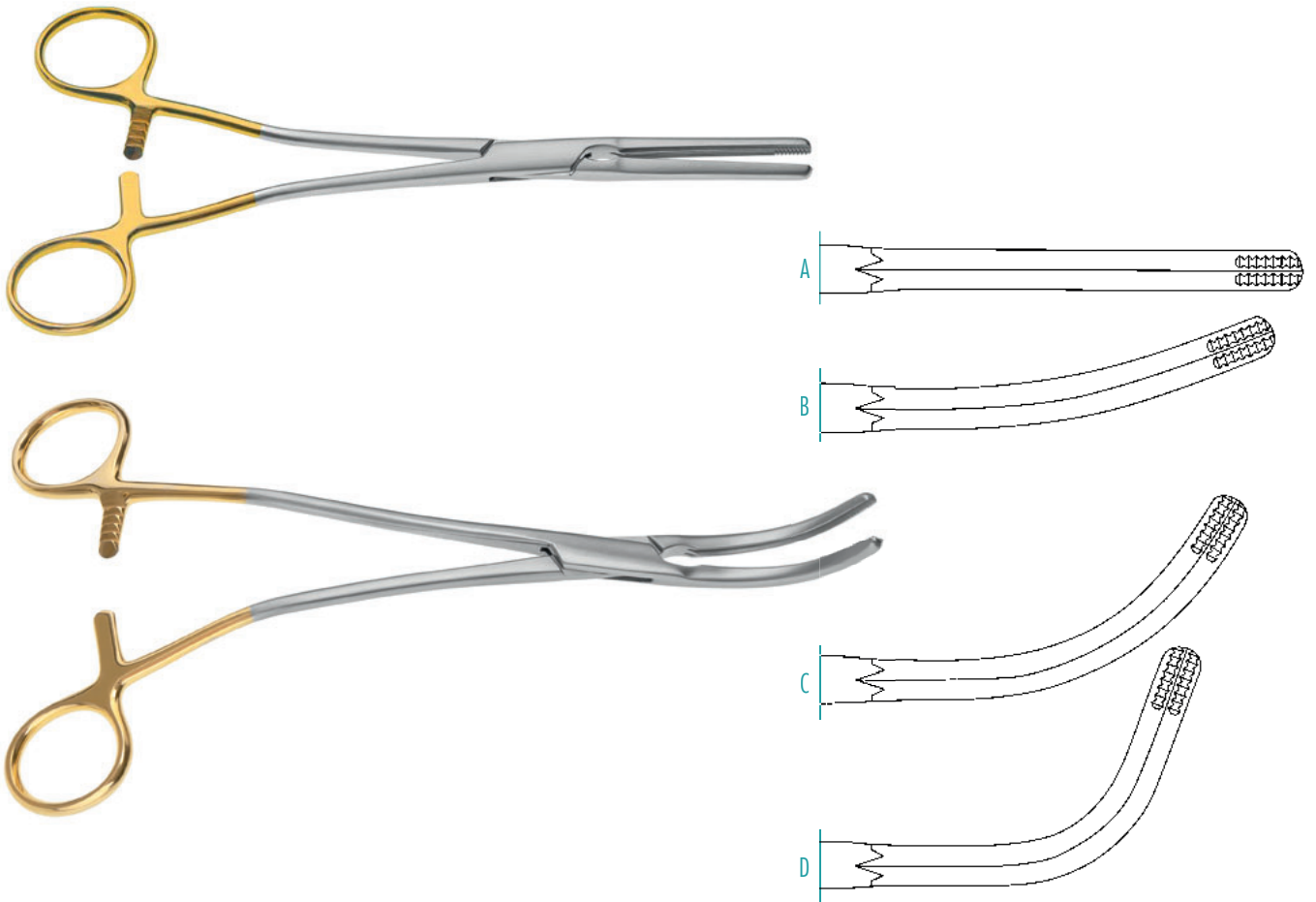

A Parametrium Forceps, straight

210mm, 8 ¹ / ₄ "	140-700-220
250mm, 9 ⁷ / ₈ "	140-700-250
305mm, 12"	140-700-305
355mm, 14"	140-700-350

B slightly curved

210mm, 8 ¹ / ₄ "	140-701-215
240mm, 9 ¹ / ₂ "	140-701-245
305mm, 12"	140-701-305
355mm, 14"	140-701-350

C strongly curved

210mm, 8 ¹ / ₄ "	140-702-210
240mm, 9 ¹ / ₂ "	140-702-245
305mm, 12"	140-702-305
355mm, 14"	140-702-350

D angled

210mm, 8 ¹ / ₄ "	140-703-205
240mm, 9 ¹ / ₂ "	140-703-245
305mm, 12"	140-703-305
355mm, 14"	140-703-350



A straight, angled shanks

210mm, 8 ¹ / ₄ "	141-700-220
240mm, 9 ¹ / ₂ "	141-700-250

B slightly curved, angled shanks

210mm, 8 ¹ / ₄ "	141-701-215
240mm, 9 ¹ / ₂ "	141-701-245

C strongly curved, angled shanks

210mm, 8 ¹ / ₄ "	141-702-210
240mm, 9 ¹ / ₂ "	141-702-245

D angled, angled shanks

210mm, 8 ¹ / ₄ "	141-703-210
245mm, 9 ² / ₃ "	141-703-245

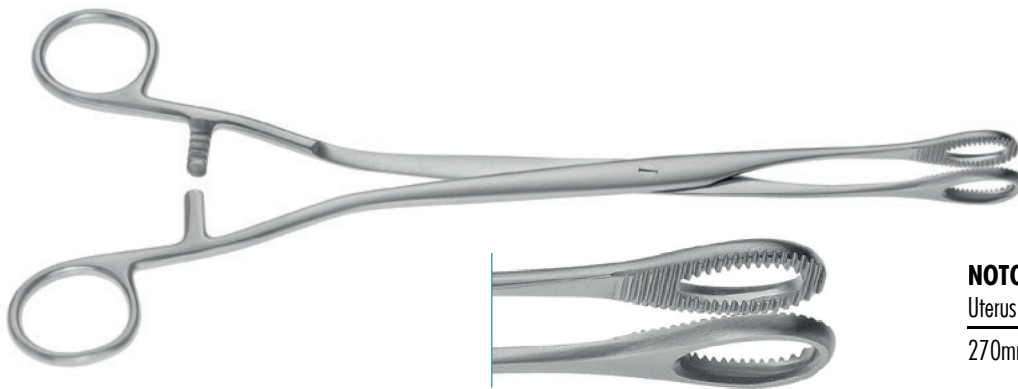

NOTO

Uterus Polypus Forceps

270mm, 10²/₃"

350-492-270

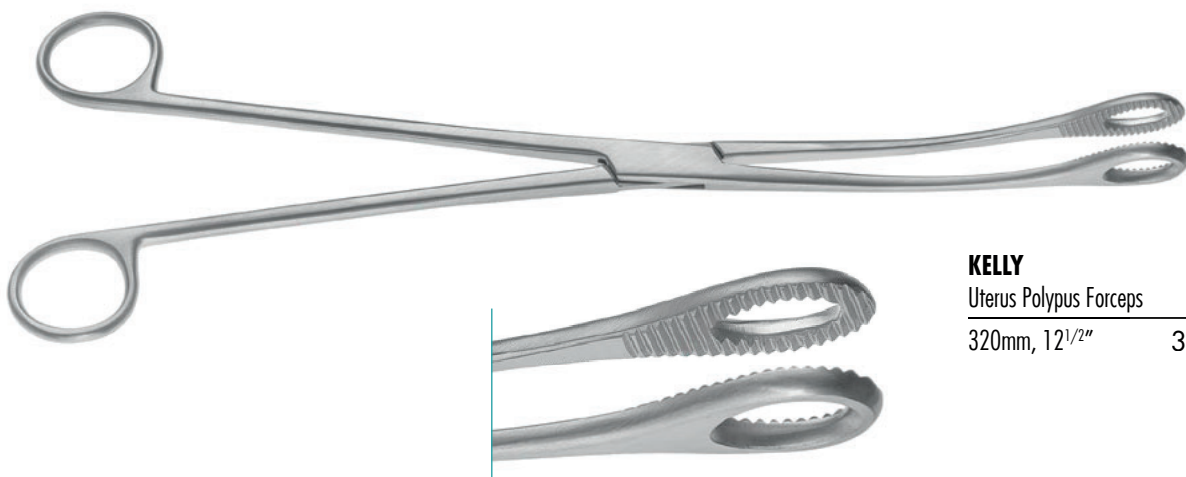

KELLY

Uterus Polypus Forceps

320mm, 12¹/₂"

350-490-320

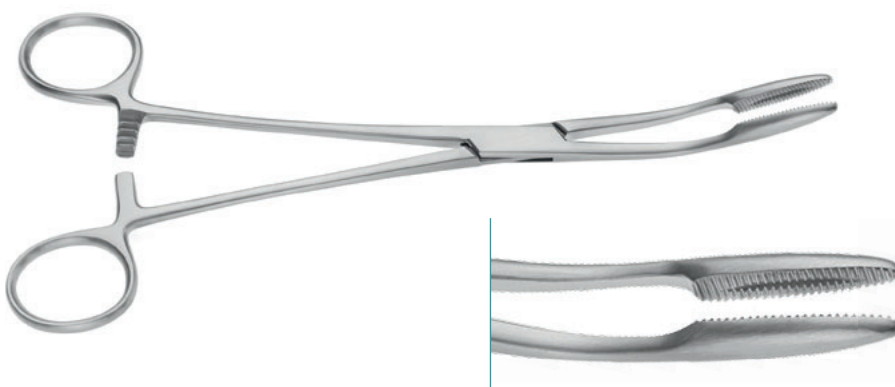

GROSS MAIER

Swab Forceps, curved

220mm, 8²/₃"

150-031-220

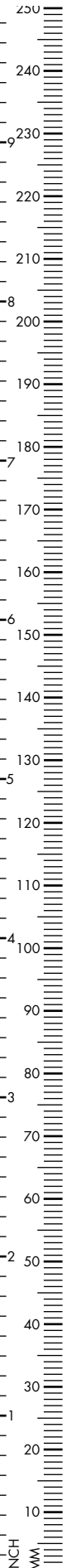

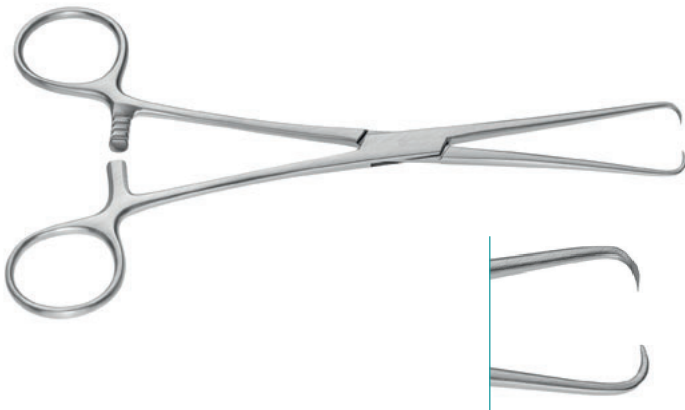

BARRETT

Tenaculum Forceps

180mm, 7"

350-426-180

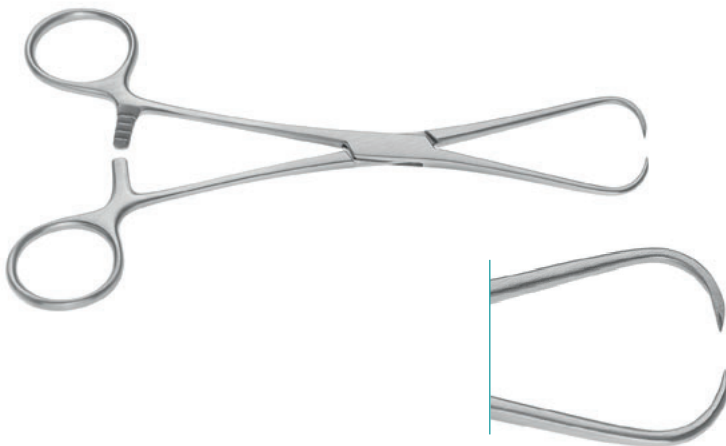

STAUDE MOORE

Tenaculum Forceps

170mm, 6²/₃"

350-422-170

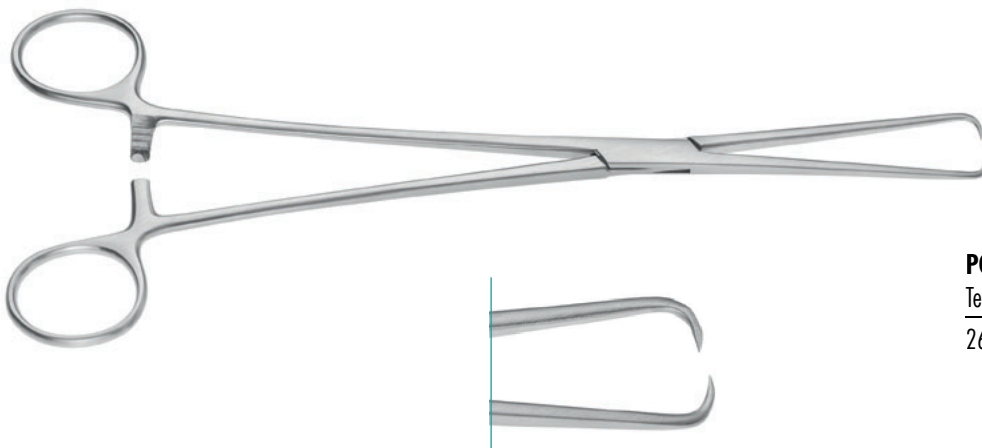

POZZI

Tenaculum Forceps

260mm, 10¹/₄"

350-420-260

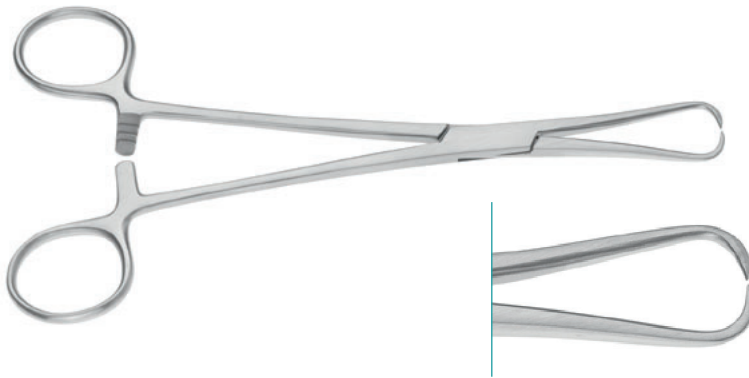
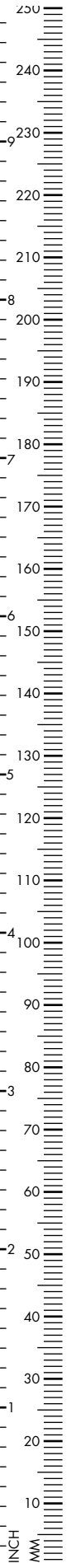

ADAIR

Tenaculum Forceps

190mm, 7^{1/2}"

350-426-190

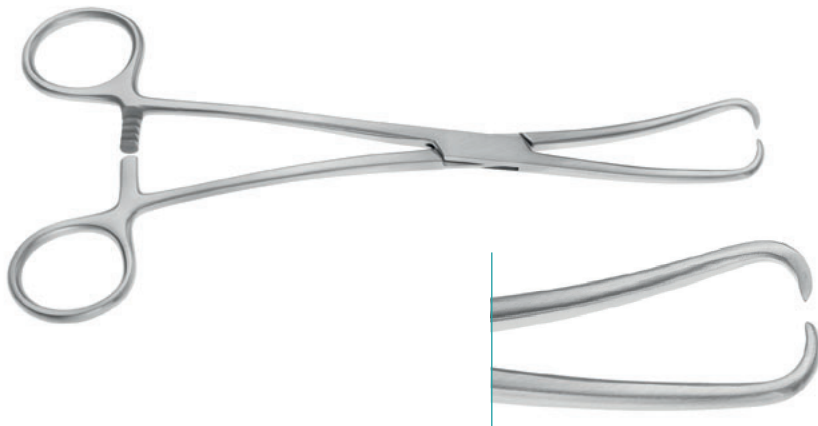

JARCHO

Tenaculum Forceps

200mm, 8"

350-427-200

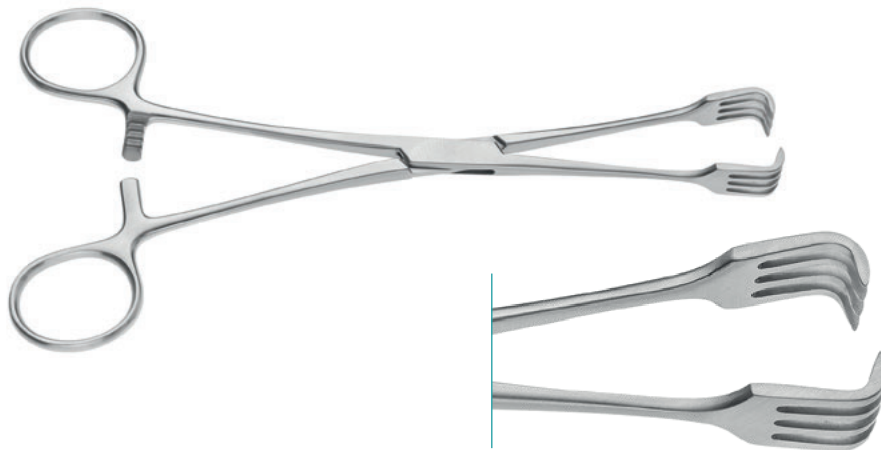

CZERNY

Tenaculum Forceps, straight

205mm, 8^{1/8}"

350-480-205

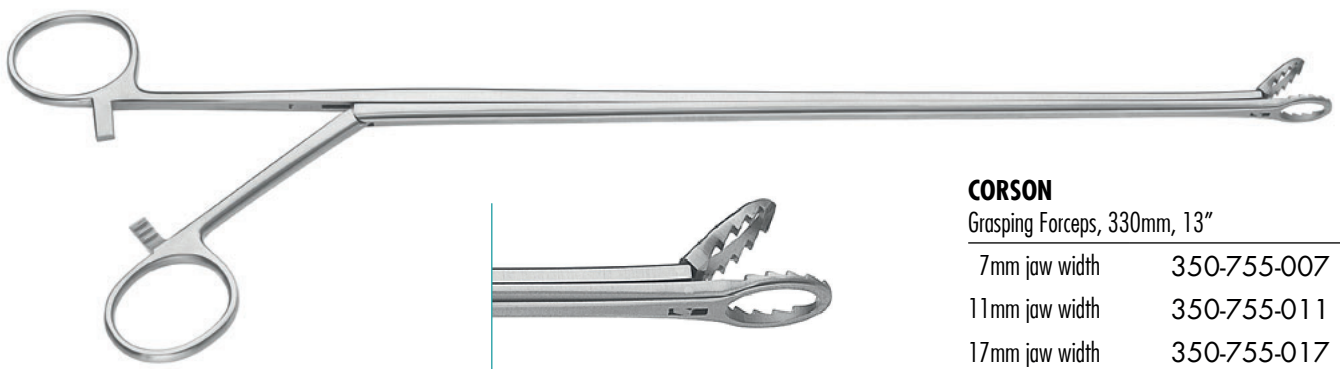

CORSON

Grasping Forceps, 330mm, 13"

7mm jaw width

350-755-007

11mm jaw width

350-755-011

17mm jaw width

350-755-017

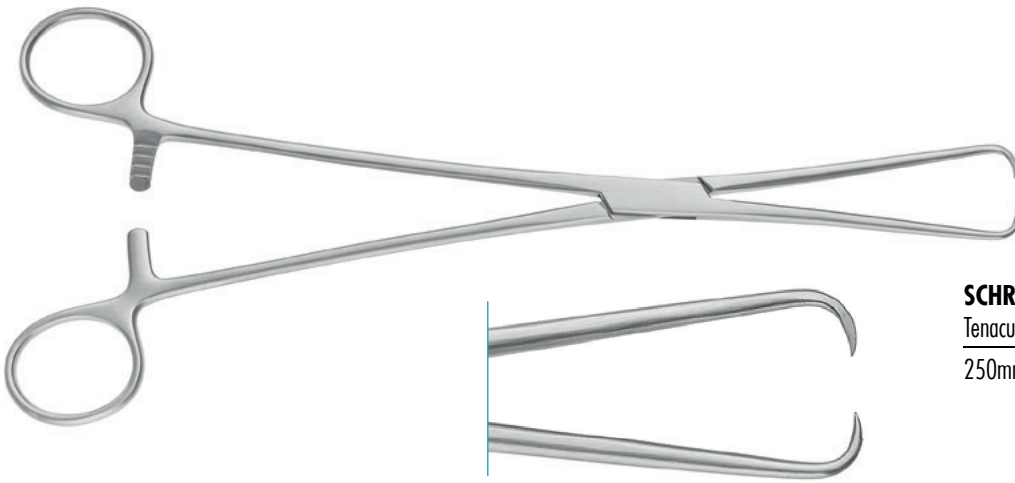

SCHROEDER

Tenaculum Forceps

250mm, 9⁷/₈"

350-400-250

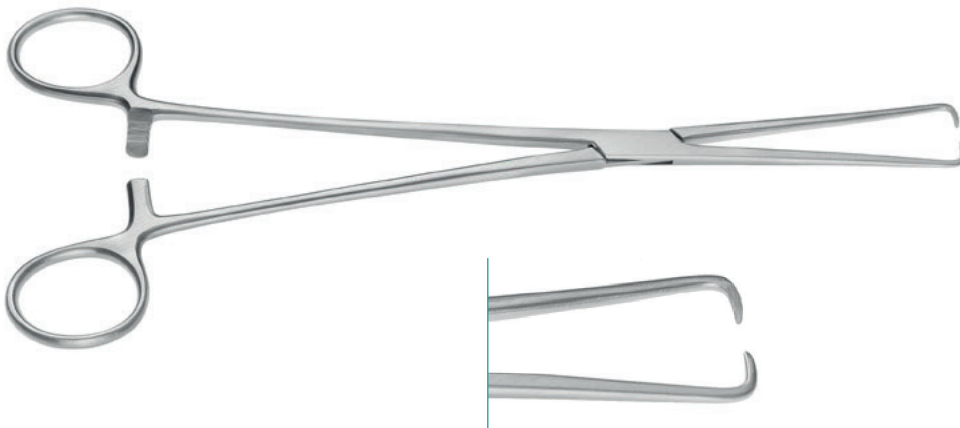

BRAUN

Tenaculum Forceps

250mm, 9⁷/₈"

350-410-250

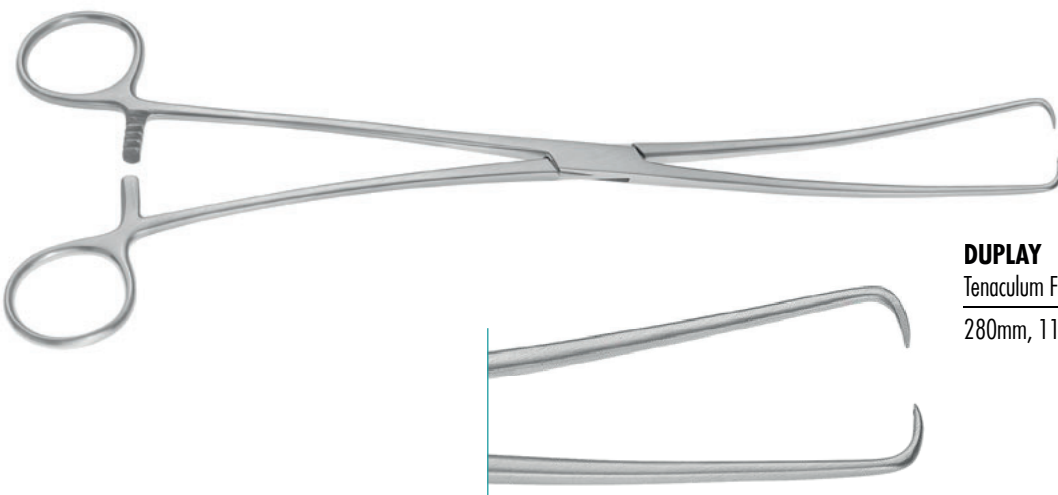

DUPLAY

Tenaculum Forceps

280mm, 11"

350-428-280



HULKA

Uterine Manipulator Tenaculum Forceps

290mm, 11^{1/2}" 350-302-290

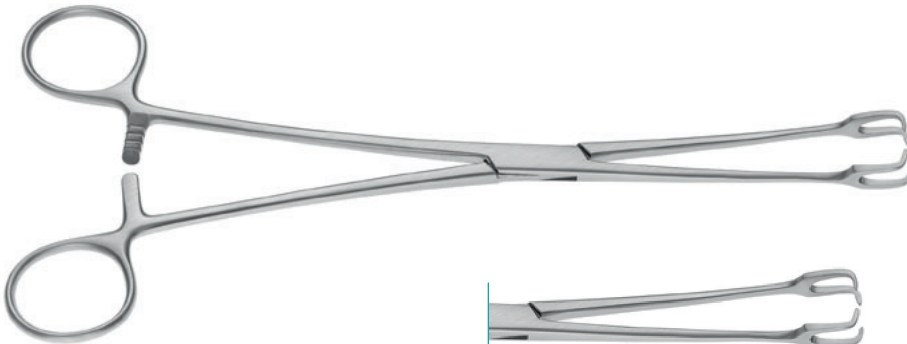

SCHROEDER

Tenaculum Forceps, 2 teeth, 240mm, 9^{1/2}"

straight 350-440-240

curved 350-441-240

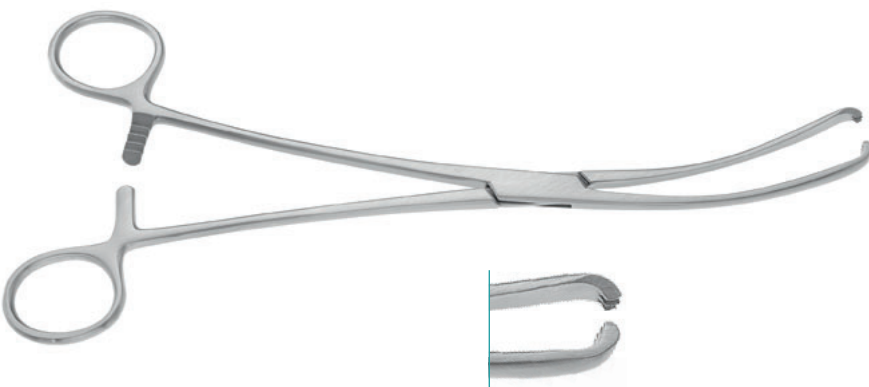

TEALE

Tenaculum Forceps, laterally curved, 3x4 teeth

230mm, 9" 350-443-230

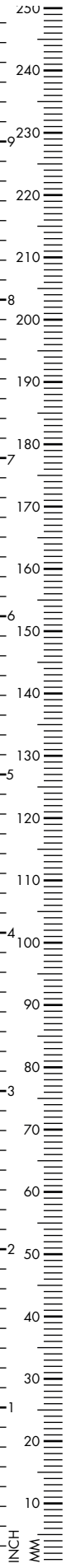

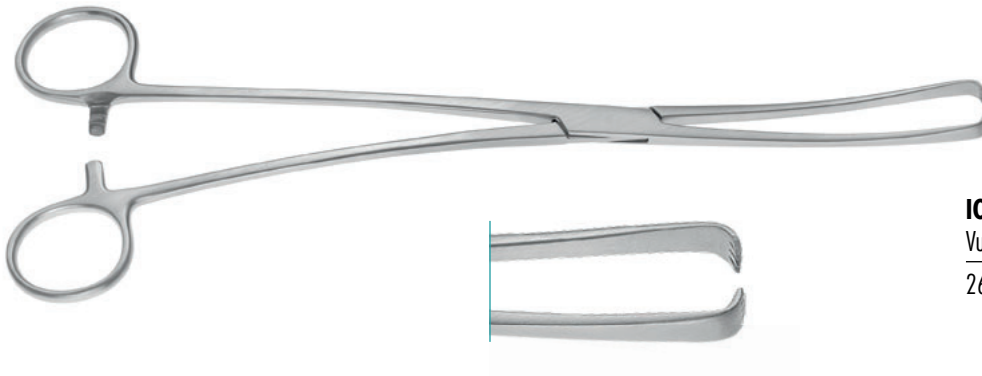

IOWA

Vulsellum Forceps

260mm, 10¹/₄"

350-445-260

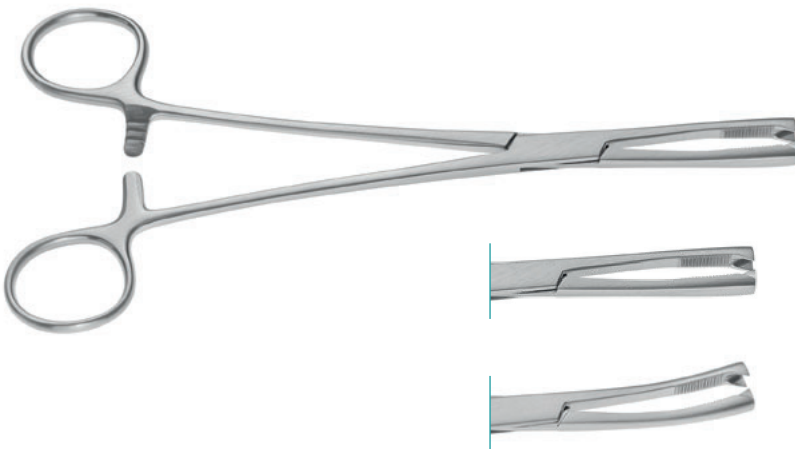

JACOBS

Tenaculum Forceps, 2x2 teeth, 210mm, 8¹/₄"

straight

350-470-210

curved

350-471-210

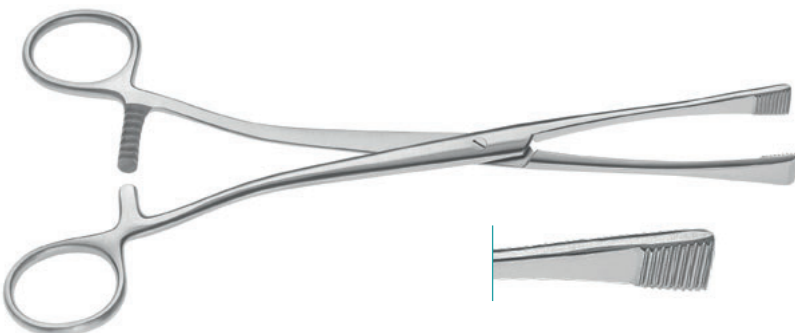

GREEN ARMYTAGE

Caesarean Forceps, straight,
15mm wide serrated jaw

210mm, 8¹/₄"

340-150-210

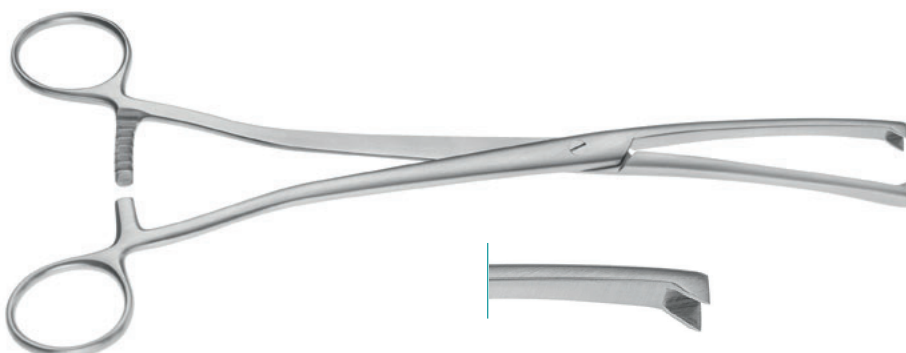

MUSEUX

Forceps, 2x2 teeth, 8mm jaw
240mm, 9¹/₂" working length

straight

350-452-240

curved

350-453-240

10mm jaw

straight

350-454-240

curved

350-455-240



DARTIGUES

Uterine Elevating Forceps

270mm, 10²/₃" 350-493-270



SOMER

Uterine Elevating Forceps

230mm, 9" 350-493-230



COLLIN

Uterine Forceps

250mm, 9⁷/₈" 350-493-250

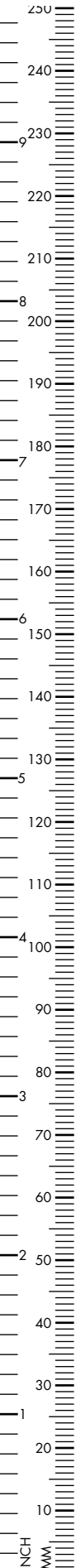



SAENGER

Placenta and Ovum Forceps,
270mm, 10²/₃"

straight	340-798-270
curved	340-799-270



Fig. 1

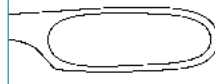

Fig. 2



WINTER

Placenta and Ovum Forceps, Fig. 2

280mm, 11"	340-799-280
------------	-------------

Placenta and Ovum Forceps, 280mm, 11"

Fig. 1	340-800-280
--------	-------------

Fig. 2	340-802-280
--------	-------------

Fig. 1 curved	
---------------	--

280mm, 11"	340-801-280
------------	-------------



BIERER

Ovum Forceps, curved, 16mm jaw,
280mm, 11"

without ratchet	350-496-330
-----------------	-------------

with ratchet	350-497-330
--------------	-------------



WRIGLEY

Obstetrical Forceps

280mm, 11"

340-011-280



SIMPSON

Obstetrical Forceps

300mm, 11^{7/8}"

340-013-300



SIMPSON BRAUN

Obstetrical Forceps

330mm, 13"

340-012-330

360mm, 14"

340-012-360



SIMPSON LUIKART

Obstetrical Forceps

360mm, 14"	340-029-360
------------	-------------



DE LEE

Obstetrical Forceps

300mm, 11 ⁷ / ₈ "	340-018-300
360mm, 14"	340-018-360



ELLIOT

Obstetrical Forceps

380mm, 15"

340-025-380



KIELLAND LUIKART

Obstetrical Forceps

400mm, 15³/₄"

340-016-400



KIELLAND

Obstetrical Forceps

410mm, 16¹/₈"

340-014-410

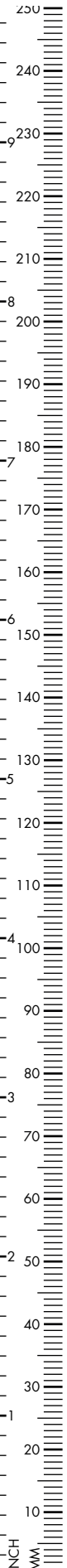



DOYEN

Myoma screw

170mm

working length

350-757-190

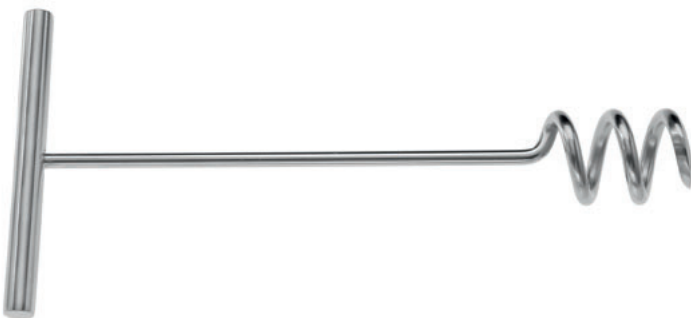

DOYEN

Myoma screw

170mm working
length

350-759-170

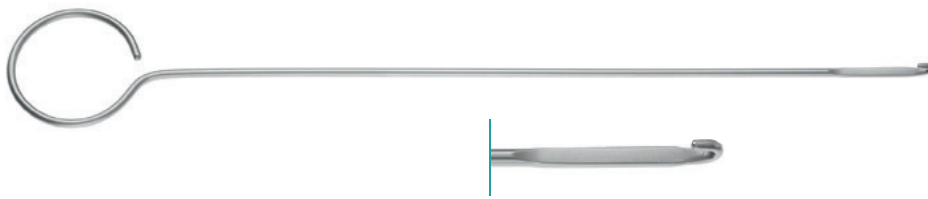

Simple IUD hook with ring handle, malleable
250mm, 9⁷/₈" 350-766-001



Double IUD Extractor
270mm, 10²/₃" 350-766-010



SAUNDERS
IUD Removing Hook
250mm, 9⁷/₈" 350-766-100



EMMET
Fistula Hook, 220mm, 8²/₃"

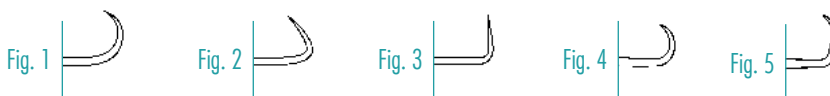
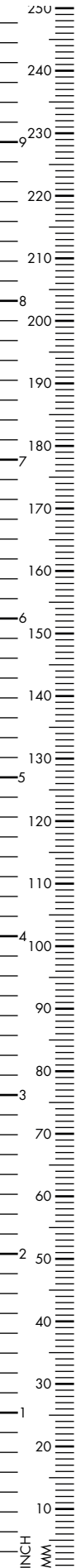

Fig. 1 350-765-001
Fig. 2 350-765-002
Fig. 3 350-765-003
Fig. 4 350-765-004
Fig. 5 350-765-005





NOVAK

Biopsy Curette, 250mm, 9⁷/₈"

Ø 1mm	350-601-230
Ø 2mm	350-602-230
Ø 3mm	350-603-230
Ø 4mm	350-604-230

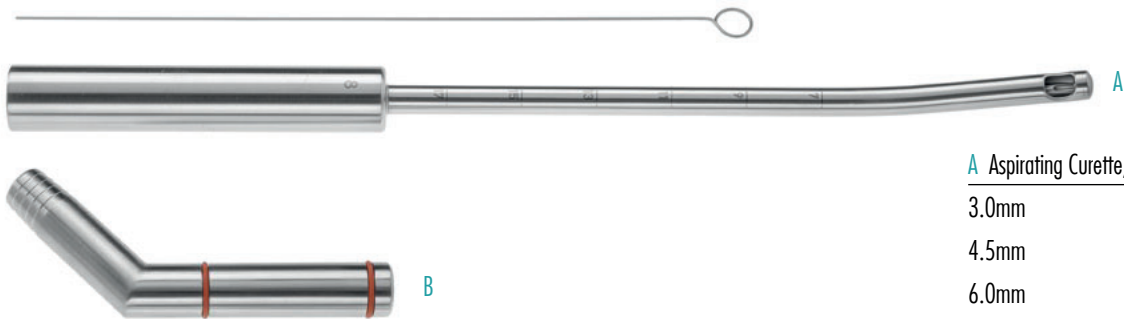

A Aspirating Curette, 290mm, 11¹/₂"

3.0mm	350-650-030
4.5mm	350-650-045
6.0mm	350-650-060
8.0mm	350-650-080
10.0mm	350-650-100
12.0mm	350-650-120
14.0mm	350-650-140

B Coupling Piece

350-650-000



RANDALL

Suction Biopsy Curette, 240mm, 9¹/₂"

Ø 4mm

350-602-240

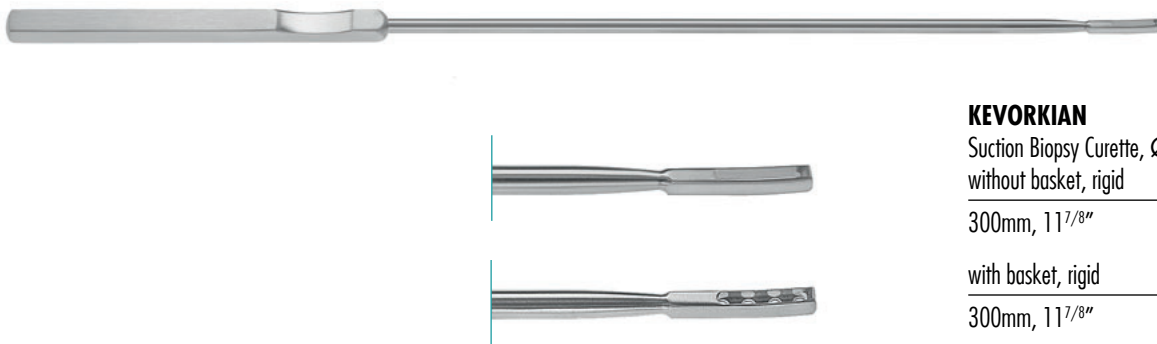

KEVORKIAN

Suction Biopsy Curette, Ø 4mm,
without basket, rigid

300mm, 11⁷/₈"

350-599-300

with basket, rigid

300mm, 11⁷/₈"

350-600-300

with basket, malleable

300mm, 11⁷/₈"

350-601-300

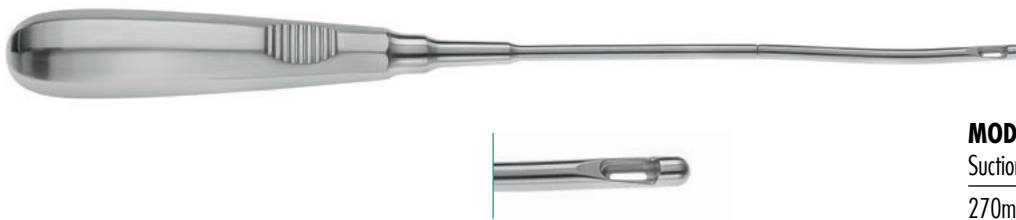

MOD. MÜNCHEN

Suction Biopsy Curette, Ø 4mm

270mm, 10²/₃"

350-605-270

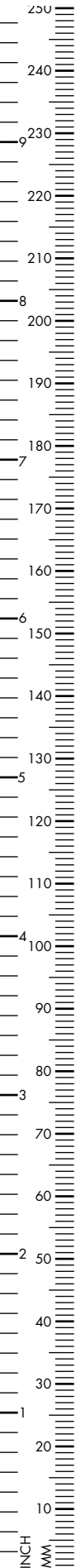

**BEACHAM**

Amniotome

260mm, 10¹/₄"

350-429-260

**BRAUN**

Uterine Depressor

280mm, 11"

350-399-280

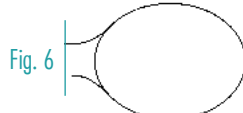
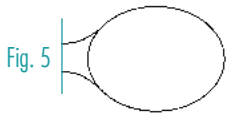

SIMON

Uterine Scoop, sharp, 240mm, 9¹/₂"

Fig. 1, 7.0mm	350-610-001
Fig. 2, 8.5mm	350-610-002
Fig. 3, 9.5mm	350-610-003
Fig. 4, 11.5mm	350-610-004
Fig. 5, 13.0mm	350-610-005
Fig. 6, 14.5mm	350-610-006

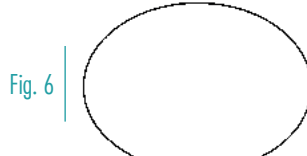
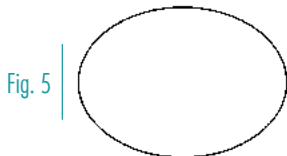
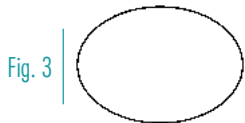

SCHROEDER

Uterine Scoop, sharp, 300mm, 11⁷/₈"

Fig. 1, 6.8mm	350-612-001
Fig. 2, 8.5mm	350-612-002
Fig. 3, 10.0mm	350-612-003
Fig. 4, 11.5mm	350-612-004
Fig. 5, 13.0mm	350-612-005
Fig. 6, 14.5mm	350-612-006

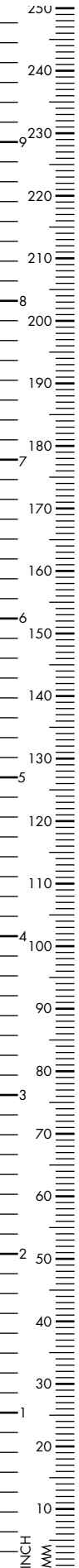

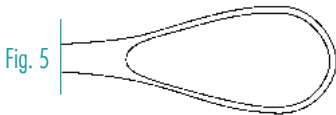
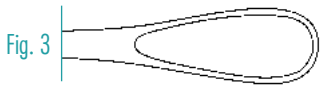
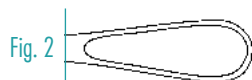
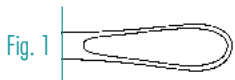

GOURDET

Uterine Scoop, blunt, 280mm, 11"

Fig. 1, 6mm	350-613-006
Fig. 2, 8mm	350-613-008
Fig. 3, 10mm	350-613-010
Fig. 4, 12mm	350-613-012
Fig. 5, 14mm	350-613-014



THOMAS

Uterus Curette, malleable, blunt, 280mm, 11"

Fig. 1, Ø 10mm	350-919-001
Fig. 2, Ø 11mm	350-919-002
Fig. 3, Ø 12mm	350-919-003
Fig. 4, Ø 13mm	350-919-004
Fig. 5, Ø 14mm	350-919-005
Fig. 6, Ø 15mm	350-919-006



SIMS

Uterus Curette, 285mm, 11^{1/4}"

rigid, sharp

rigid, blunt

malleable, sharp

malleable, blunt



Fig. 00, 5mm



Fig. 0, 6mm



Fig. 1, 7mm



Fig. 2, 8mm

350-630-005

350-630-006

350-630-007

350-630-008

350-926-050

350-926-060

350-926-070

350-926-080

350-631-005

350-631-006

350-631-007

350-631-008

350-927-050

350-927-060

350-927-070

350-927-080



Fig. 3, 9mm



Fig. 4, 11mm



Fig. 5, 12mm

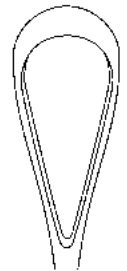

Fig. 6, 14mm

rigid, sharp

rigid, blunt

malleable, sharp

malleable, blunt

350-630-009

350-630-011

350-630-012

350-630-014

350-926-090

350-926-110

350-926-120

350-926-140

350-631-009

350-631-011

350-631-012

350-631-014

350-927-090

350-927-110

350-927-120

350-927-140

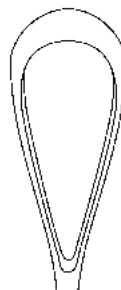

Fig. 7, 15mm



Fig. 8, 16mm



Fig. 9, 19mm

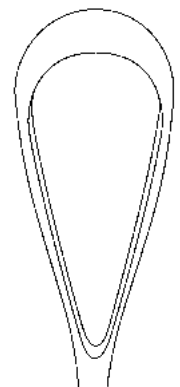

Fig. 10, 20mm

rigid, sharp

rigid, blunt

malleable, sharp

malleable, blunt

350-630-015

350-630-016

350-630-019

350-630-020

350-926-150

350-926-160

350-926-190

350-926-200

350-631-015

350-631-016

350-631-019

350-631-020

350-927-150

350-927-160

350-927-190

350-927-200

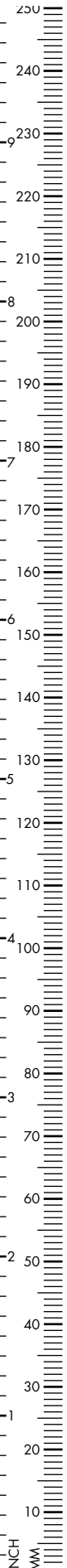



RECAMIER

Uterus Curette, 310mm, 12^{1/4}"

	Fig. 00, 5mm	Fig. 0, 6mm	Fig. 1, 7mm	Fig. 2, 8mm
rigid, sharp	350-620-005	350-620-006	350-620-007	350-620-008
rigid, blunt	350-619-005	350-619-006	350-619-007	350-619-008
malleable, sharp	350-621-005	350-621-006	350-621-007	350-621-008
malleable, blunt	350-622-005	350-622-006	350-622-007	350-622-008



Fig. 00, 5mm



Fig. 0, 6mm



Fig. 1, 7mm



Fig. 2, 8mm



Fig. 3, 9mm



Fig. 4, 11mm



Fig. 5, 12mm

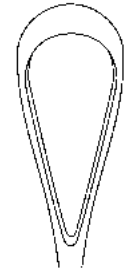

Fig. 6, 14mm

rigid, sharp	350-620-009	350-620-011	350-620-012	350-620-014
rigid, blunt	350-619-009	350-619-011	350-619-012	350-619-014
malleable, sharp	350-621-009	350-621-011	350-621-012	350-621-014
malleable, blunt	350-622-009	350-622-011	350-622-012	350-622-014

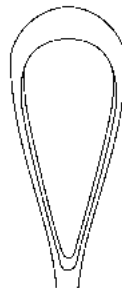

Fig. 7, 15mm

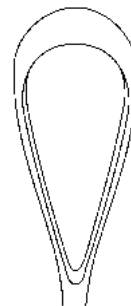

Fig. 8, 16mm

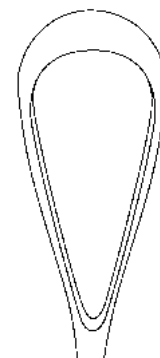

Fig. 9, 19mm

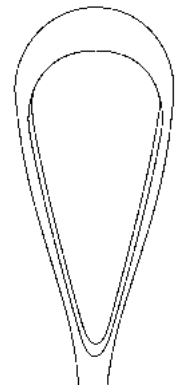
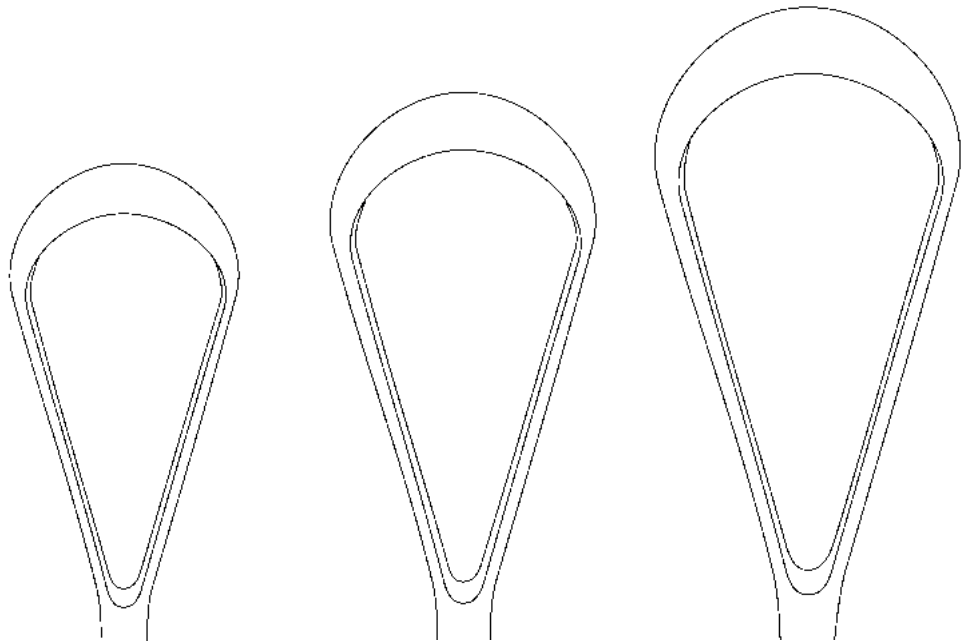

Fig. 10, 20mm

rigid, sharp	350-620-015	350-620-016	350-620-019	350-620-020
rigid, blunt	350-619-015	350-619-016	350-619-019	350-619-020
malleable, sharp	350-621-015	350-621-016	350-621-019	350-621-020
malleable, blunt	350-622-015	350-622-016	350-622-019	350-622-020



BUMM

Uterus Curette, 300mm, 11^{7/8}"

Fig. 1, 30mm

Fig. 2, 35mm

Fig. 3, 40mm

rigid, sharp

350-920-300

350-920-350

350-920-400

rigid, blunt

350-926-300

350-926-350

350-926-400

malleable, sharp

350-928-300

350-928-350

350-928-400

malleable, blunt

350-929-300

350-929-350

350-929-400

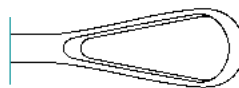
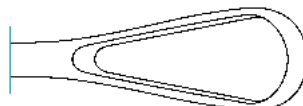

BLAKE

Biopsy Curette, sharp/blunt

270mm, 10^{2/3}"

350-614-270

250
240
230
220
210
200
190
180
170
160
150
140
130
120
110
100
90
80
70
60
50
40
30
20
10
INCH
MM

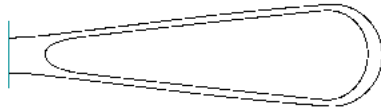

WALLICH

Placenta / Ovum Scoop

420mm, 16^{1/2}"

340-510-420

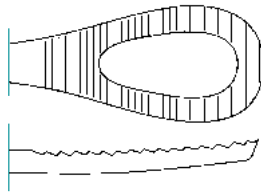

PESTALOZZA

Uterus Curette

300mm, 11^{7/8}"

340-500-300



GREENE

Uterus Curette, 280mm, 11"

10mm

350-365-010

12mm

350-365-012

14mm

350-365-014



MILAN

Curette

290mm, 11^{1/2}"

350-605-007



FAURE

Biopsy Forceps

210mm, 8¹/₄"

350-843-210



SCHUBERT

Biopsy Forceps

210mm, 8¹/₄"

350-844-210

290mm, 11¹/₂"

350-844-290



SCHUBERT

Biopsy Forceps

260mm, 10¹/₄"

350-847-260

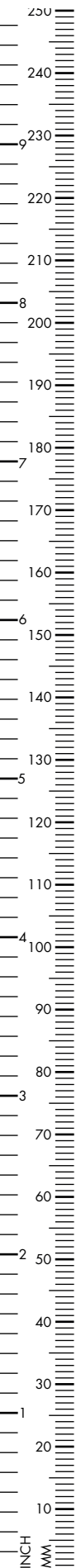

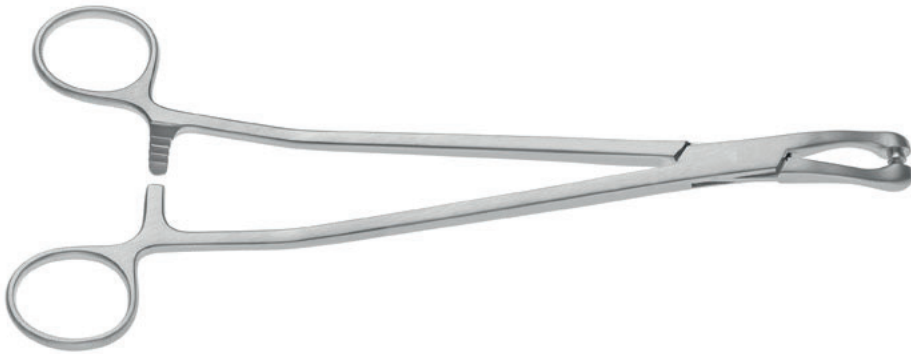

THOMS GAYLOR
Biopsy Forceps, curved

220mm, 8²/₃" 350-857-220

240mm, 9¹/₂" 350-857-240



VAN DOREN
Biopsy Forceps

267mm, 10¹/₂" 350-855-267

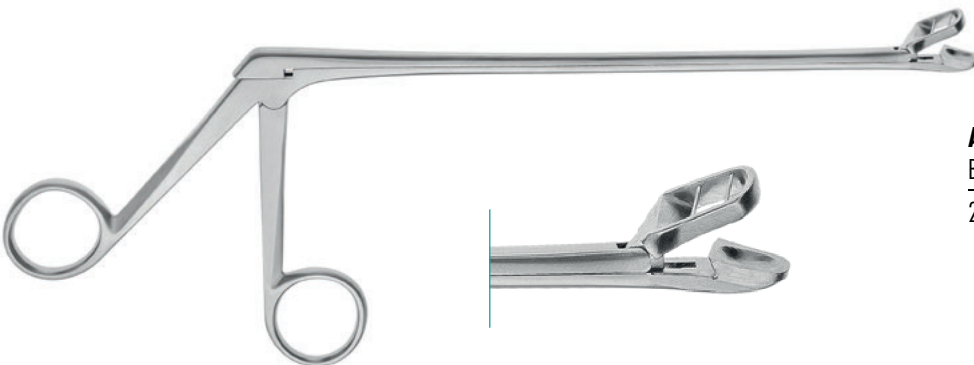

ALEXANDER
Biopsy Forceps

280mm, 11" 310-735-280

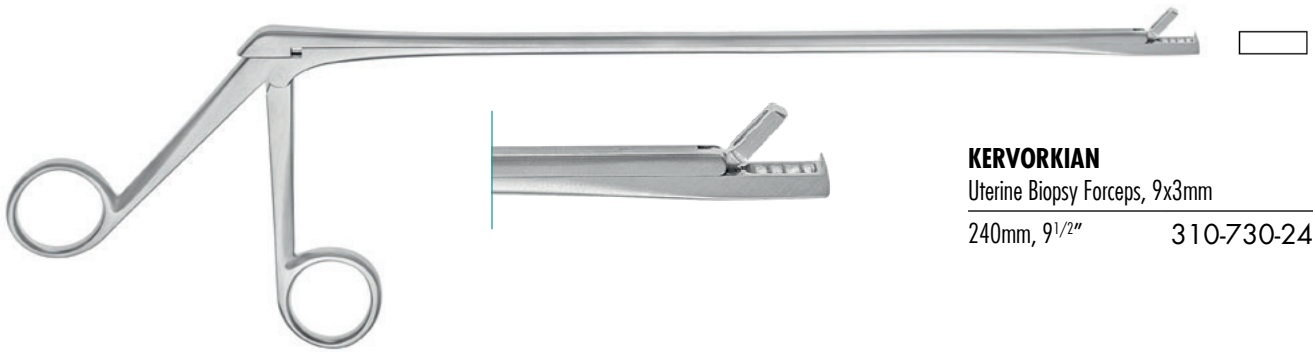

KERVORKIAN

Uterine Biopsy Forceps, 9x3mm

240mm, 9¹/₂" 310-730-240

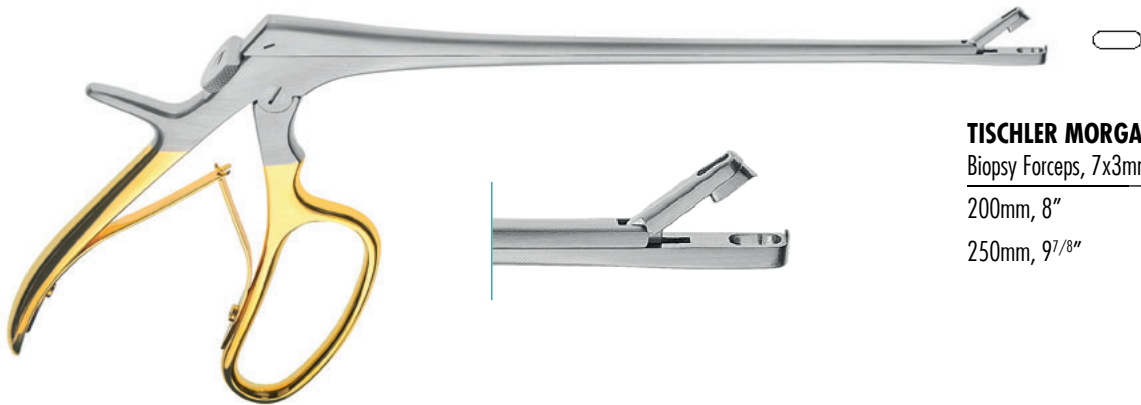

TISCHLER MORGAN

Biopsy Forceps, 7x3mm

200mm, 8" 310-733-001

250mm, 9⁷/₈" 310-735-001

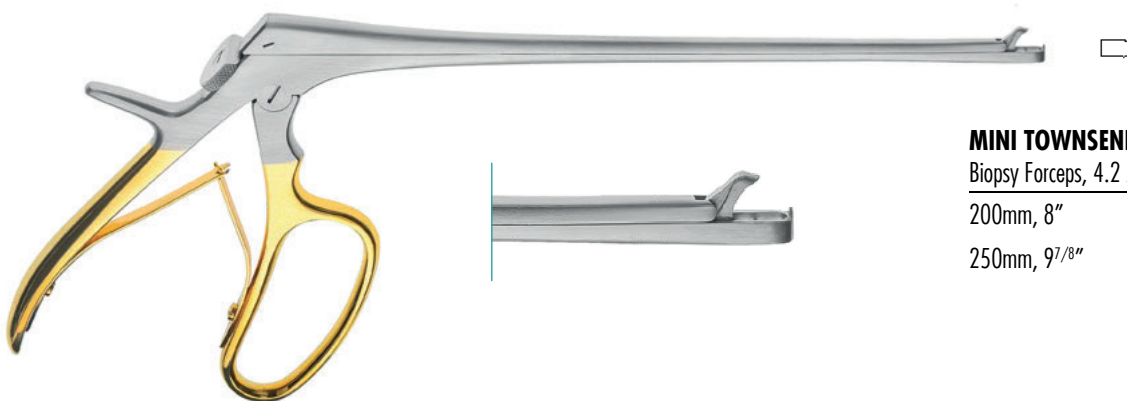

MINI TOWNSEND

Biopsy Forceps, 4.2 x 2.3mm jaw

200mm, 8" 310-733-002

250mm, 9⁷/₈" 310-735-002

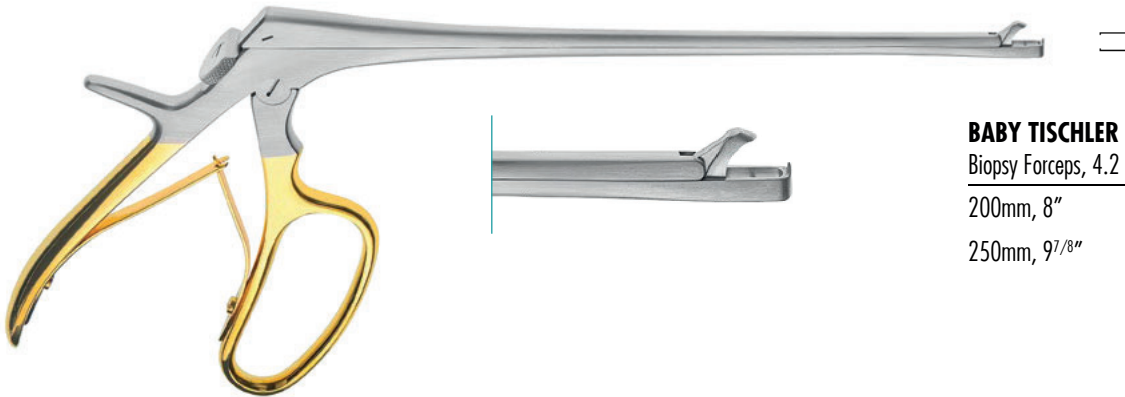

BABY TISCHLER

Biopsy Forceps, 4.2 x 2.3mm jaw

200mm, 8" 310-733-003

250mm, 9⁷/₈" 310-735-003

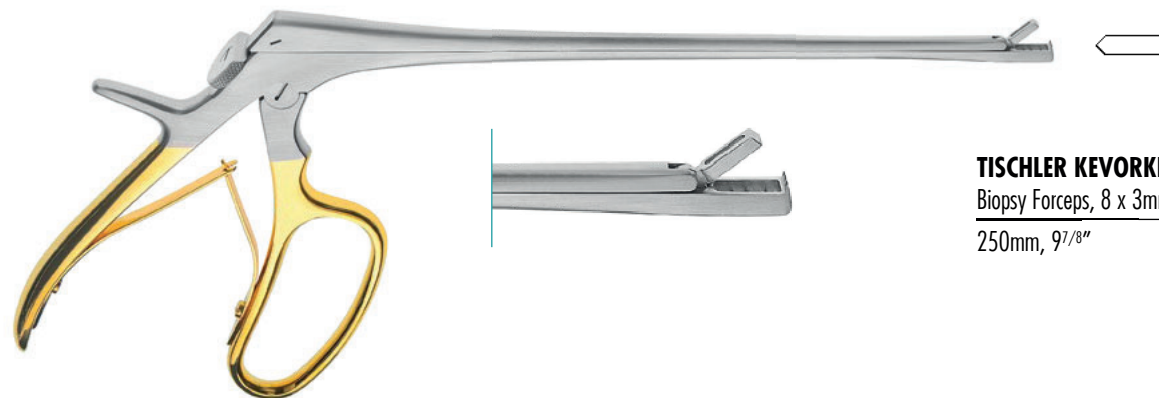

TISCHLER KEVORKIAN

Biopsy Forceps, 8 x 3mm jaw

250mm, 9⁷/₈" 310-731-250

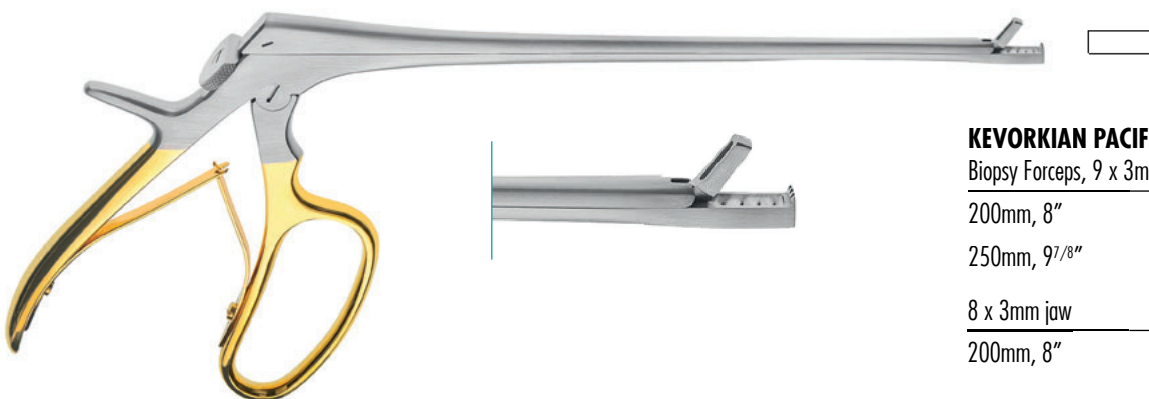

KEVORKIAN PACIFIC

Biopsy Forceps, 9 x 3mm jaw

200mm, 8" 310-732-200

250mm, 9⁷/₈" 310-732-250

8 x 3mm jaw

200mm, 8" 310-731-200

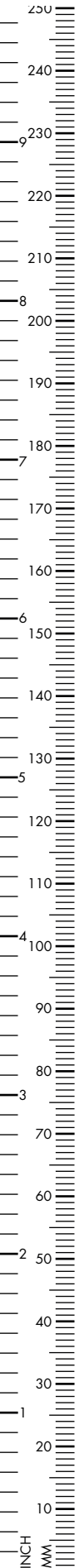

Detachable Biopsy Forceps "Roto Fit"

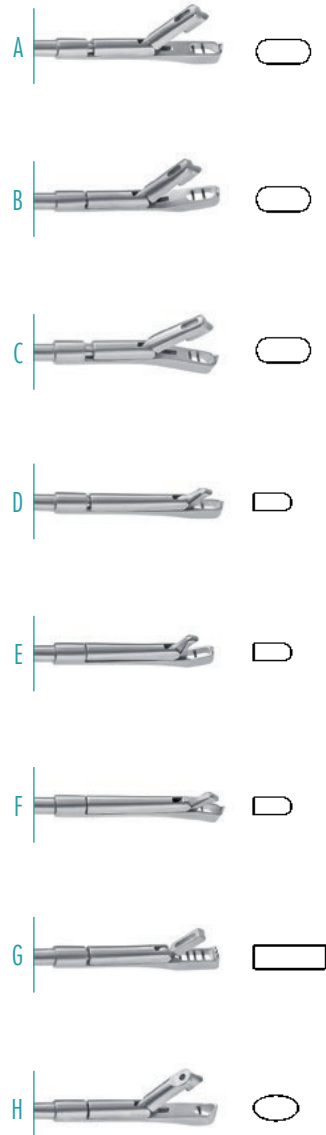

UNI TISCHLER

Insert only, 3 x 7mm, 230mm, 9"

A straight	310-800-100
B angled up	310-801-100
C angled down	310-802-100

complete instrument with handle

A straight	310-800-000
B angled up	310-801-000
C angled down	310-802-000

UNI TOWNSEND

Insert only, 2.3 x 7mm, 230mm, 9"

D straight	310-803-100
E angled up	310-804-100
F angled down	310-805-100

complete instrument with handle

D straight	310-803-000
E angled up	310-804-000
F angled down	310-805-000

UNI KERVOKIAN

Insert only, 3 x 9mm, 230mm, 9"

G straight	310-806-100
------------	-------------

complete instrument with handle

G straight	310-806-000
------------	-------------

UNI OVAL

Insert only, 3 x 5.5mm, 230mm, 9"

H straight	310-807-100
------------	-------------

complete instrument with handle

H straight	310-807-000
------------	-------------

I Handle only

310-800-600



BURKE

Biopsy Forceps, 5 x 3mm jaw

200mm, 8"	310-732-000
250mm, 9 ^{7/8} "	310-735-004

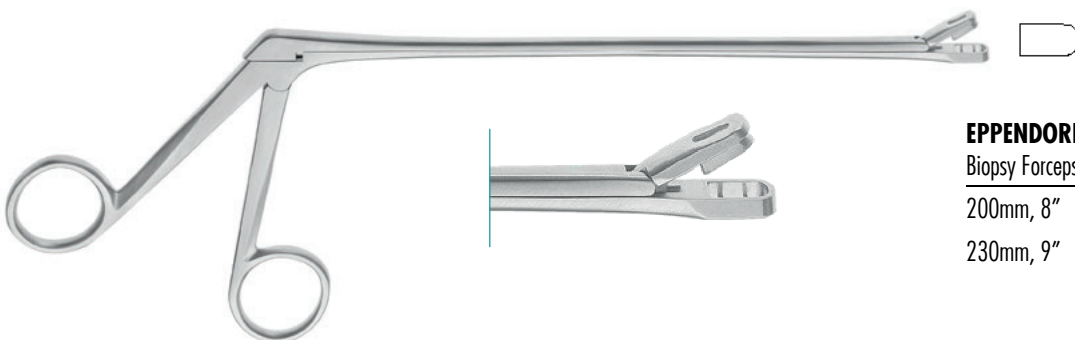

EPPENDORFER

Biopsy Forceps, 4x8mm

200mm, 8"	310-760-200
230mm, 9"	310-760-230

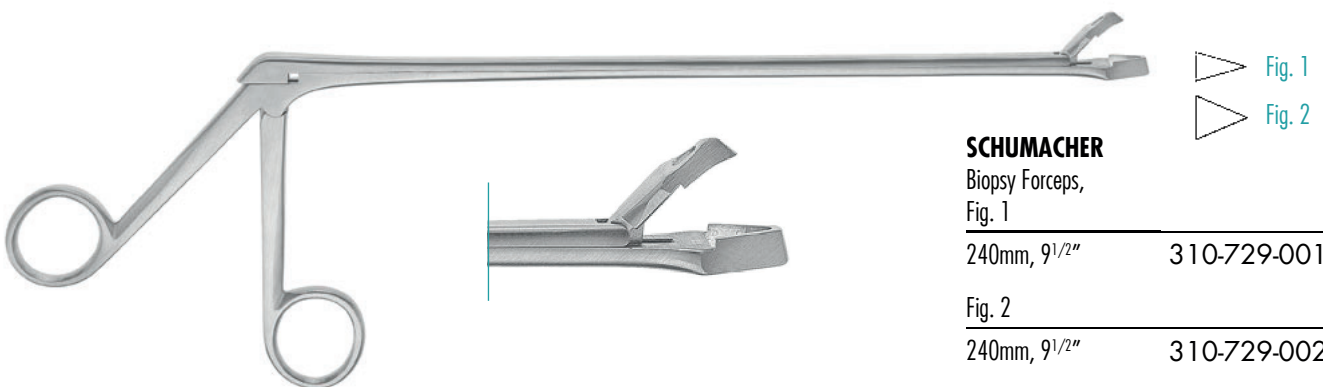

SCHUMACHER

Biopsy Forceps,
Fig. 1

240mm, 9 ^{1/2} "	310-729-001
---------------------------	-------------

Fig. 2

240mm, 9 ^{1/2} "	310-729-002
---------------------------	-------------

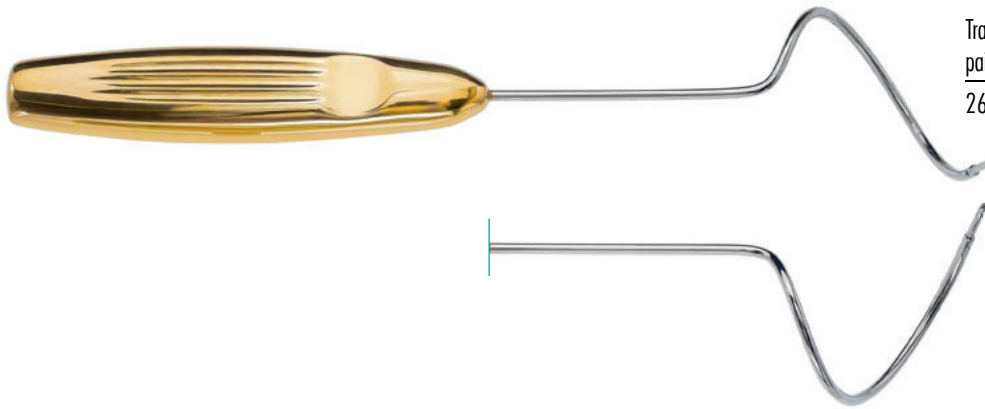

Transobturator Sling needle
pair of right and left curved

260mm, 10¹/₄" 350-101-260



MIYAZAKI

Ligature Carrier, large hook 0.75"

200mm, 8" shaft 180-160-000



MIYAZAKI

Speculum with notch

180-160-010



SIMS

Uterine Probe, graduated, Ø 4mm,
330mm, 13"

rigid 350-395-320

malleable 350-396-320



SIMPSON

Uterine Probe, malleable, Ø 4mm

290mm, 11¹/₂" 350-396-290

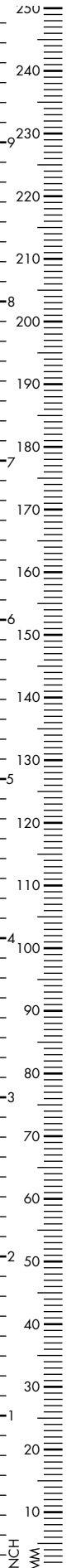



Uterine manipulator, complete set
(350-660-111 - 350-660-116)

350-660-100



Adaptor \varnothing 8 x 80 mm

350-660-111



Adaptor \varnothing 10 x 100 mm

350-660-112



Adaptor \varnothing 3 x 45 mm

350-660-113



Adaptor \varnothing 3 x 55 mm

350-660-114



Adaptor \varnothing 3.2 x 35 mm

350-660-115



Adaptor \varnothing 3.2 x 45 mm

350-660-116



COHEN

Uterus Cannula
complete with 2 interchangeable acorns

350-750-000

Acorns

small 350-750-001

large 350-750-002

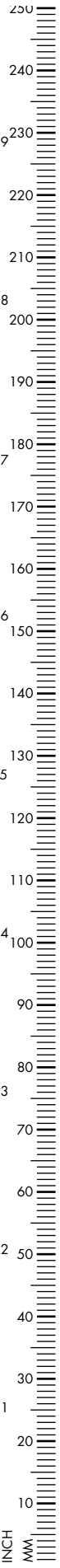

HEGAR

Uterine Dilator, double-ended

1.0/2.0mm	350-382-020	15.0/16.0mm	350-382-160
3.0/4.0mm	350-382-040	17.0/18.0mm	350-382-180
5.0/6.0mm	350-382-060	19.0/20.0mm	350-382-200
7.0/8.0mm	350-382-080	21.0/22.0mm	350-382-220
9.0/10.0mm	350-382-100	23.0/24.0mm	350-382-240
11.0/12.0mm	350-382-120	25.0/26.0mm	350-382-260
13.0/14.0mm	350-382-140		

Set*, 8 sizes from 3/4 to 17/18 mm
in canvas roll

350-383-001



HEGAR

Uterine Dilator with slope handle

1.0mm	350-380-010	12.5mm	350-380-125	24.0mm	350-380-240
1.5mm	350-380-015	13.0mm	350-380-130	25.0mm	350-380-250
2.0mm	350-380-020	13.5mm	350-380-135	26.0mm	350-380-260
2.5mm	350-380-025	14.0mm	350-380-140	27.0mm	350-380-270
3.0mm	350-380-030	14.5mm	350-380-145	28.0mm	350-380-280
3.5mm	350-380-035	15.0mm	350-380-150	29.0mm	350-380-290
4.0mm	350-380-040	15.5mm	350-380-155	30.0mm	350-380-300
4.5mm	350-380-045	16.0mm	350-380-160		
5.0mm	350-380-050	16.5mm	350-380-165		
5.5mm	350-380-055	17.0mm	350-380-170		
6.0mm	350-380-060	17.5mm	350-380-175		
6.5mm	350-380-065	18.0mm	350-380-180		
7.0mm	350-380-070	18.5mm	350-380-185		
7.5mm	350-380-075	19.0mm	350-380-190		
8.0mm	350-380-080	19.5mm	350-380-195		
8.5mm	350-380-085	20.0mm	350-380-200		
9.0mm	350-380-090	21.0mm	350-380-210		
9.5mm	350-380-095	22.0mm	350-380-220		
10.0mm	350-380-100	23.0mm	350-380-230		
10.5mm	350-380-105				
11.0mm	350-380-110				
11.5mm	350-380-115				
12.0mm	350-380-120				

* illustration does not show the complete set



PRATT

Uterine Dilators, French Scale 10^{3/8}"

13 - 15	350-392-015
17 - 19	350-392-019
21 - 23	350-392-023
25 - 27	350-392-027
29 - 31	350-392-031
33 - 35	350-392-035
37 - 39	350-392-039
41 - 43	350-392-043

Set of 8 pieces in canvas roll*

350-392-000



HANK

Uterine Dilator

Fig. 9/10 4.5/5.0mm	350-390-010	Fig. 15/16 7.5/8.0mm	350-390-016
Fig. 11/12 5.5/6.0mm	350-390-012	Fig. 17/18 8.5/9.0mm	350-390-018
Fig. 13/14 6.5/7.0mm	350-390-014	Fig. 19/20 9.5/10.0mm	350-390-020

Set, 6 pieces in canvas roll*

350-391-002

* illustration does not show the complete set



JACKSON

Vaginal Speculum

75 x 38mm	350-206-001
90 x 38mm	350-206-002
100 x 38mm	350-206-003



EASTMAN

Vaginal Speculum

75 x 38mm	350-207-001
90 x 38mm	350-207-002
100 x 38mm	350-207-003



DOYEN

Vaginal Speculum, slightly concave

55 x 35mm	350-290-001
85 x 35mm	350-290-002
115 x 35mm	350-290-003
55 x 45mm	350-290-004
85 x 45mm	350-290-005
115 x 45mm	350-290-006
160 x 45mm	350-290-007
55 x 60mm	350-290-008
85 x 60mm	350-290-009
115 x 60mm	350-290-010
160 x 60mm	350-290-011



HEANEY

Retractor, 270mm, 10²/₃"

73 x 28mm	170-459-001
45 x 28mm	170-459-002
82 x 28mm	170-459-003



HEANEY SIMON

Retractor with horn handle

260mm, 10 ¹ / ₄ "	170-460-260
---	-------------



BREISKY

Vaginal Speculum

100 x 20mm	350-320-020	130 x 20mm	350-322-020
100 x 25mm	350-320-025	130 x 25mm	350-322-025
100 x 30mm	350-320-030	130 x 30mm	350-322-030
100 x 35mm	350-320-035	130 x 35mm	350-322-035
100 x 40mm	350-320-040	130 x 40mm	350-322-040
		155 x 40mm	350-324-040

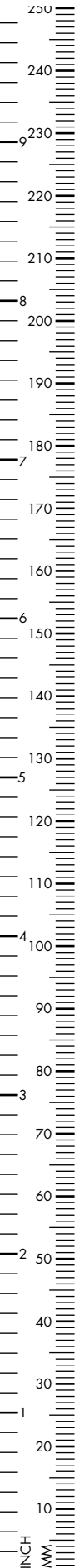

SEIDL

Speculum for children
170mm, 6²/₃"

80 x 8mm	350-254-001
80 x 10mm	350-254-002
90 x 14mm	350-254-003



KRISTELLER

Vaginal Speculum, for children

70 x 15mm	350-210-000
for adults	
70 x 27mm	350-210-001
80 x 30mm	350-210-002
90 x 36mm	350-210-003



KRISTELLER

Retractor

Fig. 0	70 x 10mm	350-211-000
Fig. 1	75 x 23mm	350-211-001
Fig. 2	85 x 26mm	350-211-002
Fig. 3	100 x 32mm	350-211-003



KRISTELLER

Vaginal Speculum Set

Fig. 0	350-212-000
Fig. 1	350-212-001
Fig. 2	350-212-002
Fig. 3	350-212-003



KRISTELLER

Vaginal Speculum

Fig. 1	110 x 27mm	350-230-001
Fig. 2	110 x 30mm	350-230-002
Fig. 3	110 x 36mm	350-230-003



KRISTELLER

Retractor

Fig. 1	115 x 18mm	350-231-001
Fig. 2	115 x 22mm	350-231-002
Fig. 3	115 x 28mm	350-231-003



KRISTELLER

Vaginal Speculum Set

Fig. 1		350-232-001
Fig. 2		350-232-002
Fig. 3		350-232-003



SIMS

Vaginal Speculum, small

65 x 25mm	350-200-001
-----------	-------------

medium

70 x 30mm	350-200-002
-----------	-------------

large

85 x 35mm	350-200-003
-----------	-------------



RZ

Lateral Retractor

60 x 22mm	350-340-000
-----------	-------------



KOGAN

Endospeculum, screw ratchet, 240mm, 9^{1/2}"

5mm	350-361-001
-----	-------------

4mm	350-361-002
-----	-------------

3mm	350-361-003
-----	-------------

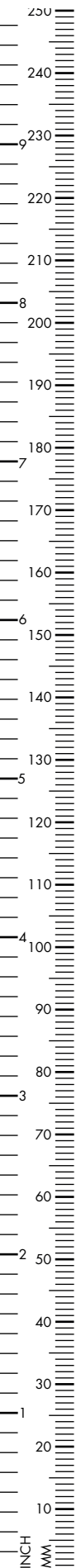



GRAVE

Vaginal Speculum

75 x 20mm	350-130-001
95 x 35mm	350-130-002
115 x 35	350-130-003



PEDERSON

Vaginal Speculum

75 x 13mm	350-140-001
100 x 22mm	350-140-002
120 x 25mm	350-140-003



CUSCO

Vaginal Speculum

75 x 32mm	350-100-001
85 x 35mm	350-100-002
100 x 35mm	350-100-003



CUSCO

Vaginal Speculum, Swiss pattern

80 x 22mm	350-102-001
100 x 25mm	350-102-002
105 x 27mm	350-102-003



SEMN

Vaginal Speculum, 100mm blade

17-20mm wide blade	350-120-001
25-30mm wide blade	350-120-002



COLLIN

Vaginal Speculum, detachable

65 x 20mm	350-110-001
85 x 30mm	350-110-002
100 x 35mm	350-110-003
100 x 40mm	350-110-004

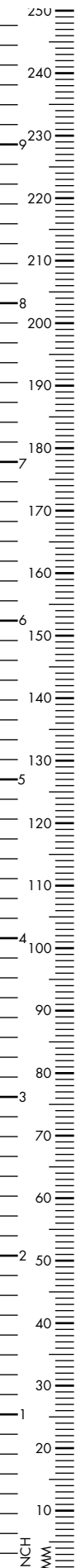



AUVARD

Vaginal Speculum, fixed weight,
1.14kg, 45° angled

70 x 42mm	350-309-000
83 x 38mm	350-310-000
102 x 45mm	350-311-000



STEINER ANVARD

Vaginal Speculum, fixed weight, 1.14kg

150 x 34mm	350-311-140
------------	-------------



SCHERBACK

Vaginal Speculum, complete set
incl. weight 400g, handle, blades Fig. 1 - 5

350-300-000



Blades

80x30mm	330-301-001
85x35mm	330-301-002
85x40mm	330-301-003
55x40mm	330-301-004
70x45mm	330-301-005



Weight

400g	350-302-001
800g	350-302-002
Handle	350-303-000



GELPI

Perineal Retractor, pediatric size

90mm, 3 ¹ / ₂ "	170-802-090
110mm, 4 ¹ / ₃ "	170-802-110
135mm, 5 ¹ / ₃ "	170-802-135

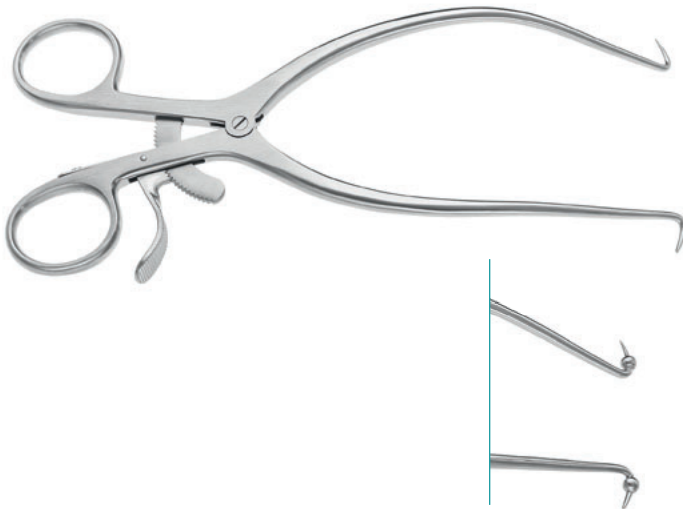

GELPI

Perineal Retractor

180mm, 7"	170-802-180
with ball stops	
190mm, 7 ¹ / ₂ "	170-803-180



RIGBY

Perineal Retractor, 21x70mm blades

180mm, 7"	170-806-180
-----------	-------------

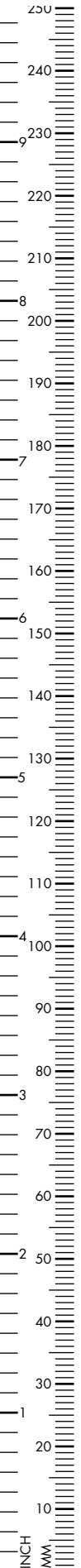



O'SULLIVAN O'CONNOR

Vaginal Retractor Set

350-336-000



RIGBY

Perineal Retractor, 21x70mm blades

180mm, 7"

170-806-180

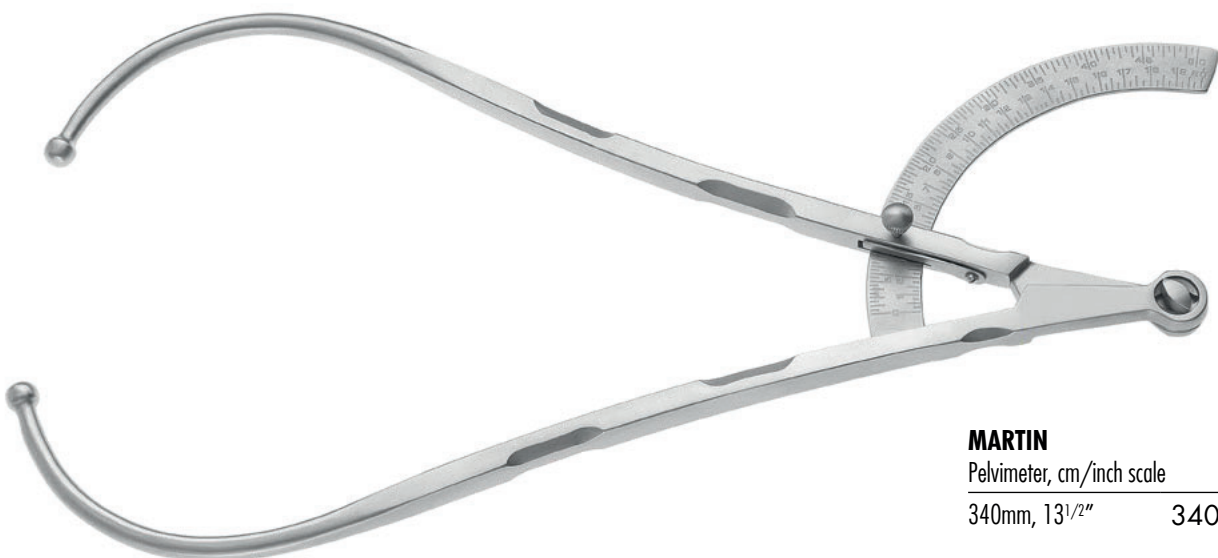

MARTIN

Pelvimeter, cm/inch scale

340mm, 13 1/2"

340-103-340

