

GENITO- URINARY



Retractors / Spatula
Forceps
Vasectomy
Penis Clamps
Catheters
Bougies
Urethrotomes



YOUNG

Prostatic Retractor

210mm, 8^{1/4}"

320-204-210



YOUNG

Prostatic Retractor

220mm, 8^{2/3}"

320-205-220



YOUNG

Prostatic Retractor

210mm, 8^{1/4}"

320-206-210



Prostatic Retractor
 360mm, 14^{1/8}"

320-201-360



LEGUEU
 Bladder Spatula

260mm, 10^{1/4}"

320-170-260



KOCHER
 Bladder Spatula

235mm, 9^{1/4}"

320-175-235

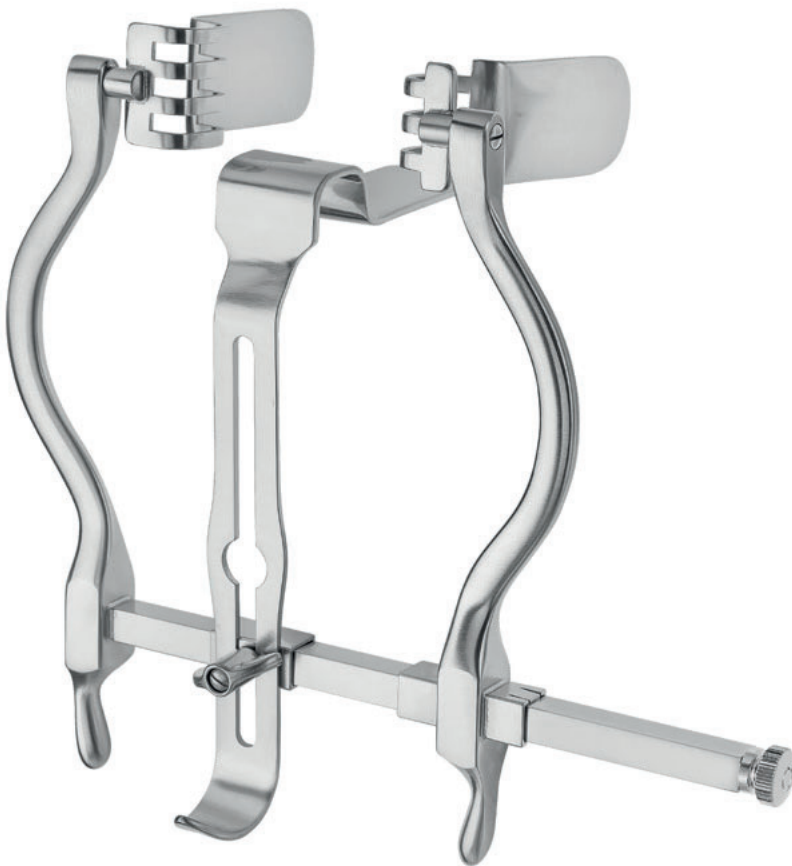

MASSON

Bladder Retractor
blade 73 x 28mm

110mm opening 320-195-000



MILLIN

Bladder Retractor, complete

320-185-000

Central Valve

105 x 45mm 320-185-004

Lateral Blades

82 x 25mm 320-185-003

87 x 25mm 320-185-002

Retractor only

320-185-001

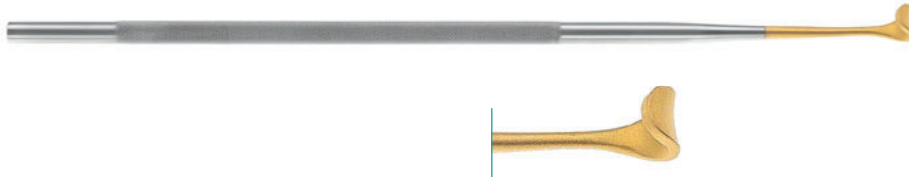

GIL VERNET

Retractor, malleable, 240mm, 9^{1/2}"

8mm	170-236-008
11mm	170-236-011
17mm	170-236-017
20mm	170-236-020
23mm	170-236-023



MILLIN

Bladder Neck Spreader

285mm, 11 ^{1/4} "	320-165-285
----------------------------	-------------

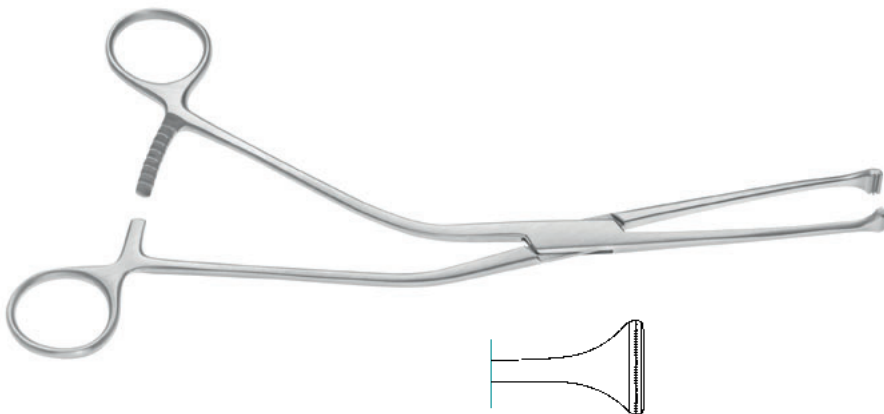

MILLIN

Prostatic Grasping Forceps

230mm, 9"	320-150-230
-----------	-------------

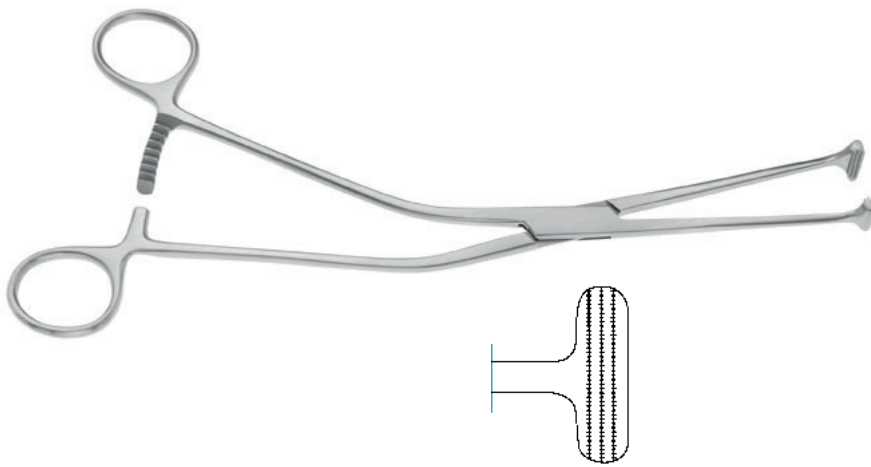

MILLIN

Atraumatic Grasping Forceps
for the capsule

230mm, 9"

320-151-230

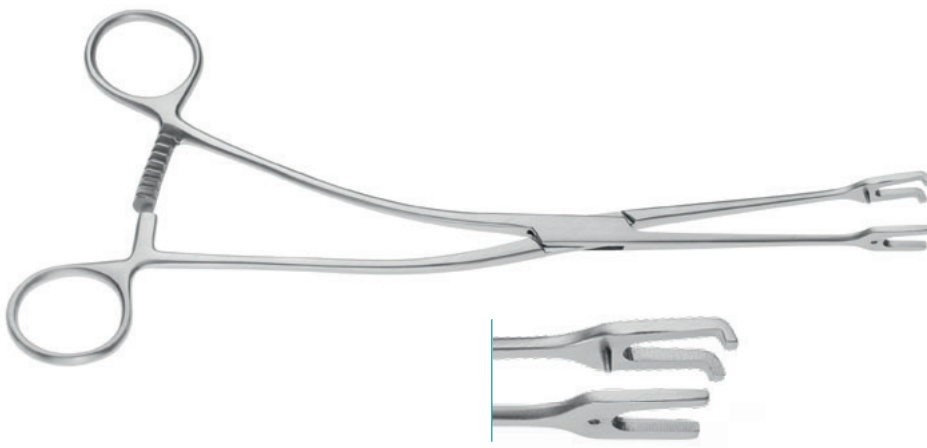

MILLIN

Ligature Carrying Forceps

245mm, 9²/₃"

320-151-245

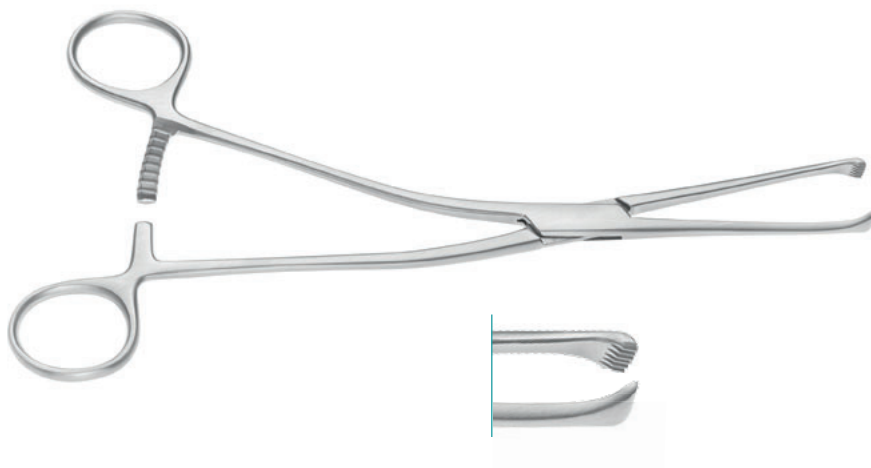

MILLIN

Grasping Forceps for the anterior lobe

230mm, 9"

320-152-230

250
240
230
220
210
200
190
180
170
160
150
140
130
120
110
100
90
80
70
60
50
40
30
20
10
INCH
MM

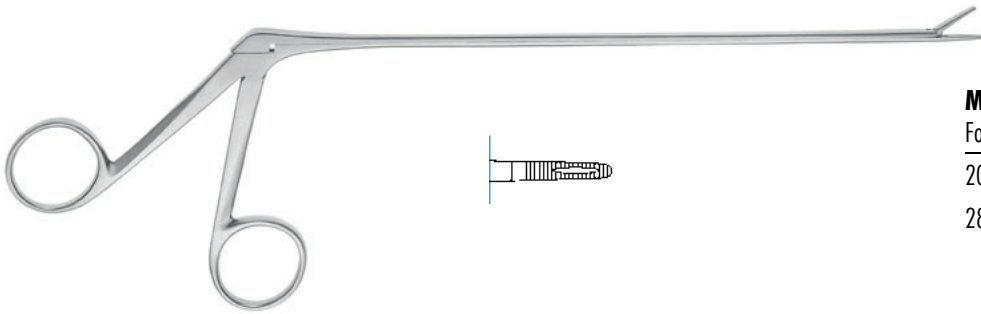

MATHIEU

Foreign Body Forceps

200mm, 8"	320-350-190
280mm, 11"	320-350-280

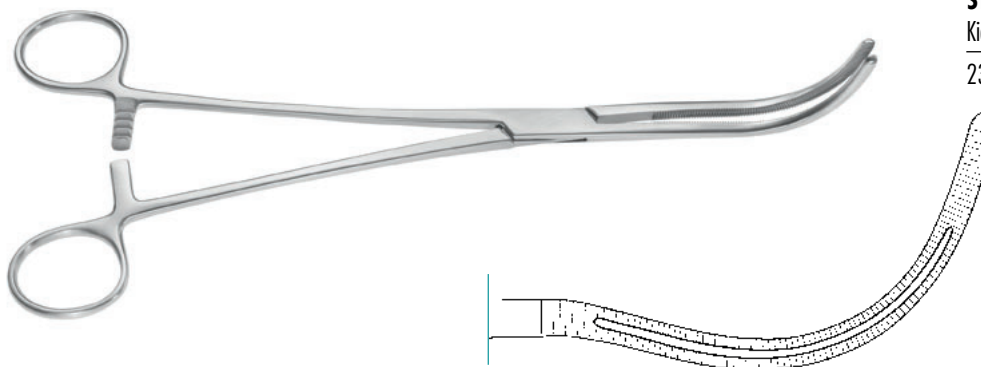

STILLE

Kidney Pedicle Clamp

230mm, 9"	140-602-230
-----------	-------------

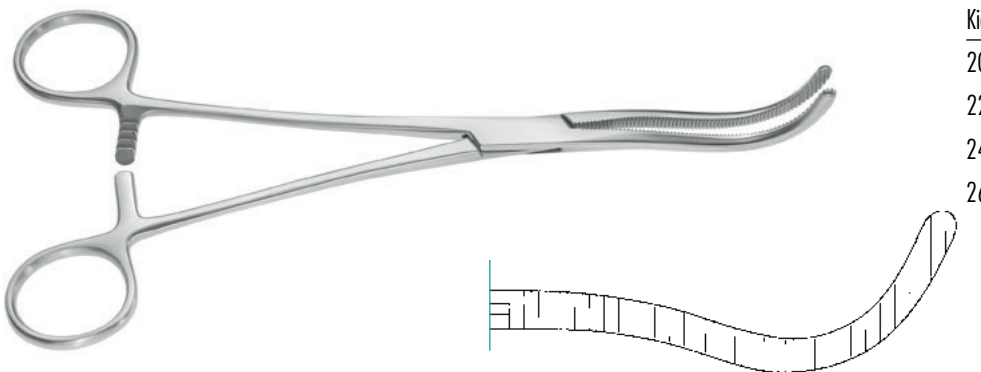

GUYON

Kidney Pedicle Clamp, curved

200mm, 8"	140-600-200
220mm, 8 ² / ₃ "	140-600-220
240mm, 9 ¹ / ₂ "	140-600-240
265mm, 10 ¹ / ₂ "	140-600-265

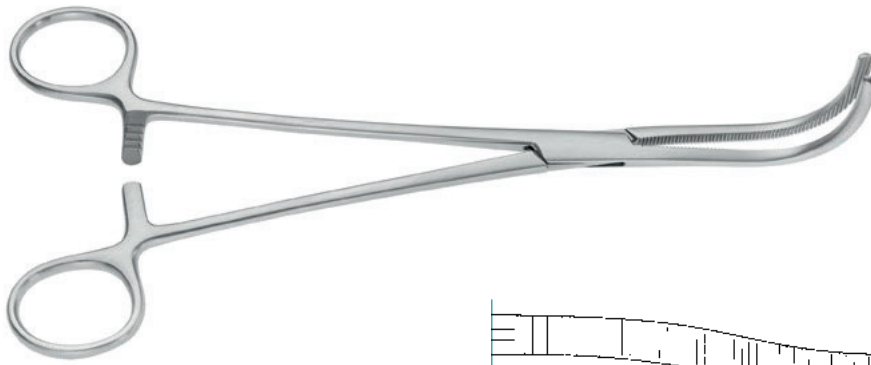
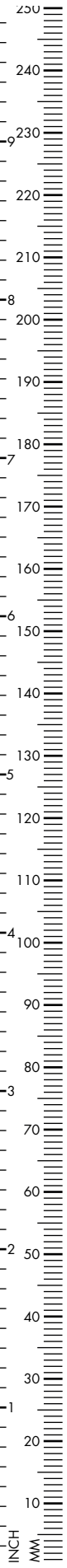

GUYON

Kidney Pedicle Clamp

230mm, 9"

140-603-230

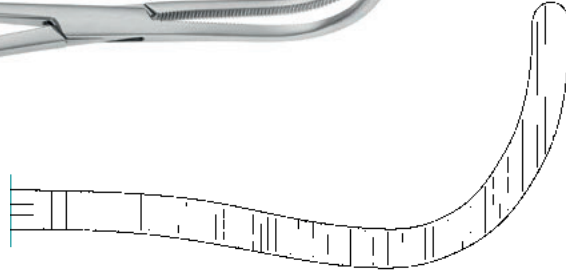

HERRICK

Pedicle Clamp, angled, longitudinal serrated

230mm, 9"

140-604-230

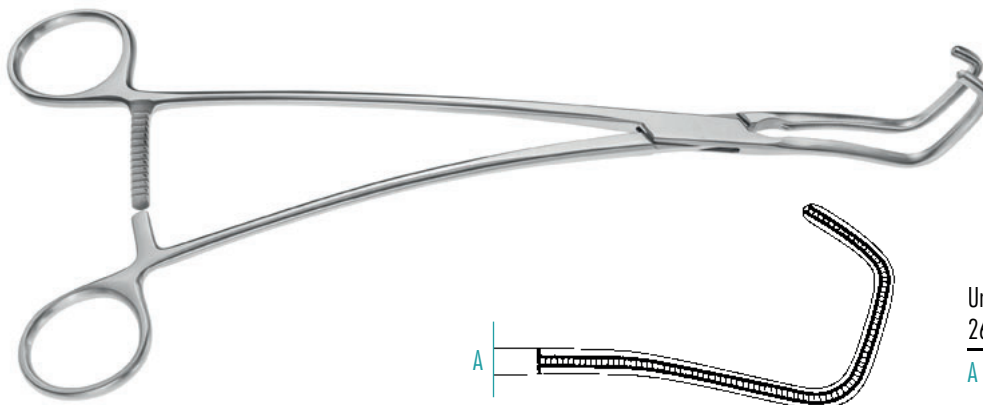

Uro-Tangential Kidney Pedicle Clamp, atraumatic
260mm, 10^{1/4}"

A Fig. 1 140-500-001

B Fig. 2 140-500-002

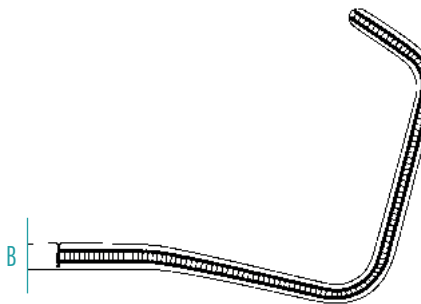
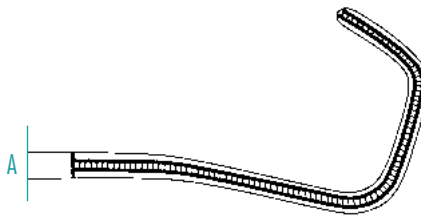

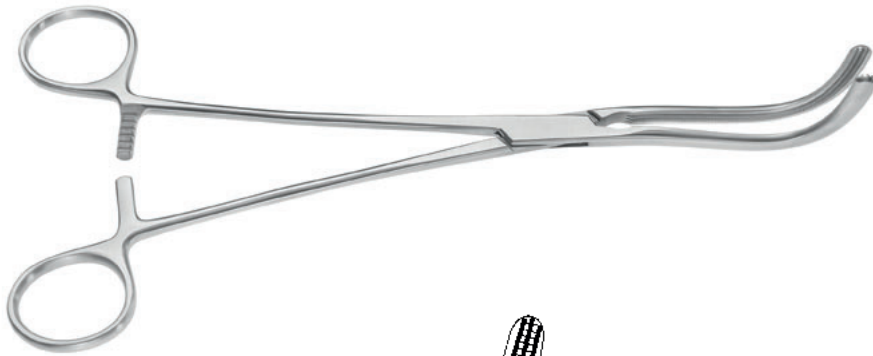

GUYON

Kidney Pedicle Clamp, atraumatic

260mm, 10¹/₄"

A 230mm, 9" 140-498-230

B 240mm, 9¹/₂" 140-498-240

C 235mm, 9¹/₄" 140-498-235

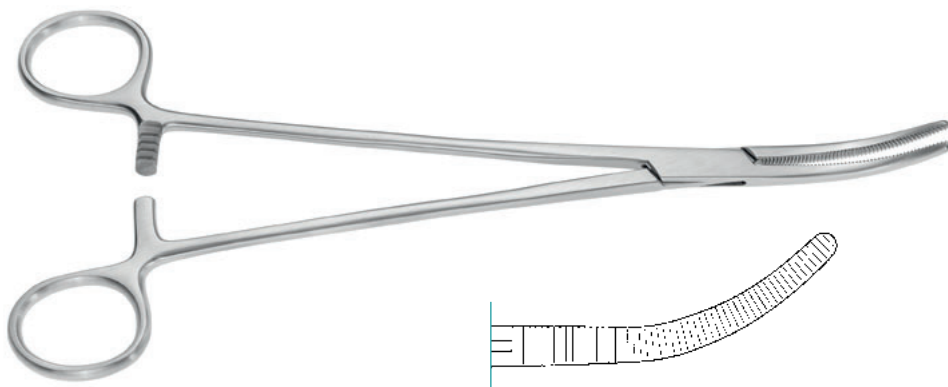
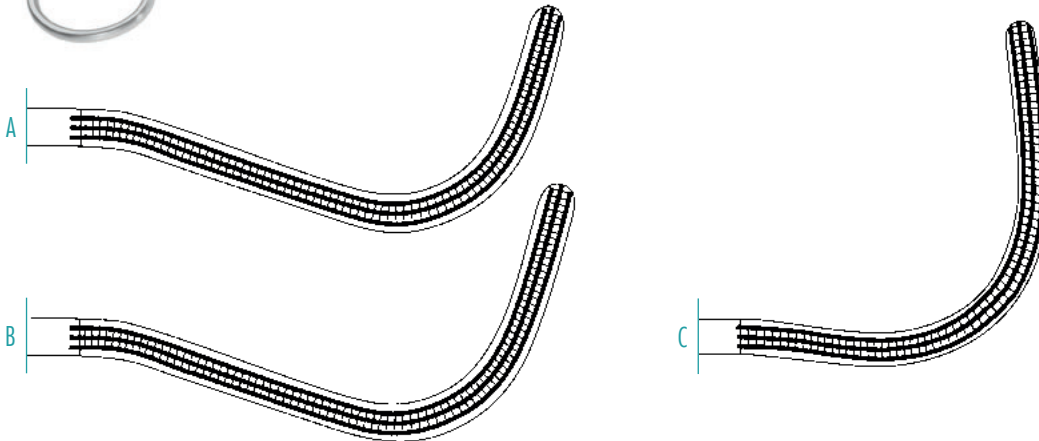

WERTHEIM

Hysterectomy Forceps, serrated, curved

250mm, 9⁷/₈"

140-697-250

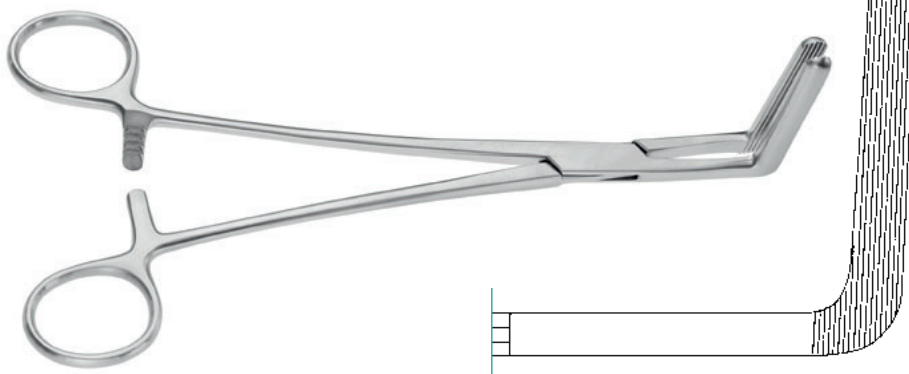
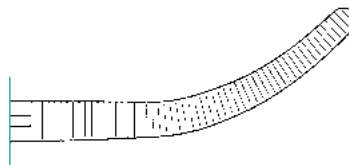

WERTHEIM CULLEN

Hysterectomy Forceps, 90° angled

215mm, 8¹/₂"

140-641-215

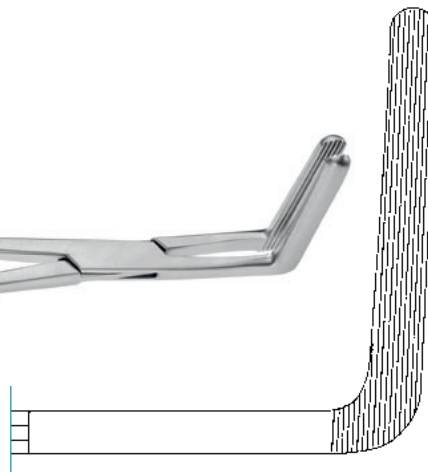

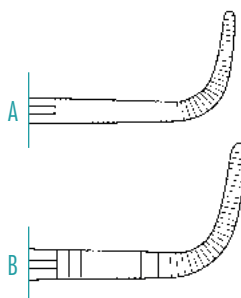
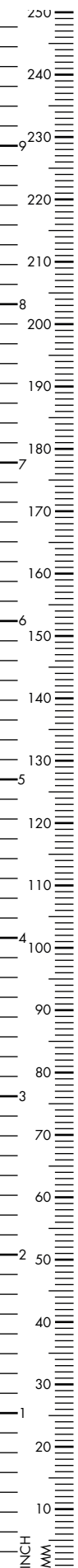

MEEKER

Kidney Pedicle Clamp

Fig. 1

A 180mm, 7" 140-619-180

Fig. 2

B 280mm, 11" 140-619-275

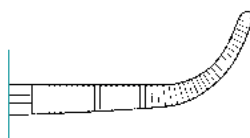
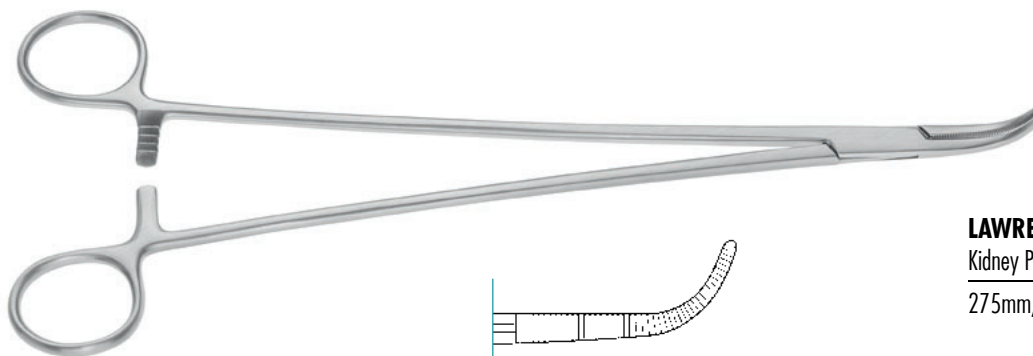

LAWRENCE

Kidney Pedicle Clamp

275mm, 10⁷/₈" 140-617-275

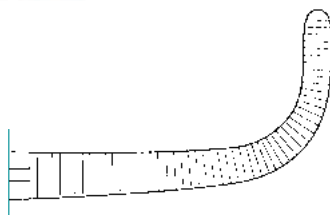
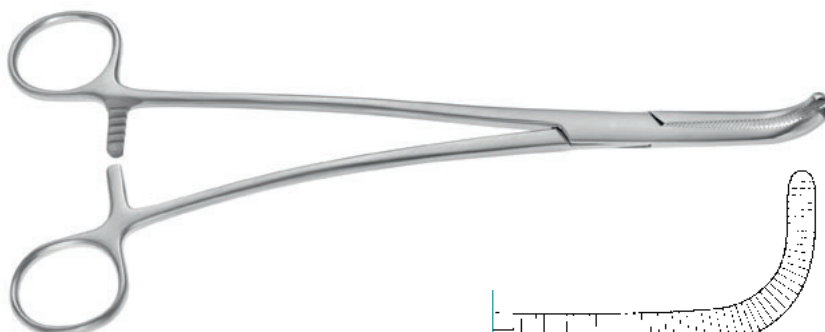

GRAY

Gall Duct Clamp, s-curved

220mm, 8²/₃" 140-607-220

230mm, 9" 140-607-230



No-Scalpel Vasectomy Forceps, sharp, pointed,
smooth curved jaw

125mm, 5" 140-353-125

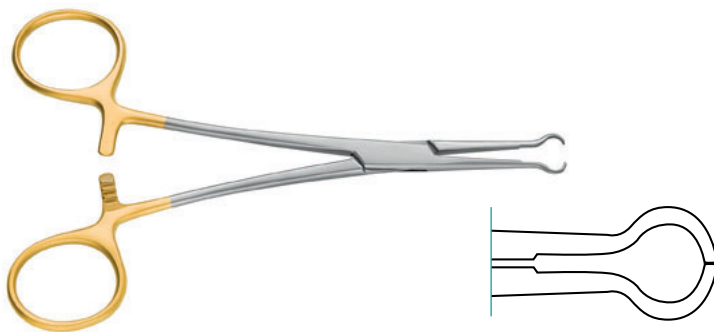

No-Scalpel Vasectomy Fixator Ring Forceps,
blunt tip, Ø4.7mm ring size

140mm, 5 1/2" 140-352-140

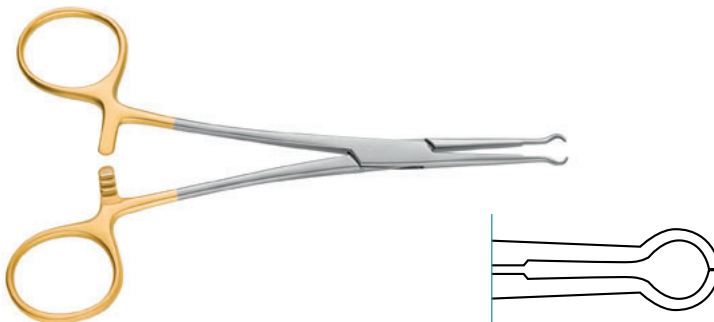

No-Scalpel Vasectomy Mini Fixator
Ring Forceps,
blunt tip, Ø3mm ring size

140mm, 5 1/2" 140-353-140



A



C



B



D

A Microspike Approximator Clamp
for Vasovasostomy

Ø2mm 270-150-001

B for Vasovasostomy

Ø4mm / Ø2mm 270-150-002

C for Vasovasostomy, end-to-end,
for Vasoepididymostomy

Ø6mm / Ø2mm 270-150-003

D for Vasovasostomy, end-to-side,
for Vasoepididymostomy

Ø6mm / Ø2mm 270-150-200



STOCKMANN

Meatus Clamp

80mm, 3¹/₄"

320-998-000



STRAUSS

Penis Seizing Forceps

130mm, 5¹/₈"

320-999-000



FOLEY

Catheter Spanner/Introducer

455mm, 18"

320-603-455



GUYON

Catheter, curved

390mm, 15¹/₂"

253-310-390

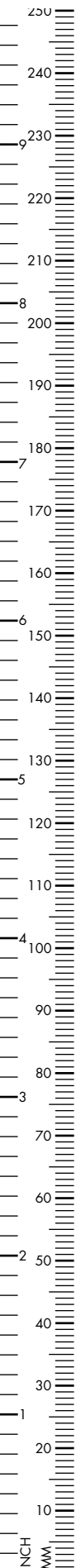



Metal Catheter for women

8 Charr.	320-721-080
10 Charr.	320-721-100
11 Charr.	320-721-110
12 Charr.	320-721-120
14 Charr.	320-721-140
16 Charr.	320-721-160
18 Charr.	320-721-180
20 Charr.	320-721-200
22 Charr.	320-721-220
24 Charr.	320-721-240

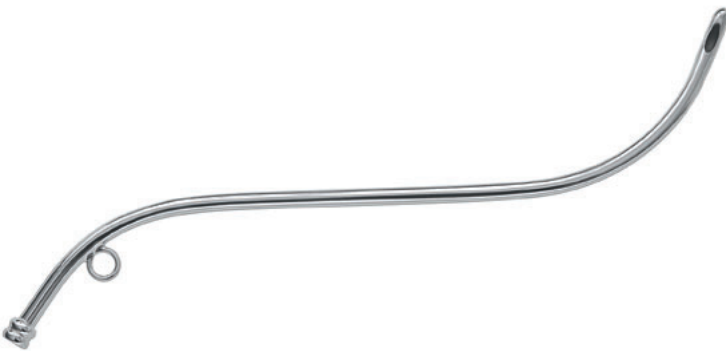

Rotunda Catheter, s-curved

8 Charr.	320-723-080
10 Charr.	320-723-100
12 Charr.	320-723-120
14 Charr.	320-723-140
16 Charr.	320-723-160
18 Charr.	320-723-180
20 Charr.	320-723-200
22 Charr.	320-723-220
24 Charr.	320-723-240



Metal Catheter for men working length: 290mm, 11¹/₂"

8 Charr.	320-720-080
10 Charr.	320-720-100
12 Charr.	320-720-120
14 Charr.	320-720-140
16 Charr.	320-720-160
18 Charr.	320-720-180
20 Charr.	320-720-200
22 Charr.	320-720-220
24 Charr.	320-720-240



DITTEL

Bougie, straight

8 Charr.	253-320-225	22 Charr.	253-329-225
9 Charr.	253-321-225	24 Charr.	253-330-225
10 Charr.	253-322-225	25 Charr.	253-331-225
11 Charr.	253-323-225	26 Charr.	253-332-225
12 Charr.	253-324-225	27 Charr.	253-333-225
14 Charr.	253-325-225	28 Charr.	253-334-225
16 Charr.	253-326-225	30 Charr.	253-335-225
18 Charr.	253-327-225	32 Charr.	253-336-225
20 Charr.	253-328-225	34 Charr.	253-337-225



GUYON

Bougie, strongly curved

8 Charr.	253-340-335
9 Charr.	253-341-335
10 Charr.	253-342-335
11 Charr.	253-343-335
12 Charr.	253-344-335
14 Charr.	253-345-335
16 Charr.	253-346-335
18 Charr.	253-347-335
20 Charr.	253-348-335
22 Charr.	253-349-335
24 Charr.	253-350-335
25 Charr.	253-351-335
26 Charr.	253-352-335
27 Charr.	253-353-335
28 Charr.	253-354-335
30 Charr.	253-355-335
32 Charr.	253-356-335
34 Charr.	253-357-335

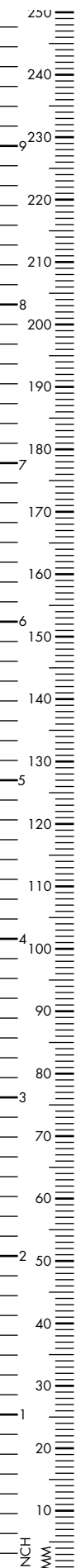



VAN BUREN

Bougie, curved

10 Charr.	253-650-010
12 Charr.	253-650-012
14 Charr.	253-650-014
16 Charr.	253-650-016
18 Charr.	253-650-018
20 Charr.	253-650-020
22 Charr.	253-650-022
24 Charr.	253-650-024
26 Charr.	253-650-026
28 Charr.	253-650-028
30 Charr.	253-650-030
32 Charr.	253-650-032
34 Charr.	253-650-034
36 Charr.	253-650-036



DITTEL

Bougie, slightly curved

8 Charr.	253-320-335	22 Charr.	253-329-335
9 Charr.	253-321-335	24 Charr.	253-330-335
10 Charr.	253-322-335	25 Charr.	253-331-335
11 Charr.	253-323-335	26 Charr.	253-332-335
12 Charr.	253-324-335	27 Charr.	253-333-335
14 Charr.	253-325-335	28 Charr.	253-334-335
16 Charr.	253-326-335	30 Charr.	253-335-335
18 Charr.	253-327-335	32 Charr.	253-336-335
20 Charr.	253-328-335	34 Charr.	253-337-335



A

OTIS

A Dilation Urethrotome, complete with 3 atraumatic tip and 2 knives, wooden case

253-500-100

wooden case only 253-500-103

B Urethrotome only

253-500-101

C Knife only

253-500-102

D Set with 3 atraumatic tip only

253-500-108

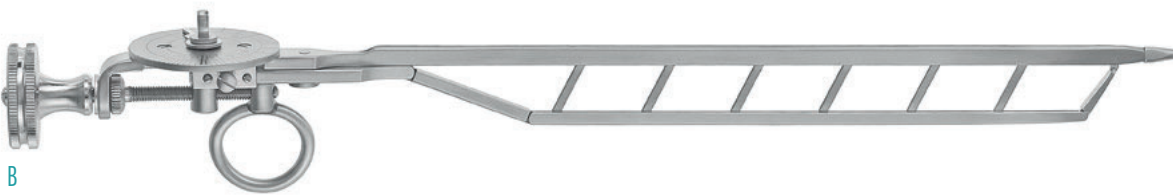

B



C



D



KEITZER

Urethrotome, complete

253-500-104

Urethrotome only

253-500-105

Knife only, pointed

253-500-106

Knife only, blunt

253-500-116

