

CLAMPS AND FORCEPS

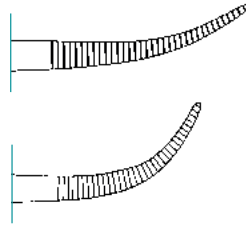

Hemostatic Forceps
Dissecting Forceps
Tissue Forceps
Intestinal Forceps
Towel Forceps
Tubing Clamps
Dressing and Sponge Forceps



JACOBSON

Hemostatic Forceps, delicate, 0.3mm tip, curved

100mm, 4"	140-161-100
130mm, 5 ¹ / ₈ "	140-161-130
190mm, 7 ¹ / ₂ "	140-161-190
fully curved	
130mm, 5 ¹ / ₈ "	140-162-130
190mm, 7 ¹ / ₂ "	140-162-190

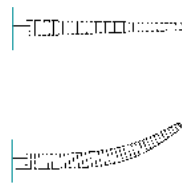

MICRO HALSTEAD MOSQUITO

Hemostatic Forceps, straight

100mm, 4"	140-270-100
120mm, 4 ³ / ₄ "	140-270-120
curved	
100mm, 4"	140-271-100
120mm, 4 ³ / ₄ "	140-271-120
straight, 1x2 teeth	
100mm, 4"	140-272-100
120mm, 4 ³ / ₄ "	140-272-120
curved, 1x2teeth	
100mm, 4"	140-273-100
120mm, 4 ³ / ₄ "	140-273-120

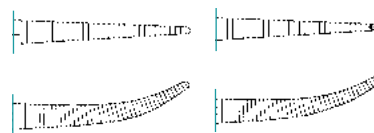

HALSTEAD MOSQUITO

Hemostatic Forceps, serrated, straight

125mm, 5"	140-254-125
140mm, 5 ¹ / ₂ "	140-254-140
180mm, 7"	140-254-180
210mm, 8 ¹ / ₄ "	140-254-210
serrated, curved	
125mm, 5"	140-255-125
140mm, 5 ¹ / ₂ "	140-255-140
180mm, 7"	140-255-180
210mm, 8 ¹ / ₄ "	140-255-210

1x2 teeth, straight

125mm, 5"	140-256-125
140mm, 5 ¹ / ₂ "	140-256-140
180mm, 7"	140-256-180
210mm, 8 ¹ / ₄ "	140-256-210

1x2 teeth, curved

125mm, 5"	140-257-125
140mm, 5 ¹ / ₂ "	140-257-140
180mm, 7"	140-257-180
210mm, 8 ¹ / ₄ "	140-257-210

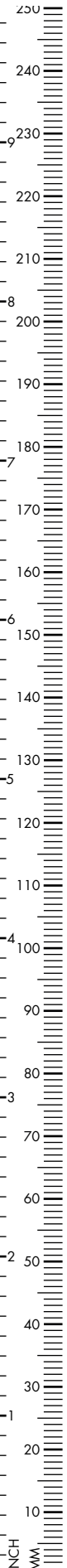

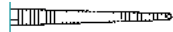
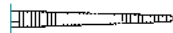

HARTMANN MOSQUITO

Hemostatic Forceps, serrated, straight

100mm, 4" 140-250-100

1x2 teeth, straight

100mm, 4" 140-248-100

serrated, curved

100mm, 4" 140-251-100

1x2 teeth, curved

100mm, 4" 140-249-100

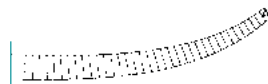
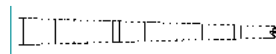
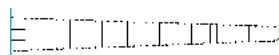

CRILE

Hemostatic Forceps, serrated, straight

140mm, 5 1/2" 140-290-140

1x2 teeth, straight

140mm, 5 1/2" 140-292-140

serrated, curved

140mm, 5 1/2" 140-291-140

1x2 teeth, curved

140mm, 5 1/2" 140-293-140



BABY CRILE

Hemostatic Forceps, 140mm, 5 1/2"

serrated, straight 140-334-140

serrated, curved 140-335-140

1x2 teeth, straight 140-336-140

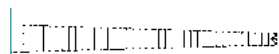
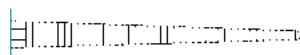

CRILE RANKIN

Hemostatic Forceps, serrated, straight

160mm, 6 1/4" 140-294-160

1x2 teeth, straight

160mm, 6 1/4" 140-296-160

serrated, curved

160mm, 6 1/4" 140-295-160

1x2 teeth, curved

160mm, 6 1/4" 140-297-160

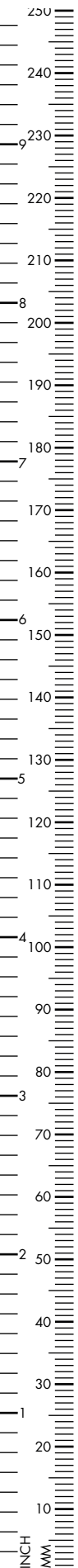

KELLY

Hemostatic Forceps, straight

140mm, 5 ¹ / ₂ "	140-280-140
--	-------------

curved

140mm, 5 ¹ / ₂ "	140-281-140
--	-------------



SPENCER WELLS

Hemostatic Forceps, serrated, straight

130mm, 5 ¹ / ₈ "	140-150-130
--	-------------

150mm, 6"	140-150-150
-----------	-------------

180mm, 7"	140-150-180
-----------	-------------

200mm, 8"	140-150-200
-----------	-------------

curved

130mm, 5 ¹ / ₈ "	140-151-130
--	-------------

150mm, 6"	140-151-150
-----------	-------------

180mm, 7"	140-151-180
-----------	-------------

200mm, 8"	140-151-200
-----------	-------------

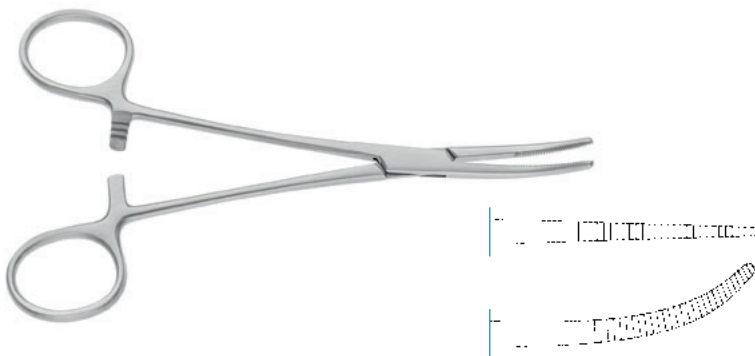

KELLY RANKIN

Hemostatic Forceps, straight

160mm, 6 ¹ / ₄ "	140-286-160
--	-------------

curved

160mm, 6 ¹ / ₄ "	140-287-160
--	-------------

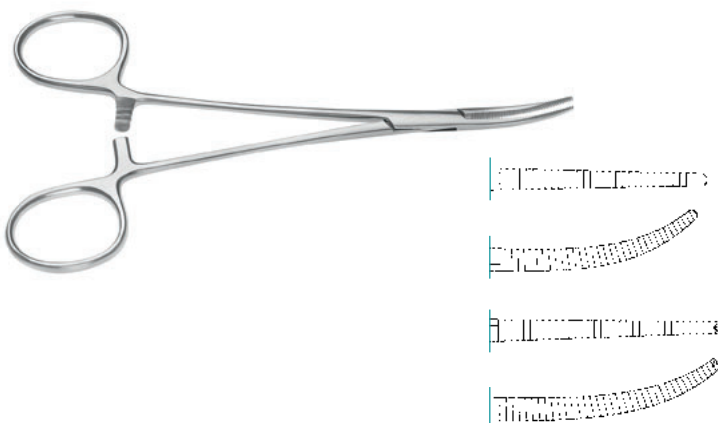

LERICHE

Hemostatic Forceps, 150mm, 6"

straight	140-276-150
----------	-------------

curved	140-277-150
--------	-------------

straight, 1x2 teeth	140-278-150
---------------------	-------------

curved, 1x2 teeth	140-279-150
-------------------	-------------

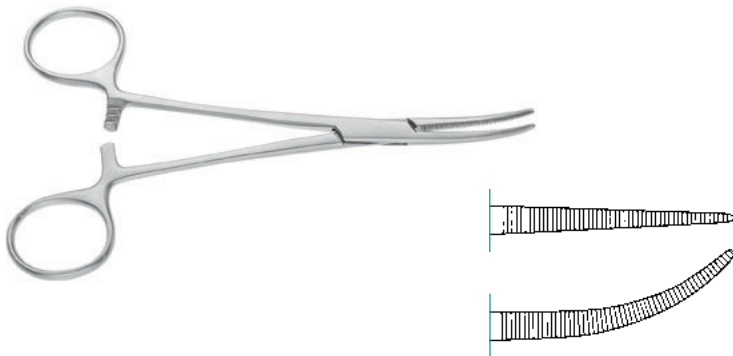

COLLER

Hemostatic Forceps, serrated, straight

140mm, 5¹/₂" 140-288-140

160mm, 6¹/₄" 140-288-160

curved

140mm, 5¹/₂" 140-289-140

160mm, 6¹/₄" 140-289-160

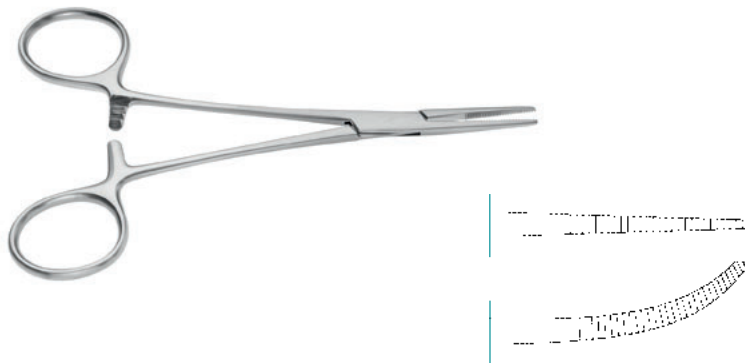

PROVIDENCE HOSPITAL

Hemostatic Forceps, serrated, straight

140mm, 5¹/₂" 140-274-140

curved

140mm, 5¹/₂" 140-275-140

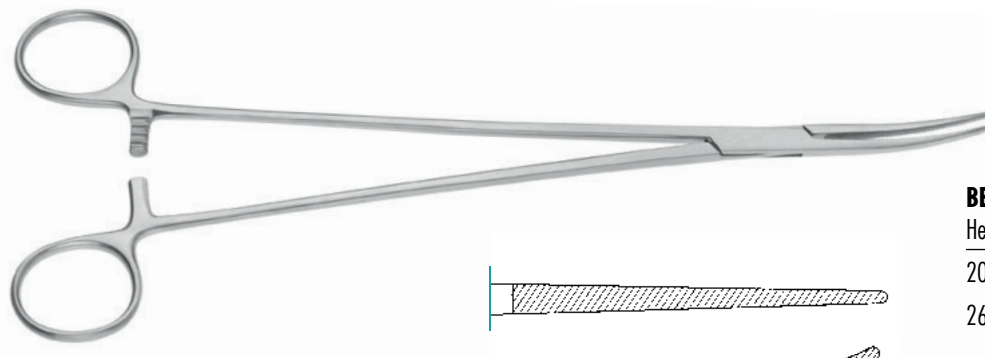

BENGOLEA

Hemostatic Forceps, serrated, straight

200mm, 8" 140-140-200

260mm, 10¹/₄" 140-140-260

serrated, curved

200mm, 8" 140-141-200

260mm, 10¹/₄" 140-141-260

1x2 teeth, straight

200mm, 8" 140-142-200

260mm, 10¹/₄" 140-142-260

1x2 teeth, curved

200mm, 8" 140-143-200

260mm, 10¹/₄" 140-143-260

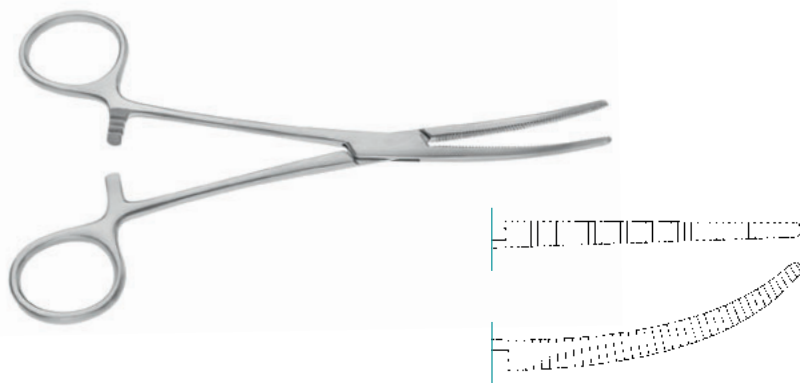

ROCHESTER PEAN

Hemostatic Forceps, serrated, straight

140mm, 5 ¹ / ₂ "	140-330-140
160mm, 6 ¹ / ₄ "	140-330-160
180mm, 7"	140-330-180
200mm, 8"	140-330-200
220mm, 8 ² / ₃ "	140-330-220
240mm, 9 ¹ / ₂ "	140-330-240
260mm, 10 ¹ / ₄ "	140-330-260
300mm, 11 ⁷ / ₈ "	140-330-300
355mm, 14"	140-330-355

curved

140mm, 5 ¹ / ₂ "	140-331-140
160mm, 6 ¹ / ₄ "	140-331-160
180mm, 7"	140-331-180
200mm, 8"	140-331-200
220mm, 8 ² / ₃ "	140-331-220
240mm, 9 ¹ / ₂ "	140-331-240
260mm, 10 ¹ / ₄ "	140-331-260
300mm, 11 ⁷ / ₈ "	140-331-300
355mm, 14"	140-331-355

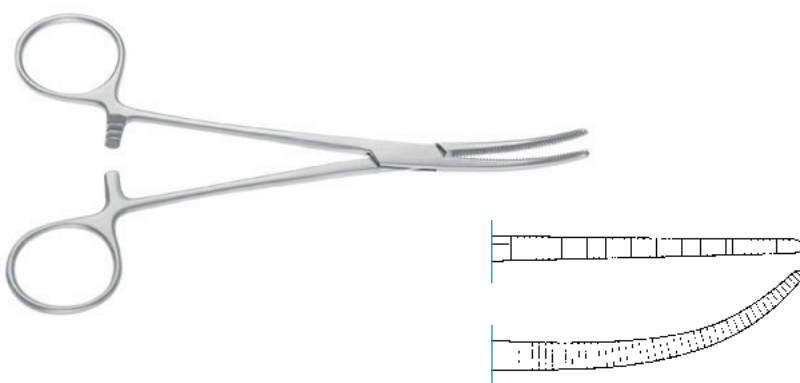

PEAN

Hemostatic Forceps, delicate, serrated, straight

130mm, 5 ¹ / ₈ "	140-316-130
140mm, 5 ¹ / ₂ "	140-316-140
160mm, 6 ¹ / ₄ "	140-316-160

curved

130mm, 5 ¹ / ₈ "	140-317-130
140mm, 5 ¹ / ₂ "	140-317-140
160mm, 6 ¹ / ₄ "	140-317-160

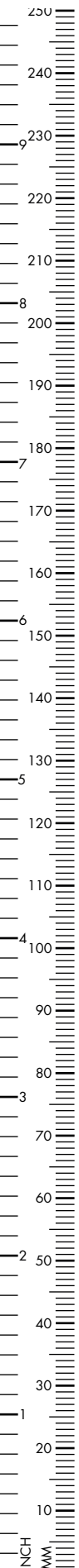

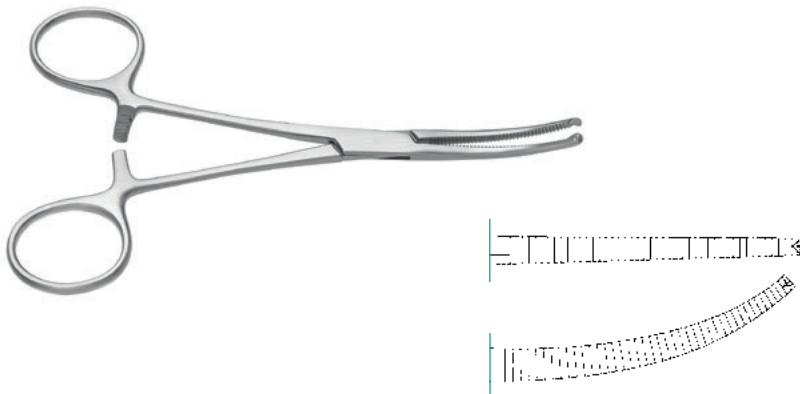

KOCHER OCHSNER

Hemostatic Forceps, 1x 2 teeth, straight

140mm, 5 ¹ / ₂ "	140-332-140
160mm, 6 ¹ / ₄ "	140-332-160
180mm, 7"	140-332-180
200mm, 8"	140-332-200
220mm, 8 ² / ₃ "	140-332-220
240mm, 9 ¹ / ₂ "	140-332-240
260mm, 10 ¹ / ₄ "	140-332-260
300mm, 11 ⁷ / ₈ "	140-332-300
355mm, 14"	140-332-355

curved

140mm, 5 ¹ / ₂ "	140-333-140
160mm, 6 ¹ / ₄ "	140-333-160
180mm, 7"	140-333-180
200mm, 8"	140-333-200
220mm, 8 ² / ₃ "	140-333-220
240mm, 9 ¹ / ₂ "	140-333-240
260mm, 10 ¹ / ₄ "	140-333-260
300mm, 11 ⁷ / ₈ "	140-333-300
355mm, 14"	140-333-355

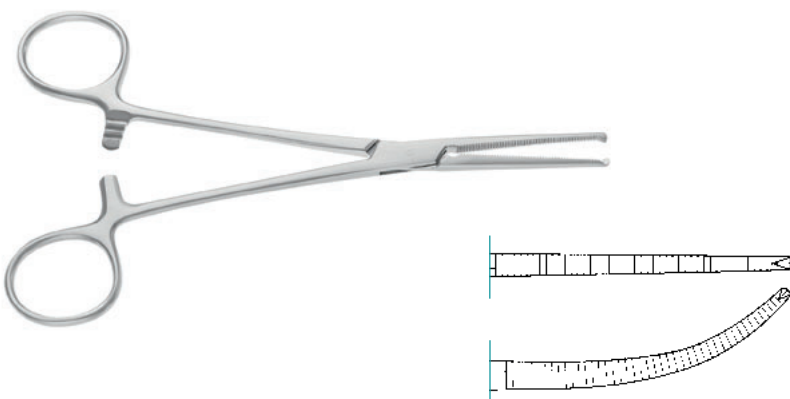

KOCHER

Delicate Hemostatic Forceps, 1x2 teeth, straight

130mm, 5 ¹ / ₈ "	140-318-130
140mm, 5 ¹ / ₂ "	140-318-140
160mm, 6 ¹ / ₄ "	140-318-160

curved

130mm, 5 ¹ / ₈ "	140-319-130
140mm, 5 ¹ / ₂ "	140-319-140
160mm, 6 ¹ / ₄ "	140-319-160

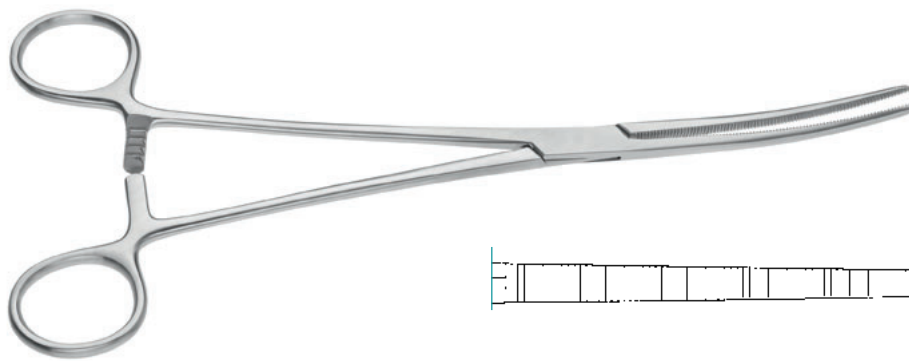

SAROT

Hemostatic Forceps, 240mm, 9¹/₂"

straight	140-348-240
curved	140-349-240

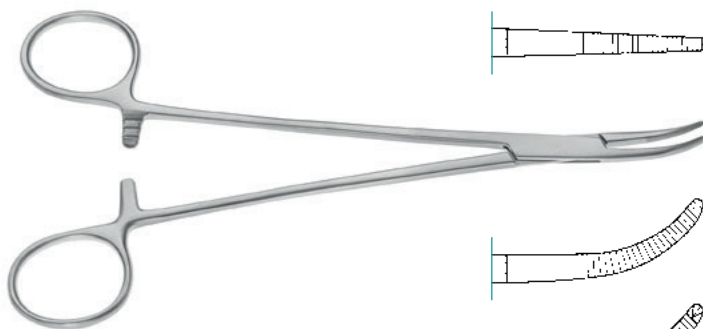

ADSON

Hemostatic Forceps, 185mm, 7¹/₄"

serrated, straight	140-366-185
serrated, curved	140-367-185
straight, 1x2 teeth	140-372-185
curved, 1x2 teeth	140-373-185



BIRKETT

Hemostatic Forceps, serrated, 185mm, 7¹/₄"

straight	140-368-185
curved	140-369-185

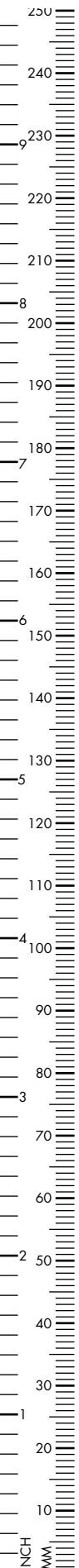

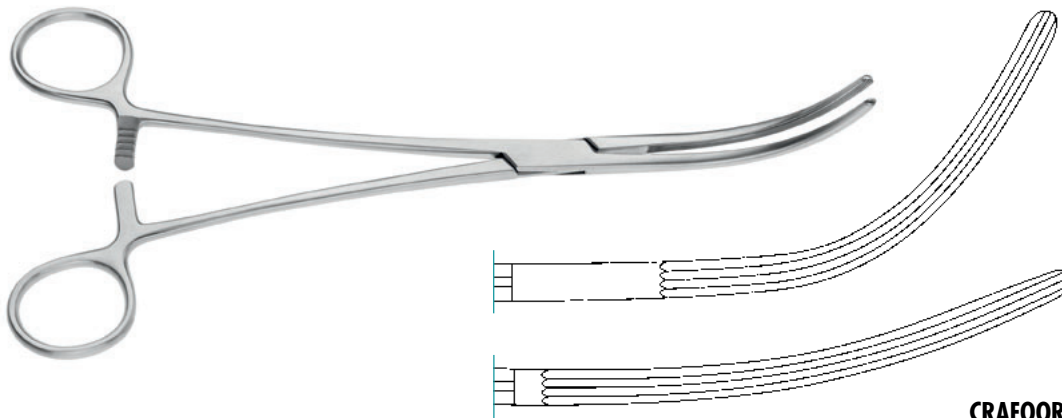

CRAFOORD

Vascular Clamp, longitudinal serration, slightly curved, elastic jaw

230mm, 9"	140-383-230
-----------	-------------

medium curved

240mm, 9 ¹ / ₂ "	140-385-240
--	-------------

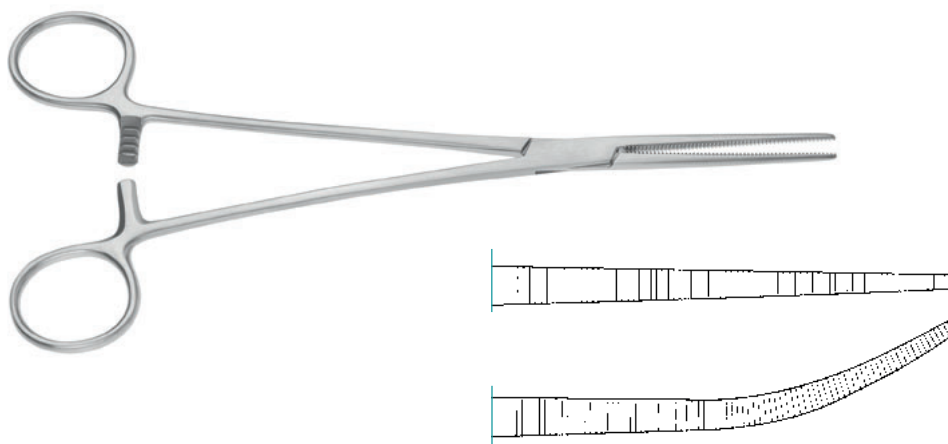

ROBERTS

Hemostatic Forceps, 220mm, 8²/₃"

straight	140-452-220
----------	-------------

curved	140-453-220
--------	-------------

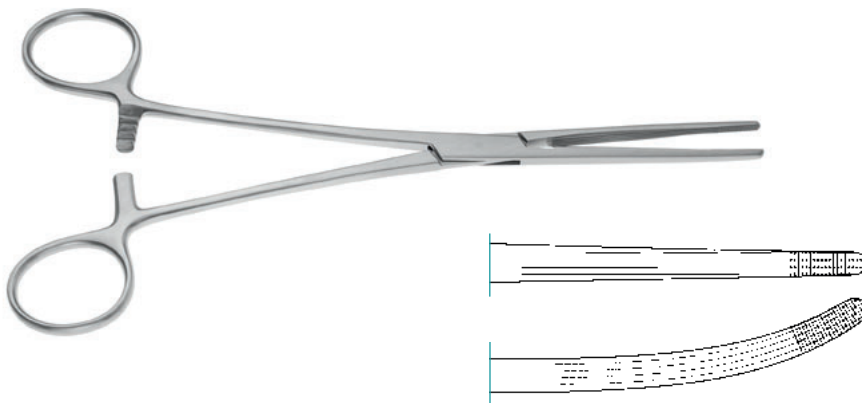
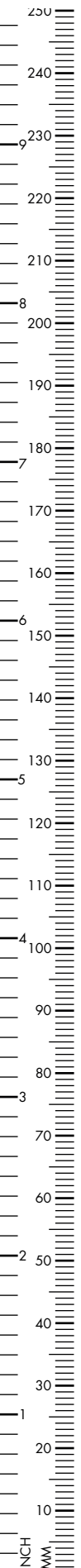

ROCHESTER CARMALT

Hemostatic Forceps, longitudinal serration, cross-serrated tip, straight

160mm, 6¹/₄" 140-314-160

200mm, 8" 140-314-200

curved

160mm, 6¹/₄" 140-315-160

200mm, 8" 140-315-200

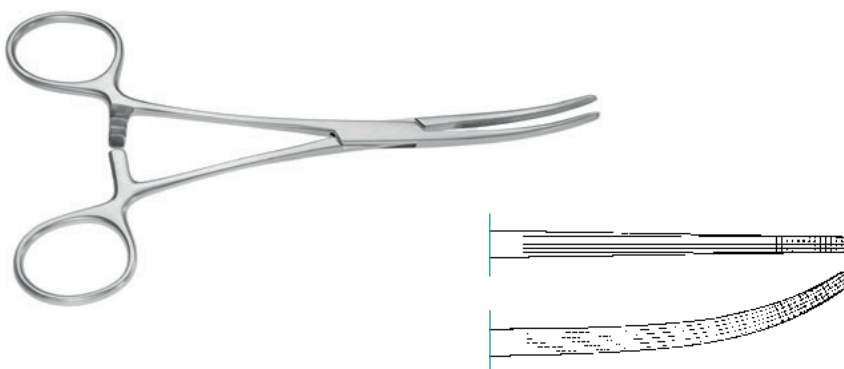

BAINBRIDGE

Intestinal Forceps, longitudinal serration, cross-serrated tip, straight

150mm, 6" 140-442-150

185mm, 7¹/₄" 140-442-185

curved

150mm, 6" 140-443-150

185mm, 7¹/₄" 140-443-185

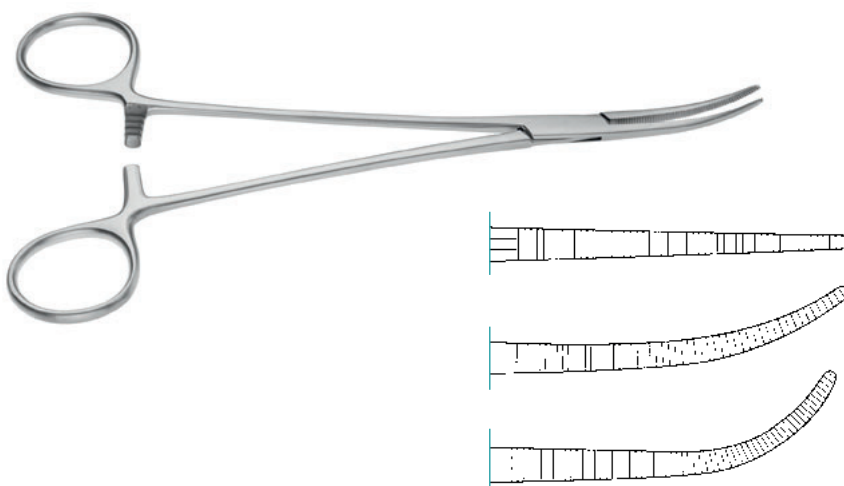

HEISS

Dissecting and Ligature Forceps, straight, Fig. 1

200mm, 8" 140-340-200

slightly curved, Fig. 2

200mm, 8" 140-341-200

strongly curved, Fig. 3

200mm, 8" 140-343-200

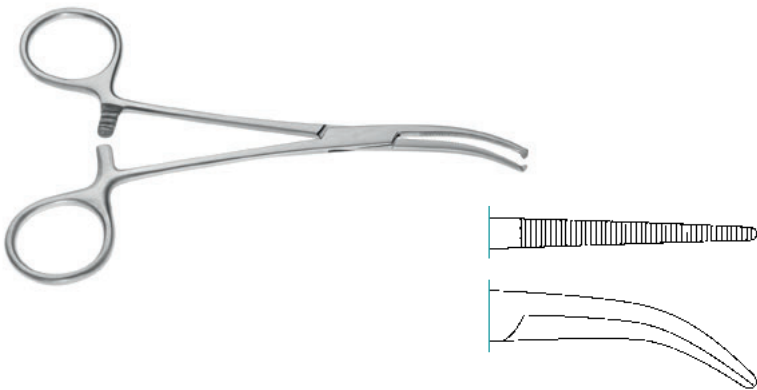

DANDY

Hemostatic Forceps, laterally curved,
140mm, 5¹/₂"

serrated	140-301-140
1x2 teeth	140-303-140

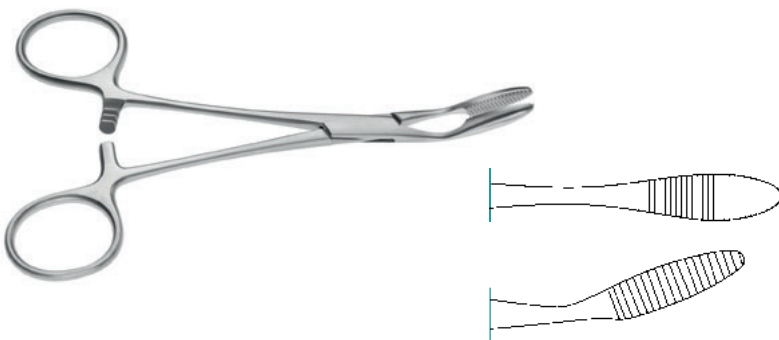

PEAN

Hemostatic Forceps, serrated, straight

125mm, 4 ³ / ₄ "	140-228-125
140mm, 5 ¹ / ₂ "	140-228-140
160mm, 6 ¹ / ₄ "	140-228-160
curved	
140mm, 5 ¹ / ₂ "	140-229-140

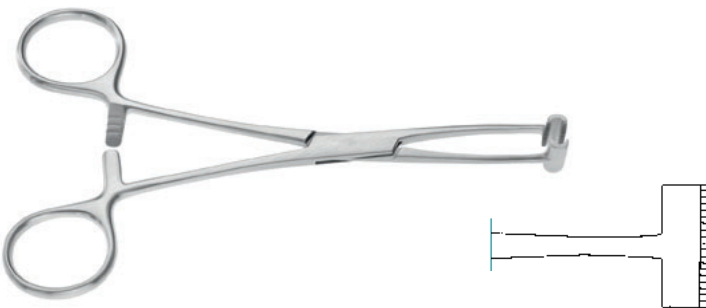

PRATT

T-Clamp, straight

150mm, 6"	140-282-150
-----------	-------------

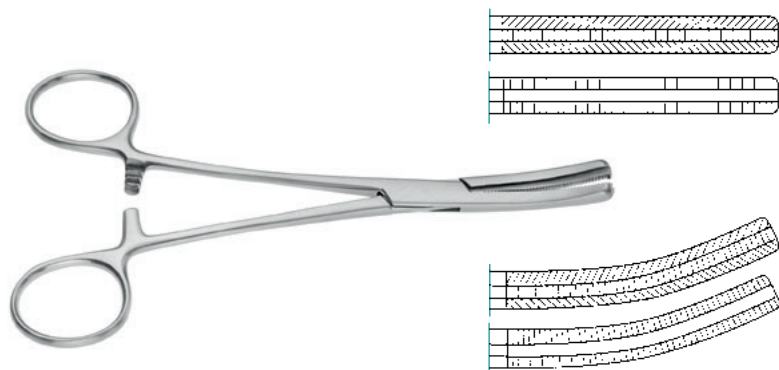

FERGUSON

Pressure Clamp, straight

160mm, 6 ¹ / ₄ "	140-300-160
curved	
160mm, 6 ¹ / ₄ "	140-301-160

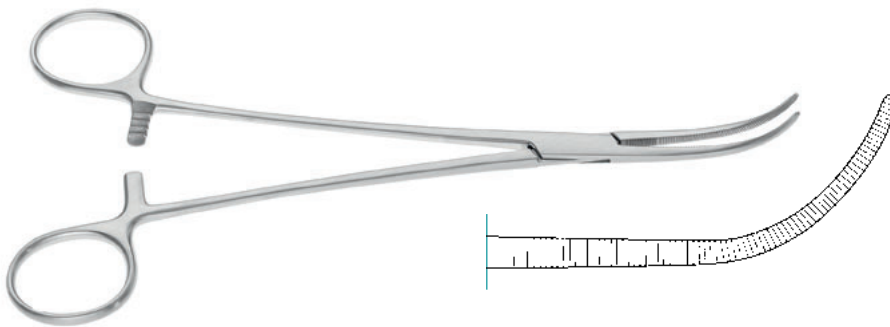

OVERHOLT MIXER

Dissecting and Ligature Forceps, curved

210mm, 8¹/₄" 140-345-210

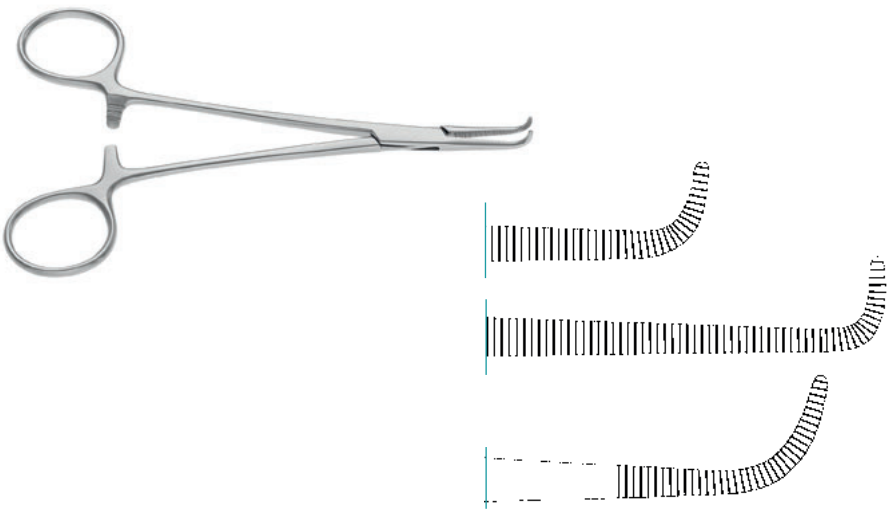

DIETRICH

Clamp, serrated, right angled

125mm, 5" 140-401-125

140mm, 5¹/₂" 140-401-140

180mm, 7" 140-401-180

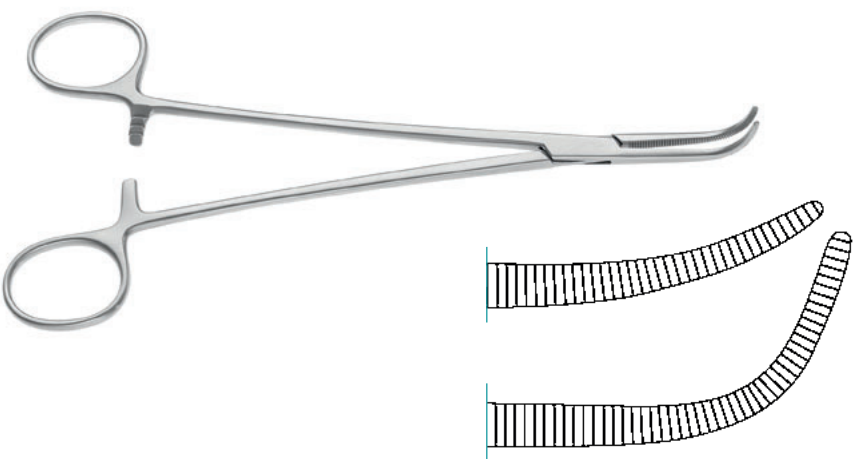

VARCO

Gallbladder Forceps, slightly curved

190mm, 7¹/₂" 140-403-190

fully curved

200mm, 8" 140-403-200

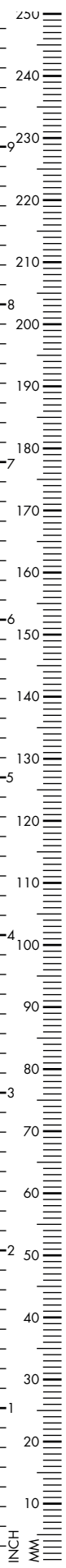

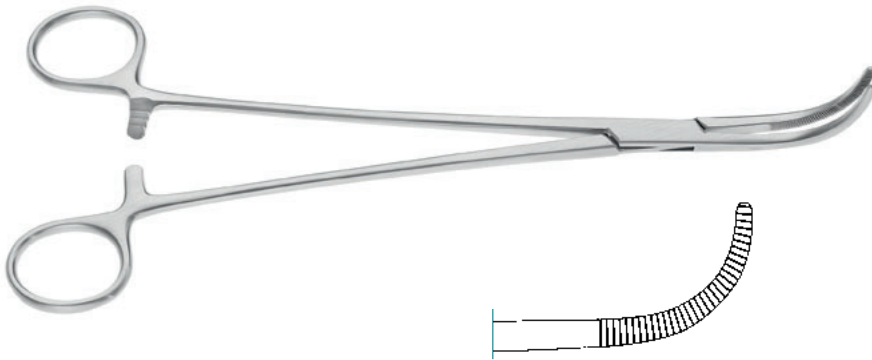

MIXER

Dissecting and Ligature Forceps,
partially serrated

220mm, 8 ² / ₃ "	140-427-220
230mm, 9"	140-429-230

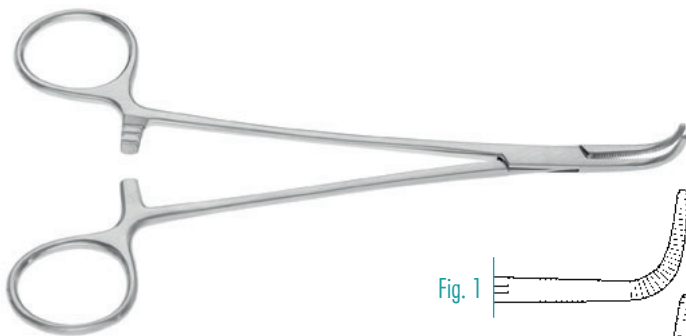

Fig. 1

Fig. 2

MEEKER

Kidney Pedicle Clamp, curved,
Fig. 1

180mm, 7"	140-619-180
-----------	-------------

Fig. 2

280mm, 11"	140-619-275
------------	-------------

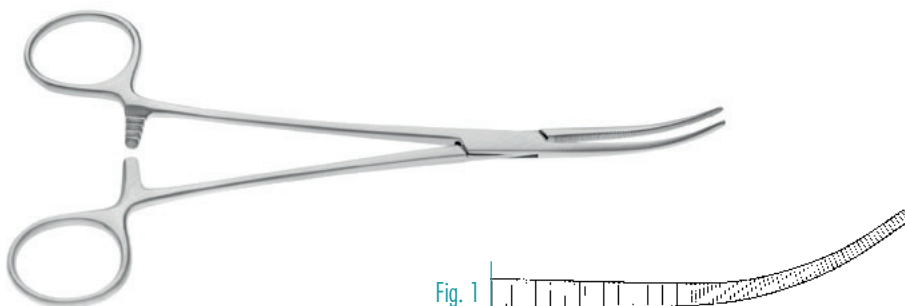

Fig. 1

Fig. 2

Fig. 3

KELLY

Dissecting Forceps, fully serrated,
Fig. 1

190mm, 7 ¹ / ₂ "	140-633-190
220mm, 8 ² / ₃ "	140-633-220
240mm, 9 ¹ / ₂ "	140-633-240

Fig. 2

190mm, 7 ¹ / ₂ "	140-635-190
220mm, 8 ² / ₃ "	140-635-220
240mm, 9 ¹ / ₂ "	140-635-240

Fig. 3

190mm, 7 ¹ / ₂ "	140-637-190
220mm, 8 ² / ₃ "	140-637-220
240mm, 9 ¹ / ₂ "	140-637-240

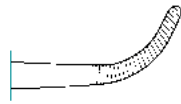

BABY MIXTER

Dissecting and Ligature Forceps,
serrated, curved

140mm, 5¹/₂"

140-421-140

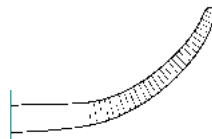

BABY MIXTER

Dissecting and Ligature Forceps,
serrated, curved

180mm, 7"

140-337-180

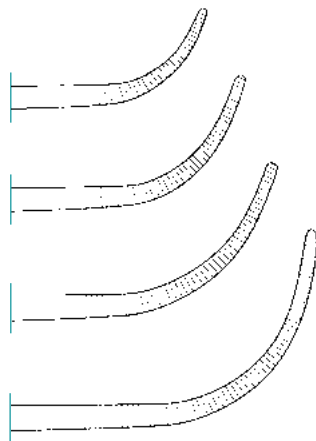
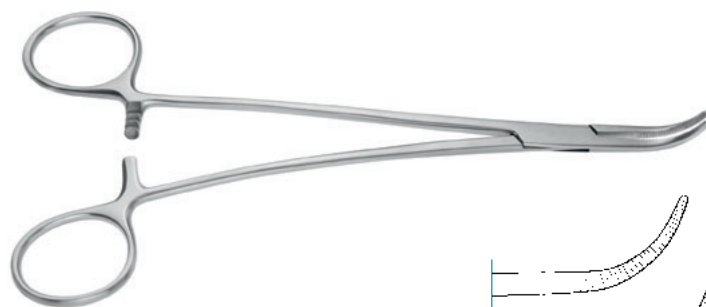

OVERHOLT

Dissecting and Ligature Forceps,
serrated, s-curved

185mm, 7¹/₂"

140-135-185

205mm, 8"

140-135-205

210mm, 8¹/₄"

140-135-210

215mm, 8¹/₂"

140-135-215

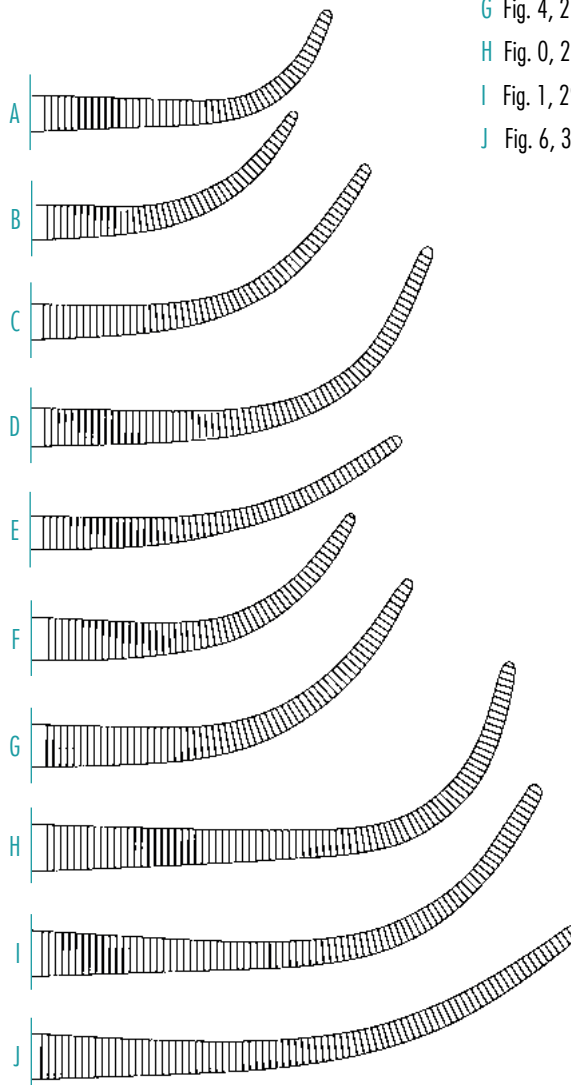

OVERHOLT

Ligature Forceps, fully serrated jaw, curved

A	Fig. 0, 215mm, 8 ¹ / ₂ "	140-137-000
B	Fig. 1, 210mm, 8 ¹ / ₄ "	140-137-001
C	Fig. 2, 220mm, 8 ² / ₃ "	140-137-002
D	Fig. 3, 225mm, 8 ⁷ / ₈ "	140-137-003
E	Fig. 6, 225mm, 8 ⁷ / ₈ "	140-137-006
F	Fig. 1, 270mm, 10 ² / ₃ "	140-137-008
G	Fig. 4, 270mm, 10 ² / ₃ "	140-137-014
H	Fig. 0, 295mm, 11 ² / ₃ "	140-137-010
I	Fig. 1, 295mm, 11 ² / ₃ "	140-137-011
J	Fig. 6, 300mm, 11 ⁷ / ₈ "	140-137-016

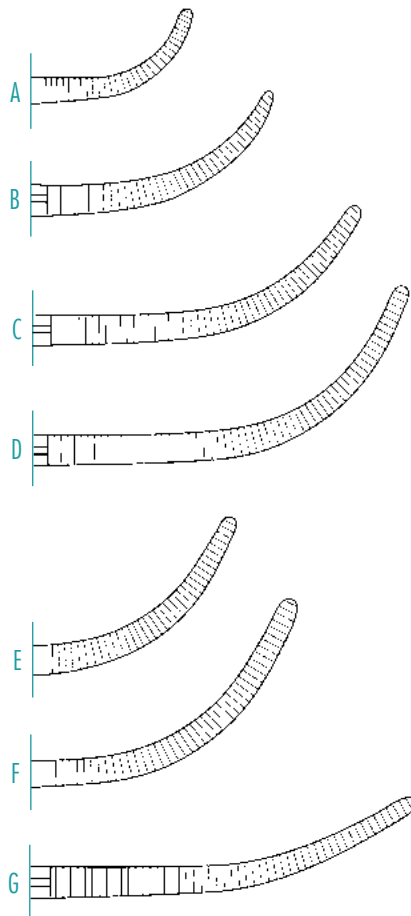

OVERHOLT

Dissecting and Ligature Forceps,
fully serrated, curved

A Fig. 0,	140-443-001
195mm, 7 ³ / ₄ "	
B Fig. 1,	140-443-002
210mm, 8 ¹ / ₄ "	
C Fig. 2,	140-443-003
220mm, 8 ² / ₃ "	
D Fig. 3,	140-443-004
225mm, 8 ⁷ / ₈ "	
E Fig. 4,	140-443-005
210mm, 8 ¹ / ₄ "	
F Fig. 5,	140-443-006
230mm, 9"	
G Fig. 6,	140-443-007
225mm, 8 ⁷ / ₈ "	



BABY OVERHOLT

Hemostatic Forceps, fully serrated, curved

130mm, 5¹/₈" 140-285-135

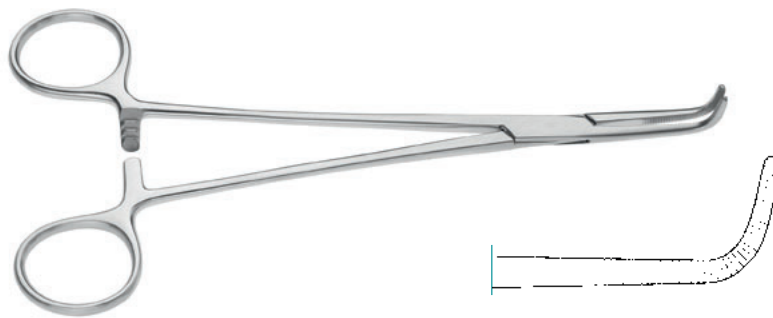

KANTROWITZ

Thorax Forceps, serrated, curved

190mm, 7¹/₂" 140-417-190

240mm, 9¹/₂" 140-417-240

280mm, 11" 140-417-280

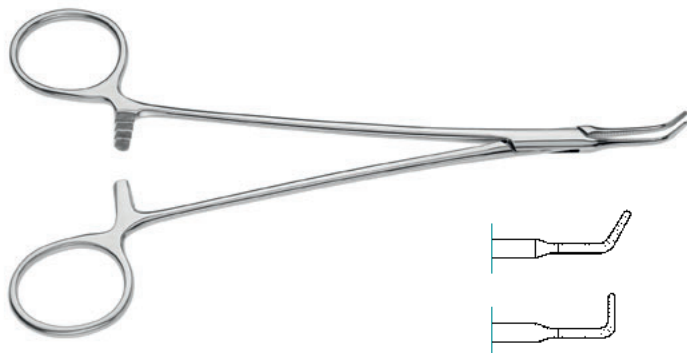

BAILEY

Hemostatic Forceps, very fine jaw, serrated,
60° angled, polished jaw

200mm, 8" 140-144-060

90° angled

180mm, 7" 140-144-090



MICRO ADSON

Dissecting Forceps, curved

140mm, 5^{1/2}"

140-338-140



BABY ADSON

Dissecting Forceps, curved

140mm, 5^{1/2}"

140-339-140

180mm, 7"

140-339-180

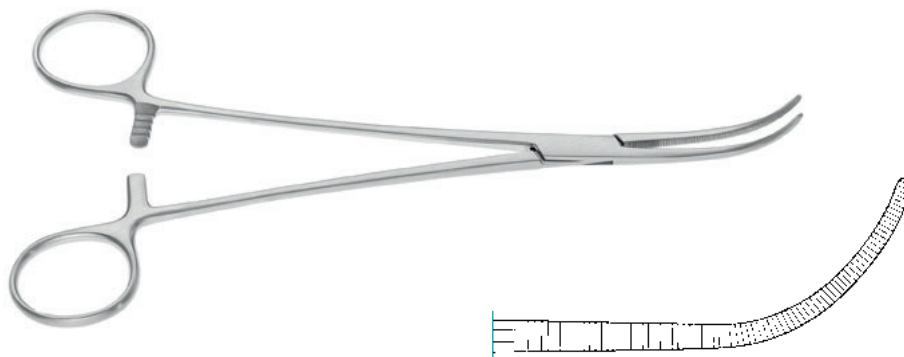

OVERHOLT MIXTER

Ligature Forceps, curved

210mm, 8^{1/4}"

140-345-210

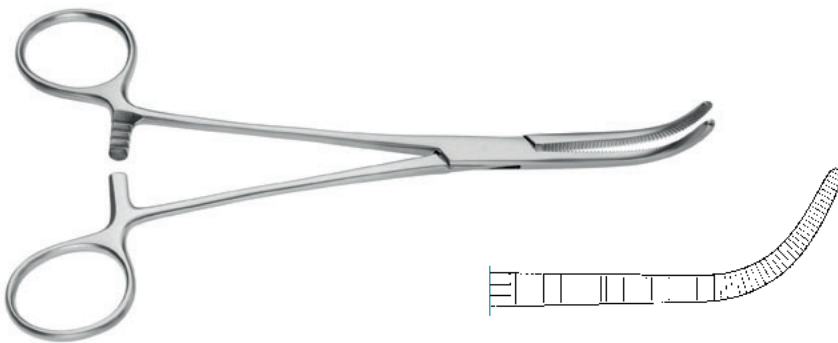

MIXER O'SHAUGHNESSY

Hemostatic Forceps, curved

155mm, 6¹/₈" 140-425-155

190mm, 7¹/₂" 140-425-190



MIXER

Gall Duct Clamp, longitudinal serrations

220mm, 8²/₃" 140-433-220

250mm, 9⁷/₈" 140-433-250

280mm, 11" 140-433-280

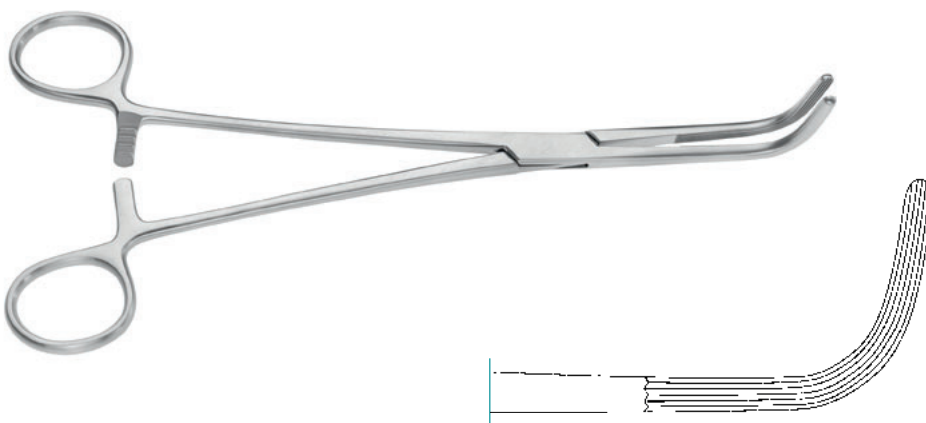

MCQUIGG MIXER

Hemostatic Forceps, longitudinal serration

220mm, 8²/₃" 140-435-220



FINOCHIETTO

Ligature Forceps, longitudinal serrations, with hole

240mm, 9¹/₂"

140-440-240

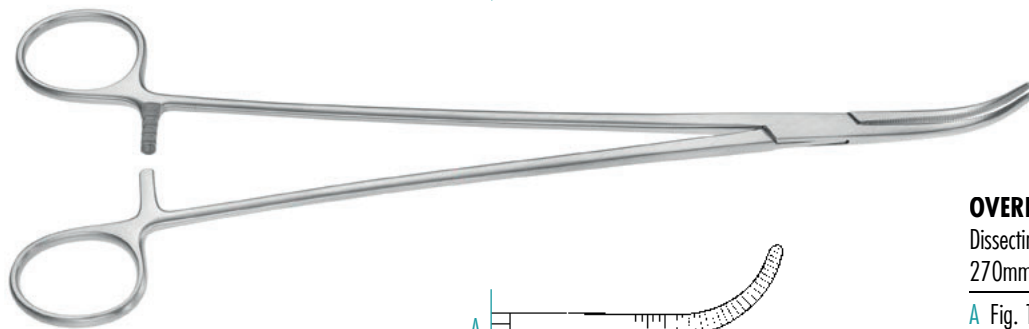
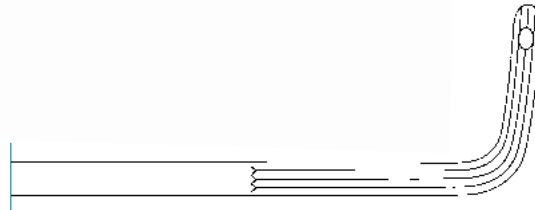

OVERHOLT GEISENDOERFER

Dissecting - and Ligature Forceps

270mm, 10²/₃"

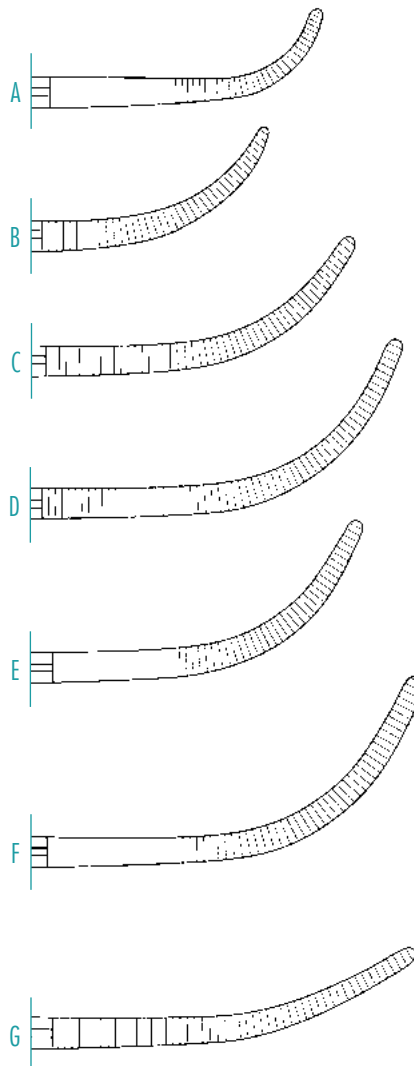

A Fig. 1	140-447-001
B Fig. 2	140-447-002
C Fig. 3	140-447-003
D Fig. 4	140-447-004
E Fig. 5	140-447-005
F Fig. 6	140-447-006
G Fig. 7	140-447-007

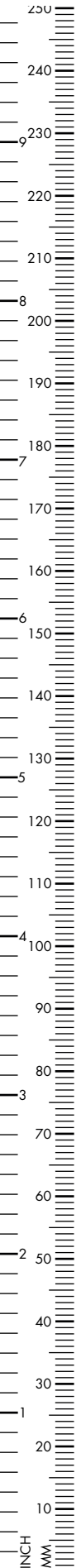

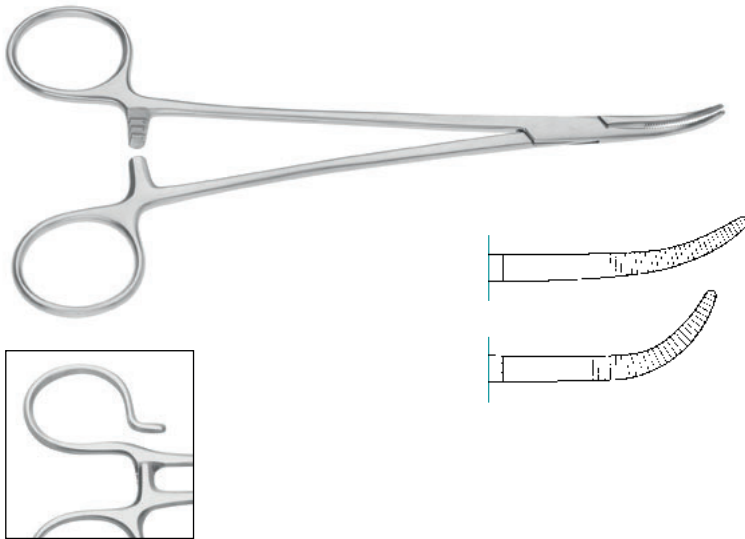

SCHNIDT SAWTELL

Tonsil Seizing Forceps, slightly curved

190mm, 7¹/₂" 140-628-190

strongly curved

190mm, 7¹/₂" 140-629-190

slightly curved, with one open ring

190mm, 7¹/₂" 140-630-190

strongly curved, with one open ring

190mm, 7¹/₂" 140-631-190

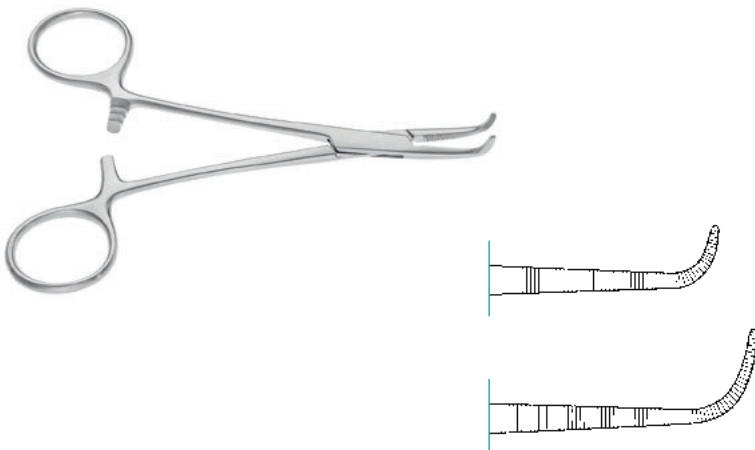

MINI GEMINI

Dissecting Forceps, fully serrated, curved

130mm, 5¹/₈" 140-359-130

160mm, 6¹/₄" 140-359-160

180mm, 7" 140-359-180

200mm, 8" 140-359-200

220mm, 8²/₃" 140-359-220

230mm, 9" 140-359-230

250mm, 9⁷/₈" 140-359-250

280mm, 11" 140-359-280

GEMINI

Dissecting Forceps, fully serrated, curved

130mm, 5¹/₈" 140-361-130

160mm, 6¹/₄" 140-361-160

180mm, 7" 140-361-180

200mm, 8" 140-361-200

220mm, 8²/₃" 140-361-220

230mm, 9" 140-361-230

250mm, 9⁷/₈" 140-361-250

280mm, 11" 140-361-280

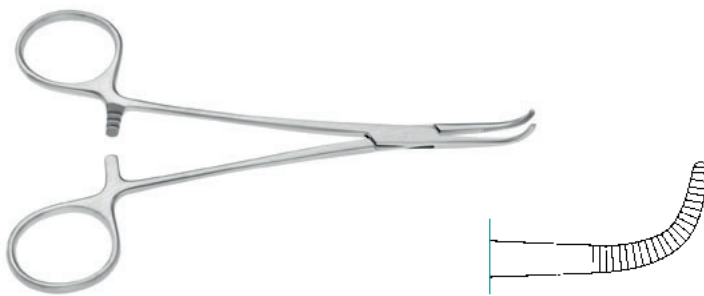

PETIT POINT MIXER

Artery Forceps, 90° angled

140mm, 5¹/₂" 140-373-140

180mm, 7" 140-373-180



BABY MIXER

Artery Forceps, slightly curved

140mm, 5¹/₂" 140-244-140

strongly curved

140mm, 5¹/₂" 140-245-140

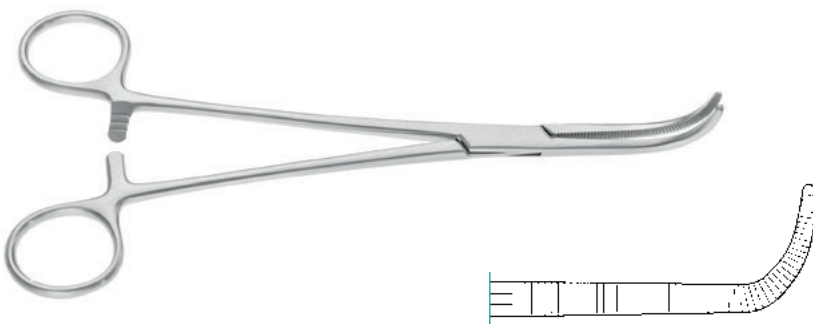

MIXER

Forceps, fully serrated

155mm, 6¹/₈" 140-423-155

190mm, 7¹/₂" 140-423-190

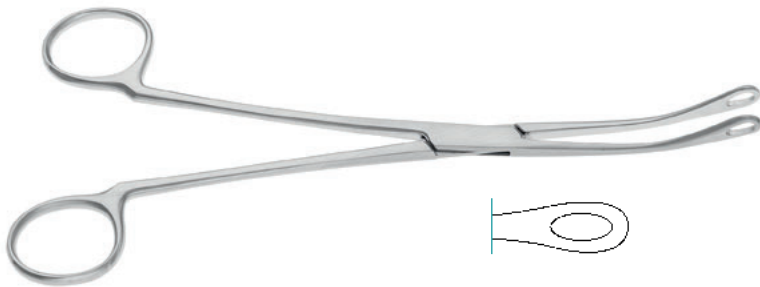

BLAKE

Gall Stone Forceps, 200mm, 8"

straight	320-117-200
curved	320-116-200

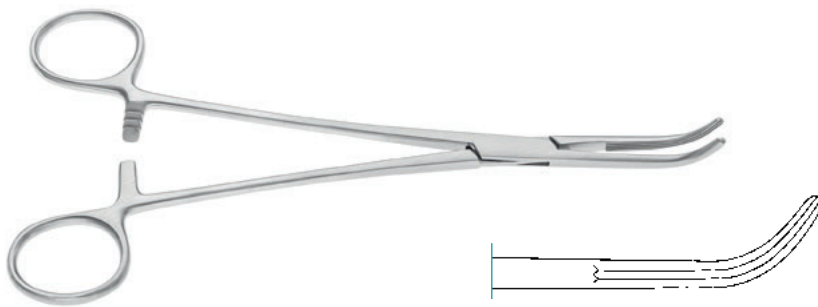

LAHEY

Gall Duct Forceps, curved, longitudinal serration

190mm, 7 ¹ / ₂ "	140-439-190
190mm, 7 ¹ / ₂ ", fine tip	140-432-190
230mm, 9"	140-439-230

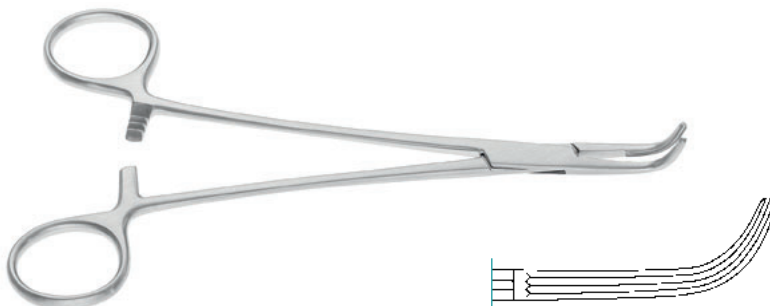

LOWER

Gall Duct Forceps, curved, longitudinal serration

185mm, 7 ¹ / ₄ "	140-437-180
--	-------------

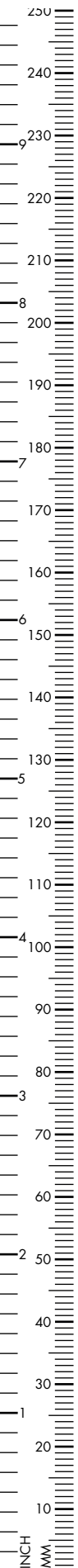

PETIT ALLIS

Tissue Forceps, 2x3 teeth

120mm, 4 ³ / ₄ "	310-008-120
--	-------------

150mm, 6"	310-008-150
-----------	-------------

3x4 teeth

120mm, 4 ³ / ₄ "	310-009-120
--	-------------

150mm, 6"	310-009-150
-----------	-------------

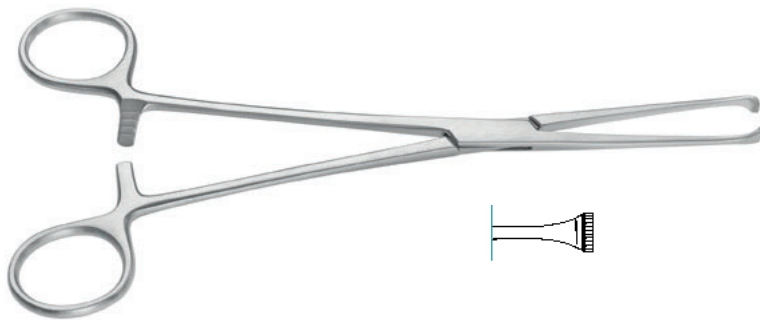

ALLIS

Tissue Forceps, 5mm wide, 4x5 teeth

200mm, 8"	310-031-200
-----------	-------------



BABY ALLIS

Tissue Forceps, 4x5 teeth

120mm, 4 ³ / ₄ "	310-010-120
--	-------------

150mm, 6"	310-010-150
-----------	-------------

190mm, 7 ¹ / ₂ "	310-010-190
--	-------------



ALLIS

Tissue Forceps, 7mm wide, 5x6 teeth

150mm, 6"	310-014-150
190mm, 7 ^{1/2} "	310-014-190
220mm, 8 ^{2/3} "	310-014-220
250mm, 9 ^{7/8} "	310-014-250



ALLIS ATRAUMA

Tissue Forceps, 7.3mm wide

160mm, 6 ^{1/4} "	310-020-160
200mm, 8"	310-020-200
250mm, 9 ^{7/8} "	310-020-250



JUDD ALLIS

Tissue Forceps, 3x4 teeth, 4mm wide

150mm, 6"	310-028-150
4.3mm wide	
190mm, 7 ^{1/2} "	310-026-190

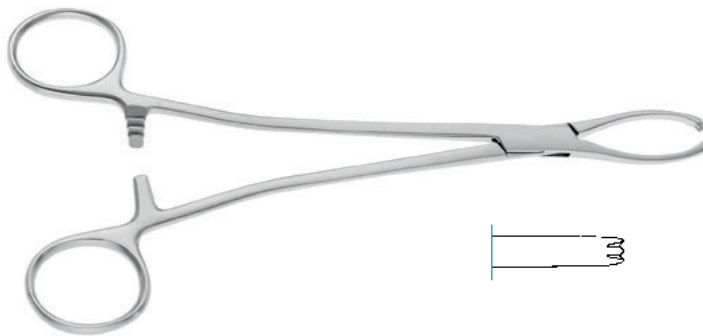

LITTLEWOOD

Tissue Forceps, 2x3 teeth

185mm, 7¹/₄"

310-025-185



ALLIS ADAIR

Tissue Forceps, 9x10 teeth, 10mm wide

155mm, 6¹/₈"

310-027-155

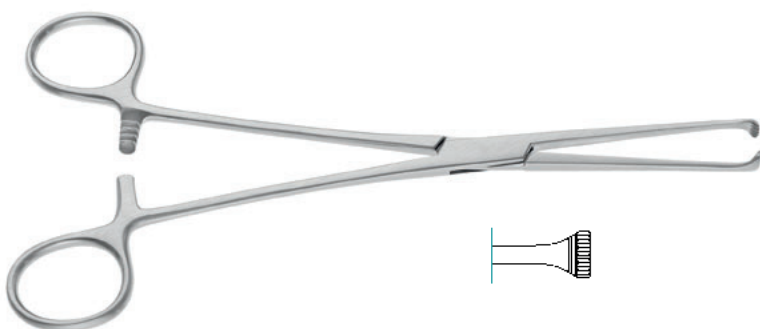

THOMS ALLIS

Tissue Forceps, 6x7 teeth, 7.25mm wide

200mm, 8"

310-030-200

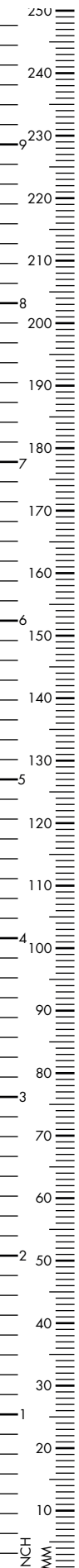



BOYS ALLIS

Tissue Grasping Forceps, 5x6 teeth,
5.2mm wide

155mm, 6^{1/8}" 310-029-155



LANE

Grasping Forceps, 1x2 teeth

150mm, 6" 310-030-150

195mm, 7^{3/4}" 310-030-195

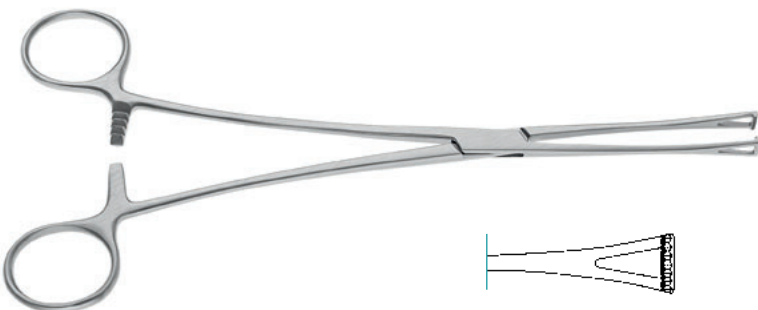

LOCKWOOD

Intestinal Grasping Forceps, 6mm wide

200mm, 8" 310-100-200

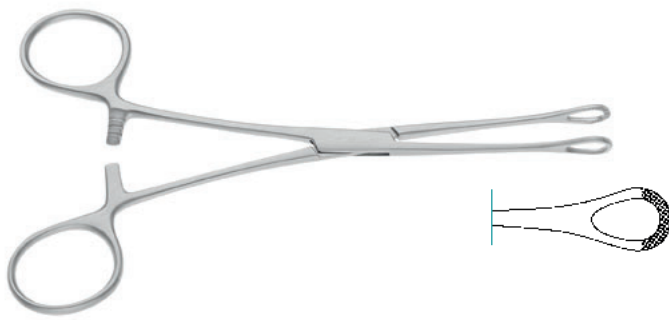
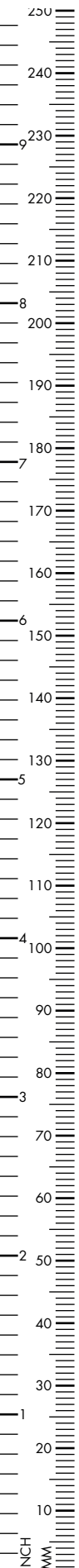

WILLIAMS

Intestinal Grasping Forceps, cross-serrated jaw
160mm, 6¹/₄" 310-115-160



PETIT BABCOCK

Intestinal Grasping Forceps, 5mm wide
130mm, 5¹/₈" 310-105-130

5.6mm wide

150mm, 6" 310-105-150

7.5mm wide

155mm, 6¹/₈" 310-105-155



BABCOCK

Tissue Forceps, 8mm wide
160mm, 6¹/₄" 310-110-160

10.5mm wide

180mm, 7" 310-110-180

11mm wide

200mm, 8" 310-110-200

11.8mm wide

240mm, 9¹/₂" 310-110-240

11.5mm wide

300mm, 11⁷/₈" 310-110-300

12mm wide

355mm, 14" 310-110-355



TC BABCOCK

Tissue Forceps, 8.5mm wide
160mm, 6¹/₄" 310-118-160

10.5mm wide

200mm, 8" 310-118-200



BABCOCK ATRAUMA

Tissue Forceps

160mm, 6 ^{1/4} "	310-111-160
200mm, 8"	310-111-200

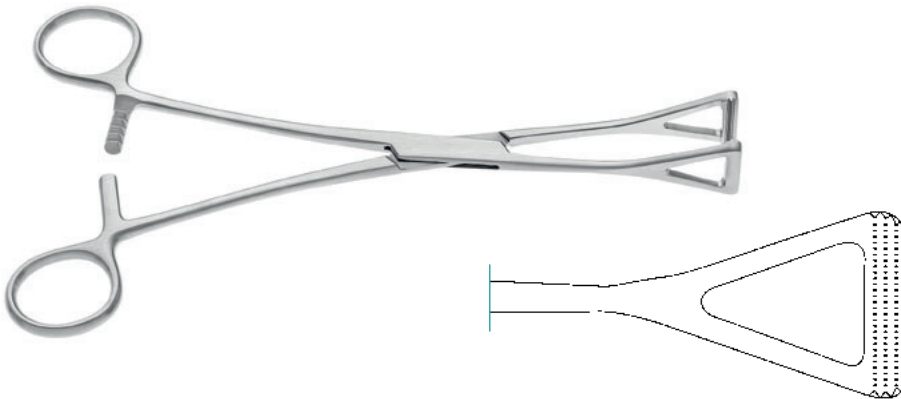

COLLIN ATRAUMA

Tissue Forceps

195mm, 7 ^{3/4} "	310-295-195
230mm, 9"	310-295-230

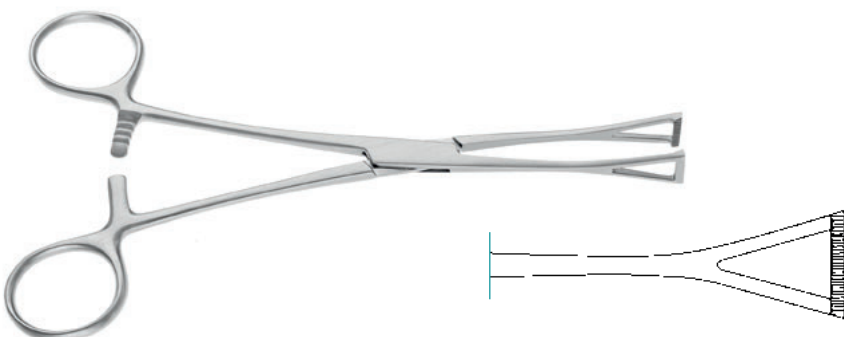

DUVAL

Tissue Forceps, 16mm wide

180mm, 7"	310-112-180
200mm, 8"	310-112-200

26mm wide

200mm, 8"	310-114-200
230mm, 9"	310-114-230

TC DUVAL

200mm, 8"	310-113-200
-----------	-------------

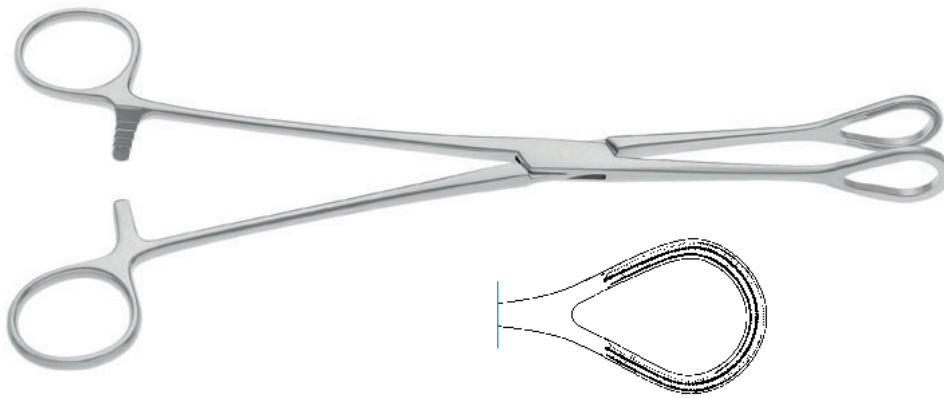
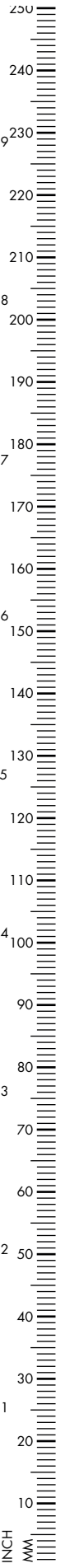

DEBAKEY ATRAUMA

Intestinal and Organ Grasping Forceps,
atraumatic serrations, small ring

250mm, 9⁷/₈" 140-220-250

large ring
260mm, 10¹/₄" 140-220-260



Tobacco Pouch
Colon Rectal Clamp

280mm, 11" 310-500-280



BENSON

Polyrus Spreader

155mm, 6¹/₈" 310-116-140



KLEINSCHMIDT

Appendectomy Clamp, 90° angled jaw

130mm, 5¹/₈" 140-397-130

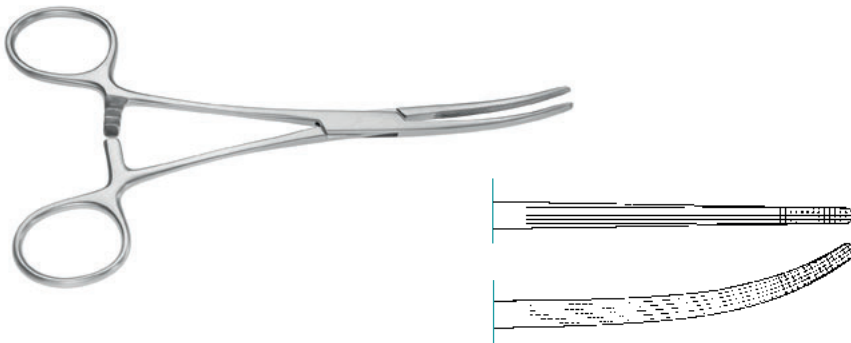

BAINBRIDGE

longitudinal serrations, cross-serrated tip,
straight

150mm, 6" 140-442-150

185mm, 7^{1/4}" 140-442-185

curved

150mm, 6" 140-443-150

185mm, 7^{1/4}" 140-443-185

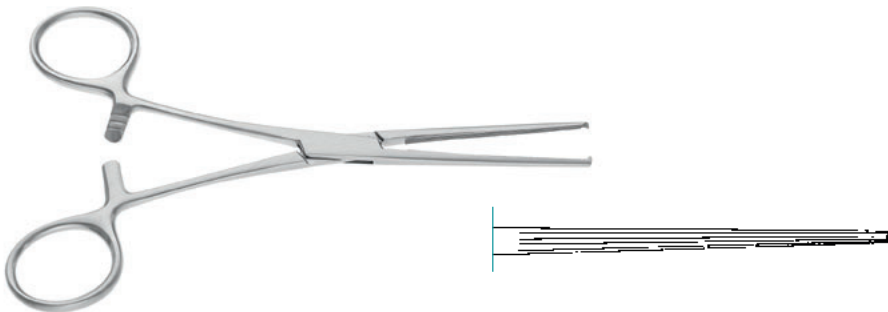

ALLEN

Intestinal Clamp, longitudinal serrations,
for children, 1x2 teeth

155mm, 6^{1/8}" 310-116-155

200mm, 8" 310-116-200

230mm, 9" 310-116-230



DENNIS

Anastomosis Clamp, longitudinal serrations,
55mm jaw length

230mm, 9" 310-117-230

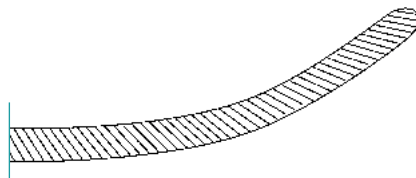
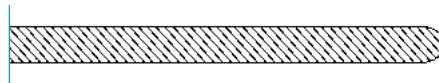
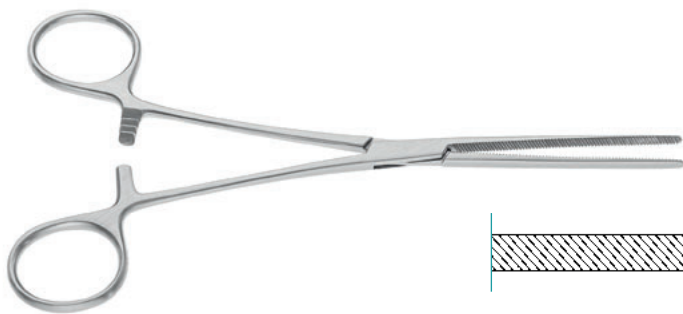

BABY DOYEN

Intestinal Clamp, diagonal serrations, elastic
180mm, 7"

straight	310-290-180
curved	310-291-180

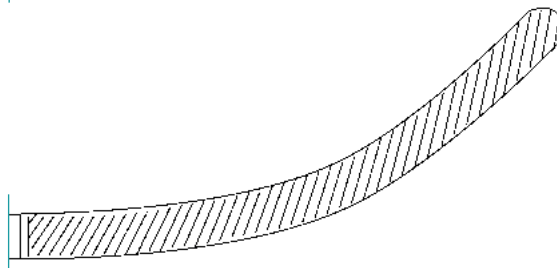
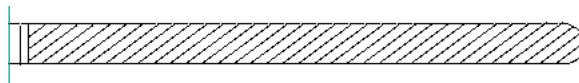
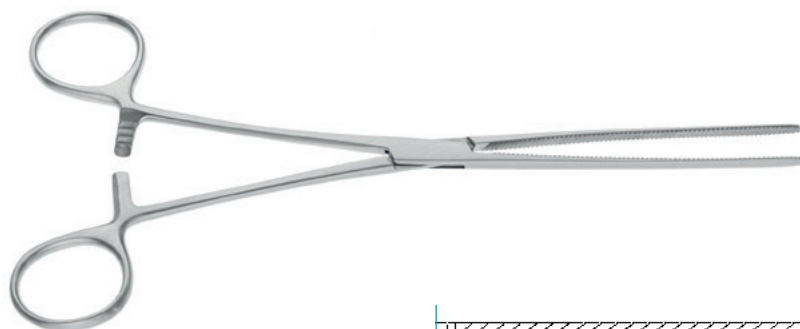

DOYEN

Intestinal Clamp, diagonal serrations, elastic,
straight

210mm, 8 ¹ / ₄ "	310-290-210
230mm, 9"	310-290-230

curved	
210mm, 8 ¹ / ₄ "	310-291-210
230mm, 9"	310-291-230

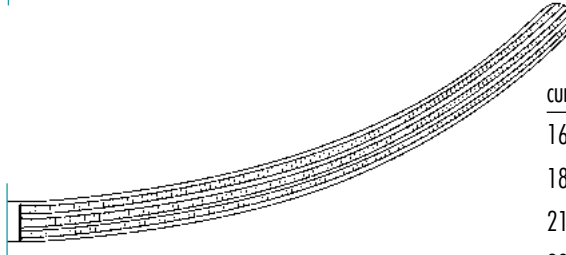
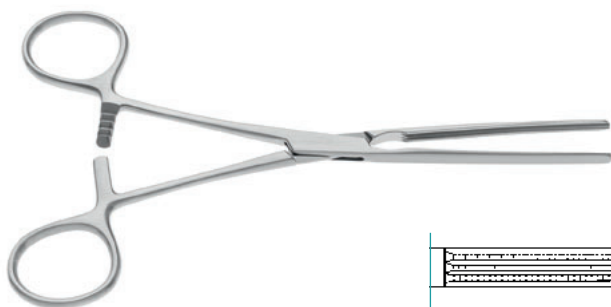

DOYEN ATRAUMATIC

Intestinal Clamp, atraumatic elastic serrations,
straight

160mm, 6 ¹ / ₄ "	310-550-160
180mm, 7"	310-550-180
210mm, 8 ¹ / ₄ "	310-550-210
230mm, 9"	310-550-230

curved	
160mm, 6 ¹ / ₄ "	310-551-160
180mm, 7"	310-551-180
210mm, 8 ¹ / ₄ "	310-551-210
230mm, 9"	310-551-230

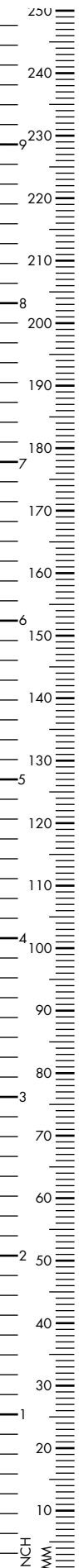

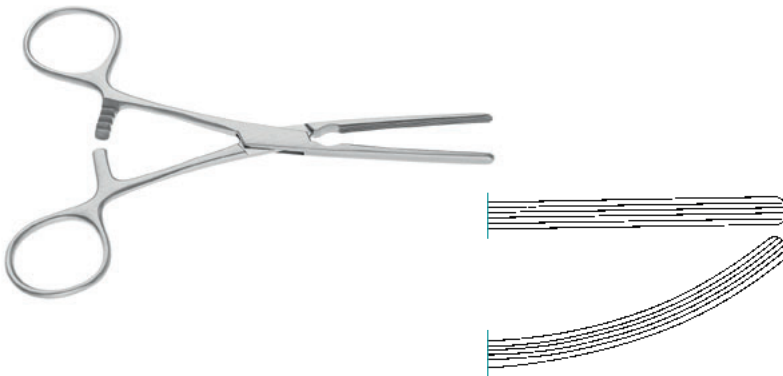

BABY KOCHER

Intestinal Clamp, longitudinal serrations
130mm, 5^{1/8}"

straight	310-124-130
curved	310-125-130

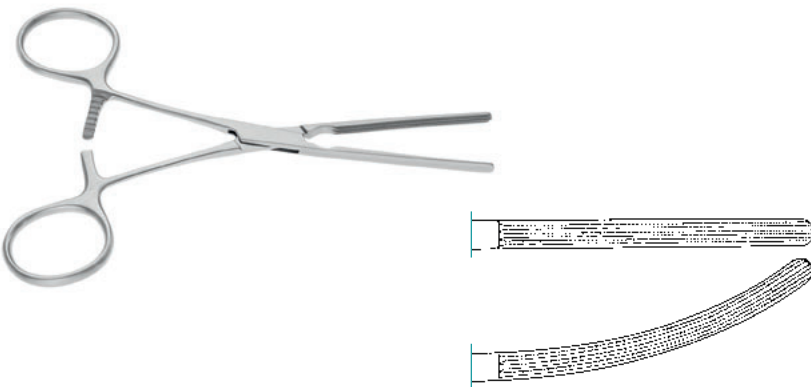

BABY KOCHER

Intestinal Clamp, atraumatic elastic serrations,
130mm, 5^{1/8}"

straight	310-200-130
curved	310-201-130

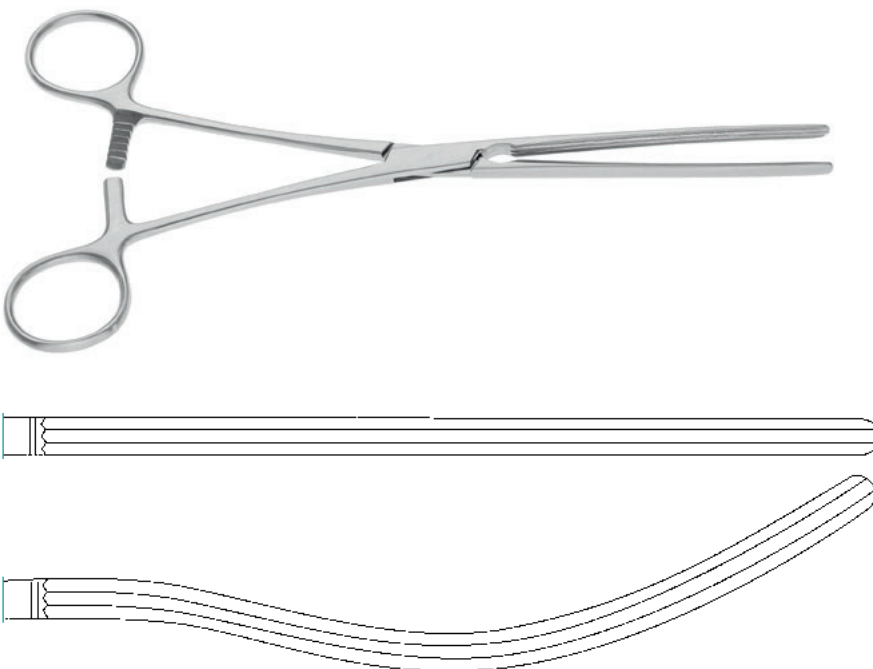

KOCHER

Intestinal Clamp, longitudinal serrations, elastic,
straight

220mm, 8 ^{2/3} "	310-124-220
250mm, 9 ^{7/8} "	310-124-250
280mm, 11"	310-124-280
curved	
220mm, 8 ^{2/3} "	310-125-220
250mm, 9 ^{7/8} "	310-125-250
280mm, 11"	310-125-280

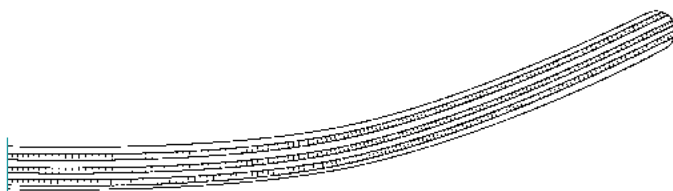
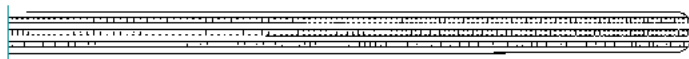
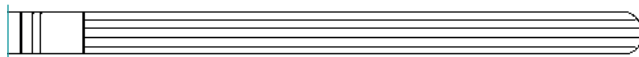
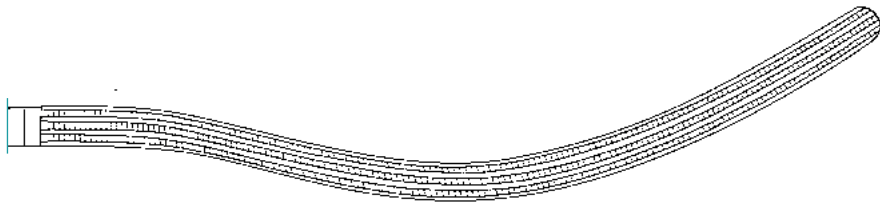
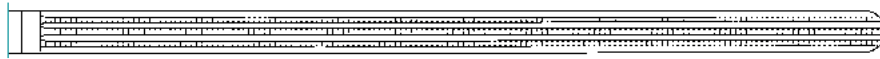

KOCHER ATRAUMATIC

Intestinal Clamp, atraumatic, elastic serrations, straight

220mm, 8 ² / ₃ "	310-126-220
250mm, 9 ⁷ / ₈ "	310-126-250
280mm, 11"	310-126-280

curved

220mm, 8 ² / ₃ "	310-127-220
250mm, 9 ⁷ / ₈ "	310-127-250
280mm, 11"	310-127-280

MAYO ROBSON

Intestinal Clamp, longitudinal serrations straight

210mm, 8 ¹ / ₄ "	310-130-210
230mm, 9"	310-130-230
250mm, 9 ⁷ / ₈ "	310-130-250

curved

210mm, 8 ¹ / ₄ "	310-131-210
230mm, 9"	310-131-230
250mm, 9 ⁷ / ₈ "	310-131-250

MAYO ROBSON ATRAUMATIC

Intestinal Clamp, atraumatic, elastic serrations straight

210mm, 8 ¹ / ₄ "	310-140-210
230mm, 9"	310-140-230
250mm, 9 ⁷ / ₈ "	310-140-250

curved

210mm, 8 ¹ / ₄ "	310-141-210
230mm, 9"	310-141-230
250mm, 9 ⁷ / ₈ "	310-141-250

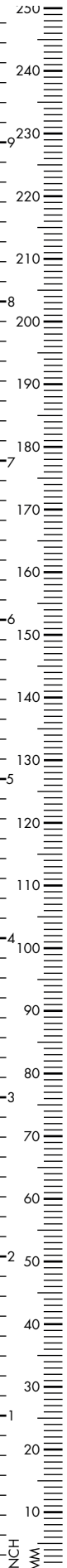

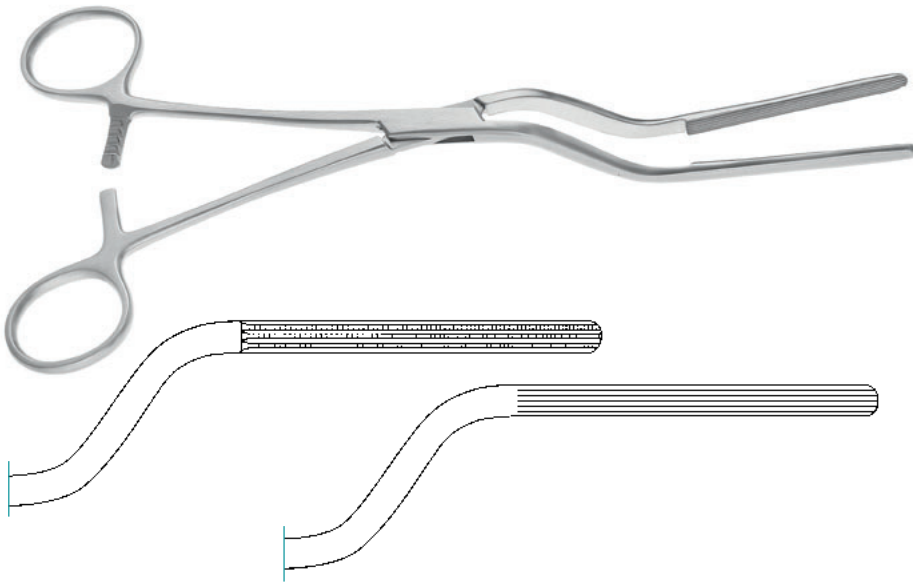

BRUNNER

Intestinal Clamp, bayonet shaped,
240mm, 9^{1/2}"

atraumatic serrations	310-151-240
longitudinal serrations	310-150-240

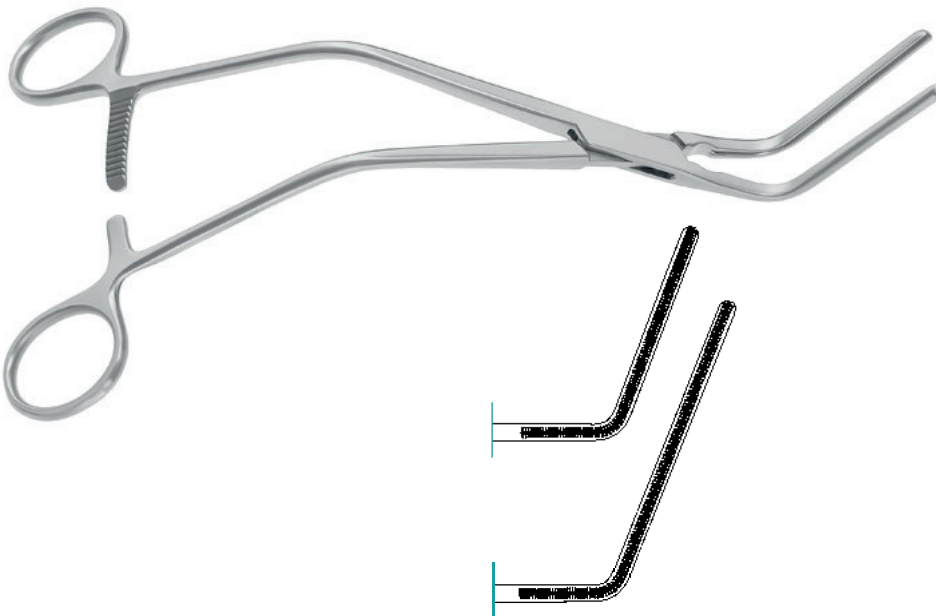

HAYES ATRAUMATIC

Intestinal Clamp, 60mm jaw

270mm, 10 ^{2/3} "	310-310-260
85mm jaw	
280mm, 11"	310-310-280

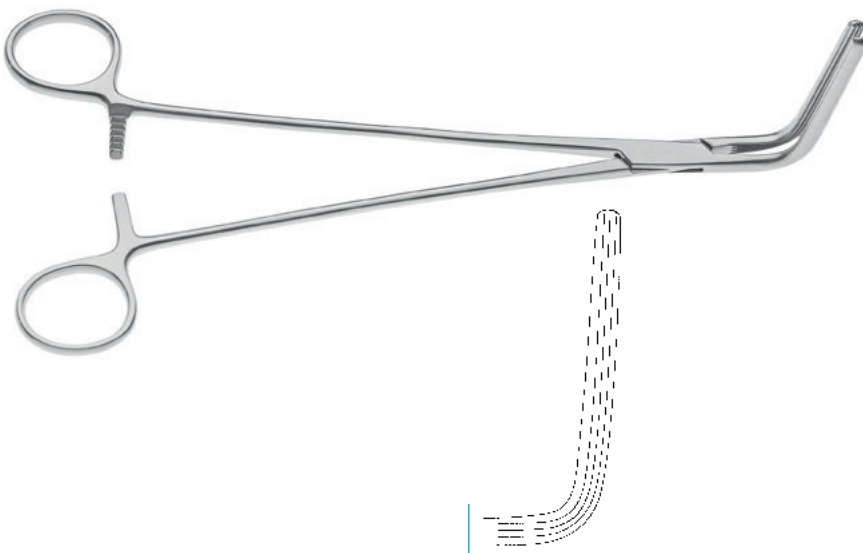

ZUBROD

Intestinal Clamp, longitudinal serrations,
60mm jaw, 90° angled

230mm, 9"	310-710-230
-----------	-------------

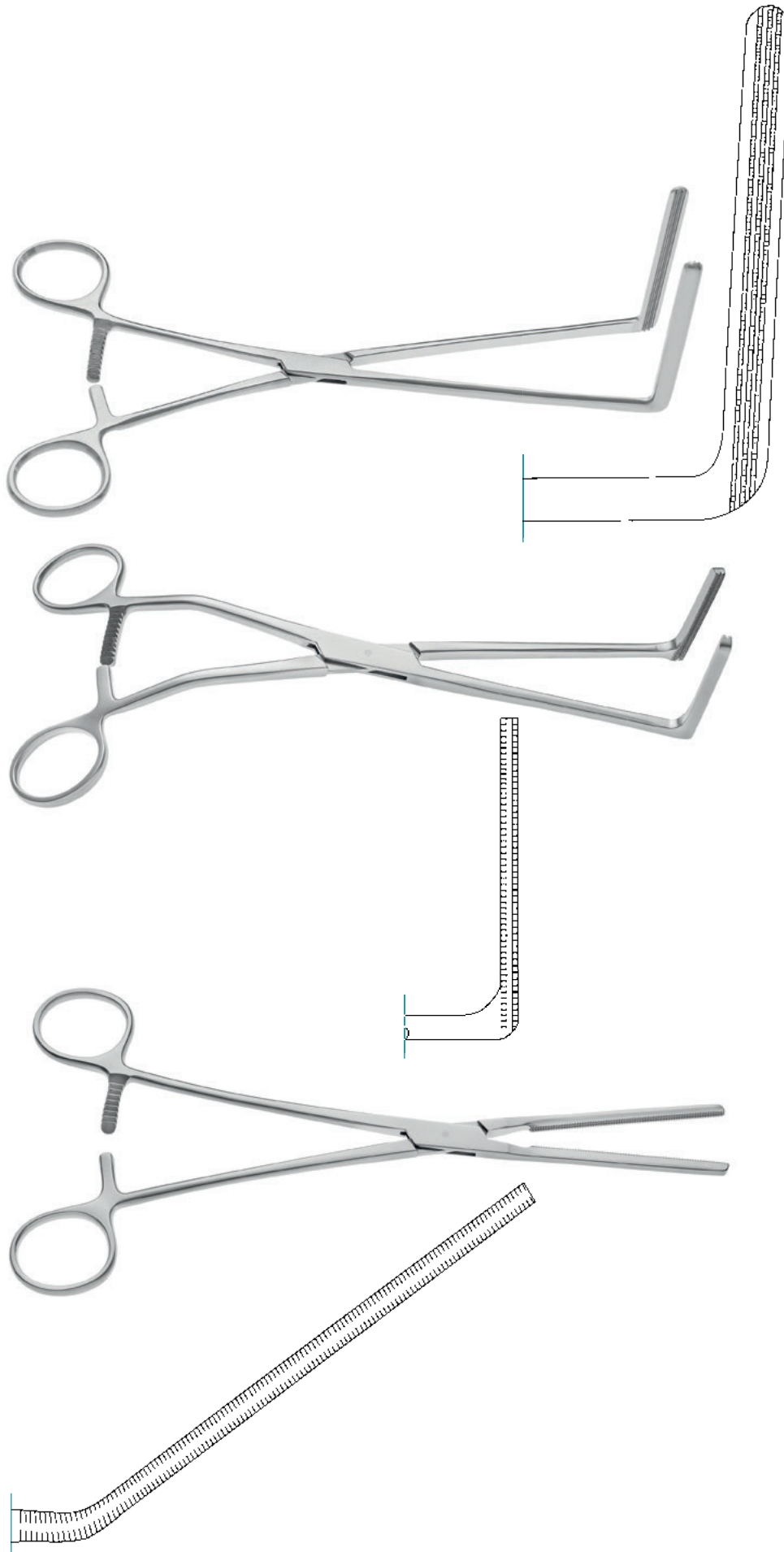

FEHLAND

Intestinal Clamp, atraumatic serrations

250mm, 9⁷/₈"

310-584-240

GLASSMAN

Intestinal Clamp, atraumatic serrations,
235mm, 9¹/₄"

25mm jaw

310-199-235

50mm jaw

310-201-235

75mm jaw

310-203-235

GLASSMAN

Intestinal Clamp, atraumatic serrations,
65mm jaw length, straight

235mm, 9¹/₄"

310-200-235

115mm jaw length, straight

280mm, 11"

310-200-290

65mm jaw length, 25° angled

229mm, 9"

310-200-229

115mm jaw length, 45° angled

280mm, 11"

310-201-290

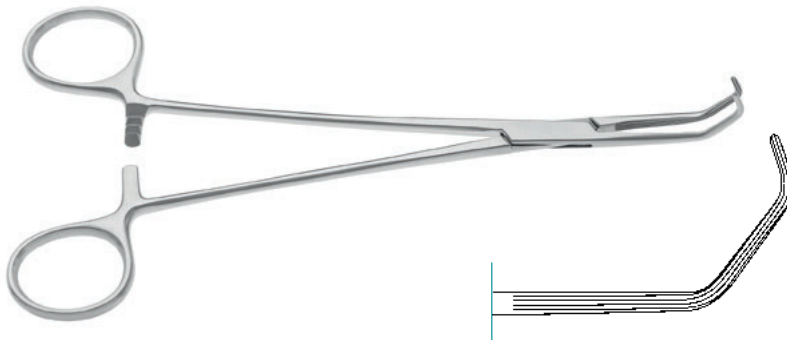

HAUSMANN

Intestinal Clamp, straight shanks,
1.9mm jaw width, 190mm, 7¹/₂"

22 x 8mm	310-233-190
----------	-------------

195mm, 7 ³ / ₄ "	
--	--

30 x 8mm	310-233-195
----------	-------------

205mm, 8 ¹ / ₈ "	
--	--

33 x 8mm	310-233-205
----------	-------------

38 x 8mm	310-243-205
----------	-------------

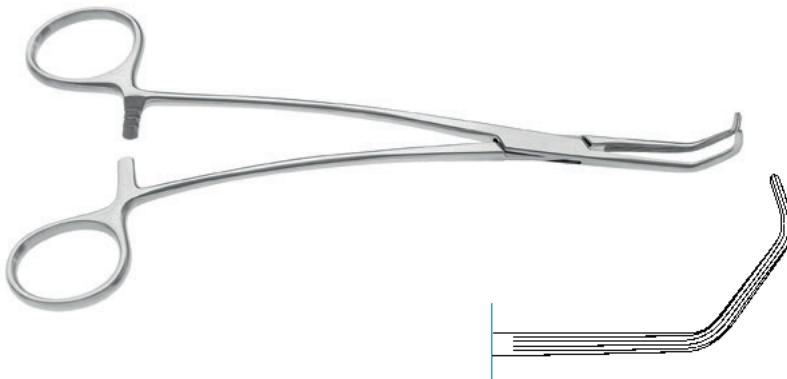

HAUSMANN

Intestinal Clamp, angled shanks,
1.9mm jaw width, 190mm, 7¹/₂"

22 x 8mm	310-231-190
----------	-------------

195mm, 7 ³ / ₄ "	
--	--

30 x 8mm	310-231-195
----------	-------------

205mm, 8 ¹ / ₈ "	
--	--

33 x 8mm	310-231-205
----------	-------------

38 x 8mm	310-241-205
----------	-------------

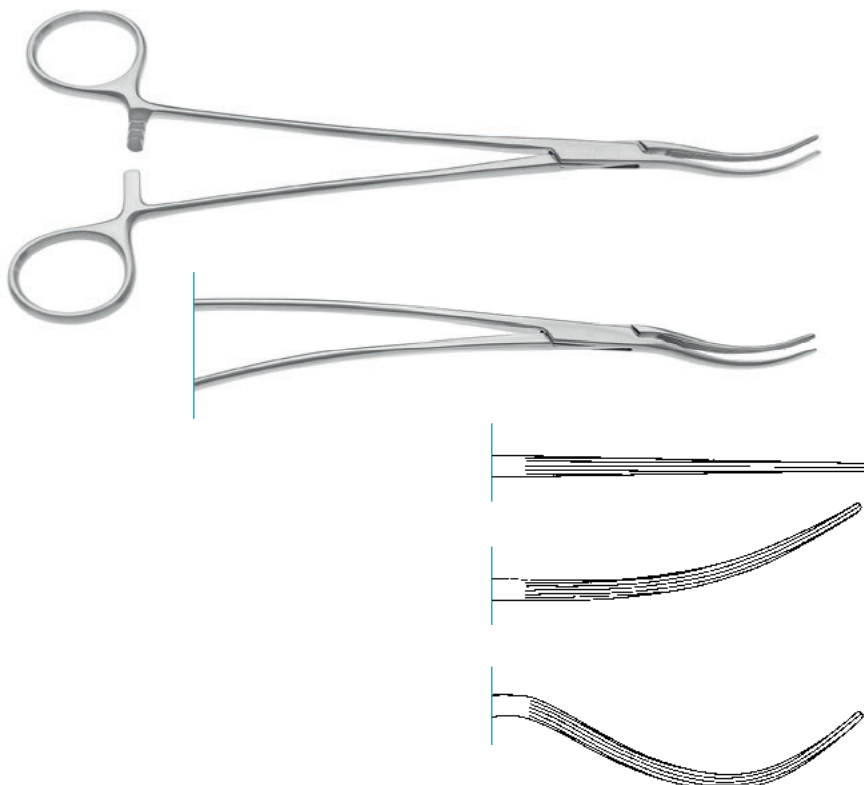

HAUSMANN

Intestinal Clamp, straight shanks, 1.9mm jaw
width, 215mm, 8¹/₂"

straight jaw	310-230-215
--------------	-------------

curved jaw	310-233-215
------------	-------------

strongly curved jaw	310-234-215
---------------------	-------------

angled shanks, 205mm, 8 ¹ / ₈ "	
---	--

straight jaw	310-250-205
--------------	-------------

angled shanks, 215mm, 8 ¹ / ₂ "	
---	--

curved jaw	310-253-215
------------	-------------

strongly curved jaw	310-254-215
---------------------	-------------

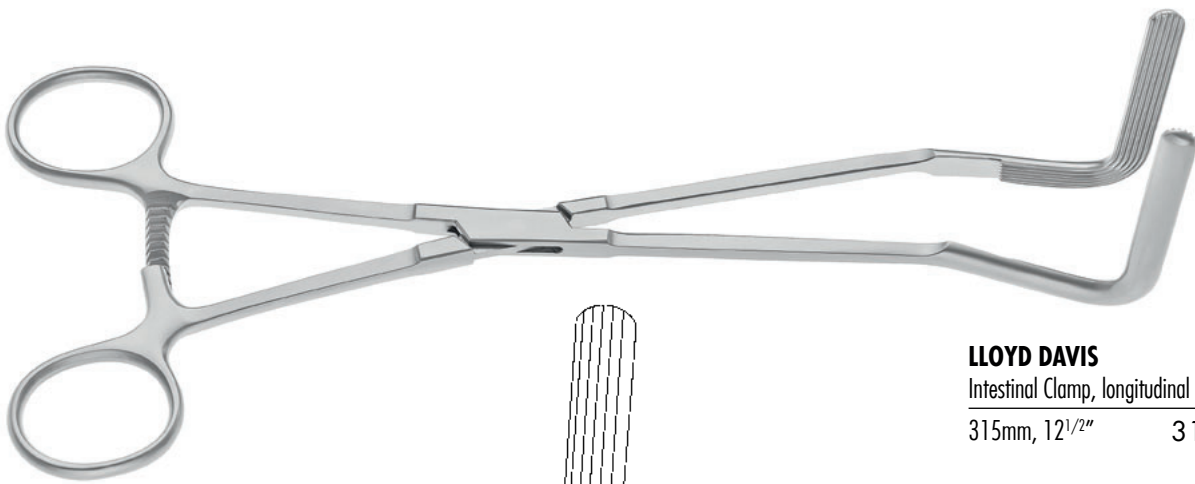

LLOYD DAVIS

Intestinal Clamp, longitudinal serrations

315mm, 12^{1/2}"

310-154-315

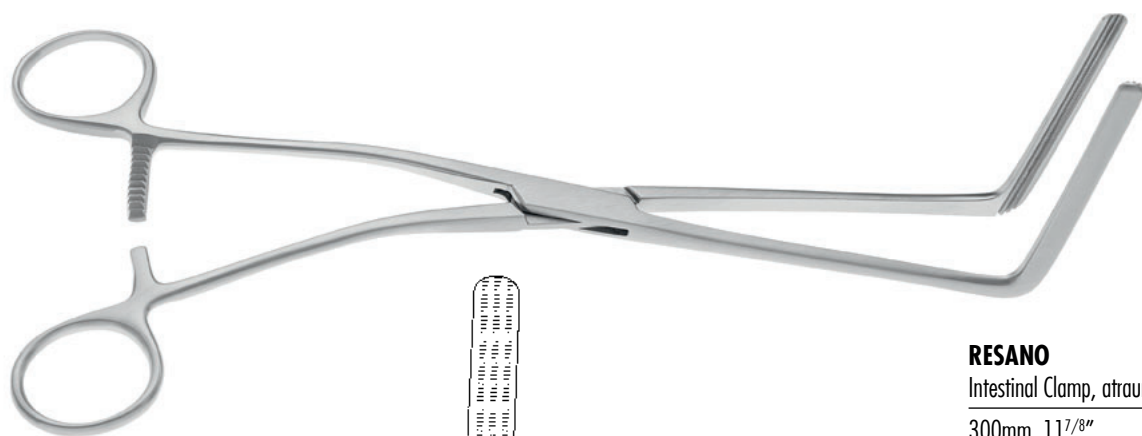
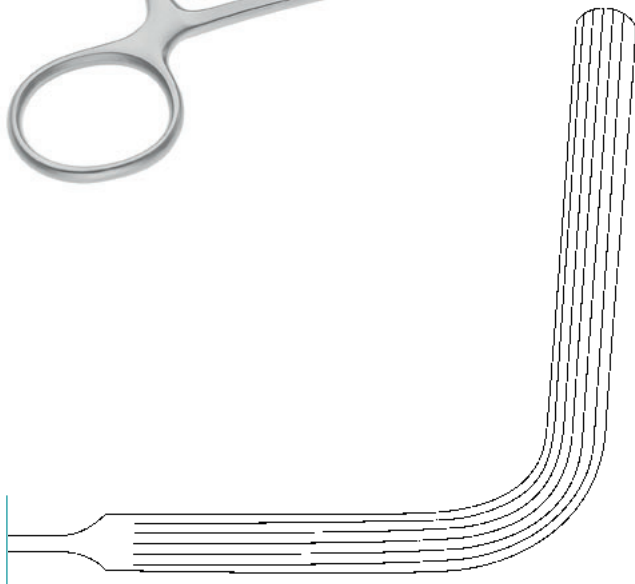

RESANO

Intestinal Clamp, atraumatic serrations

300mm, 11^{7/8}"

310-580-300

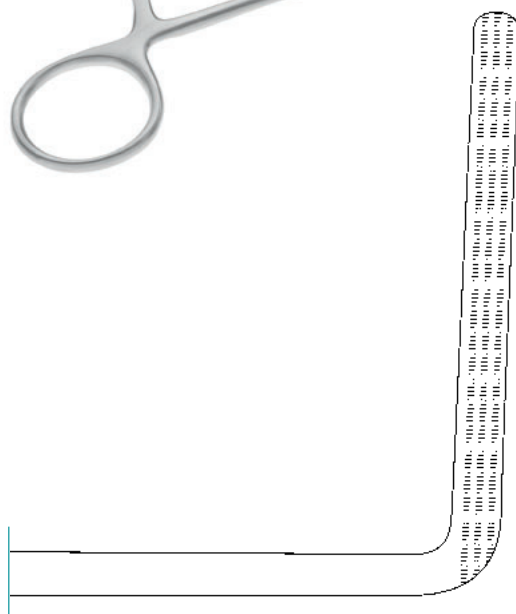

250
240
230
220
210
200
190
180
170
160
150
140
130
120
110
100
90
80
70
60
50
40
30
20
10
INCH
MM



DEMARTEL WOLFSON

Anastomosis Clamp

Set of 3 clamps

50mm	310-400-005
70mm	310-400-007
100mm	310-400-010



DEMARTEL WOLFSON

Clamp Holder

85mm	310-410-085
225mm	310-410-225



DEMARTEL WOLFSON

Closing Forceps

260mm	310-412-260
-------	-------------

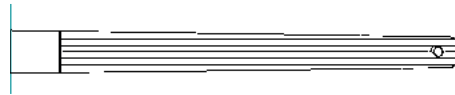

PAYR

Pylorus Clamp, light model for children,
with pin, 57mm jaw length

150mm, 6"

310-032-150

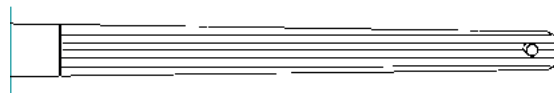

PAYR

Pylorus Clamp, with pin

210mm, 8^{1/4}"

310-033-210

65mm jaw length

290mm, 11^{1/2}"

310-033-290

105mm jaw length

315mm, 12^{1/2}"

310-033-315

146mm jaw length

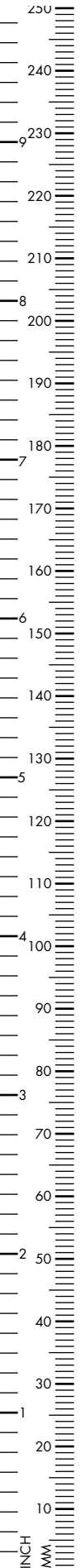

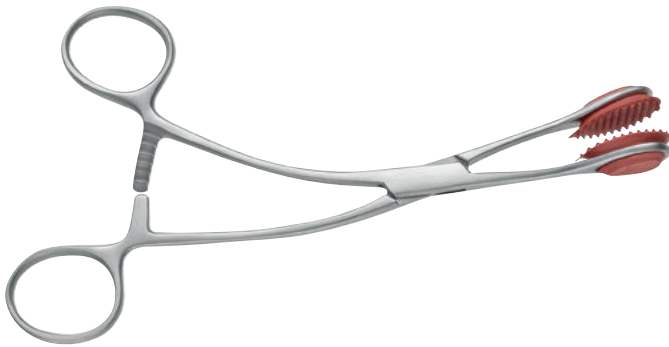

YOUNG

Tongue Holding Forceps

170mm, 6²/₃"

430-467-170

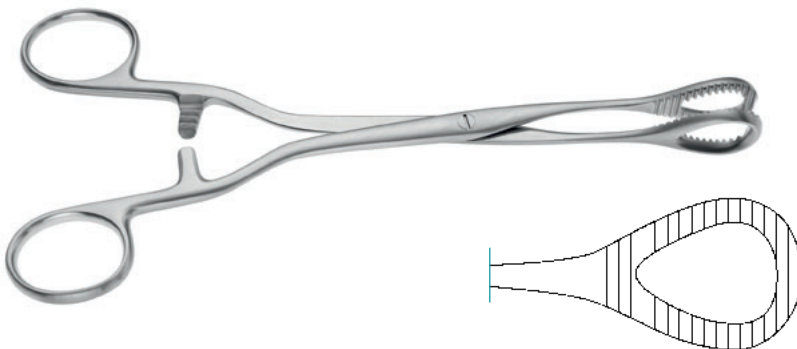

HEYWOOD SMITH

Hemorrhoidal Forceps
fenestrated serrated jaws

200mm, 8"

340-150-200

210mm, 8¹/₄"

340-160-210

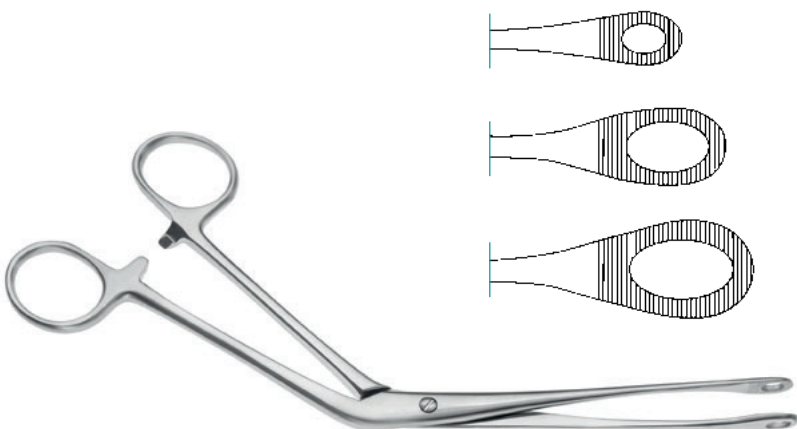

TOENNIS

Tumor Grasping Forceps

Fig. 1 250-066-341

Fig. 2 250-066-342

Fig. 3 250-066-343

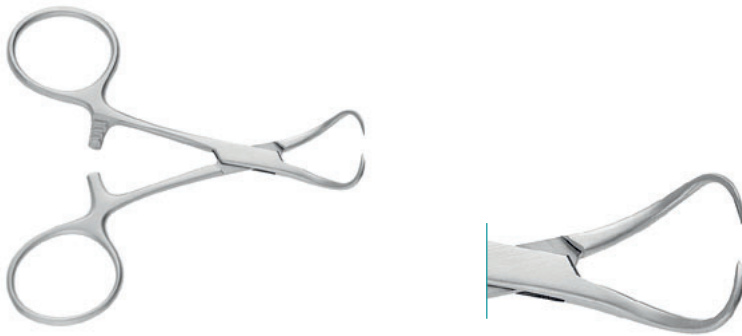
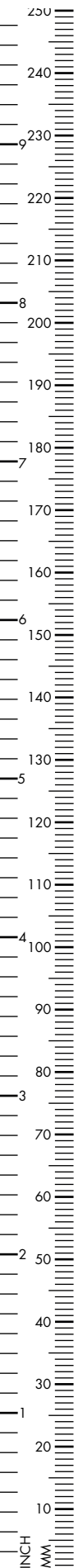

BACKHAUS

Towel Forceps

90mm, 3 ¹ / ₂ "	140-573-090
110mm, 4 ¹ / ₃ "	140-573-110
130mm, 5 ¹ / ₈ "	140-573-130
150mm, 6"	140-573-150

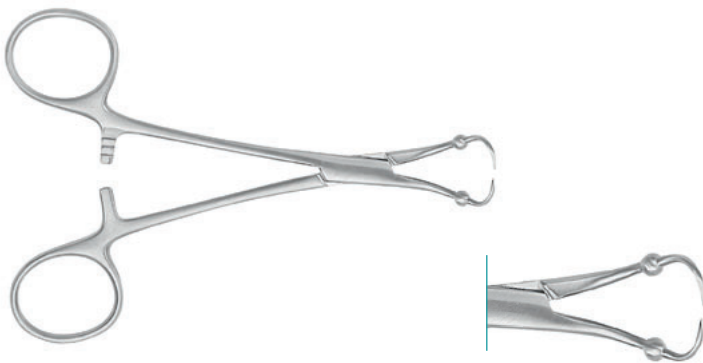

ROEDER

Towel Forceps

130mm, 5 ¹ / ₈ "	140-579-130
--	-------------

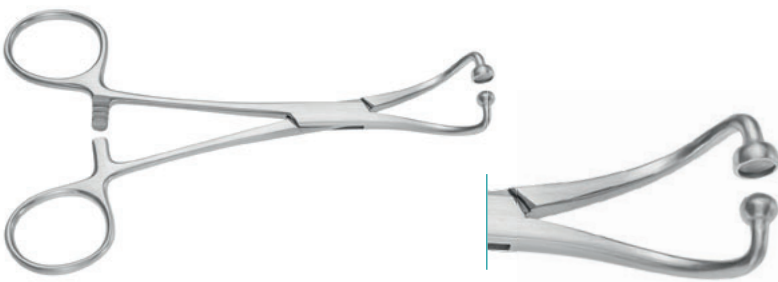

Ball & Socket Towel Forceps

110mm, 4 ¹ / ₃ "	140-580-115
130mm, 5 ¹ / ₈ "	140-580-130

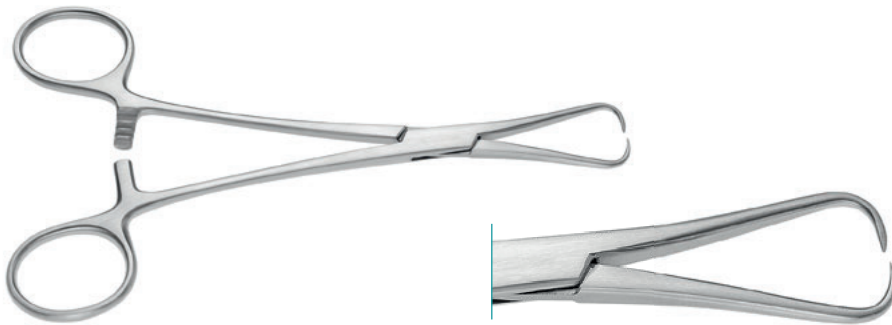

BERNHARD

Towel Forceps

165mm, 6¹/₂"

140-579-165

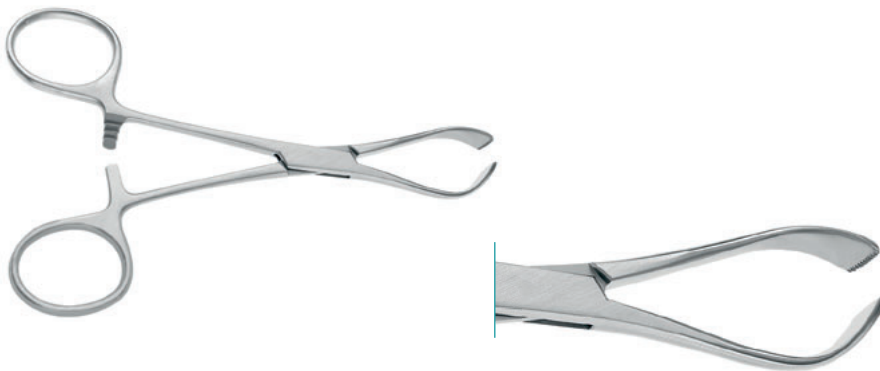

LORNA

Towel Forceps

100mm, 4"

140-578-100

130mm, 5¹/₈"

140-578-130

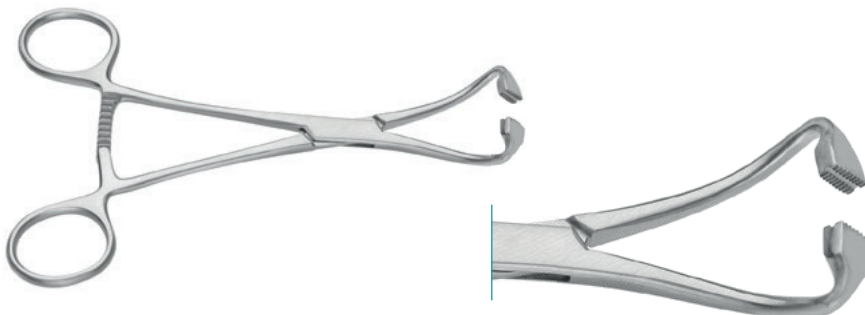

PEERS

Towel Forceps, non-perforating

145mm, 5³/₄"

140-595-145



Non-Perforating Towel Forceps

100mm, 4"	140-597-100
135mm, 5 ¹ / ₃ "	140-597-135



JONES

Towel Clip

60mm, 2 ¹ / ₃ "	140-561-050
90mm, 3 ¹ / ₂ "	140-561-090



TOHOKU

Towel Clamp

100mm, 4"	140-590-100
130mm, 5 ¹ / ₈ "	140-590-130

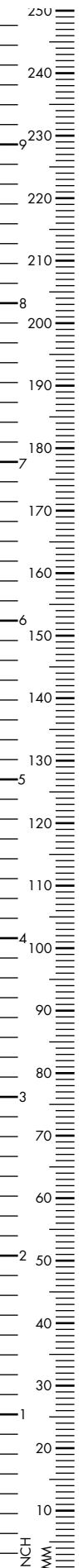

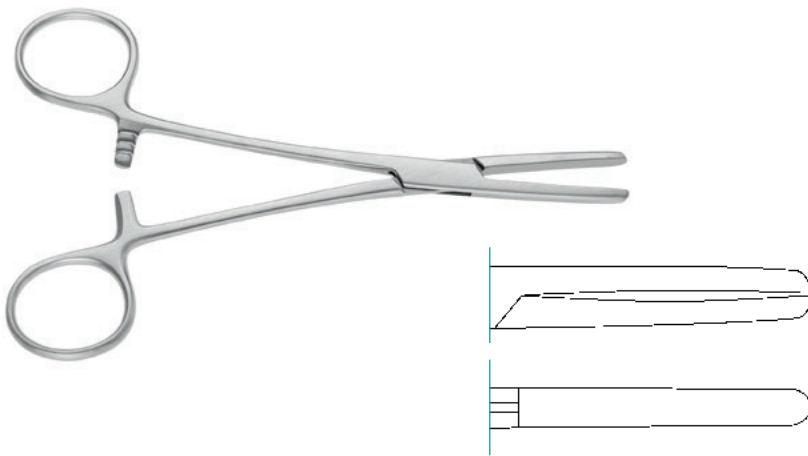

PRESBYTERIAN HOSPITAL

Tubing Clamp

165mm, 6 ^{1/2} "	140-601-165
---------------------------	-------------

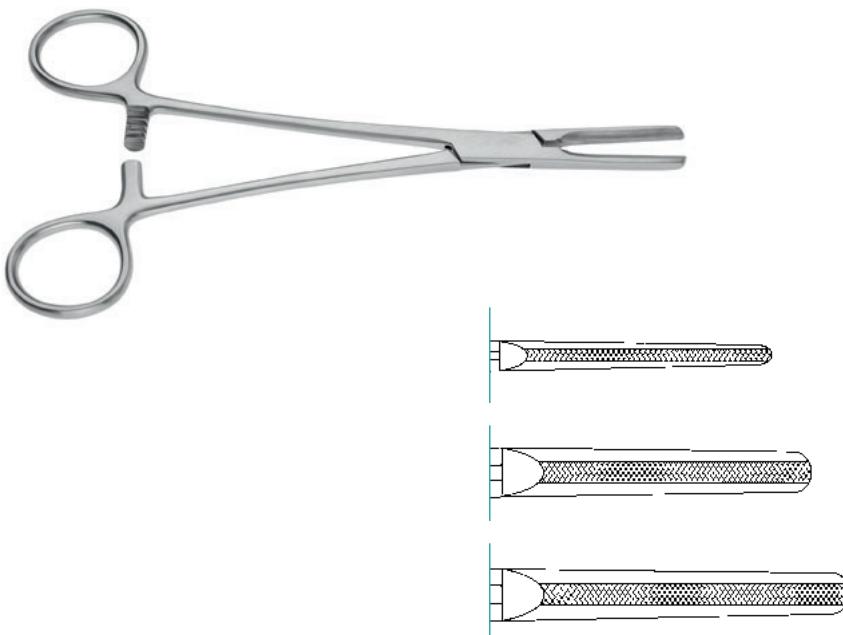

VORSE

Tubing Clamp, serrated jaws

150mm, 6"	140-603-150
180mm, 7"	140-603-180
200mm, 8"	140-603-200



VORSE

Tubing Clamp, serrated jaws, with safety guard

150mm, 6"	140-605-150
180mm, 7"	140-605-180
200mm, 8"	140-605-200

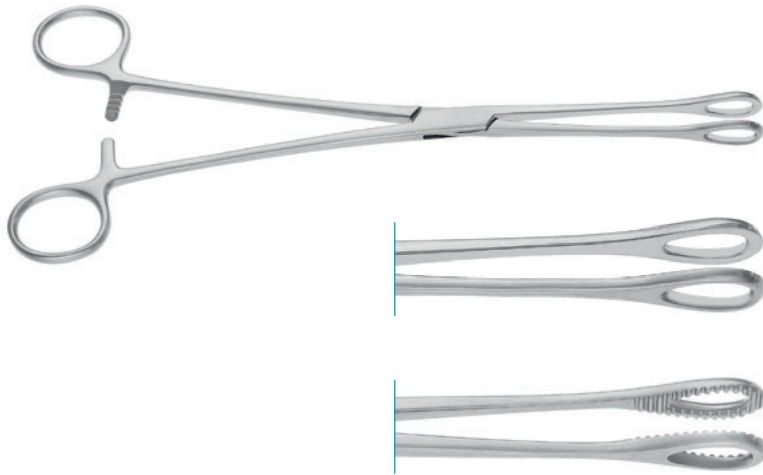
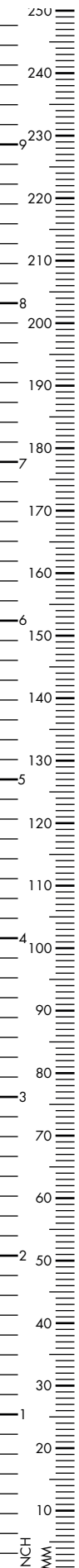

FOERSTER

Sponge Forceps, smooth, straight

180mm, 7"	150-050-180
200mm, 8"	150-050-200
250mm, 9 ⁷ / ₈ "	150-050-250

smooth, curved

180mm, 7"	150-053-180
200mm, 8"	150-053-200
250mm, 9 ⁷ / ₈ "	150-053-250

serrated, straight

180mm, 7"	150-052-180
200mm, 8"	150-052-200
250mm, 9 ⁷ / ₈ "	150-052-250
355mm, 14"	150-052-355
410mm, 16"	150-052-410

serrated, curved

180mm, 7"	150-055-180
200mm, 8"	150-055-200
250mm, 9 ⁷ / ₈ "	150-055-250

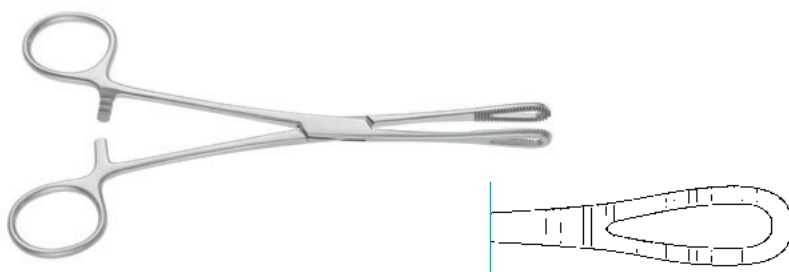

RAMPLEY

Sponge Forceps, straight, serrated

180mm, 7"	150-070-180
200mm, 8"	150-070-200
250mm, 9 ⁷ / ₈ "	150-070-250

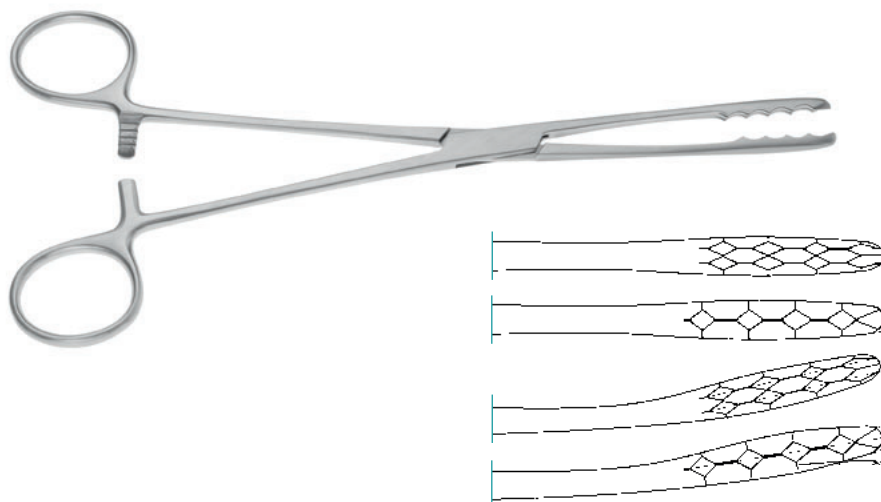

ULRICH

Swab Forceps, straight

220mm, 8 ² / ₃ "	150-010-220
250mm, 9 ⁷ / ₈ "	150-010-250
270mm, 10 ² / ₃ "	150-010-270

curved

220mm, 8 ² / ₃ "	150-011-220
250mm, 9 ⁷ / ₈ "	150-011-250
270mm, 10 ² / ₃ "	150-011-270

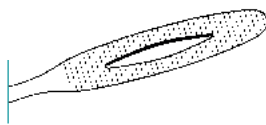
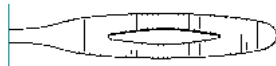

GROSS MAIER

Swab Forceps, serrated, straight

200mm, 8" 150-030-200

220mm, 8²/₃" 150-030-220

250mm, 9⁷/₈" 150-030-250

270mm, 10²/₃" 150-030-270

curved

200mm, 8" 150-031-200

220mm, 8²/₃" 150-031-220

250mm, 9⁷/₈" 150-031-250

270mm, 10²/₃" 150-031-270

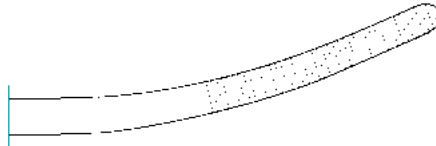
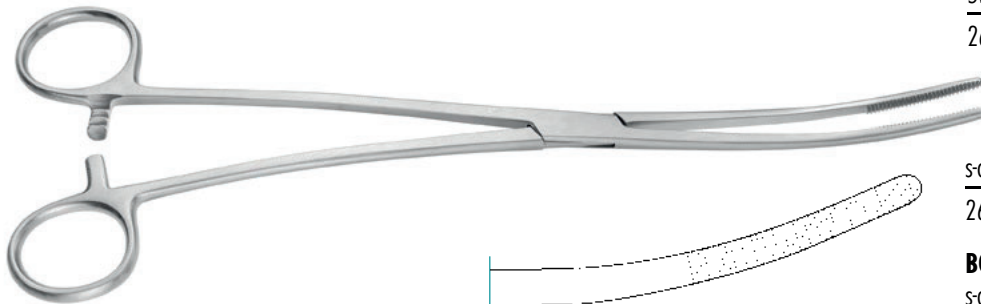

BOZEMANN

Swab Forceps, serrated, straight

260mm, 10¹/₄" 150-040-260

s-curved

260mm, 10¹/₄" 150-041-260

BOZEMANN DOUGLAS

s-curved, one large ring

260mm, 10¹/₄" 150-043-260

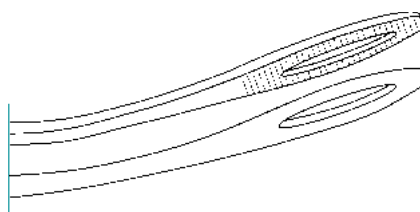
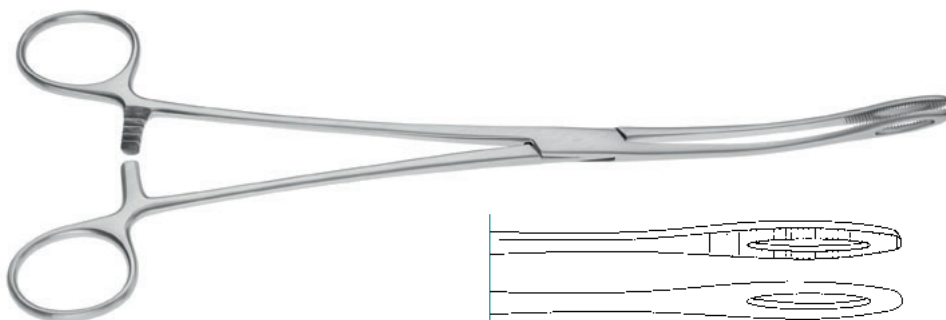

FOERSTER BONNEY

Swab Forceps, serrated, narrow, straight

250mm, 9⁷/₈" 150-060-250

curved

250mm, 9⁷/₈" 150-061-250

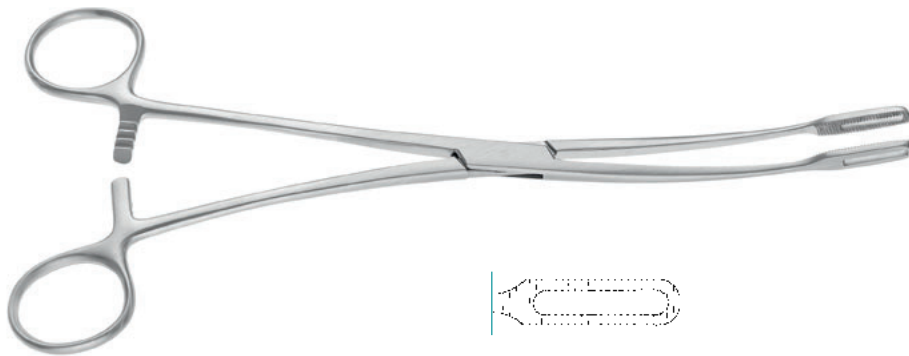

FLETCHER

Sponge Forceps, 240mm, 9¹/₂"

straight	150-046-240
s-curved	150-047-240



LISTER

Dressing Forceps

130mm, 5 ¹ / ₈ "	150-080-130
160mm, 6 ¹ / ₄ "	150-080-160
180mm, 7"	150-080-180



BRYANT

Dressing Forceps

130mm, 5 ¹ / ₈ "	150-035-130
--	-------------

