

# SINUSCOPY

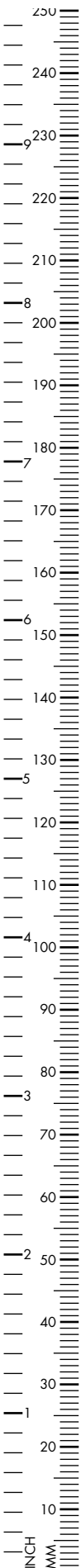

**LICHTWITZ-BIER**

Antrum Trocar Needle, 100mm, 4"

Ø 1.5mm	252-015-110
Ø 1.8mm	252-018-110
Ø 2.0mm	252-020-110

**EICKEN**Antrum Trocar Needle, 105mm, 4<sup>1</sup>/<sub>8</sub>"

Ø 1.5mm	252-115-110
Ø 1.8mm	252-118-110
Ø 2.0mm	252-120-110
Ø 2.5mm	252-125-110

**LICHTWITZ**

Antrum Trocar, 85mm working length

Ø 1.8mm	165-052-018
---------	-------------

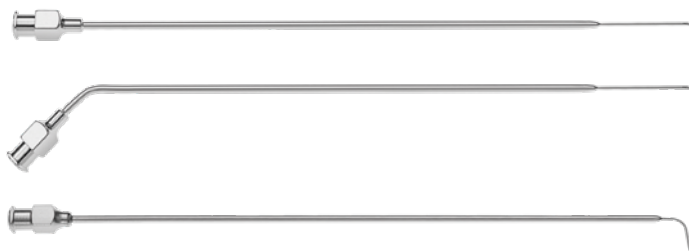
Septum Needle, with LuerLock attachment,  
Ø 0.8mm

straight	252-005-170
angled	252-003-170
angled tip	252-004-170

**BABY-EICKEN**Antrum Cannula, 90mm, 3<sup>1</sup>/<sub>2</sub>"

1.2mm	252-009-012
1.5mm	252-009-015
2.0mm	252-009-020

**EICKEN**Antrum Cannula, slightly curved, 130mm, 5<sup>1</sup>/<sub>8</sub>"

Ø 2.5mm	252-025-150
Ø 3.0mm	252-025-151
Ø 4.0mm	252-025-152

**EICKEN**Antrum Cannula with central opening, curved, 140mm, 5<sup>1</sup>/<sub>2</sub>"

Ø 2.5mm	252-125-150
Ø 3.0mm	252-125-151
Ø 4.0mm	252-125-152

**EICKEN**

Antrum Cannula, cut-off-hole, 150mm, 6" strongly curved

Ø 2.5mm	252-225-150
Ø 3.0mm	252-225-151
Ø 4.0mm	252-225-152

slightly curved

Ø 2.5mm	252-325-150
Ø 3.0mm	252-325-151
Ø 4.0mm	252-325-152

slightly curved, malleable

Ø 2.5mm	252-425-150
Ø 3.0mm	252-425-151
Ø 4.0mm	252-425-152

**EICKEN**

Sinus Suction Tube with cut-off hole,  
145mm, 5<sup>3</sup>/<sub>4</sub>"

Ø 2.5mm	252-725-150
Ø 3.0mm	252-725-151
Ø 4.0mm	252-725-152

**PASQUINI**

Sinus Suction Tube with olive tip

Ø 2.5mm	252-825-150
Ø 3.0mm	252-825-151
Ø 4.0mm	252-825-152



Suction Tube straight, mit olive Ø 2.5mm,  
without cut off hole, malleable

150mm, 6"	252-525-155
-----------	-------------

**FERGUSSON**

Suction Tube, 180mm, 7"

Ø 1.6mm, 5 Charr.	165-525-005
Ø 2.0mm, 6 Charr.	165-525-006
Ø 2.3mm, 7 Charr.	165-525-007
Ø 2.5mm, 8 Charr.	165-525-008
Ø 3.0mm, 9 Charr.	165-525-009
Ø 3.3mm, 10 Charr.	165-525-010
Ø 3.6mm, 11 Charr.	165-525-011
Ø 4.0mm, 12 Charr.	165-525-012
Ø 5.0mm, 15 Charr.	165-525-015

**FAZIER**

30° angled, with button tip, 100mm, 4"

6 Charr.	165-523-306
8 Charr.	165-523-308
10 Charr.	165-523-310
12 Charr.	165-523-312
15 Charr.	165-523-315

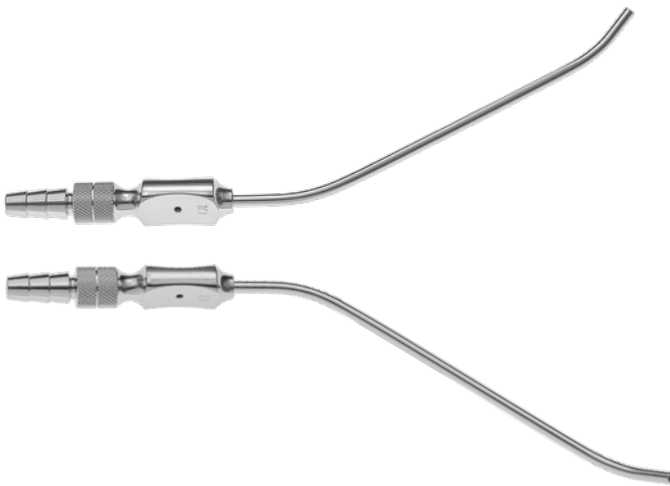
**FRAZIER**

10 Charr., 100mm, 4"

left curved	165-523-401
right curved	165-523-402

**KAHN-FRAZIER**10 Charr., s-shaped,  
150mm / 6" working length

Fig. 1 slightly curved	165-523-511
Fig. 2 strongly curved	165-523-512



**FISCH**

Suction/Irrigation Tube, 2.5 x 2.0mm

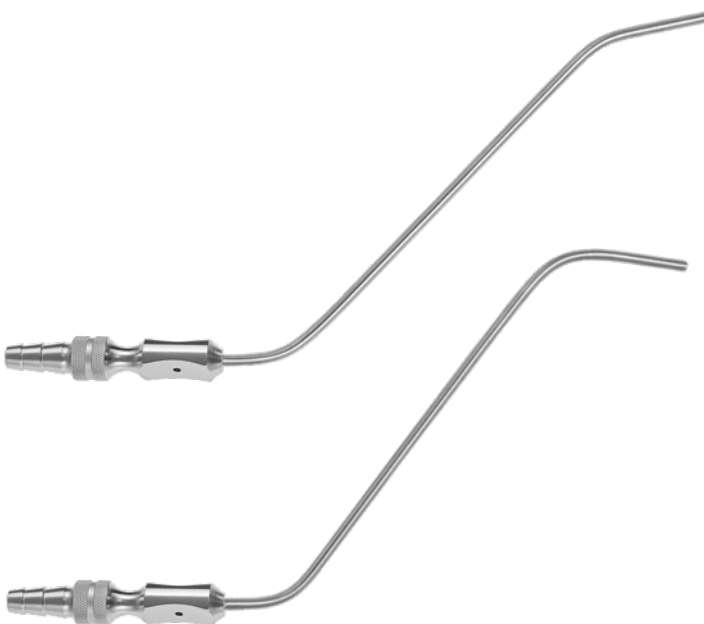
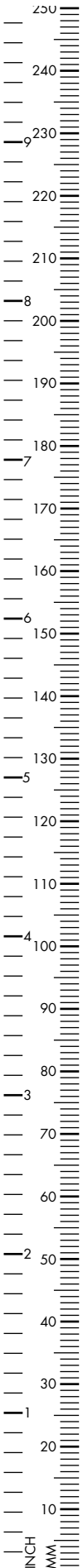
180mm, 7" 252-025-180



**SIEBENMANN**

Irrigation Antrum Cannula, blunt, Ø 2.5mm

130mm, 5 1/8"

inside opening 165-071-025

outside opening 165-072-025



**RITTER**

Frontal Sinus Bougie, 160mm, 6 1/4"

Ø 2.5 mm 252-043-025

Ø 3.0 mm 252-043-030

Ø 4.0 mm 252-043-040

Ø 5.0 mm 252-043-050



Antrum Trephine, american pattern

180mm, 7"

sharp 252-050-180

blunt 252-052-180

**MUELLER**

Antrum Rasp, diamond dusted tip,  
205mm, 8<sup>1</sup>/<sub>8</sub>"

fine

3mm	252-051-003
-----	-------------

4mm	252-051-004
-----	-------------

coarse

3mm	252-053-003
-----	-------------

4mm	252-053-004
-----	-------------

**PLESTER**

Sickle knife, slightly curved blade

160mm, 6 <sup>1</sup> / <sub>4</sub> "	410-101-160
--	-------------



Sickle knife, sharp, 200mm, 8"

sharp	252-205-190
-------	-------------

blunt	252-215-190
-------	-------------

**HALLE**Antrum Curette, malleable, 210mm, 8<sup>1/4</sup>"

Fig. 1 252-081-210

Fig. 2 252-082-210

Fig. 3 252-083-210

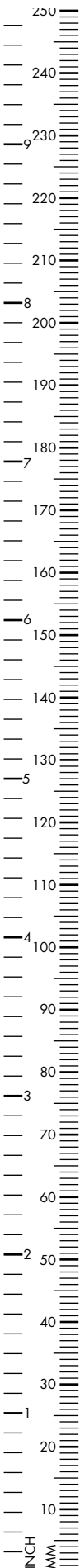

Antrum Spoon, oval, 200mm, 8"

Fig. 1, 7mm 252-071-190

Fig. 2, 8mm 252-082-190

Fig. 3, 9mm 252-093-190



Antrum Spoon, 200mm, 8"

round, 45° curved 252-171-190

oval, small, curved 252-182-190

oval, large, 30° angled 252-193-190

**PRATT**

Ethmoid Curette, double-ended

190mm, 7<sup>1/2</sup>" 252-008-190

**KUHN-BOLGER**Antrum Spoon, 190mm, 7<sup>1/2</sup>"

55° curved 252-172-190

90° curved 252-173-190

**UFFENDORDE**Bone Curette, 170mm, 6<sup>2/3</sup>"

45° angled right 210-345-007

45° angled left 210-347-007

**FAULKNER**

Antrum Curette

220mm, 8<sup>2/3</sup>" 252-071-220**FAULKNER**Antrum Curette, malleable, 220mm, 8<sup>2/3</sup>"

5 x 9mm ring 252-071-222

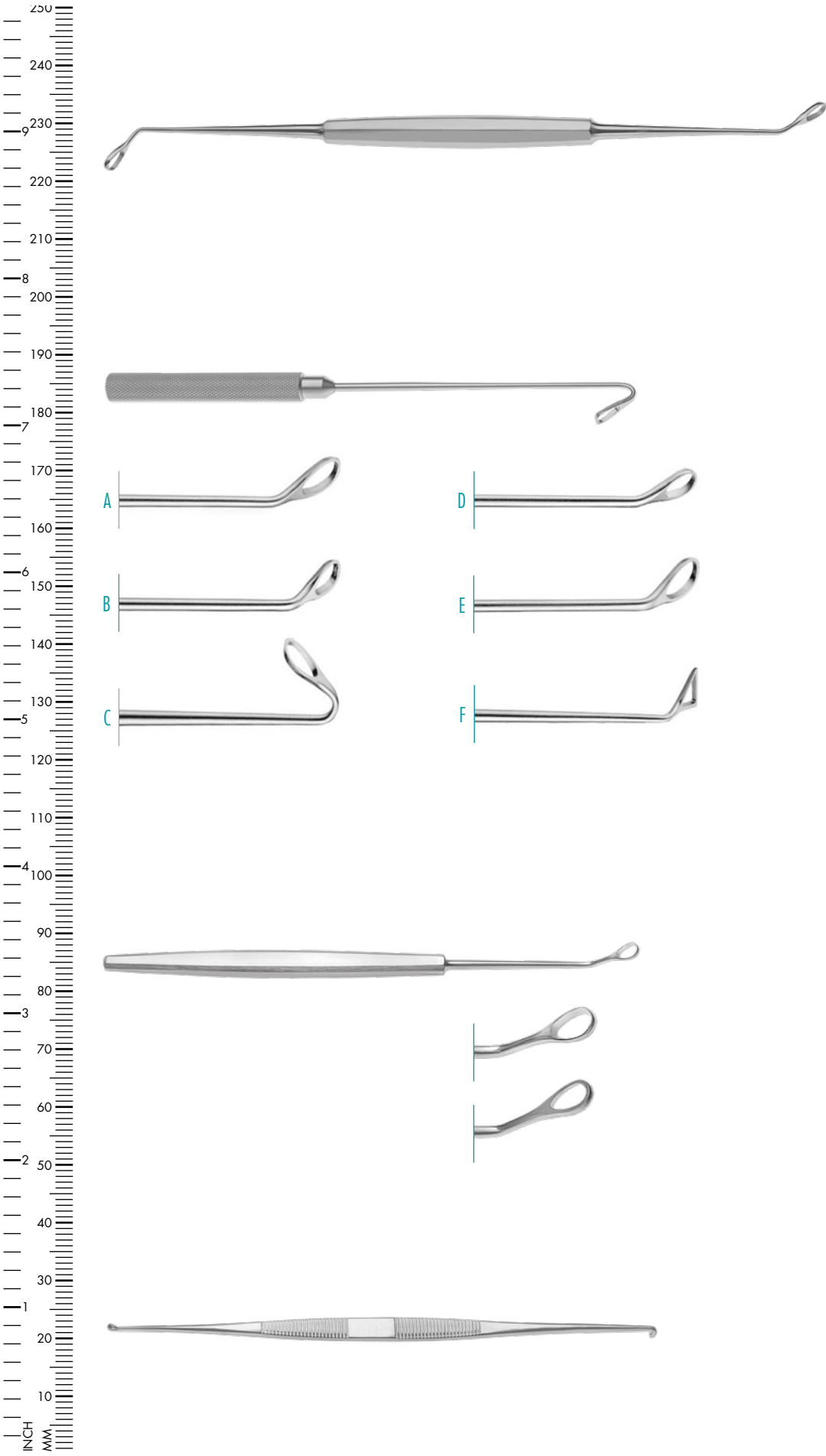

**HALLE**

Antrum Curette

245mm, 9<sup>2</sup>/<sub>3</sub>"

252-072-063

**COAKLEY**

Antrum Curette, rigid shank, 170mm, 6<sup>2</sup>/<sub>3</sub>"

- A Fig. 1 252-072-001
- B Fig. 2 252-072-002
- C Fig. 3 252-072-003
- D Fig. 4 252-072-004
- E Fig. 5 252-072-005
- F Fig. 6 252-072-006

**COAKLEY**

Antrum Curette, small size, 200mm, 8"

forward cutting 252-113-190

backward cutting 252-114-190

Curette, double-ended, oval, short curve 45°, semi-sharp, 2.2mm  
other side: 90° long curve, 2.7mm

190mm, 7<sup>1</sup>/<sub>2</sub>" 252-027-190

**RIBBON**

Retractor, malleable

200 x 6mm	170-973-006
200 x 12mm	170-973-012
200 x 17mm	170-973-017
200 x 20mm	170-973-020
250 x 25mm	170-973-025

**TUFFIER**

Retractor, malleable

200 x 25mm	170-975-250
------------	-------------



Orbital Protector

235mm, 9 1/4"	252-042-235
---------------	-------------



Antrum Punch, 3.5 x 3.7mm bite,  
110mm / 4<sup>1</sup>/<sub>3</sub>" working length

65° forward biting	252-150-110
30° upwards cutting	252-151-110



#### HAJEK-KOFLER

Sphenoid Punch, 3.5 x 3.7mm, 360° rotating

170mm, 6 <sup>2</sup> / <sub>3</sub> "	252-535-170
--	-------------



#### MCKENTY

Sphenoid Punch, rotating, through cutting,  
1.8 x 2.0mm

120mm, 4 <sup>3</sup> / <sub>4</sub> "	252-147-120
--	-------------

1.6 x 2.0mm

170mm, 6 <sup>2</sup> / <sub>3</sub> "	252-146-170
--	-------------

**MCKENTY**

Sphenoid Punch, rotating, upwards cutting,  
1.6 x 2.0mm

170mm, 6<sup>2</sup>/<sub>3</sub>" 252-151-170

**CITELLI**

Bone punch, 1.5 mm, through cutting

170mm, 6<sup>2</sup>/<sub>3</sub>" 252-147-170

**BEYER**

Bone punch, 2.0 mm, through cutting

170mm, 6<sup>2</sup>/<sub>3</sub>" 252-148-170

**HAJEK-KOFLER**

Bone Nibbler, 3.5 x 3.5mm,  
140mm, 5<sup>1</sup>/<sub>2</sub>"

upbiting 252-145-001

downbiting 252-145-002

upbiting, backward 252-145-003

downbiting, backward 252-145-004

upbiting, forward 252-145-005

upbiting, 4.5 x 4.5mm 252-146-001



**KERRISON**  
Punch, regular handle, superflat footplate



180mm, 7"  
40° upwards cutting

1mm	250-400-181SF
1.5mm	250-400-189SF
2mm	250-400-182SF
3mm	250-400-183SF
4mm	250-400-184SF
5mm	250-400-185SF



180mm, 7"  
40° downwards cutting

1mm	250-420-181SF
1.5mm	250-420-189SF
2mm	250-420-182SF
3mm	250-420-183SF
4mm	250-420-184SF
5mm	250-420-185SF

180mm, 7"  
90° upwards cutting

1mm	250-411-181SF
2mm	250-411-182SF
3mm	250-411-183SF
4mm	250-411-184SF
5mm	250-411-185SF

180mm, 7"  
90° downwards cutting

1mm	250-430-181SF
2mm	250-430-182SF
3mm	250-430-183SF
4mm	250-430-184SF
5mm	250-430-185SF

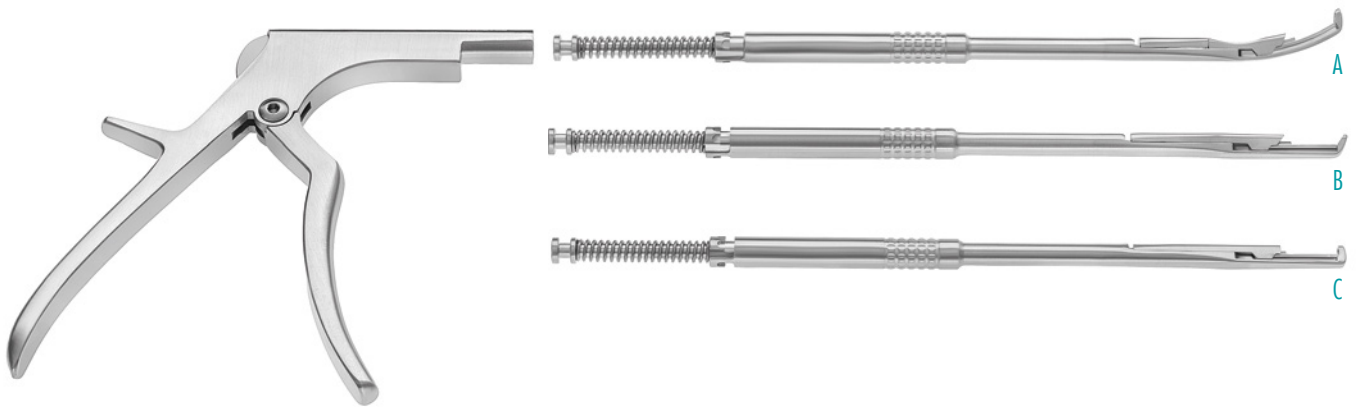

Handle only

250-245-000

**A** 360° Foraminotomy Punch  
exchangeable shaft, ejector, thin footplate  
40° angled

180mm, 7"		200mm, 8"	
2mm	250-280-182	2mm	250-280-202
3mm	250-280-183	3mm	250-280-203
4mm	250-280-184	4mm	250-280-204
5mm	250-280-185	5mm	250-280-205

**B** 360° Laminectomy Punch  
exchangeable shaft, ejector, thin footplate  
40° angled

180mm, 7"		200mm, 8"	
1mm	250-210-181	1mm	250-210-201
1.5mm	250-210-180	1.5mm	250-210-200
2mm	250-210-182	2mm	250-210-202
3mm	250-210-183	3mm	250-210-203
4mm	250-210-183	4mm	250-210-204
5mm	250-210-185	5mm	250-210-205

**C** 360° Laminectomy Punch  
exchangeable shaft, ejector, thin footplate  
90° angled

180mm, 7"		200mm, 8"	
1mm	250-245-181	1mm	250-245-201
1.5mm	250-245-180	1.5mm	250-245-200
2mm	250-245-182	2mm	250-245-202
3mm	250-245-183	3mm	250-245-203
4mm	250-245-184	4mm	250-245-204
5mm	250-245-185	5mm	250-245-205

All instruments are available with CERACUT® coating. Code number + CC (e.g. 250-400-181CC)



Frontal Sinus Punch Forceps, 40° upbiting forward, 2mm, 70° upturned shaft, 140mm, 5 1/2"

2mm bite	252-499-175
3mm bite	252-500-175



Frontal Ostium nasal forceps, 140mm, 5 1/2"

3x3mm, 5mm	252-499-140
2x2mm, 5mm	252-500-140
5x5mm, 5mm	252-501-140

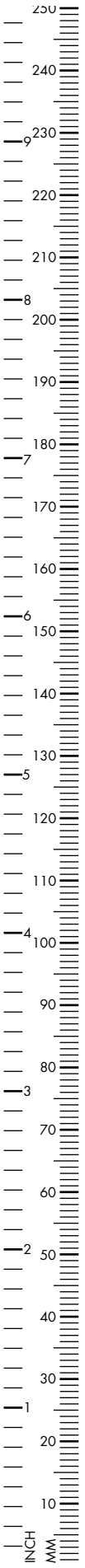



Sinuscope, autoclavable, Ø 4mm,  
180mm, 7"

● 0°	252-104-000
● 30°	252-104-030
● 45°	252-104-045
● 70°	252-104-070



Sinuscope, autoclavable, Ø 2.7mm,  
180mm, 7"

● 0°	252-127-000
● 30°	252-127-030
● 70°	252-127-070



Sinuscope, autoclavable, Ø 2.7mm,  
110mm, 4<sup>1</sup>/<sub>3</sub>"

● 0°	252-127-200
● 30°	252-127-230

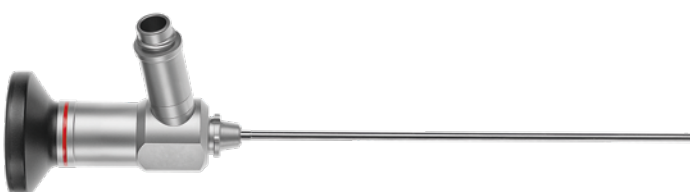

Sinuscope, Ø 3.0mm,  
140mm, 5<sup>1</sup>/<sub>2</sub>"

0°	252-130-000
30°	252-130-030
45°	252-130-045
70°	252-130-070

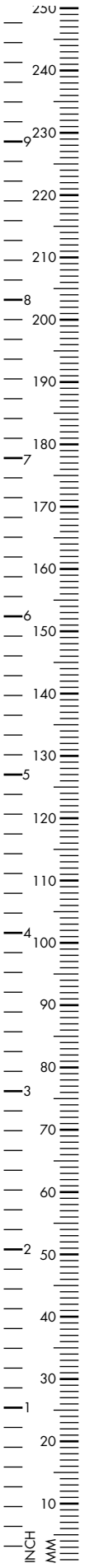

Flat Handle for Sinusscopes, 120mm, 4<sup>3/4</sup>"

for Ø 4.0mm	251-104-001
for Ø 2.7mm	251-127-001



Round Handle for Sinusscopes, 120mm, 4<sup>3/4</sup>"

for Ø 4.0mm	251-104-002
for Ø 2.7mm	251-127-002

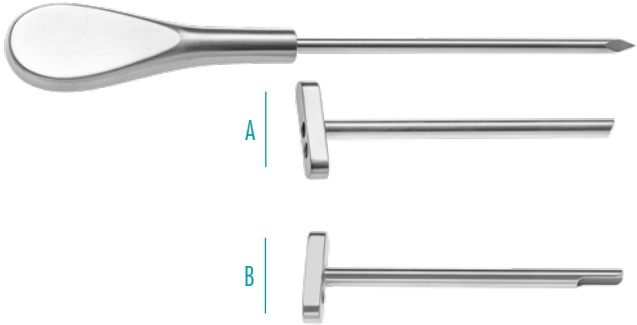

Sinuscopy Trocar and Sheath, Ø 5.2mm, 85mm working length, sharp for 4mm scopes

A oblique end	251-104-120
B duckbill tip	251-105-120

for 2.7mm scopes

A oblique end	251-127-120
---------------	-------------



Biopsy and Grasping Forceps,  
3 x 6mm oval cup

90mm, 3<sup>1</sup>/<sub>2</sub>" 252-503-090

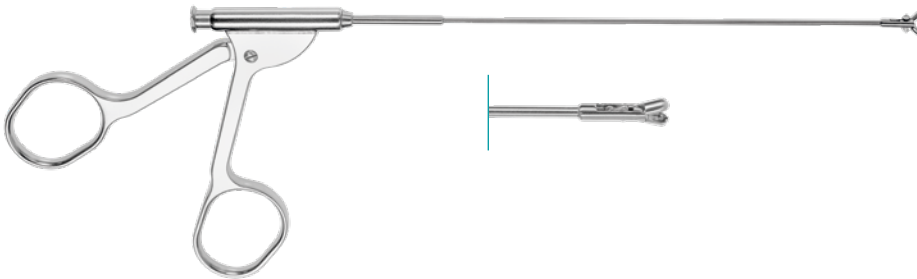

Biopsy and Grasping Forceps, delicate pattern,  
3 mm oval cup

140mm, 5<sup>1</sup>/<sub>2</sub>" 252-503-140



Biopsy and Grasping Forceps, malleable shaft,  
4mm biopsy cup, vertical opening

180mm, 7" 252-174-180

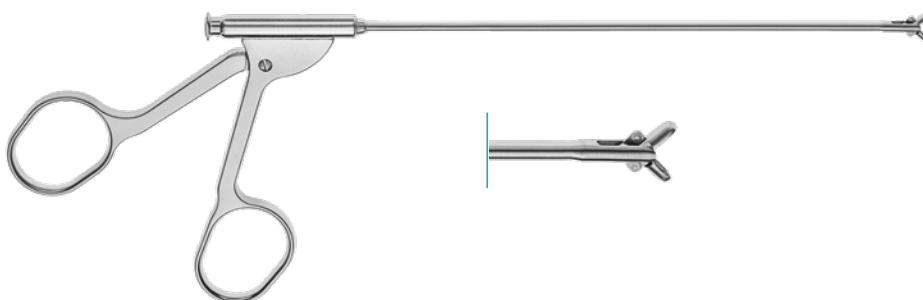

Biopsy and Grasping Forceps,  
3mm round cup, straight

150mm, 6" 252-503-150

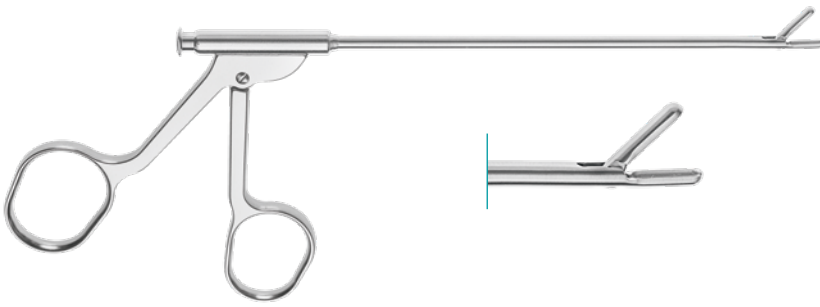
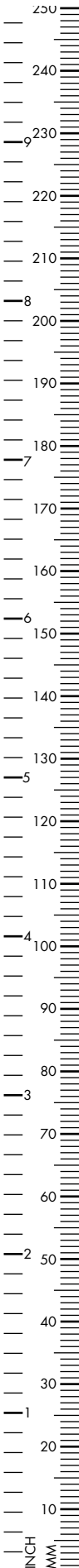

**TAKAHASHI**

Ethmoidal Forceps, 3 x 10mm

130mm, 5<sup>1</sup>/<sub>8</sub>" 252-002-130

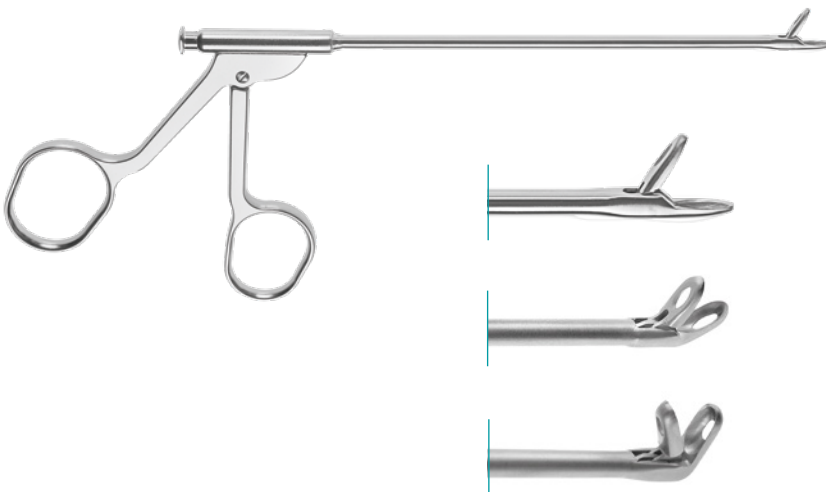

**BLAKESLEY**

Ethmoidal Forceps, straight, 130mm, 5<sup>1</sup>/<sub>8</sub>"

- Size 0, 2.5mm 252-034-130
- Size 1, 3.0mm 252-034-131
- Size 2, 3.5mm 252-034-132
- Size 3, 4.0mm 252-034-133
- Size 4, 5.0mm 252-034-134
- Size 5, 6.0mm 252-034-135

**BLAKESLEY-WILDE**

45° curved up

- Size 0, 2.5mm 252-035-130
- Size 1, 3.0mm 252-035-131
- Size 2, 3.5mm 252-035-132
- Size 3, 4.0mm 252-035-133
- Size 4, 5.0mm 252-035-134
- Size 5, 6.0mm 252-035-135

**BLAKESLEY-WILDE**

90° curved up

- Size 0, 2.5mm 252-037-130
- Size 1, 3.0mm 252-037-131
- Size 2, 3.5mm 252-037-132
- Size 3, 4.0mm 252-037-133
- Size 4, 5.0mm 252-037-134
- Size 5, 6.0mm 252-037-135

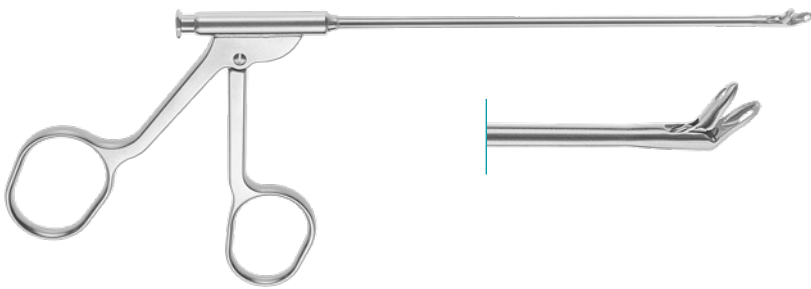
**STRUEMPEL-VOSS**

Ethmoidal Forceps, 90° curved to the right,  
45° upwards, 130mm, 5<sup>1</sup>/<sub>8</sub>"

Size 1	252-036-131
Size 2	252-036-132

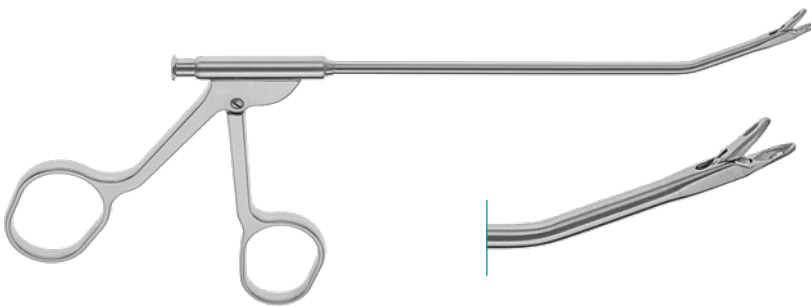
**BLAKESLEY**

Spoon Forceps, 2.7mm straight,  
130mm working length

25°	252-234-130
45°	252-234-131

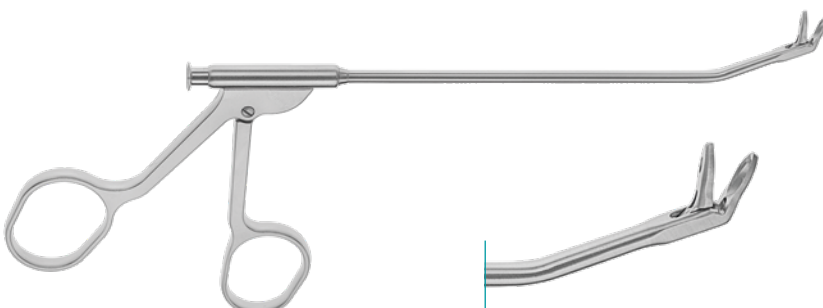
**BLAKESLEY**

Spoon Forceps, 45° curved up  
130mm working length

2.7mm	252-235-130
3.0mm	252-235-131
3.5mm	252-235-132

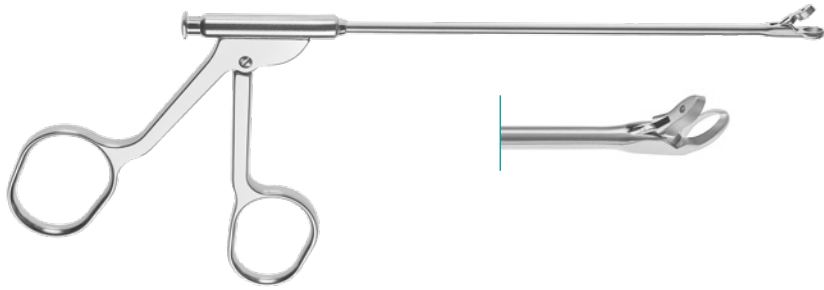
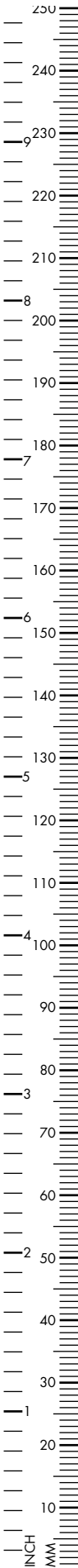

**BLAKESLEY**

Ethmoidal Forceps, straight, 130mm, 5<sup>1</sup>/<sub>8</sub>"

Fig. 0, 3.0mm 252-004-130

Fig. 1, 3.5mm 252-004-131

Fig. 2, 4.0mm 252-004-132

45° curved up

Fig. 0, 3.0mm 252-014-130

Fig. 1, 3.5mm 252-014-131

Fig. 2, 4.0mm 252-014-132

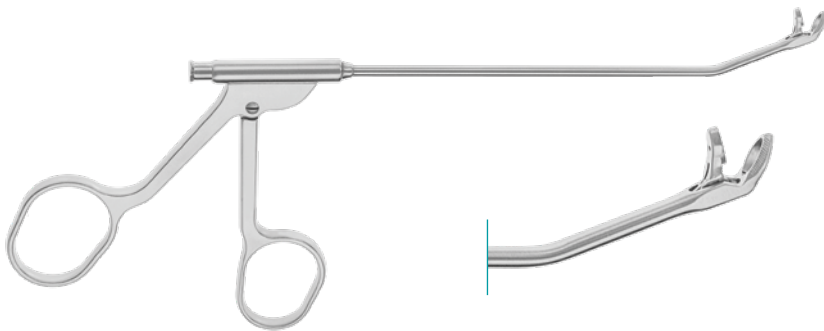

**BLAKESLEY**

Spoon Forceps, cutting, 2.7mm,  
45° angled up, sheath 25° bent up

130mm, 5<sup>1</sup>/<sub>8</sub>" 252-214-130

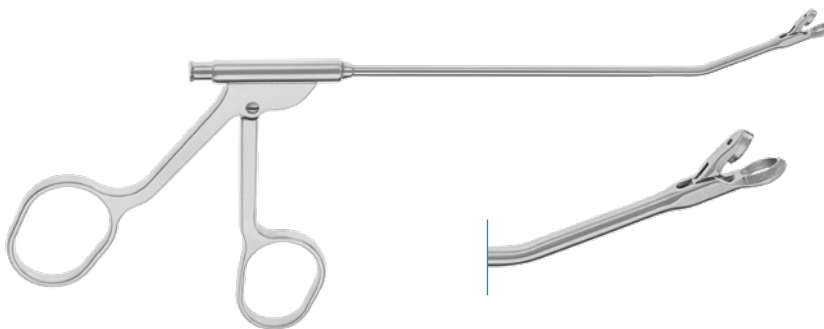

**BLAKESLEY**

Spoon Forceps, cutting, 2.7mm,  
straight sheath, sheath 25° bent up

252-204-130

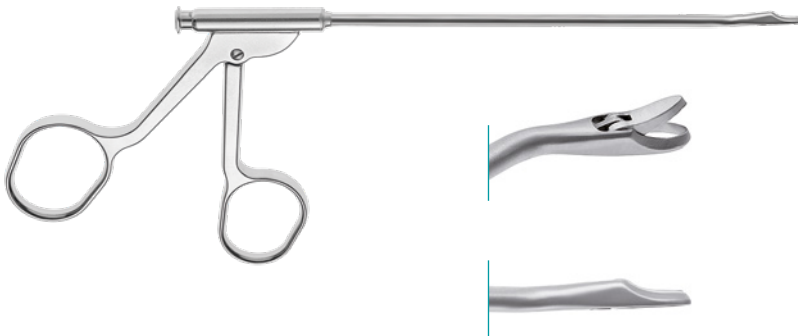
**BLAKESLEY**

Ethmoidal Forceps, through-cutting,  
115mm, 4<sup>1</sup>/<sub>2</sub>"

30° curved left	252-401-025
30° curved right	252-403-025

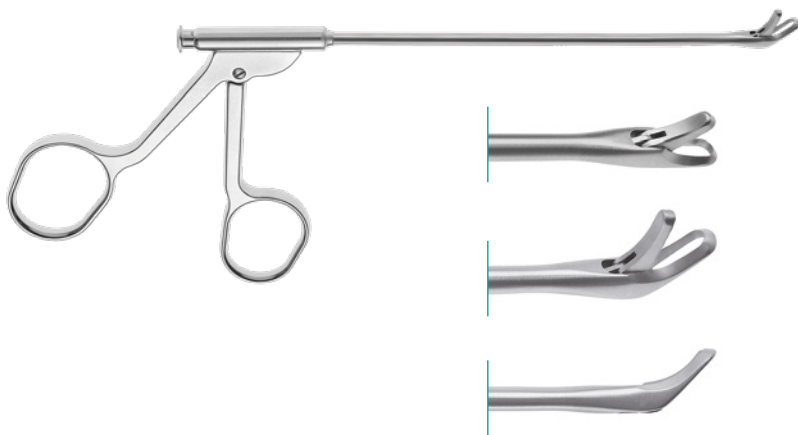
**DUCKBILL**

Duckbill Punch, straight,  
130mm, 5<sup>1</sup>/<sub>8</sub>" working length

Fig. 0, 2.0mm bite	252-206-000
Fig. 1, 2.5mm bite	252-206-001
Fig. 2, 3.0mm bite	252-206-002

upwards curved

Fig. 0, 2.0mm bite	252-207-000
Fig. 1, 2.5mm bite	252-207-001
Fig. 2, 3.0mm bite	252-207-002

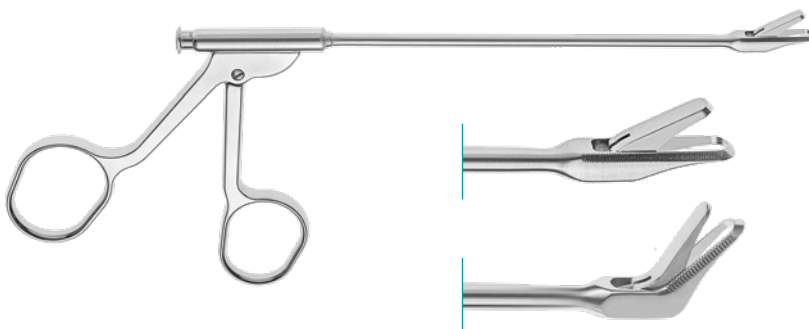
**GRUENWALD-HENKE**

Nasal Forceps, through-cutting,  
130mm, 5<sup>1</sup>/<sub>8</sub>" working length  
straight

8.0 x 3.0mm	252-013-130
11.5 x 3.5mm	252-014-135

upcurved

8.0 x 3.0mm	252-013-145
11.5 x 3.5mm	252-014-145

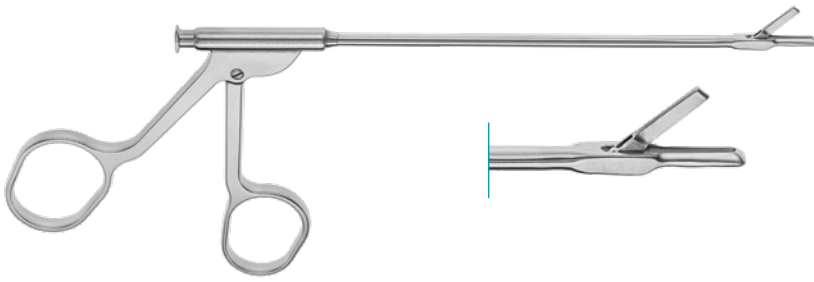
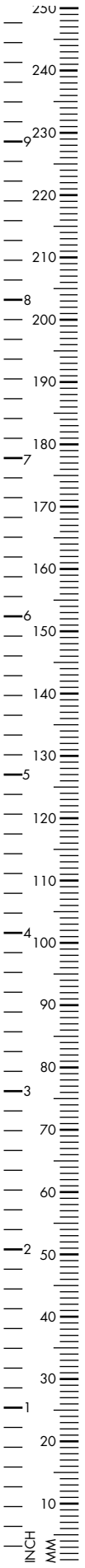

**STRUYCKEN**

Ethmoidal Forceps

130mm, 5<sup>1</sup>/<sub>8</sub>"

252-003-130

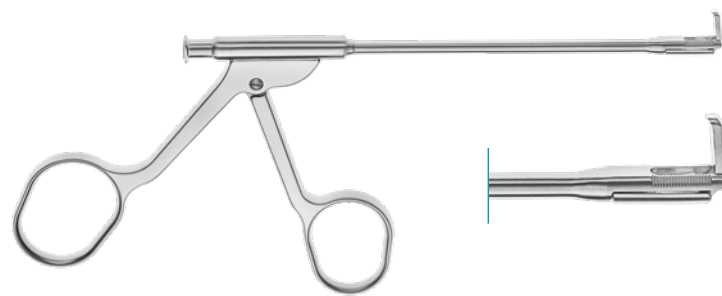

**OSTROM**

Antrum punch, 2.5mm bite, backwards cutting, 100mm, 4" working length

upside cutting

252-015-100

right side cutting

252-115-100

left side cutting

252-215-100

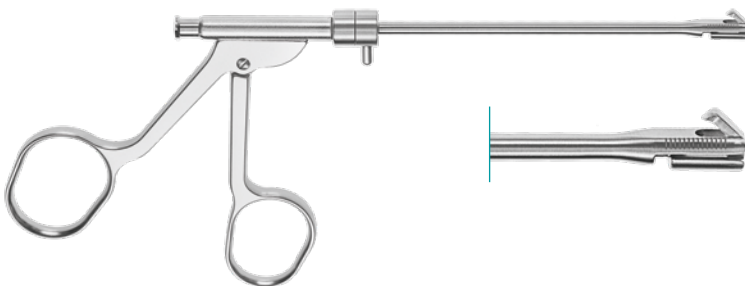

**OSTROM**

Antrum punch, 2.5mm bite, backwards cutting, 360° rotatable,

100mm, 4" working length

252-315-100

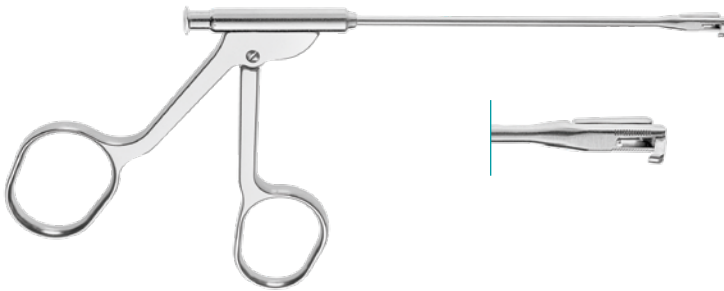
**OSTROM**

Antrum punch, 1.5mm bite, backwards cutting,  
100mm, 4" working length

upside cutting	252-010-100
right side cutting	252-110-100
left side cutting	252-210-100

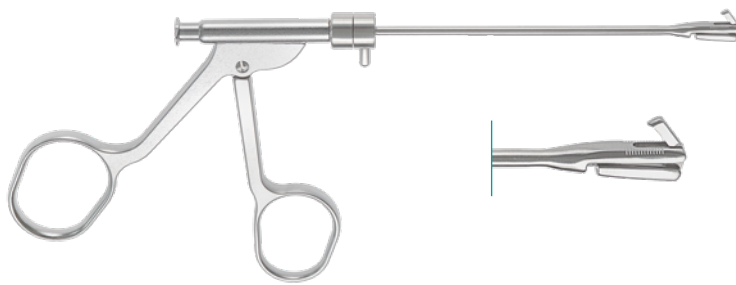
**OSTROM**

Antrum punch, 1.5mm bite, backwards cutting,  
360° rotatable

100mm, 4" working length	252-310-100
-----------------------------	-------------

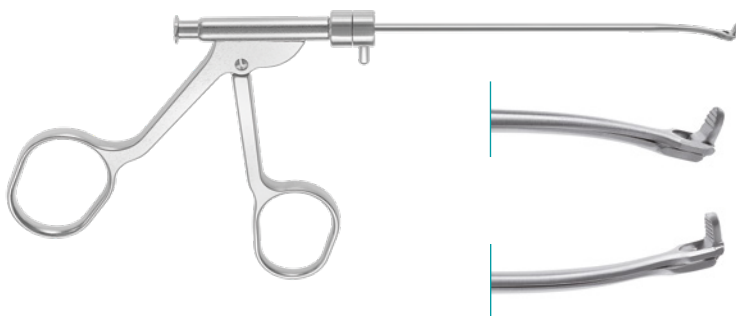
**OSTROM**

Ethmoidal Forceps, rotating, micro bite  
100mm, 4"

curved down	252-315-200
curved up	252-315-300

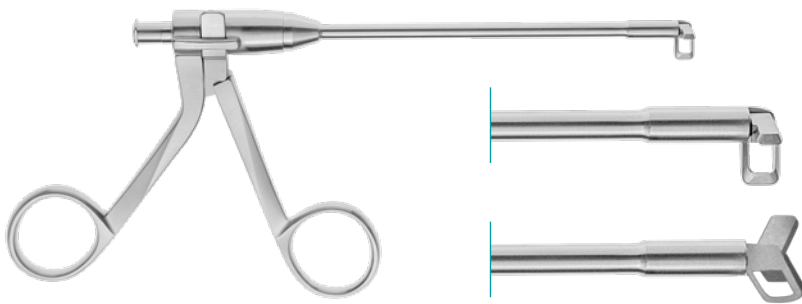
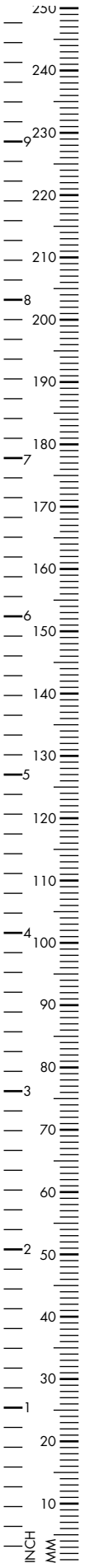

**SIDECUTTER**

Antrum punch, 3.5mm bite,  
100mm, 4" working length

downward right cutting	252-171-100
downward left cutting	252-173-100

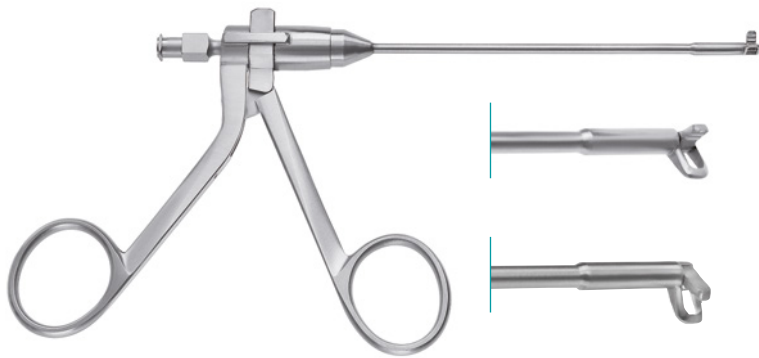

**SIDECUTTER**

Antrum punch, 2.5mm bite,  
100mm, 4" working length

left cutting	252-173-700
right cutting	252-171-700
downward right cutting	252-171-300
downward left cutting	252-173-300

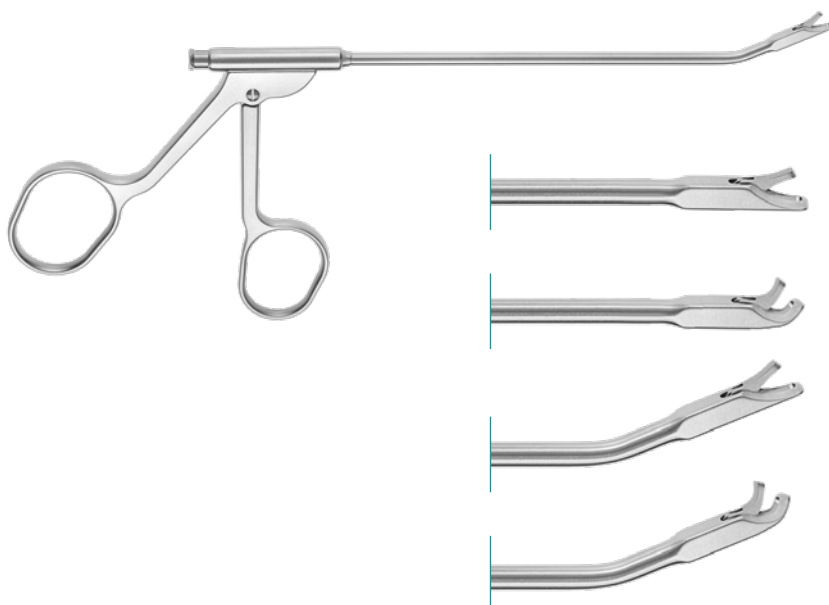

Nasal Forceps, 1.5mm, thru-cutting,  
with LuerLock, 130mm, 5<sup>1/8</sup>" working length

straight shaft	252-020-130
jaws 45° angled up	252-019-130
straight jaws, 30° curved up	252-017-130
30° curved up, jaws 45° angled up	252-015-130

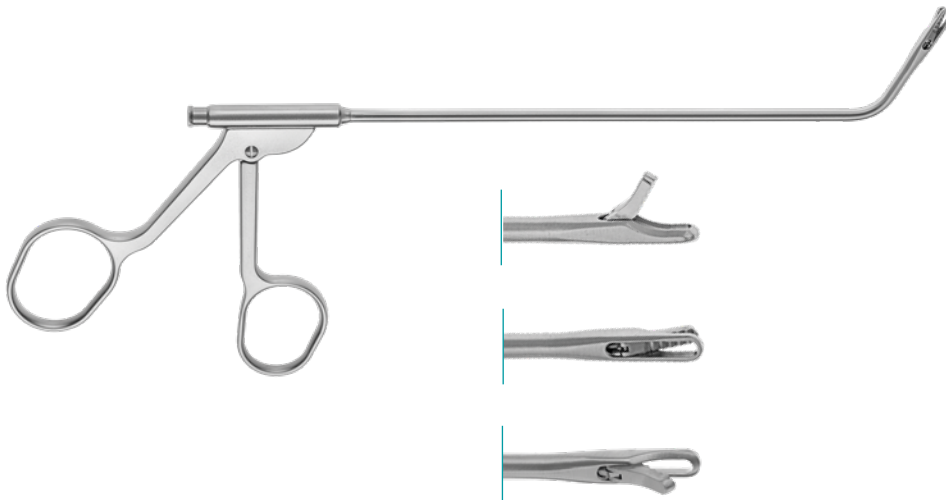

**NICOLAI**

Antrum Forceps, 2mm bite, 65° curved up

backward opening	252-477-141
left opening	252-477-142
right opening	252-477-143

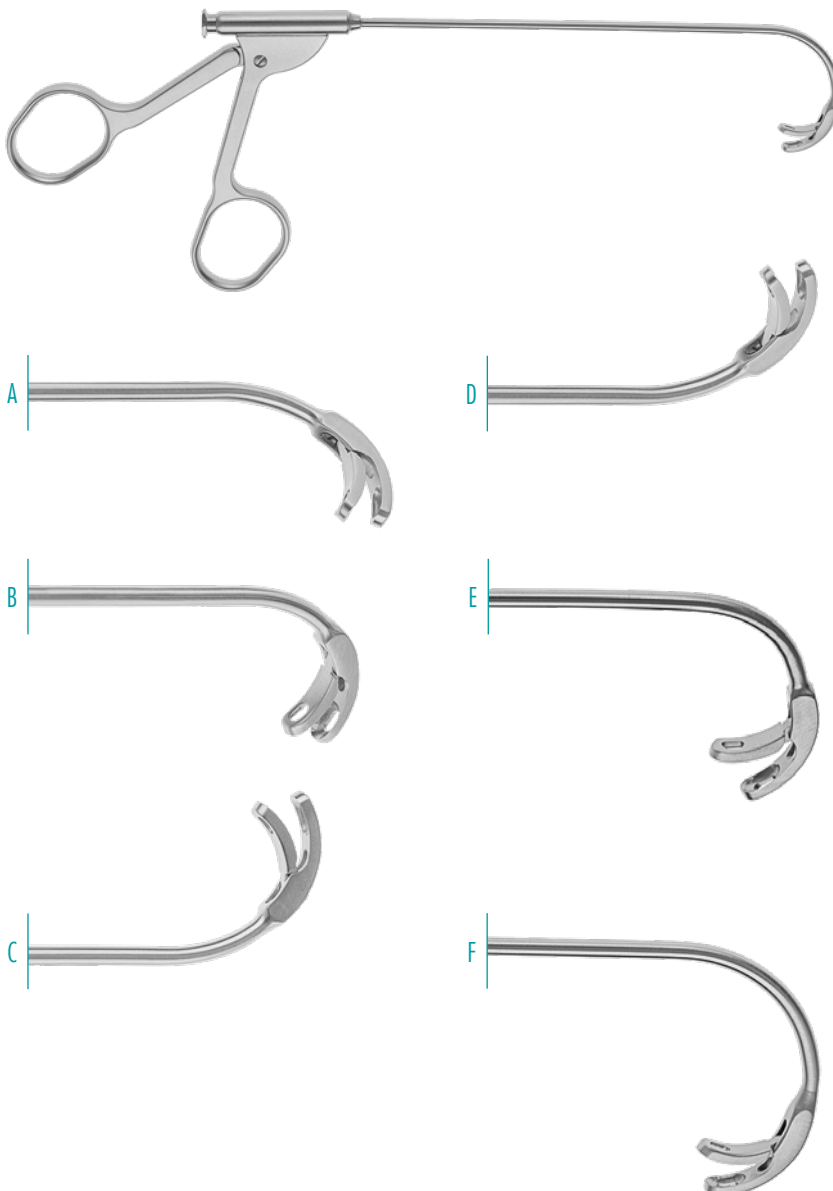

**HEUWIESER**

Antrum Grasping Forceps, 90° curved, 130mm, 5<sup>1/8</sup>"

A 120° backward opening	252-410-112
B 120° right opening	252-410-113
C 120° left opening	252-410-111
D 120° upwards angled	252-410-110
E 115° curved, 140° backward opening	252-410-114
F 140° curved, 155° backward opening	252-410-115

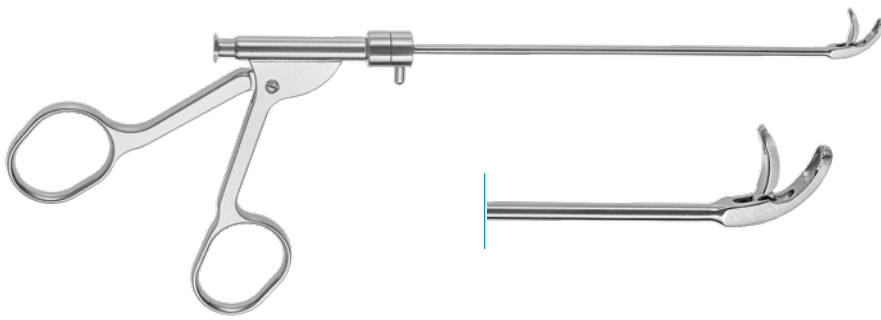
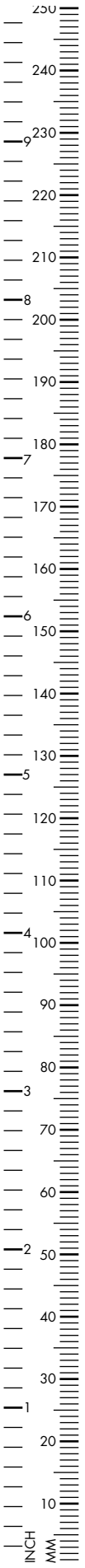

**HEUWIESER**

Antrum Grasping Forceps, rotating,  
130mm, 5<sup>1</sup>/<sub>8</sub>"

120° curved, 90° backward opening 252-411-112

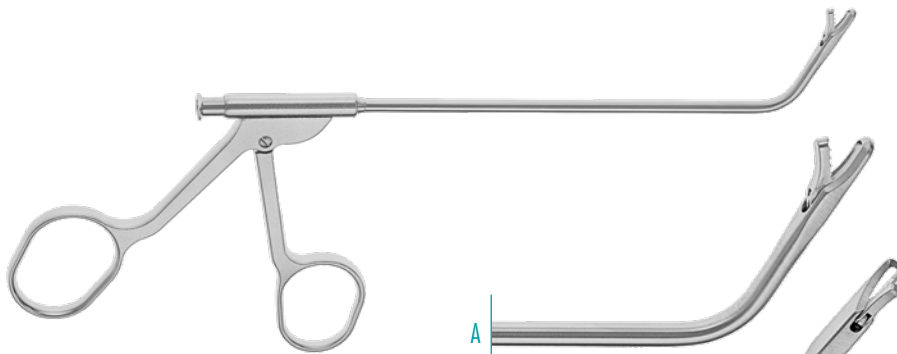

**GRÜNWALD**

Sinuscopy Forceps, 70° curved up,  
2.0mm cut, 130mm, 5<sup>1</sup>/<sub>8</sub>"

A upside opening 252-600-070

B right side cutting 252-601-070

C left side cutting 252-602-070



**KUHN**

Ethmoidal Forceps, 60° curved up,  
1.5mm cut, through-cutting,  
120mm, 4<sup>3</sup>/<sub>4</sub>"

A left 252-415-121

B right 252-415-122

C vertical opening 252-415-120

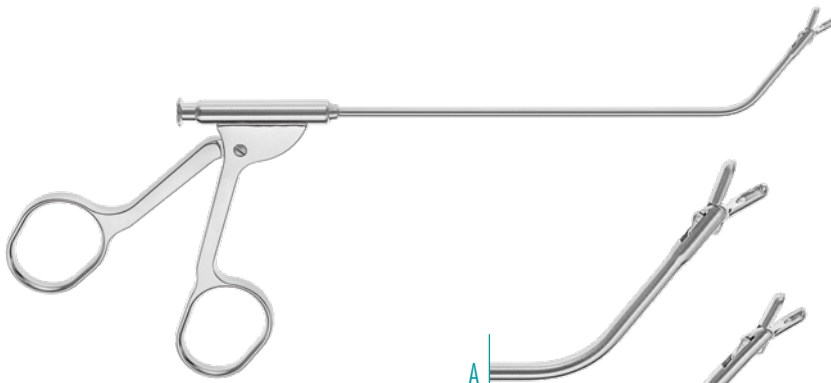

A

B

C

D

**KUHN-BOLGER**Giraffe Forceps, 55° angled up,  
130mm, 5<sup>1/8</sup>"

A vertical action, 3x6 mm	252-343-120
A vertical action, 2x4 mm	252-342-120
C horizontal action, 3x6 mm	252-353-120
D horizontal action, 2x4 mm	252-352-120



A

B

C

D

**RZ**Giraffe Biopsy Forceps, 4x8mm  
130mm, 5<sup>1/8</sup>"

A 110°, vertical opening	252-570-120
B 70°, vertical opening	252-470-120
C 110°, horizontal opening	252-770-120
D 70°, horizontal opening	252-670-120

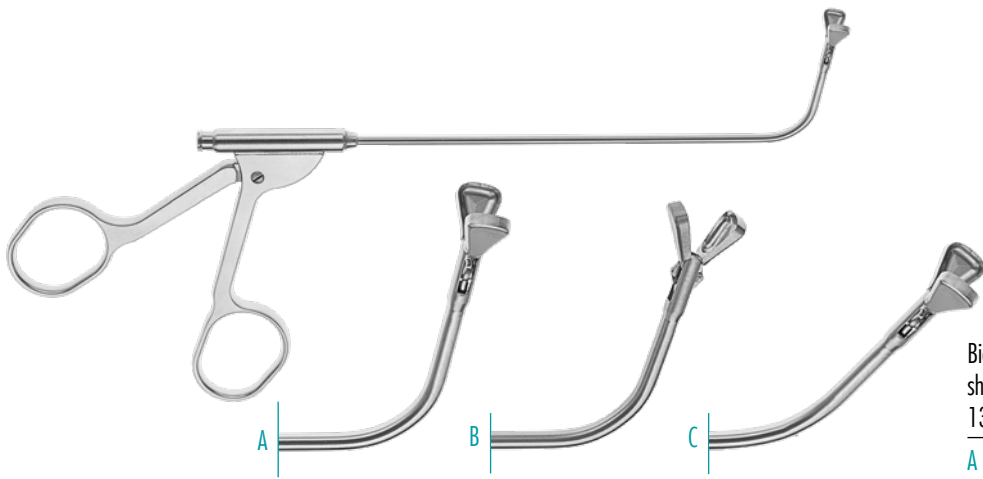

Biopsy Forceps, horizontal opening,  
shaft 80° upcurved, pear-shaped  
130mm, 5<sup>1</sup>/<sub>8</sub>"

A horizontal opening	252-473-130
B vertical opening	252-472-130
C 45° horizontal opening	252-471-130

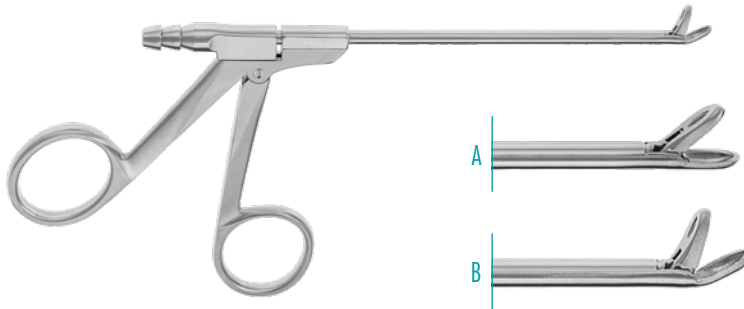

**BLAKESLEY**

Suction Punch, 3.5mm jaw,  
Ø 4.0mm shaft

A straight	252-022-100
B curved up	252-122-100

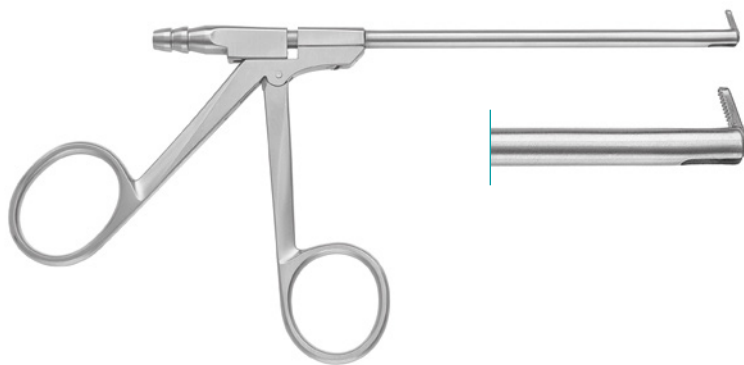

**OSTROM**

Suction Punch, 2.5mm jaw  
Ø 5.0mm shaft

upside	252-015-500
right	252-015-520
left	252-015-510

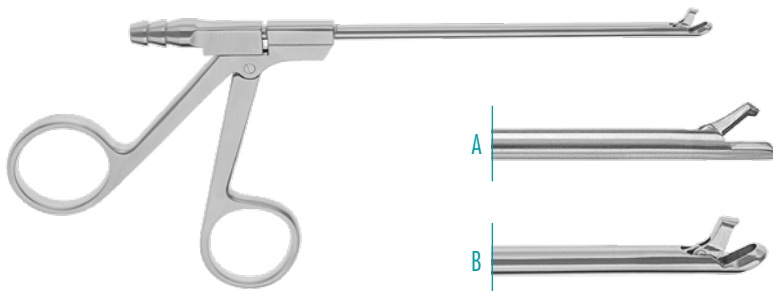

**GRUENWALD**

Suction Punch, 2.0mm jaw  
Ø 4.0mm shaft, through-cutting

A straight	252-502-100
B upcurved	252-502-145

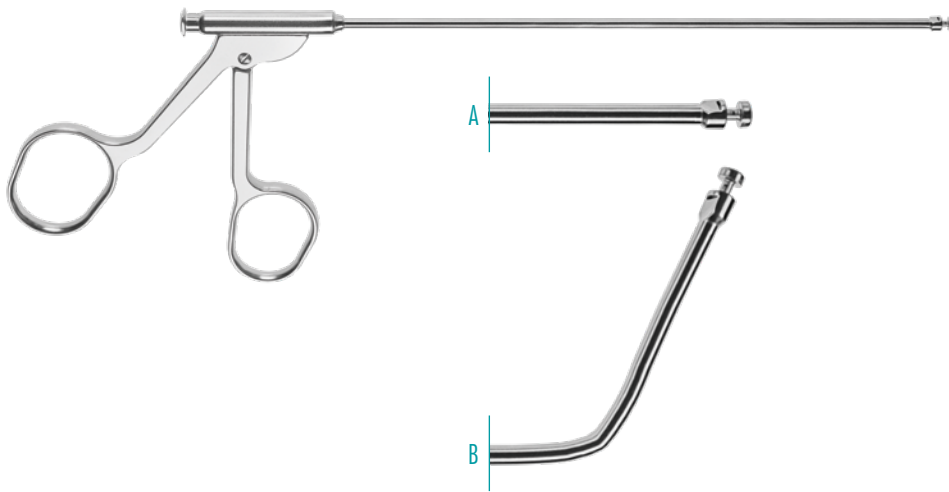

**STAMMBERGER**

Circular Punch, 160mm, 6<sup>1</sup>/<sub>4</sub>"

A straight

Ø 3.5mm 252-533-170

Ø 4.5mm 252-536-170

B 65° curved up

Ø 3.5mm 252-534-170

Ø 4.5mm 252-537-170

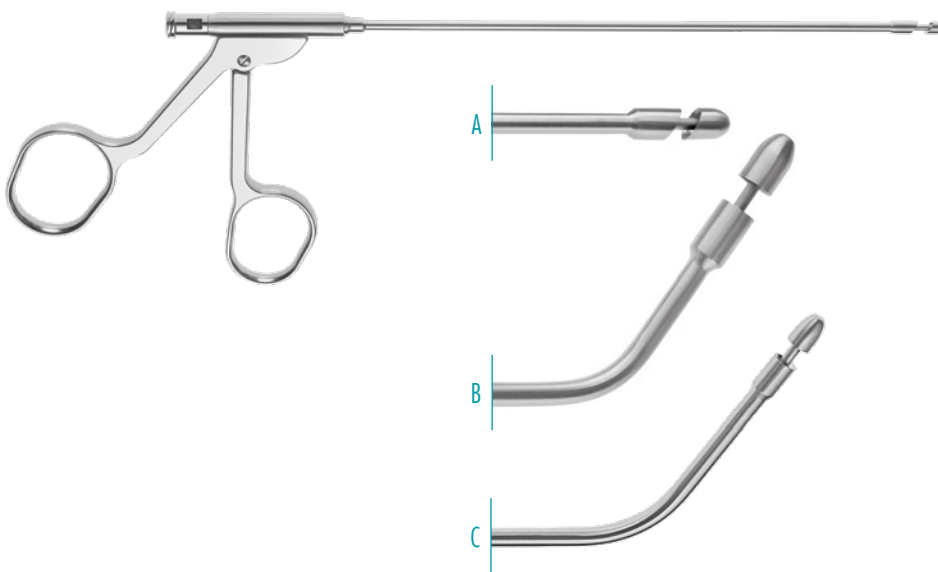

Circular Punch, 160mm, 6<sup>1</sup>/<sub>4</sub>"

A straight, 60° oblique bite

Ø 3.5mm 252-536-435

Ø 4.5mm 252-536-445

B 60° curved up

Ø 3.5mm 252-536-435

Ø 4.5mm 252-536-445

C 60° curved up, oval

Ø 3.5mm 252-537-335

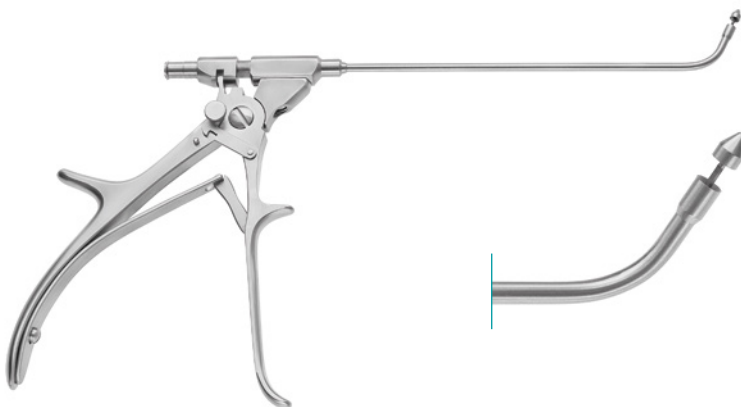

Circular Punch, 70° upturned shaft,  
with Luer-Lock

Ø 3.5mm 252-534-270

Ø 4.5mm 252-537-270

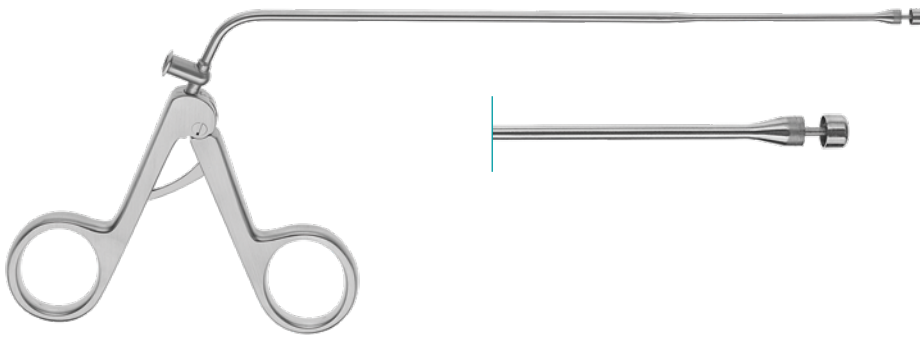

Circular Punch, straight, with Luer-Lock  
180mm working length

Ø 3.5mm	252-536-235
Ø 4.5mm	252-536-245

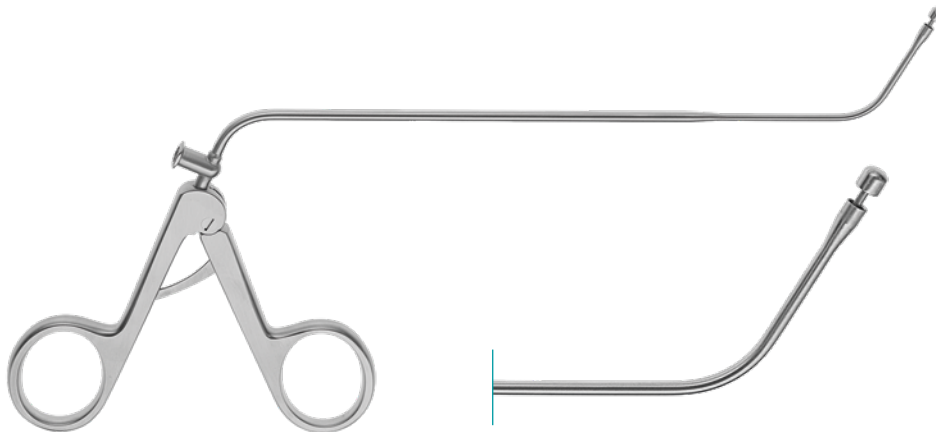

Circular Punch, 60° upcurved, with Luer-Lock  
180mm working length

Ø 3.5mm	252-536-435
Ø 4.5mm	252-536-445

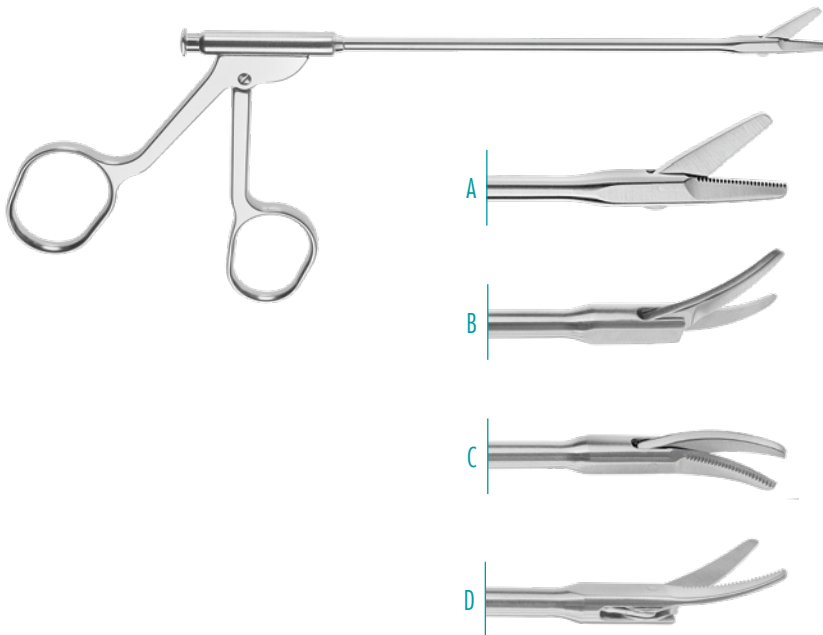

Nasal Scissors,  $\varnothing$  3.5mm  
130mm, 5<sup>1</sup>/<sub>8</sub>"

A straight	252-023-130
B left curved	252-024-130
C right curved	252-025-130
D curved up	252-026-130

**OLIVECRONA**

Nasal Scissors, serrated

230mm, 9"	120-208-230
-----------	-------------

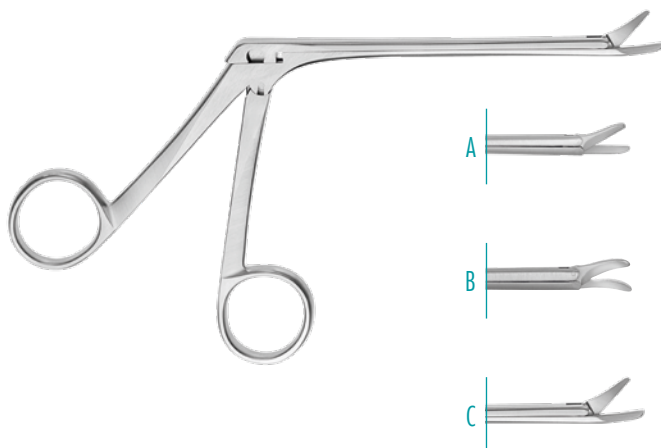

Nasal Scissors, serrated upper blade,  
120mm, 4<sup>3</sup>/<sub>4</sub>"

A straight	420-414-120
B right curved	420-415-120
C left curved	420-416-120

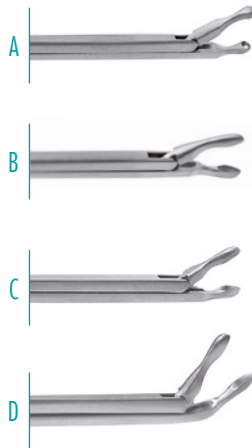
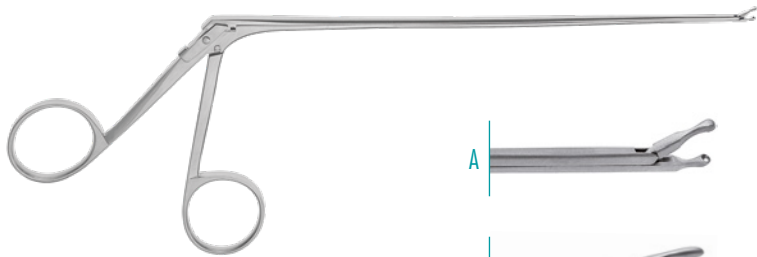
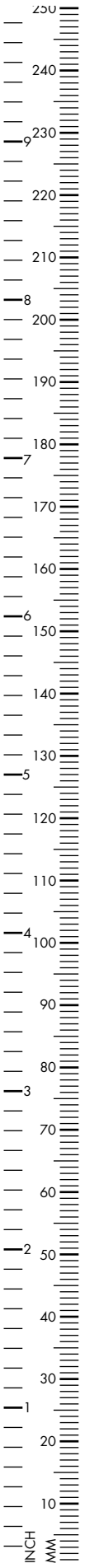

Oval Cup Forceps, 0.6mm jaw  
160mm working length

A straight	252-810-160
B right curved	252-811-160
C left curved	252-813-160
D 45° upwards angled	252-815-160

190mm working length

A straight	252-810-190
B right curved	252-811-190
C left curved	252-813-190
D 45° upwards angled	252-815-190

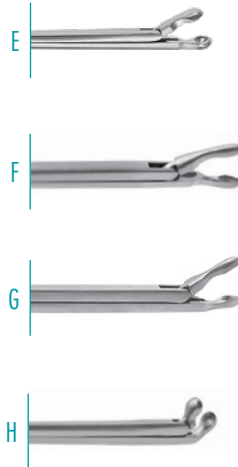
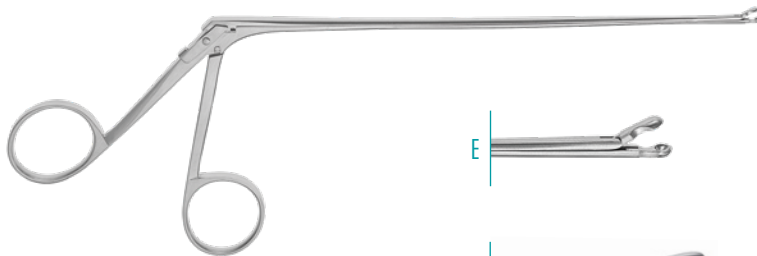

Oval Cup Forceps, 2.5mm jaw  
160mm working length

E straight	252-816-160
F right curved	252-817-160
G left curved	252-818-160
H 45° upwards angled	252-819-160

190mm working length

E straight	252-816-190
F right curved	252-817-190
G left curved	252-818-190
H 45° upwards angled	252-819-190

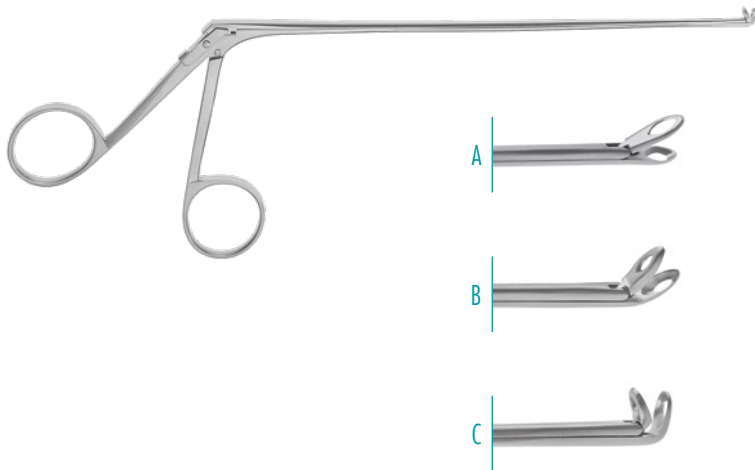
**STRÜMPEL**

Forceps, 2.5 x 7.0mm jaw,  
160mm working length

A straight	252-820-160
B 60° upwards	252-821-160
C 90° upwards	252-823-160

190mm working length

A straight	252-820-190
B 60° upwards	252-821-190
C 90° upwards	252-823-190

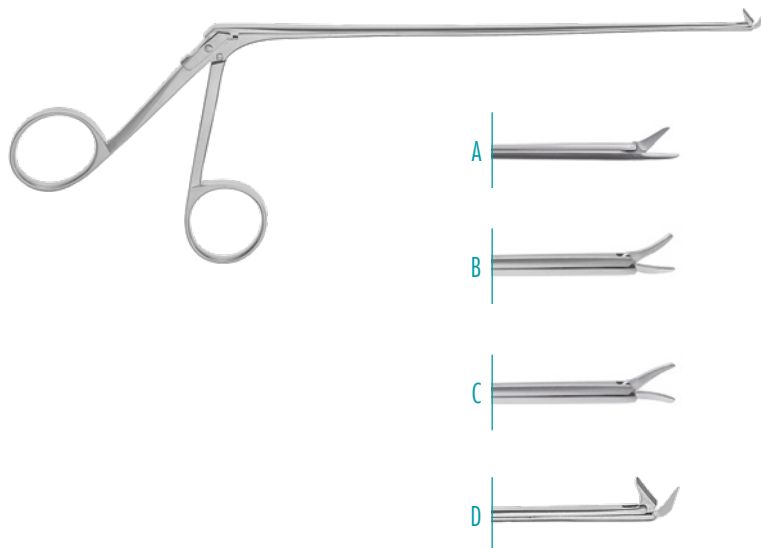

Scissors, 5mm blade,  
160mm working length

A straight	252-830-160
B right curved	252-831-160
C left curved	252-833-160
D upwards angled	252-835-160

190mm working length

A straight	252-830-190
B right curved	252-831-190
C left curved	252-833-190
D upwards angled	252-835-190

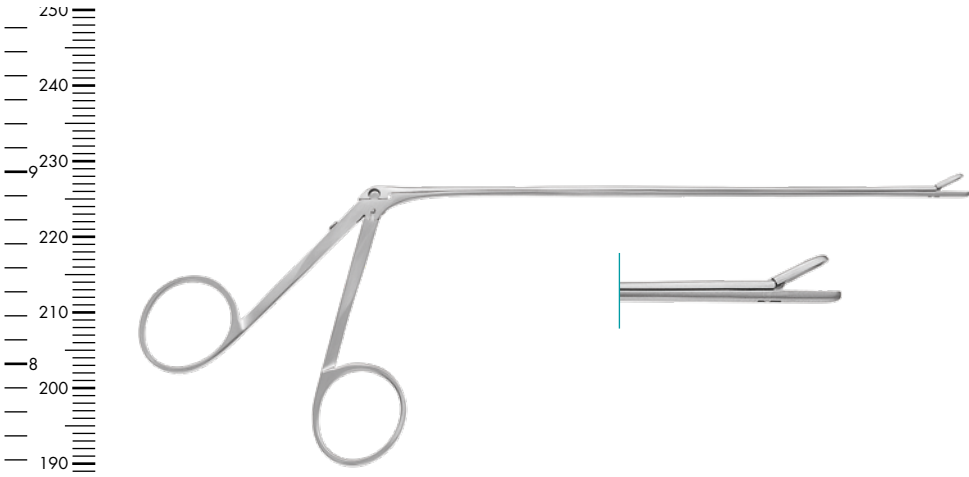

**DECKER**

Rongeur, fine model, 2x6mm jaw  
150mm, 6"

straight	250-066-817
left curved	250-066-824
right curved	250-066-827

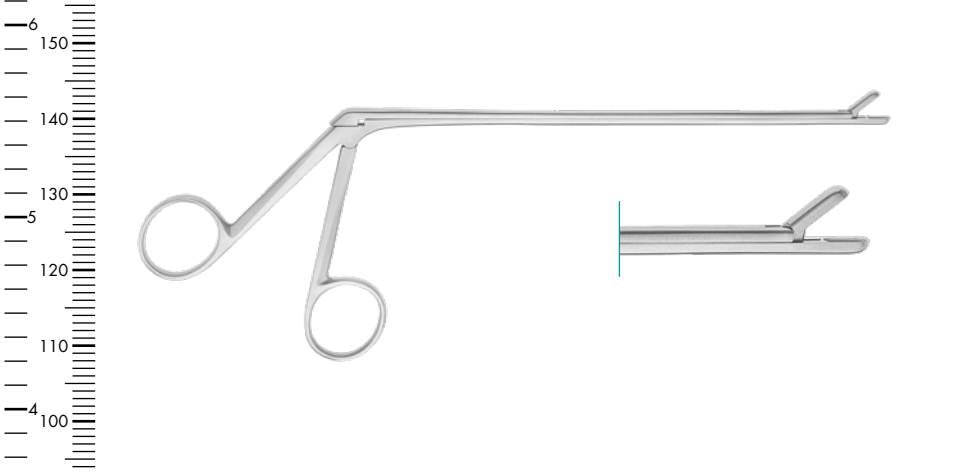

**DECKER**

Rongeur, 2x6mm jaw, straight

150mm, 6"	250-067-817
-----------	-------------

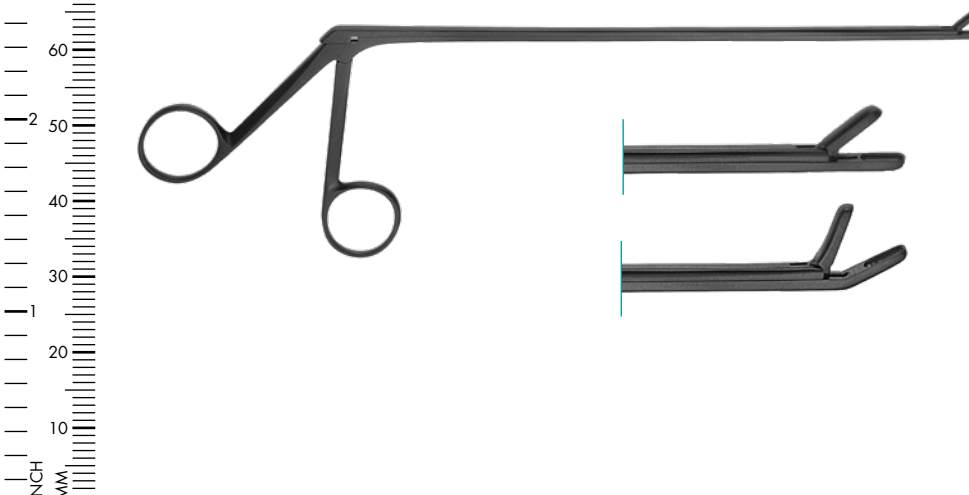

Micro Rongeur, CERA-CUT®  
2mm jaw, 170mm, 6<sup>2</sup>/<sub>3</sub>"

straight	250-300-170CC
upcurved	250-301-170CC

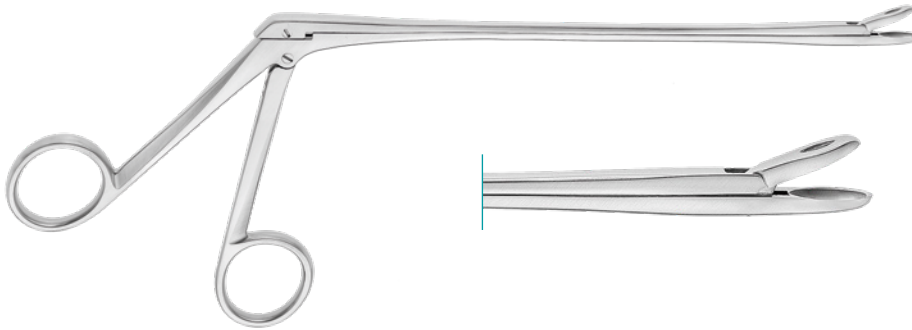
**WEIL BLAKESLEY**

Rongeur, fenestrated jaw,  
180mm, 7", straight

3.0mm	252-030-180
3.5mm	252-035-180
4.0mm	252-040-180
upwards angled	
3.0mm	252-030-181
3.5mm	252-035-181
4.0mm	252-040-181

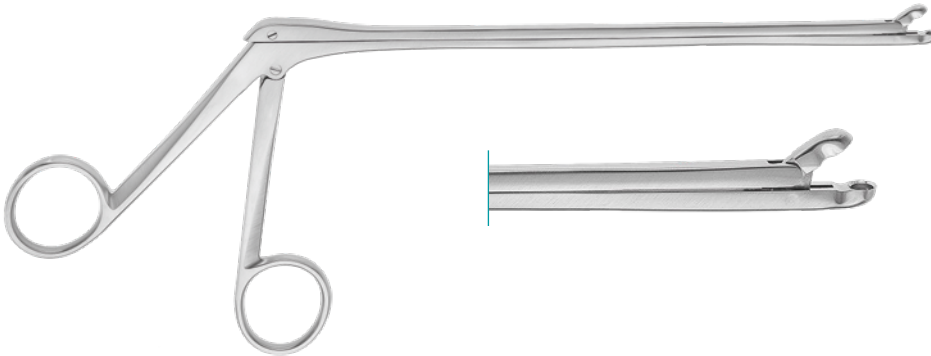
**YASARGIL**

Rongeur, 190mm, 7<sup>1/2</sup>"

Ø2.2mm	250-066-599
Ø3.5mm	250-066-600

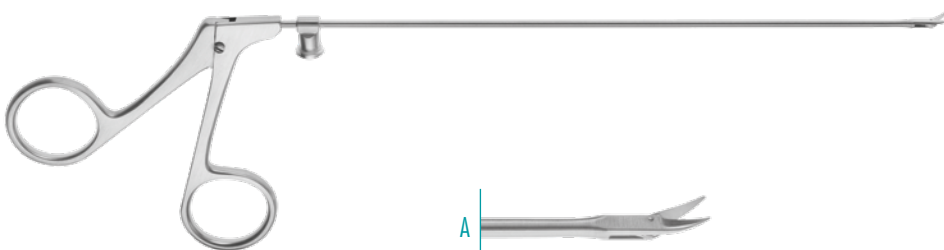

Micro Instrument with Luer-Lock  
160mm, 6<sup>1/4</sup>" working length

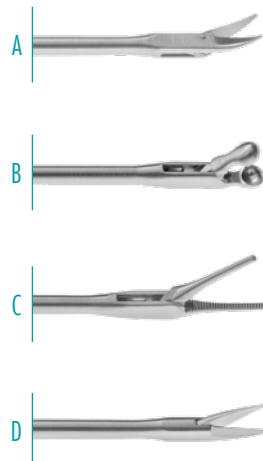

**A**  
Micro Scissors

250-064-223

**B NICOLA**  
Micro Forceps, Ø 2.5mm

250-064-222

**C YASARGIL NICOLA**  
Micro Grasping Forceps, 1mm conical jaw

250-064-224

**D NICOLA**  
Micro Scissors, straight

250-064-226

**CUSHING LANDOLT**

Specula for transsphenoidal hypophysectomy,  
black finishing

70 x 15mm	250-150-100
90 x 15mm	250-150-101
100 x 15mm	250-150-102

**PAPAERO CASPAR**

Specula for trans-sphenoidal hypophysectomy,  
stainless steel

80 x 11mm	250-150-589
90 x 13mm	250-150-590
100 x 15mm	250-150-591

black finishing

80 x 11mm	250-150-689
90 x 13mm	250-150-690
100 x 15mm	250-150-691

Key for specula

250-150-592



Transnasal Speculum, stainless steel, matted

80 x 9mm	250-150-280
90 x 9mm	250-150-290
100 x 9mm	250-150-300

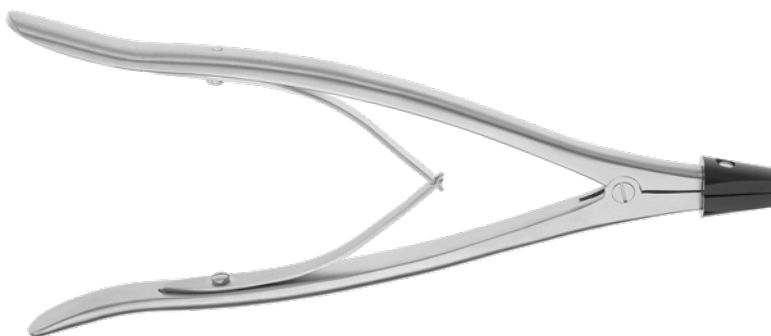
**LANDOLT**

Spreader for specula

210mm, 8 <sup>1</sup> / <sub>4</sub> "	250-150-210
--	-------------

**BAYOSPHERE**

Micro Instruments, bayonet-shaped, 100mm working length



A

B



Micro Spoon Forceps

A vertical

2mm	252-800-102
4mm	252-800-104
6mm	252-800-106

B horizontal

2mm	252-800-112
4mm	252-800-114
6mm	252-800-116



A

B

C

D

E



Micro Scissors

A sharp, straight	252-800-200
B sharp, left curved	252-800-201
C sharp, right curved	252-800-203
D sharp, horizontal	252-800-204
E blunt, straight	252-800-210

**BAYOSPHERE**

Micro Instruments, bayonet-shaped, 100mm working length



Micro Grasping Forceps

A	0.5mm, smooth	252-800-405
B	3.0mm, serrated	252-800-430
C	0.75mm, left curved	252-800-475



Micro Needle Holder

A	2x6mm, straight	252-800-510
B	1x6mm, left curved	252-800-511



YASARGIL Clip Applying Forceps

A	Standard Clips	252-800-810
B	Mini Clips	252-800-820

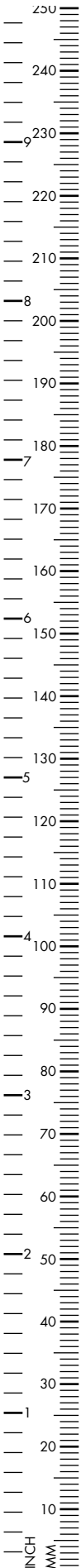



**HARDY**

Ring Curette, bayonet-shaped, 240mm, 9<sup>1</sup>/<sub>2</sub>"

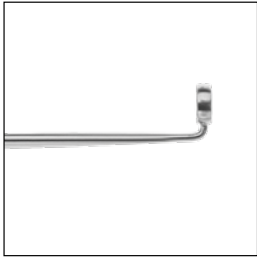

upwards angled

Ø 3mm 250-066-500  
Ø 5mm 250-066-501

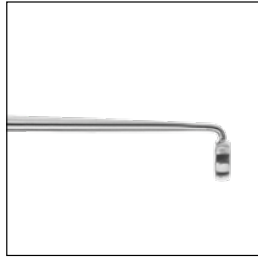

downwards angled

Ø 3mm 250-066-502  
Ø 5mm 250-066-503

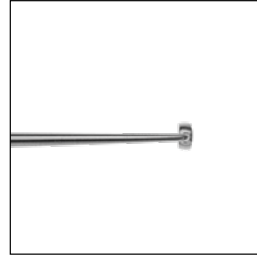

90° curved left

Ø 3mm 250-066-504  
Ø 5mm 250-066-505



45° curved right

Ø 3mm 250-066-506  
Ø 5mm 250-066-507

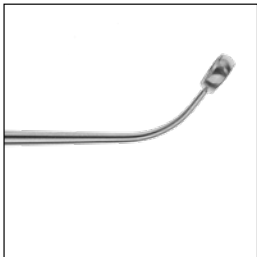

left curved

Ø 5mm 250-066-508



right curved

Ø 5mm 250-066-509

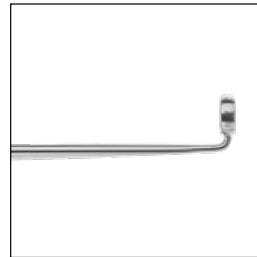

260mm, 10<sup>1</sup>/<sub>4</sub>" malleable

Ø 4mm 250-066-631  
Ø 6mm 250-066-632



**RAY**

Ring Curette, 190mm, 7<sup>1</sup>/<sub>2</sub>"

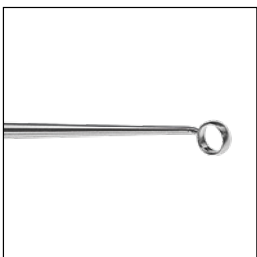

45° horizontal curved

Ø 4mm 250-066-611

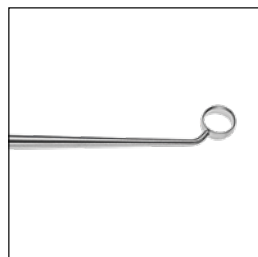

45° vertically curved

Ø 4mm 250-066-614

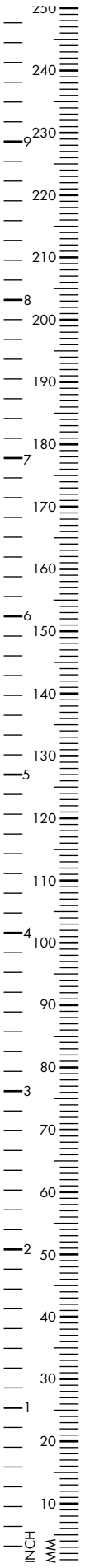

**NICOLA**  
Ring Curette, 210mm, 8 1/4"

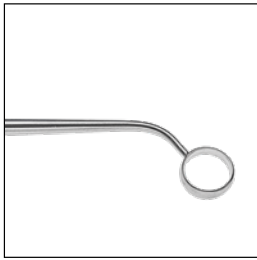

cutting to right  
Ø 6.5mm 250-066-616

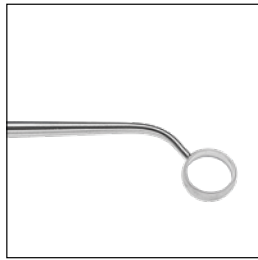

cutting to left  
Ø 6.5mm 250-066-617

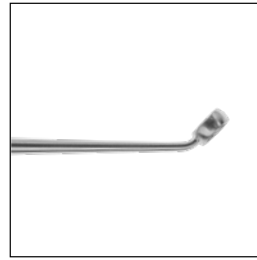

curved up  
Ø 6.5mm 250-066-618

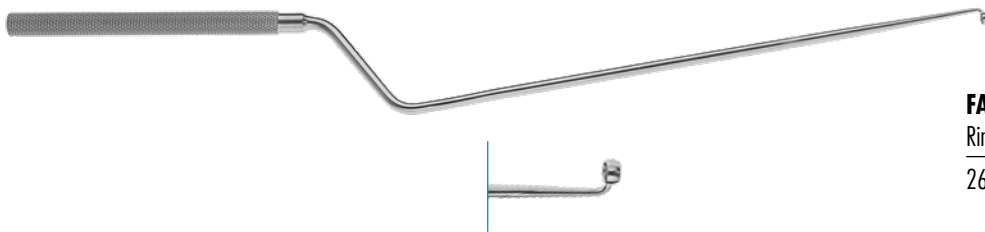

**FAHLBUSCH**  
Ring Curette, 90°, Ø 2.5mm, malleable  
260mm, 10 1/4" 250-066-637

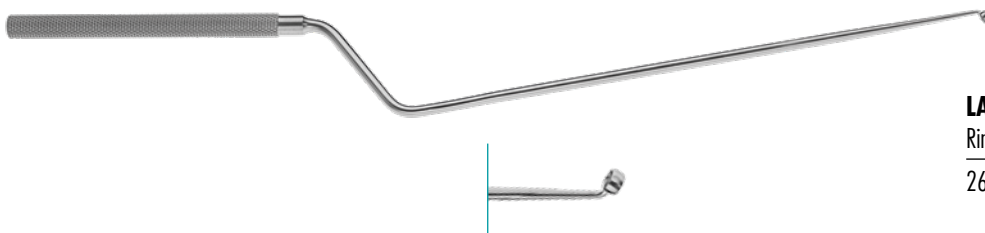

**LANDOLT-REULEN**  
Ring Curette, 45°, Ø 2.5mm  
260mm, 10 1/4" 250-066-642

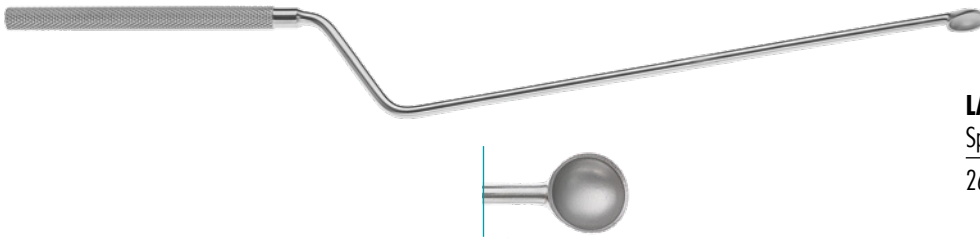
**LANDOLT**

Spoon, malleable

260mm, 10<sup>1</sup>/<sub>4</sub>"

250-066-628

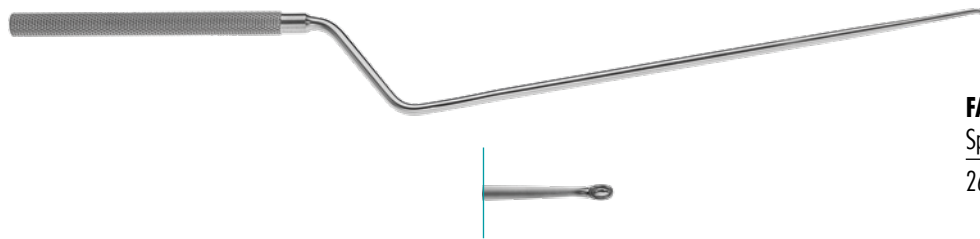
**FAHLBUSCH**

Spoon, malleable

260mm, 10<sup>1</sup>/<sub>4</sub>"

250-066-635

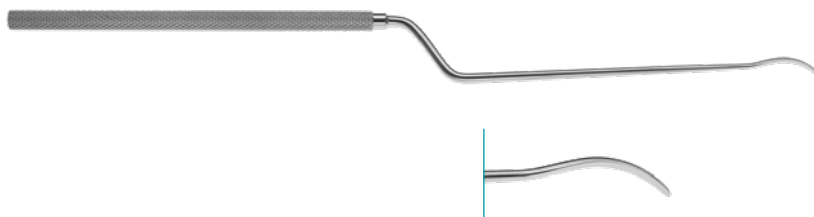
**NICOLA**

Raspatory, 2mm

215mm, 8<sup>1</sup>/<sub>2</sub>"

250-066-619

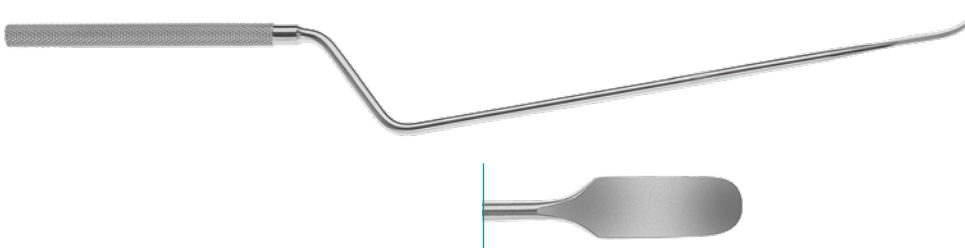
**LANDOLT**

Raspatory, malleable

260mm, 10<sup>1</sup>/<sub>4</sub>"

250-066-627

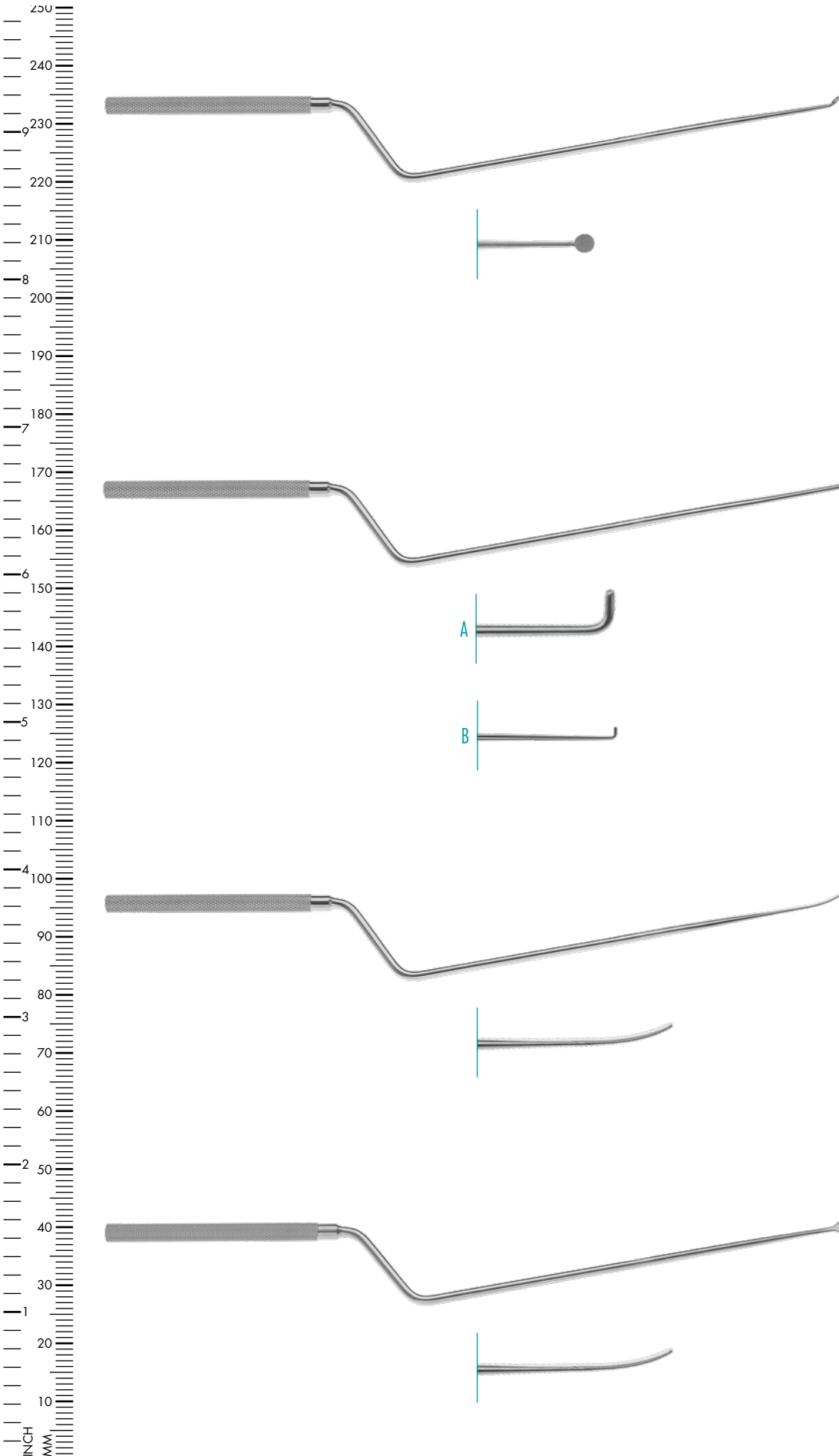

**LANDOLT-REULEN**

Raspator, 260mm, 10<sup>1/4</sup>"  
malleable

Ø 2.2mm 250-066-640

**LANDOLT**

Hook, blunt

A 260mm, 10<sup>1/4</sup>" 250-066-629

**LANDOLT-REULEN**

Hook, blunt

B 260mm, 10<sup>1/4</sup>" 250-066-643

**LANDOLT-REULEN**

Dissector, Ø 2.0mm

260mm, 10<sup>1/4</sup>" 250-066-644

**HOSOBUCHI**

Fork Spatula

260mm, 10<sup>1/4</sup>" 250-066-630

**HARDY**Enucleator, blunt, 245mm, 9<sup>2</sup>/<sub>3</sub>"

A curved left 250-066-620

B curved right 250-066-621

**HARDY-FAHLENBUSCH**Enucleator, fine, sharpened inner edge,  
245mm, 9<sup>2</sup>/<sub>3</sub>"

C curved left 250-066-608

D curved right 250-066-609

**LANDOLT**Enucleator, malleable, 260mm, 10<sup>1</sup>/<sub>4</sub>"  
blunt

A right 250-066-625

B left 250-066-655

sharp

A right 250-066-626

B left 250-066-656

