

RHINOLOGY

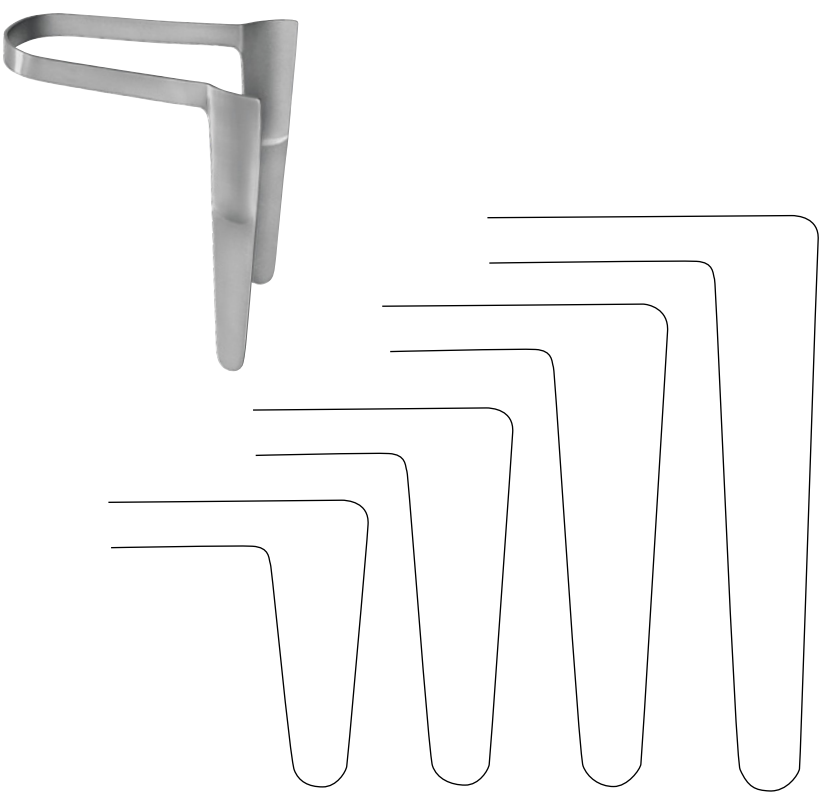

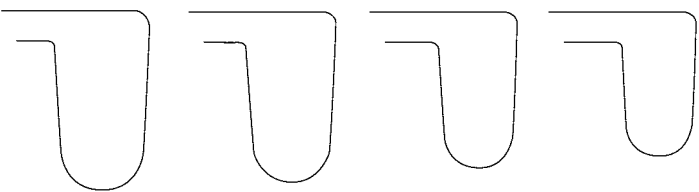
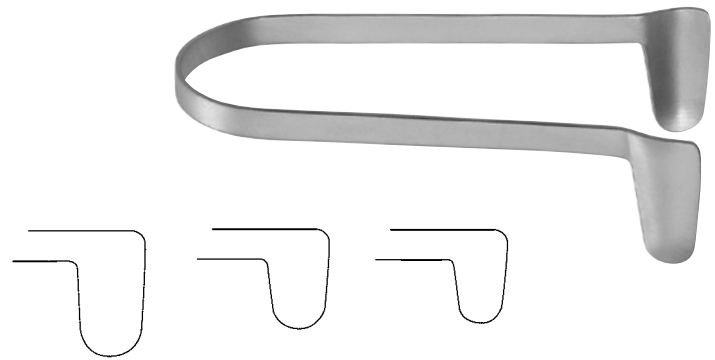
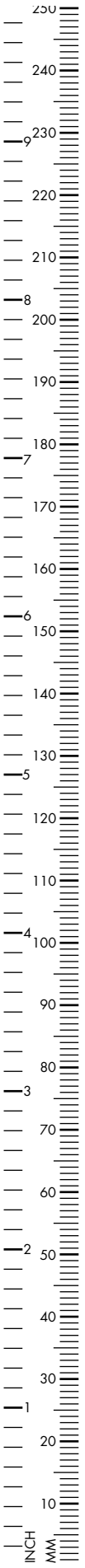

THUDICHUM (MARK HOVELL)

Nasal Specula, 70mm, 2 1/2"

8.5 x 6.0mm	420-050-001
9.0 x 7.0mm	420-050-002
12.5 x 8.0mm	420-050-003
15.0 x 8.5mm	420-050-004
18.0 x 10.0mm	420-050-006
19.5 x 10.5mm	420-050-007

insulated

8.5 x 6.0mm	420-050-101
9.0 x 7.0mm	420-050-102
12.5 x 8.0mm	420-050-103
15.0 x 8.5mm	420-050-104
18.0 x 10.0mm	420-050-106
19.5 x 10.5mm	420-050-107

ST. CLAIR THOMPSON

Nasal Specula, 73mm, 2 1/2"

38mm	420-052-001
50mm	420-052-002
65mm	420-052-003
75mm	420-052-004

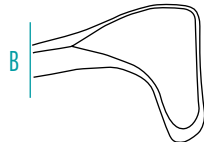
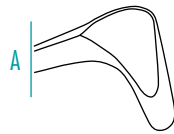
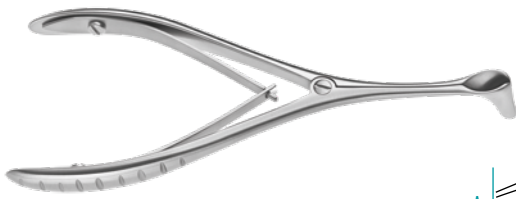

TIECK-HALLE

Nasal Specula, 135mm, 5¹/₃"

A Infants, 17.5mm 420-140-135

B Children, 21.0mm 420-142-135



BECKMANN

Nasal Specula, Infants, curved sidwards,
17.5mm

130mm, 5¹/₈" 420-147-140

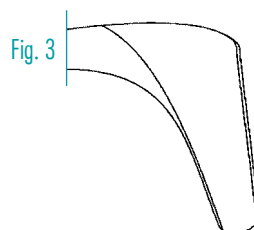
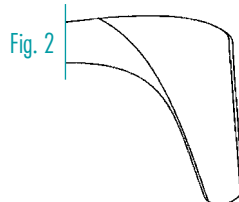
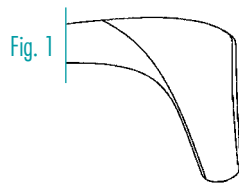

BECKMANN

Nasal Specula, 150mm, 6"

Fig. 1 22mm 420-148-150

Fig. 2 25mm 420-146-152

Fig. 3 28mm 420-146-153

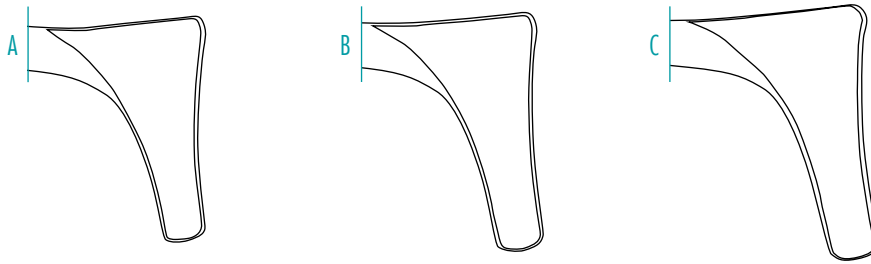
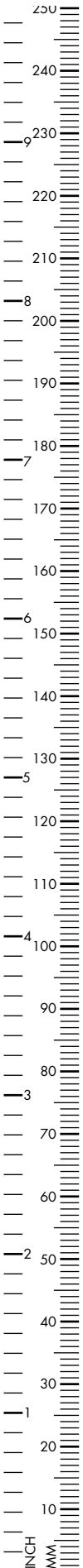

HARTMANN

Nasal Specula, 160mm, 6¹/₄"

A Fig. 1	420-119-001
29 x 7mm	
B Fig. 2	420-119-002
33 x 7mm	
C Fig. 3	420-119-003
35 x 7mm	

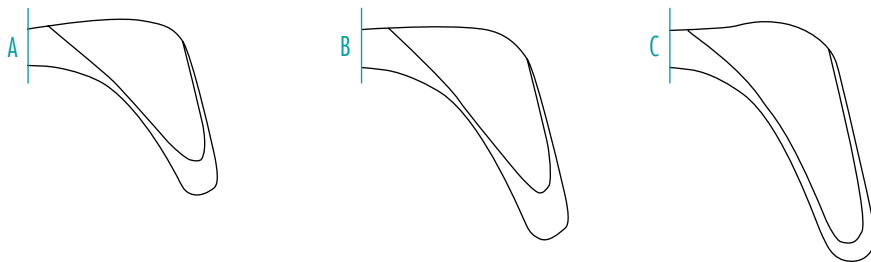

HARTMANN-HALLE

Nasal Specula, 155mm, 6¹/₈"

A Fig. 1, 27mm	420-121-150
B Fig. 2, 31mm	420-122-150
C Fig. 3, 37mm	420-123-150

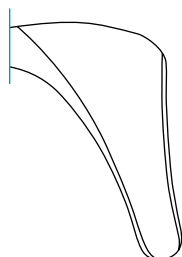

HARTMANN-HALLE

Nasal Speculum, tapered blade, aseptic joint, 155mm, 6¹/₈"

Fig. 2, 33mm	420-124-033
--------------	-------------

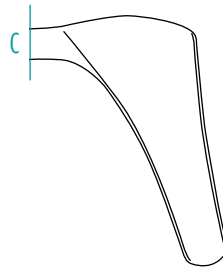
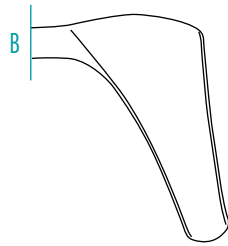
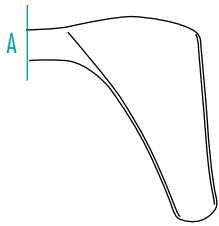

MOD. VIENNA

Nasal Specula, 130mm, 5¹/₈"

A Fig. 1 420-100-001
28 x 7mm

B Fig. 2 420-100-002
30 x 7mm

C Fig. 3 420-100-003
32 x 7mm

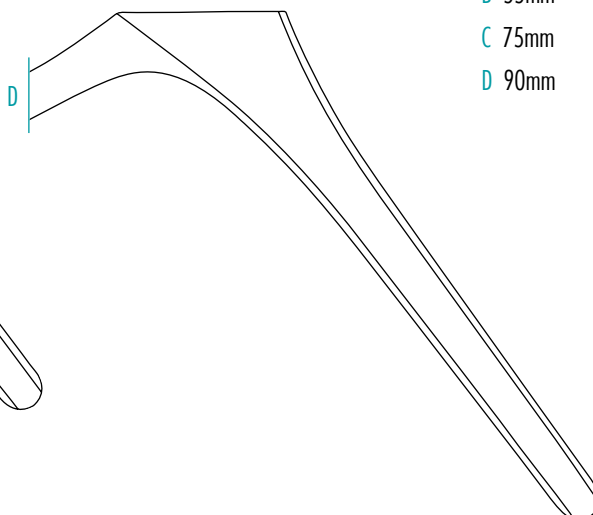
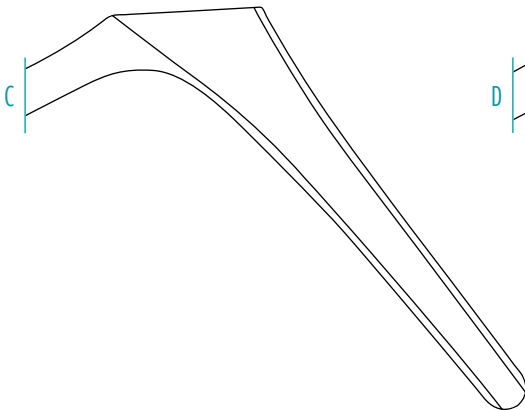
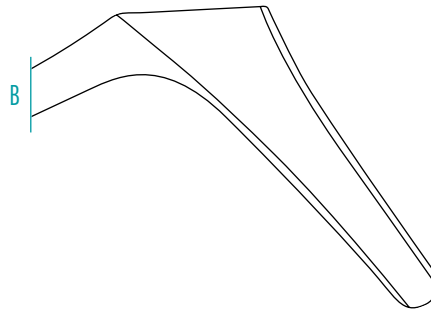
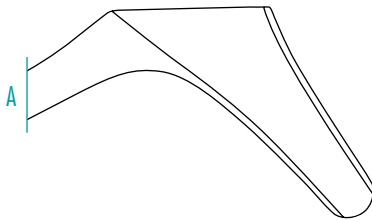

KILLIAN-STRUYCKEN

Nasal Speculum, aseptic joint, 140mm, 5¹/₂"

A 40mm 420-147-040

B 55mm 420-147-055

C 75mm 420-147-075

D 90mm 420-147-090



with locking screw

A 40mm 420-146-040

B 55mm 420-146-055

C 75mm 420-146-075

D 90mm 420-146-090

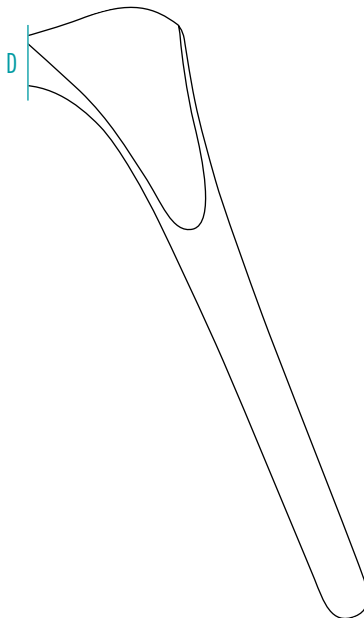
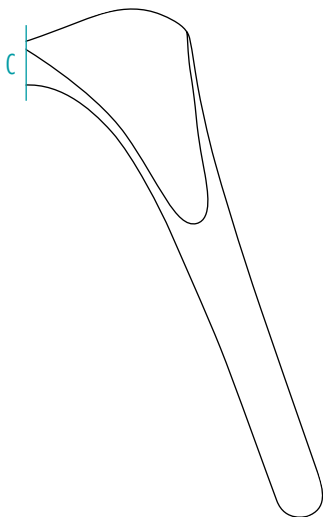
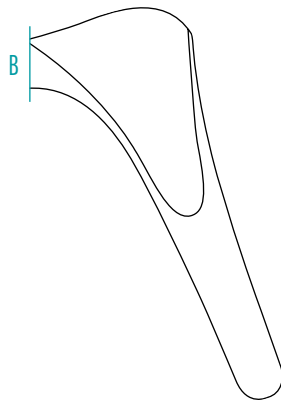
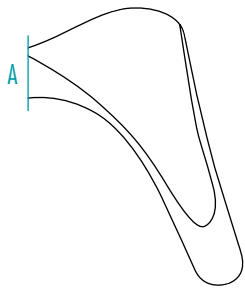

KILLIAN

Nasal Speculum, aseptic joint, 140mm, 5 1/2"

A 40mm	420-143-040
B 55mm	420-143-055
C 75mm	420-143-075
D 90mm	420-143-090

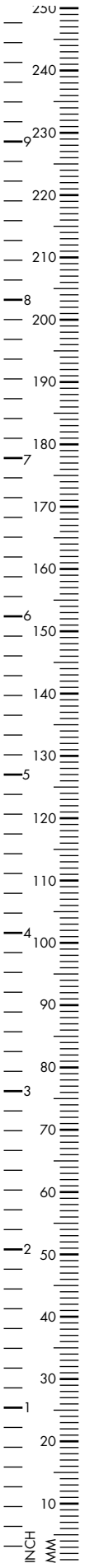

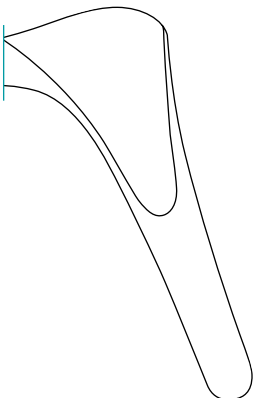
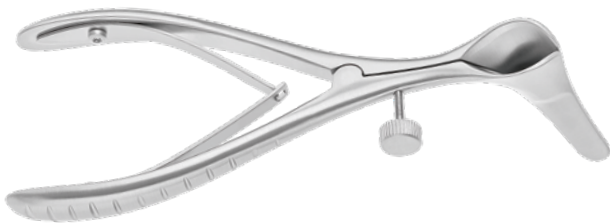
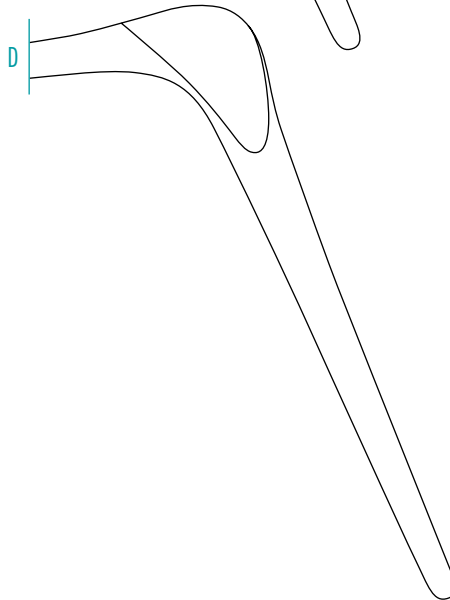
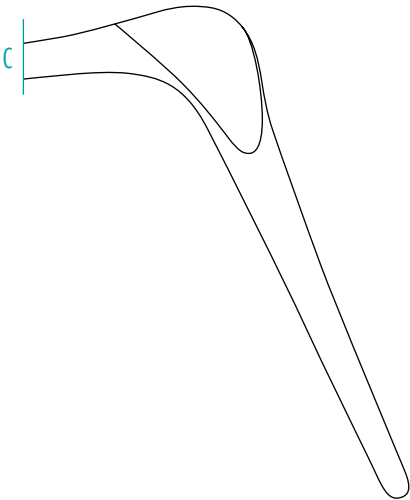
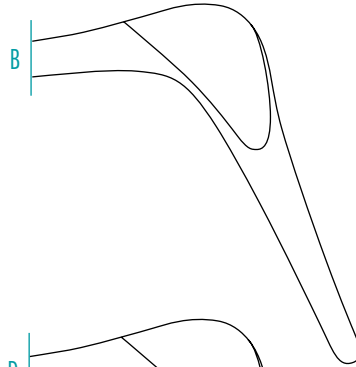
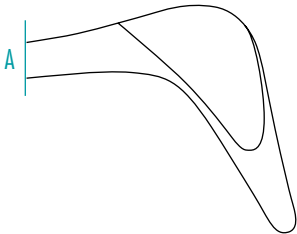

COTTLE

Nasal Speculum, aseptic joint, 130mm, 5¹/₈"

A	35mm	420-132-035
B	50mm	420-132-055
C	75mm	420-132-075
D	90mm	420-132-090



KILLIAN-WALTER

Nasal Speculum, thin blades, aseptic joint, 140mm, 5¹/₂"

	55mm	420-138-055
--	------	-------------

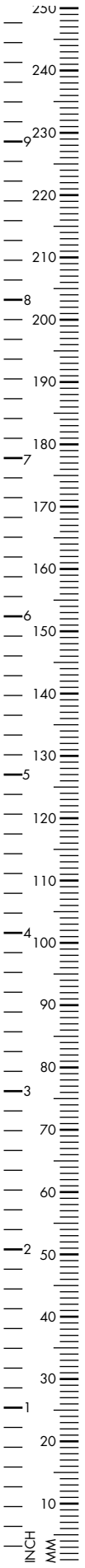

COTTLE

Nasal Speculum, aseptic joint, 130mm, 5¹/₈"

A	35mm	420-135-035
B	55mm	420-135-055
C	65mm	420-135-065
D	75mm	420-135-075
E	90mm	420-135-090

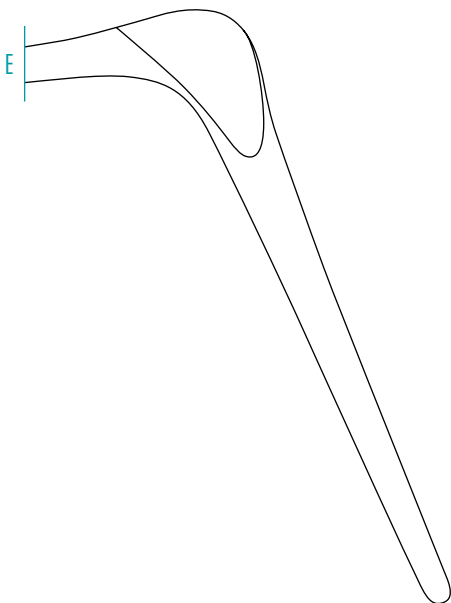
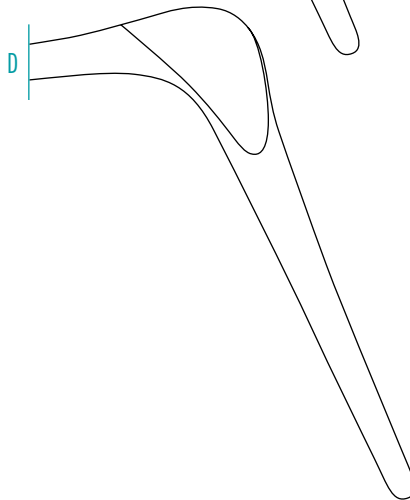
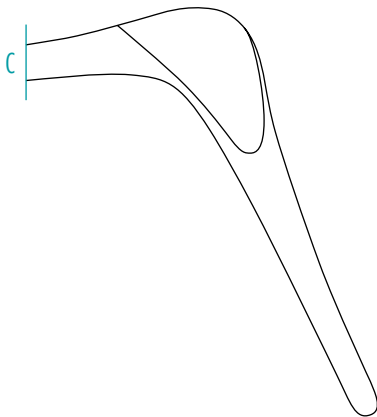
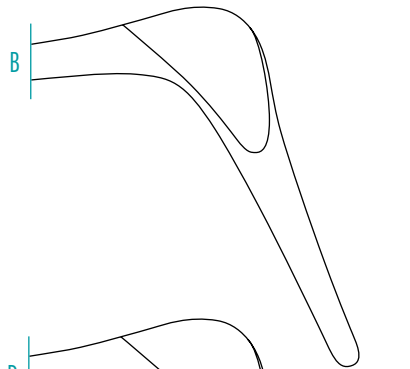
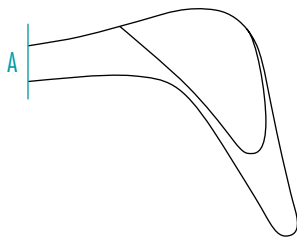

**COTTLE**

Nasal Speculum, aseptic joint,
with detachable cold light carrier,
140mm, 5^{1/2}"

A	40mm	420-743-040
B	55mm	420-743-055
C	75mm	420-743-075
D	90mm	420-743-090

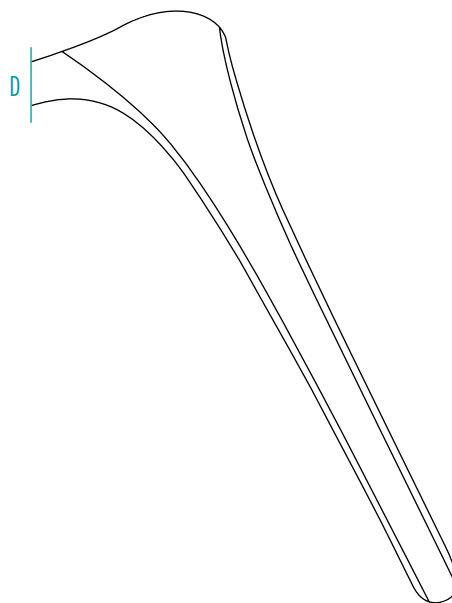
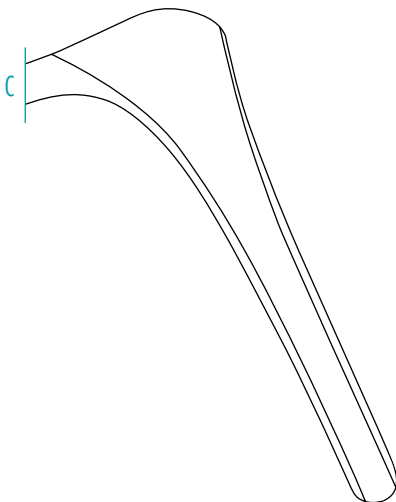
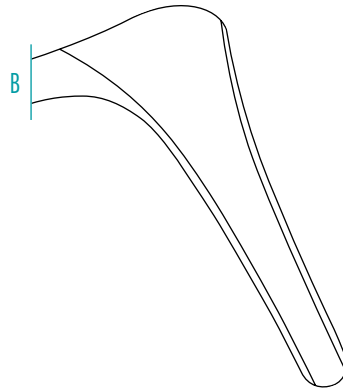
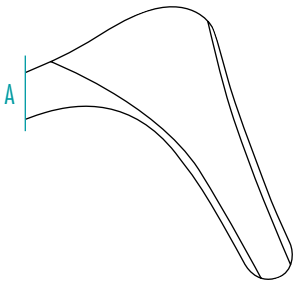

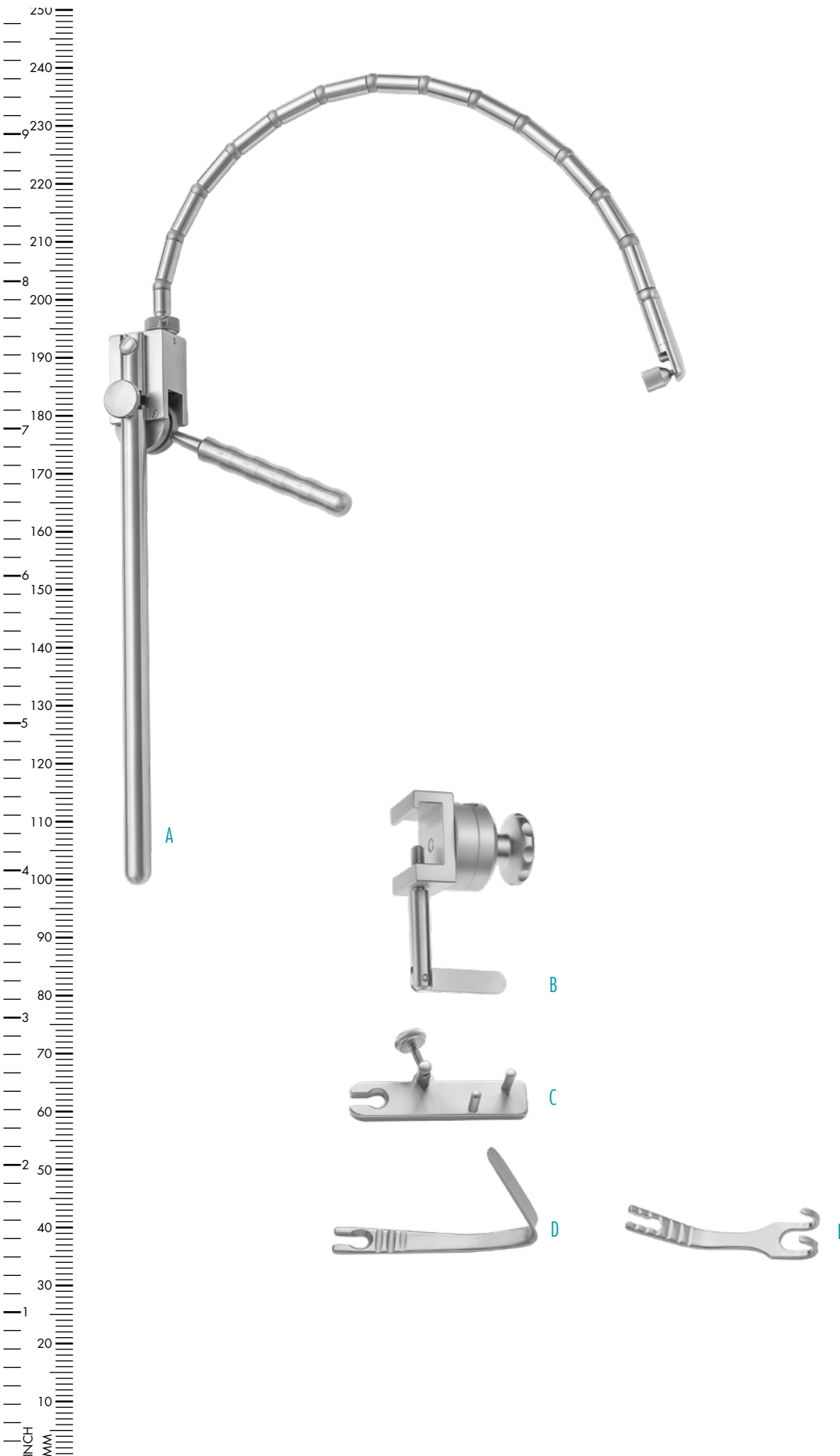

Flexible Arm, complete with holding rod,
without rotating clamp

A 251-010-000

Rotating clamp for flexible tension arm
attachable to operating table

B 251-010-100

Nasal Specula Clamp for flexible arm

C 251-010-400

AUFRICHT

Nasal Specula for flexible arm

D 251-010-500

AUFRICHT

Nasal Hook, 2 prongs, for flexible arm

E 251-010-600

**COTTLE MASING**

Nasal Specula for flexible arm

35mm	420-140-035
50mm	420-140-050
75mm	420-140-075
90mm	420-140-090
100mm	420-140-100

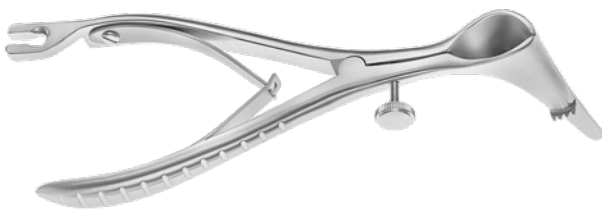
Sinus Specula for flexible arm,
with teeth

left: 55mm right: 35mm	420-150-001
left: 35mm right: 55mm	420-150-002
left: 65mm right: 45mm	420-150-003
left: 45mm right: 65mm	420-150-004
left: 75mm right: 35mm	420-150-005
left: 35mm right: 75mm	420-150-006
left: 75mm right: 40mm	420-150-007
left: 40mm right: 75mm	420-150-008

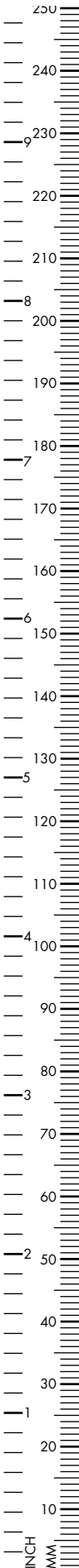

KILLIAN

Nasal Probe, slightly curved, Ø 1.5mm

165mm, 6¹/₂" 420-150-165



Nasal Probe, knee angled, Ø 1.4mm

160mm, 6¹/₄" 420-150-160



FARRELL

Applicator, triangulated serrated end, Ø 1.2mm

165mm, 6¹/₂" 160-426-165



Nasal Applicator, triangulated serrated end, Ø 1.1mm

160mm, 6¹/₄" 160-426-160



FARRELL (LATHBURY-UEBE)

Cotton Applicator, threaded, Ø 1.2mm

165mm, 6¹/₂" 160-420-165



Cotton Applicator, rough spiral end,
180mm, 7"

Ø 1.5mm 160-412-180

Ø 1.8mm 160-411-180



SIEBENMANN

Nasal Plugger

180mm, 7" 420-150-180



JANSEN

Nasal Dressing Forceps, bayonet shaped,
serrated jaws

160mm, 6^{1/4}" 410-395-160



GRUENWALD

Nasal Dressing Forceps, bayonet shaped,
serrated jaws

200mm, 8" 410-389-190



TROELTSCH (WILDE)

Nasal Dressing Forceps, knee bent

170mm, 6^{2/3}" 420-375-165

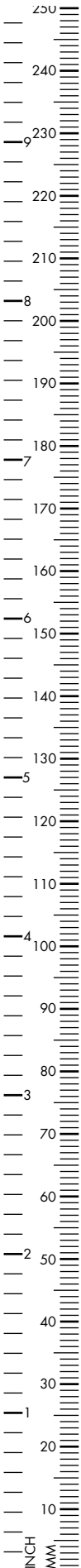

Suction Tube, 165mm, 6¹/₂"

Ø 3.0mm	410-165-030
Ø 3.5mm	410-165-035
Ø 4.5mm	410-165-045

Suction Tube, 195mm, 7²/₃"

Ø 4.5mm	410-195-045
---------	-------------



Nasal Suction Tube, Ø5mm, Ø6.5mm tip

180mm, 7"	165-064-160
-----------	-------------



FRAZIER

Suction Tube, 190mm, 7¹/₂"

Ø 1.6mm, 5 Charr.	165-523-005
Ø 2.0mm, 6 Charr.	165-523-006
Ø 2.3mm, 7 Charr.	165-523-007
Ø 2.5mm, 8 Charr.	165-523-008
Ø 3.0mm, 9 Charr.	165-523-009
Ø 3.3mm, 10 Charr.	165-523-010
Ø 3.6mm, 11 Charr.	165-523-011
Ø 4.0mm, 12 Charr.	165-523-012
Ø 5.0mm, 15 Charr.	165-523-015

**HARTMANN**

Nasal Dressing Forceps

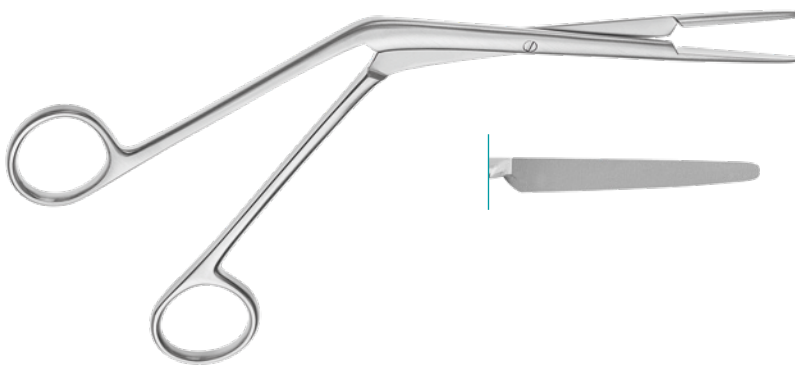
215mm, 8^{1/2}" 420-211-200175mm, 6^{7/8}" 420-211-160**LUBET-BARBON**

Polypus Forceps, smooth jaws

200mm, 8" 420-210-200

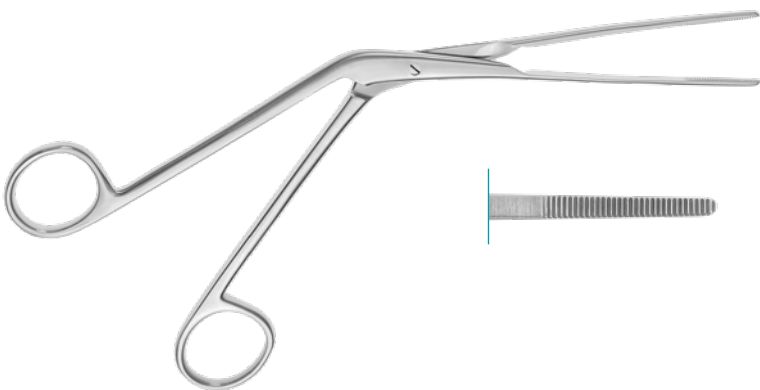
**WEST**

Nasal Dressing Forceps

200mm, 8" 420-411-200

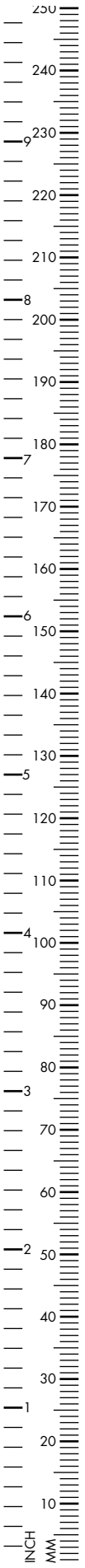

YANKAUER
Nasal Dressing Forceps

420-210-175



TILLEY
Nasal Dressing Forceps, serrated

130mm, 6¹/₄" 410-232-140

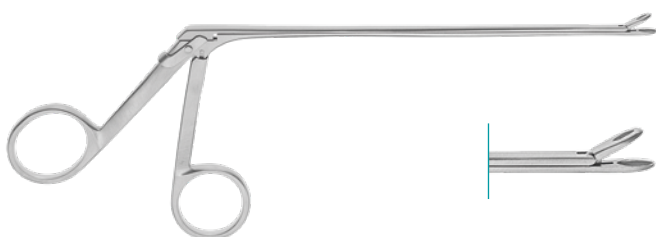

STRUEMPEL
Forceps, 2.5mm spoon

130mm, 6¹/₄" 410-338-234

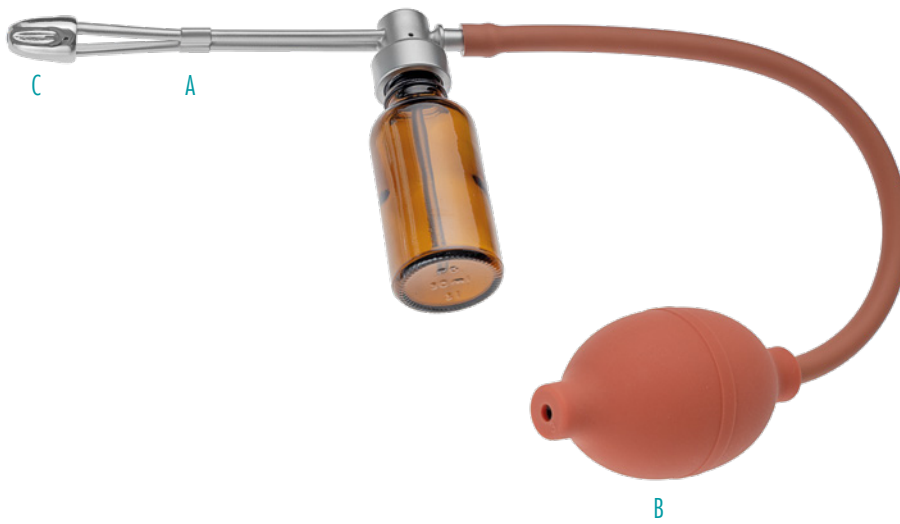

Universal Atomizer, complete set

410-228-000

A Liquid Atomizer only

410-228-050

B Rubber Bulb only

410-228-100

C Nose Guard only

410-228-010



GLATZEL

Nasal Mirror, 200 x 130mm

200 x 130mm

420-001-000

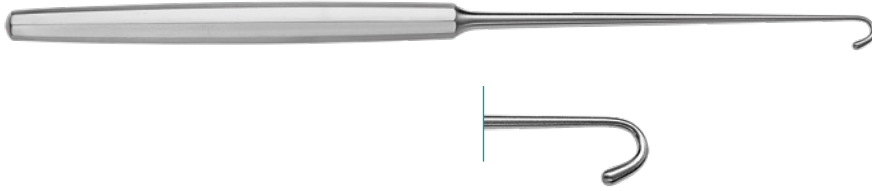
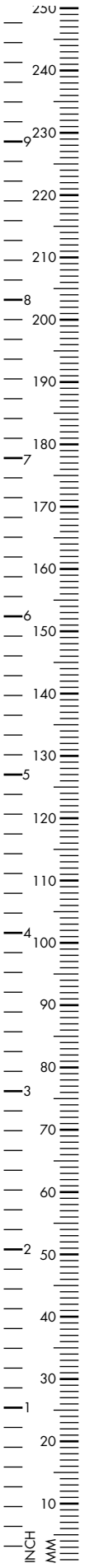

LANGE

Choana hook

230mm, 9"

420-413-230

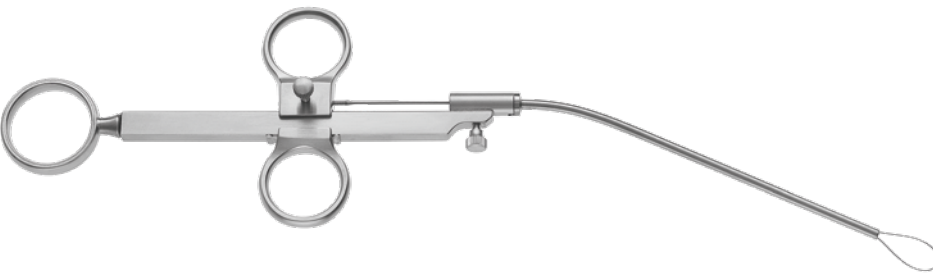

KRAUSE

Nasal Polypus Snare, knee bent

250mm, 9⁷/₈"

420-201-260

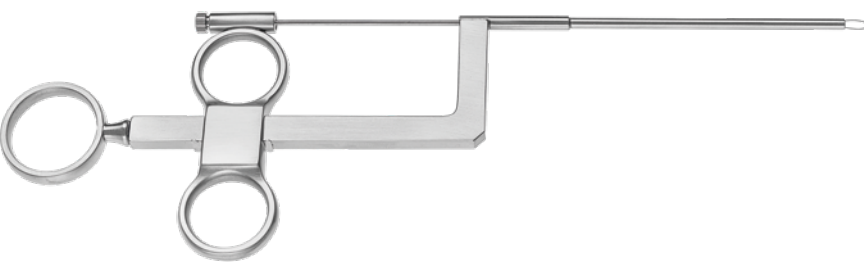

WILDE

Nasal Polypus Snare, bayonet shaped

250mm, 9⁷/₈"

410-270-250



Wire loops for nasal polyp snares,
package of 100pcs.

Ø 3.0mm 420-210-003



Snare Wire in coils, Ø 3.0mm,
1 coil of 10 meters

420-210-013



HEYMAN KNIGHT

Nasal Scissors, knee bent

180mm, 7" 120-283-180

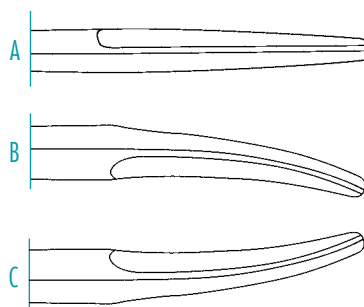
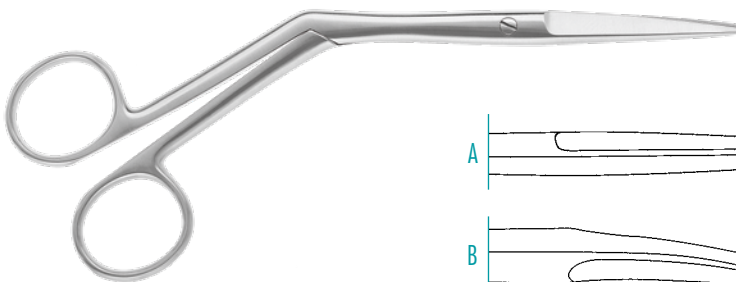

HEYMANN

Nasal Scissors, serrated upper blade,
190mm, 7^{1/2}"

A straight 120-284-180

B right curved 120-287-180

C left curved 120-285-180

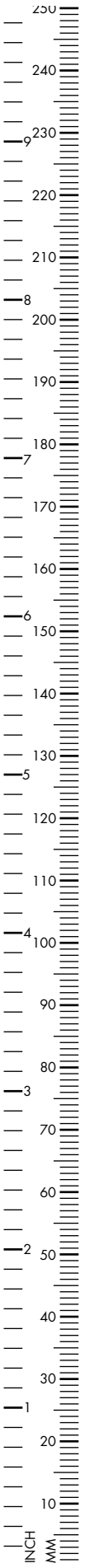

HEYMANN

TC Nasal Scissors, straight, serrated

195mm, 7³/₄"

120-585-180



KIRSTEIN

Nasal Scissors, serrated

180mm, 7"

120-285-175



OLIVECRONA

Nasal Scissors, serrated

230mm, 9"

120-208-230

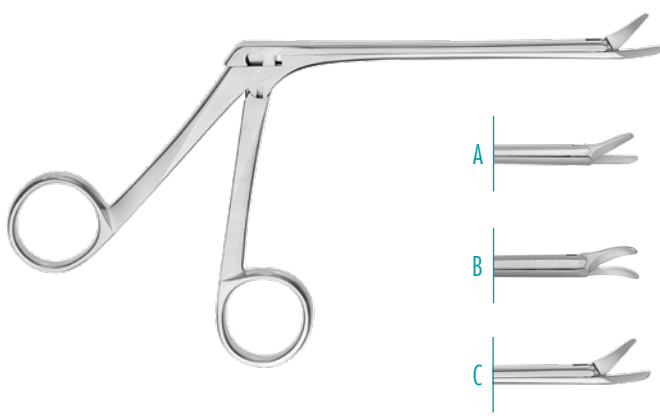

Nasal Scissors, serrated upper blade,
120mm, 4³/₄"

A straight 420-414-120

B right curved 420-415-120

C left curved 420-416-120

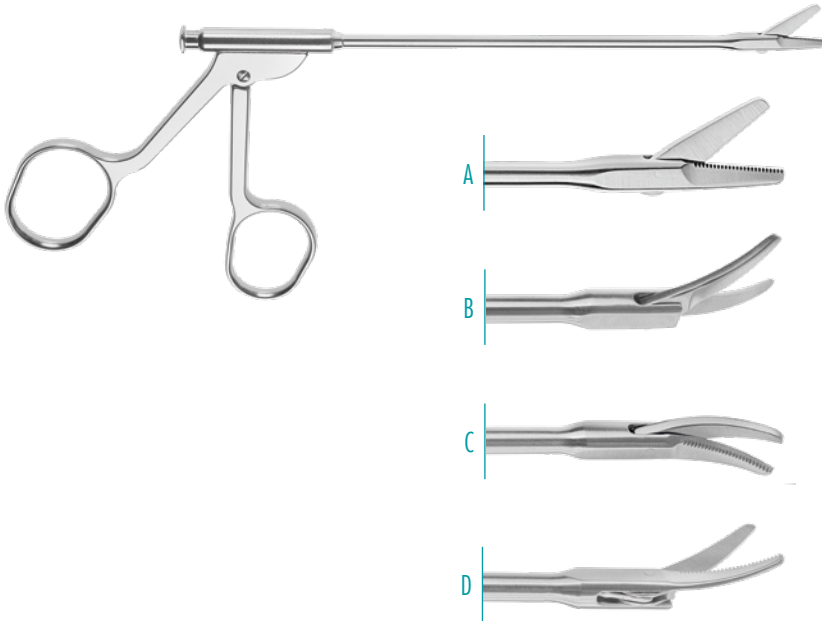

Nasal Scissors, \varnothing 3.5mm
130mm, 5¹/₈"

A straight	252-023-130
B left curved	252-024-130
C right curved	252-025-130
D curved up	252-026-130

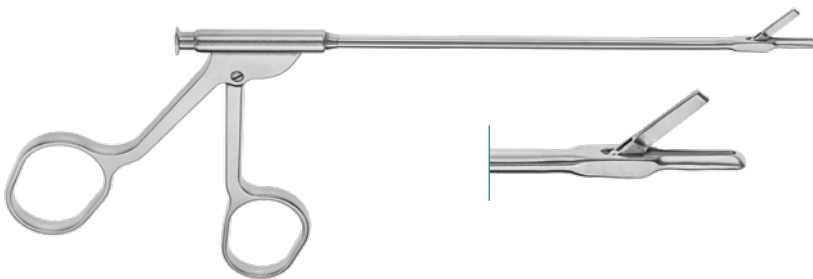

STRUYCKEN
Ethmoidal Forceps

130mm, 5¹/₈" 252-003-130

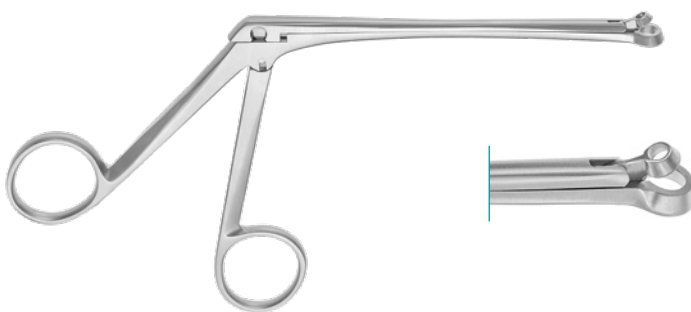

HARTMANN

Nasal Cutting Forceps, through-cutting,
120mm, 4³/₄"

5mm	420-407-005
7mm	420-407-007
9mm	420-407-009
11mm	420-407-011

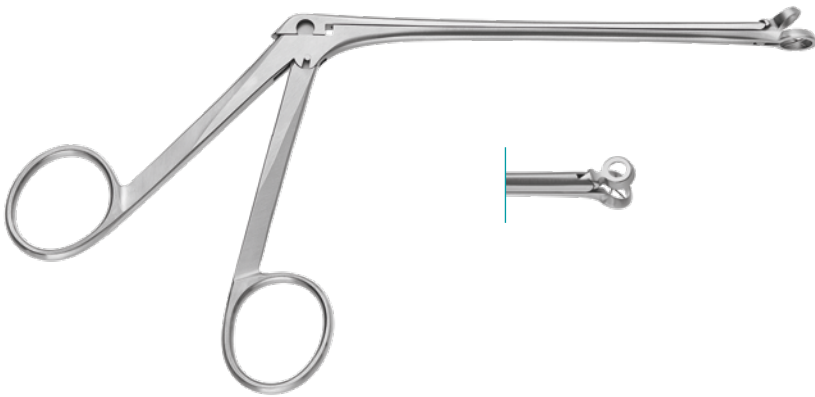
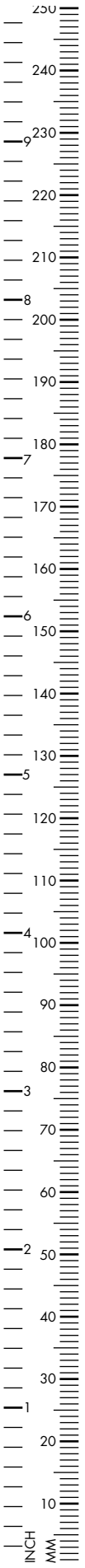

MELZER

Adenoid Punch, through cutting,
round, with basket, 140mm, 5¹/₂"

Fig. 1, 7mm	420-401-001
Fig. 2, 8mm	420-401-002

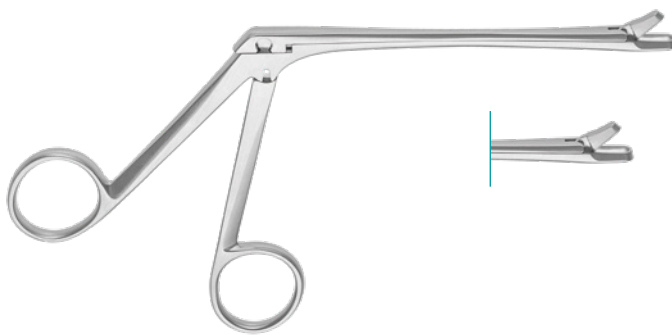

GRUENWALD-HENKE

Nasal Cutting Forceps, through-cutting,
120mm, 4³/₄"

Fig. 1, 3.5 x 11mm	420-405-120
Fig. 2, 2.0 x 9.5mm	420-406-120

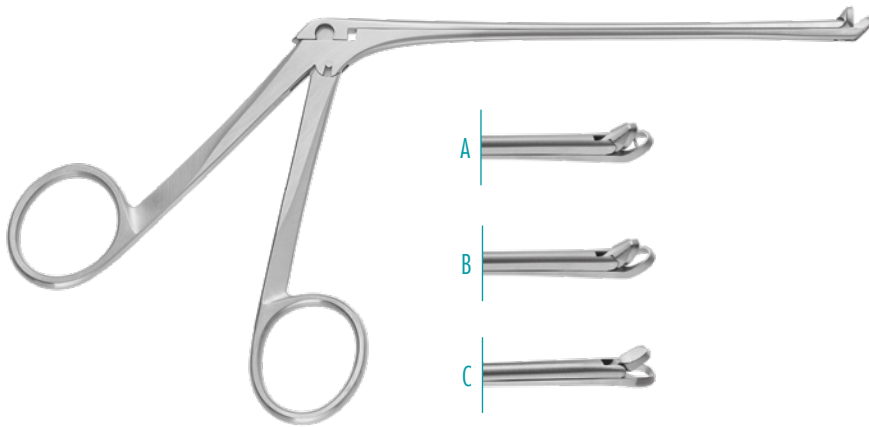
**WATSON-WILLIAMS**

Nasal Forceps, through-cutting, upcurved,
3mm bite, 140mm, 5¹/₂"

A	420-418-140
B	420-419-140
C	420-420-140

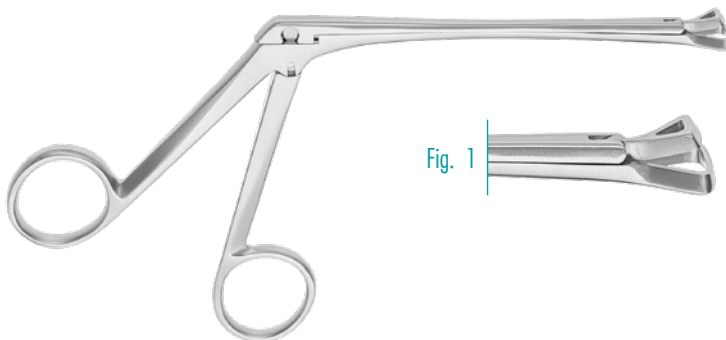
**SCHMEDEN**

Nasal Cutting Forceps, through-cutting,
120mm working length, 190mm, 7¹/₂"

Fig. 1	420-401-190
Fig. 2	420-402-190

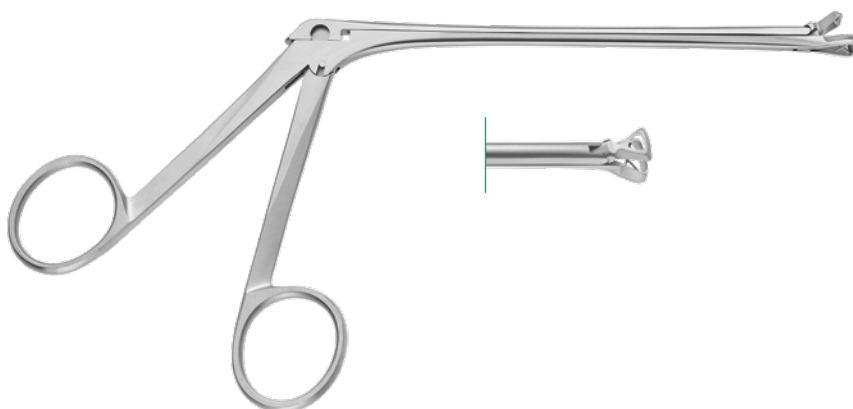
**MELZER**

Adenoid Forceps, through-cutting, triangular,
140mm, 5¹/₂"

Fig. 0, 6mm	420-401-100
Fig. 1, 7mm	420-401-101
Fig. 2, 8mm	420-401-102
Fig. 3, 10mm	420-401-103

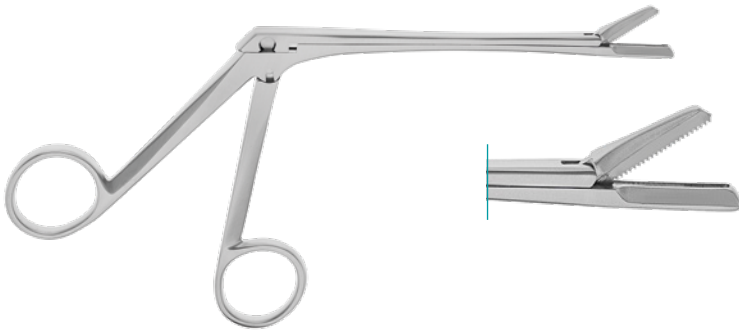
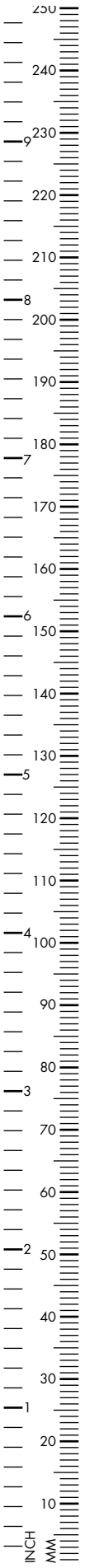

STRUYCKEN

Nasal Cutting Forceps, through-cutting

120mm, 4^{3/4}"

420-409-120

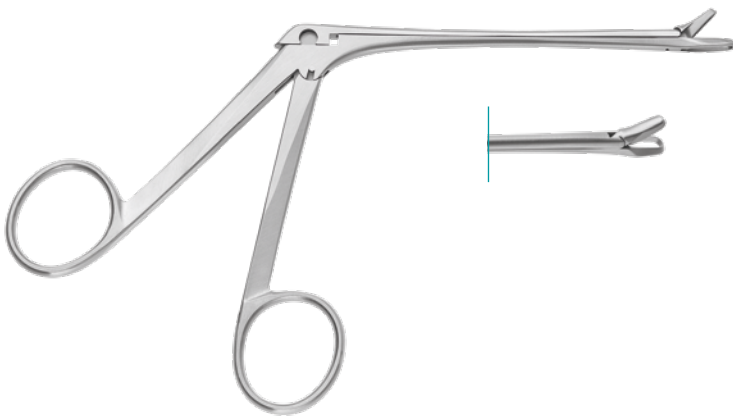

GRUENWALD

Nasal Forceps, oval bite, 115mm, 4^{1/2}"

Fig. 1, 3.0mm

420-421-001

Fig. 2, 3.5mm

420-421-002

Fig. 3, 4.0mm

420-421-003

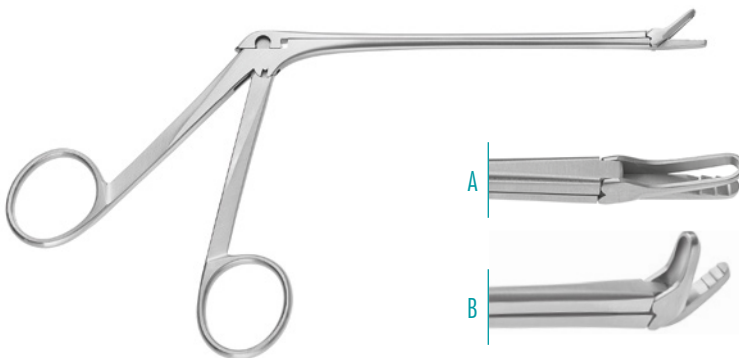

MYLES

Nasal Cutting Forceps, through-cutting,
130mm, 5^{1/8}"

A straight, flat

420-410-140

B 30° upcurved

420-413-140

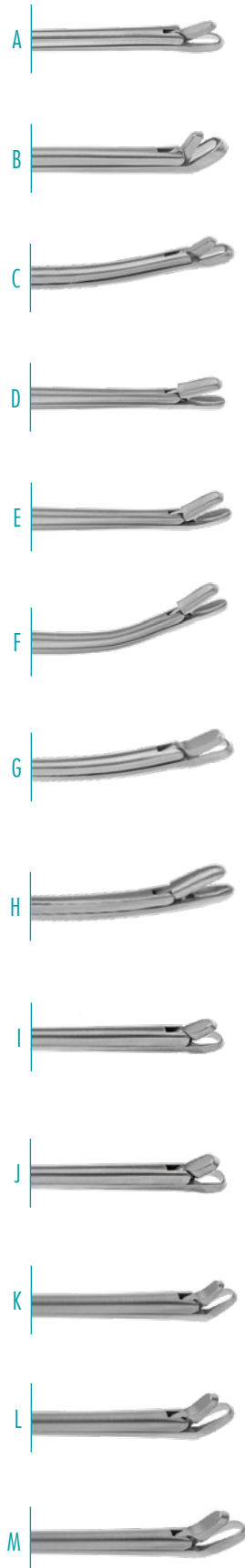
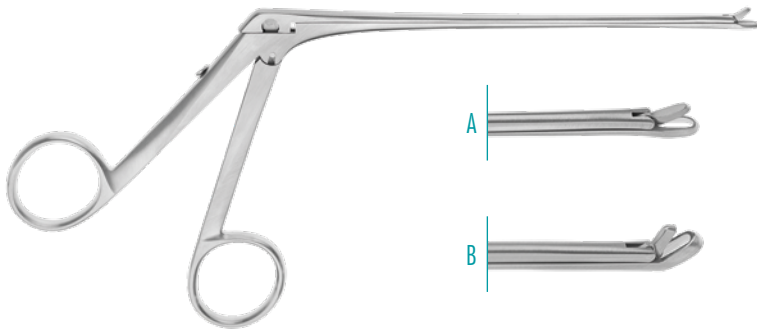
**MORIYAMA**Conchotom, through-cutting, 140mm, 5¹/₂"

A	Size 1, straight, delicate	252-200-001
B	Size 2, upcutting, delicate	252-200-002
C	Size 3, shaft upcurved, delicate	252-200-003
D	Size 4, straight, oval cups, delicate	252-200-004
E	Size 5, upwards, oval cups, delicate	252-200-005
F	Size 6, shaft upcurved, oval cups, delicate	252-200-006
G	Size 8, sheath upcurved	252-200-008
H	Size 9, shaft upwards, oval cups	252-200-009
I	Size 10, straight, small size, 115mm, 4 ¹ / ₂ "	252-200-010
J	Size 11, straight, large size, 115mm, 4 ¹ / ₂ "	252-200-011
K	Size 12, upwards, small size, 115mm, 4 ¹ / ₂ "	252-200-012
L	Size 13, upwards, medium size, 115mm, 4 ¹ / ₂ "	252-200-013
M	Size 14, upwards, large size, 115mm, 4 ¹ / ₂ "	252-200-014

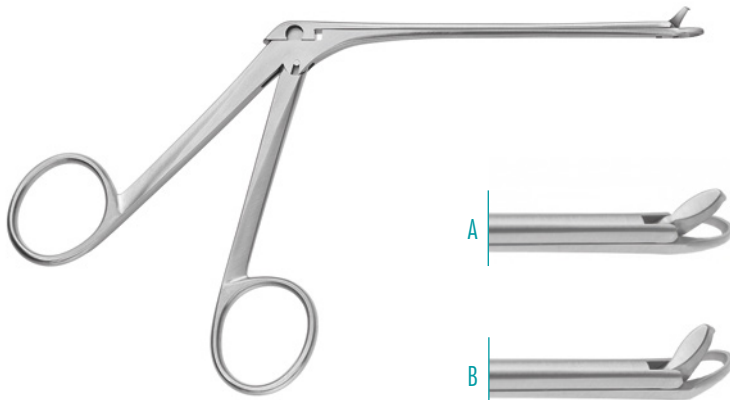
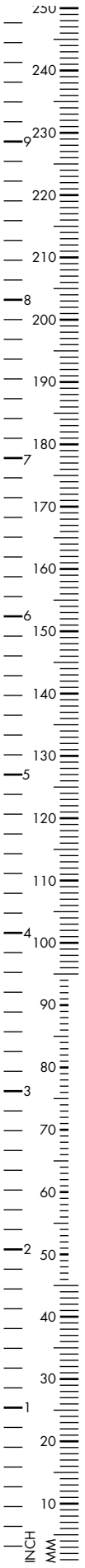

smooth

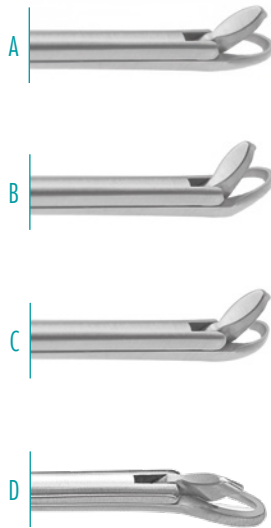

BLAKESLEY

Nasal Forceps, through cutting, smooth, 115mm, 4 1/2"

A straight

2.0mm bite	252-200-110
2.5mm bite	252-200-111
3.0mm bite	252-200-112
3.5mm bite	252-200-113
4.0mm bite	252-200-114
5.0mm bite	252-200-115

B upcurved

2.0mm bite	252-201-110
2.5mm bite	252-201-111
3.0mm bite	252-201-112
3.5mm bite	252-201-113
4.0mm bite	252-201-114
5.0mm bite	252-200-115

C left curved

2.5mm bite	252-202-111
------------	-------------

D right curved

2.5mm bite	252-203-111
------------	-------------

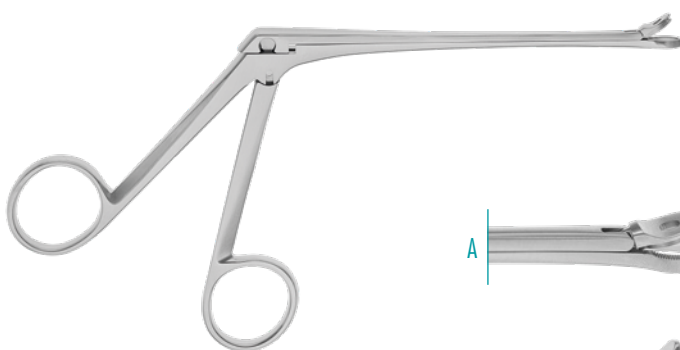

serrated



BLAKESLEY

Nasal Forceps, through cutting, serrated, 115mm, 4 1/2"

A straight

2.0mm bite	252-204-110
2.5mm bite	252-204-111
3.0mm bite	252-204-112
3.5mm bite	252-204-113
4.0mm bite	252-204-114

B upcurved

2.0mm bite	252-205-110
2.5mm bite	252-205-111
3.0mm bite	252-205-112
3.5mm bite	252-205-113
4.0mm bite	252-205-114

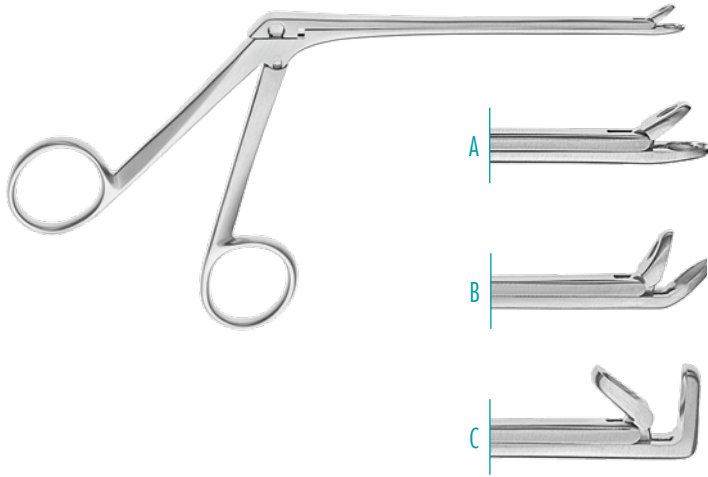

WEIL-BLAKESLEY

Ethmoidal Forceps, oval cup, fenestrated jaws, 120mm, 4"

A straight

Fig. 0, 3.0mm	252-000-120
Fig.1, 3.6mm	252-001-120
Fig.2, 4.2mm	252-002-120
Fig.3, 4.8mm	252-003-120
Fig.4, 5.6mm	252-004-120

B upwards curved

Fig. 0, 3.0mm	252-000-121
Fig.1, 3.6mm	252-001-121
Fig.2, 4.2mm	252-002-121
Fig.3, 4.8mm	252-003-121
Fig.4, 5.6mm	252-004-121

C 90° upwards curved

Fig. 0, 3.0mm	252-000-122
Fig.1, 3.6mm	252-001-122
Fig.2, 4.2mm	252-002-122
Fig.3, 4.8mm	252-003-122
Fig.4, 5.6mm	252-004-122

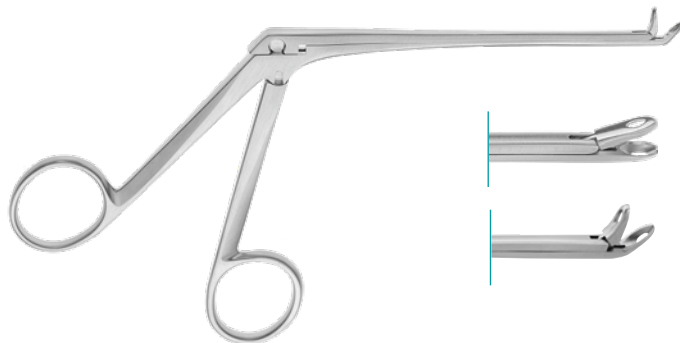

STRUEMPEL-VOSS

Ethmoidal Forceps, Ø2.5mm, 110mm, 4 1/3"

straight	252-144-121
upcurved jaws	252-000-111

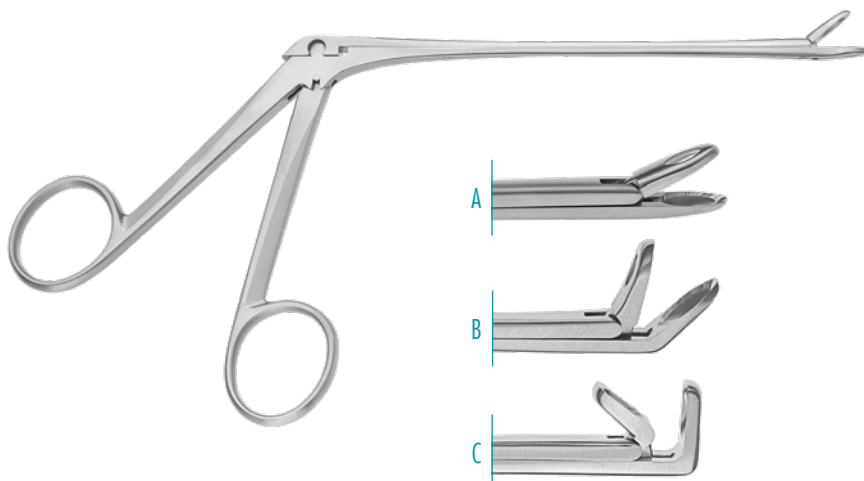

BLAKESLEY

Nasal Forceps, 150mm, 6"

A straight / 0°

Size 1, 3.5mm	252-035-150
Size 2, 4.0mm	252-040-150
Size 3, 5.0mm	252-050-150

B 45° upcurved

Size 1, 3.5mm	252-035-151
Size 2, 4.0mm	252-040-151

C 90° upcurved

Size 1, 3.5mm	252-035-152
Size 2, 4.0mm	252-040-152

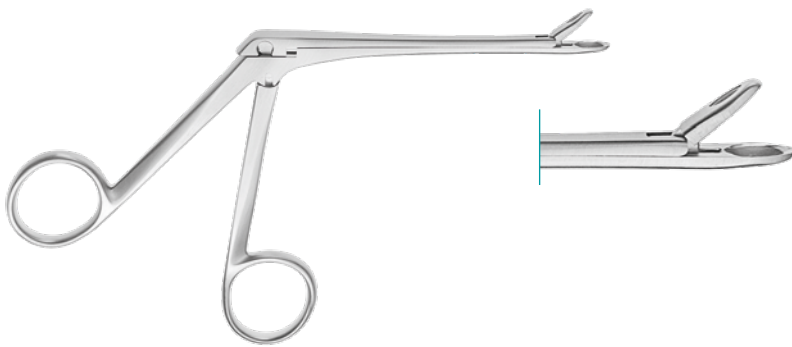
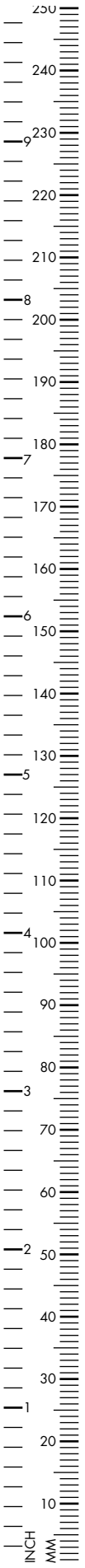

TILLEY HENCKEL

Ethmoid Punch, straight, 100mm, 4¹/₃"

Ø 4.5mm	252-022-045
Ø 5.5mm	252-022-055
Ø 6.5mm	252-022-065

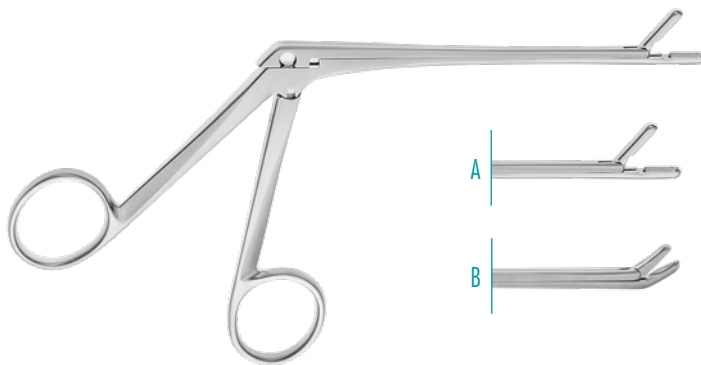

TAKAHASHI

Ethmoidal Forceps, oval, cup-shaped, 110mm, 4¹/₃"

A straight

2.5mm	252-410-130
3.0mm	252-410-131
4.0mm	252-410-132

150mm, 6"

3.0mm	252-410-151
-------	-------------

B upcurved, 110mm, 4¹/₃"

3.0mm	252-413-131
-------	-------------

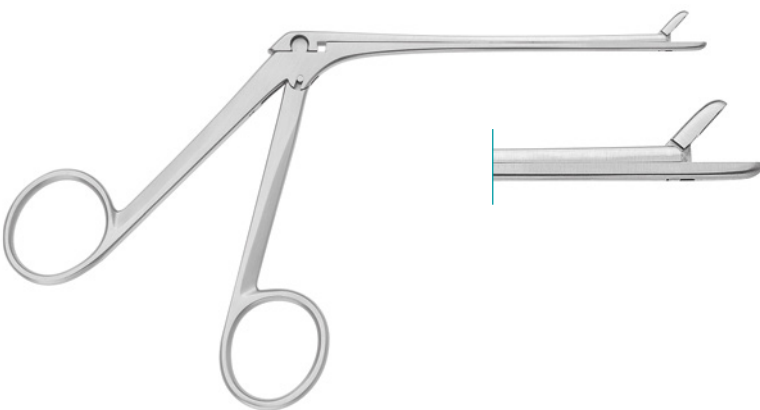

ST BARTS

Rongeur, 3mm, 110mm, 4¹/₃"

straight	252-536-115
curved up	252-537-115
curved down	252-538-115

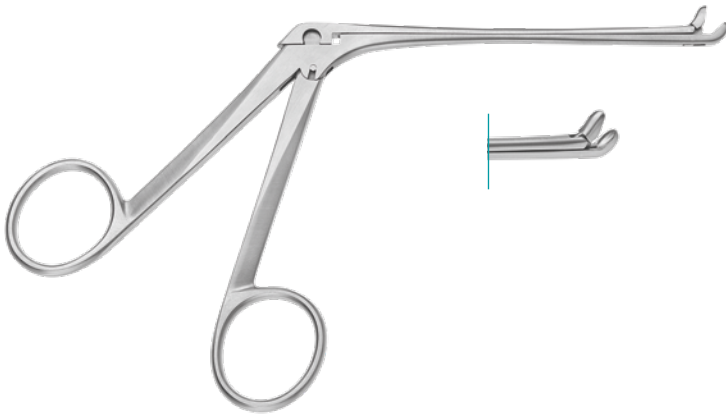
**BEAD**

Nasal Forceps, cup jaws, upturned

115mm, 4¹/₂"

252-425-115

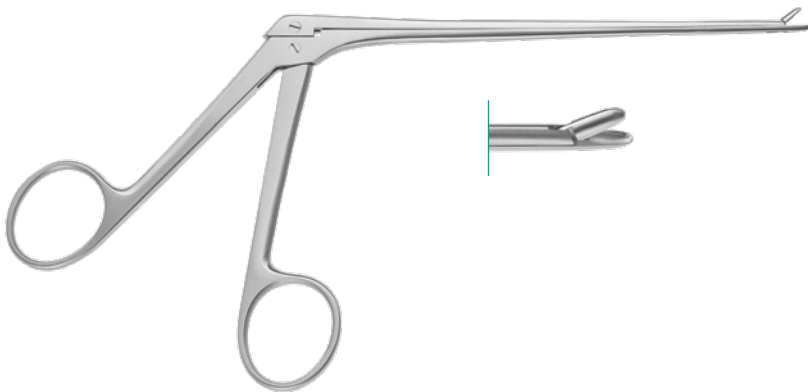

Ethmoidal Forceps, straight

140mm, 5¹/₂"

252-534-100

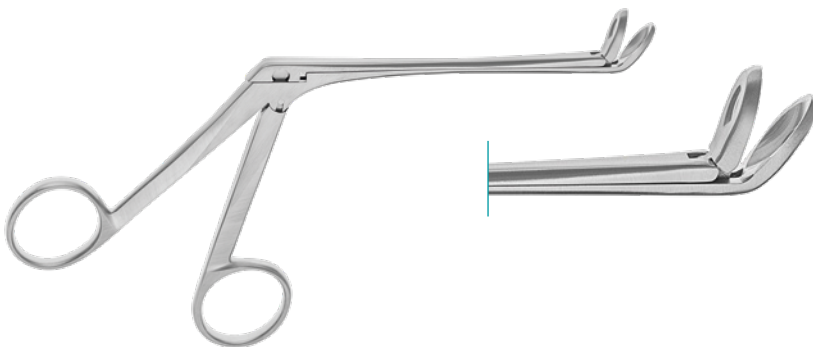
**BLAKESLEY**Conchotom with spoon, 6x14mm,
60° bent up115mm, 4¹/₂"

252-551-204

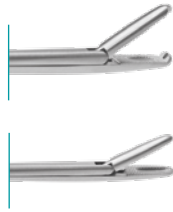
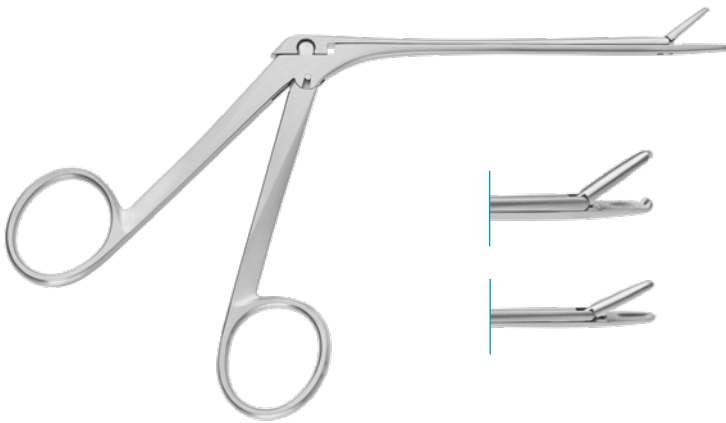
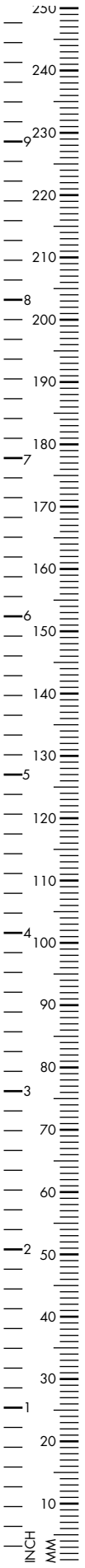

NOYES

Nasal Forceps, serrated jaws

serrated, 1x2 teeth	252-526-115
serrated	252-527-115

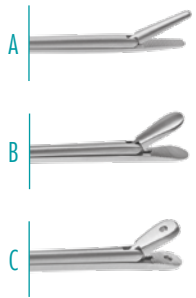
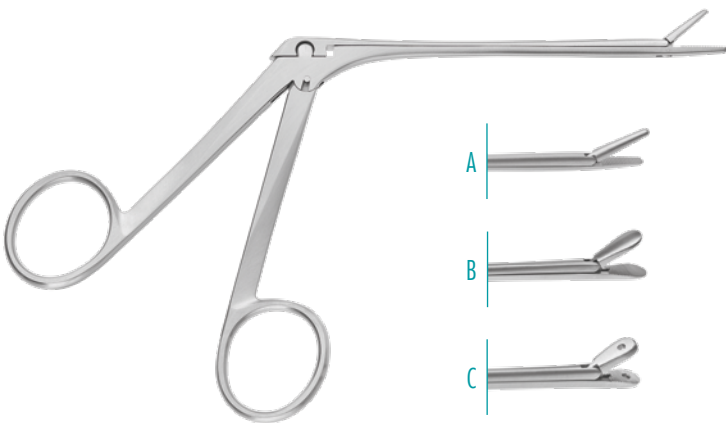

Nasal Forceps, serrated jaws

A MORGENSTEIN	252-528-115
B BLAKESLEY	252-529-115
C FERRIS-SMITH	252-530-115

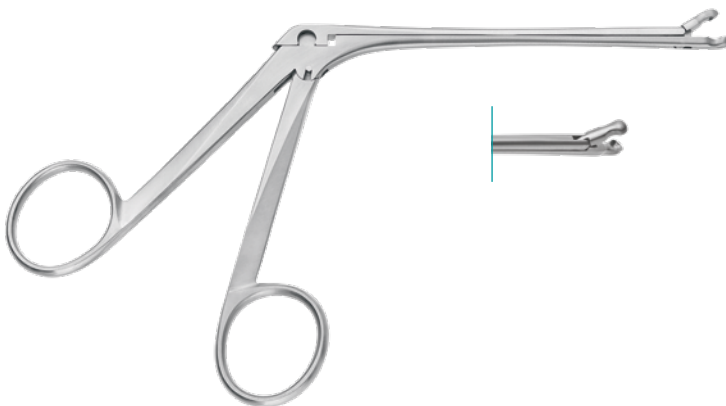

Sinus Cup Forceps, round cups, Ø 3.5mm

115mm, 4 1/2"	252-426-100
---------------	-------------

Zliders - slide to clean

The cleaning of complex surgical instruments requires different processes, compared to conventional reusable instruments. For the most difficult-to-clean instruments cleaning is done manually which makes it time and cost consuming.

The new solution to avoid complex and manual processes is the "one part detachable" instrument.



PRESS



SLIDE



OPEN

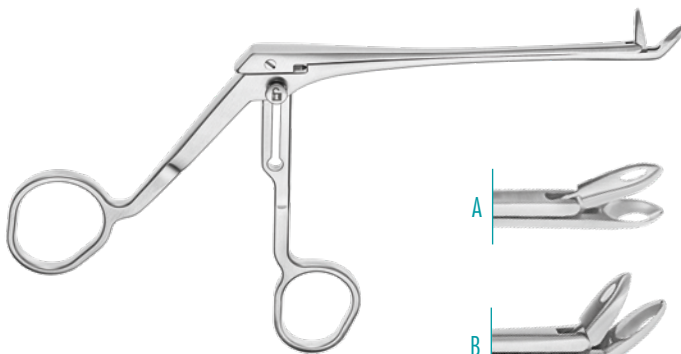

BLAKESLEY

Nasal Forceps, 120mm working length,

A straight

2.5mm	252-725-120
3.0mm	252-730-120
3.5mm	252-735-120
4.0mm	252-740-120
4.5mm	252-745-120

B 45° upwards

3.0mm	252-730-121
3.5mm	252-735-121
4.0mm	252-740-121

C 90° upwards

2.5mm	252-725-122
3.0mm	252-730-122
3.5mm	252-735-122
4.0mm	252-740-122

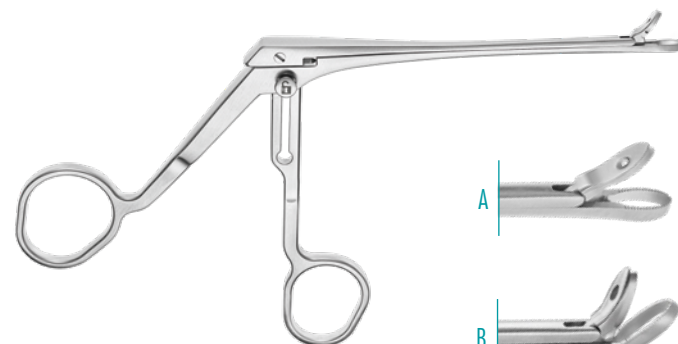

BLAKESLEY

Punch, 120mm working length,

A straight

1.9 x 4.0mm	252-720-120
2.5 x 6.0mm	252-726-120
3.0 x 7.0mm	252-731-120

B 45° upwards

1.9 x 4.0mm	252-721-120
2.5 x 6.0mm	252-727-120
3.0 x 7.0mm	252-732-120

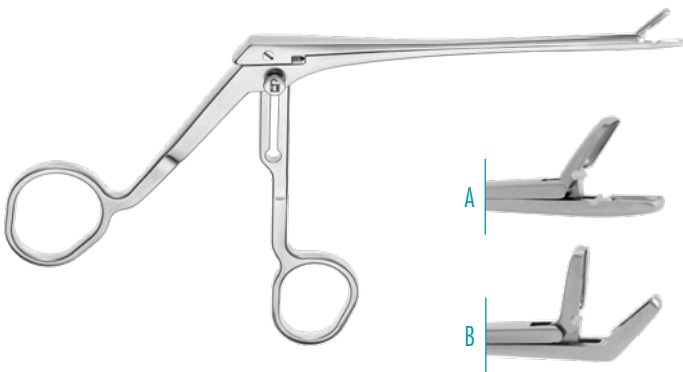
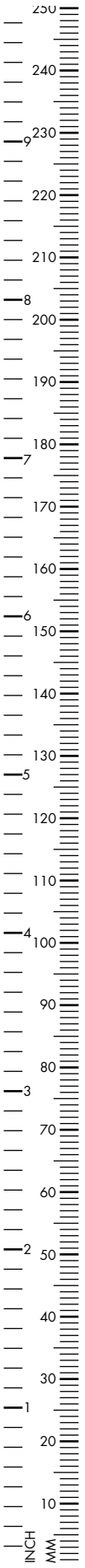

TAKAHASHI

Nasal Forceps, 125mm working length,

A straight

2.0 x 10.0mm	252-741-120
2.5 x 10.0mm	252-742-120
3.0 x 10.0mm	252-743-120
4.0 x 10.0mm	252-744-120

B 45° upwards, 120mm working length

2.0mm	252-741-121
2.5mm	252-742-121
3.0mm	252-743-121
4.0mm	252-744-121

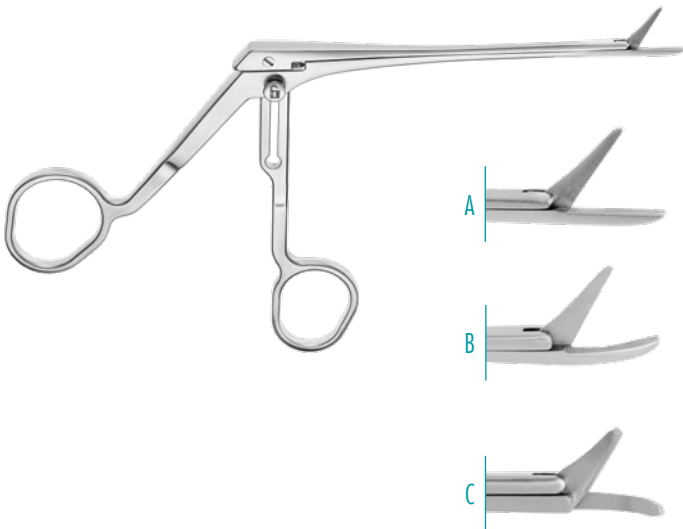

Nasal Scissors, 120mm working length,

A straight

4.0 x 3.0mm x 10.0mm	252-722-120
----------------------	-------------

B right

4.0 x 3.0mm x 10.0mm	252-723-120
----------------------	-------------

C left

4.0 x 3.0mm x 10.0mm	252-724-120
----------------------	-------------

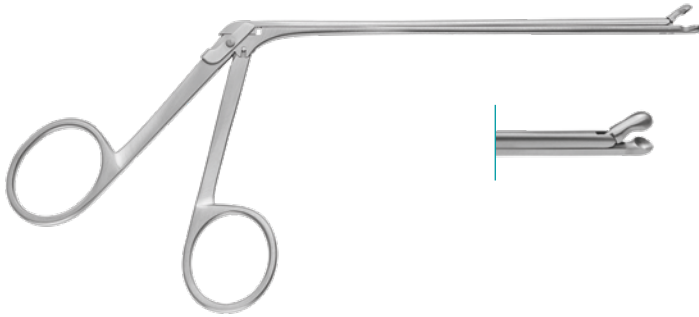
**HILDYARD**

Post-Nasal Forceps, 3.5mm biopsy cup

120mm, 4³/₄"

420-223-170

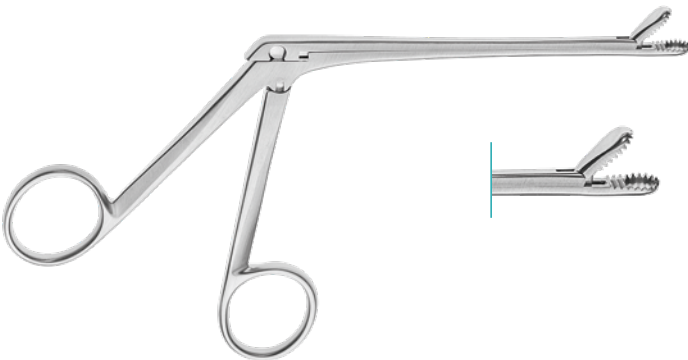
**WATSON-WILLIAMS**Ethmoidal Forceps for mucosa,
straight, serrated120mm, 4³/₄"

252-530-120

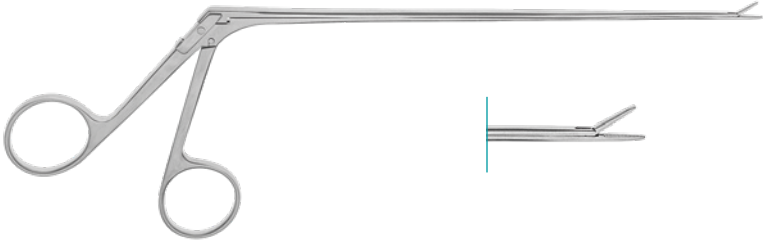
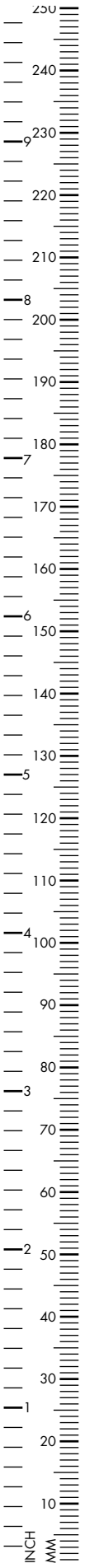

Grasping Forceps, fine serration
 150mm, 6" 252-160-150

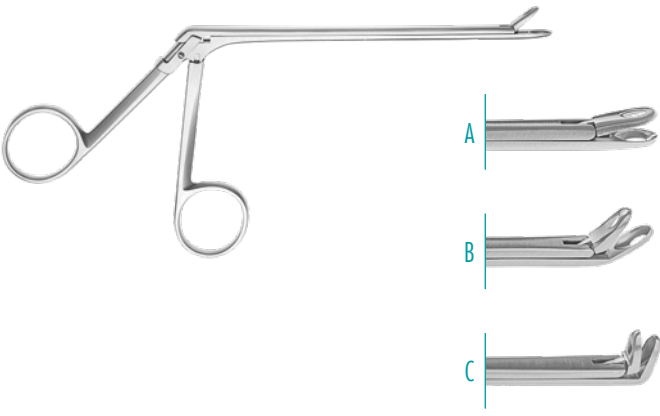

STRUEMPEL
 Nasal Forceps with oval fenestrated
 cupped jaws, 100mm, 4"
 A straight 252-031-120
 B 45° angled up 252-032-120
 C 90° angled up 252-033-120



BELLUCCI
 Scissors, straight
 100mm, 4" 252-034-120

**WATSON-WILLIAMS**Ethmoidal Forceps, 115mm, 4^{1/2}"

Fig. 1, 6.5mm	252-529-120
Fig. 2, 9.5mm	252-531-120

**BRUENINGS**Septum Forceps, fenestrated, 190mm, 7^{1/2}"

Size 1, 6.5mm	252-028-001
Size 2, 7.5mm	252-028-002
Size 3, 9.0mm	252-028-003
Size 4, 10.0mm	252-028-004

**CRAIG**Septum Bone Cutting and Breaking Forceps, sharp cup, 6mm, 165mm, 6^{1/2}"

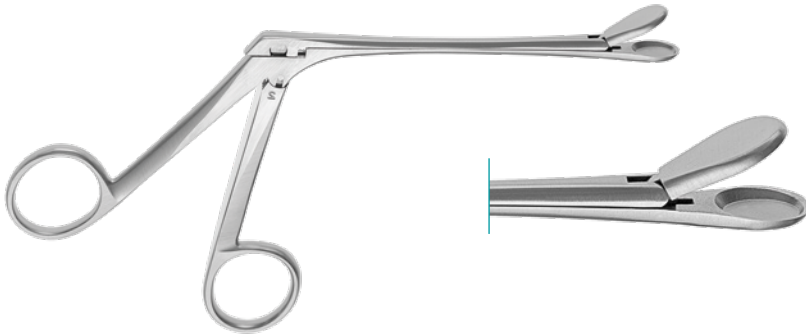
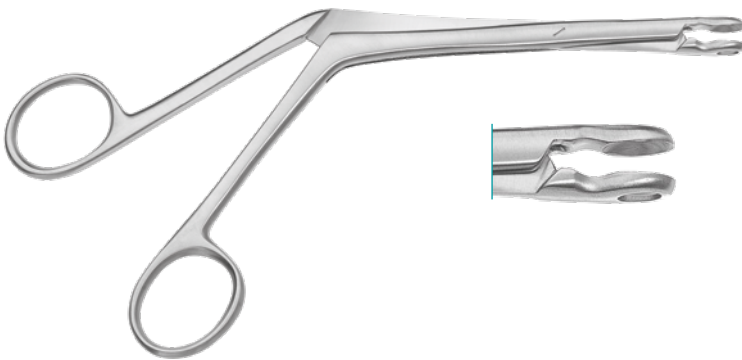
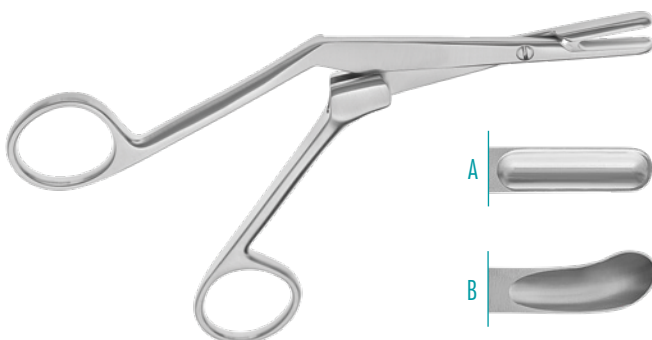
A straight

Oval cup 252-029-000

B curved left

252-029-500

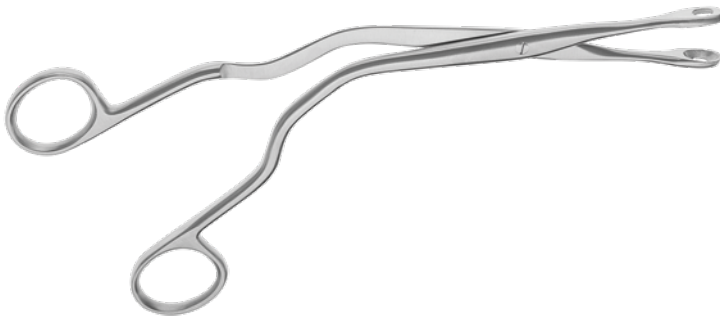
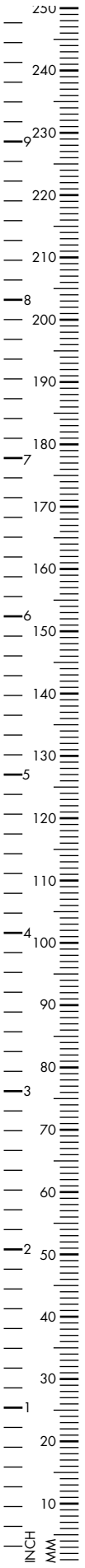

LUC

Septum Forceps with fenestrated jaws
190mm, 7¹/₂"

6.0mm	420-400-001
7.5mm	420-400-002



HEYMANN-KNIGHT

Septum Forceps, sharp oval cup

190mm, 7 ¹ / ₂ "	420-422-190
--	-------------



JANSEN-MIDDLETON

Nasal Forceps, 4x11mm, spoon jaws

170mm, 6 ² / ₃ "	252-032-190
--	-------------



JANSEN-MIDDLETON

Nasal Punch, through cutting, 210mm, 8¹/₄"

4 x 14mm	252-031-190
3 x 13mm	252-033-190

**BECKER**

Septum Scissors, double action, serrated

180mm, 7"

420-213-180

**CAPLAN**

Nasal Scissors, straight blade

220mm, 8^{2/3}"

120-286-220

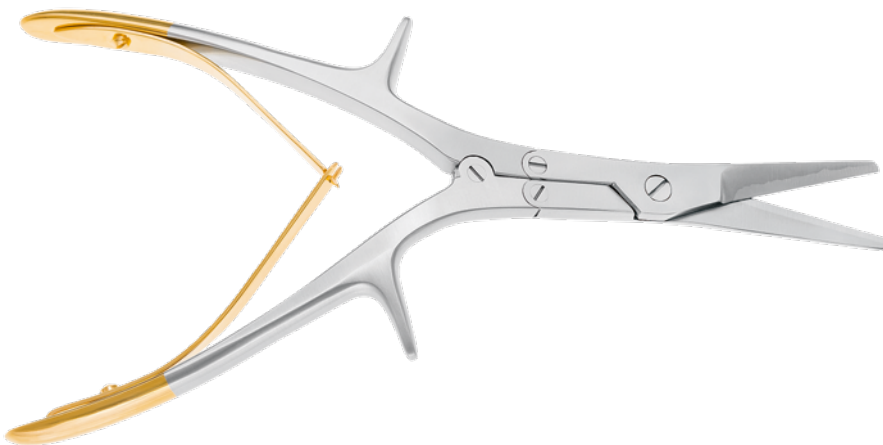
**GORNEY**

Nasal Scissors, straight blade

220mm, 8^{2/3}"

120-588-220

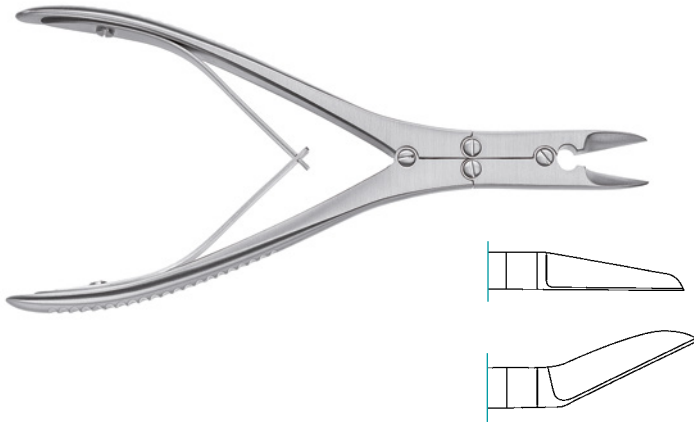
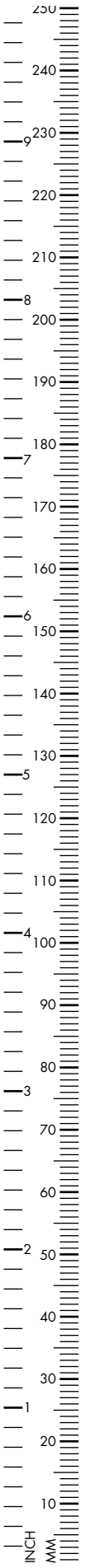

RUSKIN LISTON

Bone Cutting Forceps, double action,
170mm, 6²/₃"

straight	210-844-170
angled	210-843-170



MCINDOE

Bone Cutting Forceps, double action

175mm, 6 ⁷ / ₈ "	210-880-175
--	-------------

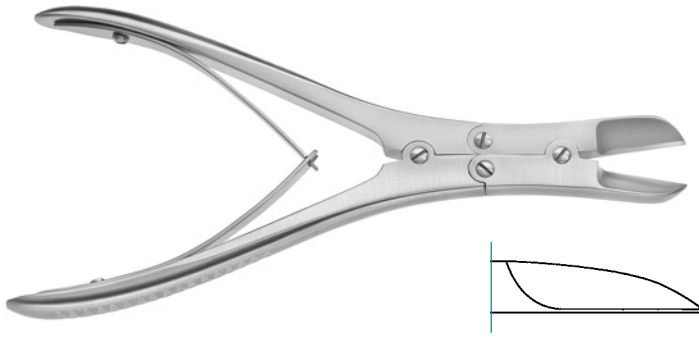

RUSKIN ROWLAND

Bone Cutting Forceps, double action, straight

180mm, 7"	210-855-180
-----------	-------------



GUASTELLA
Lateral Osteotomy Forceps
280mm, 11" 420-370-400



KRESSNER
Crushing Forceps, kee-bent, 220mm, 8²/₃"
3mm 420-408-003
4mm 420-408-004



RUBIN
Septum Morcelizer, double action,
straight
205mm, 8¹/₈" 420-370-210
angled



190mm, 7¹/₂" 420-371-210
Protection Cap 420-370-212



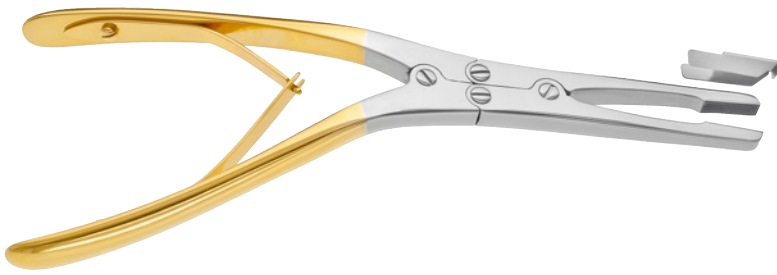
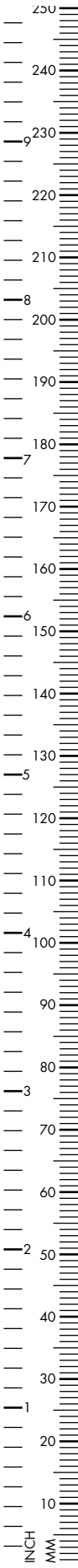

RUBIN
Septum Morselizer, double action, with guard
220mm, 8²/₃"

	420-220-220
Guard only	420-221-200

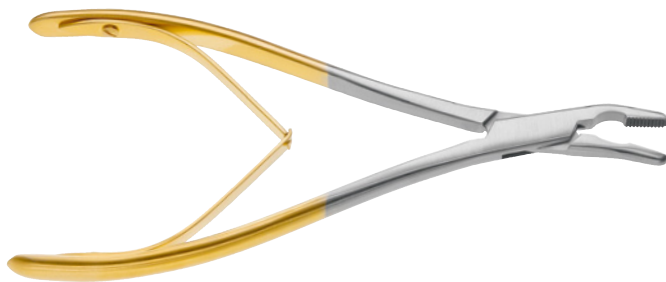

GUNTER
TC Lower Lateral Morselizer
180mm, 7"

	420-220-212
--	-------------



COTTLE-WALSHAM
Septum Forceps, aseptically lock
230mm, 9"

	420-450-230
--	-------------



COTTLE-WALSHAM
Septum Straightening Forceps, 210mm, 8¹/₄"

A right	420-452-230
B left	420-451-230



**ASH**

Septum Straightening Forceps, curved

220mm, 8^{2/3}"

420-455-230

**BOIES**

Elevator for septum repositioning

170mm, 6^{2/3}"

420-557-170

**BOIES**

Nasal fracture elevator, 9mm tip

195mm, 7^{3/4}"

420-555-195

**GOLDMANN**

Septum elevator, round (displacer)

200mm, 8"

420-189-210

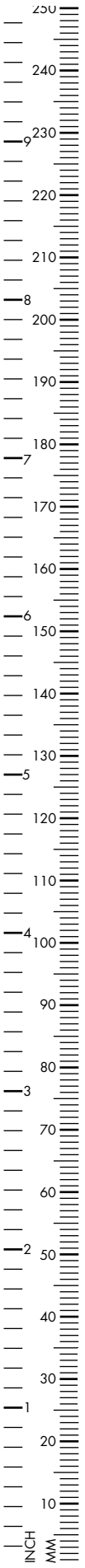

FREER
Mucosa Knife

150mm, 6" 420-195-150



COTTLE
Septum knife, stiff blade with rounded edge

140mm, 5 1/2" 420-213-140



JOSEPH
Button-End Knife, angled

165mm, 6 1/2" 420-209-175



JOSEPH
Nasal Knife, sharp, double-edge,
150mm, 6"

straight 420-190-003

curved 420-191-003



MASING
Cartilage Slitting Knife, curved blade, sharp

130mm, 5 1/8" 420-552-130



Skin Hook	
150mm, 6"	170-011-150



GRAEFF	
Micro Skin Hook, 125mm, 5"	
sharp	170-010-125



KILNER	
Skin Hook, sharp	
150mm, 6"	230-203-150



GILLIES	
Skin Hook, 180mm, 7"	
A small	230-205-180
B medium	230-207-180
C large	230-209-180

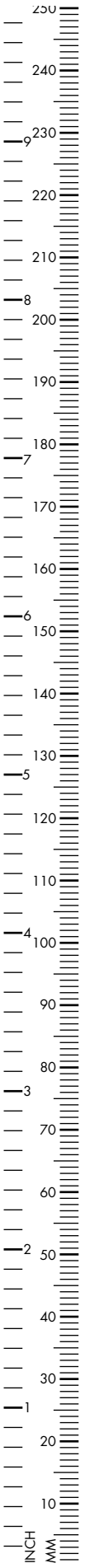

COTTLE

Nerve Hook, 168mm, 6²/₃"

180° retrograde curved 230-286-160

120° retrograde curved 230-285-160



FISCH

Hook, 90°, sharp, angled

185mm, 7¹/₄" 250-064-376

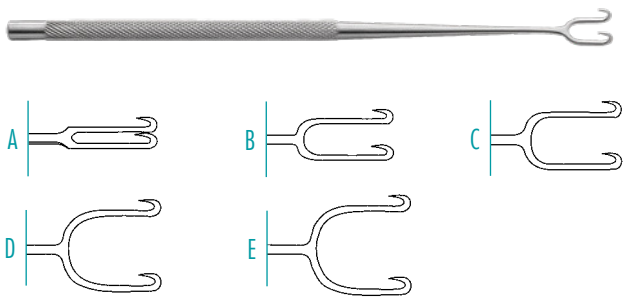

JOSEPH

Skin Hook, 2 prongs, 160mm, 6¹/₄"

A 2mm wide 170-014-002

B 5mm wide 170-014-005

C 7mm wide 170-014-007

D 10mm wide 170-014-010

E 12mm wide 170-014-012



Thumb Retractor, sharp, double hook, 8mm wide
 38mm working length 170-008-381



FREER
 Skin hook, 2 prongs, sharp
 150mm, 6" 230-220-001



COTTLE
 Nasal Retractor, 10mm wide
 130mm, 5 1/8" 420-187-130

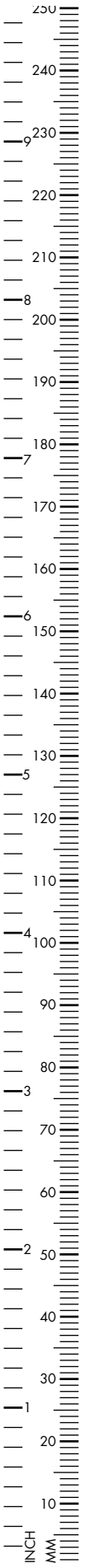

FOMON

Alar Retractor, 2 buttoned prongs

160mm, 6^{1/4}" 230-280-160



FOMON

Alar Retractor, 2 buttoned prongs, insulated end

160mm, 6^{1/4}" 230-780-160



COTTLE

Alar Retractor, 2 prongs, 140mm, 5^{1/2}"
blunt/sharp

buttoned right 230-281-140

sharp/blunt

buttoned left 230-282-140

sharp/sharp

230-283-140



MASING

Alar Retractor, 6 x 12mm,
140mm, 5^{1/2}"

420-520-140



insulated 420-520-141



COTTLE

Alar Retractor, 10 x 12mm,
140mm, 5^{1/2}"

420-523-140

insulated 420-523-141

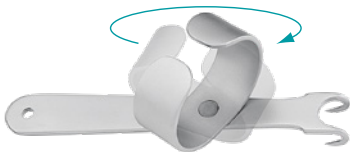
**RZ-NOSE**

RZ Nasal Retractor with Thimble Hook,
swivelling

85mm, 3 ¹ / ₃ "	260-200-110
---------------------------------------	-------------

**KILNER**

Alar Retractor, 2 prongs, 10mm wide,
85mm, 3¹/₄"

sharp	420-184-100
-------	-------------

blunt	420-185-100
-------	-------------

**KILNER**

Alar Retractor, 2 sharp prongs, 13mm wide

85mm, 3 ¹ / ₄ "	420-184-130
---------------------------------------	-------------

**RUBIN**

Hook, 7 x 5.5mm

sharp	420-187-155
-------	-------------

blunt	420-187-255
-------	-------------

**CONVERSE**

Alar Retractor, double-ended, 120mm, 4³/₄"

sharp	260-502-120
-------	-------------

blunt	260-501-120
-------	-------------

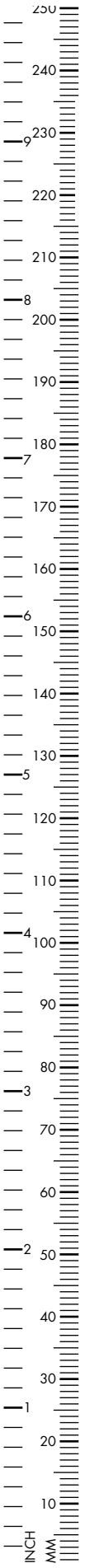

HARALD

Retractor, double-ended

420-186-140



KILNER

Double Hook

420-186-100



COTTLE-NEIVERT

Alar Retractor, saw and knife guide, 2 prongs, blunt

200mm, 8"

230-260-200



NEIVERT

Nasal Retractor, double-ended, with knife guide

160mm, 6 1/4"

170-036-180



NEIVERT-RETTINGER

Nasal Hook

13mm

170-036-183

17mm

170-036-187

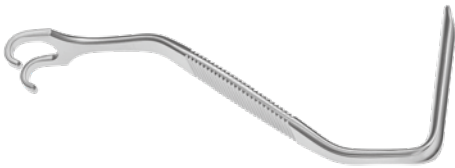
**WALTER**

Nasal Hook, 2 blunt prongs and blunt blade

135mm, 5¹/₃" 420-256-135**AUFRICHT**

Double-Ended Nasal Retractor, blunt

5mm / 42 x 7mm 420-260-005

8mm / 38 x 7mm 420-260-008

13mm / 38 x 7mm 420-260-013

13mm / 42 x 10mm 420-260-113

**MALINIAC**

Nasal Retractor, 9 x 45mm

100mm, 4" 420-652-100

with fiber optic light carrier

100mm, 4" 420-752-100

**CONVERSE**

Nasal Retractor, 11x44mm

110mm, 4¹/₃" 420-235-110

with fiber optic light carrier

100mm, 4" 420-236-110

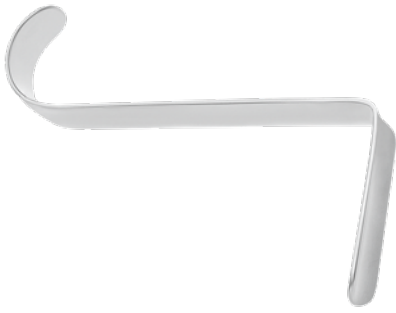
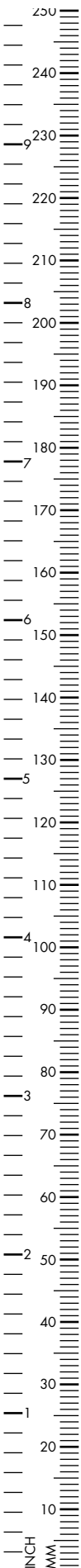
**CONVERSE**Nasal Retractor, 90mm, 3¹/₂"

10x20mm	420-237-095
12x30mm	420-238-095
12x40mm	420-239-090
12x50mm	420-239-095

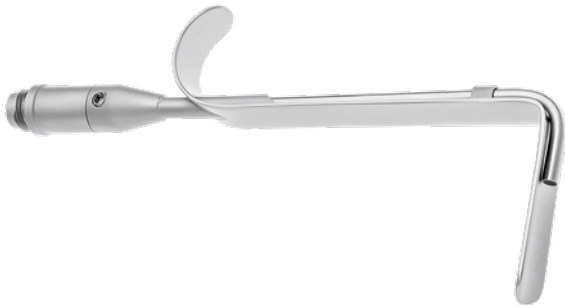
**CONVERSE**Nasal Retractor with fibre-optic light carrier, 90mm, 3¹/₂"

10x20mm	420-237-195
12x30mm	420-238-195
12x40mm	420-239-190
12x50mm	420-239-195

**AUFRICT**Nasal Retractor, 160mm, 6¹/₄"

10 x 45mm	420-250-160
-----------	-------------

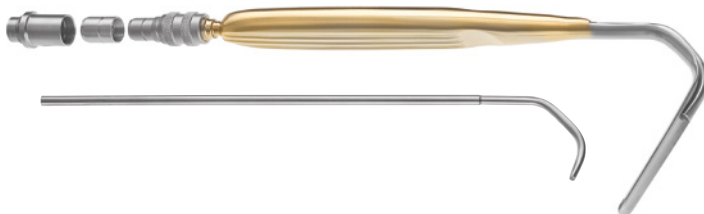
**AUFRICT**

Nasal Retractor, with detachable fiber optic, 120°, 45mm blade

180mm, 7"	420-255-160
-----------	-------------



Dissector / Probe, double ended,
pointed tip / round cutting tip, 8mm

130mm, 5¹/₈" 420-546-130

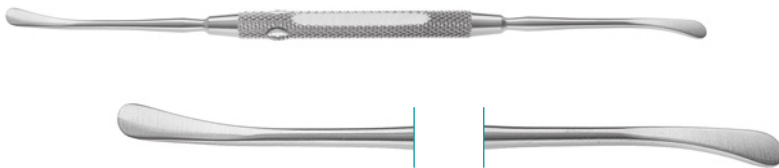

FREER

Septum Elevator, sharp/blunt, 5mm

185mm, 7¹/₄" 420-546-180

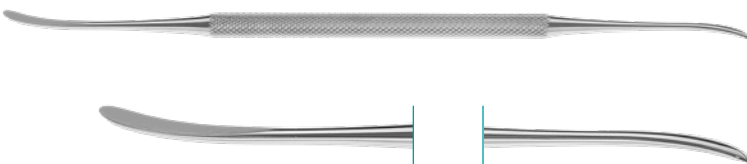

DANIEL

Elevator

420-546-200

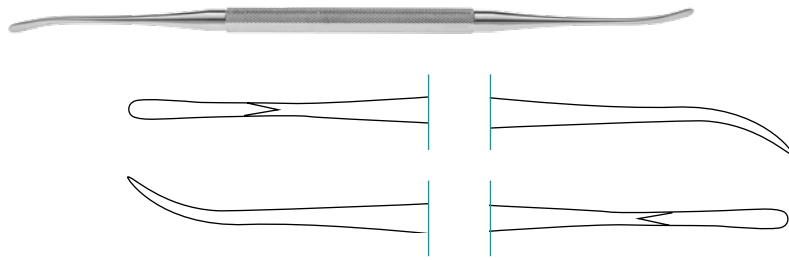
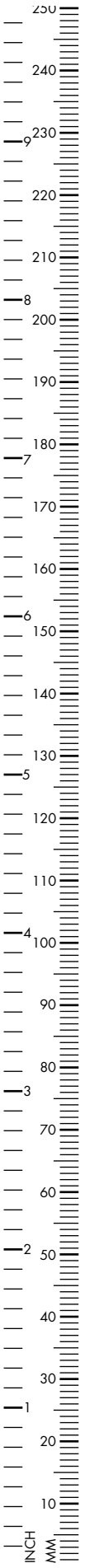

FREER-YASARGIL

Dissector, sharp

190mm, 7¹/₂"

420-548-180



FREER

Septum Elevator, double-ended,
semi-blunt/blunt

200mm, 8"

252-001-200



KLEINERT-KUTZ

Elevator and Dissector, double-ended,
blade A: 4.5mm / blade b: 3.0mm

180mm, 7"

420-554-178

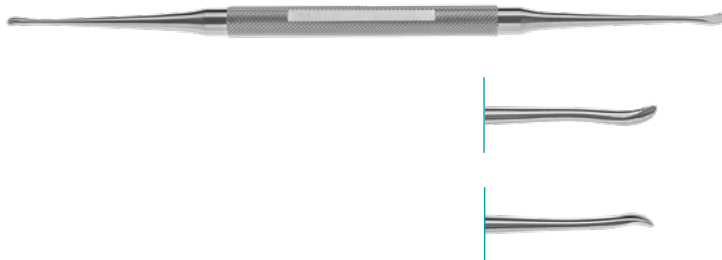

KLEINERT-KUTZ

Elevator and Dissector, double-ended,
blade A: 2.5mm / blade b: 3.0mm

190mm, 7¹/₂"

420-554-190

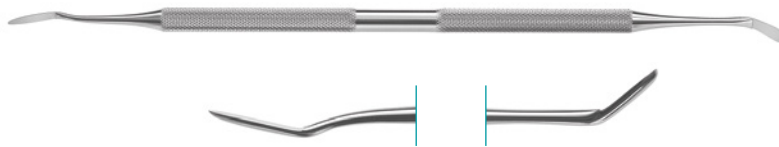
**FREER-LONG**Septum Elevator, double-ended,
sharp/sharp220mm, 8^{2/3}" 252-001-220**WOODSON**

Elevator, 2.4 / 4.0mm blade

200mm, 8" 420-556-200

**FREER-JOSEPH**

Septum Elevator, double-ended

200mm, 8" 420-555-200

**OBWEGESER-FREER**

Septum Elevator, double-ended

200mm, 8" 420-532-200

**HOWARTH**

Elevator, double-ended, sharp/blunt

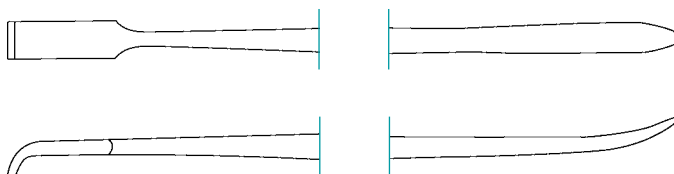
215mm, 8^{1/2}" 420-552-215

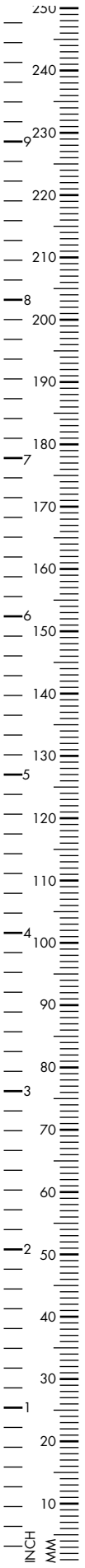

HARALDSSON

Suction Elevator

190mm, 7¹/₂"

420-390-190



RZ

Nasal Suction Dissector, Luer Lock,
Ø 8mm, 190mm, 7¹/₂"

sharp

420-310-190

blunt

420-311-190



NEGUS

Suction Dissector, blunt, 6mm

210mm, 8¹/₄"

420-395-205



GORNEY

Suction Raspatory, semi-sharp, 3mm

180mm, 7"

420-253-185

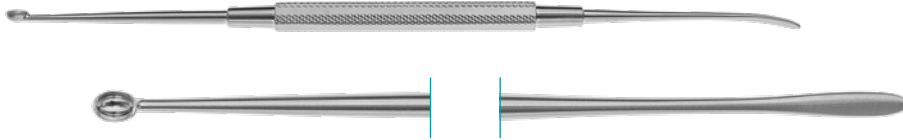

CARTER

Septum Elevator, double-ended

210mm, 8¹/₄" 420-551-210

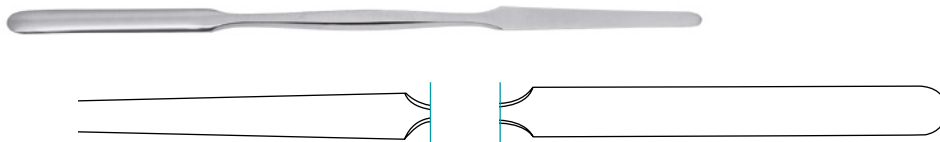

KILLIAN

Elevator, double-ended, sharp/blunt

185mm, 7¹/₄" 420-541-180

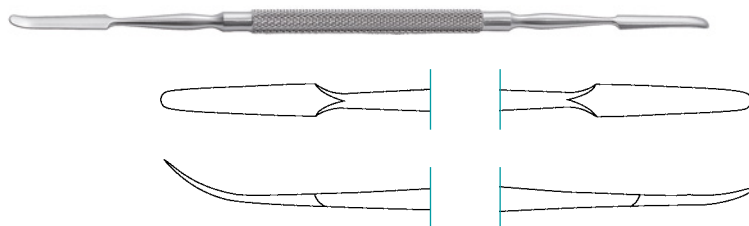

KILLIAN

Raspatory, 6mm, sharp/blunt

180mm, 7" 420-540-180



KILLIAN

Septum double-ended elevator,
shuffle-shaped, sharp/blunt

180mm, 7" 252-002-180

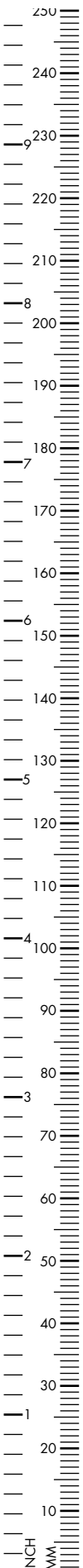
**MASING**

Elevator, double-ended, graduated, sharp/blunt

200mm, 8"

420-551-200

**COTTLE**

Perisosteal Elevator, double ended, graduated

220mm, 8²/₃"

420-553-220

**JOSEPH**Masing Septum Elevator, bayonet shaped,
slightly curved210mm, 8¹/₄"

420-550-210

**COTTLE**Elevator, double-ended, graduated,
sharp/sharp

230mm, 9"

420-550-230

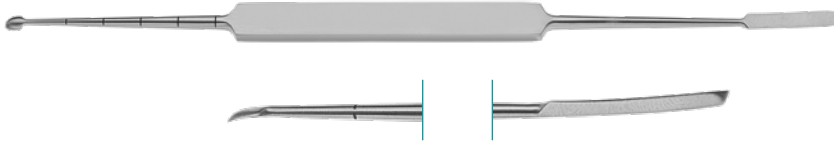
**COTTLE-JOSEPH**

Double Elevator

225mm, 8^{7/8}"

420-550-225

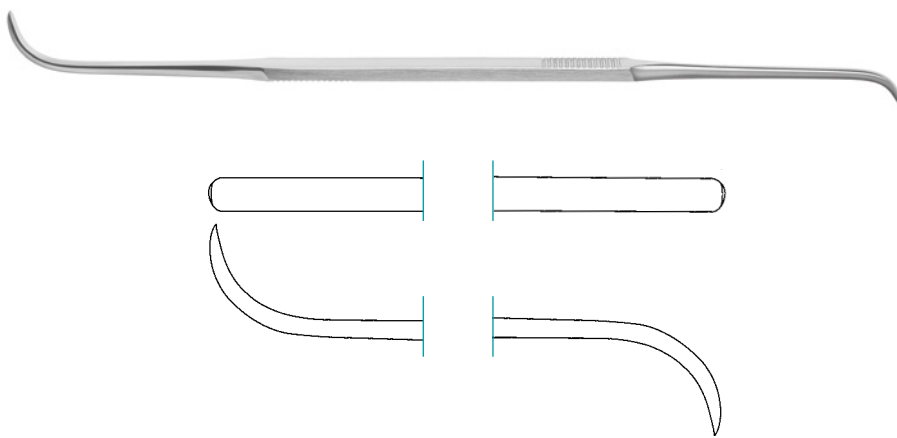
**COTTLE**

Elevator, double-ended, for tunneling

220mm, 8"

420-552-200

**PENNINGTON**

Elevator

210mm, 8^{1/4}"

420-543-210

**FREER**

Periosteal Elevator, double-ended, sharp

175mm, 6^{7/8}"

420-551-175

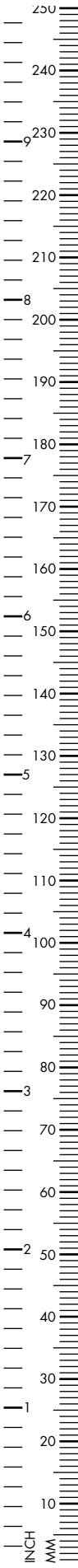

MCKENTY

Septum and Periosteal Elevator

220mm, 8²/₃"

420-539-220



MCKENTY

Raspatory, 150mm, 6"

4mm

420-547-004

5mm

420-547-005



JOSEPH

Periosteal elevator, slightly curved,

170mm, 6²/₃"

2mm

420-530-165

3mm

420-531-165

4mm

420-532-165

5mm

420-533-165

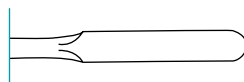

Raspatory, 170mm, 6²/₃"

6mm 210-439-006

8mm 210-439-008

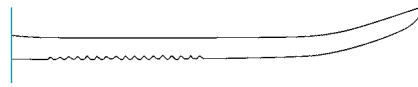
**PLESTER**

Raspatory, 8mm wide

180mm, 7" 410-336-180

**ERLANGEN**

Raspatory, 6mm wide, slightly curved

175mm, 6⁷/₈" 420-547-006**HALLE**

Raspatory, 4mm, blunt, slightly curved

180mm, 7" 420-544-165

**FREER**

Periosteal Elevator, 4mm

160mm, 6¹/₄" 420-551-180

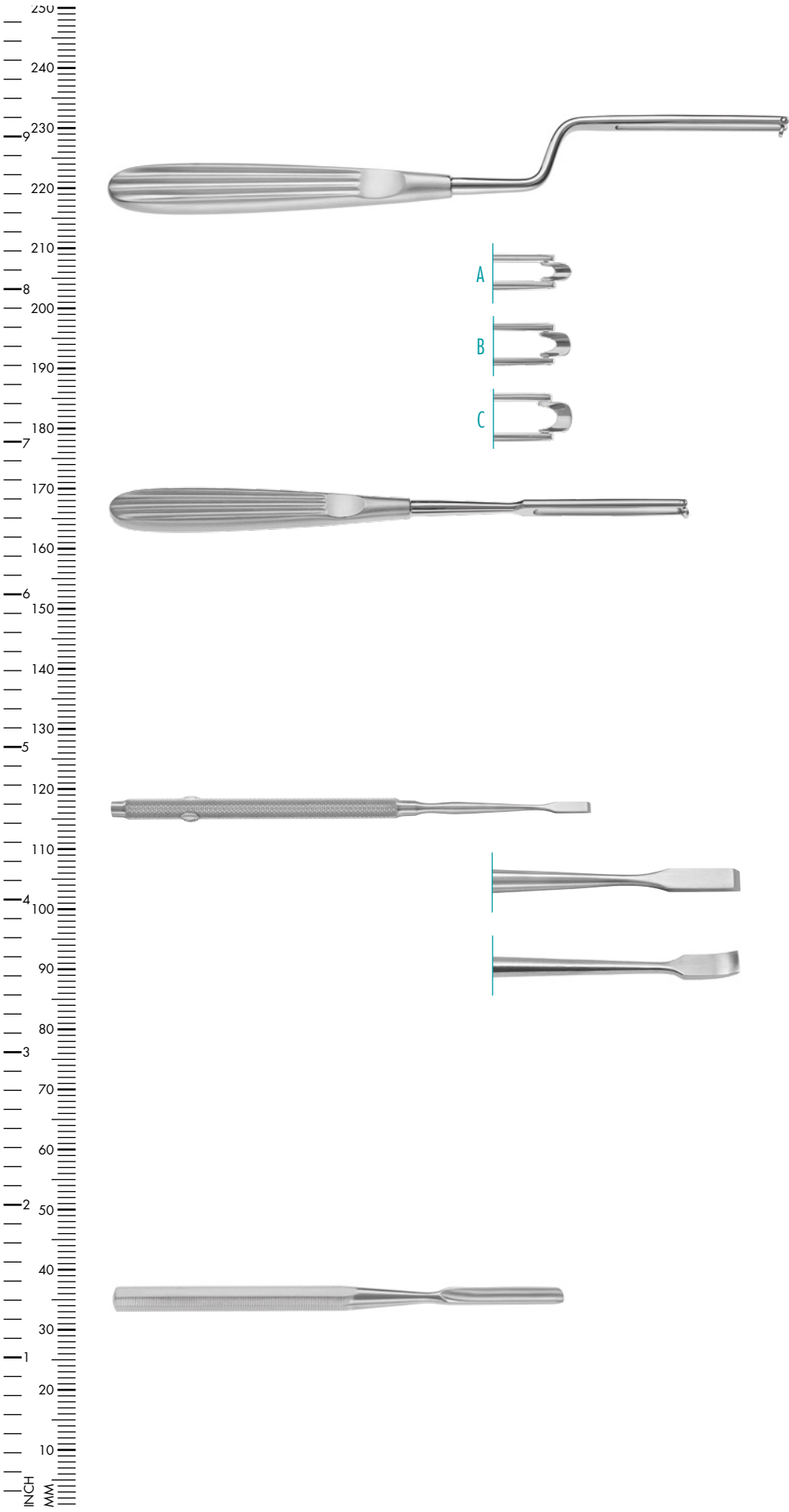

BALLENGER

Swivel knife, bayonet shaped, 210mm, 8¹/₄"

A 3mm	420-392-003
B 4mm	420-392-004
C 5mm	420-392-005

straight, 195mm, 7²/₃"

A 3mm	420-393-003
B 4mm	420-393-004
C 5mm	420-393-005

FREER

Septum Chisel, 4mm, 160mm, 6¹/₄"

straight	420-590-004
curved	420-591-004

FREER

Septum Gouge, straight, round cutting, 6mm

150mm, 6"	420-550-170
-----------	-------------

**BALLENGER**

Septum Gouge, with notch and cutting edge,
6mm

155mm, 6^{1/8}" 420-595-170

**KILLIAN**

Septum Gouge, round cutting edge,
bayonet shaped, 6mm

170mm, 6^{2/3}" 420-552-170

**KILLIAN-CLAUS**

Septum Gouge with notch, bayonet shaped,
6mm

170mm, 6^{2/3}" 420-551-170

**COTTLE**

Chisel, graduated, 185mm, 7^{1/4}"

3mm 210-488-003

4mm 210-488-004

6mm 210-488-006

7mm 210-488-007

9mm 210-488-009

12mm 210-488-012

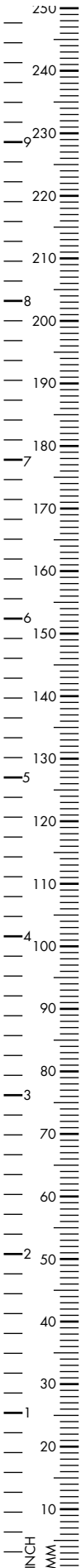

COTTLE

Chisel, curved, graduated, 6mm

180mm, 7" 210-486-006



COTTLE

Chisel, 4mm

180mm, 7" 210-475-004



COTTLE

Osteotome with depth marking, 180mm, 7"

4mm 210-487-004

7mm 210-487-007

8mm 210-487-008

10mm 210-487-010

12mm 210-487-012



COTTLE

185mm, 7 1/4"

4mm 210-472-004

6mm 210-472-006

7mm 210-472-007

9mm 210-472-009

12mm 210-472-012

**COTTLE**

Fishtail Osteotome, protecting ends,
double guarded, 8mm

180mm, 7" 210-486-008

**COTTLE**

Osteotome with guard and crossbar, 5mm

185mm, 7^{1/4}" 210-472-105

**COTTLE**

Fishtail osteotome, with crossbar,
with round cutting end, 16mm

180mm, 7" 210-486-016

**COTTLE-CINELLI**

Chisel, 185mm, 7^{1/4}"

10mm 210-474-010

12mm 210-474-012

14mm 210-474-014

16mm 210-474-016

**CINELLI**

Osteotome, double guarded, straight
160mm, 6^{1/4}"

8mm	420-589-008
10mm	420-589-010
12mm	420-589-012
14mm	420-589-014
16mm	420-589-016

**RUBIN**

Osteotome, 167mm, 6^{2/3}"

8mm	420-587-008
10mm	420-587-010
12mm	420-587-012
14mm	420-587-014
16mm	420-587-016

**FANOUS-GUBISCH**

Osteotome, straight, 4mm wide, with guard,
200mm, 8"

straight	420-640-001
right curved	420-640-002
left curved	420-640-003

**ANDERSON-NEIVERT**

Osteotome, 3.5mm, 205mm, 8^{1/8}"

straight	420-639-001
curved right	420-639-002
curved left	420-639-003

**SILVER**Osteotome, slender model, 185mm, 7¹/₄"

straight	420-460-001
left	420-460-002
right	420-460-003

**SILVER**

Osteotome, with guard, straight, 180mm, 7"

straight	420-459-001
left curved	420-459-002
right curved	420-459-003

**MASING**

Osteotome, with guard, 180mm, 7"

straight	420-459-101
right curved	420-459-102
left curved	420-459-103

**FRENCHAY**

Nasal Chisel with guard 180mm, 7"

curved left	420-491-001
curved right	420-491-002
straight	420-491-000

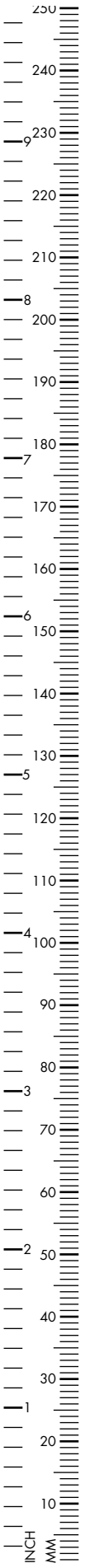

GUASTELLA

Osteotome, 180mm, 7"

left	420-472-002
right	420-472-003



MCINDOE

Osteotome, hard edge, mushroom head, 150mm, 6"

9mm	420-487-009
11mm	420-487-011
13mm	420-487-013
15mm	420-487-015



WALTER

Chisel with notch, double guarded, 190mm, 7 1/2"

3.0mm	420-582-003
4.5mm	420-582-045



WALTER

Osteotome, 190mm, 7 1/2"

A 2mm	420-580-002
B 3mm	420-580-003
C 4mm	420-580-004
D 7mm	420-580-007
E 9mm	420-580-009
F 12mm	420-580-012

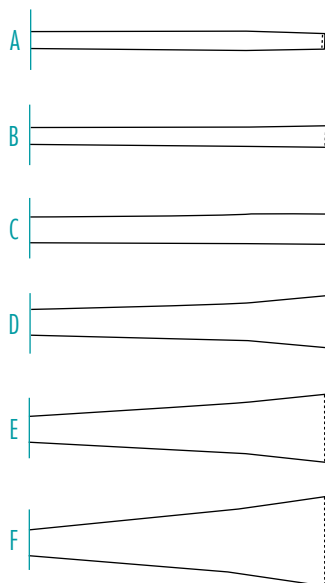

**SHEEHAN**Osteotome, 160mm, 6^{1/4}"

2mm	420-594-002
3mm	420-594-003
4mm	420-594-004
5mm	420-594-005
6mm	420-594-006
8mm	420-594-008
10mm	420-594-010
12mm	420-594-012

**RZ OSTEOTOME**

Osteotome, 180mm, 7"

2mm	420-568-002
3mm	420-568-003
4mm	420-568-004
5mm	420-568-005
6mm	420-568-006
7mm	420-568-007

**SHEEHAN**Osteotome, 90mm, 3^{1/2}"

1mm	420-594-002
-----	-------------

Mini Osteotome, CeraCut®, 175mm, 6^{7/8}"

2mm	420-702-175CC
3mm	420-703-175CC
4mm	420-704-175CC
6mm	420-706-175CC

**COTTLE**

Mallet, Ø 30mm, 1 side plain, 1 side convex
240g

190mm, 7¹/₂" 210-240-180

**LUCAE**

Mallet, Ø 19mm
190mm, 7¹/₂"

80g 210-230-190

140g 210-231-190

**COLLIN (LUCAE)**

Mallet, Ø 30mm
220g

200mm, 8" 210-220-200



Mallet, Ø 35mm, synthetic

240mm, 9¹/₂" 210-260-150



Mallet, anodized aluminium handle and head,
Ø 32mm
140g

225mm, 8⁷/₈" 210-264-220

Spare Discs, pair 210-264-221

**JOSEPH**Nasal Saw, 170mm, 6²/₃"

straight	230-202-000
bayonet shaped, curved left	230-202-001
bayonet shaped, curved right	230-202-002

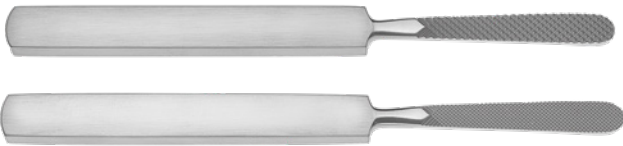
**JOSEPH**Nasal Rasp, cross-serrated, 160mm, 6¹/₄"

fine	420-605-160
coarse	420-606-160

**MALTZ**

Rasp, straight, 180mm, 7"

backward cutting	420-654-180
forward cutting	420-657-180

**MCINDOE**

Nasal Rasp, straight, backward cutting

180mm, 7"	420-655-180
-----------	-------------

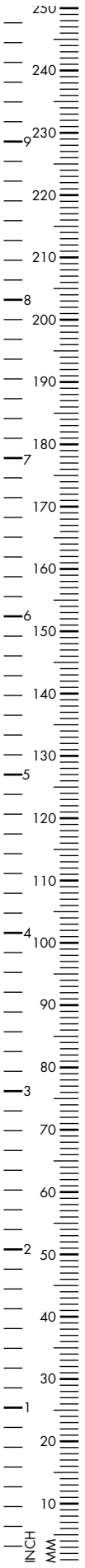

LEWIS

Nasal Rasp, 7mm wide tip

200mm, 8"

420-658-175



COTTLE

Nasal Rasp, backward cutting, straight

210mm, 8¹/₄"

420-670-210



AUFRICHT

Nasal Rasp, 90° cross-serrated,
9mm wide, 220mm, 8²/₃"

A backward cutting

420-650-001

B forward cutting

420-650-002

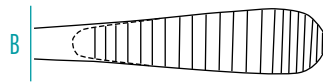
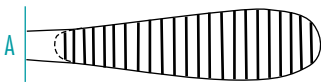

MILLER

Rasp, 90° cross-serrated, backwards cutting,
180mm, 7"

Fig. 1



Fig. 2



Fig. 3



Fig. 1 8mm / 5mm

500-387-000

Fig. 2 6mm / 4mm

500-384-010

Fig. 3 6mm / 5mm

500-386-045

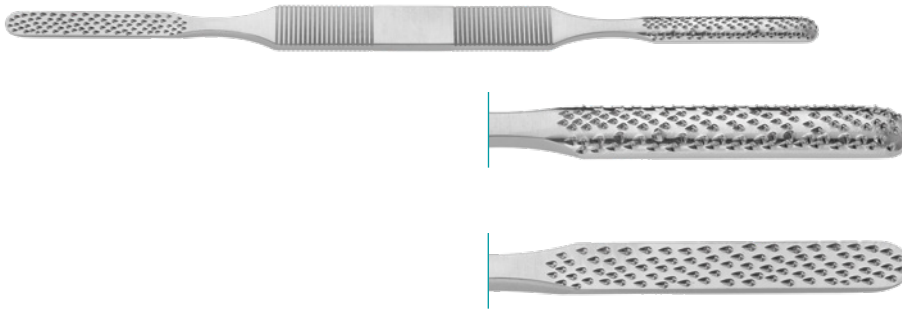

FOMON LIGHTWEIGHT

Rasp, double-ended, 7.0mm
215mm, 8¹/₂"

Coarse	420-662-001
Fine	420-662-002

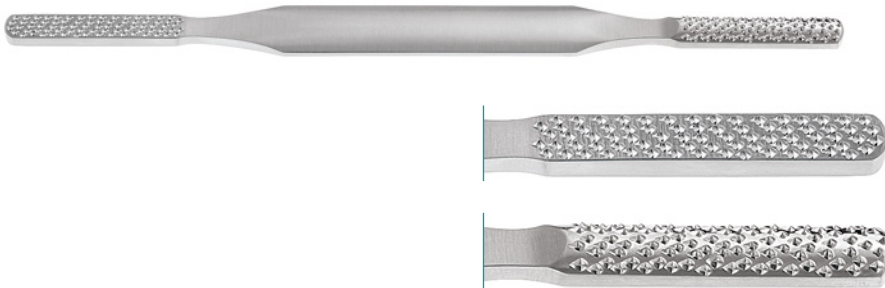

FOMON

Rasp, coarse, double-ended, 7.0mm / 8.0mm
215mm, 8¹/₂"

420-660-000

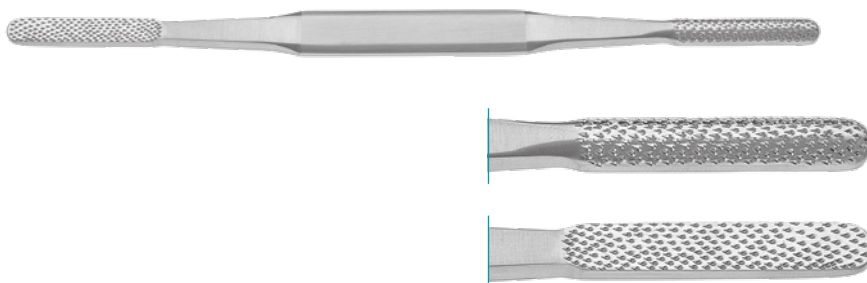

FOMON

Rasp, fine, round/flat
215mm, 8¹/₂"

420-661-000

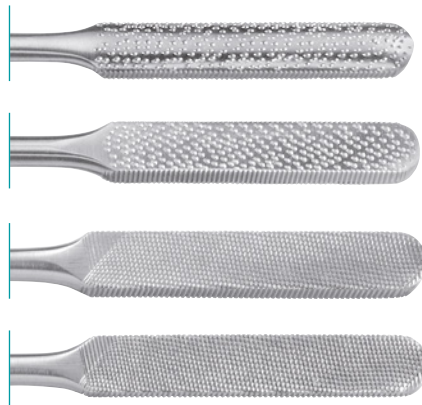
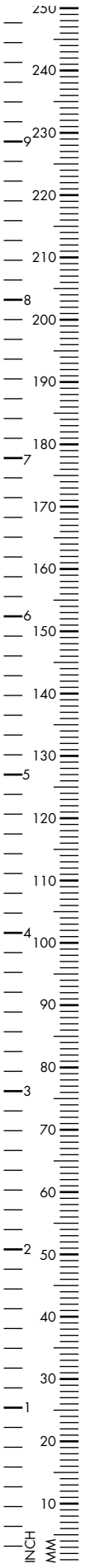

FOMON

Rasp, fine/coarse, double-ended, 4 sides

215mm, 8¹/₂"

420-661-100

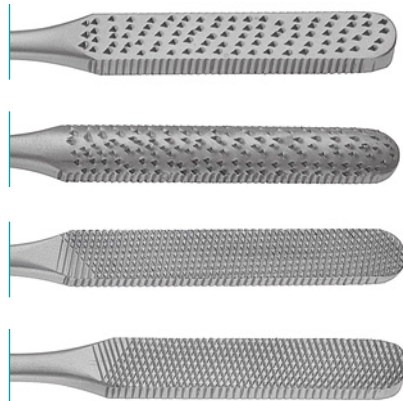

KLEINERT KUTZ

Rasp, double-ended, 4 sides

220mm, 8²/₃"

420-656-000



MALTZ

Nasal Rasp, straight, backward cutting

180mm, 7"

420-672-000



MALTZ

TC Rasp,

165mm, 6 1/2"

Fig. 2

420-492-165

Fig. 3

420-493-165



PARKES

TC Rasp, straight, 8 x 39mm

210mm, 8 1/4"

Fig. 1

420-490-210

Fig. 2

420-491-210

Fig. 3

420-492-210

Fig. 4

420-493-210

Fig. 5

420-494-210



FOMON

TC Rasp, double-ended, 7 x 40mm

210mm, 8 1/4"

Fig. 1 / Fig. 2

420-660-219

Fig. 3 / Fig. 4

420-660-214

Fig. 5 / Fig. 6

420-660-216

Fig. 7 / Fig. 8

420-660-218

Fig. 9 / Fig. 10

420-660-200



Fig.1
0.8



Fig.2
1.1



Fig.3
1.3



Fig.4
1.6

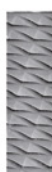

Fig.5
1.8



Fig.6
2.0



Fig.7
2.4



Fig.8
2.6



Fig.9
2.8



Fig.10
3.0

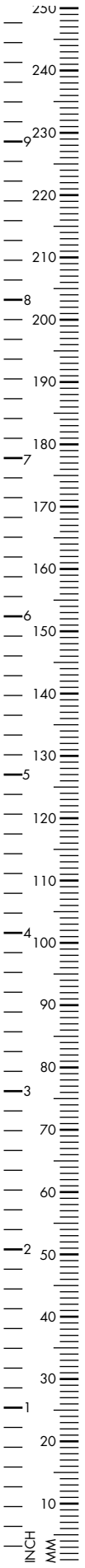

ASTON

Nasal Rasp, backward cutting, straight, 200mm, 8"

fine	420-480-200
coarse	420-488-200



AUFRICHT (PEET)

Nasal Rasp, 7 x 25mm fine, curved diamond jaws

200mm, 8"	420-650-101
-----------	-------------



PEET-COTTLE

Nasal Rasp, curved, diamond jaws

190mm, 7 1/2"	420-650-100
---------------	-------------

**PEET**

Convex Nasal Rasp, 25x8mm, straight
diamond jaws

190mm, 7^{1/2}"

420-650-050

**COTTLE**

Rasp, 7x33mm, straight
diamond jaws

200mm, 8"

420-675-200

**FOMON**

Rasp, double-ended, convex on flat,
diamond jaws, 7 x 40mm

210mm, 8^{1/4}"

420-653-000

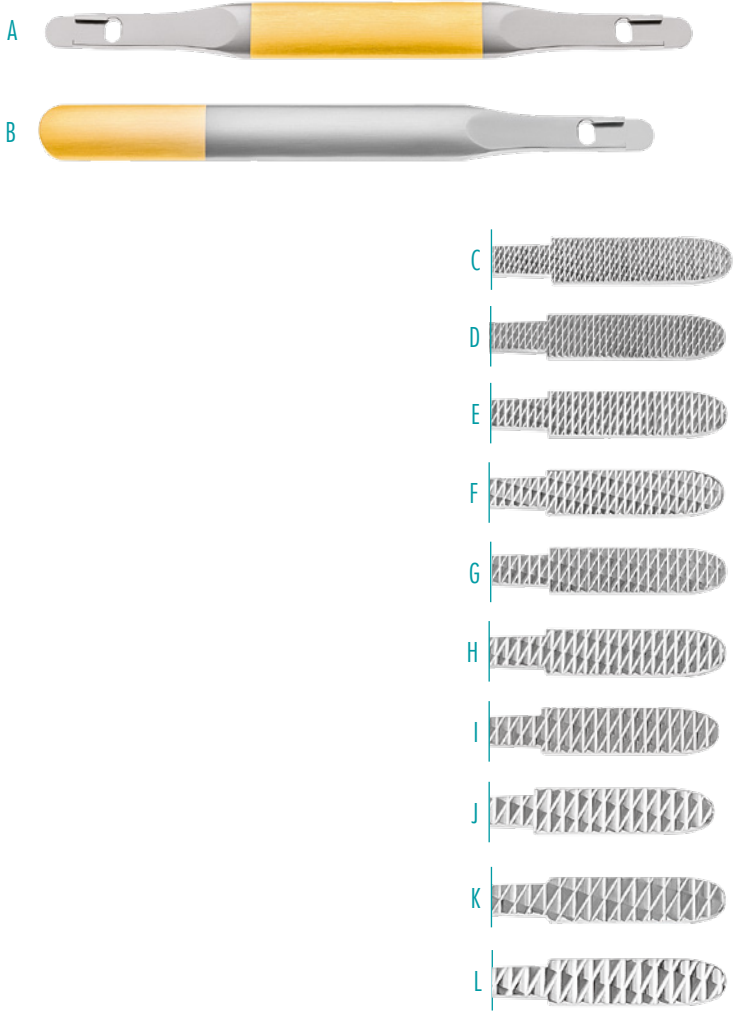
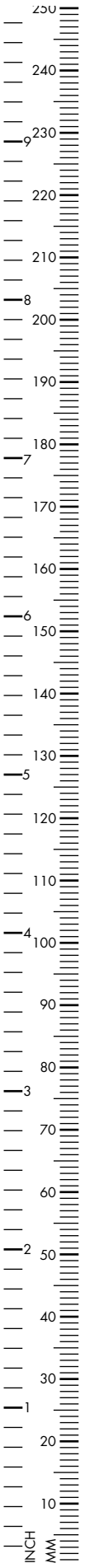

FOMON

Nasal Rasp Holder

A	double-ended	420-660-200
B	single-ended	420-660-100

FOMON

TC Insert

C	Fig. 1	420-660-101
D	Fig. 2	420-660-102
E	Fig. 3	420-660-103
F	Fig. 4	420-660-104
G	Fig. 5	420-660-105
H	Fig. 6	420-660-106
I	Fig. 7	420-660-107
J	Fig. 8	420-660-108
K	Fig. 9	420-660-109
L	Fig. 10	420-660-110

Fixation Key

M		420-660-150
---	--	-------------

TC Nasal Rasp Set, complete in sterilization tray, incl. 10 inserts, 1 key and 2 handles (single+double)

N		420-660-500
---	--	-------------

Wire Brush for cleaning rasps

165mm, 6 ¹ / ₂ "	260-500-001
--	-------------

**GIERTZ STILLE**

Rib Shears, double action

250mm, 9⁷/₈"

290-137-270

**DINGMANN**

Bone Holding Forceps, heavy pattern

190mm, 7¹/₂"

210-626-190

**LANGENBECK**

Bone Holding Forceps, 11mm wide

210mm, 8¹/₄"

210-722-210

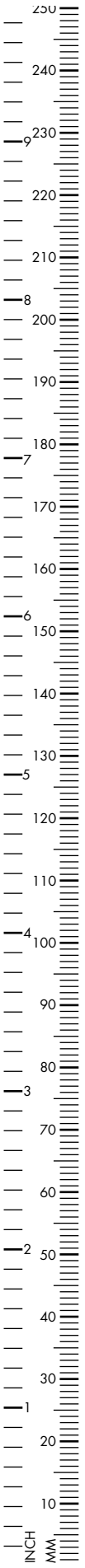

DOYEN

Rib Raspatory, 175mm, 6⁷/₈"

curved right	210-331-170
curved left	210-333-170



COTTLE

Bone Crusher with removal clip forceps,
28mm wide

	420-365-000
Cartilage Crusher, 50mm wide	420-365-050

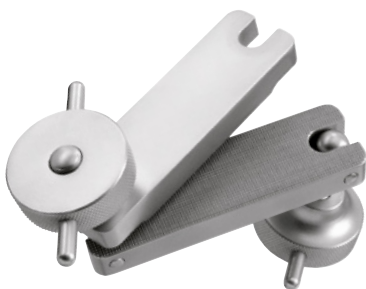

RZ

Cartilage Crusher

60 x 30mm	420-364-000
-----------	-------------

**TOLSDORF**

Bone crusher, inner part serrated, outer part
bottom plain, Ø 40mm

420-366-000



Plastic Plate, autoclavable

85 x 55mm 420-367-000



Plastic Plate, for preparation of bone grafts,
autoclavable

200x100x10mm 420-367-002

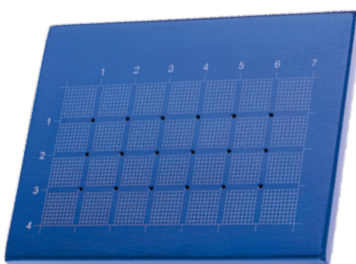
**SHEEN**

Cartilage Grid, aluminium, blue

70 x 40mm 260-761-000



Ruler, with mm inch markings

150mm, 6" 100-418-150

200mm, 8" 100-418-200

300mm, 12" 100-418-300

**CASTROVIEJO**

Caliper with locking screw, 0 - 15mm scale

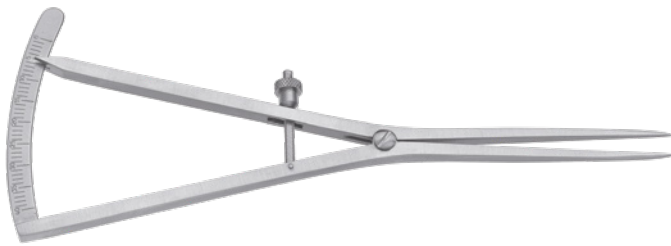
70mm, 2³/₄" 400-583-005**CASTROVIEJO**

Caliper with locking screw

0 - 20mm, 400-583-007
85mm, 3¹/₄"0 - 40mm, 400-583-008
180mm, 7"**CASTROVIEJO**Caliper with locking screw, angled,
0 - 20mm scale70mm, 2³/₄" 400-583-009**JAMESON**Caliper with locking screw, graduated,
0 - 80 mm95mm, 3³/₄" 400-421-000**THORPE**Caliper with locking screw, graduated,
0 - 80 mm95mm, 3³/₄" 400-420-100

**NOLST TRENITÉ**

Glabella Rasp, 8mm wide

185mm, 7¹/₄"

420-700-400

**NOLST TRENITÉ**

Nasal Rasp, double-ended, 200mm, 8"

medium

420-700-501

medium/fine

420-700-502

**NOLST TRENITÉ**Micro Skin Hook, 155mm, 6¹/₈"

1 prong

420-700-001

2 prongs

420-700-002

**NOLST TRENITÉ**

Micro Skin Hook, 2 prongs, 10mm wide

420-700-210

**NOLST TRENITÉ**

Nasal Retractor, Aufricht type

160mm, 6¹/₄"

420-700-200



BLAKESLEY (NOLST TRENITÉ)

Nasal Forceps, delicate, 3.5mm

85mm working length 420-700-700



NOLST TRENITÉ

Micro Osteotome, 185mm, 7¹/₄"

2.0mm	420-700-020
2.5mm	420-700-025
3.0mm	420-700-030
4.0mm	420-700-040
6.0mm	420-700-060



NOLST TRENITÉ

Micro Osteotome with guard, 185mm, 7¹/₄"

2.2mm	420-700-022
3.0mm	420-700-023
4.0mm	420-700-024



NOLST TRENITÉ

Micro Osteotome, 185mm, 7¹/₄"

10mm	420-700-100
12mm	420-700-120
14mm	420-700-140
16mm	420-700-160
18mm	420-700-180

**NOLST TRENITÉ**

Rhinoplasty Scissors, sharp, 100mm, 4"

straight 420-700-610

curved 420-700-611

**NOLST TRENITÉ**

Dissecting Scissors, Kilner type

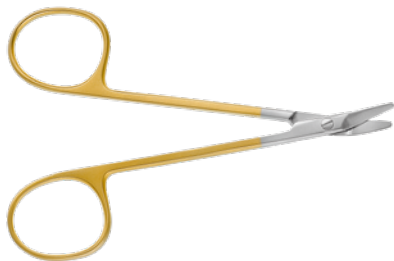
140mm, 5^{1/2}" 420-700-340**NOLST TRENITÉ**

Angled Scissors, Walter type

100mm, 4" 420-700-620

**NOLST TRENITÉ**

Halsey type

130mm, 5^{1/8}" 420-700-330

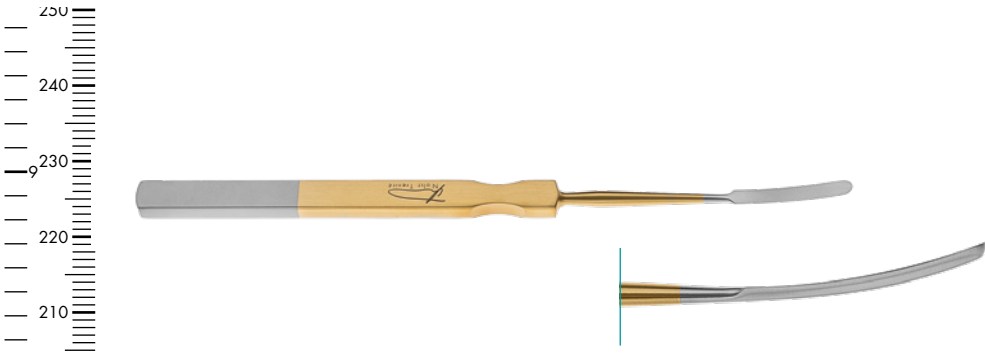

NOLST TRENITÉ
 Periosteal Elevator, Joseph Type, 3mm
 180mm, 7" 420-700-430

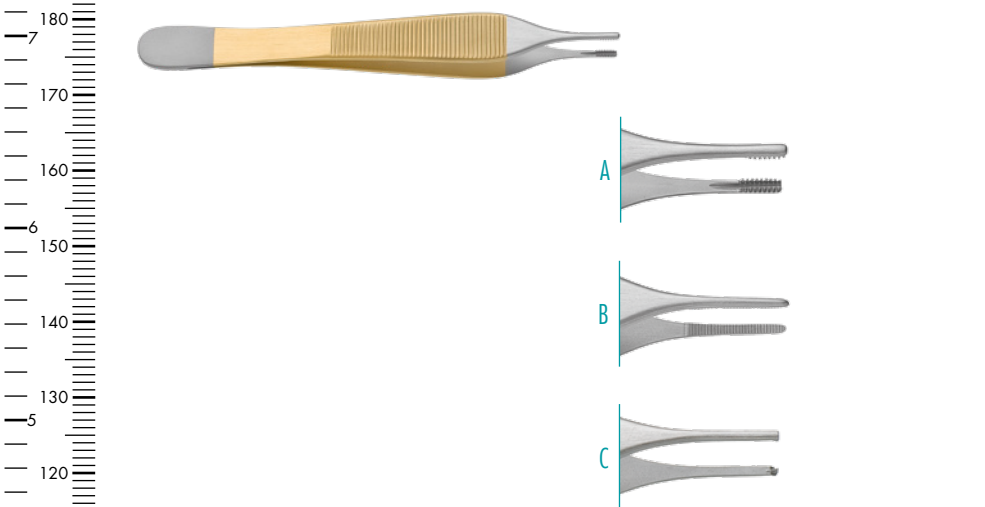

NOLST TRENITÉ
 Dressing/Tissue Forceps, 120mm, 4^{3/4}"

A Adson-Brown type	420-700-630
B Adson type	420-700-640
C Adson type	420-700-650

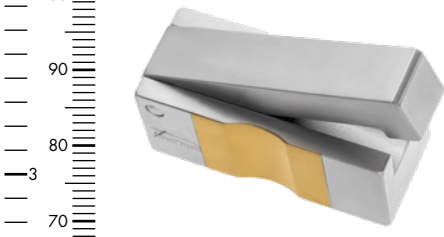

NOLST TRENITÉ
 Cartilage Crusher, Cottle type
420-700-777



NOLST TRENITÉ
 Mallet, Cottle type
420-700-888

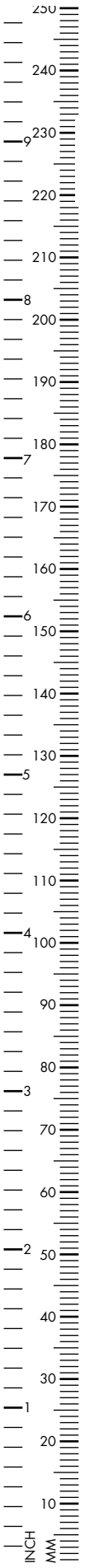



Bipolar electrode with flat plug,
105mm working length

A	700-420-002
B	700-420-001



Bipolar Suction Forceps, bayonet shaped,
200mm, 8"

1.4mm tip	700-600-201
2.0mm tip	700-600-202
230mm, 9"	
1.4mm tip	700-600-231
2.0mm tip	700-600-232
60° curved 210mm, 8 ¹ / ₄ "	
3.2mm tip	700-600-214
45° curved 210mm, 8 ¹ / ₄ "	
3.0mm tip	700-600-213



Bipolar Forceps, angled jaws, 2.0mm tip
180mm, 7"

	700-600-195
--	-------------



Bipolar Forceps, knee angled, pointed tip

165mm, 6 ¹ / ₂ "	700-600-160
220mm, 8 ² / ₃ "	700-600-220
0.5mm tip	
165mm, 6 ¹ / ₂ "	700-600-165
220mm, 8 ² / ₃ "	700-600-225
1.0mm tip	
165mm, 6 ¹ / ₂ "	700-600-161
220mm, 8 ² / ₃ "	700-600-221

NON-STICK FORCEPS

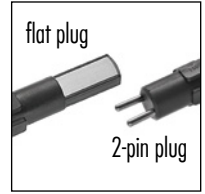

Straight		150mm		180mm		200mm	220mm
		straight tip	angled tip	straight tip	angled tip	straight tip	straight tip
0.3mm tip (point)	flat plug	700-610-150	700-611-150	700-610-180	700-611-180	700-610-200	700-610-220
	2-pin	700-612-150	700-613-150	700-612-180	700-613-180	700-612-200	700-620-220
0.6mm tip (blunt)	flat plug	700-620-150	700-621-150	700-620-180	700-621-180	700-620-200	700-620-220
	2-pin	700-622-150	700-623-150	700-622-180	700-623-180	700-622-200	700-622-220
1.0mm tip (blunt)	flat plug	700-630-150	700-631-150	700-630-180	700-631-180	700-630-200	700-630-220
	2-pin	700-632-150	700-633-150	700-632-180	700-633-180	700-632-200	700-632-220
2.0mm tip (blunt)	flat plug	700-640-150	700-641-150	700-640-180	700-641-180	700-640-200	700-640-220
	2-pin	700-642-150	700-643-150	700-642-180	700-643-180	700-642-200	700-642-220



JEWELER TYPE		110mm	
		straight tip	angled tip
0.25mm tip (point)	flat plug	700-601-710	700-601-730
	2-pin	700-601-711	700-601-731
0.6mm tip (blunt)	flat plug	700-601-712	700-601-732
	2-pin	700-601-713	700-601-733
1.0mm tip (blunt)	flat plug	700-601-714	700-601-734
	2-pin	700-601-715	700-601-735



straight tip

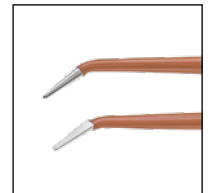

angled tip

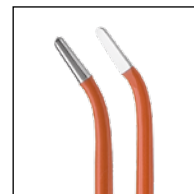

angled down tip

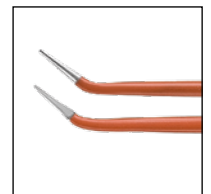

angled up tip

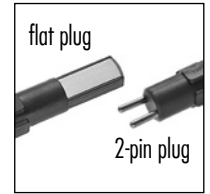

Bayonet Shape		180mm straight tip	200mm straight tip	220mm straight tip	240mm straight tip
0.3mm tip (point)	flat plug	700-650-180	700-650-200	700-650-220	700-650-240
	2-pin	700-652-180	700-652-200	700-652-220	700-652-240
0.6mm tip (blunt)	flat plug	700-660-180	700-660-200	700-660-220	700-660-240
	2-pin	700-662-180	700-662-200	700-662-220	700-662-240
1.0mm tip (blunt)	flat plug	700-670-180	700-670-200	700-670-220	700-670-240
	2-pin	700-672-180	700-672-200	700-672-220	700-672-240
2.0mm tip (blunt)	flat plug	700-680-180	700-680-200	700-680-220	700-680-240
	2-pin	700-682-180	700-682-200	700-682-220	700-682-240

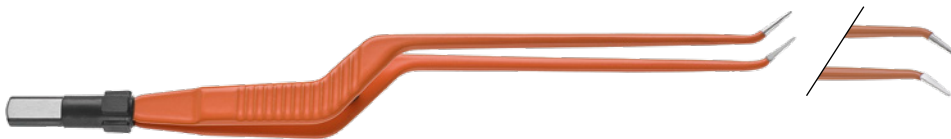

Bayonet Shape, angled up/angled down		200mm angled up tip	220mm angled up tip	200mm angled down tip	220mm angled down tip
1.0mm tip (blunt)	flat plug	700-670-201	700-670-221	700-670-203	700-670-223
	2-pin	700-672-201	700-672-221	700-672-203	700-672-223

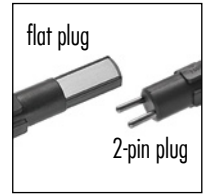

NON-STICK FORCEPS, ROUND HANDLE



Straight		150mm		180mm	
		straight tip	angled tip	straight tip	angled tip
0.3mm tip (point)	flat plug	700-010-150	700-011-150	700-010-180	700-011-180
	2-pin	700-012-150	700-013-150	700-012-180	700-013-180
0.6mm tip (blunt)	flat plug	700-020-150	700-021-150	700-020-180	700-021-180
	2-pin	700-022-150	700-023-150	700-022-180	700-023-180
1.0mm tip (blunt)	flat plug	700-030-150	700-031-150	700-030-180	700-031-180
	2-pin	700-032-150	700-033-150	700-032-180	700-033-180
2.0mm tip (blunt)	flat plug	700-040-150	700-041-150	700-040-180	700-041-180
	2-pin	700-042-150	700-043-150	700-042-180	700-043-180
Straight		200mm		225mm	
		straight tip	angled tip	straight tip	angled tip
0.3mm tip (point)	flat plug	700-010-200	700-011-200	700-010-220	700-011-220
	2-pin	700-012-200	700-013-200	700-012-220	700-013-220
0.6mm tip (blunt)	flat plug	700-020-200	700-021-200	700-020-220	700-021-220
	2-pin	700-022-200	700-023-200	700-022-220	700-023-220
1.0mm tip (blunt)	flat plug	700-030-200	700-031-200	700-030-220	700-031-220
	2-pin	700-032-200	700-033-200	700-032-220	700-033-220
2.0mm tip (blunt)	flat plug	700-040-200	700-041-200	700-040-220	700-041-220
	2-pin	700-042-200	700-043-200	700-042-220	700-043-220



straight tip

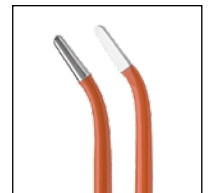

angled down tip

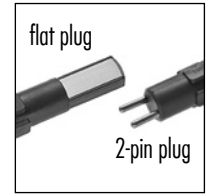

Bayonet		180mm straight tip	200mm straight tip
0.3mm tip (point)	flat plug	700-050-180	700-050-200
	2-pin	700-052-180	700-052-200
0.6mm tip (blunt)	flat plug	700-060-180	700-060-200
	2-pin	700-062-180	700-062-200
1.0mm tip (blunt)	flat plug	700-070-180	700-072-200
	2-pin	700-072-180	700-072-200
2.0mm tip (blunt)	flat plug	700-080-180	700-082-200
	2-pin	700-082-180	700-082-200
Bayonet		225mm straight tip	250mm straight tip
0.3mm tip (point)	flat plug	700-050-220	700-050-250
	2-pin	700-052-220	700-052-250
0.6mm tip (blunt)	flat plug	700-060-220	700-060-250
	2-pin	700-062-220	700-062-250
1.0mm tip (blunt)	flat plug	700-070-220	700-070-250
	2-pin	700-072-220	700-072-250
2.0mm tip (blunt)	flat plug	700-080-220	700-080-250
	2-pin	700-082-220	700-082-250



