

# ORAL

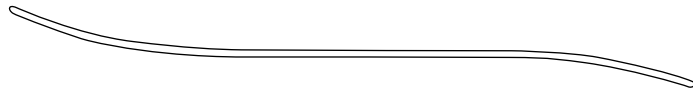

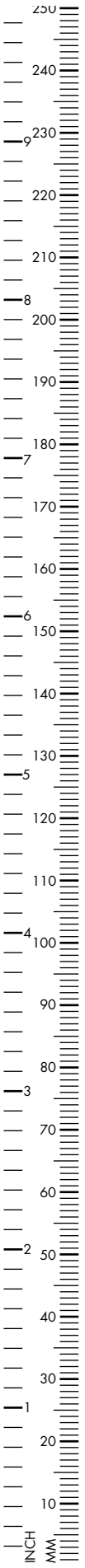

**BUCHWALD**

Tongue Depressor, 23 x 18mm

180mm, 7"

430-361-190



**MAYO**

Tongue Depressor, 23 x 19mm

170mm, 6<sup>2</sup>/<sub>3</sub>"

430-362-170

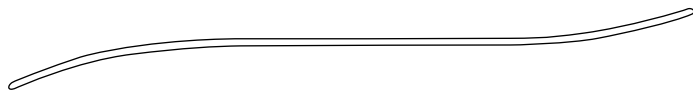

**BRUENINGS**

Tongue Depressor

190mm, 7<sup>1</sup>/<sub>2</sub>"

430-385-190



**MINNESOTA**

Cheek Retractor, 14mm and 20mm wide,  
double-ended

155mm, 6<sup>1</sup>/<sub>8</sub>"

430-155-000

**MORITZ-SCHMIDT**

Tongue Depressor

190mm, 7<sup>1</sup>/<sub>2</sub>"

430-397-190

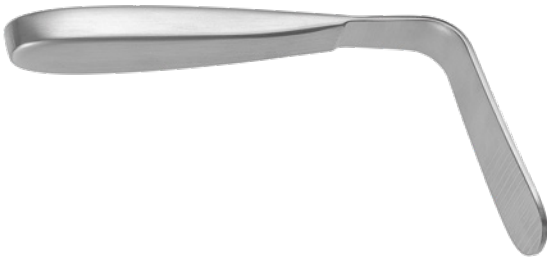
**TOBOLD**

Tongue Depressor

145mm, 5<sup>3</sup>/<sub>4</sub>"

430-349-145

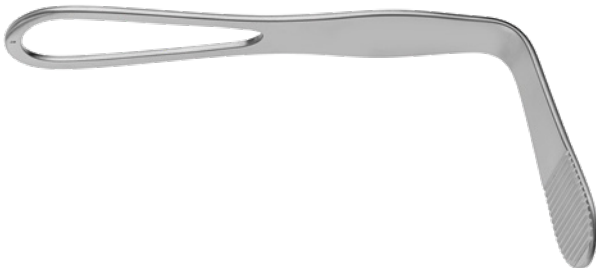
**HARTMANN**

Tongue Depressor, fenestrated handle

150mm, 6"

430-271-150

**WIEDER**

Tongue Depressor, fenestrated blade

125mm, 5"

30mm blade

430-297-140

36mm blade

430-297-150

**STIERLEN**

Tongue Depressor

55mm	430-350-005
70mm	430-350-007
90mm	430-350-009
100mm	430-350-010

**HEISTER**

Mouth Gag

130mm, 5 <sup>1</sup> / <sub>8</sub> "	430-150-130
--	-------------

**DOYEN-JANSEN**

Mouth Gag, children

120mm, 5 <sup>1</sup> / <sub>8</sub> "	430-140-110
--	-------------

adults

140mm, 5 <sup>1</sup> / <sub>2</sub> "	430-140-140
--	-------------

**DENHARDT**

Mouth Gag, silicone inserts, interchangeable

120mm, 4 <sup>3</sup> / <sub>4</sub> "	430-142-120
--	-------------

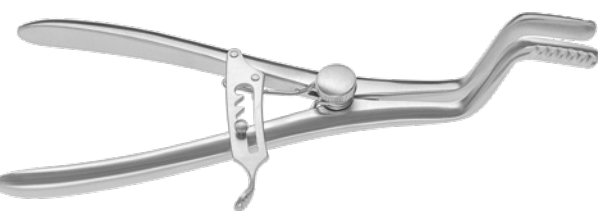
**ROSER-KOENIG**

Mouth Gag

160mm, 6 <sup>1</sup> / <sub>4</sub> "	430-144-160
--	-------------

**JENNINGS**

Mouth Gag

90mm, 3 1/2"	430-250-090
110mm, 4 1/3"	430-250-110
130mm, 5 1/8"	430-250-130
150mm, 6"	430-250-150

**MC IVOR**

Mouth Gag, frame only

430-256-010

**DAVIS-MEYER**

Mouth Gag, frame only

right	430-130-500
left	430-130-510



Sliding Tooth Hook

430-130-520



Palate Blade, for 430-130-500

430-130-560

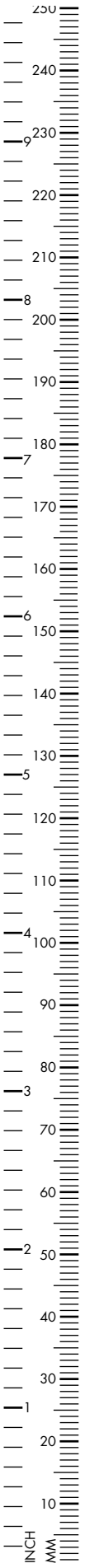

**DAVIS-BOYLE**

Mouth Gag, adults

left	430-310-010
right	430-310-011



Silicone Caps for Davis-Boyle mouth gag

430-310-012



**DAVIS-BOYLE**

Mouth Gag, small pattern for adolescent

430-310-009

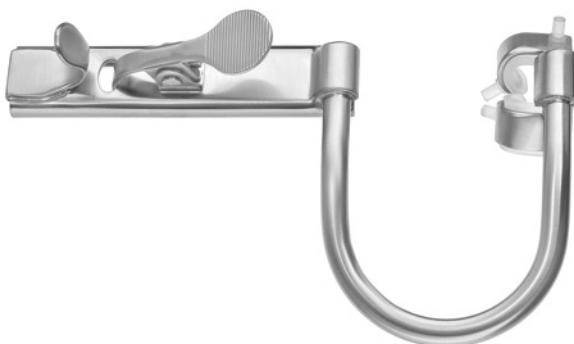

**DAVIS-BOYLE**

Mouth Gag, children

430-310-110

**KILNER-DOUGHTY**

Mouth Gag, left

430-315-010

**DINGMANN**

Mouth Gag, set with 3 blades

430-327-000

Mouth Gag only

430-327-004

Blades

24 x 62mm

430-327-001

28 x 65mm

430-327-002

31 x 75mm

430-327-003



# OSTRA LARYNGO-PHARYNGOSCOPE RETRACTOR

- **Wide range of blades**  
Tongue, vallecular and laryngeal
- **Adaptable design**  
Accommodates different anatomical conditions and surgical techniques
- **Open lateral frame**  
Enables free movement for robotic instruments and camera, ensuring an unobstructed view
- **Independent blade adjustment**  
Precise control of angle and depth for customized exposure.
- **Secure fixation**  
Fully compatible with the RZ Retractor Holder Set

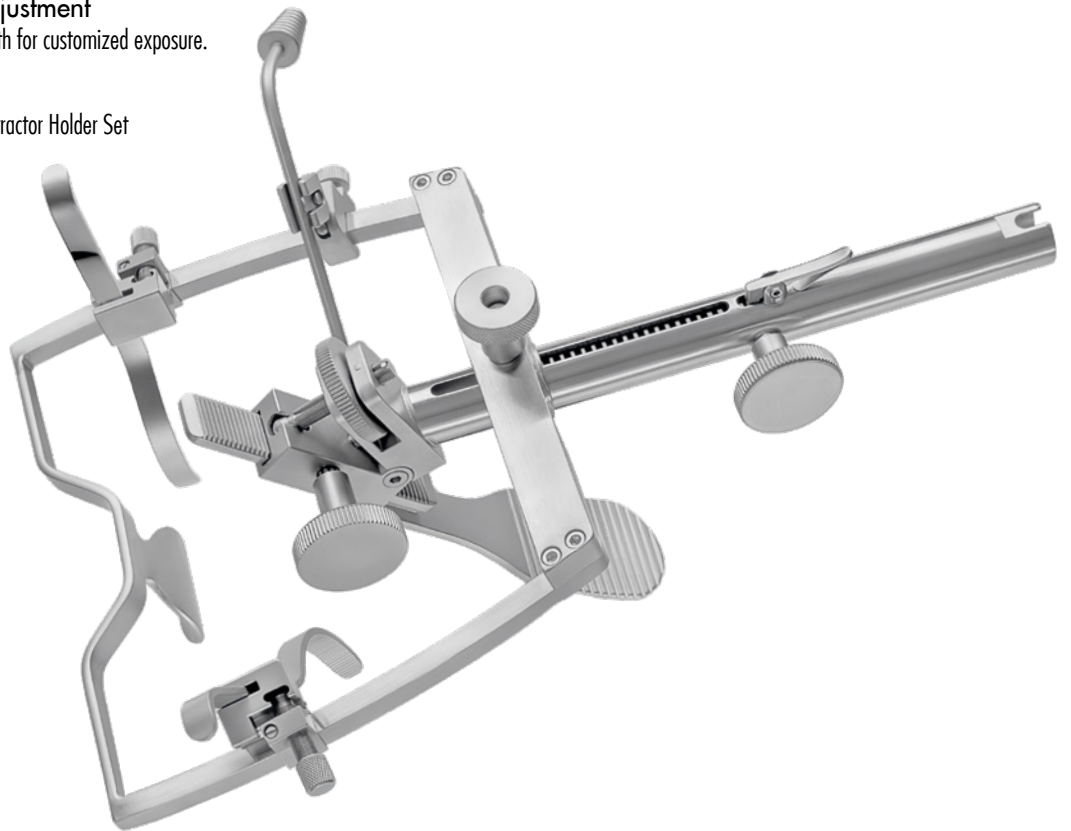

**NATHANSON**

Retractor Arm Set with table clamp

Table Clamp	170-801-503
single arm	170-801-501
double arm	170-801-502



- **Secure table fixation**
- **90° / 360° positioning flexibility**
- **Quick-lock attachment**

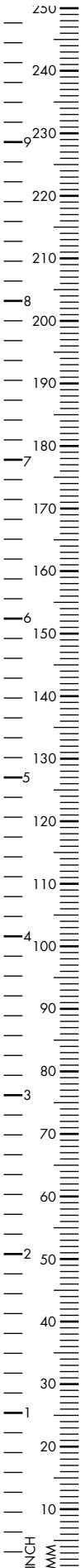



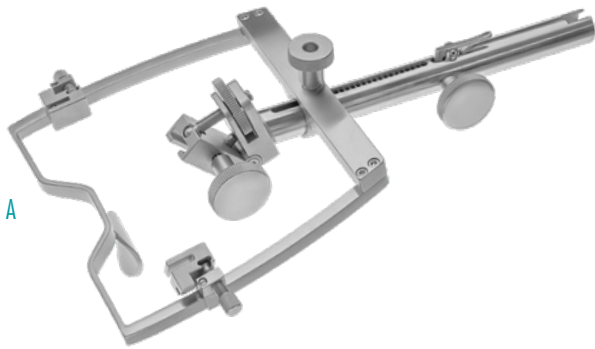

A



B



D



F



H



J



L



N



C



E



G



I



K



M

**RZ OSTR**Laryngo-Pharyngoscope Retractor,  
complete set

430-326-000

A Basic frame  
with adaptor 430-326-100B Adaptor for  
Retractor Holder Set  
170-801-501 430-326-002C Adaptor For Chest  
Support 430-326-003D TORS blade,  
small, left 430-326-004D TORS blade,  
small, right 430-326-005E TORS blade,  
large, left 430-326-006E TORS blade,  
large, right 430-326-007F Tongue blade,  
curved 430-326-008G Tongue blade,  
curved, open right 430-326-009G Tongue blade,  
curved, open left 430-326-010H Mandible blade,  
110mm 430-326-011I Laryngeal blade,  
170mm, concave 430-326-012J Diverticle blade,  
concave, working  
length 22 cm 430-326-013K Cheek retractor,  
curved 430-326-014L Light clip, with  
lateral cable connection 430-326-015M Adaptor for suction  
tube or tumor grasping  
forceps 430-326-016N Suction tube for  
smoke, Ø4x170 mm 430-326-017

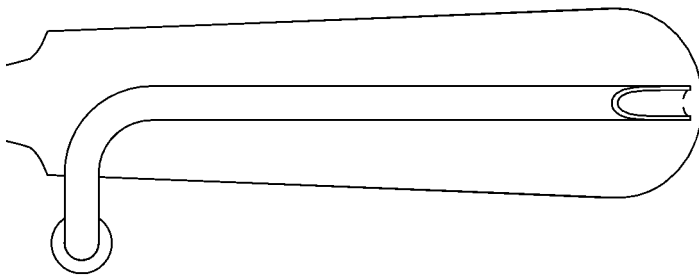
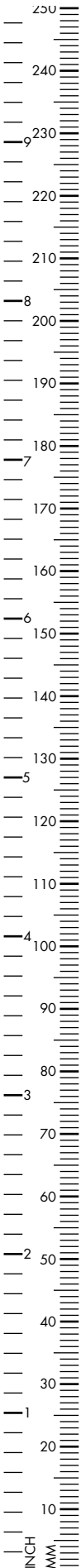

**DAVIS-BOYLE**

Tongue Blade, without anaesthesia channel

21 x 30mm 430-257-001

with anaesthesia channel

23 x 65mm 430-257-002

24 x 80mm 430-257-003

25 x 93mm 430-257-004

26 x 108mm 430-257-005

**DAVIS-BOYLE**

Tongue Blade

25 x 65mm 430-310-001

25 x 75mm 430-310-002

25 x 90mm 430-310-003

25 x 102mm 430-310-004

**MC IVOR**

Tongue Blade

23 x 55mm 430-256-001

25 x 65mm 430-256-002

26 x 75mm 430-256-003

**HERBERHOLD**

Tongue Blade

Fig. 1, 29 x 61mm 430-298-001

Fig. 2, 33 x 70mm 430-298-002

Fig. 3, 38 x 79mm 430-298-003

Fig. 4, 41 x 94mm 430-298-004

**DAVIS-MEYER**Tongue Blade, with tubing set  
for anaesthesia channel

29 x 70mm	430-130-070
30 x 75mm	430-130-075
31 x 80mm	430-130-080
32 x 85mm	430-130-085
33 x 95mm	430-130-095
34 x 100mm	430-130-100
34 x 105mm	430-130-105

**KILNER-DOUGHTY**

Tongue Blade

28 x 65mm	430-315-001
23 x 75mm	430-315-002
37 x 80mm	430-315-003

**RUSSEL-DAVIS**

Tongue Blade, with groove

28 x 65mm	430-309-001
32 x 75mm	430-309-002
37 x 80mm	430-309-003
41 x 94mm	430-309-004
46 x 103mm	430-309-005

very narrow pattern

18 x 57mm	430-309-006
22 x 67mm	430-309-007
25 x 75mm	430-309-008
27 x 85mm	430-309-009

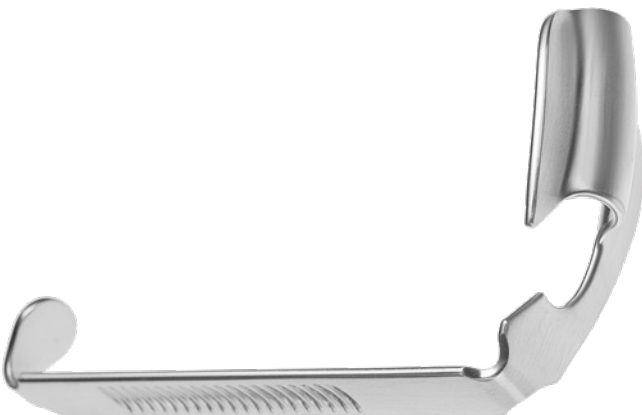

Tongue Blade, with groove

28 x 65mm	430-129-001
32 x 75mm	430-129-002
37 x 80mm	430-129-003

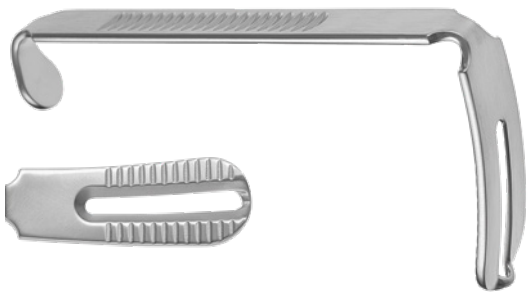
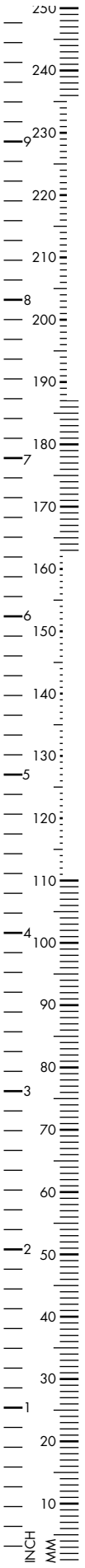

**DOUGHTY**

Tongue Blade, with slot

23 x 65mm	430-320-065
24 x 80mm	430-320-075
25 x 93mm	430-320-090
26 x 108mm	430-320-102
26 x 114mm	430-320-115



**WÜRZBURG**

Tongue Blade, slotted

136 x 71mm	430-325-001
136 x 77mm	430-325-002
136 x 86mm	430-325-003
136 x 96mm	430-325-004
136 x 106mm	430-325-005

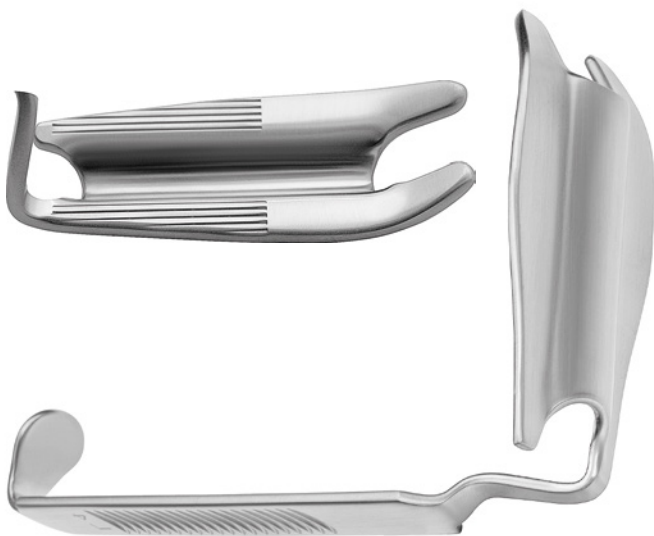

Tongue Blade, left

25 x 58mm	430-000-002
27 x 72mm	430-000-003
34 x 87mm	430-000-004
37 x 95mm	430-000-005

right

25 x 58mm	430-010-002
27 x 72mm	430-010-003
34 x 87mm	430-010-004
37 x 95mm	430-010-005



**NEGUS**  
Chest Support

430-320-000

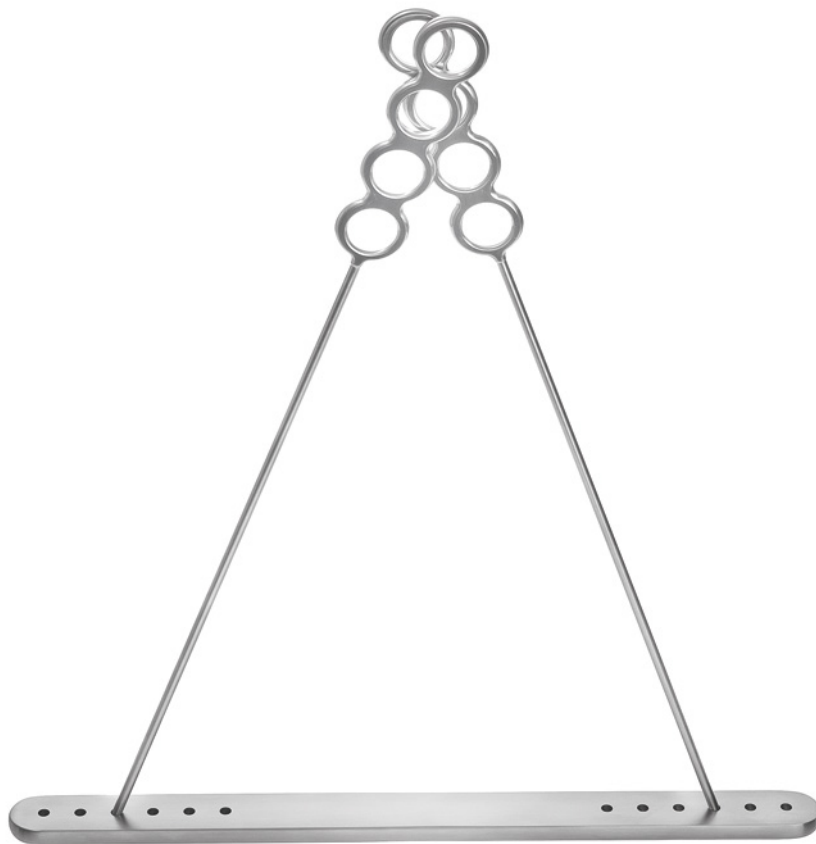

**DRAFFIN**  
Holder for mouth gag, complete:  
2 bars and plate

430-355-000

Bars only, pair

430-355-001

Magauran Plate

430-355-002

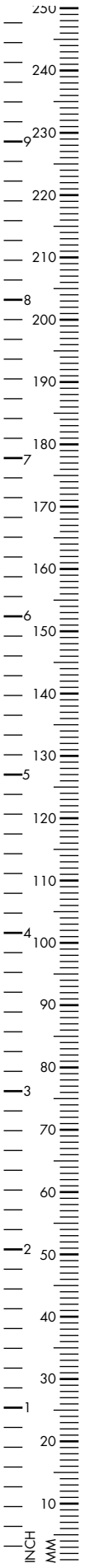

**SEIFERT**

Salivary duct probe, silver plated,  $\varnothing$  1.0mm

180mm, 7" 410-045-180



**BOWMAN**

Lacrimal Probe, buttoned up

0000/000 400-497-008

00/0 400-497-003

0/1 400-497-001

1/2 400-497-012

2/3 400-497-023

3/4 400-497-034

4/5 400-497-045

5/6 400-497-056

6/7 400-497-067

7/8 400-497-078



**WILDER**

Dilator

Fig. 1 400-713-001

Fig. 2 400-713-002

Fig. 3 400-713-003



**PERWITZSCHKY**

Salivary Scissors

100mm, 4" 420-100-100



**PERWITZSCHKY**

Salival Scissors

100mm, 4"

420-100-100



## Scalpel Handle No.7

165mm, 6 1/2"

110-130-077



## Scalpel Handle No.3L

210mm, 6 1/4"

110-116-033

**FISCHER**

Tonsil Knife, serrated blade

225mm, 8 7/8"

430-656-190

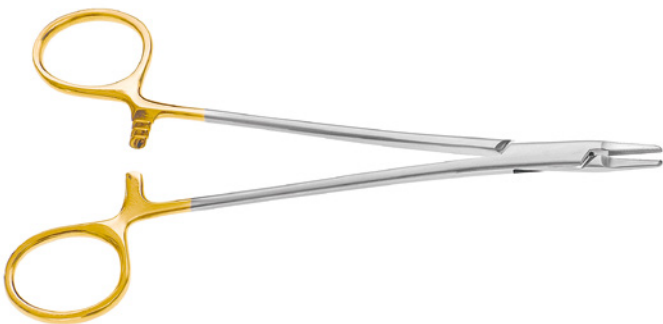
**RYDER**

TC Needle Holder, 2.0mm tip, serrated jaw, straight

180mm, 7"

180-560-180

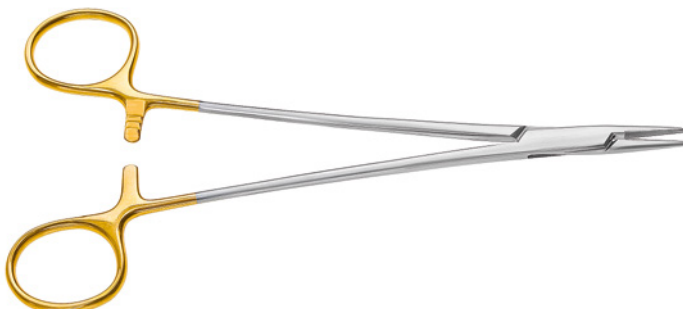
**DEBAKEY**

TC Needle Holder, serrated, straight

180mm, 7"

180-548-180

**NAGER**

Uvula Retractor

210mm, 8<sup>1</sup>/<sub>4</sub>"

430-524-210

**HOFER**

Uvula Retractor

240mm, 9<sup>1</sup>/<sub>2</sub>"

430-300-230

**SCHÖNBORN**

Uvula Retractor, 13 x 6mm

210mm, 8<sup>1</sup>/<sub>4</sub>"

430-245-200

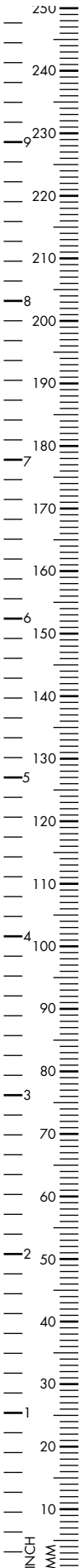



**BECKMANN**Adenoid Curette, straight, 220mm, 8<sup>2</sup>/<sub>3</sub>"

Fig. 1, 8mm	420-220-010
Fig. 2, 10mm	420-220-020
Fig. 3, 12mm	420-220-030
Fig. 4, 14mm	420-220-040
Fig. 5, 16mm	420-220-050
Fig. 6, 18mm	420-220-060
Fig. 7, 19.5mm	420-220-070

**BECKMANN**Adenoid Curette, curved, 220mm, 8<sup>2</sup>/<sub>3</sub>"

Fig. 1, 8mm	420-221-010
Fig. 2, 10mm	420-221-020
Fig. 3, 12mm	420-221-030
Fig. 4, 14mm	420-221-040
Fig. 5, 16mm	420-221-050
Fig. 6, 18mm	420-221-060
Fig. 7, 19.5mm	420-221-070

**BARNHILL**Adenoid Curette, 220mm, 8<sup>2</sup>/<sub>3</sub>"

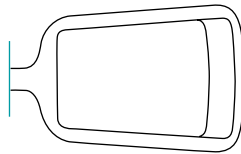
Fig. 0	420-222-000
Fig. 1	420-222-001
Fig. 2	420-222-002
Fig. 3	420-222-003
Fig. 4	420-222-004

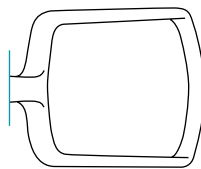

**LA FORCE**

Adenotome, 230mm, 9"

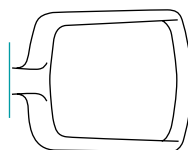
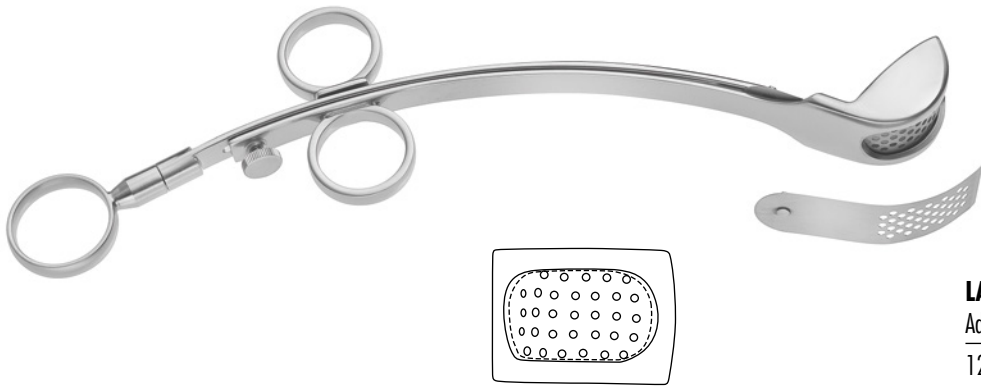
12mm	420-226-001
16mm	420-226-002
18mm	420-226-003

Spare Blades

for 420-226-001	420-226-101
for 420-226-002	420-226-102
for 420-226-003	420-226-103



**SHAMBOUGH**

Adenotome

Fig. 1, 13mm	420-228-000
Fig. 2, 16mm	420-228-000
Fig. 3, 19mm	420-229-100

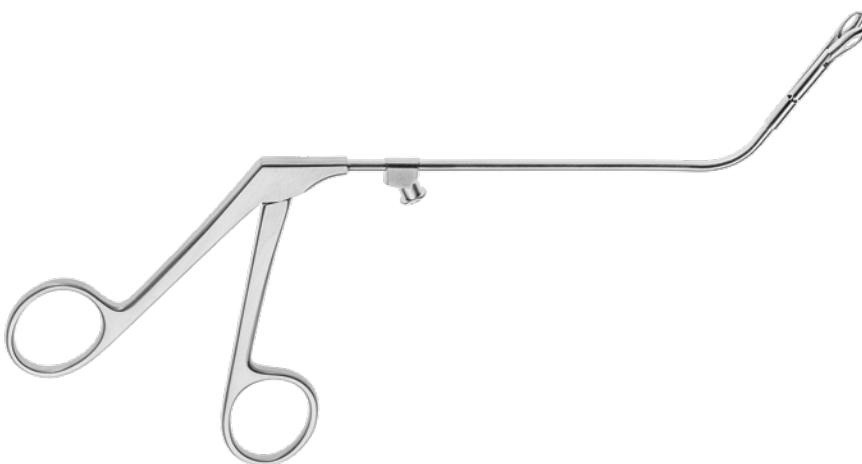

**JATHO**

Nasopharynx Forceps

240mm, 9 1/2"	420-395-240
---------------	-------------



**JURASZ**

Adenoid Cutting Forceps, children

190mm, 7<sup>1</sup>/<sub>2</sub>" 420-396-190

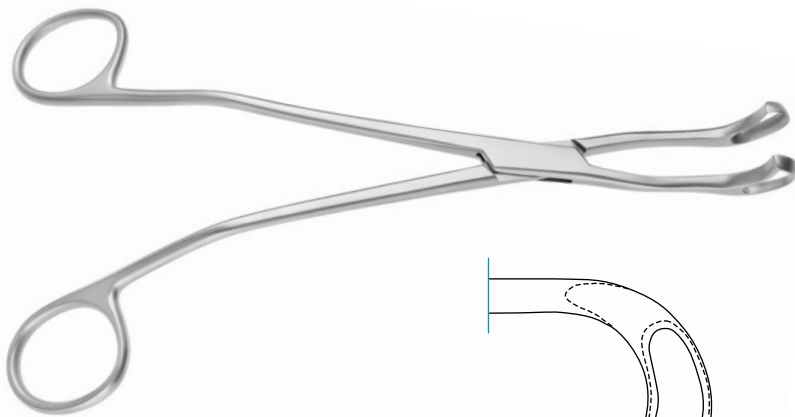

**JURASZ**

Adenoid Cutting Forceps, 210mm, 8<sup>1</sup>/<sub>4</sub>"

Fig. 1 420-397-210

Fig. 2 420-398-210

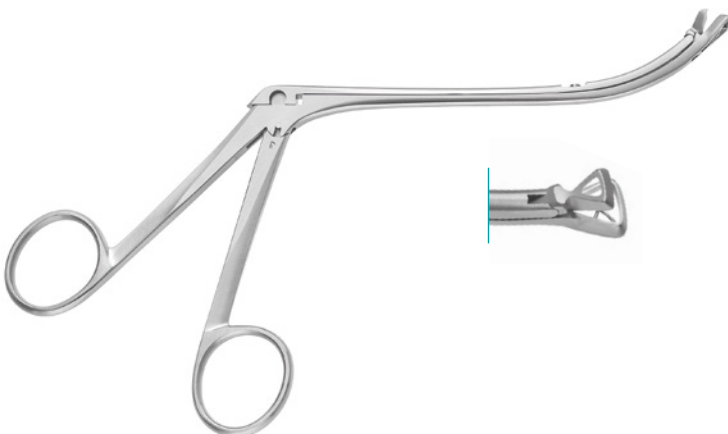

**RONIS**

Adenoid Forceps, through cutting, upcurved shaft, triangular bite, 130mm working length

Fig. 0, 6mm 420-391-000

Fig. 1, 7mm 420-391-001

Fig. 2, 8mm 420-391-002

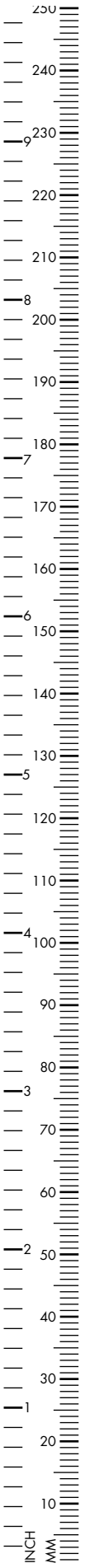

**KING**

Adenoid Forceps, through cutting, downcurved shaft, triangular bite, 130mm working length

Fig. 1, 7mm 420-391-115

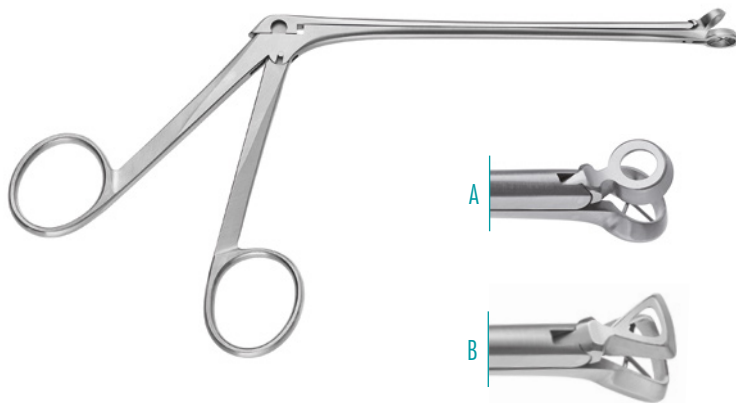

**MELZER**

**A** Adenoid Forceps, through cutting, round, 140mm, 5 1/2"

Fig. 1, 7mm 420-401-001  
Fig. 2, 8mm 420-401-002

**B** through cutting, triangular

Fig. 0, 6mm 420-401-100  
Fig. 1, 7mm 420-401-101  
Fig. 2, 8mm 420-401-102  
Fig. 3, 10mm 420-401-103

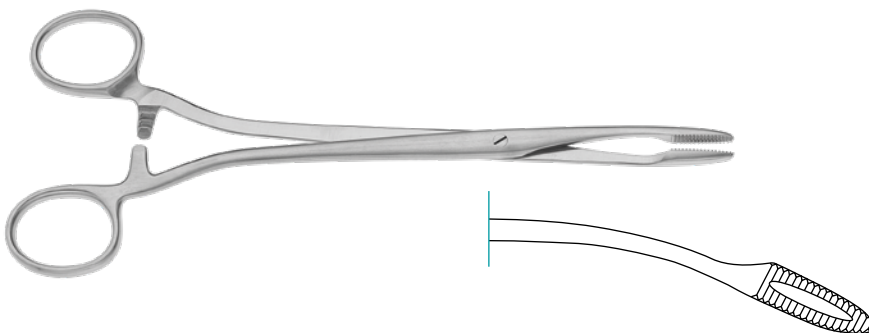

**DUPLAY**

Dressing Forceps, 200mm, 8"

straight 150-130-200  
curved 150-131-200

**DUPLAY**

Nasopharyngeal Sponge Holding Forceps,  
s-shaped

190mm, 7<sup>1</sup>/<sub>2</sub>"

420-398-190

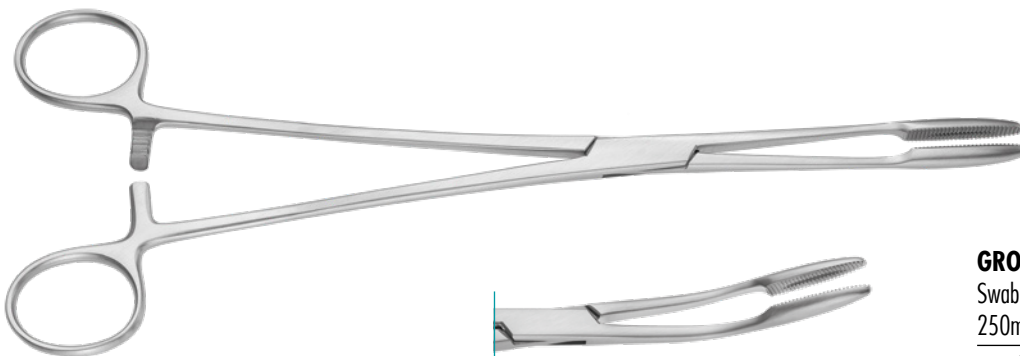
**GROSS MAIER**

Swab Forceps, serrated, straight,  
250mm, 9<sup>7</sup>/<sub>8</sub>"

straight

150-030-250

curved

150-031-250

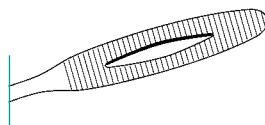
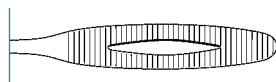

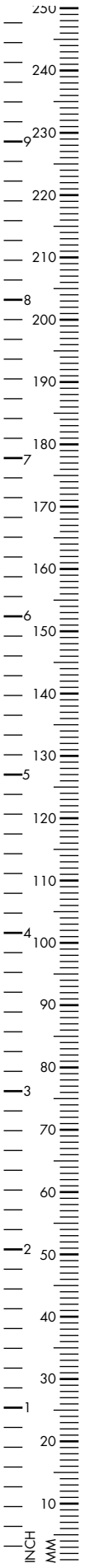

Dressing Forceps, serrated  
200mm, 8" 130-010-200



Standard Dressing Forceps, delicate, straight  
200mm, 8" 130-014-200



Tissue Forceps, 1x2 teeth  
200mm, 8" 130-110-200

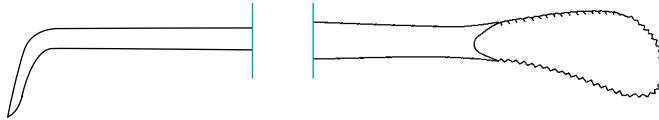

Tissue Forceps, 1x2 teeth, delicate  
200mm, 8" 130-120-200

**HENKE**

Tonsil Dissector / Pillar Retractor,  
235mm, 9<sup>1</sup>/<sub>4</sub>"

12mm	430-600-230
17mm	430-601-230

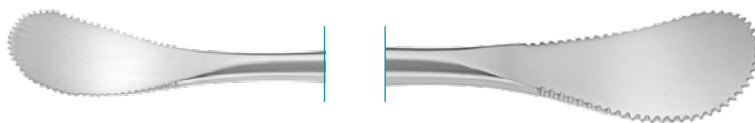
**HENKE**

Tonsil Dissector, double-ended  
12mm / 18mm

230mm, 9"	430-602-230
-----------	-------------

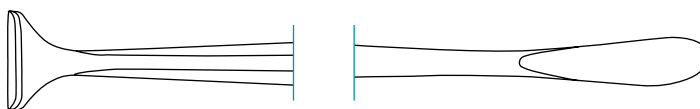
**HURD**

Tonsil Dissector / Pillar Retractor,  
215mm, 8<sup>1</sup>/<sub>2</sub>"

7.5mm	430-600-215
10mm	430-601-220

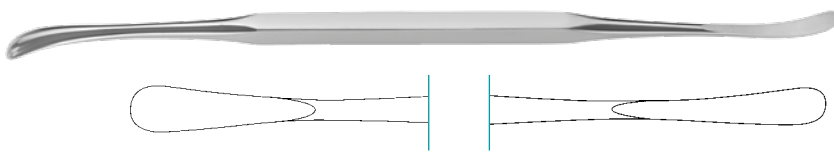
**ALDERDICE**

Tonsil Dissector

220mm, 8<sup>2</sup>/<sub>3</sub>"

430-510-220

**LOPEZ-REINKE**

Tonsil Suction Dissector

235mm, 9<sup>1</sup>/<sub>4</sub>"

430-670-235

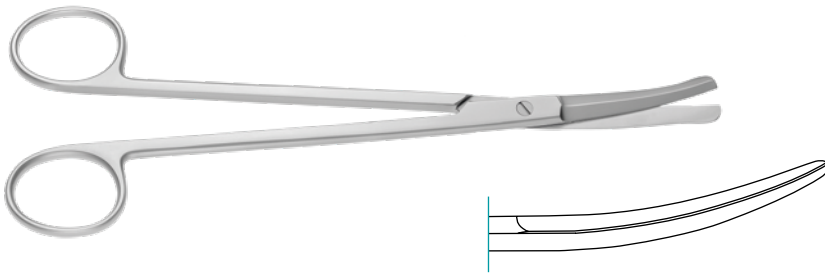

**GOOD**

Tonsil Scissors

190mm, 7<sup>1/2</sup>"

120-217-190

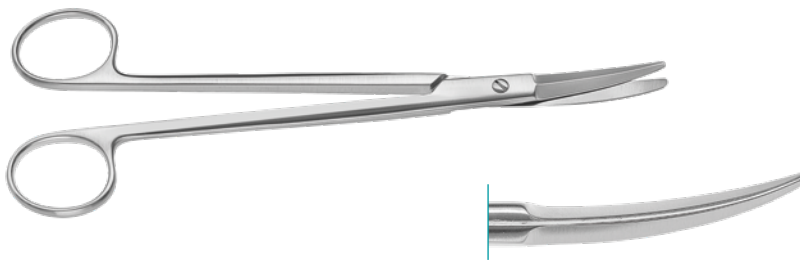
**PRINCE**

Tonsil Scissors

175mm, 6<sup>7/8</sup>"

120-213-175

**BOETTCHER**

Tonsil Scissors, sharp

180mm, 7"

120-207-180

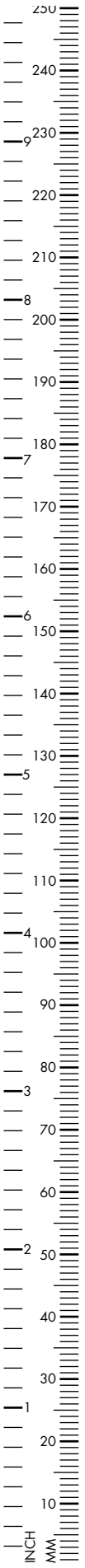

**BOETTCHER**

Tonsill Scissors, curved, 180mm, 7"

120-209-180

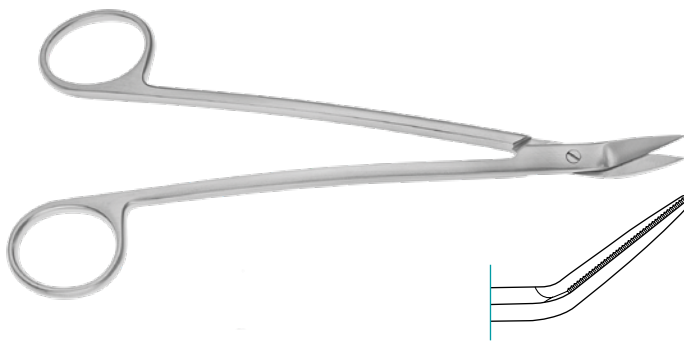

**DEAN**

Tonsil Scissors, angled upwards,  
serrated blades

170mm, 6<sup>2</sup>/<sub>3</sub>"

120-213-170

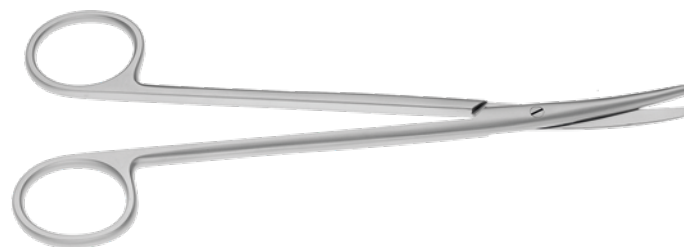

**METZENBAUM NELSON**

blunt, curved

180mm, 7"

120-111-180

200mm, 8"

120-111-200

230mm, 9"

120-111-230

Supercut

180mm, 7"

121-111-180

200mm, 8"

121-111-200

230mm, 9"

121-111-230

**TIVNEN-TYDING**

Tonsil Seizing Forceps, 3x3 teeth, 1 open ring

210mm, 8<sup>1/4</sup>" 430-631-002**LAHEY**

Goitre Seizing Forceps

200mm, 8" 440-030-200

**MUSEUX**

Tonsil Holding Forceps, 2x2 teeth

200mm, 8" 140-602-200

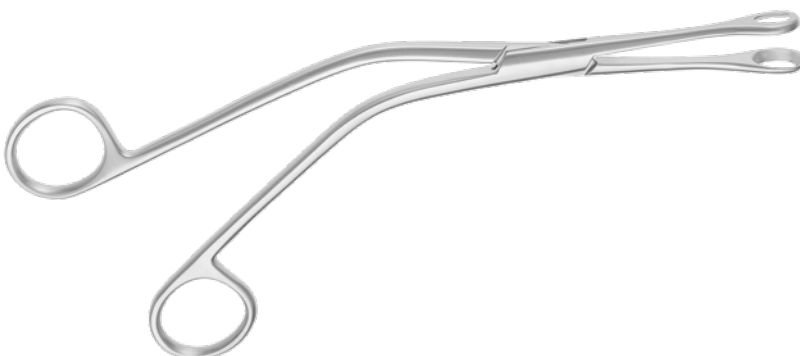
**DENIS-BROWNE**

Tonsil Holding Forceps, 10mm

200mm, 8" 420-427-200

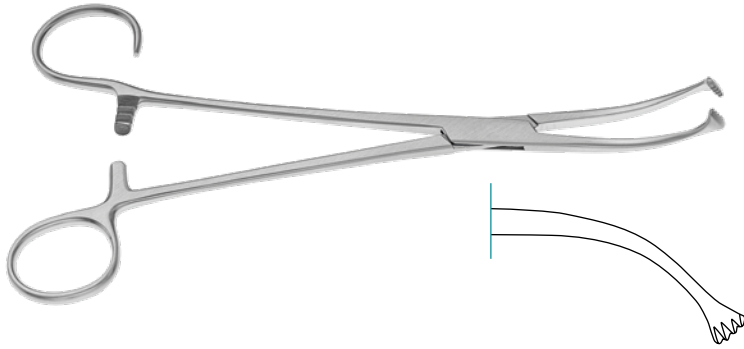
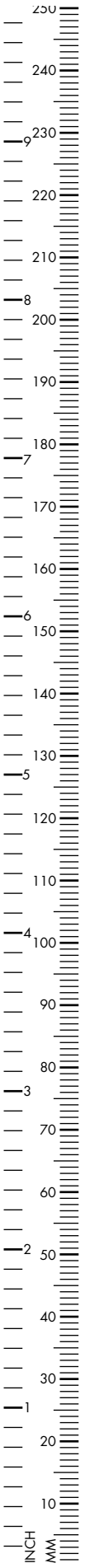

**COLVER**

Tonsil Seizing Forceps, curved

190mm, 7<sup>1</sup>/<sub>2</sub>"

140-626-190

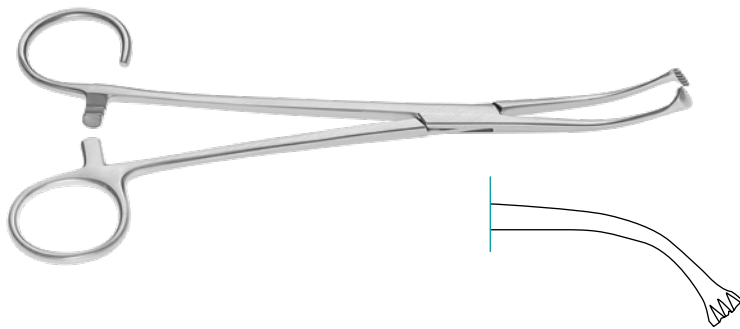

**WHITE**

Tonsil Holding Forceps

180mm, 7"

140-620-180

235mm, 9<sup>1</sup>/<sub>4</sub>"

140-620-235

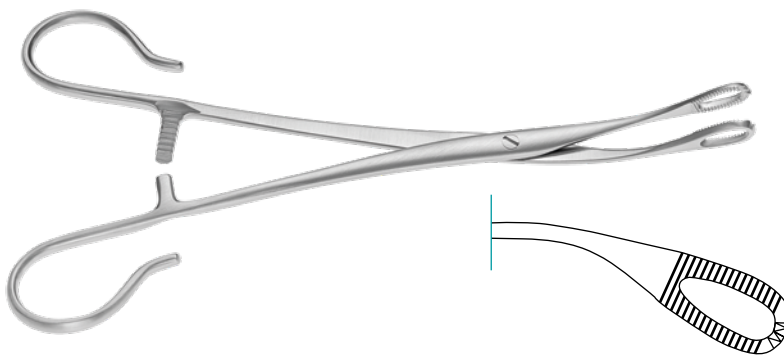

**BLOHMKE**

Tonsil Holding Forceps

200mm, 8"

140-625-200

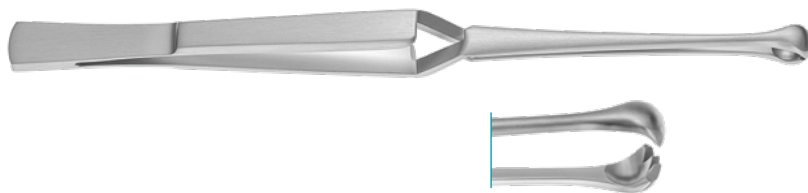

**MARSCHIK**

Tonsil Grasping Forceps

220mm, 8<sup>2</sup>/<sub>3</sub>"

430-620-220

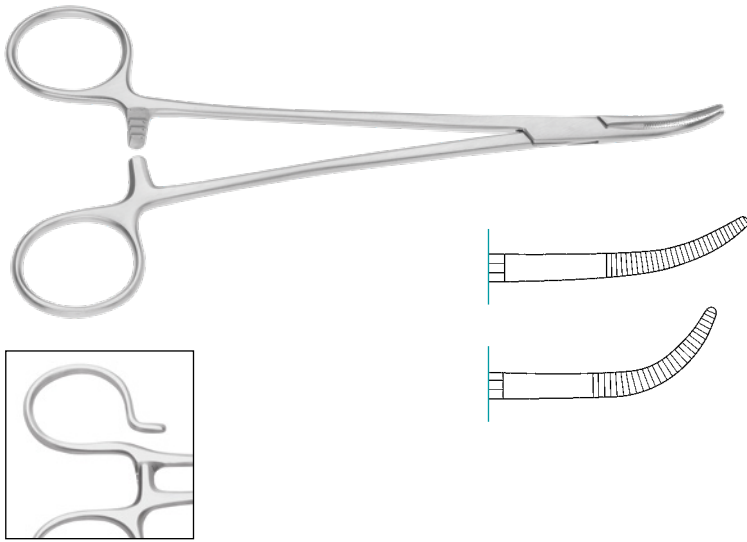

**SCHNIDT SAWTELL**

Tonsil Seizing Forceps, slightly curved

190mm, 7<sup>1/2</sup>" 140-628-190

strongly curved

190mm, 7<sup>1/2</sup>" 140-629-190

slightly curved, with one open ring

190mm, 7<sup>1/2</sup>" 140-630-190

strongly curved, with one open ring

190mm, 7<sup>1/2</sup>" 140-631-190

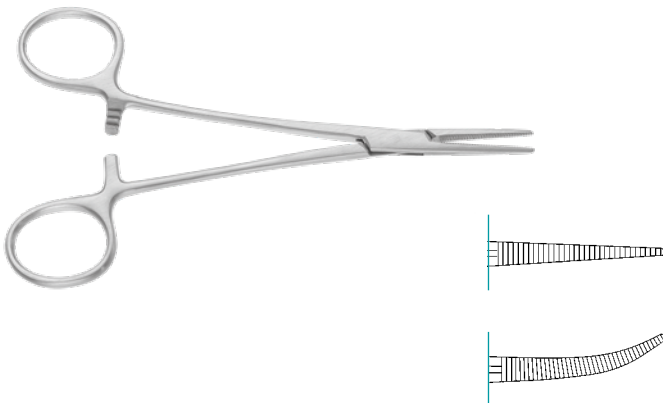

**HALSTEAD MOSQUITO**

Hemostatic Forceps, serrated, 180mm, 7"

straight 140-254-180

curved 140-255-180

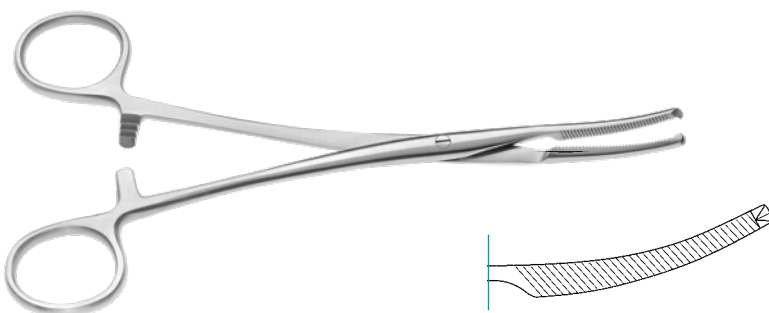

**MIKULICZ**

Peritoneal Forceps, curved, 1x2 teeth

180mm, 7" 140-548-180

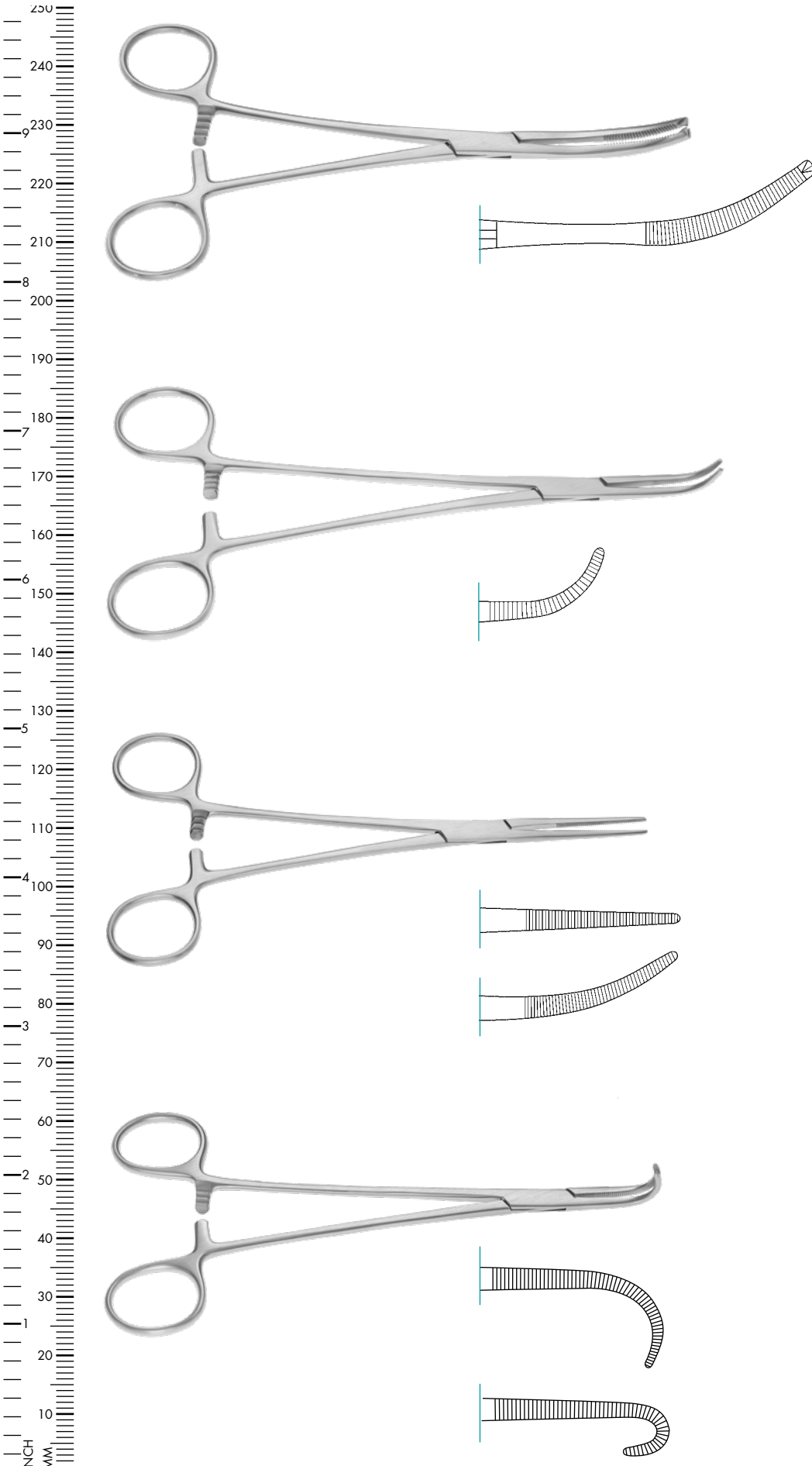

**MIKULICZ**

Peritoneal Forceps, strongly curved, 1x2 teeth  
200mm, 8" 140-549-200

**OVERHOLT**

Dissecting and Ligature Forceps,  
fully serrated, curved  
Fig. 0, 195mm, 7<sup>3/4</sup>" 140-443-001

**BIRKETT**

Hemostatic Forceps, serrated, 185mm, 7<sup>1/4</sup>"  
straight 140-368-185  
curved 140-369-185

**NEGUS**

Tonsil Artery Forceps, serrated, 190mm, 7<sup>1/2</sup>"  
slightly curved 140-625-190  
strongly curved 140-627-190

**BRUENINGS**

Tonsil Snare

270mm, 10<sup>2</sup>/<sub>3</sub>"

430-605-270

**EVES**

Tonsil Snare with ratchet

285mm, 11<sup>1</sup>/<sub>4</sub>"

430-604-280

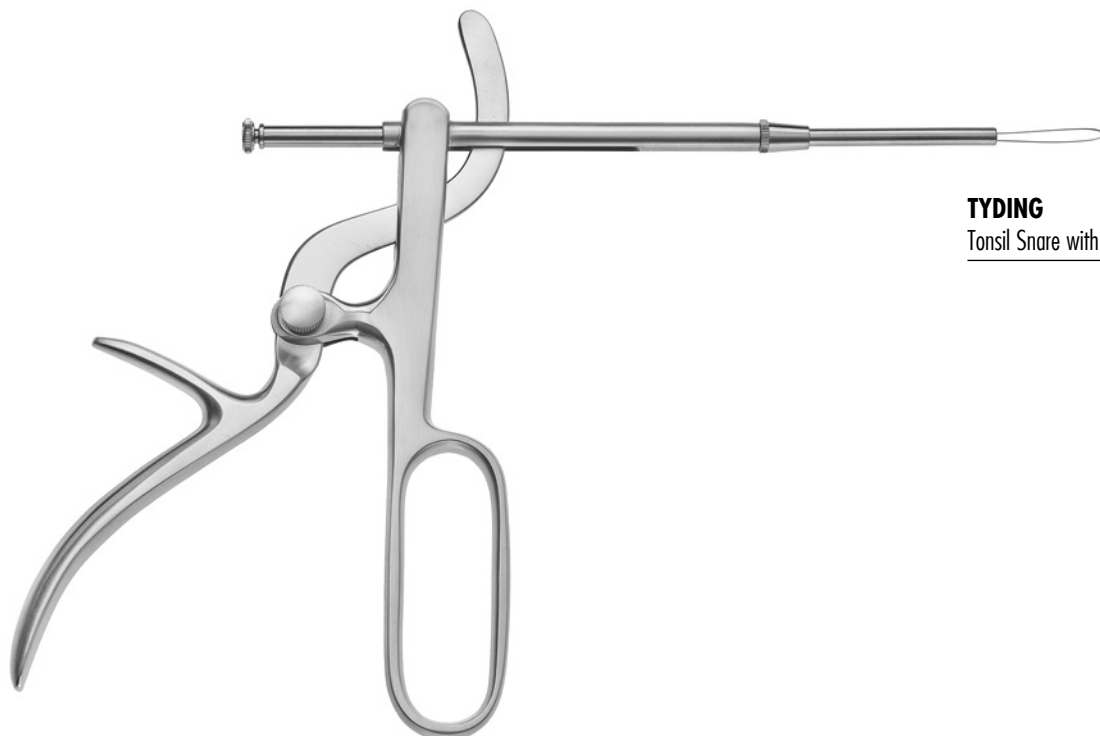
**TYDING**

Tonsil Snare with detachable straight tip

430-620-000

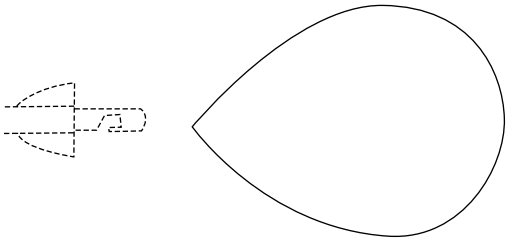
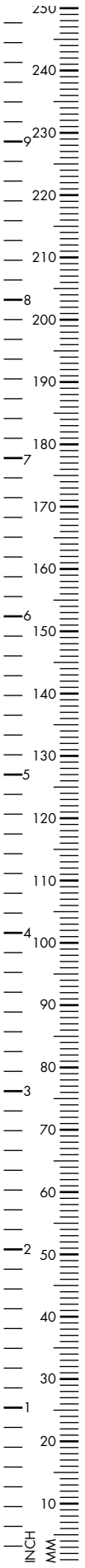

Wire Loop, package of 100 pieces

Ø 0.4mm x 40mm	430-606-040
Ø 0.4mm x 50mm	430-607-040



Wire Cutting Scissors, serrated,  
120mm, 4<sup>3/4</sup>"

	120-265-120
TC	120-565-120

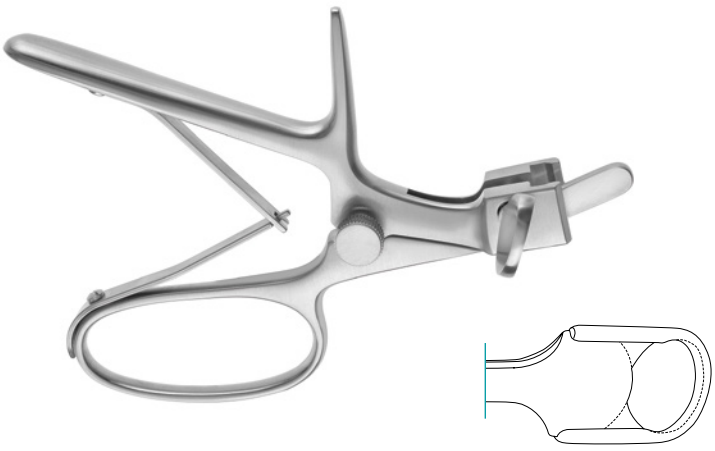

**SLUDER-BALLENGER**

Tonsillotome Handle for blades  
430-650-001 - 430-650-003

	430-650-100
--	-------------

Blades

Fig. 1	430-650-001
Fig. 2	430-650-002
Fig. 3	430-650-003

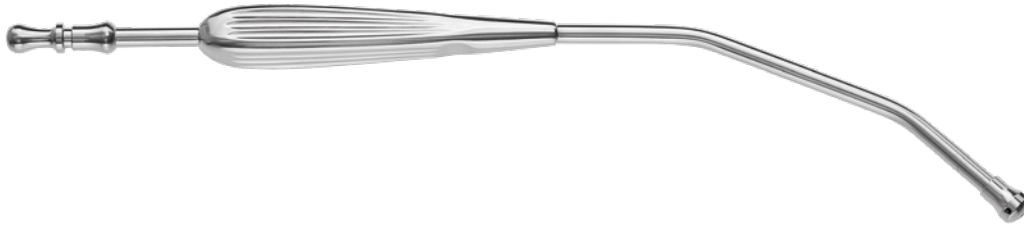

**YANKAUER**

Suction Tube

270mm, 10<sup>7/8</sup>"

165-543-270

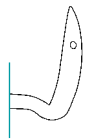
**HURD**Ligature Needle, 210mm, 8<sup>1/4</sup>"

right

180-719-210

left

180-718-210

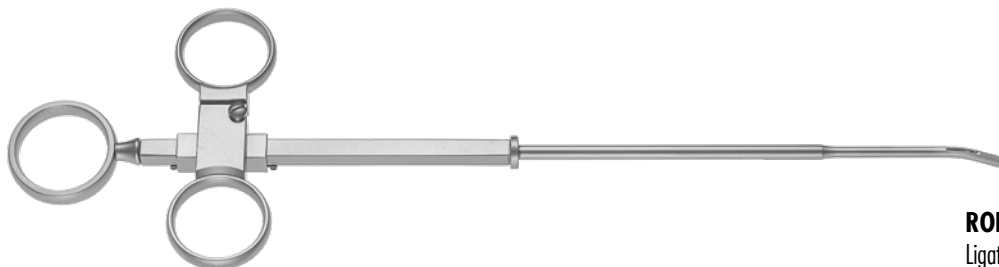
**ROEDER**

Ligature Instrument

260mm, 10<sup>1/4</sup>"

430-500-260

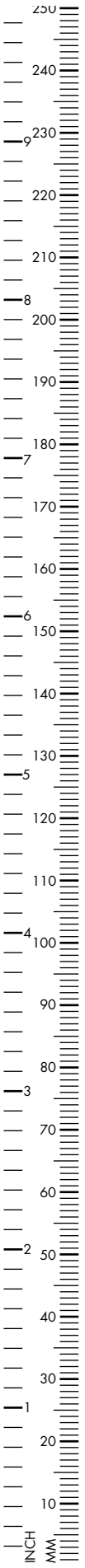

**NEGUS**

Knot Tier

205mm, 8<sup>1</sup>/<sub>8</sub>"

430-505-205



**LUNIATSCHEK**

Gauze Packer, 2mm

190mm, 7<sup>1</sup>/<sub>2</sub>"

430-602-175



**HARTMANN**

Postnasal Applicator, spiral end, Ø 2.3mm

220mm, 8<sup>2</sup>/<sub>3</sub>"

160-481-200

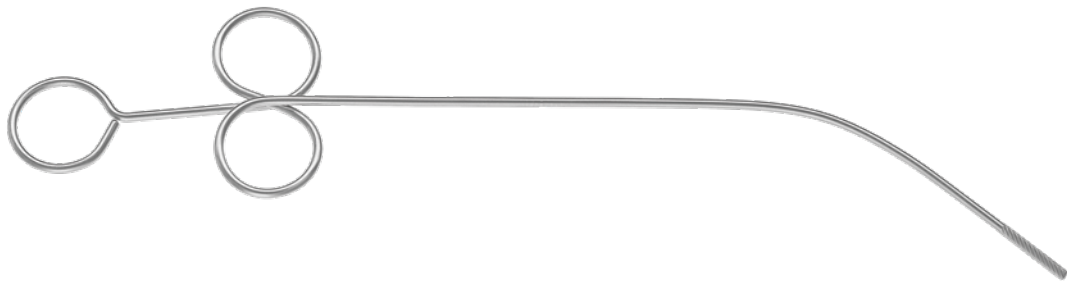

**FEIN**

Postnasal Applicator

280mm, 11"

160-495-280



Laryngeal Mirror, hexagonal handle,  
180mm, 7"

∅ 18mm, Fig. 4	230-330-018
∅ 16mm, Fig. 3	230-330-016
∅ 14mm, Fig. 2	230-330-014
∅ 12mm, Fig. 1	230-330-012
∅ 10mm, Fig. 0	230-330-010
∅ 8mm, Fig. 00	230-330-008
∅ 6mm, Fig. 000	230-330-006
∅ 30mm, Fig. 10	230-330-030
∅ 28mm, Fig. 9	230-330-028
∅ 26mm, Fig. 8	230-330-026
∅ 24mm, Fig. 7	230-330-024
∅ 22mm, Fig. 6	230-330-022
∅ 20mm, Fig. 5	230-330-020



Laryngeal mirror, insert only,  
120mm, 4<sup>3/4</sup>"

∅ 18mm, Fig. 4	230-329-018
∅ 16mm, Fig. 3	230-329-016
∅ 14mm, Fig. 2	230-329-014
∅ 12mm, Fig. 1	230-329-012
∅ 10mm, Fig. 0	230-329-010
∅ 8mm, Fig. 00	230-329-008
∅ 6mm, Fig. 000	230-329-006
∅ 30mm, Fig. 10	230-329-030
∅ 28mm, Fig. 9	230-329-028
∅ 26mm, Fig. 8	230-329-026
∅ 24mm, Fig. 7	230-329-024
∅ 22mm, Fig. 6	230-329-022
∅ 20mm, Fig. 5	230-329-020



Mirror Handle with set screw

110mm, 4 <sup>1/3</sup> "	230-331-110
---------------------------	-------------

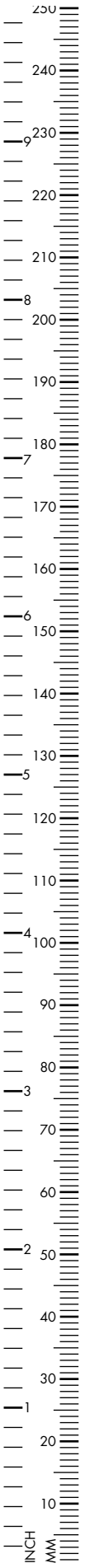

**MICHEL**

Rhinoscopic mirror with interchangeable mirror inserts, 250mm, 9<sup>7</sup>/<sub>8</sub>"

Ø 12mm	430-788-012
Ø 14mm	430-788-014
Ø 16mm	430-788-016
Ø 18mm	430-788-018

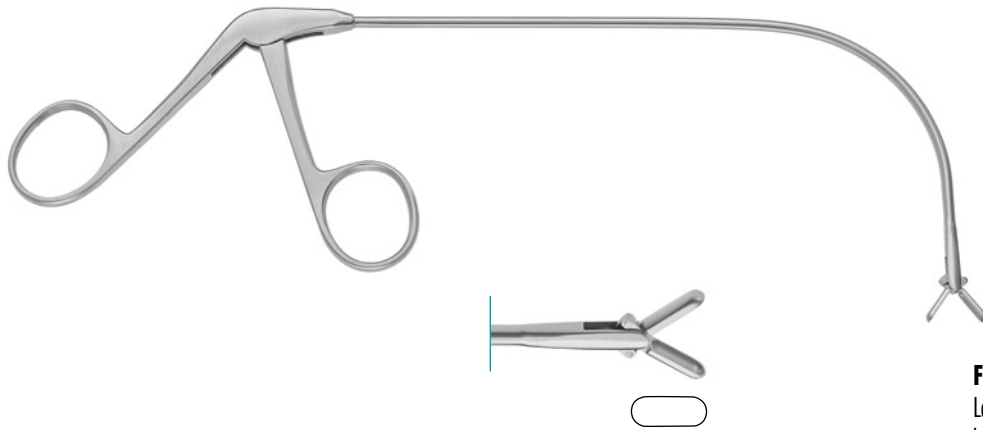

**FRAENKEL**

Laryngeal Forceps, double action, longitudinal oval jaws

170mm, 6 <sup>2</sup> / <sub>3</sub> "	430-813-050
--	-------------

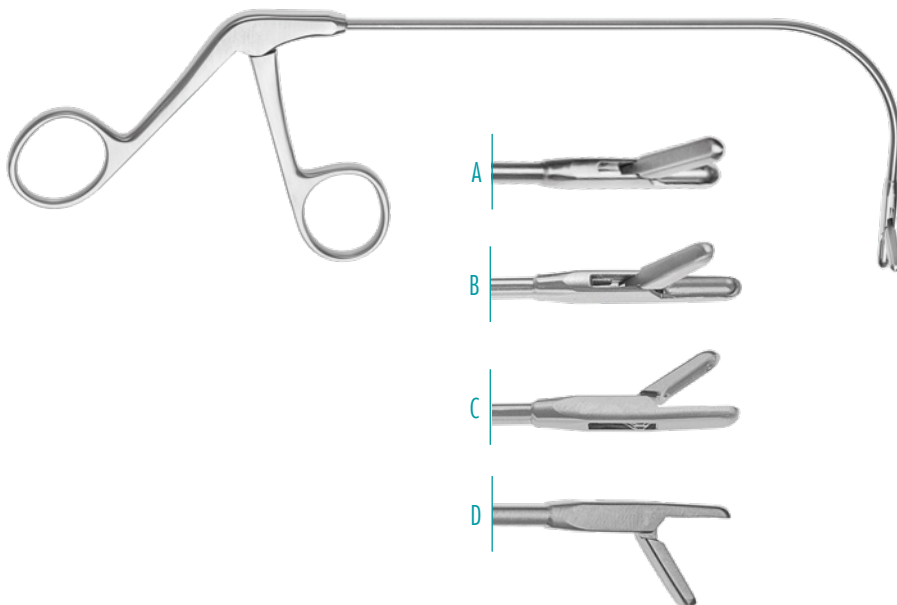

**JURASZ**

Laryngeal Polypus Forceps, 220mm, 8<sup>2</sup>/<sub>3</sub>"

A opening to right	430-813-010
B opening to left	430-813-020
C opening downwards	430-813-030
D opening upwards	430-813-040

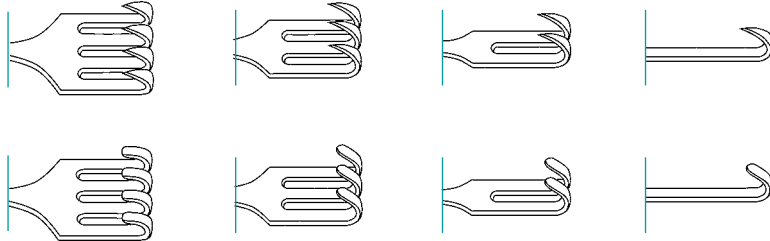

Hand Held Retractor, 160mm, 6<sup>1</sup>/<sub>4</sub>"  
sharp

1 prong	170-074-161
2 prongs	170-074-162
3 prongs	170-074-163
4 prongs	170-074-164

blunt

1 prong	170-075-161
2 prongs	170-075-162
3 prongs	170-075-163
4 prongs	170-075-164

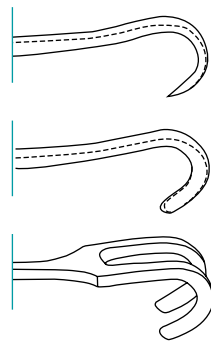

Tracheal Hook, 160mm, 6<sup>1</sup>/<sub>4</sub>"

sharp	170-005-001
blunt	170-005-002
2 prongs, blunt	170-005-003



**LABORDE**

Tracheal Dilator

140mm, 5 <sup>1</sup> / <sub>2</sub> "	440-130-140
--	-------------

**TROUSSEAU**

Tracheal Dilator

120mm, 4<sup>3</sup>/<sub>4</sub>" 440-120-120140mm, 5<sup>1</sup>/<sub>2</sub>" 440-120-140**KOCHER**

Goitre Director with hole

160mm, 6<sup>1</sup>/<sub>4</sub>" 440-221-160

# LARYNGOSCOPY



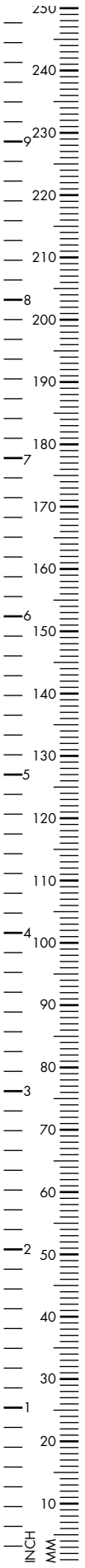

Naso-Pharyngo-Laryngoscope, flexible,  
300mm working length

Ø 2.2mm	100-500-220
Ø 2.8mm	100-500-280
Ø 3.2mm	100-500-320
Ø 3.4mm	100-500-340



Naso-Pharyngo-Laryngoscope, flexible,  
300mm working length,  
with working channel

Ø 2.8mm	100-500-285
Ø 1.2mm working channel	
Ø 3.8mm	100-500-385
Ø 1.4mm working channel	