

RING HANDLE INSTRUMENTS

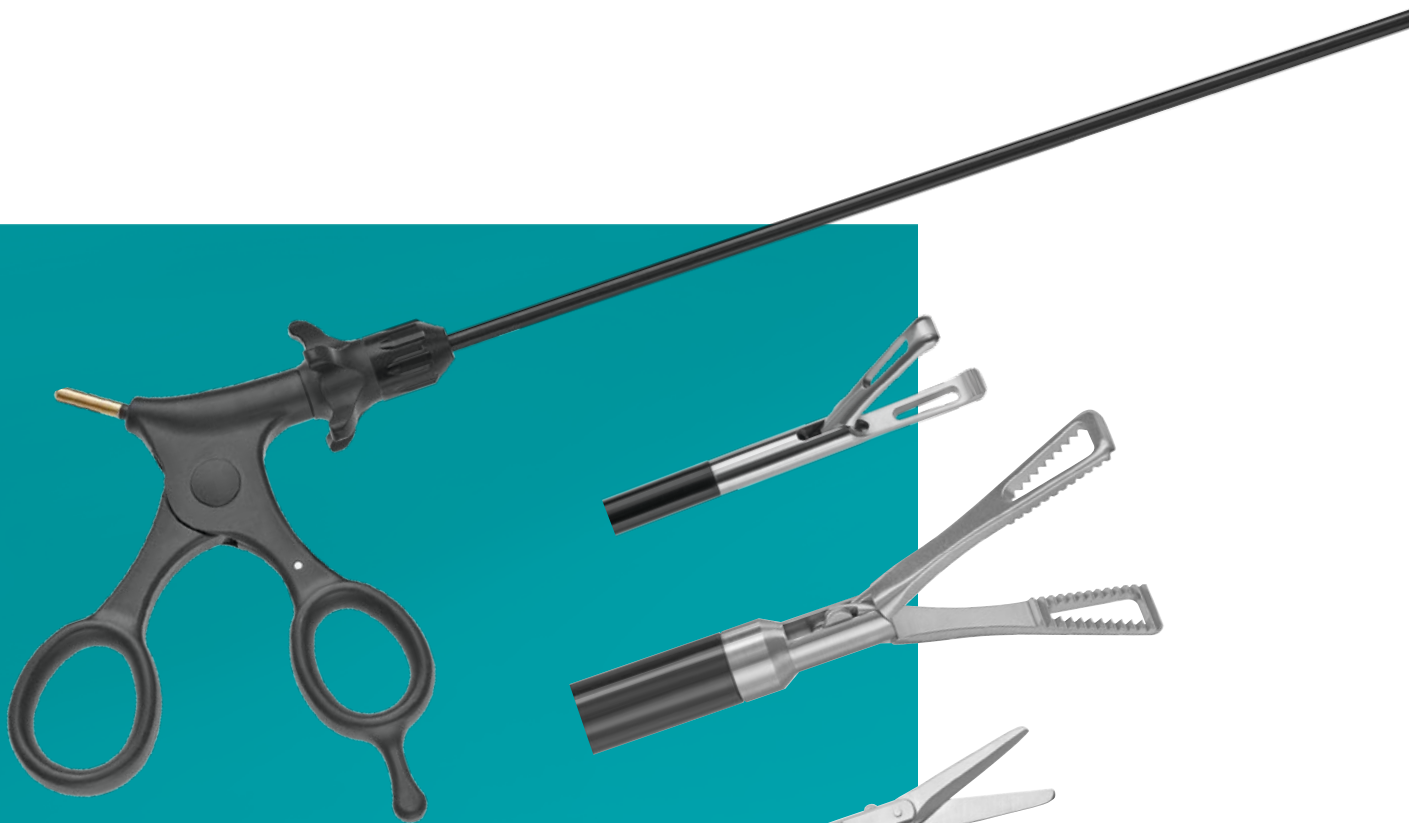

Handles



300-750-101*
PEEK Polymer Handle with
HF - connection



300-750-103*
PEEK Polymer Handle with ratchet
and HF - connection



300-750-105*
PEEK Polymer Handle with hook up
ratchet and HF - connection



300-750-106*
PEEK Polymer Handle with swing-away
ratchet, rotatable and HF - connection



300-750-001
Carbon Fiber Handle, rotating,
HF - connection



300-750-003
Carbon Fiber Handle, rotating,
with ratchet, HF - connection



300-750-015
Axial Handle with catch for needle holder
fixed, for all needle holder inserts,
with two gold rings

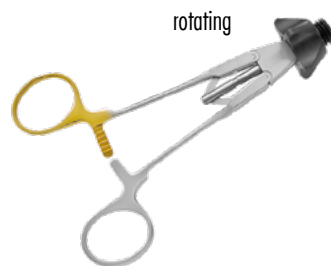

300-750-115
Axial Handle with catch, rotating,
for standard instrument,
with one golden ring



300-750-215
Axial Handle without catch,
non rotating, for standard instrument,
with two gold rings

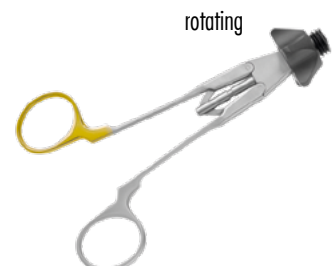

300-750-315
Axial Handle without catch, rotating,
for standard instrument, with one gold ring



Outer Sheath, insulated, adaptable to all handles, Ø 5 mm

210 mm 300-550-005
 330 mm 300-660-005*
 450 mm 300-760-005*

- exchangeable color coding locking nuts
- advantages in handling and cleaning
- strengthening of the shaft through a partial thickening at the proximal end



Outer Sheath, insulated, adaptable to all handles, Ø 10 mm

210 mm 300-550-010
 330 mm 300-660-010*
 450 mm 300-760-010*



Outer Sheath, insulated, adaptable to all handles, with LuerLock

Ø 5 mm 210 mm 300-550-105
 Ø 10 mm 210 mm 300-550-110
 Ø 5 mm 330 mm 300-660-105
 Ø 10 mm 330 mm 300-660-110
 Ø 5 mm 450 mm 300-760-105
 Ø 10 mm 450 mm 300-760-110



300-400-900
 Rubber Seals for LuerLock connectors
 sales unit: 5 pcs.

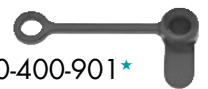

300-400-901*
 Rubber Seals for LuerLock connectors
 sales unit: 5 pcs.



Locking Nuts

300-661-005 5mm ●
 300-661-010 10mm ●
 300-661-006 5mm ●
 300-661-007 5mm ●
 300-661-008 5mm ●
 300-661-004 5mm ●
 300-661-009 3.5mm* ●



300-661-006OR
 Sealing ring, package of
 10 pieces,
 autoclavable

* for 3.5mm Mini Laparoscopy instruments



3-PIECE MODULAR INSTRUMENT

- Long-life and reliable materials
- Large variety of handle designs
- Ratchet mechanism / deactivation

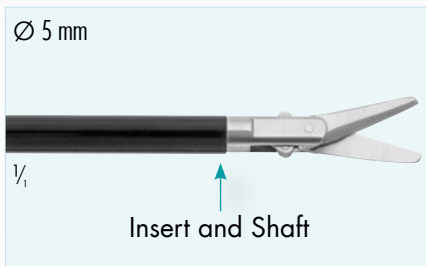

insert only

300-400-067

Insert's Catalogue-No.

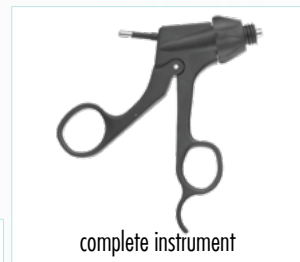

300-410-067

Catalogue-No. of the
complete Instrument



300-420-067

Catalogue-No. of the
complete Instrument

*Each piece can be ordered separately

*Each piece can be ordered separately



Watch the video on
YouTube



The RZ spherical head
locking system for fast
assembling / disassembling



Modular 3-piece detachable instrument system consists of:

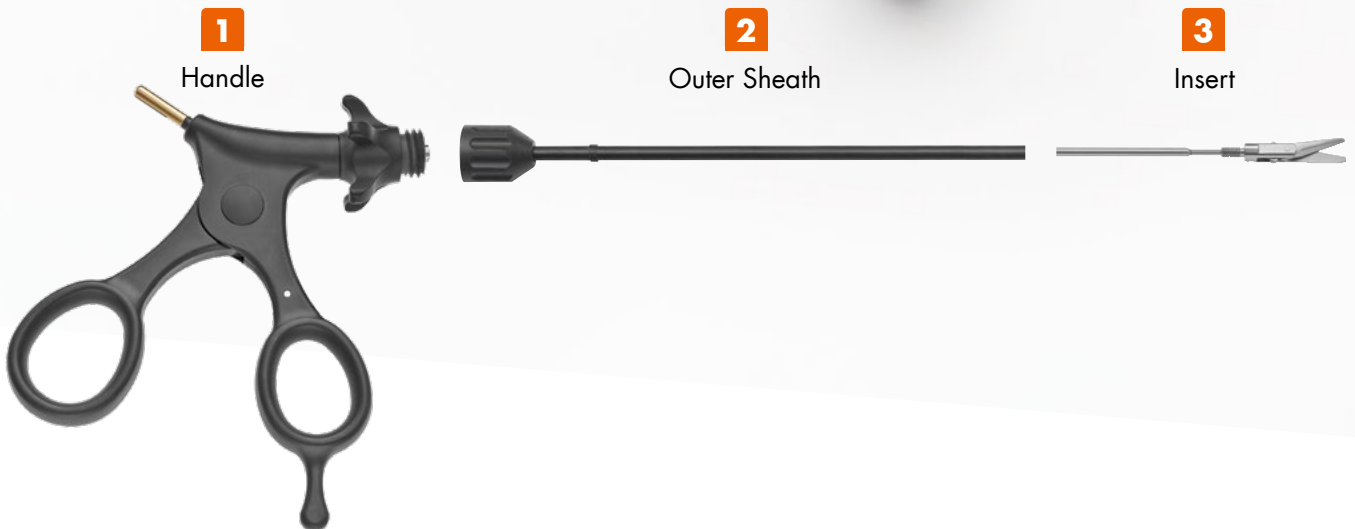

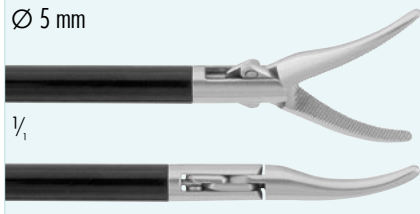

Catalogue-No. for insert only

300-400-732*



Complete Instrument
with handle 300-750-001

300-410-732



Complete Instrument
with handle 300-750-101

300-420-732*

KELLY

Dissecting forceps curved, slightly tapered, cross-serrated jaws, wide opening, double action, Ø 5 mm, 330 mm

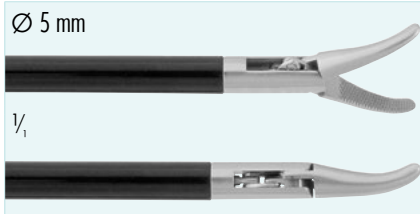

300-400-733

300-410-733

300-420-733

BABY KELLY

Short dissecting and suturing forceps, curved, tapered, cross-serrated jaws, wide opening, double action, Ø 5 mm, 330 mm

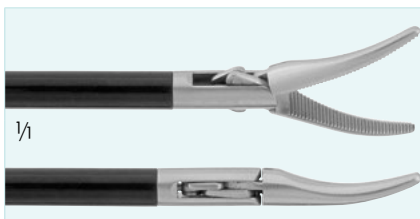

300-400-731*

300-410-731

300-420-731*

MARYLAND

Extra fine dissector with slightly tapered tip and gently curved for precise dissection, Ø 5 mm, 330 mm



300-400-738*

300-410-738

300-420-738*

MIXTER

Fine dissecting forceps, 90° angled, fine serrated jaws, double action, Ø 5 mm, 330 mm

Ø 5 mm



1/1

insert only

300-400-735*



Complete Instrument
with handle 300-750-001

300-410-735



Complete Instrument
with handle 300-750-101

300-420-735*

RIGHT ANGLE

Dissecting grasping forceps, fine serrated jaws, double action, Ø 5 mm, 330 mm

Ø 10 mm

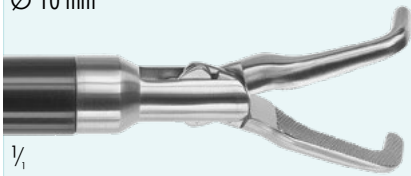

1/1

300-400-736*

300-410-736

300-420-736*

RIGHT ANGLE

Dissecting grasping forceps, fine serrated jaws, double action, Ø 10 mm, 330 mm

Ø 10 mm

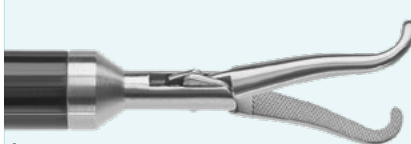

1/1

300-400-741

300-410-741

300-420-741

OVERHOLT

Dissecting forceps 90° angled jaws, double action, Ø 10 mm, 330 mm

Ø 10 mm



1/1

300-400-740

300-410-740

300-420-740

MIXTER

Dissecting forceps, 10 mm long tip, 90° angled jaws, double action, Ø 10 mm, 330 mm

Ø 5 mm



1/1

300-400-027

300-410-027

300-420-027

PETELIN

Dissecting forceps, single action jaws, angled 60° left. deep serrations, Ø 5 mm, 330 mm

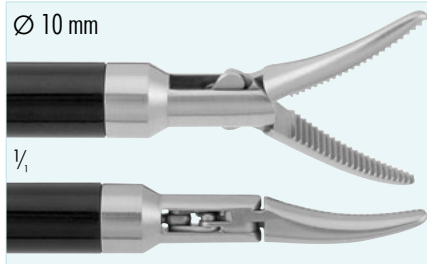

insert only
300-400-730

 Complete Instrument with handle 300-750-001
300-410-730

 Complete Instrument with handle 300-750-101
300-420-730

MARYLAND
Dissecting forceps curved left, blunt jaws, double action, Ø 10 mm, 330 mm

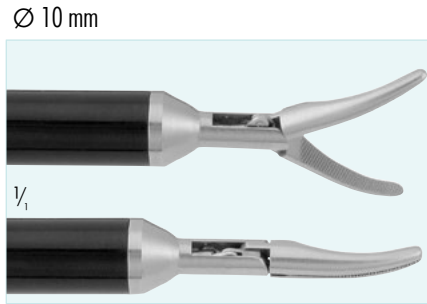

300-400-734

300-410-734

300-420-734

MIXTER 45°
Dissecting forceps curved with long fine serrated jaws, double action, Ø 10 mm, 330 mm

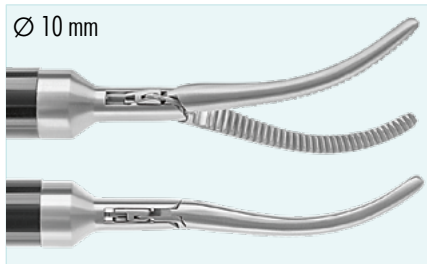

300-400-737

300-410-737

300-420-737

OVERHOLT-MIXTER
Dissecting forceps curved with slim long serrated jaws, double action, Ø 10 mm, 330 mm



300-400-739*

300-410-739

300-420-739*

MIXTER 90°
Dissecting forceps 90° angled, serrated jaws, double action, Ø 10 mm, 330 mm



insert only
300-400-044

Complete Instrument
with handle 300-750-001
300-410-044

Complete Instrument
with handle 300-750-101
300-420-044

ADHESION FORCEPS

Serrated jaws, one fenestrated, double action, Ø 5 mm, 330 mm



300-400-109

300-410-109

300-420-109

GRASPING FORCEPS

1x2 teeth, single action, Ø 5 mm, 330 mm

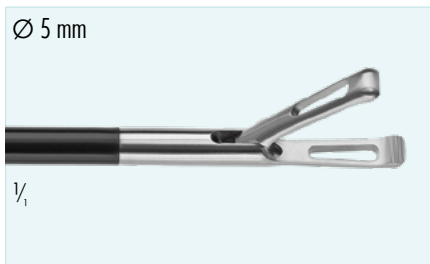

300-400-251*

300-410-251

300-420-251*

BABCOCK

Grasping forceps, single action, Ø 5 mm, 330 mm

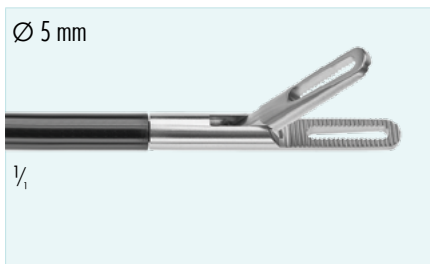

300-400-023

300-410-023

300-420-023

JOHANS

Grasping forceps, fenestrated jaws, serrated, 12mm, single action, Ø 5 mm, 330 mm

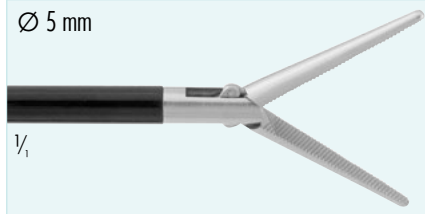

insert only
300-400-016*



300-410-016



300-420-016*

NEEDLE NOSE

Dissecting and grasping forceps with tapered and fine, cross-serrated jaws, double action, Ø 5 mm, 330 mm



300-400-003

300-410-003

300-420-003

NEEDLE NOSE

Dissecting and grasping forceps with tapered and fine, cross-serrated jaws, single action, Ø 5 mm, 330 mm



300-400-040

300-410-040

300-420-040

FENESTRATED BULLNOSE

Dissecting and grasping forceps with delicate, fenestrated and flat jaws, deep serration, double action, Ø 5 mm, 330 mm

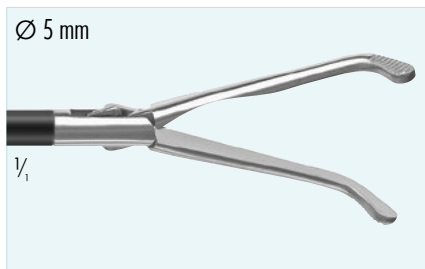

300-400-610

300-430-610

300-440-610

PYLORUS

Spreader, double action, Ø 5 mm, 330 mm



insert only



300-400-025*

300-410-025

300-420-025*

300-430-025

300-440-025*

DOLPHIN

Dissecting and grasping forceps with biopsy cup and fine serrated and tapered jaws, double action, Ø 5 mm, 330 mm



insert only
300-400-012*

Complete Instrument
with handle 300-750-003
300-430-012

Complete Instrument
with handle 300-750-103
300-440-012*

JAEGER
Grasping forceps with fenestrated jaws, DeBakey serration, 20 mm, double action, Ø 5 mm, 330 mm

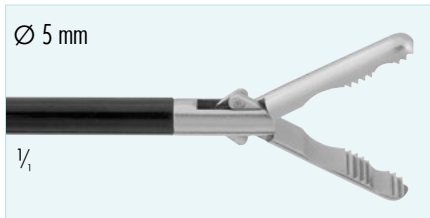

300-400-015*

300-430-015

300-440-015*

FUNDUS
Grasping forceps with 2 cups and serrated jaws, double action, Ø 5 mm, 330 mm



300-400-005

300-430-005

300-440-005

BULLDOG
Grasping forceps with fine serrated jaws, single action, Ø 5 mm, 330 mm

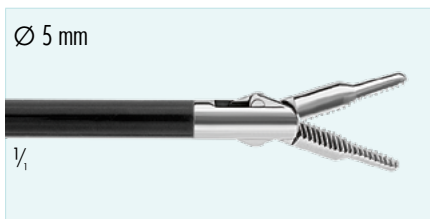





300-400-021

300-430-021

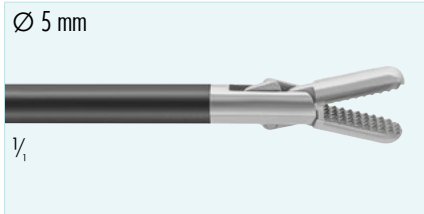
300-440-021

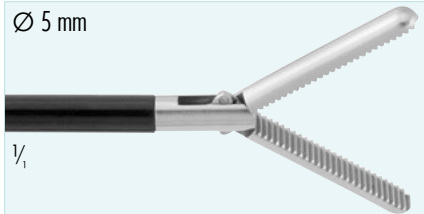
DOLPHIN
Grasping and dissecting forceps with fine serrated tapered jaws, double action, Ø 5 mm, 330 mm

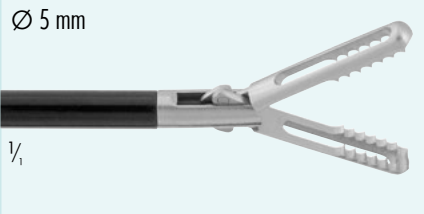

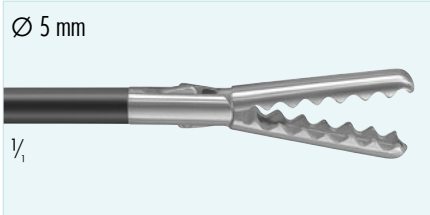
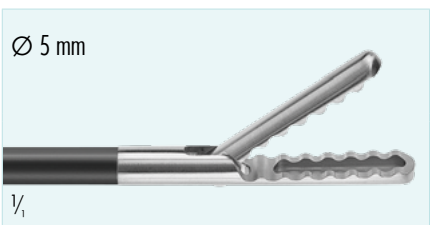
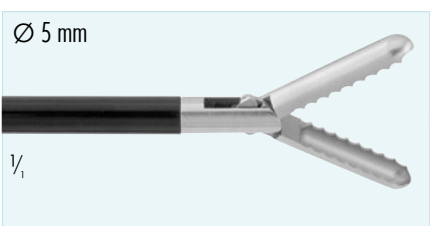

	insert only	Complete Instrument with handle 300-750-003	Complete Instrument with handle 300-750-103	Complete Instrument with handle 300-750-105
 <p>Ø 5 mm 1/1</p>	300-400-001*	300-430-001	300-440-001*	300-460-001*
BULLNOSE Grasping forceps, heavy pattern, standard serrated jaws, double action, Ø 5 mm, 330 mm				
 <p>Ø 5 mm 1/1</p>	300-400-008	300-430-008	300-440-008	300-460-008
STRONG TC GRASPER Grasping forceps with Tungsten Carbide jaw inserts, heavy pattern, pyramidal tip, serrated jaws, double action, Ø 5 mm, 330 mm				
 <p>Ø 5 mm 1/1</p>	300-400-029*	300-430-029	300-440-029*	300-460-029*
STRONG TC GRASPER Grasping forceps with Tungsten Carbide jaw inserts, heavy pattern, pyramidal tip, serrated, 15 mm long jaws, double action, Ø 5 mm, 330 mm				
 <p>Ø 5 mm 1/1</p>	300-400-002	300-430-002	300-440-002	300-460-002
XL BULLNOSE Grasping forceps, standard serrated jaws, double action, Ø 5 mm, 330 mm				
 <p>Ø 5 mm 1/1</p>	300-400-000	300-430-000	300-440-000	300-460-000
STANDARD Grasping forceps with biopsy cup, heavy pattern, standard serrated jaws, double action, Ø 5 mm, 330 mm				
 <p>Ø 5 mm 1/1</p>	300-400-017*	300-430-017	300-440-017*	300-460-017*
GRIPPER #1 Grasping forceps with coarse-serrated, fenestrated jaws, double action, Ø 5 mm, 330 mm				

	insert only	Complete Instrument with handle 300-750-003	Complete Instrument with handle 300-750-103	Complete Instrument with handle 300-750-105
 <p>Ø 5 mm 1/1</p> <p>PRESTIGE Atraumatic grasping forceps with long, wave shaped jaws and deep cup with lateral serration, double action, Ø 5 mm, 330 mm</p>	300-400-013*	300-430-013	300-440-013*	300-460-013*
 <p>Ø 5 mm 1/1</p> <p>PRESTIGE Grasping Forceps, wave-shaped lateral serration, and deep cup, single action, atraumatic, Ø 5 mm, 330 mm</p>	300-400-033*	300-430-033	300-440-033*	300-460-033*
 <p>Ø 5 mm 1/1</p> <p>ALLIGATOR Grasping forceps with fine sharp lateral teeth and deep cup, double action, Ø 5 mm, 330 mm</p>	300-400-053	300-430-053	300-440-053	300-460-053

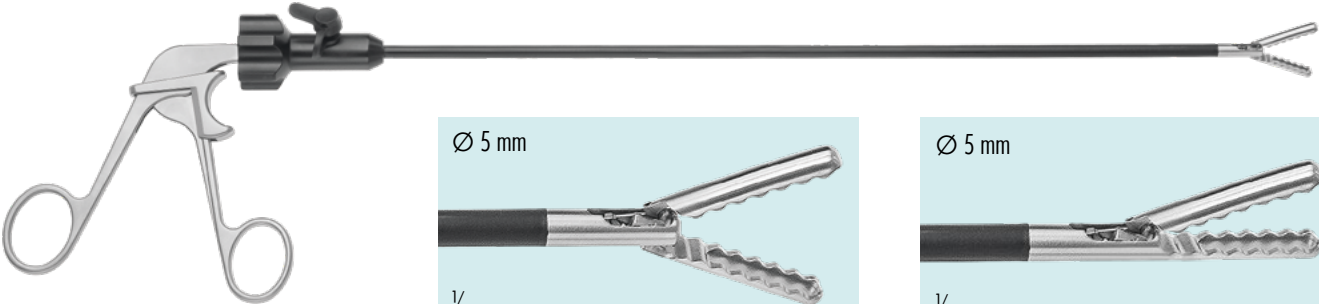
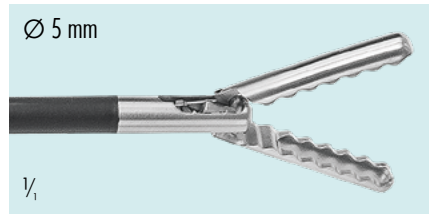
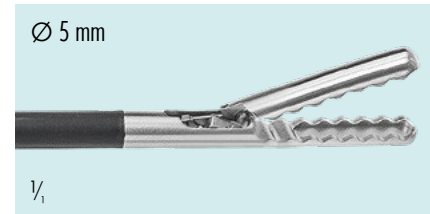
NON-DETACHABLE PRESTIGE FORCEPS

Complete Instrument, rotating, insulated, with prestige handle and Luer-Lock connection, 330mm working length

	 <p>Ø 5 mm 1/1</p> <p>300-111-013 Double action jaws</p>	 <p>Ø 5 mm 1/1</p> <p>300-111-033 Single action jaws</p>
--	---	---

	insert only	Complete Instrument with handle 300-750-003	Complete Instrument with handle 300-750-103	Complete Instrument with handle 300-750-105
 <p>Ø 5 mm 1/1</p> <p>KOCHER Grasping forceps with aggressive 3 x 4 teeth and serrated inner jaws, double action, Ø 5 mm, 330 mm</p>	300-400-004*	300-430-004	300-440-004*	300-460-004*
 <p>Ø 5 mm 1/1</p> <p>KOCHER Grasping forceps with aggressive 2 x 4 teeth and serrated inner jaws, single action, Ø 5 mm, 330 mm</p>	300-400-006	300-430-006	300-440-006	300-460-006
 <p>Ø 5 mm 1/1</p> <p>ALLIS Grasping forceps with 1 x 2 teeth and smooth inner jaws, single action, Ø 5 mm, 330 mm</p>	300-400-014	300-430-014	300-440-014	300-460-014
 <p>Ø 5 mm 1/1</p> <p>ALLIS Grasping forceps with 1 x 2 teeth and serrated inner jaws, double action, Ø 5 mm, 330 mm</p>	300-400-009	300-430-009	300-440-009	300-460-009
 <p>Ø 5 mm 1/1</p> <p>COBRA Grasping forceps with sharp 2 x 4 teeth and serrated inner jaws, double action, Ø 5 mm, 330 mm</p>	300-400-201*	300-430-201	300-440-201*	300-460-201*



insert only
300-400-011*

Complete Instrument
with handle 300-750-003
300-430-011

Complete Instrument
with handle 300-750-103
300-440-011*

Complete Instrument
with handle 300-750-105
300-460-011*

MARTIN

Grasping forceps with multiple fine serrations, 4.8 mm wide jaws, single action, Ø 5 mm, 330 mm



300-400-713*

300-430-713

300-440-713*

300-460-713*

CLAW GRASPER

Grasping forceps, aggressive 2 x 3 teeth and smooth inner jaws, single action, Ø 5 mm, 330 mm



300-401-713

300-431-713

300-441-713

300-461-713

CLAW GRASPER

Grasping forceps, aggressive 2 x 3 teeth and smooth inner jaws, single action, Ø 5 mm, 450 mm

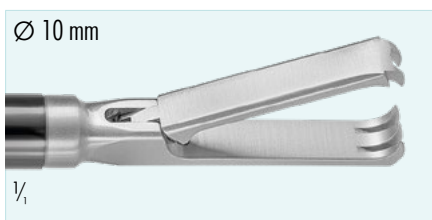

300-400-710*

300-430-710

300-440-710*

300-460-710*

CLAW GRASPER

Grasping forceps, aggressive 2 x 3 teeth and smooth inner jaws, single action, Ø 10 mm, 330 mm



300-400-717

300-430-717

300-440-717

300-460-717

DAVIS

Grasping forceps, blunt interlocking 2 x 3 teeth and long ridged inner jaws, double action, Ø 5 mm, 330 mm



300-400-715

300-430-715





300-440-715

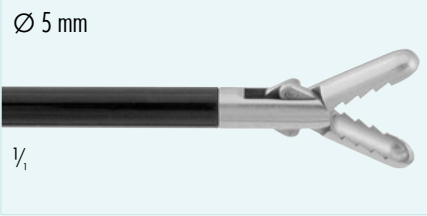
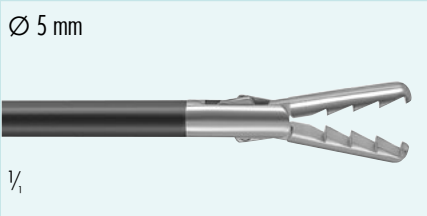
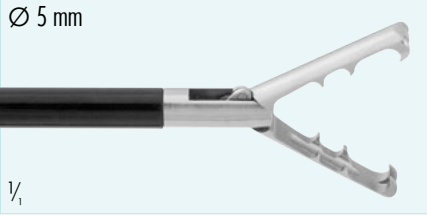
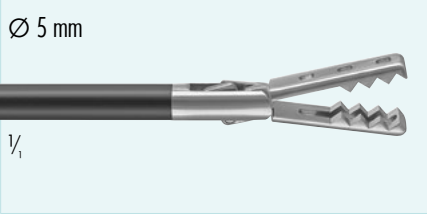
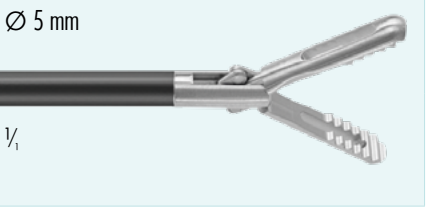

300-460-715

ST. ANDREWS

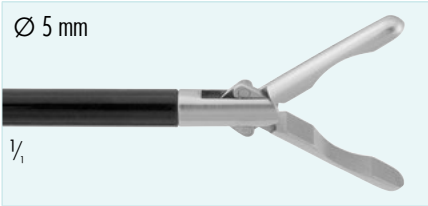
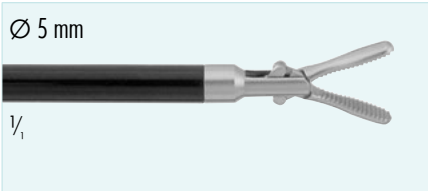
Grasping forceps, with sharp 2 x 4 teeth and wave shaped inner jaws, double action, Ø 5 mm, 330 mm

	insert only	Complete Instrument with handle 300-750-003	Complete Instrument with handle 300-750-103	Complete Instrument with handle 300-750-105
 <p>Ø 5 mm 1/1</p>	300-400-051	300-430-051	300-440-051	300-460-051
<p>ALLIGATOR SPOON</p> <p>Grasping forceps with cupped jaws, aggressive retrograde lateral teeth, double action, Ø 5 mm, 330 mm</p>				
 <p>Ø 5 mm 1/1</p>	300-400-010*	300-430-010	300-440-010*	300-460-010*
<p>ALLIGATOR</p> <p>Grasping forceps with strong retrograde serrations, double action, Ø 5 mm, 330 mm</p>				
 <p>Ø 5 mm 1/1</p>	300-400-048	300-430-048	300-440-048	300-460-048
<p>SHARK</p> <p>Grasping forceps with very sharp and aggressive lateral retrograde teeth, double action, Ø 5 mm, 330 mm</p>				
 <p>Ø 5 mm 1/1</p>	300-400-018	300-430-018	300-440-018	300-460-018
<p>CLINCH</p> <p>Grasping forceps with strong serration and fenestrated jaws, double action, Ø 5 mm, 330 mm</p>				
 <p>Ø 5 mm 1/1</p>	300-400-049	300-430-049	300-440-049	300-460-049
<p>ENDOCLINCH</p> <p>Grasping forceps, wave-shaped, fenestrated, double action, Ø 5 mm, 330 mm</p>				

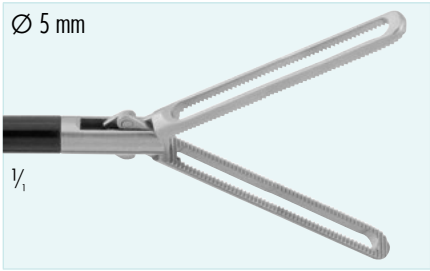
	insert only	Complete Instrument with handle 300-750-003	Complete Instrument with handle 300-750-103
 <p>Ø 5 mm 1/1</p> <p>PIN GRASPER Grasping Forceps with fine 1x2 teeth, smooth inner jaws, double action, Ø 5 mm, 330 mm</p>	300-400-042	300-410-042	300-420-042
 <p>Ø 5 mm 1/1</p> <p>OVARY Grasping forceps with fine serrated, wave shaped jaws, double action, Ø 5 mm, 330 mm</p>	300-400-045	300-410-045	300-420-045
 <p>Ø 5 mm 1/1</p> <p>TUBAL Dissecting and grasping forceps with smooth jaws, double action, Ø 5 mm, 330 mm</p>	300-400-046	300-410-046	300-420-046
 <p>Ø 5 mm 1/1</p> <p>DUCKBILL Grasping and dissecting forceps with flat jaws, fine serrations, double action, Ø 5 mm, 330 mm</p>	300-400-024	300-410-024	300-420-024
 <p>Ø 5 mm 1/1</p> <p>PETITE Micro Grasping Forceps, double action, fenestrated, fine jaw, fine serration</p>	300-400-032	300-410-032	300-420-032
 <p>Ø 5 mm 1/1</p> <p>PETELIN Grasping and Dissecting Forceps with serrated jaws, curved left, single action, Ø 5 mm, 330 mm</p>	300-400-026	300-410-026	300-420-026

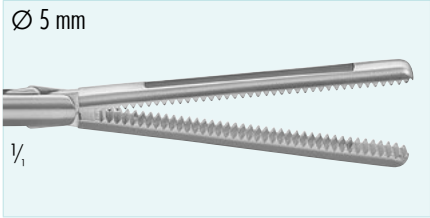
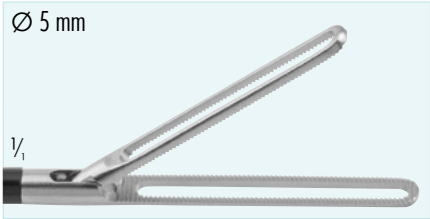
	insert only	Complete Instrument with handle 300-750-003	Complete Instrument with handle 300-750-103	Complete Instrument with handle 300-750-105
 <p>Ø 5 mm 1/1</p> <p>JOHANS Grasping forceps with 20 mm fenestrated jaws, double action, Ø 5 mm, 330 mm</p>	300-400-289*	300-430-289	300-440-289*	300-470-289*
 <p>Ø 5 mm 1/1</p> <p>LONG JOHANS Grasping forceps with 40 mm fenestrated jaws, double action, Ø 5 mm, 330 mm</p>	300-400-291*	300-430-291	300-440-291*	300-470-291*
 <p>Ø 5 mm 1/1</p> <p>DORSEY Grasping forceps with 12 mm fenestrated jaws, double action, Ø 5 mm, 330 mm</p>	300-400-285*	300-430-285	300-440-285*	300-470-285*
 <p>Ø 5 mm 1/1</p> <p>LONG DORSEY Grasping forceps with 45 mm fenestrated jaws, double action, Ø 5 mm, 330 mm</p>	300-400-287	300-430-287	300-440-287	300-470-287
 <p>Ø 5 mm 1/1</p> <p>LONG JOHANS Grasping forceps with 40 mm fenestrated jaws, single action, Ø 5 mm, 330 mm</p>	300-400-288	300-430-288	300-440-288	300-470-288



insert only
300-400-284*

Complete Instrument with handle 300-750-003
300-430-284

Complete Instrument with handle 300-750-103
300-440-284*

Complete Instrument with handle 300-750-105
300-470-284*

JOHANS

Grasping forceps with 20 mm fenestrated jaws, single action, Ø 5 mm, 330 mm



300-400-310*
300-400-312**

300-430-310
300-430-312*

300-440-310*
300-440-312**

300-470-310*
300-470-312**

MARQUES

Grasping forceps with 2 fenestrations, single action, Ø 5 mm, 330 mm
* with 3 fenestrations



300-400-314*

300-430-314

300-440-314*

300-470-314*

MARQUES

Grasping forceps with 2 fenestrations, bent up, single action, Ø 5 mm, 330 mm

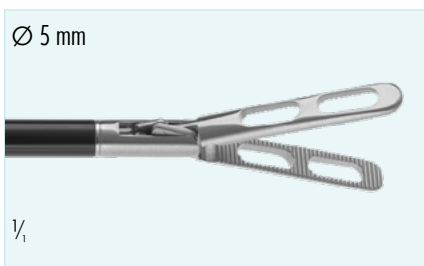

300-400-311
300-400-313*

300-430-311
300-430-313*

300-440-311
300-440-313*

300-470-311
300-470-313*

MARQUES

Grasping forceps with 2 fenestrations, double action, Ø 5 mm, 330 mm
* with 3 fenestrations

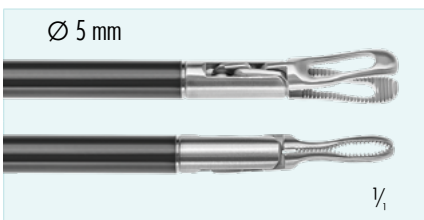

300-400-052*







300-430-052

300-440-052*

300-470-052*

GRASPER

Atraumatic Grasping forceps with fenestrated jaws, fine serrations, double action, Ø 5 mm, 330 mm

<p>Ø 5 mm</p>  <p>1/1</p>	<p>insert only</p>	 <p>Complete Instrument with handle 300-750-001</p>	 <p>Complete Instrument with handle 300-750-101</p>
	<p>300-400-080*</p>	<p>300-410-080</p>	<p>300-420-080*</p>
<p>Biopsy forceps with 2 pinholes, sharp oval cups, double action, Ø 5 mm, 330 mm</p>			
<p>Ø 5 mm</p>  <p>1/1</p>	<p>300-400-082</p>	<p>300-410-082</p>	<p>300-420-082</p>
<p>Biopsy forceps with sharp oval cups, double action, Ø 5 mm, 330 mm</p>			
<p>Ø 5 mm</p>  <p>1/1</p>	<p>300-400-521</p>	<p>300-410-521</p>	<p>300-420-521</p>
<p>Biopsy forceps with 2 pins, sharp oval cups, single action, Ø 5 mm, 330 mm</p>			
<p>Ø 5 mm</p>  <p>1/1</p>	<p>300-400-086</p>	<p>300-410-086</p>	<p>300-420-086</p>
<p>BLAKESLEY Biopsy forceps with sharp cups, single action, Ø 5 mm, 330 mm</p>			
<p>Ø 5 mm</p>  <p>1/1</p>	<p>300-400-100</p>	<p>300-410-100</p>	<p>300-420-100</p>
<p>Hook punch forceps, thru-cutting, single action, Ø 5 mm, 330 mm</p>			

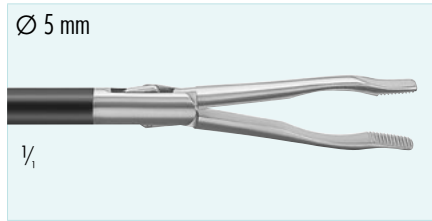

insert only

300-400-250	300-430-250	300-440-250	300-470-250
-------------	-------------	-------------	-------------



BABCOCK PADDLE

Grasping forceps with flat paddles and fine serration for atraumatic grip of delicate tissue, double action, Ø 5 mm, 330 mm

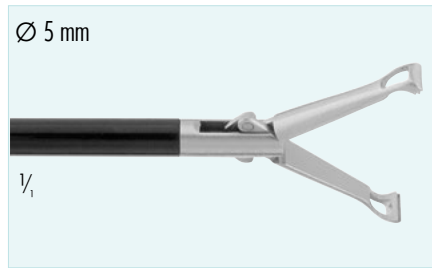

300-400-252*	300-430-252	300-440-252*	300-470-252*
--------------	-------------	--------------	--------------

BABCOCK

Traditional style Babcock grasping forceps, rounded jaws with fine serrations, double action, Ø 5 mm, 330 mm

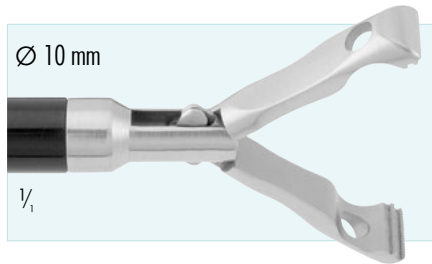

300-400-079	300-430-079	300-440-079	300-470-079
-------------	-------------	-------------	-------------

DEBAKEY BABCOCK

Traditional style Babcock grasping forceps, rounded jaws with atraumatic DeBaKey serration, double action, Ø 10 mm, 330 mm

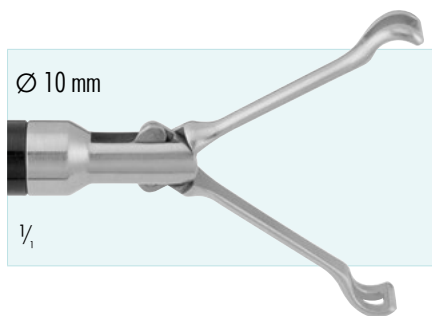

300-400-078*	300-430-078	300-440-078*	300-470-078*
--------------	-------------	--------------	--------------

BABCOCK

Traditional style Babcock grasping forceps with medium jaws, rounded jaws with fine serrations, double action, Ø 10 mm, 330 mm

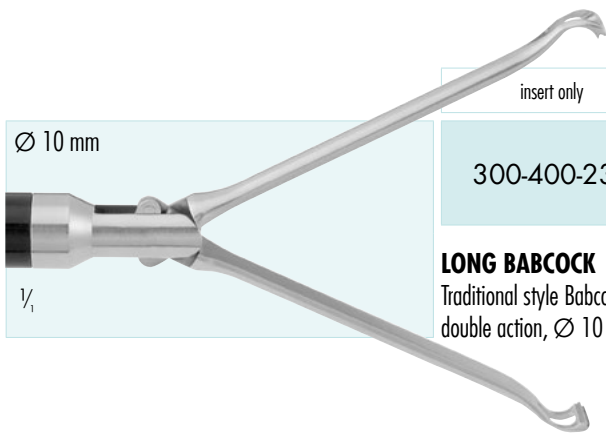

insert only
300-400-234

Complete Instrument
with handle 300-750-003
300-430-234

Complete Instrument
with handle 300-750-103
300-440-234

Complete Instrument
with handle 300-750-105
300-470-234

LONG BABCOCK

Traditional style Babcock grasping forceps with long jaws, rounded jaws with fine serrations, double action, ∅ 10 mm, 330 mm

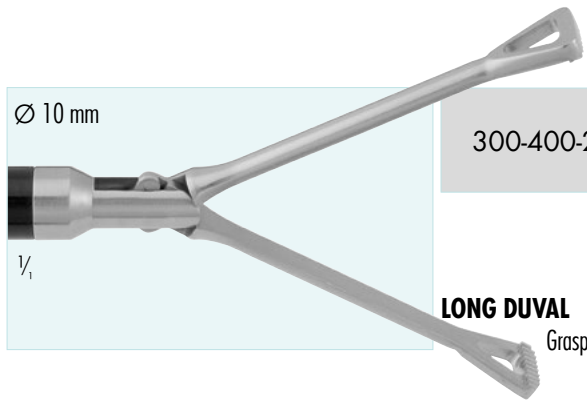

300-400-280

300-430-280

300-440-280

300-470-280

LONG DUVAL

Grasping forceps with long jaws, V-shaped tip with fine serrations, double action, ∅ 10 mm, 330 mm

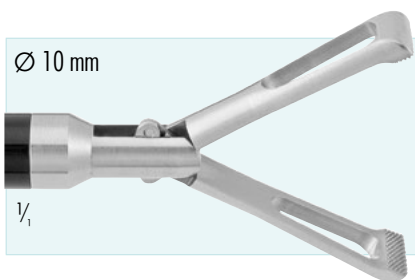

300-400-084



300-430-084

300-440-084

300-470-084

COLLIN-DUVAL

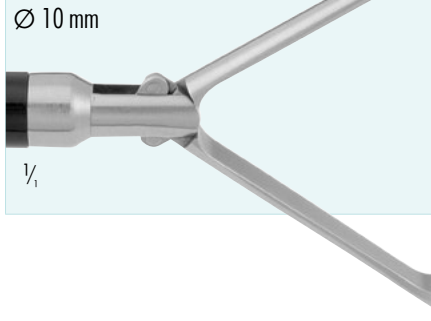
Grasping forceps, V-shaped tip with fine serrations on the tip, double action, ∅ 10 mm, 330 mm

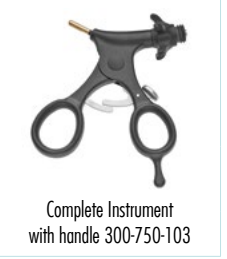
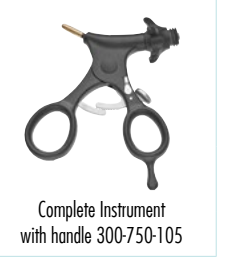
 <p>Ø 10 mm</p> <p>1/1</p>	insert only	 <p>Complete Instrument with handle 300-750-003</p>	 <p>Complete Instrument with handle 300-750-103</p>	 <p>Complete Instrument with handle 300-750-105</p>
	300-400-074	300-430-074	300-440-074	300-470-074
	<p>ALLIS Traditional Allis grasping forceps, with fine serrations on the tip, double action, Ø 10 mm, 330 mm</p>			

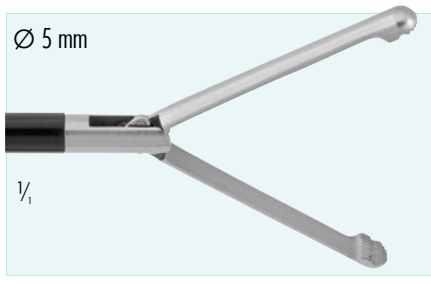
 <p>Ø 5 mm</p> <p>1/1</p>	300-400-097	300-430-097	300-440-097	300-470-097
	<p>SLIM ALLIS Grasping forceps with delicate jaws and with fine serrations on the tip, double action, Ø 5 mm, 330 mm</p>			

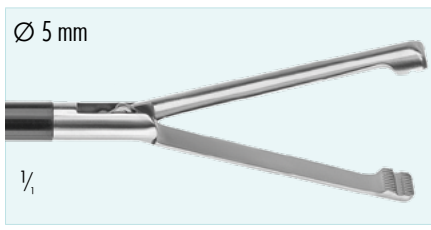
 <p>Ø 5 mm</p> <p>1/1</p>	300-400-197	300-430-197	300-440-197	300-470-197
	<p>ALLIS Bowell grasping forceps, 4 mm x 35 mm, double action, Ø 5 mm, 330 mm</p>			

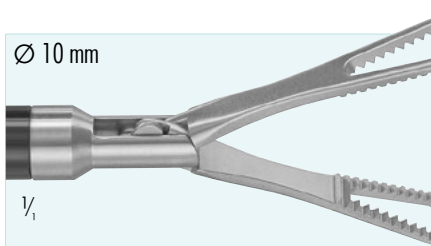
 <p>Ø 10 mm</p> <p>1/1</p>	300-400-085*	300-430-085	300-440-085*	300-470-085*
	<p>COLLIN Grasping forceps, V-shaped tip with deep serrations for firm grip, double action, Ø 10 mm, 330 mm</p>			

 <p>Ø 5 mm 1/1</p>	insert only	 Complete Instrument with handle 300-750-003	 Complete Instrument with handle 300-750-103	 Complete Instrument with handle 300-750-105
	300-400-243	300-430-243	300-440-243	300-460-243

DEBAKEY

Pick-up forceps with fine 22 mm long atraumatic serrations, 38 mm jaws, double action, Ø 5 mm, 330 mm

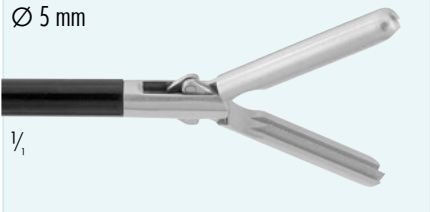
 <p>Ø 5 mm 1/1</p>	300-400-244	300-430-244	300-440-244	300-460-244
---	-------------	-------------	-------------	-------------

DEBAKEY

Atraumatic grasping forceps, fine atraumatic serrations, double action, 25 mm jaws, Ø 5 mm, 330 mm

 <p>Ø 5 mm 1/1</p>	300-400-245	300-430-245	300-440-245	300-460-245
---	-------------	-------------	-------------	-------------

DEBAKEY

Atraumatic grasping forceps, fine atraumatic serrations, double action, 40 mm jaws, Ø 5 mm, 330 mm

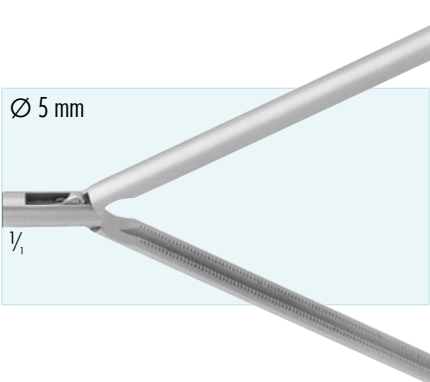
 <p>Ø 5 mm 1/1</p>	300-400-246	300-430-246	300-440-246	300-460-246
---	-------------	-------------	-------------	-------------

DEBAKEY

Atraumatic grasping forceps, fine atraumatic serrations, double action, 60 mm jaws, Ø 5 mm, 330 mm

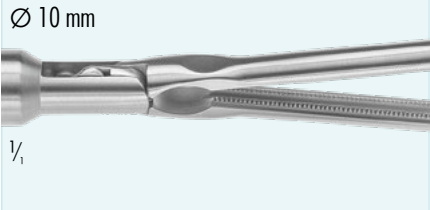
 <p>Ø 10 mm 1/1</p>	300-400-275	300-430-275	300-440-275	300-460-275
--	-------------	-------------	-------------	-------------

KOCHER

Bowell forceps, 40 mm long longitudinal serrated jaws, Ø 10 mm, 330 mm

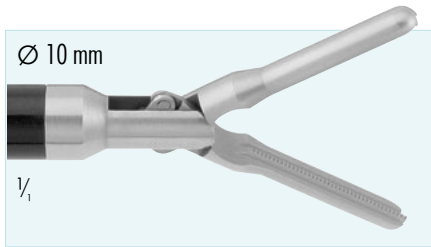

insert only	Complete Instrument with handle 300-750-003	Complete Instrument with handle 300-750-103	Complete Instrument with handle 300-750-105
300-400-263	300-430-263	300-440-263	300-460-263

DEBAKEY

Atraumatic grasping forceps, fine atraumatic serrations, double action, 25 mm jaws, Ø 10 mm, 330 mm

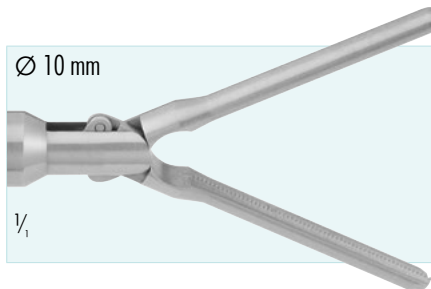

300-400-264	300-430-264	300-440-264	300-460-264
-------------	-------------	-------------	-------------

DEBAKEY

Atraumatic grasping forceps, fine atraumatic serrations, double action, 40 mm jaws, Ø 10 mm, 330 mm

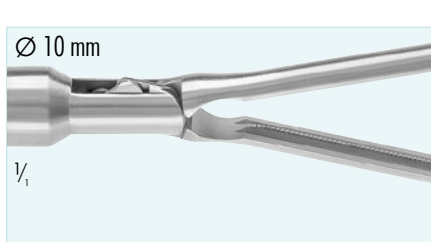

300-400-266	300-430-266	300-440-266	300-460-266
-------------	-------------	-------------	-------------

DEBAKEY

Atraumatic grasping forceps, fine atraumatic serrations, double action, 60 mm jaws, Ø 10 mm, 330 mm

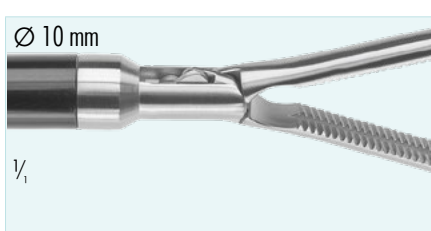

300-400-274	300-430-274	300-440-274	300-460-274
-------------	-------------	-------------	-------------

GLASSMAN

Grasping forceps, atraumatic serrations, double action, Ø 10 mm, 330 mm



300-400-276	300-430-276	300-440-276	300-460-276
-------------	-------------	-------------	-------------

GLASSMAN

Grasping forceps with oblique, parallel serrations, double action, 60 mm jaws, Ø 10 mm, 330 mm

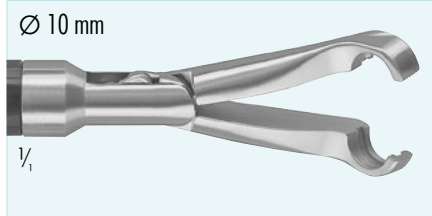

insert only

300-400-295



300-430-295



300-440-295

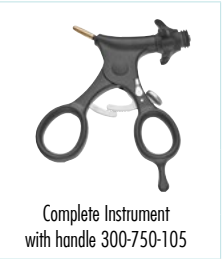

300-460-295

ANVIL
Grasping forceps with specially shaped jaws to grasp and hold the anvil of a circular stapler, double action, Ø 10 mm, 330 mm



300-400-286

300-430-286

300-440-286

300-460-286

DORSEY
Grasping forceps, fenestrated jaws with medium serrations, double action, Ø 10 mm, 330 mm

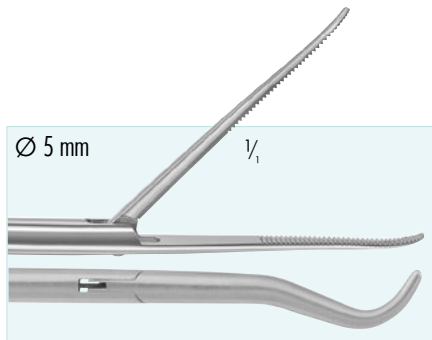

300-400-030

300-430-030

300-440-030

300-460-030

GEEGEE
Dissecting and grasping forceps with fine jaws, strongly curved and fine serrations, single action, Ø 5 mm, 330 mm

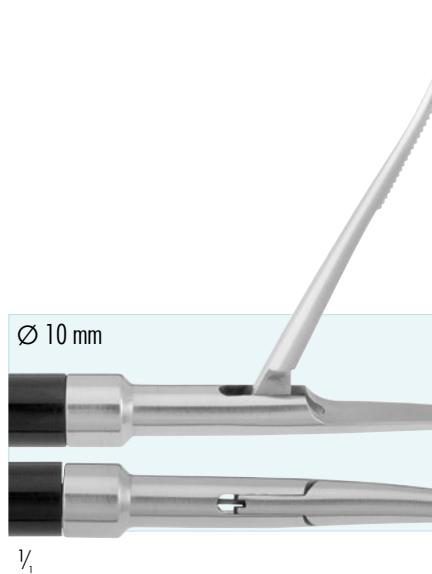

300-400-076

300-430-076

300-440-076

300-460-076

GEEGEE
Dissector and grasping forceps with fine jaws, strongly curved and fine serration, single action, Ø 10 mm, 330 mm

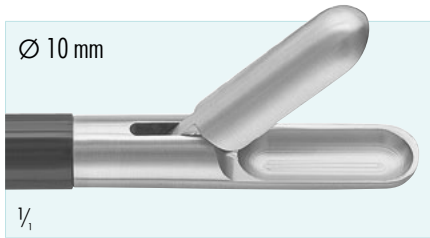

insert only
300-400-720*

Complete Instrument
with handle 300-750-003
300-430-720

Complete Instrument
with handle 300-750-103
300-440-720*

Complete Instrument
with handle 300-750-105
300-460-720*

SPOON

Forceps with sharp, cup-shaped jaws for tissue or stone removal, **single action**, Ø 10 mm, 330 mm

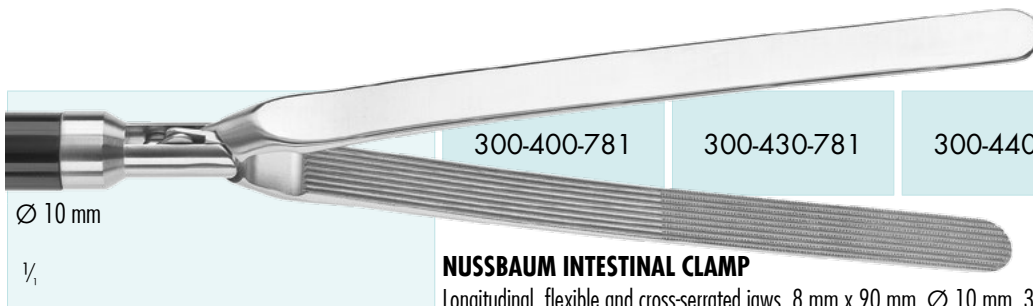

300-400-781

300-430-781

300-440-781

300-460-781

NUSSBAUM INTESTINAL CLAMP

Longitudinal, flexible and cross-serrated jaws, 8 mm x 90 mm, Ø 10 mm, 330 mm

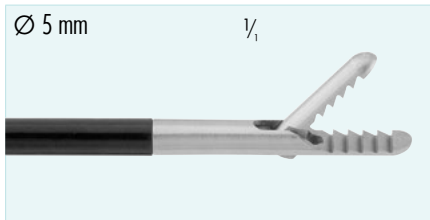

300-400-700

300-430-700

300-440-700

300-460-700

RETROGRADE

Grasping and extracting forceps with deep retrograde serration for a secure grip of tissue, **single action**, Ø 5 mm, 330 mm

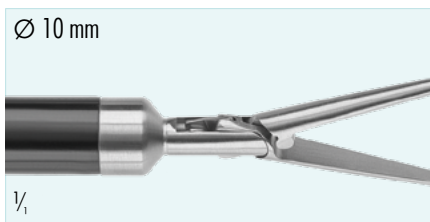

300-400-753*

300-430-753

300-440-753*

300-460-753*

TENACULUM FORCEPS

35mm long jaws, **double action**, Ø 10 mm, 330 mm

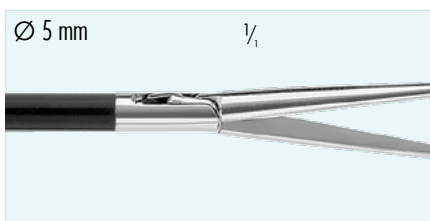

300-400-751*

300-430-751

300-440-751*

300-460-751*

TENACULUM FORCEPS

35mm long jaws, **double action**, Ø 5 mm, 330 mm



Complete Instrument
with handle 300-750-015

insert only

Ø 5 mm

300-400-200*

300-490-200

1/1

SATINSKY

Grasping Forceps, 50 mm atraumatic jaws, Ø 5 mm, 330 mm

Ø 5 mm

300-400-202

300-490-245

1/1

SATINSKY

Grasping Forceps, 40 mm atraumatic jaws, Ø 5 mm, 330 mm

Ø 5 mm



300-400-206

300-490-206

1/1

CRAFOORD

Thorax clamp, 50 mm atraumatic jaws, Ø 5 mm, 330 mm

 <p>Ø 5 mm</p> <p>1/1</p>	<p>insert only</p> <p>300-400-204</p>	 <p>Complete Instrument with handle 300-750-015</p> <p>300-490-204</p>
	<p>CRAFOORD Thorax clamp, 35 mm atraumatic jaws, Ø 5 mm, 330 mm</p>	

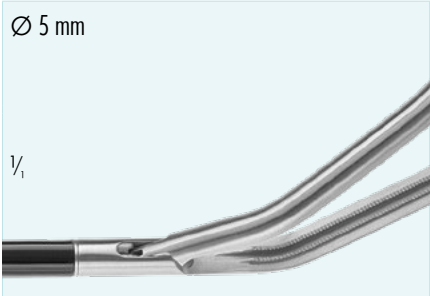
 <p>Ø 5 mm</p> <p>1/1</p>	<p>300-400-220*</p>	<p>300-490-220</p>
	<p>DEBAKEY Pulmonary atraumatic Clamp, curved shape, Ø 5 mm, 330 mm</p>	

 <p>Ø 5 mm</p> <p>1/1</p>	<p>300-400-221</p>	<p>300-490-221</p>
	<p>DEBAKEY Pulmonary atraumatic Clamp, s-shaped, Ø 5 mm, 330 mm</p>	

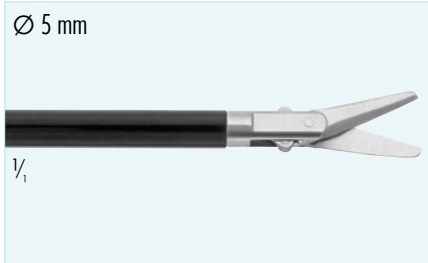

insert only

300-400-067*



300-410-067



300-420-067*

ORIGINAL METZENBAUM

Scissors, short blades (12 mm), slightly curved, double action, Ø 5 mm, 330 mm

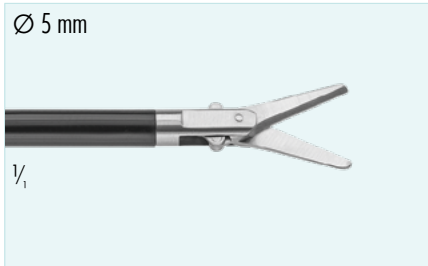

300-400-069*

300-410-069

300-420-069*

METZENBAUM

Scissors, short blades (12 mm), straight, double action, Ø 5 mm, 330 mm



300-400-172

300-410-172

300-420-172

METZENBAUM

Scissors, short, with **Diamond Dusted** blades (12 mm), curved, double action, Ø 5 mm, 330 mm



300-400-168

300-410-168

300-420-168

METZENBAUM

Scissors, medium, with **Diamond Dusted** blades (15 mm), straight, double action, Ø 5 mm, 330 mm



insert only

300-400-072*



300-410-072



300-420-072*

METZENBAUM

Scissors, medium blades (15 mm), slightly curved, double action, Ø 5 mm, 330 mm

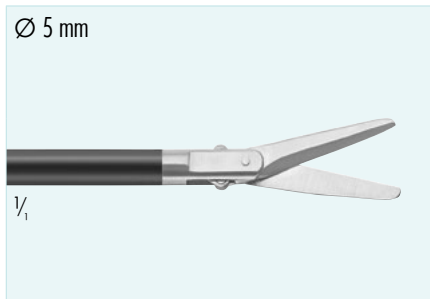

300-400-070*

300-410-070

300-420-070*

METZENBAUM

Scissors, long blades (18 mm), slightly curved, double action, Ø 5 mm, 330 mm

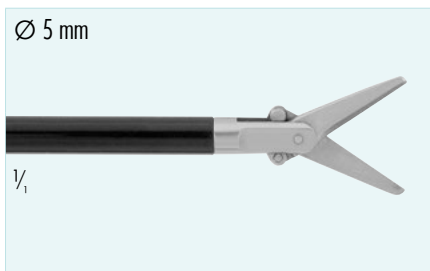

300-400-068*

300-410-068

300-420-068*

METZENBAUM

Scissors, medium blades (15 mm), straight, double action, Ø 5 mm, 330 mm

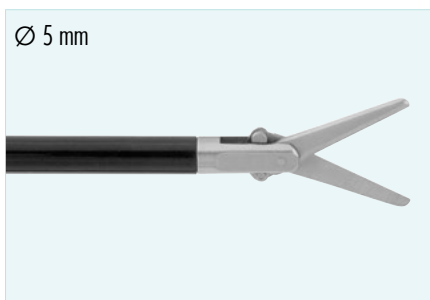

300-400-071

300-410-071

300-420-071

METZENBAUM

Scissors, long blades (18 mm), straight, double action, Ø 5 mm, 330 mm

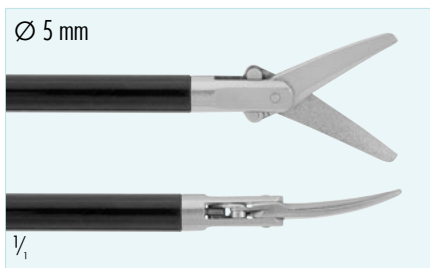

300-400-169

300-410-169

300-420-169

METZENBAUM

Scissors, medium blades (15 mm) coated with **Diamond Dust**, slightly curved, double action, Ø 5 mm, 330 mm, **DD-Coating** gives the scissors' blades a more durable cutting performance.



insert only

300-400-170



300-410-170



300-420-170

TC METZENBAUM

Scissors, long blades (18 mm) with **Tungsten Carbide** inserts, strong curved, double action, Ø 5 mm, 330 mm

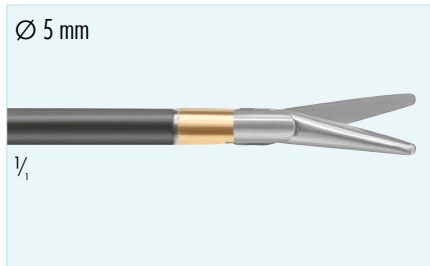

300-400-171

300-410-171

300-420-171

TC METZENBAUM

Scissors, short blades (12 mm) with **Tungsten Carbide** inserts, slight curved, double action, Ø 5 mm, 330 mm



300-400-180

300-410-180

300-420-180

HINGELESS TC METZENBAUM

Scissors, long blades (18 mm), curved, double action, Ø 5 mm, 330 mm, with **Tungsten Carbide** inserts
For use with shaft 300-660-015 only

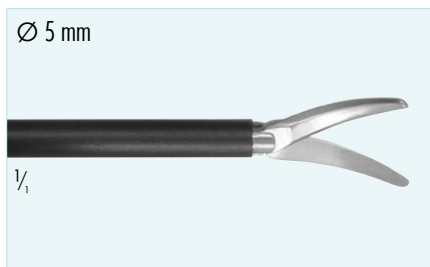

300-400-181

300-410-181

300-420-181

HINGELESS TC METZENBAUM

Scissors, short blades (12 mm), curved, double action, Ø 5 mm, 330 mm, with **Tungsten Carbide** inserts
For use with shaft 300-660-015 only



insert only

300-400-072CC



300-410-072CC

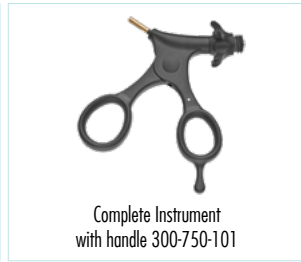

300-420-072CC

METZENBAUM CERA CUT®

Scissors, medium blades (15 mm) slightly curved, double action, Ø 5 mm, 330 mm

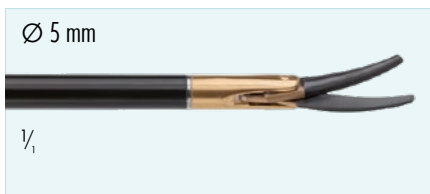

300-400-170CC

300-410-170CC

300-420-170CC

METZENBAUM TC CERA CUT®

TC Scissors, medium blades (16 mm), curved, double action, Ø 5 mm, 330 mm

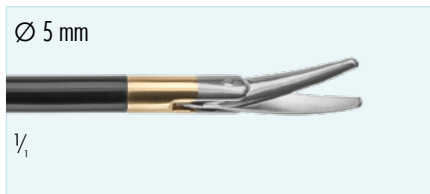

300-400-173

300-410-173

300-420-173

METZENBAUM TC

TC Scissors, medium blades (15 mm), curved, double action, Ø 5 mm, 330 mm



300-400-065

300-410-064

300-420-064

METZENBAUM

Scissors, bow shape curved, 16mm blades, fine serrated, double action, Ø 5 mm, 330 mm



300-400-165*

300-410-165

300-420-165*

METZENBAUM TC

TC Scissors, bow shape curved, 16mm blades, fine serrated, double action, Ø 5 mm, 330 mm



300-400-056

300-410-056

300-420-056

METZENBAUM

Scissors, slightly curved, double action, Ø 10 mm, 330 mm

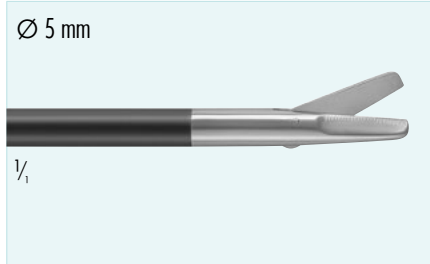

insert only

300-400-063



300-410-063

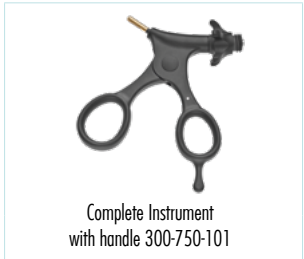

300-420-063

PERITONEAL

Scissors, delicate with fine serrated blades, straight, single action, Ø 5 mm, 330 mm



300-400-060*

300-410-060

300-420-060*

HOOK

Scissors with round cutting blades, single action, Ø 5 mm, 330 mm



300-400-062

300-410-062

300-420-062

HOOK

Scissors with round cutting blades, fine serrated lower blade, single action, Ø 5 mm, 330 mm

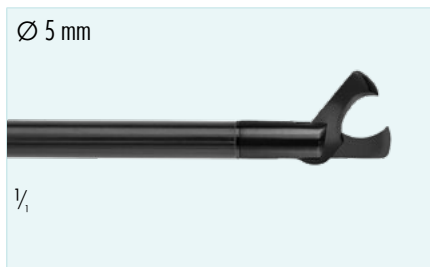

300-400-060CC

300-410-060CC

300-420-060CC

HOOK CERA CUT®

Scissors with round cutting blades, single action, Ø 5 mm, 330 mm

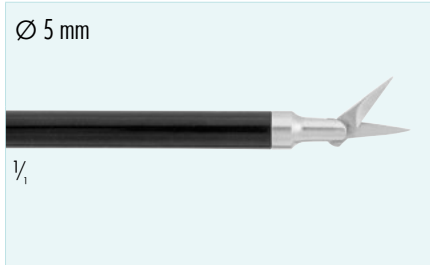

insert only

300-400-570



300-410-570

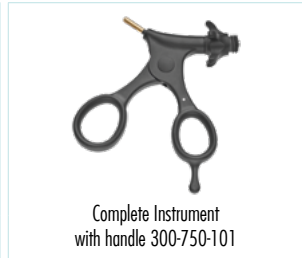

300-420-570

MICRO

Scissors with straight sharp blades, single action, Ø 5 mm, 330 mm

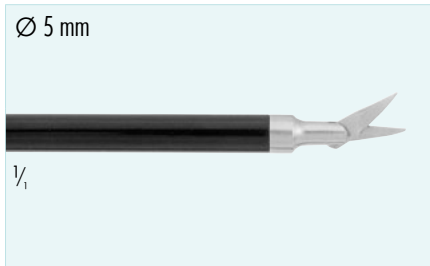

300-400-571

300-410-571

300-420-571

MICRO

Scissors with curved sharp blades, single action, Ø 5 mm, 330 mm

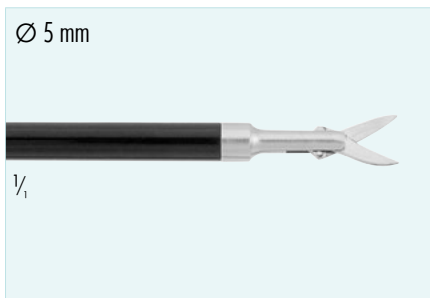

300-400-572

300-410-572

300-420-572

MICRO

Scissors with curved sharp blades, double action, Ø 5 mm, 330 mm



4-PIECE ENDO TIP SYSTEM

- Reusable handle and shaft, disposable tip
- Always having a sharp tip
- Ecological and economical - reduces waste and saves budget

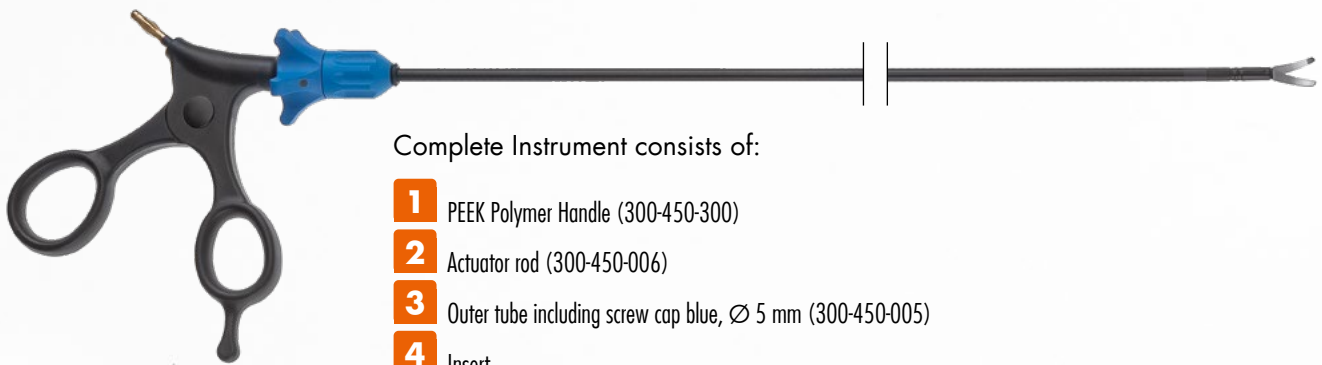

Complete Instrument consists of:

- 1** PEEK Polymer Handle (300-450-300)
- 2** Actuator rod (300-450-006)
- 3** Outer tube including screw cap blue, \varnothing 5 mm (300-450-005)
- 4** Insert

1 PEEK POLYMER HANDLES



300-450-300 PEEK Polymer Handle, blue rotating wheel, without ratchet



2

3



The EndoTip system allows to reuse the handle and the sheath of the Instrument, but gives the opportunity to easily change the tip. That provides an always sharp scissors without creating the waste of a complete single use instrument.

4



METZENBAUM non-sterile, limited reusable
 300-450-177 medium, 15mm curved
 300-450-171 short, 10mm, curved
 300-450-173 long, 18 mm, curved
 300-450-174 long, 18 mm, straight
 300-450-176 medium, 15mm, straight



METZENBAUM sterile, single use
 300-450-177S medium, 15mm curved
 300-450-171S short, 10mm, curved



JOHANS Grasper, fenestrated
 300-450-289 non-sterile (limited reusable)
 300-450-289S sterile



MARYLAND Grasper, curved
 300-450-731 non-sterile (limited reusable)
 300-450-731S sterile



ENDOCLINCH Grasper, fenestrated
 300-450-049 non-sterile (limited reusable)
 300-450-049S sterile