

- 420-050-001 8,5 x 6,0 mm
- 420-050-002 9,0 x 7,0 mm
- 420-050-003 12,5 x 8,0 mm
- 420-050-004 15,0 x 8,5 mm
- 420-050-005 16,5 x 9,0 mm
- 420-050-006 18,0 x 10,0 mm
- 420-050-007 19,5 x 10,5 mm

THUDICHUM (MARK HOVELL)

Nasenspekulum, 70 mm
Nasal specula

- 420-050-101 8,5 x 6,0 mm
- 420-050-102 9,0 x 7,0 mm
- 420-050-103 12,5 x 8,0 mm
- 420-050-104 15,0 x 8,5 mm
- 420-050-105 16,5 x 9,0 mm
- 420-050-106 18,0 x 10,0 mm
- 420-050-107 19,5 x 10,5 mm

Nasenspekulum, **isoliert**, 70 mm
Nasal specula, **insulated**

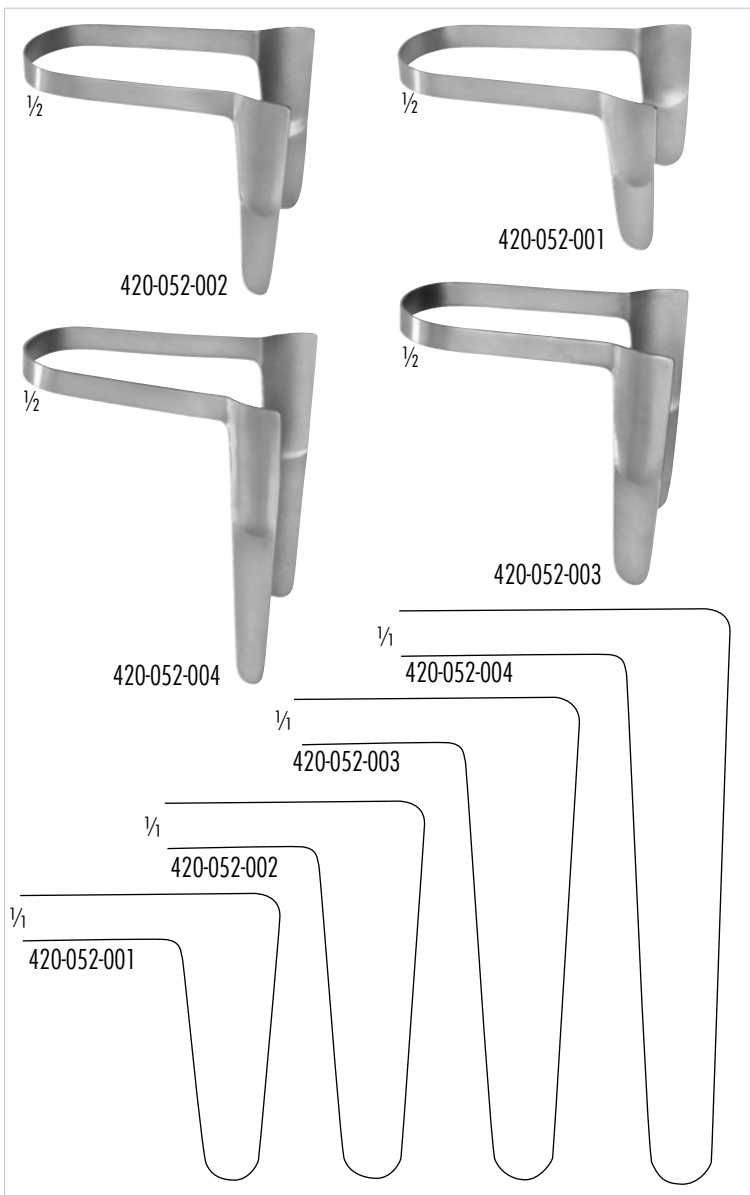

- 420-052-001 38 mm
- 420-052-002 50 mm
- 420-052-003 65 mm
- 420-052-004 75 mm

ST CLAIR THOMPSON

Nasenspekulum, 73 mm
Nasal specula, 2 1/2 inch

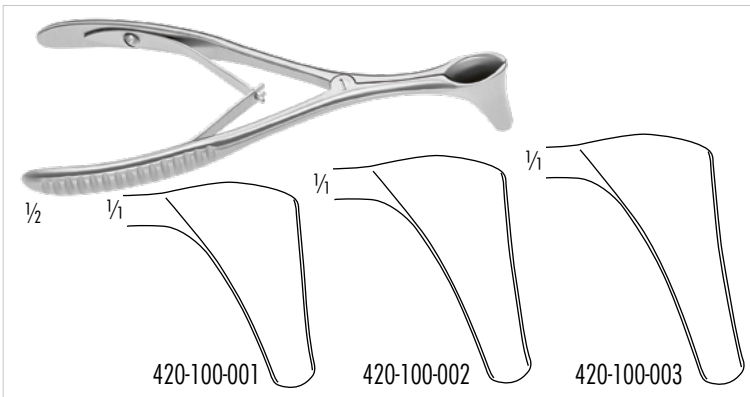

420-100-001 Fig.1 27 x 7 mm
 420-100-002 Fig.2 30 x 7 mm
 420-100-003 Fig.3 33 x 7 mm
 Wiener Modell Nasenspekulum, 130 mm
 Vienna pattern nasal specula, 5 inch

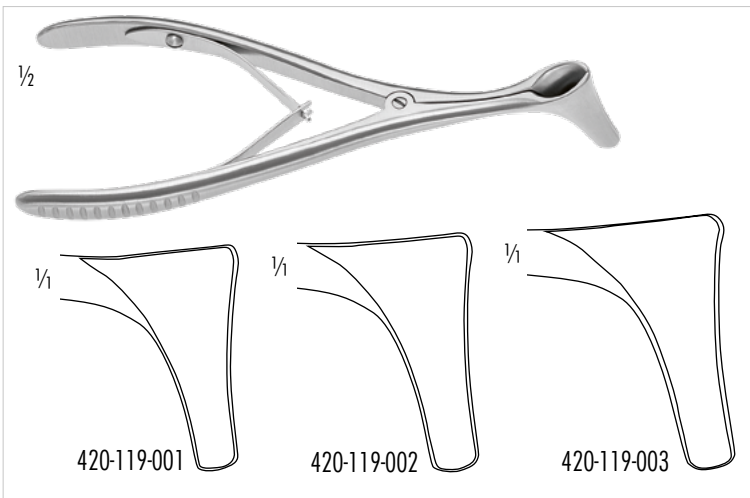

420-119-001 29 x 7 mm
 420-119-002 33 x 7 mm
 420-119-003 35 x 7 mm
HARTMANN
 Nasenspekulum, 160 mm
 Nasal specula, 6 1/4 inch

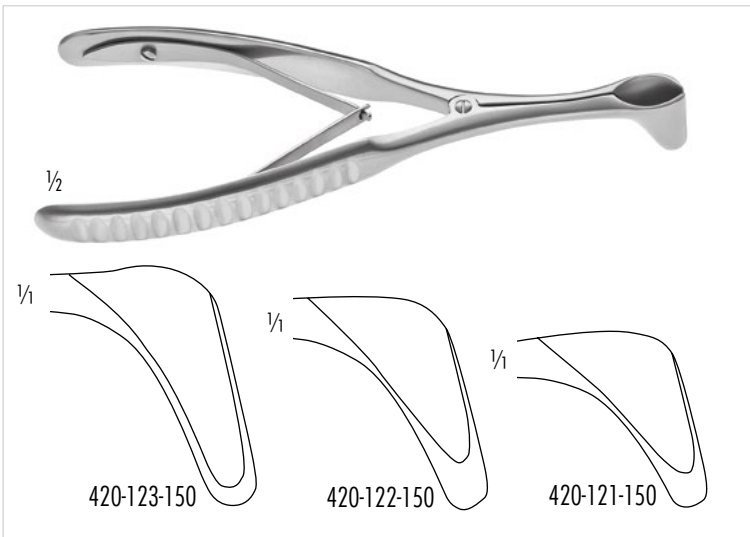

420-121-150 27 mm
 420-122-150 31 mm
 420-123-150 35 mm
HARTMANN-HALLE
 Nasenspekulum, 155 mm
 Nasal specula, 6 inch

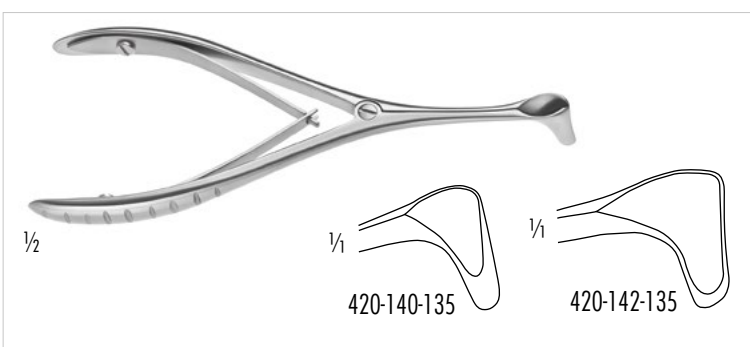

420-140-135 klein/small
 420-142-135 groß/large
TIECK-HALLE
 Nasenspekulum, Kindermodelle, 135 mm
 Nasal specula, pediatric pattern, 5 1/4 inch

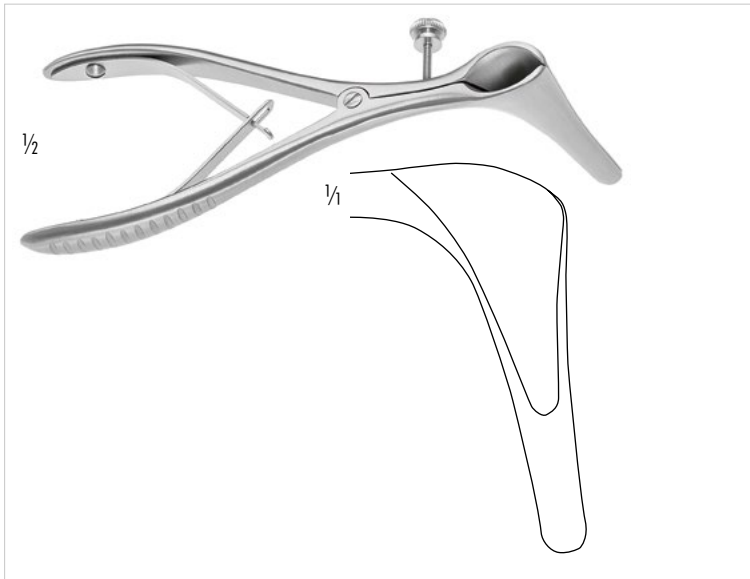

420-134-050 50 x 6 mm

COTTLE

Septumspekulum, leicht spitz zulaufend
Septum specula, slightly tapered blades

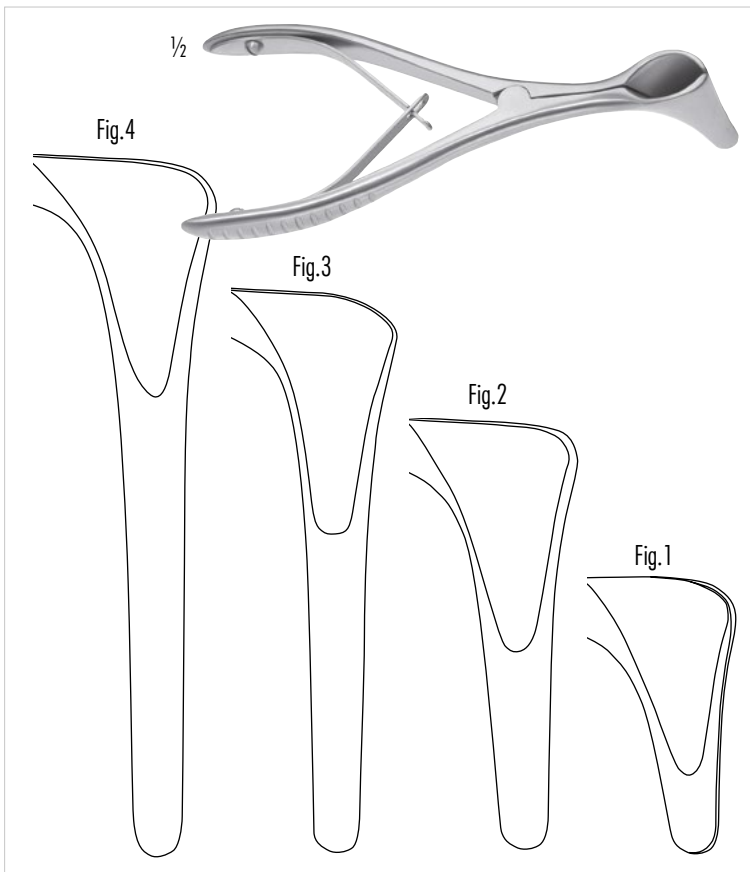

420-145-036	Fig.1	36 x 7 mm
420-145-056	Fig.2	56 x 7 mm
420-145-075	Fig.3	75 x 7 mm
420-145-090	Fig.4	90 x 7 mm

KILLIAN

Nasenspekulum, 145 mm
Septum specula, 5 3/4 inch



420-743-055	55 mm
420-743-075	75 mm
420-743-090	90 mm

KILLIAN

Nasenspekulum, mit abnehmbarem Kaltlichtträger, 140 mm
Nasal specula, with detachable cold light carrier, 5 1/2 inch

420-136-020	Fig.1	30 mm
420-136-035	Fig.2	38 mm
420-136-055	Fig.3	55 mm
420-136-070	Fig.4	70 mm
420-136-080	Fig.5	80 mm
420-136-090	Fig.6	90 mm

COTTLE

Nasenspekula mit Stellschraube, 135 mm
 Nasal specula with setscrew, 5 1/4 inch

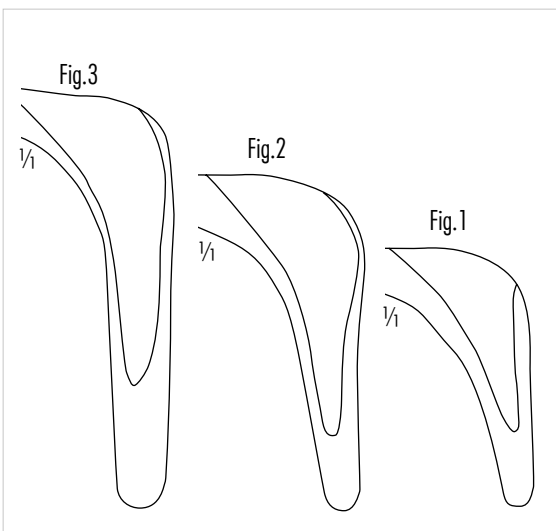
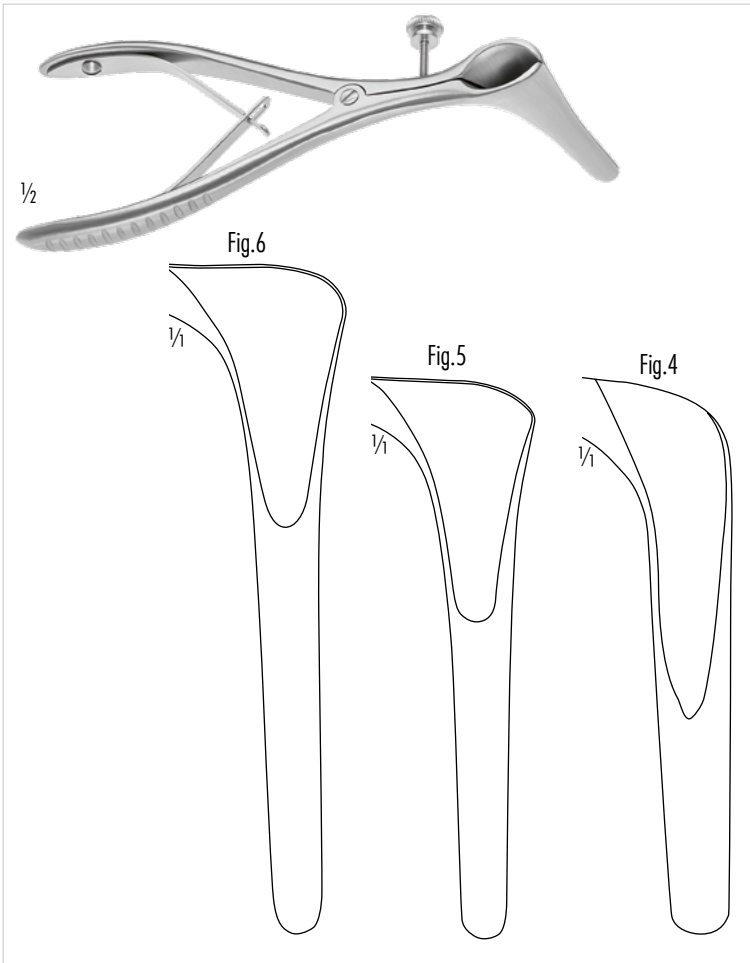

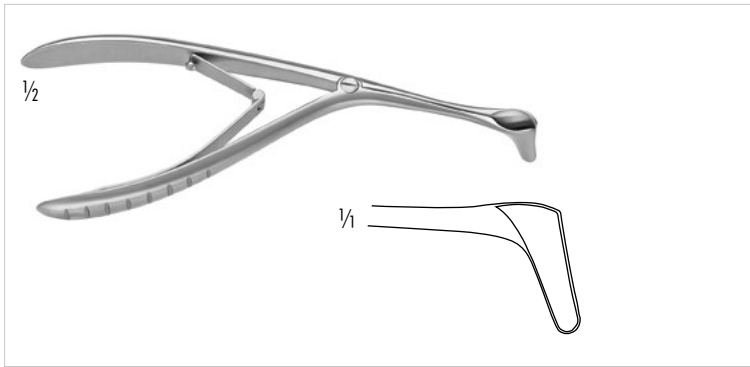

420-147-140

BECKMANN

Nasenspekula, Kindermodell, seitwärts gebogen, 150 mm
Nasal specula, pediatric pattern, curved sidewards, 6 inch

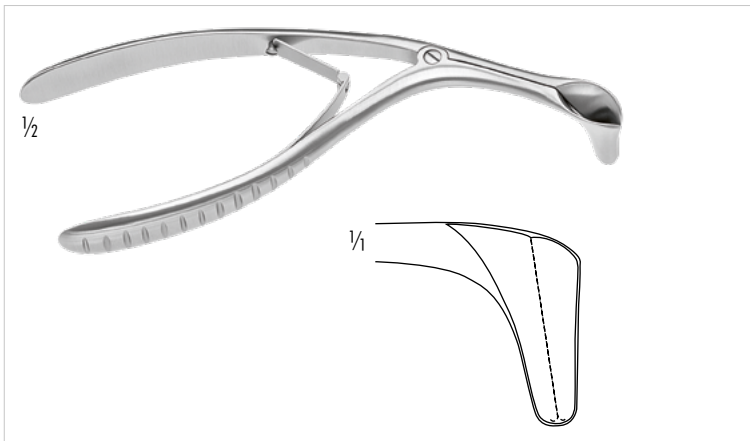

420-148-150

BECKMANN

Nasenspekula, seitwärts gebogen, 150 mm
Nasal specula, curved sidewards, 6 inch



- 420-140-035 35mm Blattlänge/blade length
- 420-140-050 50mm Blattlänge/blade length
- 420-140-075 75mm Blattlänge/blade length
- 420-140-090 90mm Blattlänge/blade length
- 420-140-100 100mm Blattlänge/blade length

COTTLE MASING

Nasenspekula für flexiblen Spannarm, mit Stellschraube
Nasal Specula for flexible arm



- 420-150-001 links/left 55mm, rechts/right 35mm
- 420-150-002 links/left 35mm, rechts/right 55mm
- 420-150-003 links/left 65mm, rechts/right 45mm
- 420-150-004 links/left 45mm, rechts/right 65mm
- 420-150-005 links/left 75mm, rechts/right 35mm
- 420-150-006 links/left 35mm, rechts/right 75mm
- 420-150-007 links/left 75mm, rechts/right 52mm
- 420-150-008 links/left 52mm, rechts/right 75mm

Sinus Spekula zur Verwendung mit flexiblen Spannarm,
mit Zähnen, mit Stellschraube
Sinus Specula for use with flexible arm, with teeth,
with set screw



420-150-160
Nasensonde, kniegebogen, 160 mm
Nasal probe, knee angled, 6 1/4 inch



420-150-165
KILLIAN
Nasensonde, leicht gebogen, 165 mm
Nasal probe, slightly curved, 6 1/2 inch

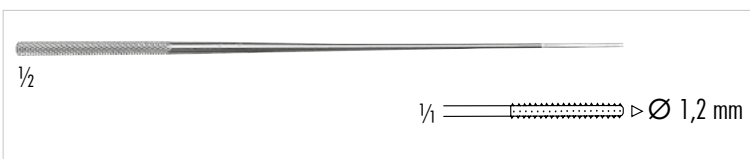

160-426-165 Ø 1,2 mm
LATHBURY-FARRELL
Nasensonde, dreikant gerieft, 160 mm
Nasal applicator, triangular serrated end, 6 1/4 inch

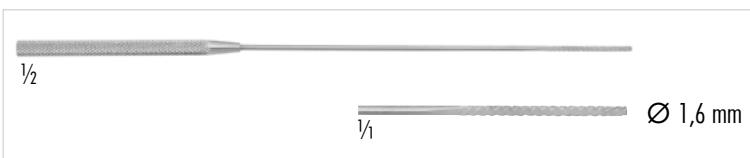

160-426-160 Ø 1,6 mm
Nasensonde, dreikant gerieft, 160 mm
Nasal applicator, triangular serrated end, 6 1/4 inch

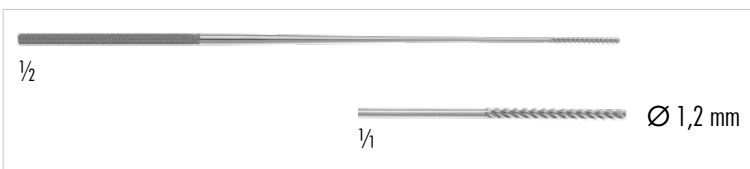

160-420-165 Ø 1,2 mm
FARRELL
Nasensonde, spiralförmig gerieft, 160 mm
Nasal applicator, rough spiral end, 6 1/4 inch

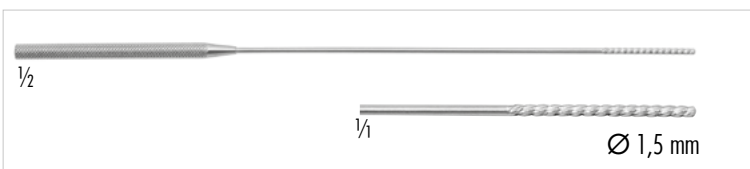

160-412-180 Ø 1,5 mm
Nasensonde, spiralförmig gerieft, 180 mm
Nasal applicator, rough spiral end, 7 inch



420-150-180
SIEBENMANN
Nasensonde, 180 mm
Nasal plugger, 7 inch



420-413-230

LANGE

Choanenhaken, 230 mm
Choana hook, 9 1/2 inch

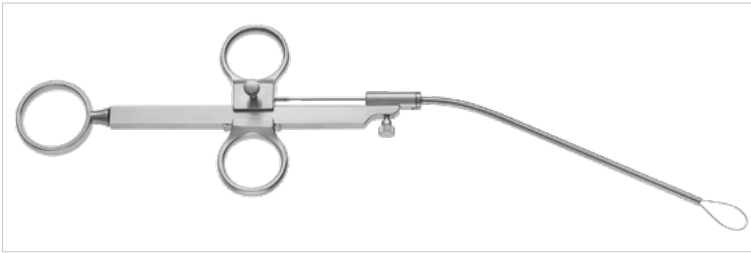

420-201-260

KRAUSE

Nasenpolypenschnürer, kniegebogen, 250 mm
Nasal polypus snare, knee bent, 10 inch

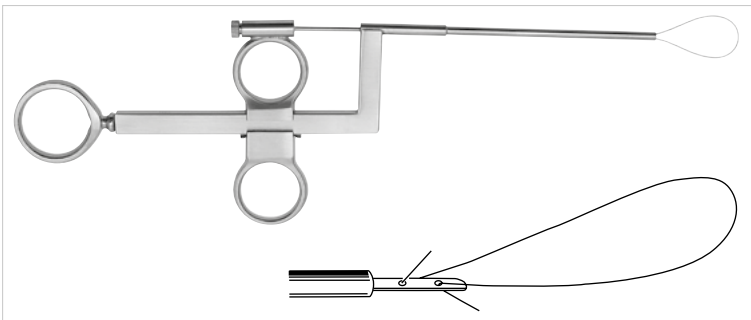

410-270-250

WILDE

Nasenpolypenschnürer, bajonettförmig gebogen, 250 mm
Nasal polypus snare, bayonet shaped, 10 inch



420-210-003 Ø 0,3 mm

Schlingen für Nasenpolypenschnürer,
Bestelleinheit: PH=Packung á 100 Stück
Wire loops for nasal snares,
sales unit: PH=Package of 100 pieces

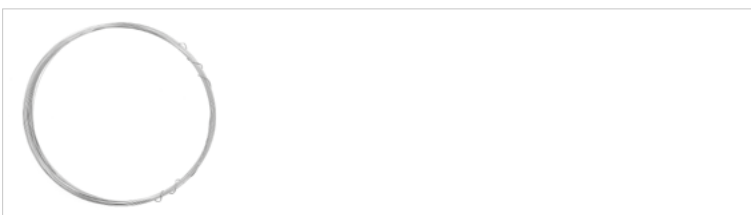

420-210-013 Ø 0,3 mm

Schnürerdraht in Rollen á 10 m
Snare wire in coils of 10 metres

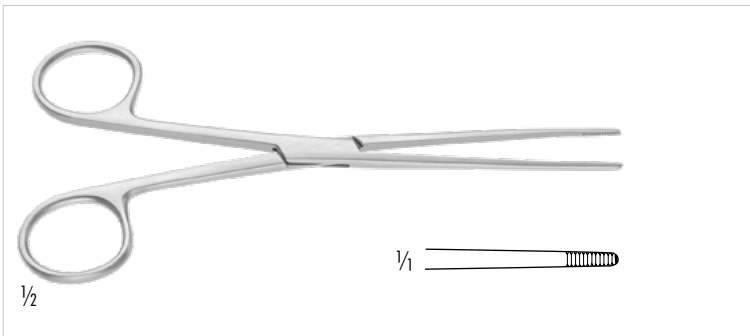

150-080-160 155 mm/6 inch
150-080-180 180 mm/7 inch

LISTER
Tamponzange
Sinus forceps

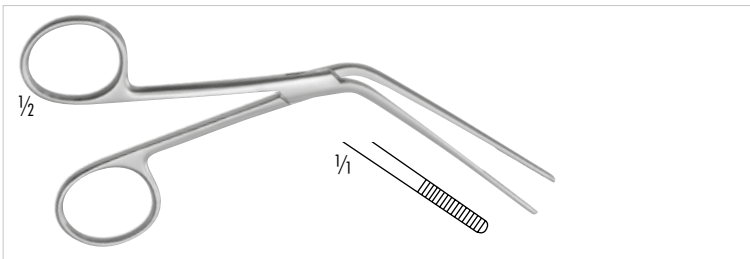

410-232-140
TILLEY
Nasentamponzange, 130 mm
Nasal dressing forceps, 5 1/8 inch

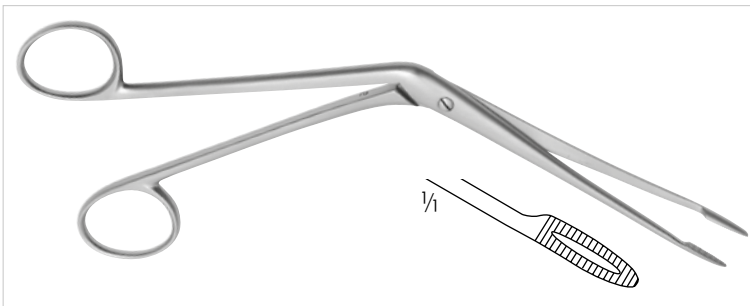

420-211-200
HARTMANN
Nasentamponzange, 215 mm
Nasal dressing forceps, 8 1/4 inch

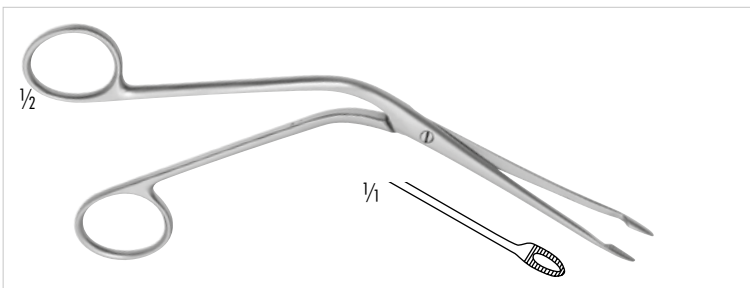

420-211-160
HARTMANN
Nasentamponzange, 175 mm
Nasal dressing forceps, 7 inch

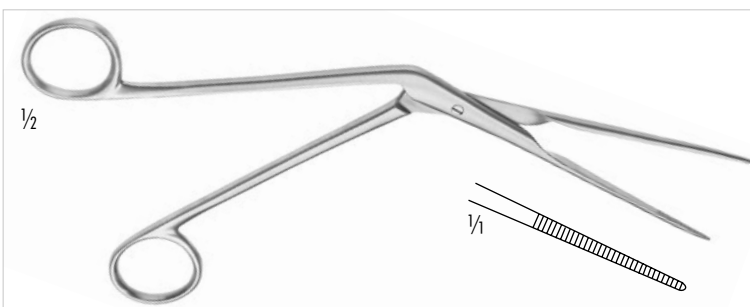

420-411-200
WEST
Nasentamponzange, 200 mm
Nasal dressing forceps, 8 inch

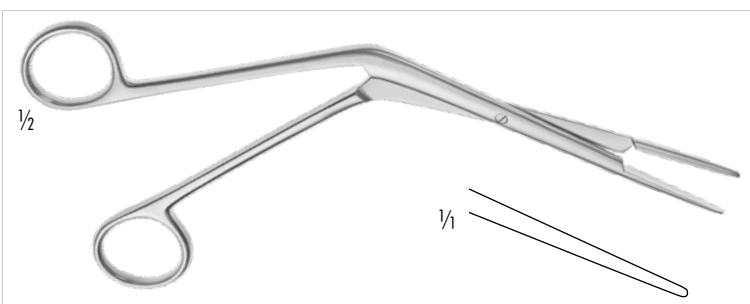

420-210-200
LUBET-BARBON
Nasentamponzange, 200 mm
Nasal dressing forceps, 8 inch



410-389-190

GRUENWALD

Nasenpinzetten, anatomisch, bajonettförmig, 200 mm
Nasal dressing forceps, bayonet shaped, 8 inch

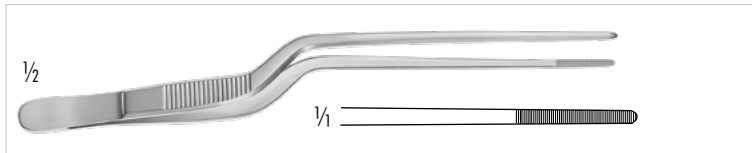

410-395-160

JANSEN

Nasenpinzetten, anatomisch, bajonettförmig, 160 mm
Nasal dressing forceps, bayonet shaped, 6 1/4 inch

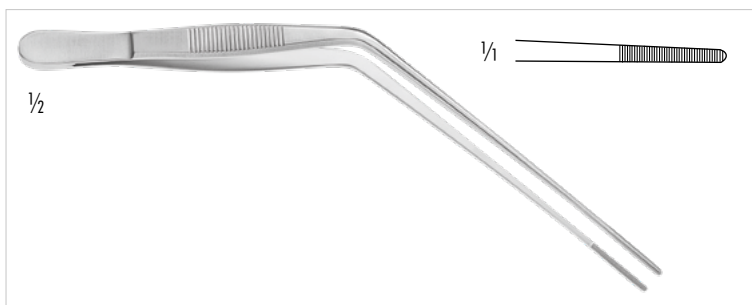

420-375-165

TROELTSCH (WILDE)

Nasenpinzetten, anatomisch, kniegebogen, 170 mm
Nasal dressing forceps, knee bent, 6 3/4 inch



410-228-000

Universal Pulverbläser, mit beweglicher Nasenolive,
Schraubflasche 30 ccm und Halbgebläse
Universal Powder Blower, with adjustable nozzle,
threaded flacon 30 ccm and Rubber Bulb

410-228-100

Halbgebläse allein / Rubber Bulb only

410-228-010

aufsteckbare Nasenolive, allein / Nose guard, only

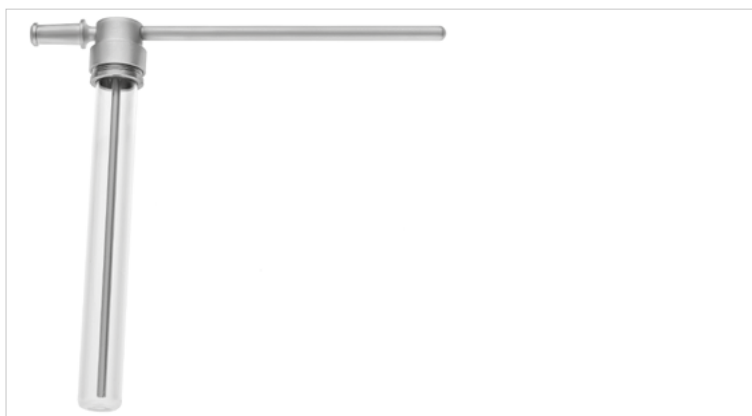

410-229-000

GRUENWALD

Zerstäuber mit gerader Kanüle, 130 mm
Atomizer with straight cannula, 5 1/8 inch

410-229-050

GRUENWALD

Ersatzflacon mit Gewinding
Threaded Spare Bottle only

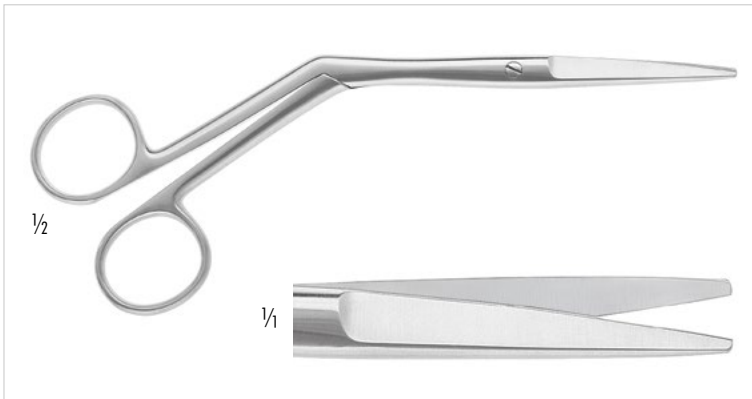

- 120-284-180 gerade/straight
gezahntes oberes Blatt/
serrated upper blade
- 120-287-180 rechts gebogen/right curved
gezahnt/serrated
- 120-285-180 links gebogen/left curved
gezahnt/serrated
- 120-585-180 **TC**, unteres Blatt gezahnt, gerade
TC, lower blade serrated, straight

HEYMANN
Nasenschere, 190 mm,
Nasal scissors, 7 1/2 inch

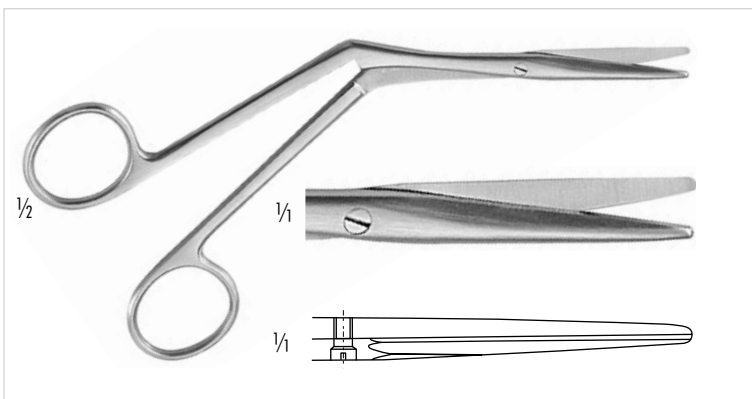

120-283-180
HEYMANN-KNIGHT
Nasenschere, 180 mm
Nasal scissors, 7 inch

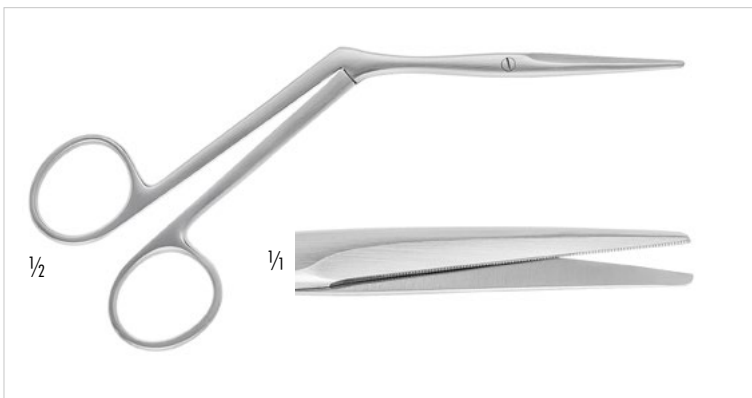

120-285-175
KIRSTEIN
Nasenschere, gezahnt, 180 mm
Nasal scissors, serrated, 7 inch

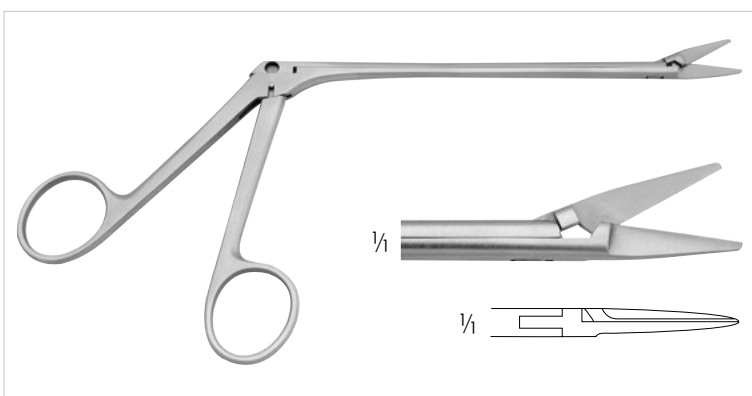

120-208-230
OLIVECROW
Nasenschere, 230 mm
Nasal scissors, 9 inch

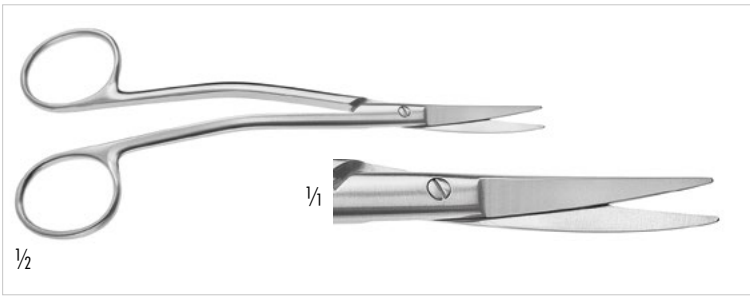

120-306-140

JOSEPH

Nasenschere, doppelt gebogen, stumpf, 140 mm
Nasal scissors, double curved, blunt, 5 1/2 inch



420-408-003 3 mm

420-408-004 4 mm

KRESSNER

Muschelquetschzangen, 220 mm
Crushing forceps, 8 3/4 inch

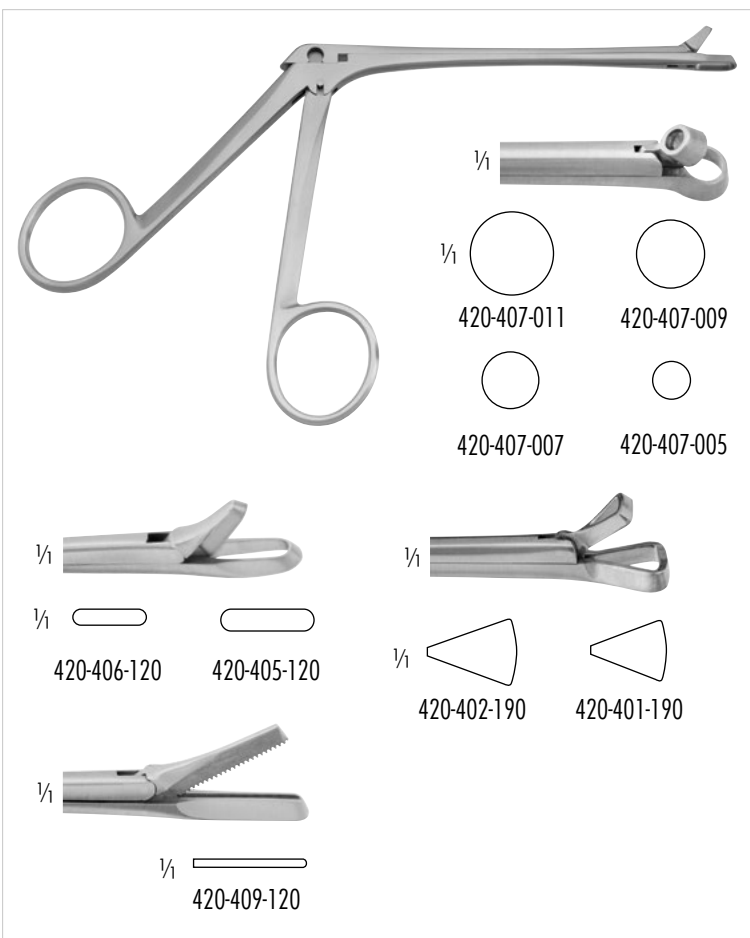

420-407-005 5mm

420-407-007 7mm

420-407-009 9mm

420-407-011 11mm

HARTMANN

Conchotom, durchschneidend, 120 mm
Nasal cutting forceps, through cutting, 4 1/2 inch

420-405-120 3,5 x 11mm

420-406-120 2,0 x 9,5mm

GRUENWALD-HENKE

Conchotom, durchschneidend
Nasal cutting forceps, through cutting

420-401-190 Fig. 1

420-402-190 Fig. 2

SCHMEDEN

Conchotom, durchschneidend
Nasal cutting forceps, through cutting

420-409-120

STRUYCKEN

Conchotom, durchschneidend
Nasal cutting forceps, through cutting



420-401-001 7 mm, Fig.1
420-401-002 8 mm, Fig.2

MELZER

Adenoidzange, durchschneidend, rund, mit Gitter, 140 mm
Adenoid Forceps, through cutting, round, with basket, 140 mm



420-421-001 3 mm Schnitt/3 mm bite Fig.1
420-421-002 3,5 mm Schnitt/3.5 mm bite Fig.2
420-421-003 4 mm Schnitt/4 mm bite Fig.3

GRUENWALD

Nasenzange, durchschneidend, ovaler Schnitt, Arbeitslänge: 115 mm
Nasal Forceps, through cutting, oval bite, Working length: 4 1/2 inch

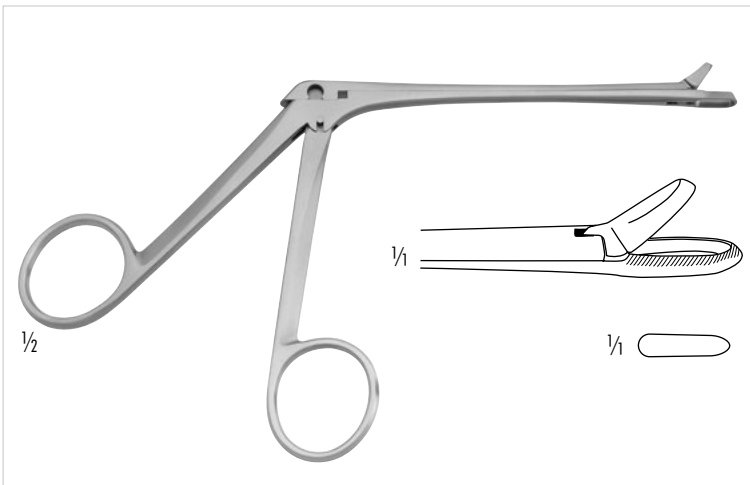

420-410-120

MYLES

Conchotom, durchschneidend, 120 mm
Nasal cutting forceps, through cutting, 4 3/4 inch

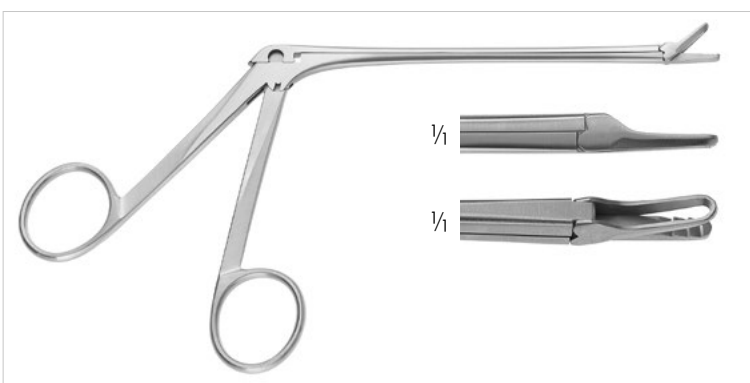

420-410-140

MYLES

Conchotom, durchschneidend, 2,5 x 11,5 mm flaches, gezahntes Maul, Arbeitslänge: 140 mm
Nasal Punch, through cutting, 2.5 x 11.5 mm flat, serrated jaw, Working length: 5 1/2 inch

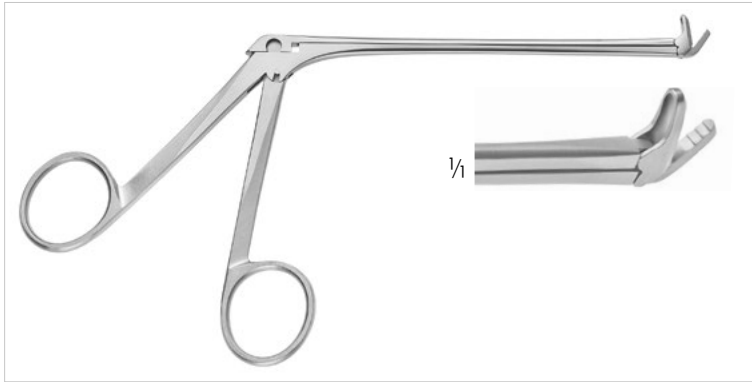

420-413-140

MYLES

Conchotom, durchschneidend, gezahnt, 30° aufgebogen,
Arbeitslänge: 140 mm

Nasal Punch, through cutting, serrated, 30° upcurved shaft,
Working length: 5 1/2 inch

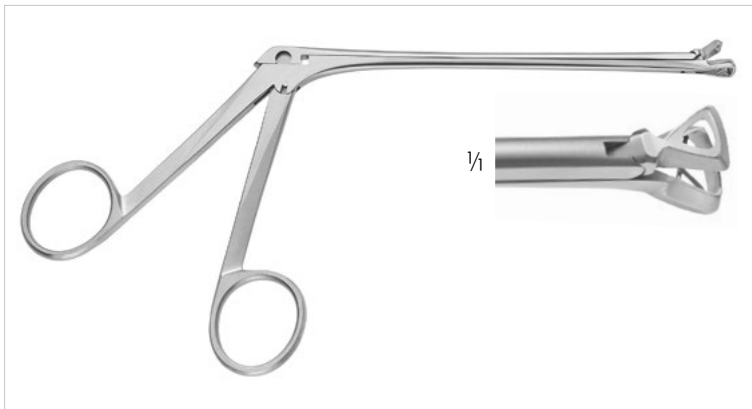

420-401-100 6 mm, Fig.0

420-401-101 7 mm, Fig.1

420-401-102 8 mm, Fig.2

420-401-103 10 mm, Fig.3

MELZER

Adenoidzange, durchschneidend, dreieckig, mit Gitter,
Arbeitslänge: 140 mm

Adenoid Forceps, through cutting, triangular, with basket,
Working length: 5 1/2 inch

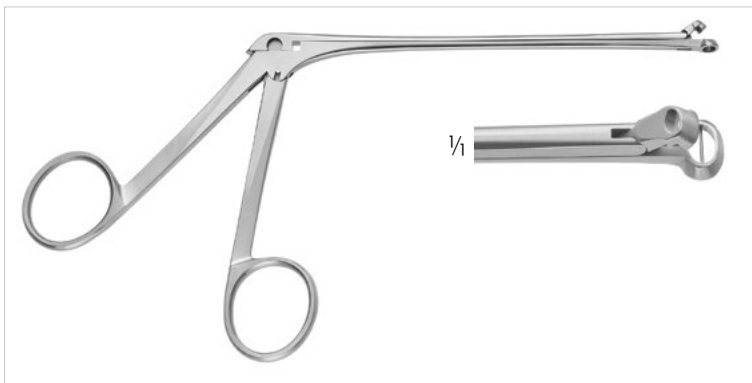

420-401-201 5,2 x 3,2mm Fig.1

MELZER

Adenoidzange, durchschneidend, oval, Arbeitslänge: 140 mm

Adenoid Forceps, through cutting, oval, Working length: 5 1/2 inch



420-414-120 gerade/straight

420-415-120 links gebogen/left curved

420-416-120 rechts gebogen/right curved

Nasenschere, 120 mm

Nasal scissors, 4 3/4 inch

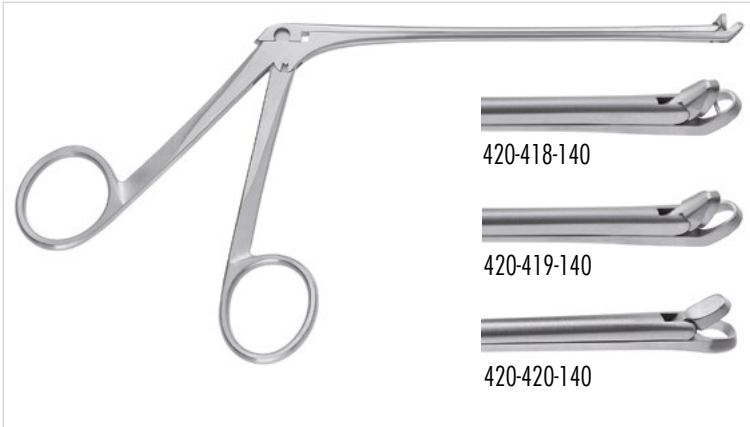

- 420-418-140 Mit Gitter, aufgebogen/
with basket, curved up
- 420-419-140 Ohne Gitter, aufgebogen/
without basket, curved up
- 420-420-140 Ohne Gitter, gerade/
without basket, straight

WATSON-WILLIAMS

Nasenzange, durchschneidend, 3 mm Schnitt,
Arbeitslänge: 140 mm
Nasal Forceps, through cutting, 3 mm bite,
Working length: 5 1/2 inch

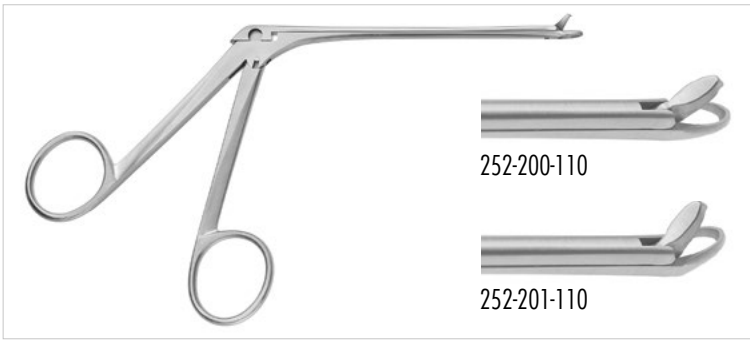

- 252-200-110 2 mm Schnitt, gerade/bite, straight
- 252-200-111 2,5 mm Schnitt, gerade/bite, straight
- 252-200-112 3 mm Schnitt, gerade/bite, straight
- 252-201-110 2 mm Schnitt, aufgebogen/bite, upcurved
- 252-201-111 2,5 mm Schnitt, aufgebogen/bite, upcurved
- 252-201-112 3 mm Schnitt, aufgebogen/bite, upcurved

BLAKESLEY

Nasenzange, durchschneidend, 115 mm
Nasal Forceps, through cutting, 4 1/2 inch

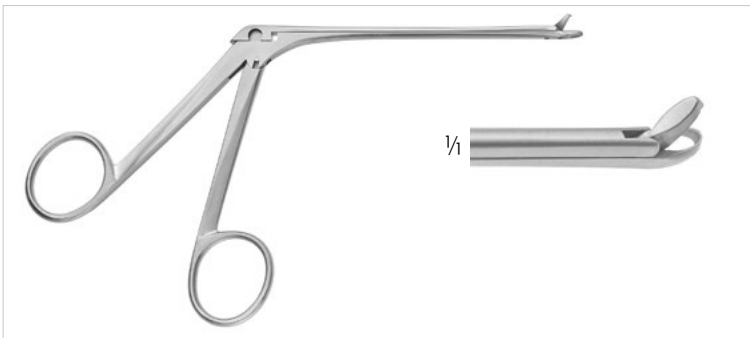

- 252-202-111 Fig.1 links gebogen/left curved jaw
- 252-203-111 Fig.2 rechts gebogen/right curved jaw

BLAKESLEY

Nasenzange, durchschneidend, 2,5mm Schnitt, 115mm
Nasal Forceps, though cutting, 2.5mm cut, 4 1/2 inch



- 252-477-141 rückwärts öffnend/backward cutting
- 252-477-142 links öffnend/left side cutting
- 252-477-143 rechts öffnend/right side cutting

NICOLAI

Stirnhöhlezange 2mm Schnitt, 65° aufgebogen
Antrum Forceps, 2mm bite, 65° angled upwards



252-526-115 **NOYES** gefenstert/fenestrated
1x2 Zähne/teeth

252-527-115 **NOYES** gefenstert/fenestrated

252-528-115 **MORGENSTEIN**

252-529-115 **BLAKESLEY**

252-530-115 **FERRIS-SMITH**

Nasenzange mit Quersähen, Arbeitslänge: 115 mm

Nasal Forceps with serrated jaws, Working length: 4 1/2 inch

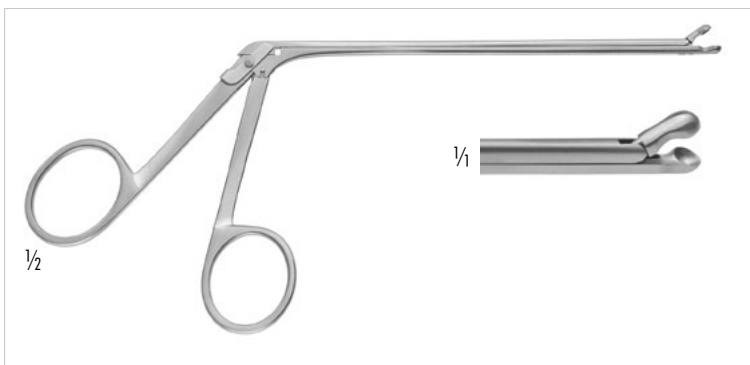

420-223-170

HILDYARD

Löffelzängchen, 3,5 mm Löffel, 120 mm Schaftlänge,
Arbeitslänge: 120 mm

Post-Nasal Biopsy Forceps, 3.5 mm biopsy cup, shaft

Working length: 4 3/4 inch



252-539-115

LEWIS

Nasenzange seitlich links öffnend, Arbeitslänge: 115mm

Nasal Forceps, round grooved jaws, opening to left side,

Working length: 4 1/2 inch

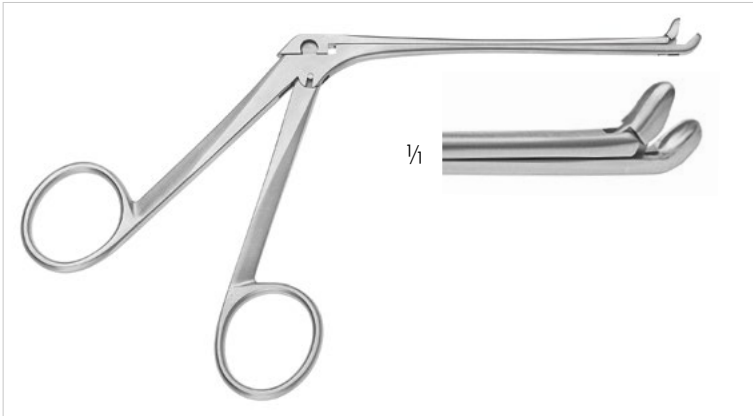

252-425-115

BEAD

Bead Nasenzange mit Löffel, aufgebogen, kleines Modell, Arbeitslänge: 115mm

Nasal Forceps with cup jaws, upturned, small model, Working length: 4 1/2 inch

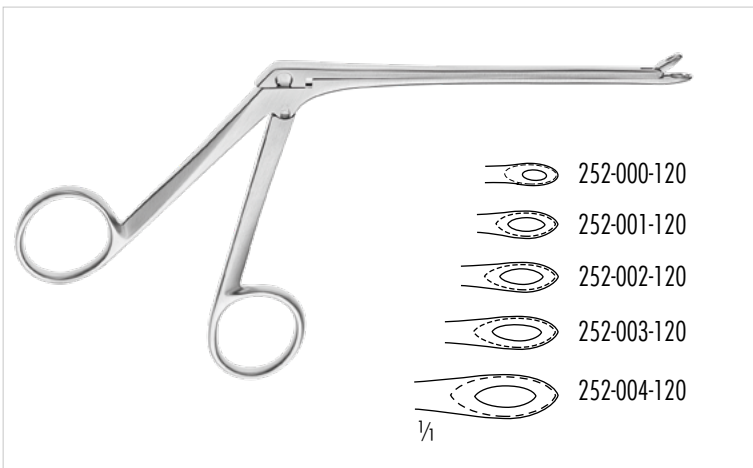

- 252-000-120 Fig.0 3,0 mm
- 252-001-120 Fig.1 3,6 mm
- 252-002-120 Fig.2 4,2 mm
- 252-003-120 Fig.3 4,8 mm
- 252-004-120 Fig.4 5,6 mm

WEIL-BLAKESLEY

Siebbeinzangen, gerade, ovaler Löffel, gefensterter Maul, 120 mm

Ethmoidal forceps, straight, oval, cup-shaped fenestrated jaws, 4 3/4 inch

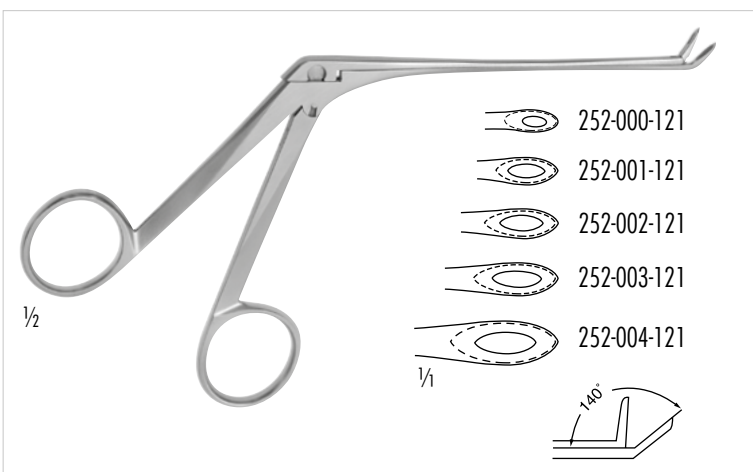

- 252-000-121 Fig.0 3,0 mm
- 252-001-121 Fig.1 3,6 mm
- 252-002-121 Fig.2 4,2 mm
- 252-003-121 Fig.3 4,8 mm
- 252-004-121 Fig.4 5,6 mm

WEIL-BLAKESLEY

Siebbeinzangen, aufgebogen, ovaler Löffel, gefensterter Maul, 110 mm

Ethmoidal forceps, upwards curved, oval cup, fenestrated jaws, 4 1/2 inch



252-000-111

STRUEMPEL-VOSS

Siebbeinzange 45° aufgebogen, besonders fein, 2,5mm
110 mm Schaft

Ethmoidal forceps, 45° upwards curved, oval, very delicate, 2.5mm
110 mm shaft

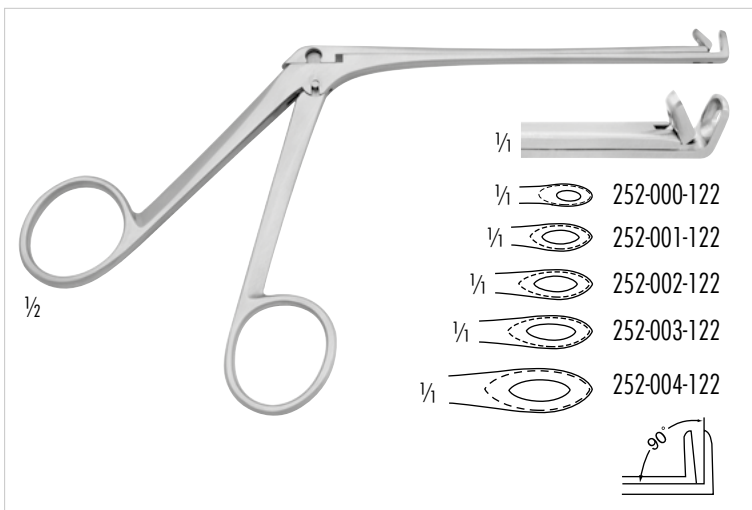

252-000-122 Fig.0 3,0 mm

252-001-122 Fig.1 3,6 mm

252-002-122 Fig.2 4,2 mm

252-003-122 Fig.3 4,8 mm

252-004-122 Fig.4 5,6 mm

WEIL-BLAKESLEY

Siebbeinzange, 90° aufgewinkelt, 110 mm
Ethmoidal forceps, 90° angled up, 4 1/2 inch



0°

252-035-150 Größe/Size 1: 3,5mm

252-040-150 Größe/Size 2: 4,0mm

252-050-150 Größe/Size 3: 5,0mm

45°

252-035-151 Größe/Size 1: 3,5mm

252-040-151 Größe/Size 2: 4,0mm

90°

252-035-152 Größe/Size 1: 3,5mm

252-040-152 Größe/Size 2: 4,0mm

BLAKESLEY

Nasenzange, Arbeitslänge: 150mm Arbeitslänge:
Nasal Forceps, working length: 6 inch

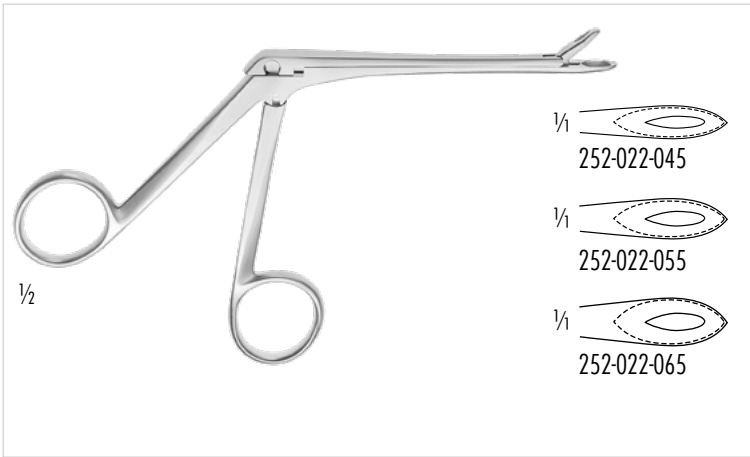

252-022-045 4,5 mm
 252-022-055 5,5 mm
 252-022-065 6,5 mm

TILLEY HENCKEL

Siebbeinzange, gerade, Schaft graduert, 115 mm
 Ethmoidal forceps, straight, shaft graduated, 4 1/2 inch



252-410-130 2 mm, gerade/straight
 252-410-131 3 mm, gerade/straight
 252-413-131 3 mm, aufgebogen/curved up

TAKAHASHI

Siebbeinzange, oval, Löffelmaul, 120 mm
 Ethmoidal forceps, oval, cup-shaped, 4 3/4 inch



252-534-100
 Siebbeinzange, gerade, 140 mm
 Ethmoidal forceps, straight, 5 1/2 inch



252-530-120
WATSON-WILLIAMS
 Schleimhaut Faßzange, gezahnt, gerade, 120 mm
 Ethmoidal mucosa forceps, serrated jaws, straight, 4 3/4 inch

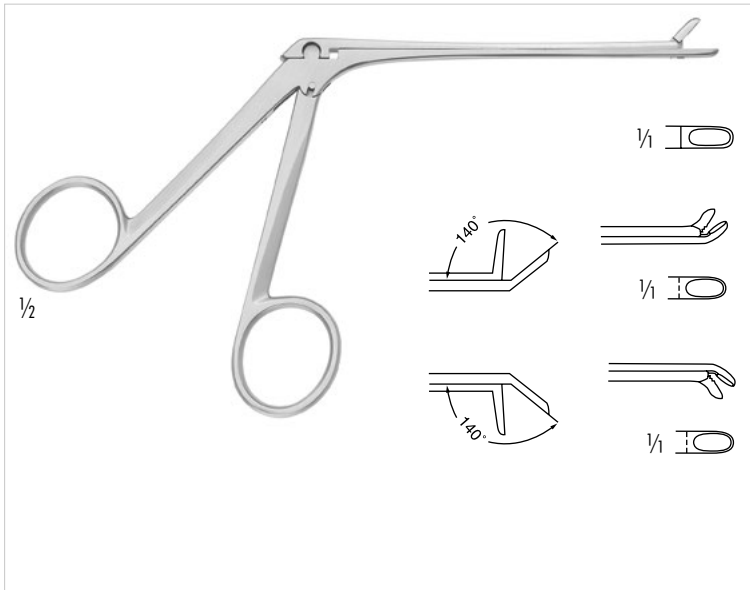

- 252-536-115 gerade/straight
- 252-537-115 aufgebogen/curved up
- 252-538-115 abgebogen/curved down

ST BARTS

Rongeur, 3 mm, 110 mm
 Rongeur, 3 mm, 4 1/3 inch

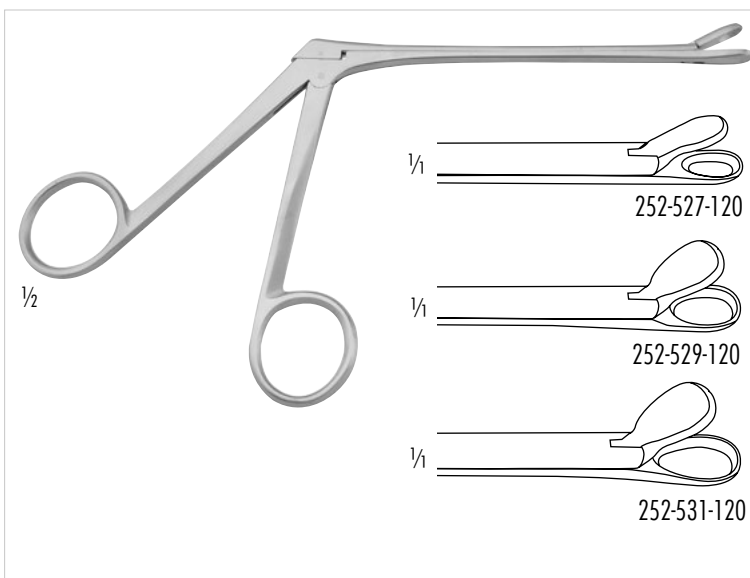

- 252-527-120 Fig.0
- 252-529-120 Fig.1
- 252-531-120 Fig.2

WATSON-WILLIAMS

Siebbeinzange, 115 mm
 Ethmoidal forceps, 4 1/2 inch

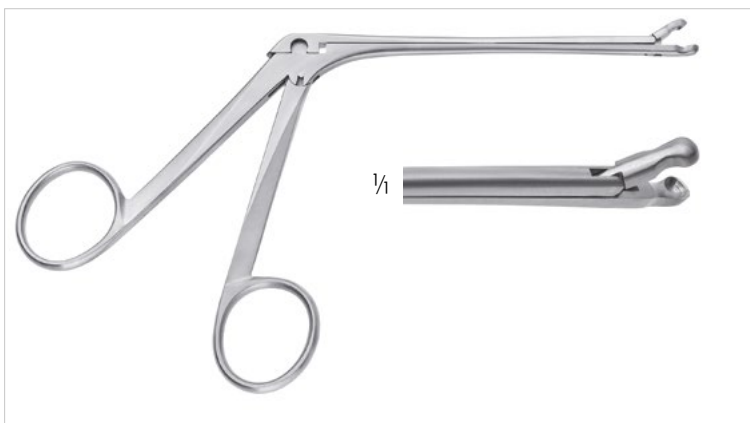

252-426-100 Ø 3.5 mm
 Nasenzange mit rundem Löffel, 115 mm
 Sinus Cup Forceps, 4 1/2 inch

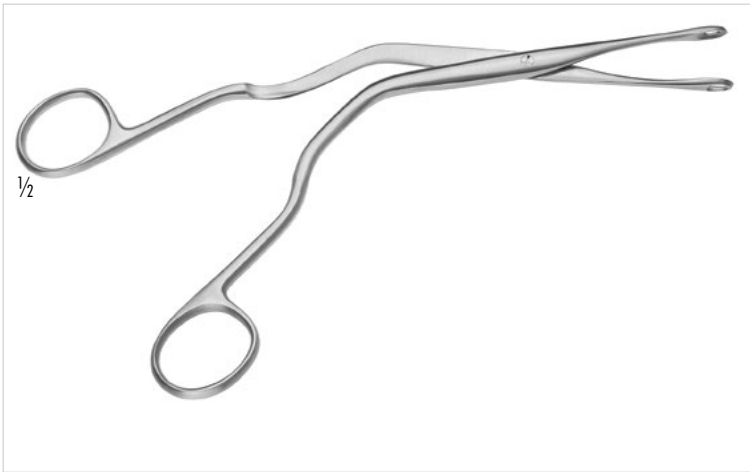

- 420-400-001 6,0 mm
- 420-400-002 7,5 mm
- 420-400-003 9,0 mm

LUC

Septumzange, gefenstert, 190 mm
Septum forceps with fenestrated jaws, 7 1/2 inch

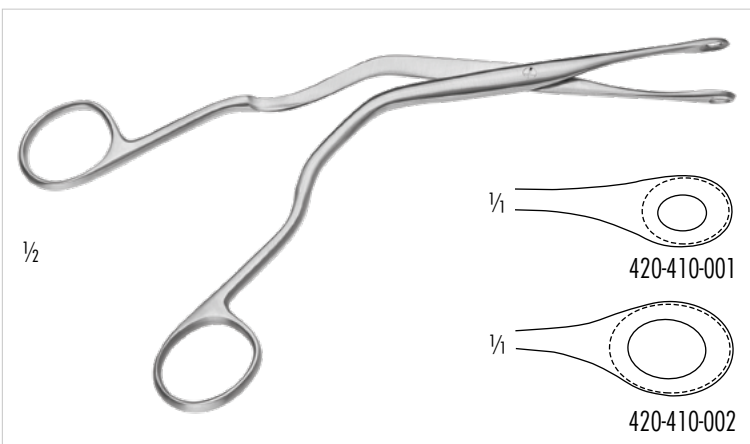

- 420-410-001 Fig. 1
- 420-410-002 Fig. 2

LUC

Septumzange, gefenstert, 200 mm
Septum forceps with fenestrated jaws, 8 inch

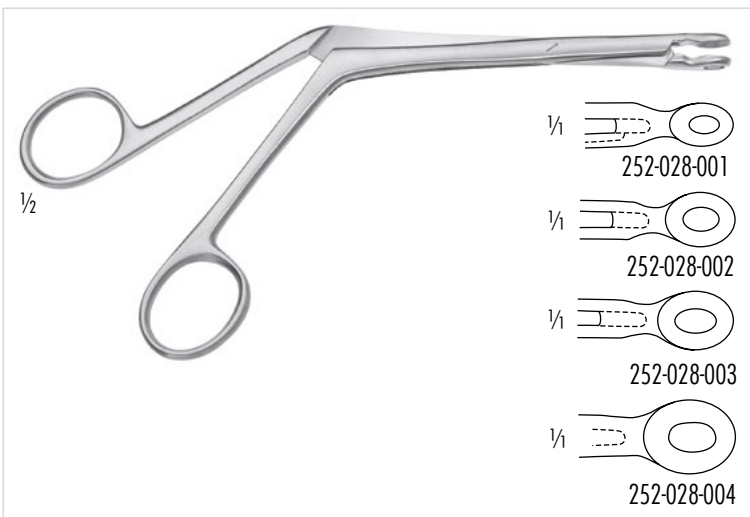

- 252-028-001 Größe/Size 1
- 252-028-002 Größe/Size 2
- 252-028-003 Größe/Size 3
- 252-028-004 Größe/Size 4

BRUENINGS

Septumzange, gefenstert, 190 mm
Septum forceps, fenestrated jaws, 7 1/2 inch



- 252-029-000 6mm

CRAIG

Vormerzange, gerade, scharfer Löffel oval, 165 mm
Septum bone cutting and breaking forceps straight, sharp cup, 6 1/2 inch

- 252-029-165 6mm

CRAIG

Vormerzange mit eckigen Schneidkanten, 165 mm
Septum bone cutting and breaking forceps straight, sharp cup, 6 1/2 inch

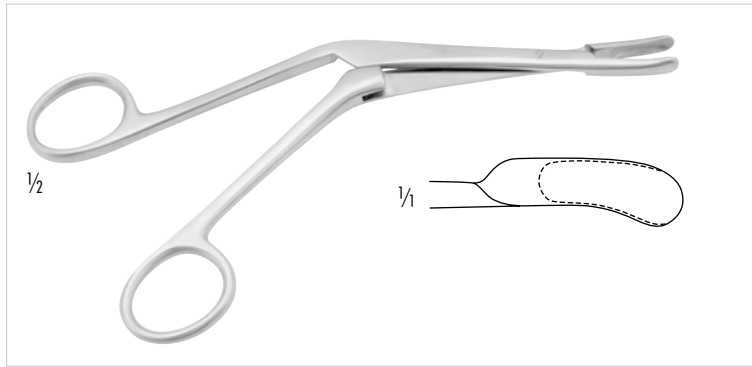

252-029-500

CRAIG-DOMNICK

Vormerzange, linksgebogen, scharfe Löffel, 165 mm
 Septum bone cutting and breaking forceps, curved to the left,
 sharp cup, 6 1/2 inch

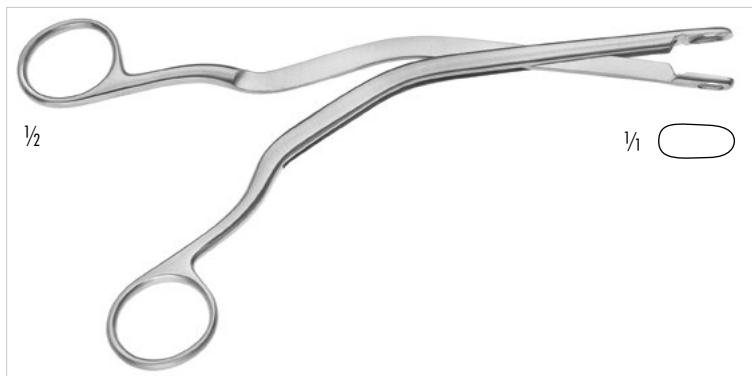

420-412-190

IRWIN MOORE

Septumzange, 190 mm
 Septum forceps, 7 1/2 inch



420-422-190

HEYMANN-KNIGHT

Septumzange, scharfer ovaler Löffel, 190 mm
 Septum forceps, with sharp oval cup, 7 1/2 inch

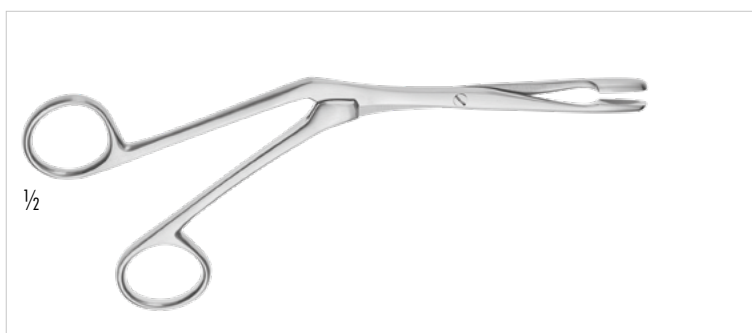

420-214-180

KNIGHT

Nasenzange, scharf, 180 mm
 Nasal forceps, sharp, 7 inch



252-031-190 4x14 mm großes Modell / large pattern
 252-033-190 3x13 mm kleines Modell / small pattern
JANSEN-MIDDLETON
 Nasenzange, durchschneidend, 210 mm
 Nasal forceps, through cutting, 8 1/4 inch



252-032-190 4x11 mm
JANSEN-MIDDLETON
 Nasenzange, Löffelmaul, 170 mm
 Nasal forceps, cup-shaped, 6 3/4 inch



420-213-180
BECKER
 Septumschere mit Doppelgelenk, gezahnt, 180 mm
 Septum scissors, double action, with serrated jaws, 7 inch



120-286-220 gerade Schneide/straight cutting edge
CAPLAN
 Nasenschere, 220 mm
 Nasal scissors, 8 1/2 inch

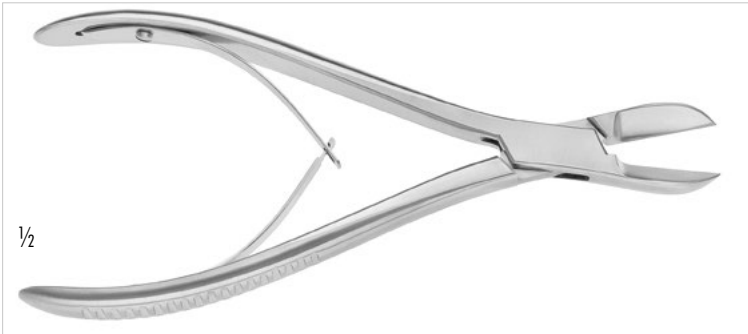

210-845-185

COTTLE-KAZANJIAN

Knochensplitterzange, zum Entfernen eines Nasenhöckers, 180 mm
 Bone cutting forceps, for removal of nasal hump, 7 inch

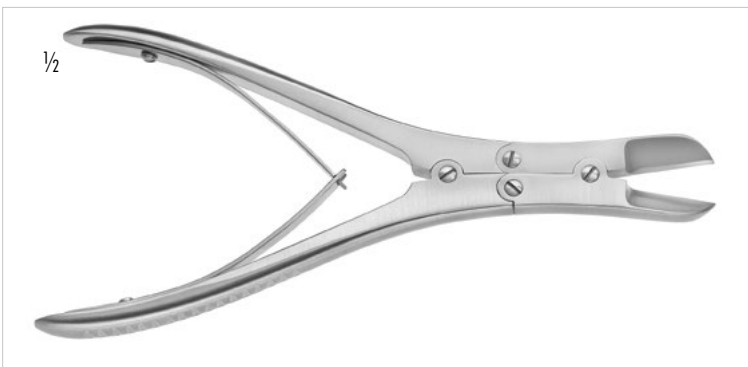

210-855-180

RUSKIN-ROWLAND

Nasenzange mit Doppelgelenk, gerade, 180 mm
 Nasal hump rongeur, double action, straight, 7 inch



420-370-210

RUBIN

Knorpelquetschzange mit Doppelgelenk, gerade, 220 mm
 Septum morcelizer, double action, straight, 8 1/2 inch



420-371-210

RUBIN

Knorpelquetschzange mit Doppelgelenk, abgewinkelt, 220 mm
 Septum morcelizer, double action, angled, 8 1/2 inch

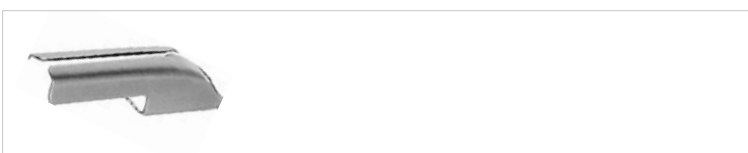

420-370-212

Schutzkappe für RUBIN Quetschzange 420-370-210 + 420-371-210
 Protection cap for RUBIN septum morcelizer
 420-370-210 + 420-371-210

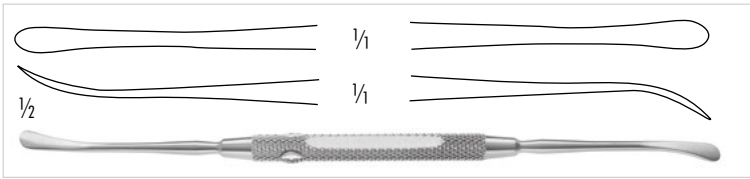

420-546-180 5 mm

FREER

Elevatorium, scharf/stumpf, 185 mm
Elevator, sharp /blunt, 7 1/4 inch

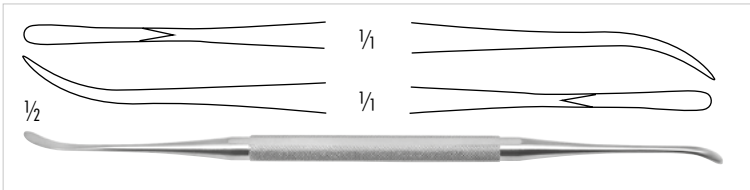

420-548-180

FREER-YASARGIL

Dissektor, scharf, 190 mm
Dissector, sharp, 7 1/2 inch



210-528-240

COHEN

Elevator, doppelendig, 240mm
Elevator, double-ended, 9 1/2 inch



420-556-200

WOODSON

Elevator, 2,4 / 4,0mm Blatt, 200mm
Elevator, 2.4 / 4.0mm blade, 8 inch

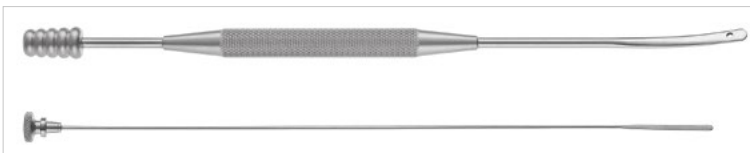

420-395-205 6 mm

NEGUS

Saugdissektor, stumpf 210 mm
Suction dissector, blunt, 8 1/4 inch

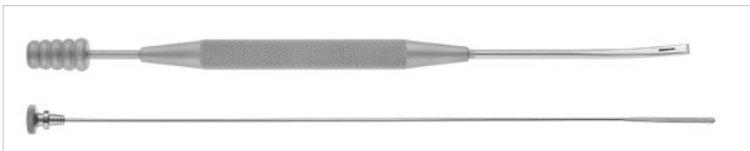

420-253-185 3 mm

GORNEY

Saugraspatorium, halb-scharf 180 mm
Suction raspatory, semi-sharp 7 inch

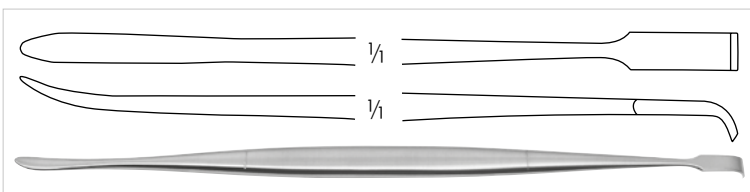

420-552-215

HOWARTH

Doppel-Elevatorium, 215 mm
Elevator, double-ended, 8 1/4 inch

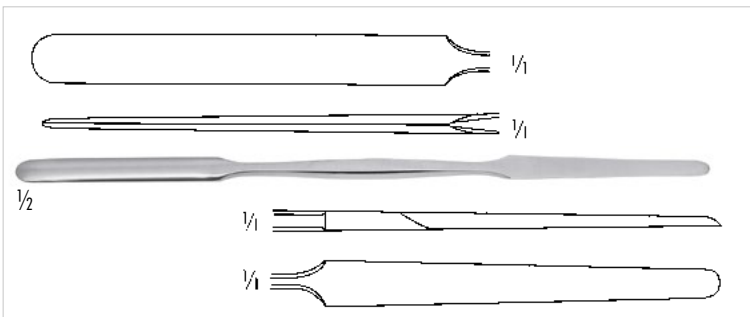

420-541-180

KILLIAN

Doppel-Elevatorium, scharf/stumpf, 185 mm
Elevator, double-ended, sharp/blunt, 7 1/4 inch

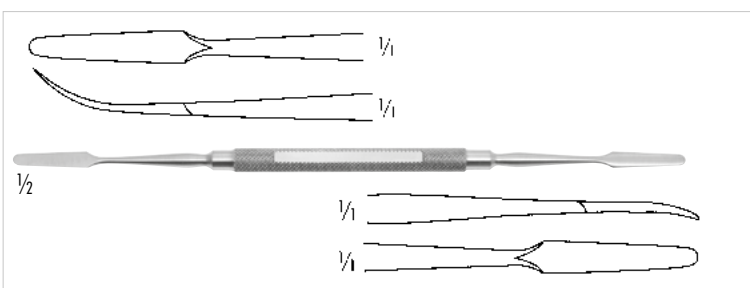

420-540-180

KILLIAN

Doppel-Elevatorium, scharf/stumpf, 180 mm
Elevator, double-ended, sharp/blunt, 7 inch



252-002-180

KILLIAN

Doppel-Elevatorium, schiffenförmig, scharf/stumpf, 180 mm
Septum double-ended elevator, shuffle-shaped, sharp/blunt, 7 inch



252-001-200

FREER

Doppel-Elevatorium, halbscharf/stumpf, 200 mm
Septum double-ended elevator, semi-sharp/blunt, 8 inch

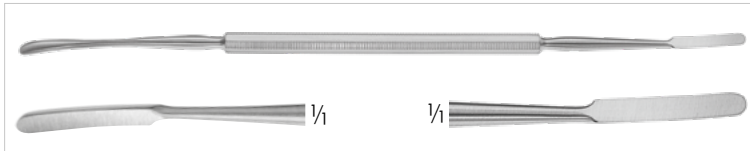

420-555-200

FREER-JOSEPH

Doppel-Elevatorium, 200 mm
Septum double-ended elevator, 8 inch



420-551-200

MASING

Elevatorium, doppelendig, graduert, scharf/stumpf, 200 mm
Elevator, double-ended, graduated, sharp/blunt, 8 inch



420-550-230

COTTLE

Doppel-Elevatorium, graduert, scharf/stumpf, 210 mm
Elevator, double-ended, graduated, sharp/blunt, 8 1/4 inch

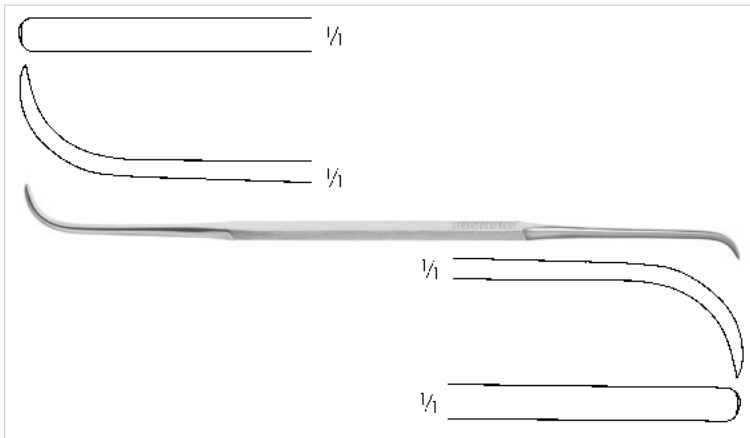

420-552-200

COTTLE

Doppel-Elevatorium, zum Tunnelieren, 220 mm
Elevator, double-ended, for tunneling, 9 inch

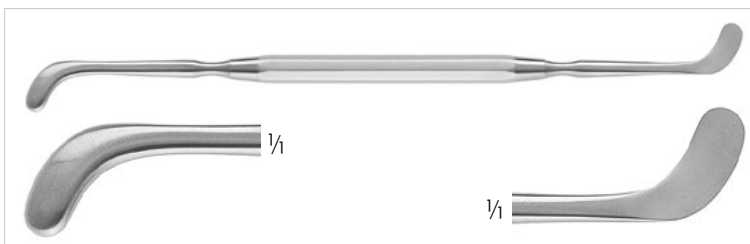

420-543-210

PENNINGTON

Elevatorium, 210 mm
Elevator, 8 1/4 inch



420-551-175

FREER

Raspatorium, doppelendig, scharf, 175 mm
Periosteal elevator, double-ended, sharp, 7 inch

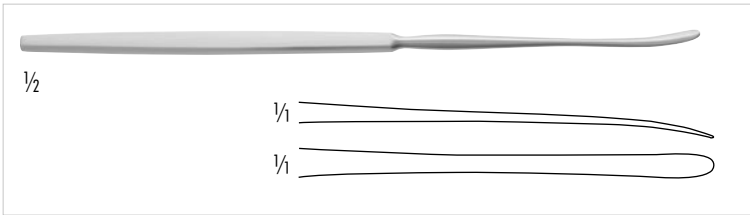

420-544-165 4,0 mm

HALLE

Elevatorium, stumpf, 180 mm
Elevator, blunt, 7 inch

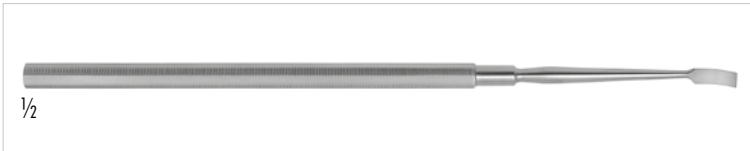

420-551-180 4 mm

FREER

Raspatorium, 160 mm
Periosteal elevator, 6 1/2 inch

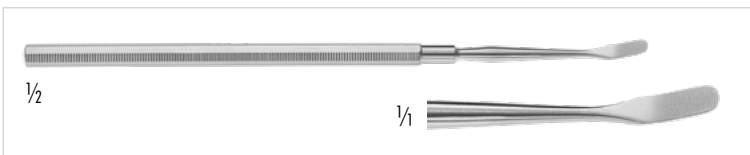

420-557-165 4,0 mm

Raspatorium, abgewinkelte Spitze, 165 mm
Periosteal elevator, angled tip, 6 1/2 inch

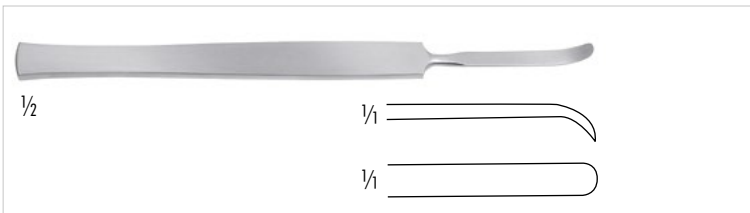

420-547-004 4 mm

420-547-005 5 mm

MC KENTY

Septum Elevatorium, gebogen, scharf, 155 mm
Septum periosteal elevator, curved, sharp, 6 inch



420-547-006

ERLANGEN

Raspatorium, 6mm breit, leicht gebogen, 175 mm
Raspatory, 6mm wide, slightly curved, 7 inch

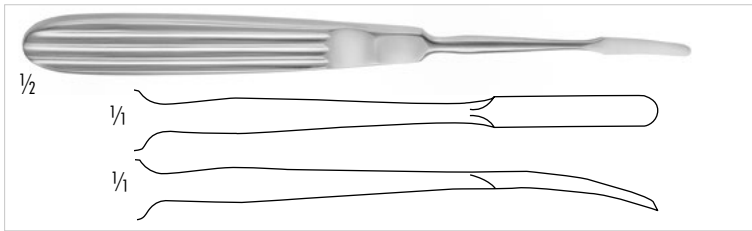

- 420-530-165 2 mm
- 420-531-165 3 mm
- 420-532-165 4 mm
- 420-533-165 5 mm

JOSEPH

Periost-Raspatorium, leicht gebogen, 170 mm
 Periosteal elevator, slightly curved, 6 3/4 inch

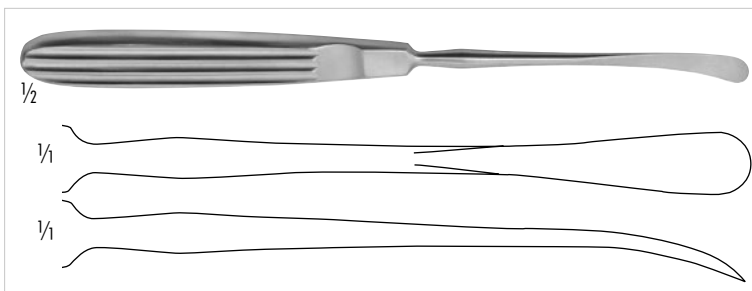

- 210-438-195 8 mm

COTTLE

Elevatorium, gebogen, scharf, 190 mm
 Elevator, curved, sharp, 7 1/2 inch

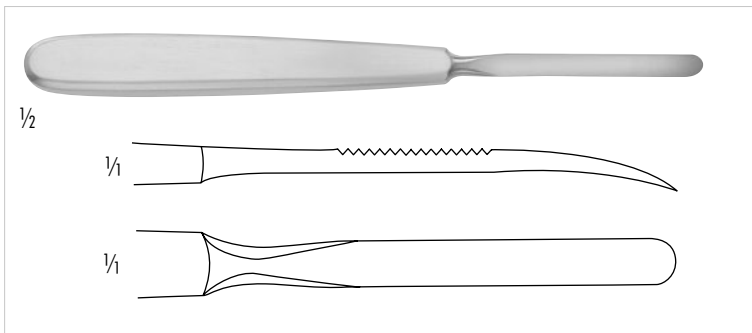

- 210-439-006 6 mm
- 210-439-008 8 mm

Periost-Raspatorium, leicht gebogen, 170 mm
 Periosteal elevator, slightly curved, 6 3/4 inch

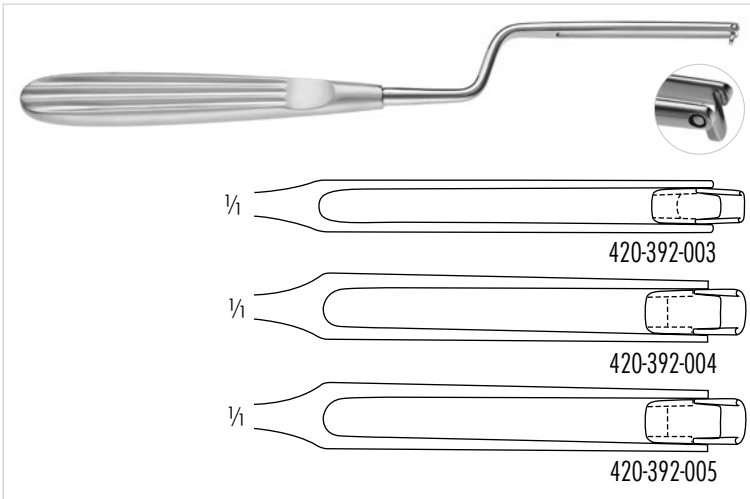

420-392-003 3 mm
 420-392-004 4 mm
 420-392-005 5 mm

BALLENGER

Schwingmesser, bajonettförmig, 210 mm
 Swivel knife, bayonet shaped, 8 1/4 inch

420-393-003 3 mm
 420-393-004 4 mm
 420-393-005 5 mm

BALLENGER

Schwingmesser, gerade, 195 mm
 Swivel knife, straight, 8 inch

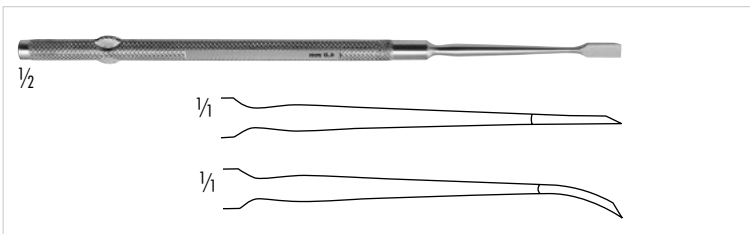

420-590-004 4 mm, gerade/straight
 420-591-004 4 mm, gebogen/curved

FREER

Septum Flachmeissel, 160 mm
 Septum chisel, 6 1/4 inch

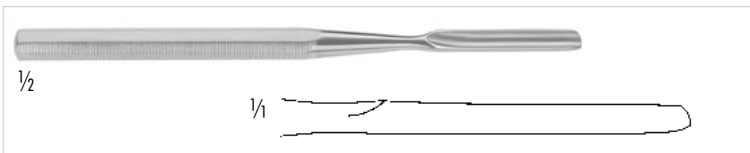

420-550-170 6 mm

FREER

Septum-Hohlmeissel, mit runder Schneide, gerade, 150 mm
 Septum gouge, straight, round cutting edge, 6 inch

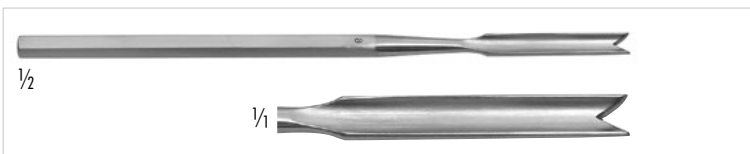

420-595-170 6 mm

BALLENGER

Septum-Hohlmeissel mit Kerbe, gerade, 155 mm
 Septum gouge, with notch and cutting edge, 6 inch

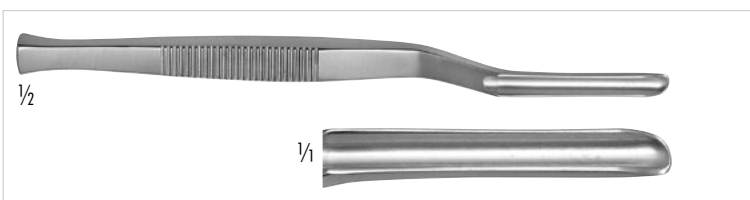

420-552-170 6 mm

KILLIAN

Septum-Hohlmeissel mit runder Schneide, bajonettförmig gebogen, 170 mm
 Septum gouge, round cutting edge, bayonet shaped, 6 3/4 inch

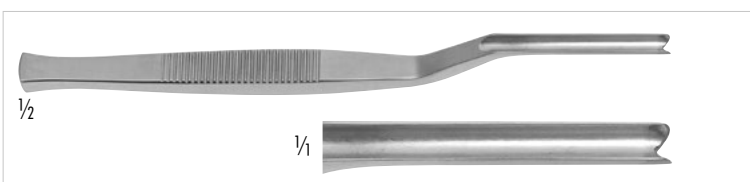

420-551-170 6 mm

KILLIAN-CLAUS

Septum-Hohlmeissel mit Kerbe, bajonettförmig gebogen, 170 mm
 Septum gouge with notch, bayonet shaped, 6 3/4 inch



- 210-488-004 4 mm
- 210-488-007 7 mm
- 210-488-009 9 mm
- 210-488-012 12 mm

COTTLE

Flachmeißel, graduiert, 185 mm
Chisel, graduated, 7 1/4 inch

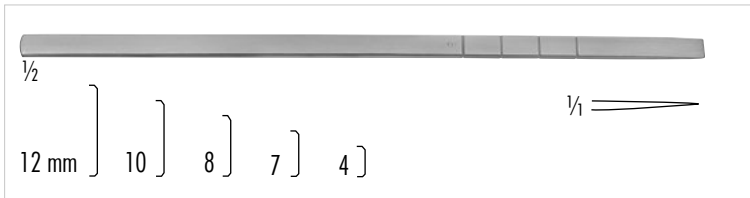

- 210-487-004 4 mm
- 210-487-007 7 mm
- 210-487-008 8 mm
- 210-487-010 10 mm
- 210-487-012 12 mm

COTTLE

Osteotom, graduiert, 180 mm
Osteotome, graduated, 7 inch

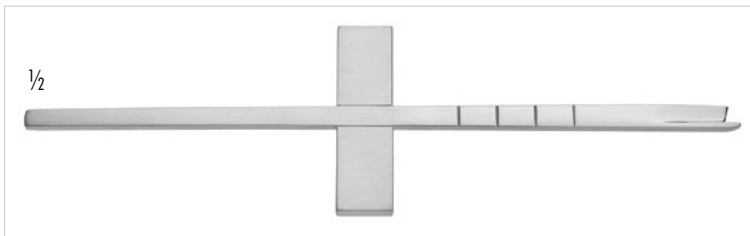

- 210-472-105 5mm

COTTLE

Osteotom mit Schutz und Crossbar, 185m
Osteotome with guard and crossbar, 7 1/4 inch

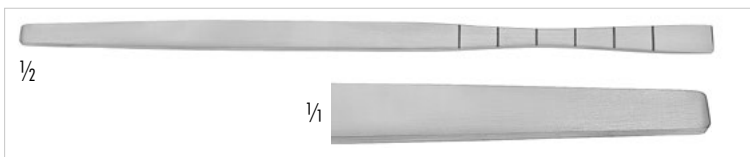

- 210-486-008 8 mm

COTTLE

Fischschwanz Osteotom, verrundete Ecken 180 mm
Fishtail osteotome, with protected ends, double guarded 7 inch



- 210-486-016

COTTLE

Fischschwanz Osteotom, mit Querbalken, 16mm,
runde Schneidkanten, 180mm
Fishtail osteotome, with crossbar, 16mm
with round cutting end, 7 inch

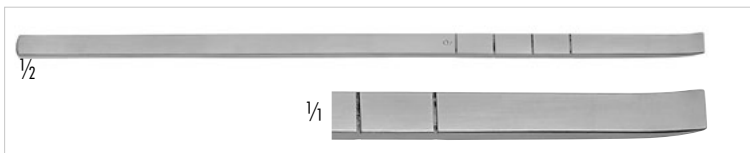

- 210-486-006 6 mm

COTTLE

Flachmeißel, gebogen, graduiert, für transversale Osteotomie, 180 mm
Chisel, curved, graduated, for transverse osteotomies, 7 inch

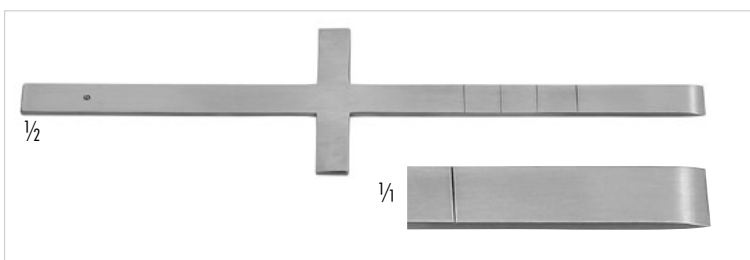

- 210-472-006 6 mm

COTTLE

Osteotom, gerade, 185 mm
Osteotome, straight, 7 1/4 inch

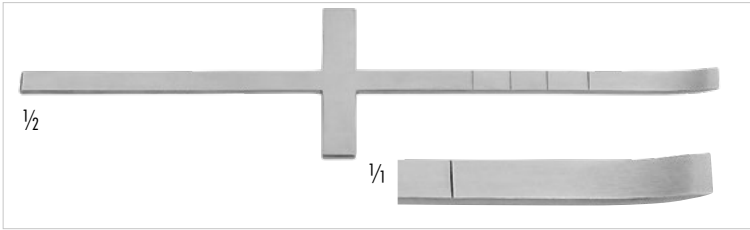

210-473-006 6 mm
COTTLE
 Osteotom, gebogen, 185 mm
 Osteotome, curved, 7 1/4 inch

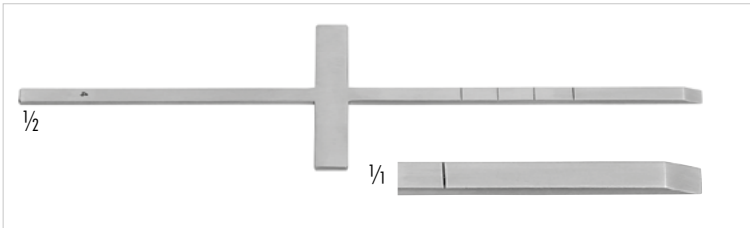

210-474-006
COTTLE
 Meißel, gerade, 6 mm, 185 mm
 Chisel, straight, 6 mm, 7 1/4 inch



420-587-008 8 mm
 420-587-010 10 mm
 420-587-012 12 mm
 420-587-014 14 mm
 420-587-016 16 mm
RUBIN
 Osteotom, 167 mm
 Osteotome, 6²/₃ inch



420-589-008 8 mm
 420-589-010 10 mm
 420-589-012 12 mm
 420-589-014 14 mm
 420-589-016 16 mm
CINELLI
 Osteotom, mit doppelter Führung, gerade, 160 mm
 Osteotome, double guarded, straight, 6 1/4 inch



420-587-177 6,5 mm
PARKES
 Höcker Hohlmeißel, 180 mm
 Hump gouge, 7 inch



420-459-001 gerade/straight
 420-459-002 rechts gebogen/curved right
 420-459-003 links gebogen/curved left
SILVER
 Nasenmeißel, 180mm
 Nasal Chisel, 7 inch



420-460-001 gerade/straight
 420-460-002 links/left
 420-460-003 rechts/right

SILVER

Osteotom, schmales Modell, 185 mm
 Osteotome, slender model, 7 1/4 inch



420-639-001 gerade/straight
 420-639-002 rechts gebogen/curved right
 420-639-003 links gebogen/curved left

ANDERSON-NEIVERT

Osteotom, 205 mm, 3,5 mm
 Osteotome, 8 inch, 3.5 mm



420-641-001 gerade/straight
 420-641-002 rechts/right
 420-641-003 links/left

GUNTER

Osteotom, 205 mm
 Osteotome, 8 inch



420-472-002 links/left
 420-472-003 rechts/right

GUASTELLA

Osteotom, 180 mm
 Osteotome, 7 inch



420-460-005

SILVER

Osteotom mit V-Spitze, gebogen, 175 mm
 Osteotome with V-tip, curved, 6 3/4 inch



420-491-001 links gebogen/curved left
 420-491-002 rechts gebogen/curved right
 420-491-000 gerade/straight

FRENCHAY

Nasenmeißel, mit Führung, 180 mm
 Nasal Chisel, with guard, 7 inch



420-586-004 4mm 420-586-006 6mm
 420-586-005 5mm 420-586-007 7mm

FOMON

Meißel, 170 mm
 Chisel, 6 3/4 inch



420-458-160

PARKES

Osteotom, mit einseitigem Schutz, 160 mm
 Osteotome with single guard, 6 1/3 inch



420-470-001 gerade/straight
 420-470-002 rechts gebogen/curved right
 420-470-003 links gebogen/curved left

RISTOW

Osteotom, 200 mm
 Osteotome, 8 inch

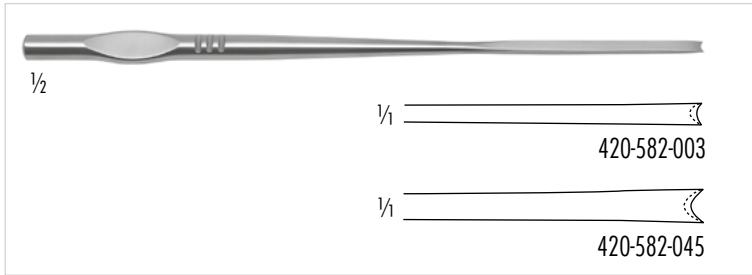

420-582-003 3,0 mm
420-582-045 4,5 mm

WALTER

Flachmeißel mit Hohlkehle, Spitzen verrundet, 190 mm
Chisel with notch, double guarded, 7 1/2 inch

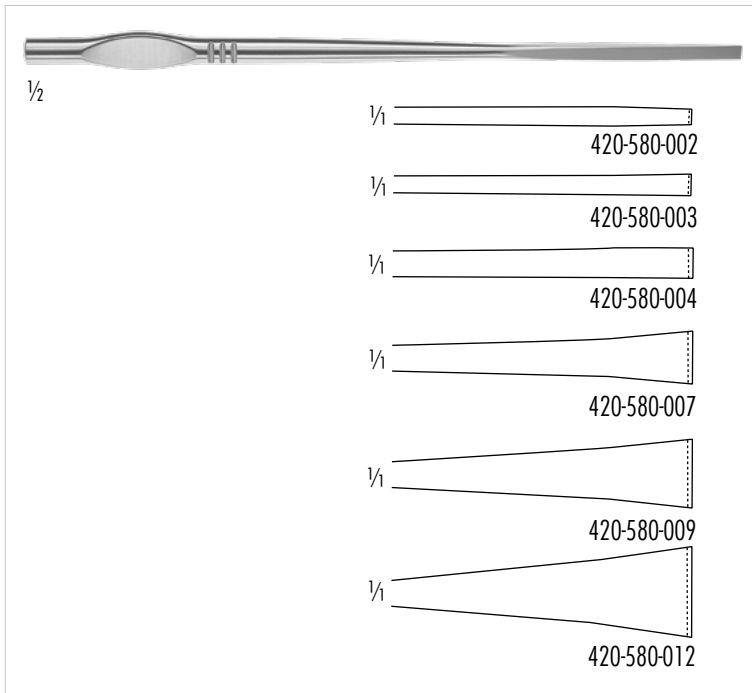

420-580-002 2,0 mm
420-580-003 3,0 mm
420-580-004 4,0 mm
420-580-007 7,0 mm
420-580-009 9,0 mm
420-580-012 12,0 mm

WALTER

Osteotom, 190 mm
Osteotome, 7 1/2 inch



420-568-002 2 mm
420-568-003 3 mm
420-568-004 4 mm
420-568-005 5 mm
420-568-006 6 mm
420-568-008 8 mm
420-568-010 10 mm

RZ-OSTEOTOME

Osteotom, 180 mm
Osteotome, 7 inch



420-572-002 2 mm
420-572-003 3 mm
420-572-004 4 mm
420-572-005 5 mm
420-572-010 10 mm
420-572-011 11 mm
420-572-012 12 mm

CONVERSE

Osteotom mit Stabilisierung, 180 mm
Osteotome with stabilizer, 7 inch



420-573-001 gerade/straight
 420-573-002 links/left
 420-573-003 rechts/right

CONVERSE

Meißel mit Schutz, 190mm
 Chisel with single guard, 7¹/₂ inch



420-500-200 3,0 mm

REES

Osteotom, mit Aluminium Handgriff, 200 mm
 Osteotome, with aluminum handle, 8 inch

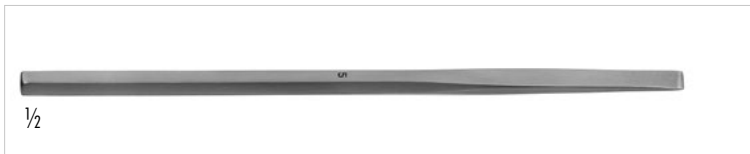

420-594-002	2 mm	420-594-007	7 mm
420-594-003	3 mm	420-594-008	8 mm
420-594-004	4 mm	420-594-010	10 mm
420-594-005	5 mm	420-594-012	12 mm
420-594-006	6 mm	420-594-015	15 mm

SHEEHAN

Osteotom, 160 mm
 Osteotome, 6¹/₃ inch



420-596-002	2 mm
420-596-003	3 mm
420-596-004	4 mm
420-596-006	6 mm
420-596-008	8 mm
420-596-010	10 mm
420-596-011	11 mm
420-596-015	15 mm

TARDY

Osteotom, 160 mm
 Osteotome, 6¹/₃ inch



420-496-001	1 mm	420-496-007	7 mm
420-496-002	2 mm	420-496-008	8 mm
420-496-003	3 mm	420-496-009	9 mm
420-496-004	4 mm	420-496-010	10 mm
420-496-005	5 mm	420-496-012	12 mm
420-496-006	6 mm	420-496-015	15 mm

FRENCH PATTERN

Osteotom, 150 mm
 Osteotome, 6 inch

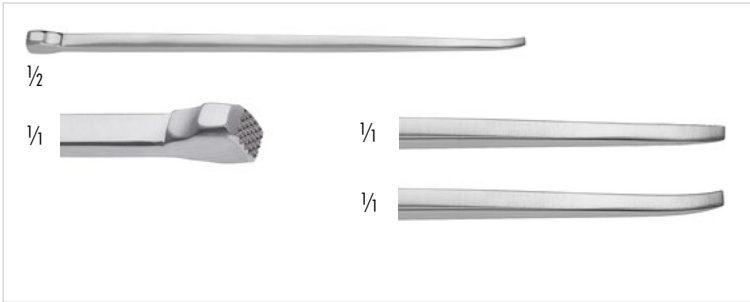

Gerade/straight		Gebogen/curved	
420-570-002	2mm	420-571-002	2mm
420-570-004	4mm	420-571-004	4mm
420-570-006	6mm	420-571-006	6mm
420-570-008	8mm	420-571-008	8mm
420-570-010	10mm	420-571-010	10mm
420-570-012	12mm	420-571-012	12mm
Mini Osteotom, 125 mm			
Mini Osteotome, 5 inch			



420-702-175CC	2mm
420-703-175CC	3mm
420-704-175CC	4mm
420-706-175CC	6mm
Mini Osteotom, CeraCut®, 175mm	
Mini Osteotome, CeraCut®, 7 inch	



210-114-143	3mm
210-114-145	5mm
210-114-147	7mm
210-114-149	9mm
TRAUTMANN	
Meissel, 140 mm	
Chisel, 5 ^{1/2} inch	



210-113-143	3mm
210-113-145	5mm
210-113-147	7mm
210-113-149	9mm
TRAUTMANN	
Hohlmeissel, 140 mm	
Gouge, 5 ^{1/2} inch	



Gerade/straight		Gebogen/curved	
420-502-002	2mm	420-502-102	2mm
420-502-003	3mm	420-502-103	3mm
420-502-005	5mm	420-502-105	5mm
420-502-007	7mm	420-502-107	7mm
420-502-010	10mm	420-502-110	10mm
420-502-014	14mm	420-502-114	14mm
420-502-016	16mm	420-502-116	16mm
420-502-018	18mm	420-502-118	18mm
TESSIER			
Nasen Osteotom, 160 mm			
Nasal Osteotome, 6 ^{1/3} inch			



210-240-180 240 g, Ø 30 mm

COTTLE

Hammer, 1 Seite flach, 1 Seite konvex, 190 mm
Mallet, 1 side plain flat, 1 side convex, 7 1/2 inch



210-264-140 140 g, Ø 25 mm

Hammer, mit auswechselbaren Kunststoffbacken
Mallet, with interchangeable plastic disks

210-265-100

Ersatzbackenpaar, für Hammer 210-264-140
Pair of spare disks, for mallet 210-264-140



210-019-170 117 g, Ø 19 mm

Hammer, mit Kupferkopf, 170 mm
Mallet, with copper head, 6 3/4 inch



110-110-003

Skalpell Griff Nr. 3, 130 mm
Scalpel handle No.3, 5 1/8 inch



110-130-077

Skalpell Griff Nr. 7, 165mm
Scalpel handle No. 7, 6 1/2 inch

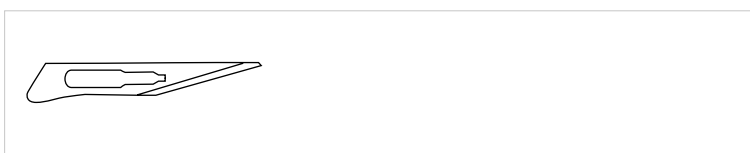

110-201-011

Skalpellklingen Fig 11, 100 Stück
Scalpel blades Fig. 11, 100 pieces

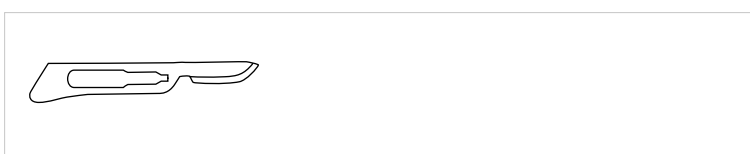

110-201-015

Skalpellklingen Fig. 15, 100 Stück
Scalpel blades Fig. 15, 100 pieces



420-213-140

COTTLE

Septummesser, abgerundete Kanten, 140 mm
Septum knife, stiff blade with rounded edge, 5 1/2 inch

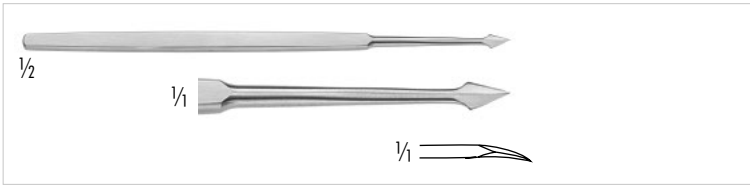

420-552-130

MASING

Knorpelritzmesser, in der Spitze gebogen, 130 mm
Cartilage slitting knife, curved blade, pointed, 5 1/8 inch



420-205-160

JOSEPH

Plastikmesser, gerade, Spitze verrundet, 150 mm
Button-end knife, straight, 6 inch



420-207-160

CONVERSE

Plastikmesser, gebogen, Spitze verrundet, 160 mm
Button-end knife, curved, 6 1/4 inch

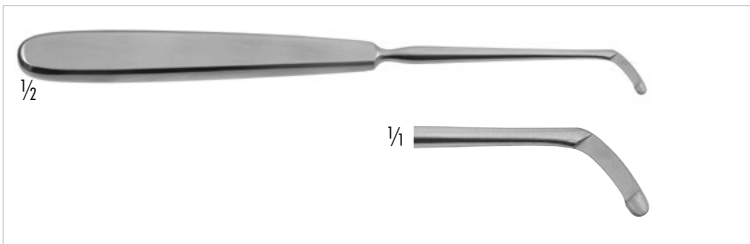

420-209-175

JOSEPH

Zugmesser zum Abtragen von Knorpelvorsprüngen des Septums, 165 mm
Button-end knife, angled for removal of septum cartilage, 6 1/2 inch

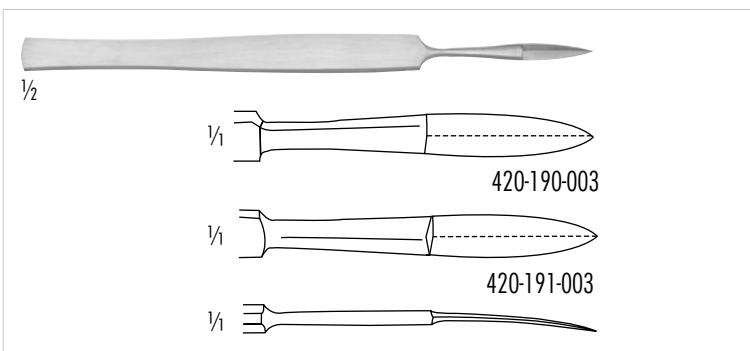

420-190-003 gerade/straight

420-191-003 gebogen/curved

JOSEPH

Plastikmesser mit doppelter Schneide, scharf, 150 mm
Double-edge nasal knife, sharp, 6 inch



420-195-150

FREER

Mukosamesser, 150 mm
Mucosa knife, 6 inch

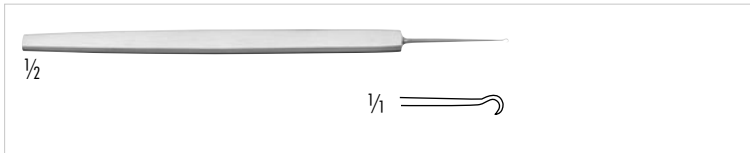

170-010-125
GRAEFE
Hauthäkchen, scharf, 120 mm
Skin hook, sharp, 4 3/4 inch

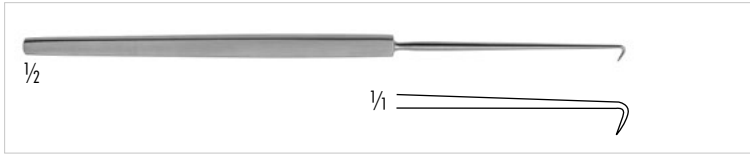

230-285-160
COTTLE
Scharfes Sehnenhäkchen, 120° retrograd gebogen, 168 mm
Tenaculum hook, 120° retrograde curved, 6 2/3 inch

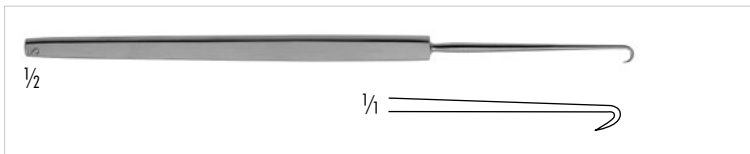

230-286-160
COTTLE
Scharfes Sehnenhäkchen, 180° retrograd gebogen, 168 mm
Tenaculum hook, 180° retrograde curved, 6 2/3 inch

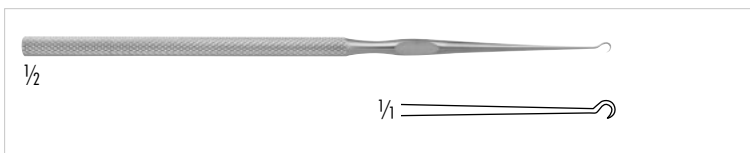

230-203-150
KILNER
Hauthäkchen, scharf, 150 mm
Skin hook, sharp, 6 inch

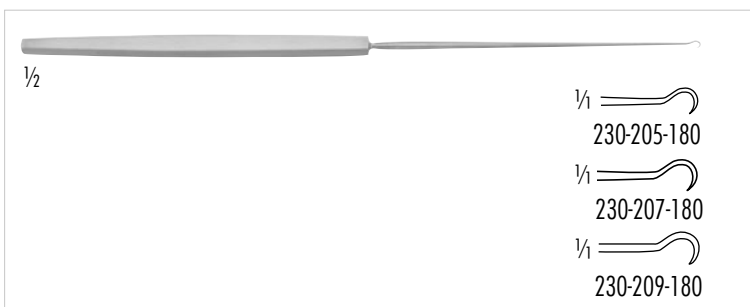

230-205-180 klein/small
230-207-180 mittel/medium
230-209-180 groß/large
GILLIES
Hauthäkchen, scharf, 180 mm
Skin hook, sharp, 7 inch

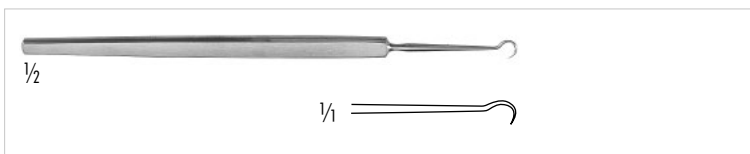

170-013-130 130 mm, 5 1/4 inch
170-013-180 180 mm, 7 inch
FRAZIER
Hauthäkchen, scharf
Skin hook, sharp



250-064-376
FISCH
Hauthäkchen, 90° abgewinkelt, scharf, 190 mm
Skin hook, 90° angled, sharp, 7 1/2 inch



170-060-001 klein/small
170-060-002 groß/large
CUSHING
Stumpfes Häkchen, 190 mm
Buttoned hook, 7 1/2 inch



170-042-130
GUTHRIE
Hauthäkchen, Fig. 1, 120 mm
Skin hook, Fig. 1, 4 3/4 inch

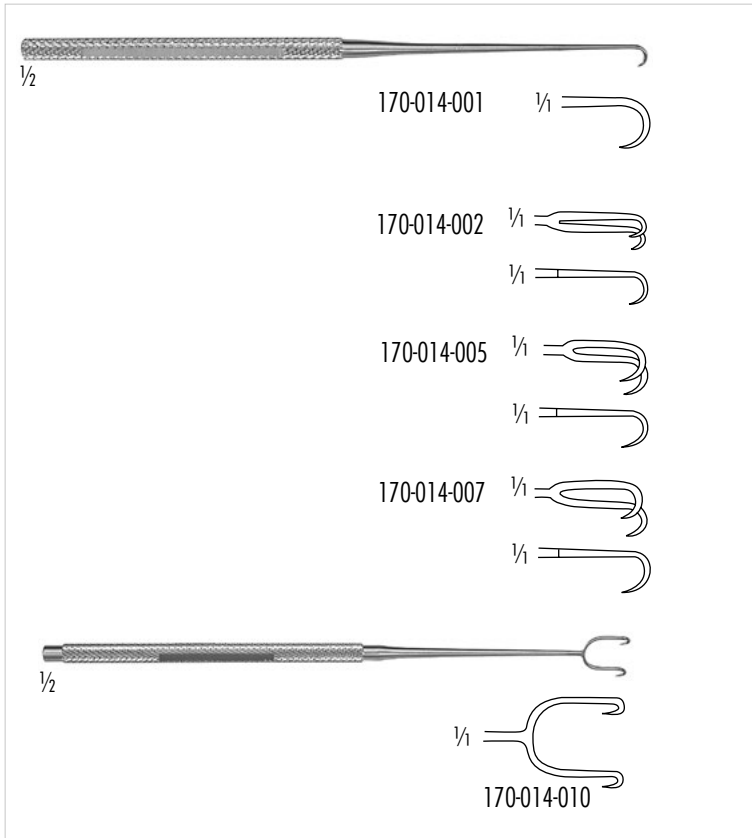

170-014-001

JOSEPH

Hauthäkchen, scharf, 1 Zinken, 150 mm
Skin hook, sharp, single prong, 6 inch

170-014-002 2 mm

170-014-005 5 mm

170-014-007 7 mm

170-014-010 10 mm

JOSEPH

Hauthäkchen, 2 Zinken, scharf, 160 mm
Skin hook, sharp, 2 prongs, 6 1/4 inch

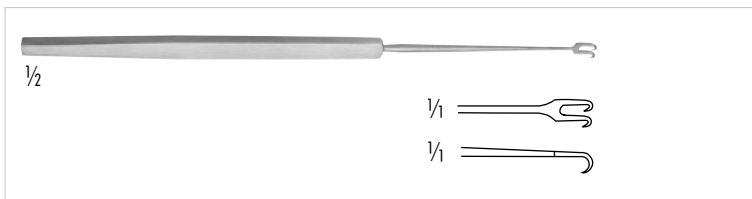

230-220-001

FREER

Hauthäkchen, 2 Zinken, scharf, 150 mm
Skin hook, 2 prongs, sharp, 6 inch

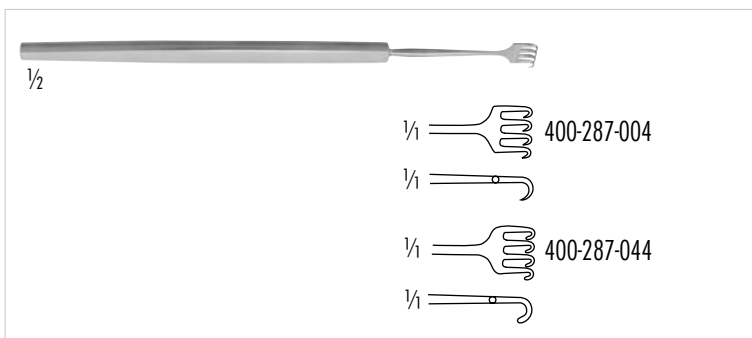

400-287-004 scharf/sharp

400-287-044 stumpf/blunt

ROLLET

Hauthäkchen, 4 Zinken, 135 mm
Skin hook, 4 prongs, 5 1/4 inch

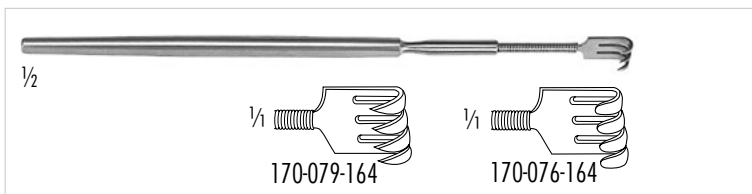

170-079-163 3 Zinken, scharf / 3 prongs, sharp

170-079-164 4 Zinken, scharf / 4 prongs, sharp

170-076-163 3 Zinken, stumpf / 3 prongs, blunt

170-076-164 4 Zinken, stumpf / 3 prongs, blunt

Feine Wundhaken mit flexibler Spitze, 160 mm

Fine hand held retractor with flexible tip, 6 1/4 inch

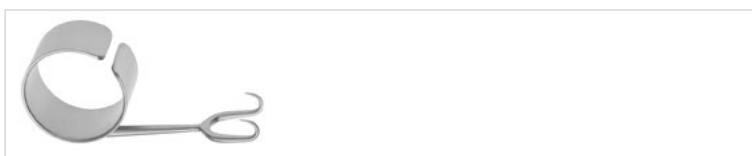

170-008-381

COTTLE

Wundhäkchen mit Ring, Arbeitslänge: 38 mm, scharf, 2-zahig, 8 mm
Thumb retractor, working length 1 1/2 inch, sharp, double hook, 8 mm wide

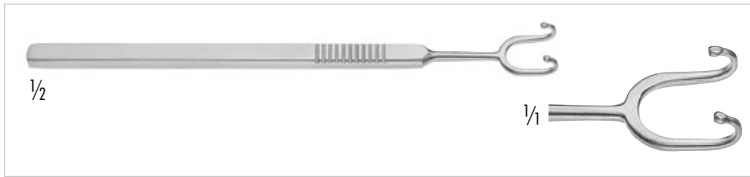

420-186-145
FOMON
Nasenflügelretractor, 2 Zinken, stumpf/stumpf, 140 mm
Alar retractor, 2 prongs, blunt/blunt, 5 1/2 inch



230-281-140 stumpf/spitz, blunt/sharp
230-282-140 spitz/stumpf, sharp/blunt
COTTLE
Nasenflügelretractor, 2 Zinken, 140 mm
Alar retractor, 2 prongs, 5 1/2 inch

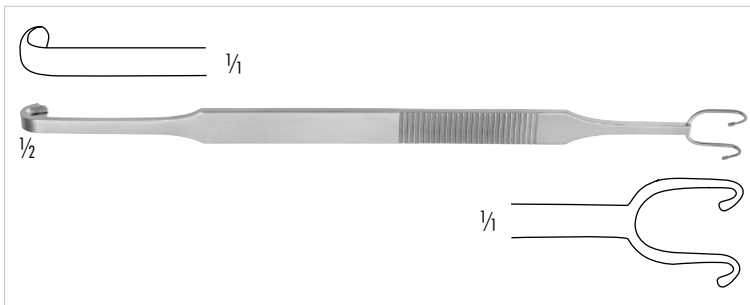

230-260-200
COTTLE-NEIVERT
Nasenflügelretractor, mit Säge- oder Messerführung,
2 Zinken, stumpf, 200 mm
Alar retractor, with saw and knife guide, 2 prongs, blunt, 8 inch

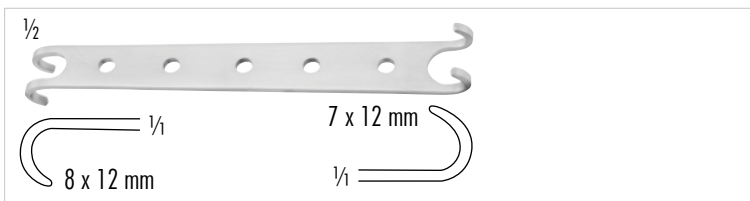

260-501-120
CONVERSE
Alar-Doppelhaken, 2 Zinken, stumpf/stumpf, 120 mm
Alar retractor, double-ended, 2 prongs, blunt/blunt, 4 3/4 inch



420-187-155 sharp
420-187-255 blunt
RUBIN
Haken, 7mm lang, 5,5mm breit
Hook, 7mm length, 5.5mm wide



420-524-150
COTTLE
Alar Retraktor mit Lippe, 150 mm
Alar retractor with lip, 6 inch

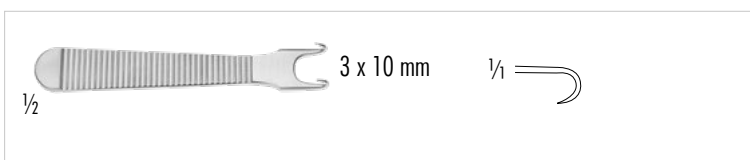

420-184-100 spitz/spitz / sharp/sharp
420-185-100 stumpf/stumpf / blunt/blunt
KILNER
Nasenflügelretractor, 2 Zinken, 85 mm
Alar retractor, 2 prongs, 3 1/4 inch

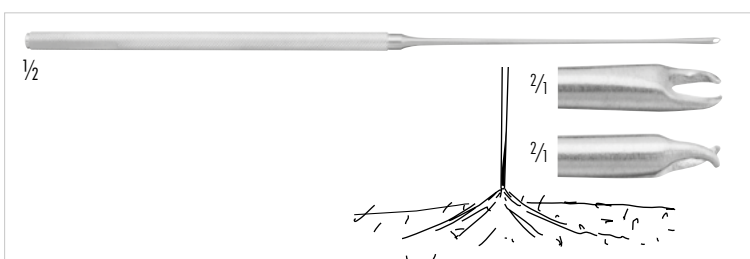

250-064-392 Ø 1,8 mm
Hautkralle mit Schutzkappe, 185 mm
Skin picks with protection cap, 7 1/4 inch

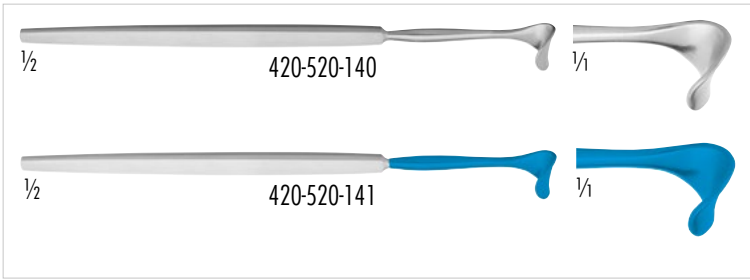

420-520-140 6x12 mm
 420-520-141 6x12 mm, **isoliert/insulated**
MASING
 420-523-140 10x12 mm
 420-523-141 10x12 mm; **isoliert/insulated**
COTTLE

Alar Retraktor, 140 mm
 Alar retractor; 5 1/2 inch



420-256-135
WALTER

Doppelhaken, eine Seite mit 2 stumpfen Haken, eine Seite mit stumpfen Blatt
 Double-ended retractor, one end 2 blunt prongs and one with blade



420-260-005 5mm + 42x7mm
 420-260-008 8mm + 38x7mm
 420-260-013 13mm + 38x7mm
 420-260-113 13mm + 42x10mm

AUFRICHT
 Doppelendiger Nasenhaken, stumpf
 Double-ended nasal retractor, blunt



420-250-160 10x45 mm Blatt/blade
 420-251-160 10x30 mm Blatt/blade
AUFRICHT
 Nasenretraktor, 160 mm
 Nasal retractor, 6 1/4 inch

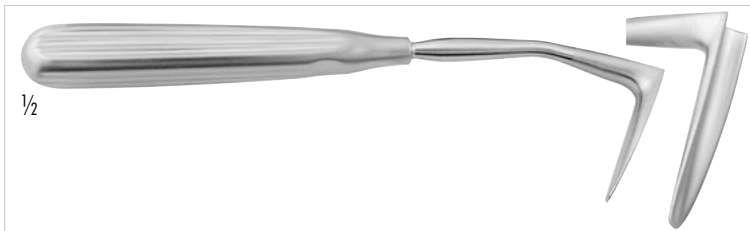

420-057-160

DEVINE-MILLARD-AUFRICHT

Nasenretraktor, 10 x 45 mm Blatt, 180 mm

Nasal retractor, 10 x 45 mm blade, 7 inch

420-257-160

Dito, mit KL-Anschluß

Same, with fibre optic

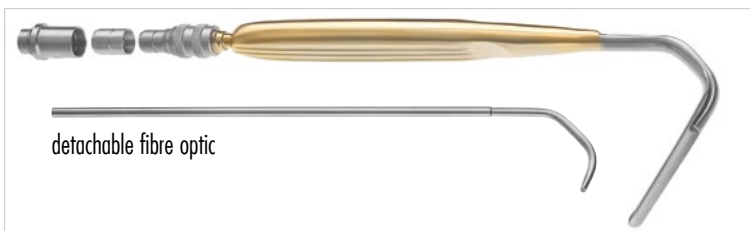

420-255-160

AUFRICHT

Nasenretraktor, mit Kaltlicht, 120°, 45 mm Blatt, 180 mm

Nasal retractor, with fibre optic, 120°, 45 mm blade, 7 inch

detachable fibre optic



420-652-100

420-752-100 mit Kaltlichtträger/with fibre optic light carrier

MALINIAC

Nasenretraktor, 9 x 45 mm, 100 mm

Nasal retractor, 9 x 45 mm, 4 inch



420-236-110 11 x 44 mm

CONVERSE

Nasenretraktor, mit Kaltlicht, 110 mm

Nasal retractor, with fibre optic, 4 1/3 inch



121-188-145 gerade / straight
121-189-145 gebogen / curved

METZENBAUM

Super-Cut Präparierscheren, mit eckigen Ringen, 145 mm

Super-Cut Dissecting scissors, with square rings, 5 3/4 inch



120-967-130 gebogen/curved
120-966-130 gerade/straight

GOLDMAN FOX

TC Sehnschere, eine Schneide gezahnt, 130 mm

TC Tendon scissors, one blade serrated, 5 1/8 inch

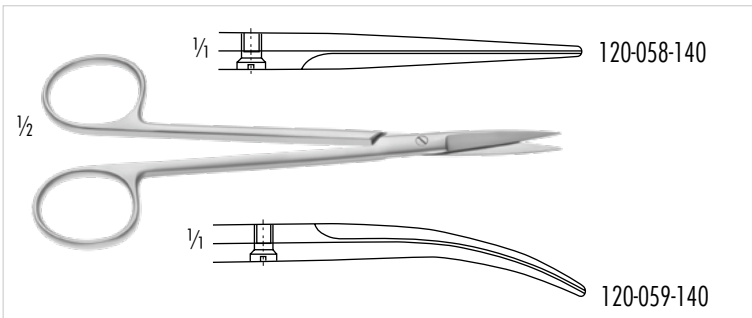

120-058-140 gerade / straight
120-059-140 gebogen / curved

JOSEPH

Plastikschere, spitz/spitz, 145 mm

Plastic scissors, sharp/sharp, 5 3/4 inch

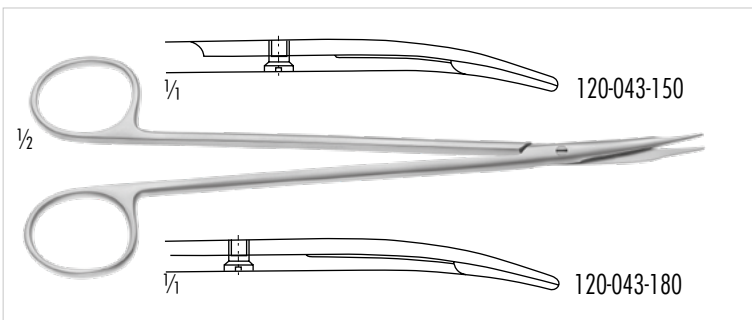

120-043-150 145 mm, 5 3/4 inch
120-043-180 175 mm, 7 inch

REYNOLDS

Präparierschere, delikat, stumpf/stumpf, gebogen

Dissecting scissors, delicate, blunt/blunt, curved

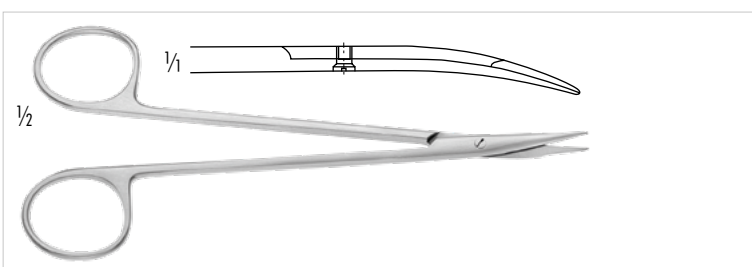

120-315-150

JAMESON

Präparierschere, delikat, stumpf/stumpf, gebogen, 150 mm

Dissecting scissors, delicate, blunt/blunt, curved, 6 inch

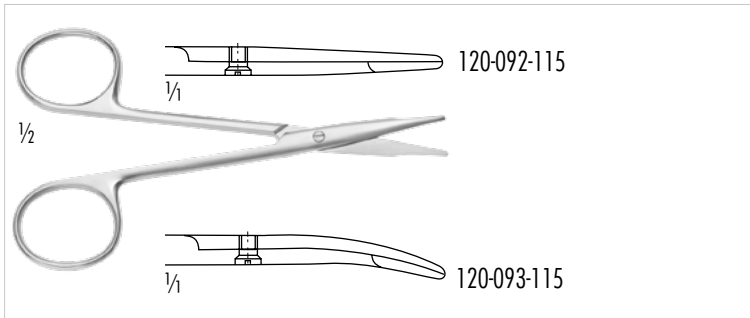

- 120-092-115 gerade, stumpf/stumpf
straight, blunt/blunt
- 120-093-115 gebogen, stumpf/stumpf
curved, blunt/blunt

STEVENS

Gefäß- und Sehenschere, 110 mm
Vessel and tendon scissors, 4 3/8 inch

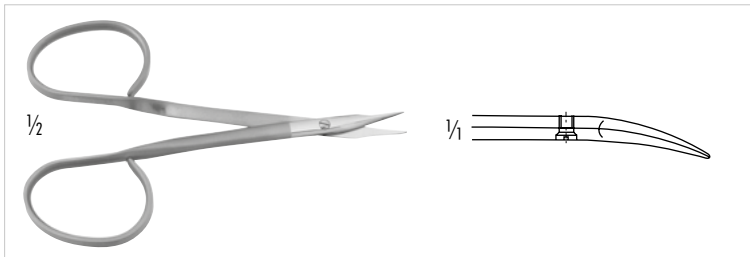

- 120-099-105 gebogen / curved

STEVENS

Gefäß- und Sehenschere, spitz, mit offenem Ring, 100 mm
Vessel and tendon scissors, sharp, with Ribbon handle, 4 inch

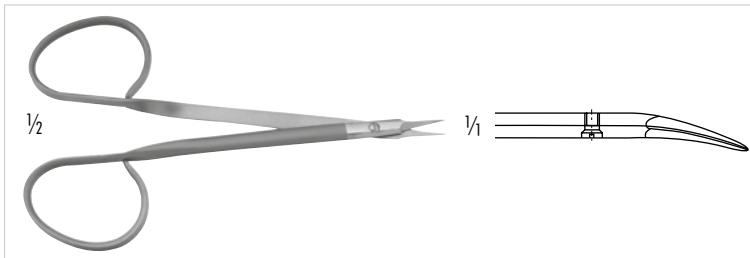

- 120-398-120

STEVENS

Besonders feine Präparierschere, spitz, leichtes Modell mit offenem Ring, 110 mm
Dissecting scissors, delicate, sharp, light pattern with Ribbon handle, 4 3/8 inch

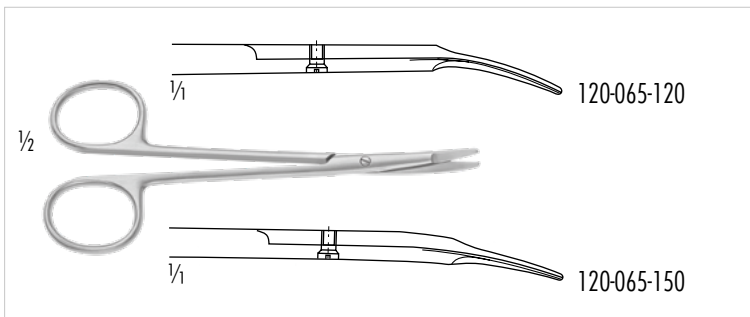

- 120-065-120 125 mm, 5 inch

- 120-065-150 150 mm, 6 inch

KILNER

Präparierschere, mit stark abgeflachten Blättern, gebogen, stumpf/stumpf
Dissecting scissors, with bevelled blade, curved, blunt/blunt

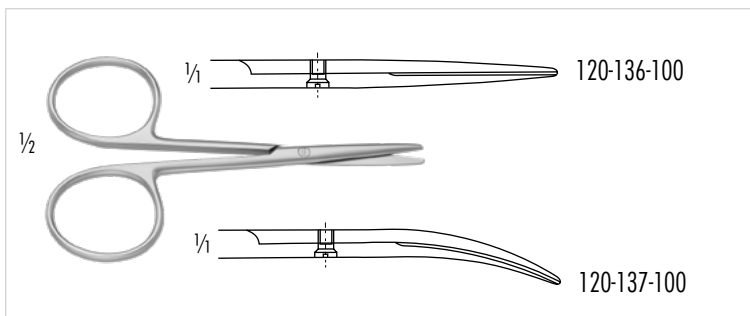

- 120-136-100 gerade / straight

- 120-137-100 gebogen / curved

COTTLE-KNAPP

Plastikschere, stumpf/stumpf, 105 mm
Plastic scissors, blunt/blunt, 4 1/8 inch

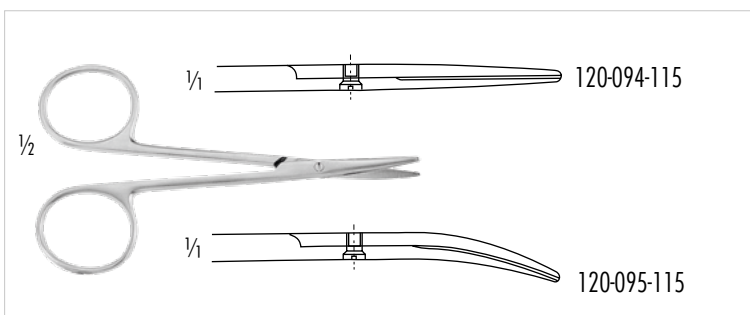

- 120-094-115 gerade / straight

- 120-095-115 gebogen / curved

STRABISMUS

Präparierschere, 115 mm
Dissecting scissors, 4 1/2 inch

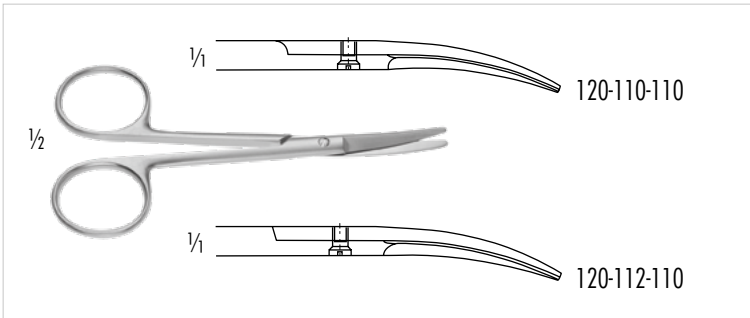

120-110-110 spitz/spitz / sharp/sharp
 120-112-110 stumpf/stumpf / blunt/blunt

COTTLE-MASING

Nasenplastikschere, gebogen, 105 mm
 Nasal plastic scissors, curved, 4 1/8 inch

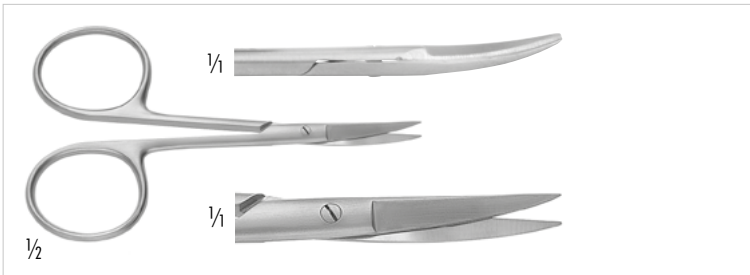

120-081-100

121-081-100 **Super Cut**

Iris Schere, gebogen, mit großen Ringen, 100 mm
 Iris scissors, curved, with large handle, 4 inch

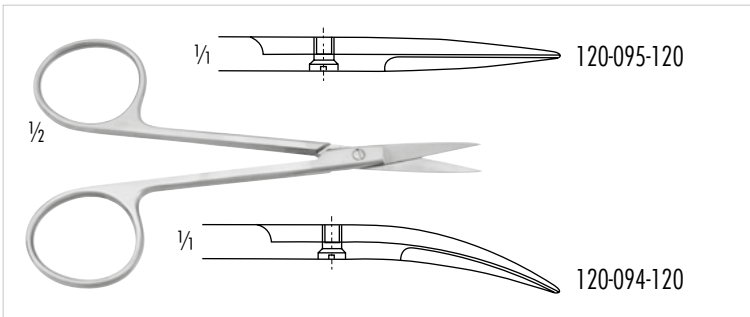

120-095-120 gerade/straight
 120-094-120 gebogen/curved

Feine Schere, 115 mm
 Delicate scissors, 4 1/2 inch

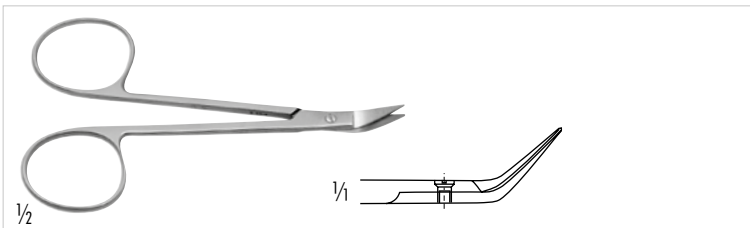

120-411-090

DANIELS

Präparierschere, 40° abgewinkelt, 90 mm
 Dissecting scissors, 40° angled, 3 1/2 inch

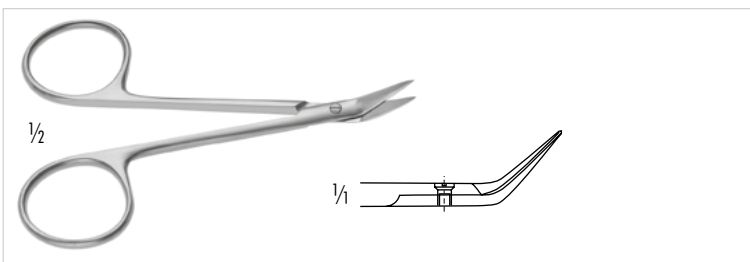

120-411-105

BIRO

Schere, abgewinkelte Schneide, rundes Maul, 105 mm
 Scissors, angled blades, round shape, 4 inch

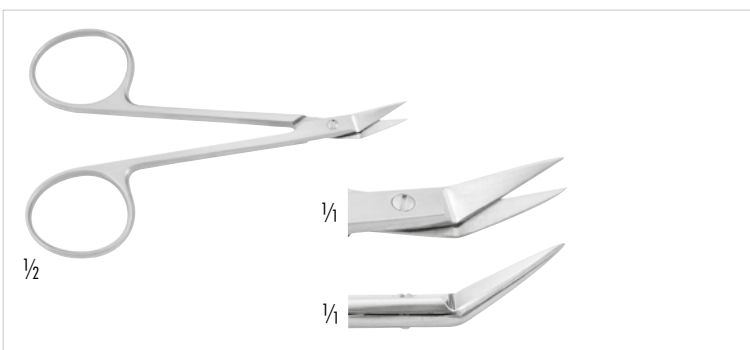

120-511-100

121-511-100 **Super Cut**

CONVERSE

Nasenschere, aufgewinkelte Blätter, spitz/spitz, 104 mm
 Nasal scissors, angled up blades, sharp/sharp, 4 1/8 inch

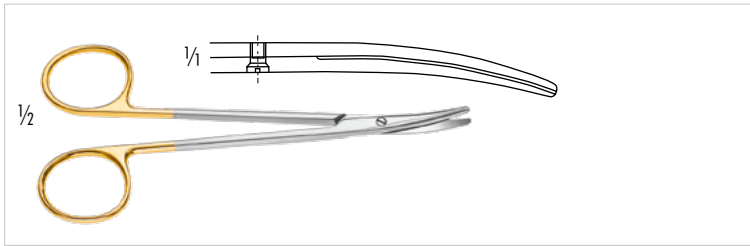

120-595-115

BABY-METZENBAUM

TC Präparierschere, gebogen, 115 mm

TC Dissecting scissors, curved, 4 1/2 inch

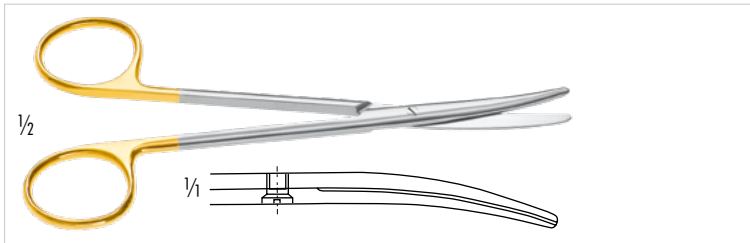

120-511-145

METZENBAUM

TC Präparierschere, Fig 1, gebogen, 145 mm

TC Dissecting scissors, Fig. 1, curved, 5 3/4 inch

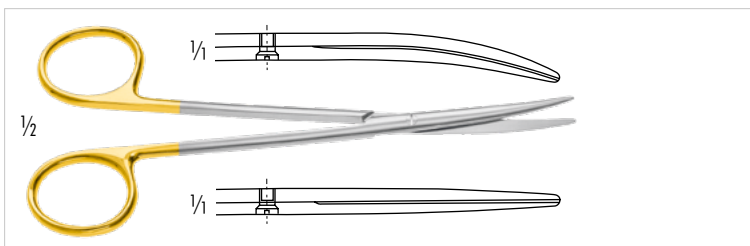

120-521-145 gebogen/curved

120-520-145 gerade/straight

METZENBAUM-FINO

TC Präparierschere, stumpf, 145 mm

TC Dissecting scissors, blunt, 5 3/4 inch

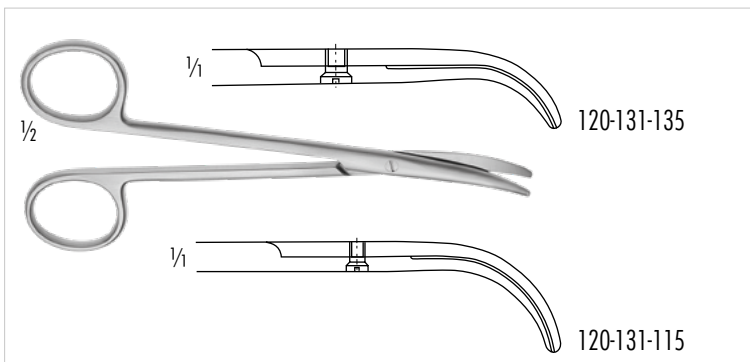

120-131-115 115 mm, 4 1/2 inch

120-131-135 135 mm, 5 1/4 inch

FOMON

Nasenflügelschere, stark gebogen

Lower lateral scissors, strongly curved

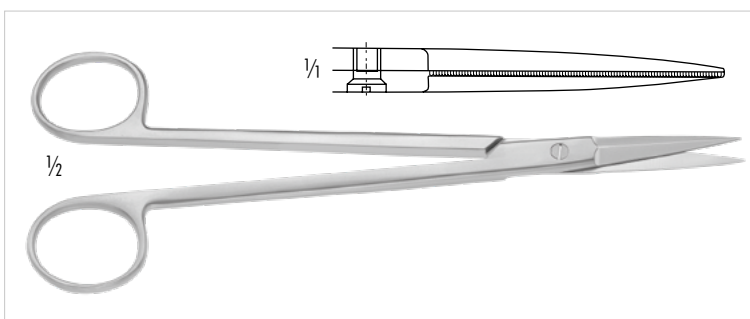

120-190-190

MC INDOE

Knorpelschere, mit außen schneidenden Blättern,

spitz/spitz, gerade, gezahnt, 185 mm

Cartilage scissors, straight, serrated blades. Blades: cutting

on both sides, sharp/sharp, 7 1/4 inch

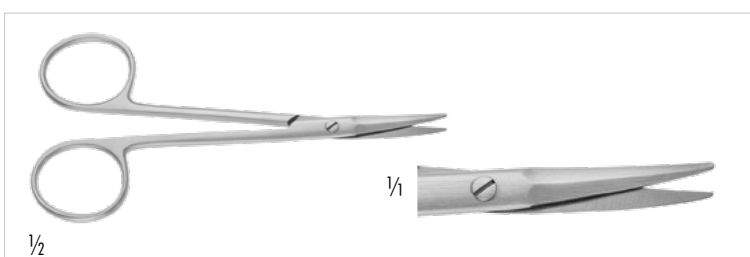

120-281-110 stumpf, 110mm/pointed, 4 3/4 inch

120-281-130 spitz, 130mm/pointed, 5 inch

BEUSE

Nasenschere, leicht gebogen

Nasal Scissors, slightly curved

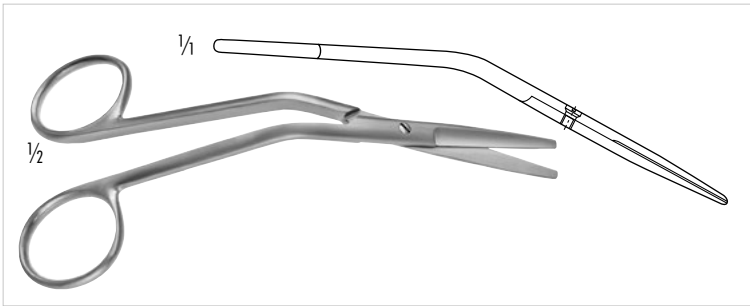

120-280-150

FOMON

Nasenschere, beide Schneiden gezahnt, kniegebogen, stumpf/stumpf, 145 mm

Dorsal scissors, straight, serrated blades, knee bent, blunt/blunt, 5 3/4 inch

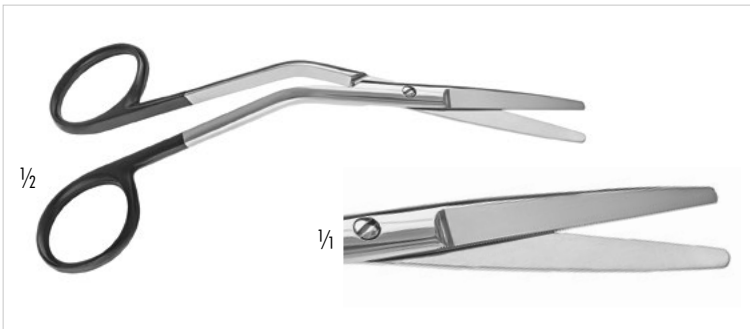

121-280-145

FOMON

SC Nasenschere, kniegebogen, ein gezahntes Blatt, 145 mm

SC Dorsal scissors, knee bent, one serrated blade, 5 3/4 inch



120-281-160

121-281-160 **Super-Cut**

120-581-160 **TC**

COTTLE

Nasenschere, kniegebogen, stumpf/stumpf, 165 mm

Dorsal scissors, straight blades, knee bent, blunt/blunt, 6 1/2 inch



120-585-180

KNIGHT

TC Nasenschere, 180 mm

TC Nasal Scissors, 7 inch

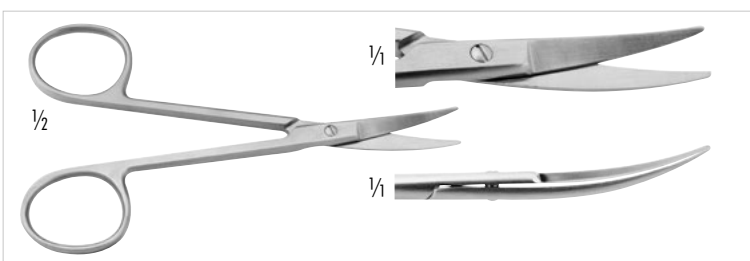

120-379-115

COTTLE

Bulldog-Schere, stumpf/stumpf, 115 mm

Bulldog scissors, blunt/blunt, 4 1/2 inch

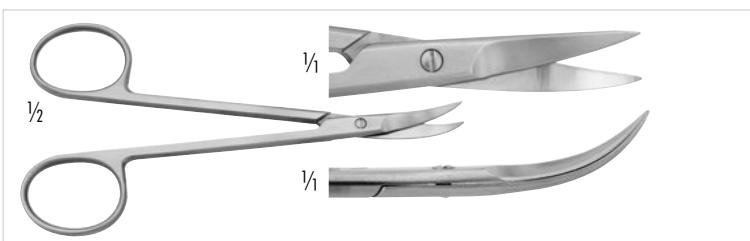

120-053-115

CHADWICK

Schere, gebogen, spitz, 115 mm

Scissors, curved, sharp, 4 1/2 inch



420-730-085

COTTLE

Columella-Pinzette für Kinder, mit Stellschraube
Columella clamp for children, with adjusting screw



420-730-100

COTTLE

Columella-Pinzette, mit feststehenden Fixierrollen und Stellschraube, 100 mm
Columella clamp, with fixation bearings and adjusting screw, 4 inch

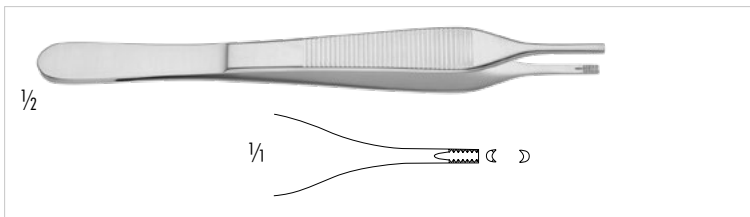

130-552-120 120mm, 4 3/4 inch

130-552-150 150mm, 6 inch

ADSON-BRAUN

Wundrandpinzette, 7x7 Zähne
Tissue forceps, 7x7 teeth

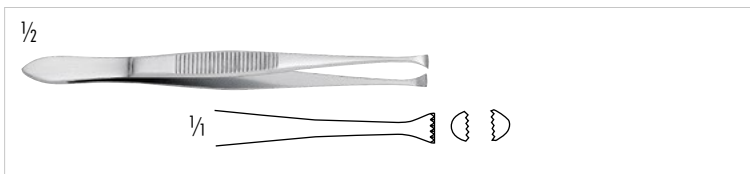

400-025-110

GRAEFFE

Hautfasspinzette, mit scharfen Zähnen, 110 mm
Tissue forceps, with sharp teeth, 4 3/8 inch



130-558-150

GLANZ

Pinzette atraumatisch, 150 mm
Atraumatic tissue forceps, 6 inch

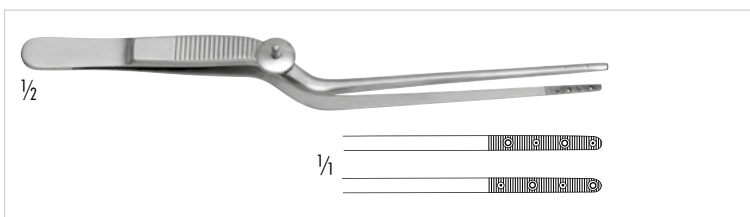

420-732-155

COTTLE

Fixierpinzette, mit Stellschraube, bajonettförmig, gerieft mit Zähnen, 155 mm
Lower lateral forceps, with adjusting screws, bayonet shaped, serrated with teeth, 6 inch



290-552-160

DEBAKEY

Atraumatische Pinzette, gerade, 2 mm Spitze, 160 mm
Atraumatic forceps, straight, 2 mm tip, 6 1/4 inch



410-247-165

SHEEN

Nasenpinzette mit 6mm Löffel, bajonett gebogen, 165mm
Nasal Forceps with 6mm spoon, bayonet shape, 6 1/2 inch

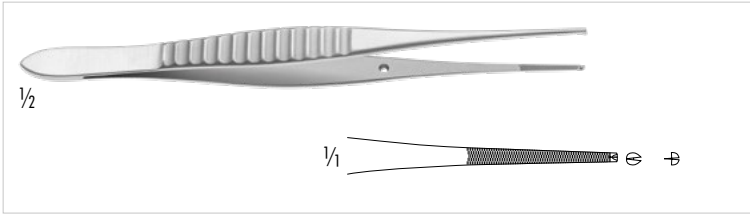

130-120-150
GILLIES
Chirurgische Pinzette, 1 x 2 Zähne, 160 mm
Tissue forceps, 1 x 2 teeth, 6 1/4 inch

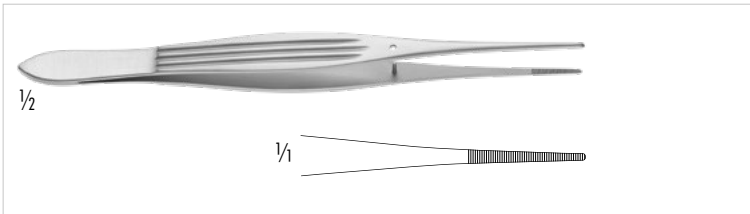

130-028-150
MC INDOE
Anatomische Pinzette, 150 mm
Dissecting forceps, 6 inch



130-500-100 gerade/straight
130-501-100 gebogen/curved
GRAEFE
Feine anatomische Pinzette, 100 mm
Delicate dressing forceps, 4 inch



130-503-100 gerade/straight
130-504-100 gebogen/curved
GRAEFE
Chirurgische Pinzette, 1 x 2 Zähne, 100 mm
Tissue forceps, 1 x 2 teeth, 4 inch



130-144-125
SEMKEN
Anatomische Pinzette, 125 mm
Dressing forceps, 5 inch



130-145-125
SEMKEN
Chirurgische Pinzette, 1 x 2 Zähne, 125 mm
Tissue forceps, 1 x 2 teeth, 5 inch



400-137-050
CASTROVIEJO
Nahtpinzette mit Fadenplatte, 0,5 mm, 1 x 2 Zähne, 100 mm
Suture forceps with tying platform, 0.5 mm, 1 x 2 teeth, 4 inch

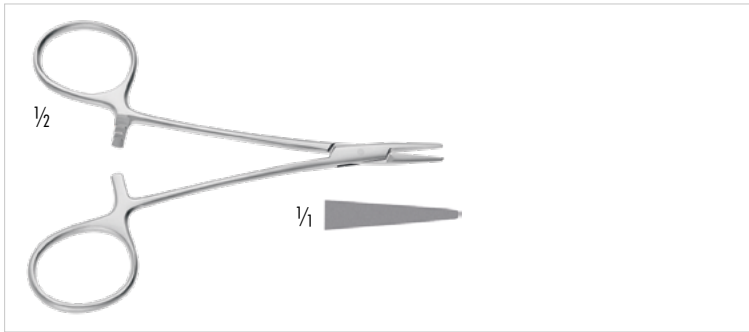

180-318-110

YANG

Nadelhalter, sehr fein, glattes Maul, 110 mm
 Needle holder, very delicate, smooth jaw, 4 1/4 inch



180-542-150

BABY-CRILE-WOOD

TC Nadelhalter, 150 mm
 TC Needle holder, 6 inch

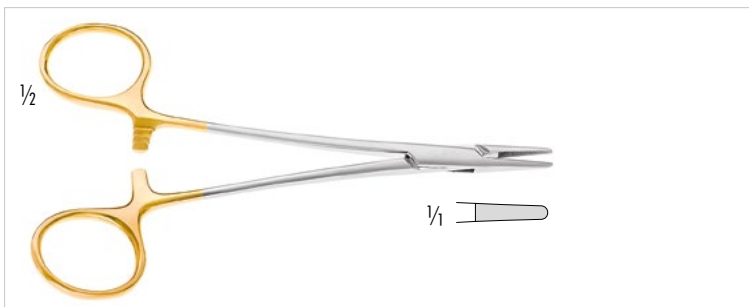

180-537-130

HALSEY

TC Nadelhalter, 130 mm
 TC Needle holder, 5 1/8 inch

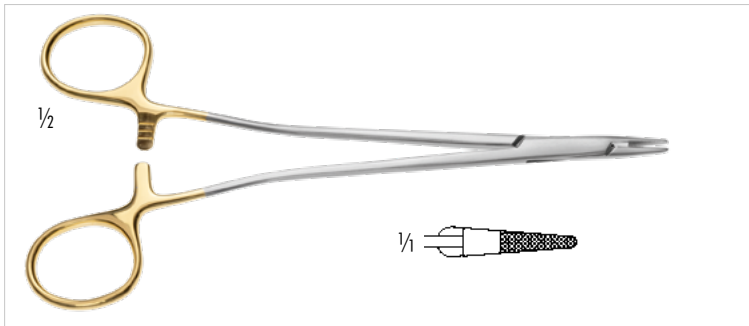

180-533-130

NEIVERT

TC Nadelhalter, 130 mm
 TC Needle holder, 5 1/8 inch



180-531-150 150 mm/6 inch

180-531-170 170 mm/6 3/4 inch

SENNING

TC Nadelhalter, durch seine schlanke Form besonders für tiefe Nähte bei rhinoplastischen Operationen geeignet, 170 mm
 TC Needle holder, used for suturing in rhinoplastic surgery, 6 3/4 inch



250-264-246

JACOBSON

Mikro Nadelhalter, Rundgriff, gerade, mit Sperre, diamantiertes Maul, 185 mm
 Micro Needle holder, round handle, straight, with catch, diamond dusted jaws, 7 1/4 inch



420-390-200

Knorpelritzzange mit abnehmbarem einseitigem Schutz für rechts und links sowie ohne Schutz für ein gleichzeitiges Einritzen beider Knorpelseiten, 200 mm

Cartilage morcelizer forceps with removable guard, converts cartilage into a membranous-like structure, permitting repositioning of the septum to midline, 8 inch



420-189-210

GOLDMANN

Nasenfrakturaufrichter, runde Form, 200 mm

Septum elevator, round (displacer), 8 inch



420-557-170

BOIES

Elevator zur Reposition von Nasenbeinbrüchen, 170 mm

Elevator for septum repositioning, 6 ¾ inch

½



420-555-195

BOIES

Nasenfrakturelevator, 9 mm breite Spitze, 195 mm

Nasal fracture elevator, 9 mm wide tip, 7 ¾ inch

½

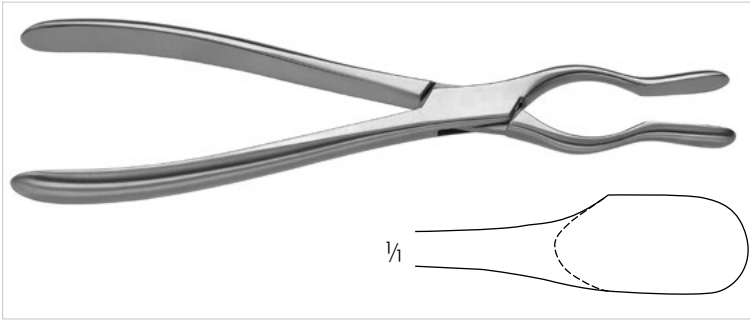

420-450-230
COTTLE-WALSHAM
Septumrichtzange mit aseptischem Schluß, 220 mm
Septum straightening forceps, with aseptic lock, 8 3/4 inch

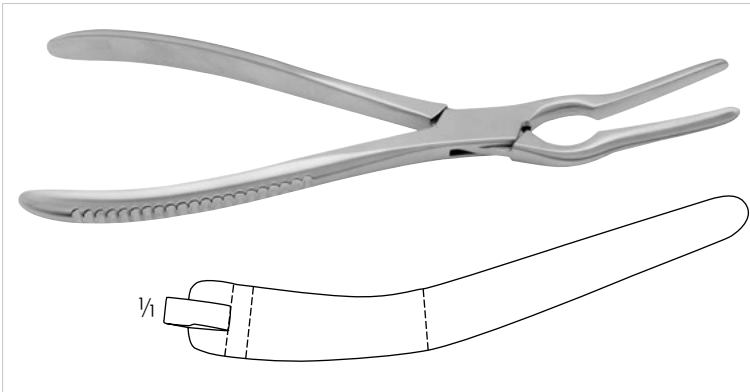

420-455-230
ASH
Septumrichtzange, 220 mm
Septum straightening forceps, 8 3/4 inch

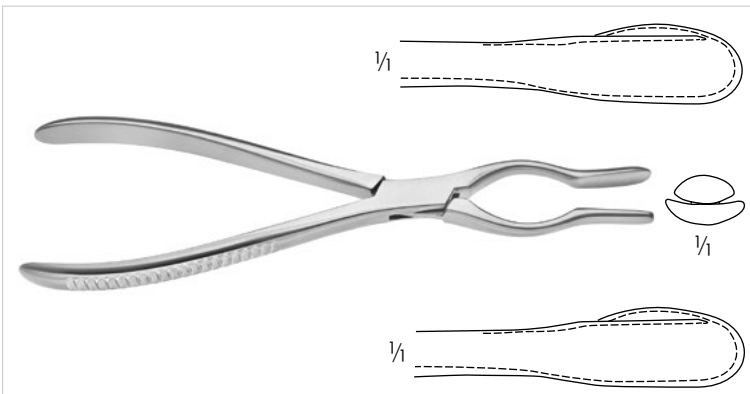

420-452-230 für rechts/right
420-451-230 für links/left
WALSHAM
Septumrichtzange, 210 mm
Septum straightening forceps, 8 1/4 inch



	∅ A	∅ B
410-404-030	3,6 mm	3,0 mm
410-404-035	4,0 mm	3,5 mm
410-404-040	4,5 mm	4,0 mm

MAGILL
Saugkanülen, 245 mm
Suction tube, 9 3/4 inch

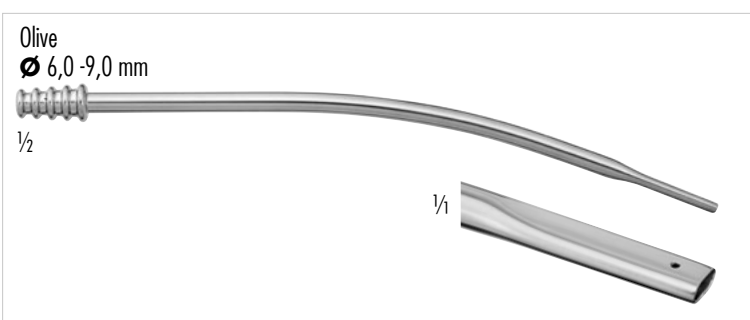

165-064-160 ∅ 5 mm
Nasensaugrohr, LUER-Bohrung, Spitze 6,5 mm breit, 180 mm
Nasal suction tube, with LUER, tip 6,5 mm wide, 7 inch

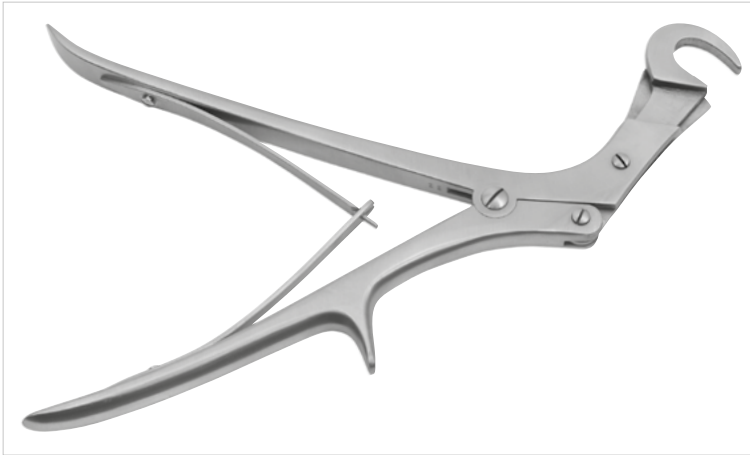

290-137-270

GIERTZ-STILLE

Rippenschere, mit Doppelübersetzung, 250 mm
Rib shear, double action, 10 inch

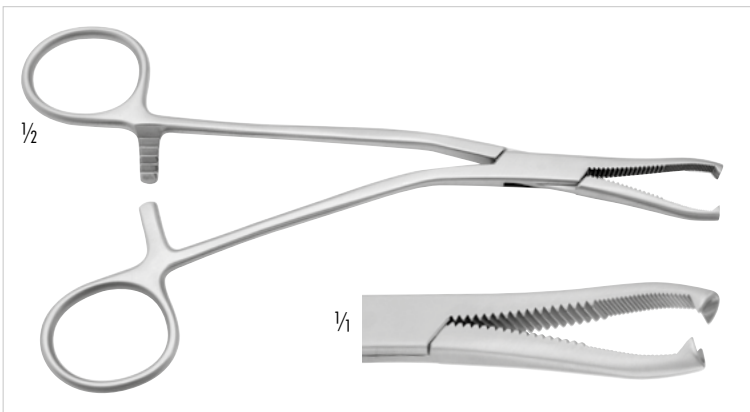

210-626-190

DINGMANN

Knochenhaltezange, 185 mm
Bone holding forceps, 7 1/4 inch



420-365-000 28mm breit/28mm wide

420-365-050 50mm breit/50mm wide

COTTLE

Knochen-Knorpelquetsche mit Metallklammer, zum Entnehmen
der Knochen-Knorpeltrümmer
Bone crusher, for preparation of cartilage implant material,
complete with clamp

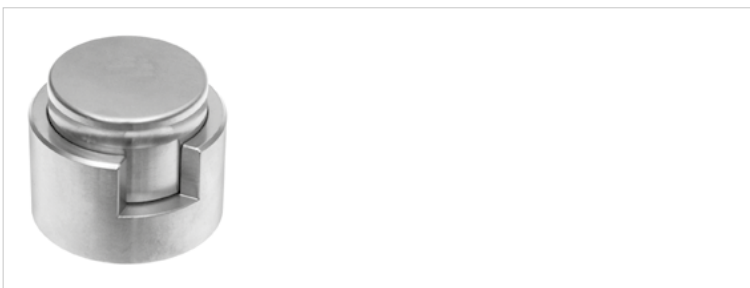

420-366-000

TOLSDORF

Knorpelquetsche, Innenteil gezahnt, Außenteil innen glatt
40mm Innen-Durchmesser
Bone crusher, inner part serrated, outer part bottom plain
40mm inner diameter



420-367-000

85 x 55 mm

Kunststoffplatte, zur Bearbeitung der Knochen-
transplantate, dampfsterilisierbar
Plastic plate, for preparation of bone grafts, autoclavable



- 230-202-000 gerade/straight
- 230-202-001 bajonettförmig, links gebogen
bayonet shaped, curved to the left
- 230-202-002 bajonettförmig, rechts gebogen
bayonet shaped, curved to the right

JOSEPH

Nasensäge, 170 mm
Nasal saw, 6 3/4 inch



- 230-211-170 links abgewinkelt/left angled
- 230-210-170 rechts abgewinkelt/right angled

JOSEPH

Nasensäge, 170 mm
Nasal saw, 6 3/4 inch

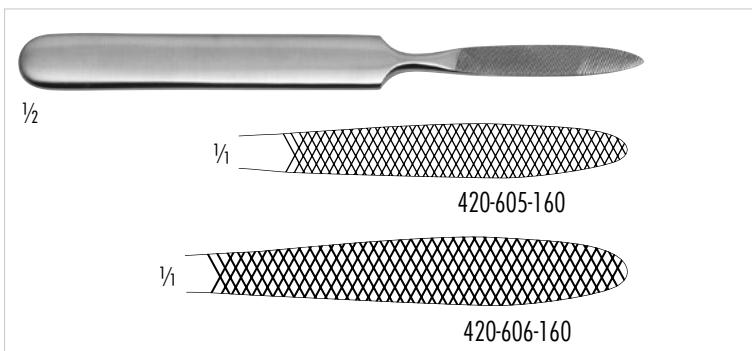

- 420-605-160 fein kariert/fine cross-serrated
- 420-606-160 grob kariert/coarse cross-serrated

JOSEPH

Raspel, zum Füllen von nasalen Knochen, 165 mm
Rasp, for filling nasal bone material, 6 1/2 inch



420-653-180

MALTZ

Nasen-Raspel, 90° quer gerieft, auf Zug schneidend, 180 mm
Nasal rasp, 90° cross-serrated, teeth set to cut on down stroke, 7 inch



420-650-001

AUFRICHT

Nasen-Raspel, 90° quer gerieft, auf Zug schneidend, 220 mm
Nasal rasp, 90° cross-serrated, teeth set to cut on down stroke, 8 3/4 inch

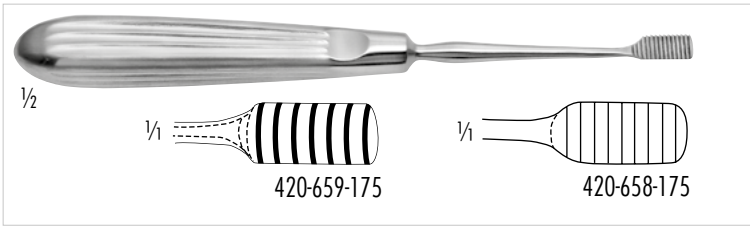

420-658-175

LEWIS

Raspel, 8 mm, 90° quer gerieft, auf Zug schneidend, feine Zahnung
Rasp, 8 mm, 90° cross serrated, set to cut on down stroke, fine teeth



420-658-210 9x25mm

PECK-PARK

Raspel, 16 Zähne, 210mm
Raspatory, 16 teeth, 8 1/4 inch

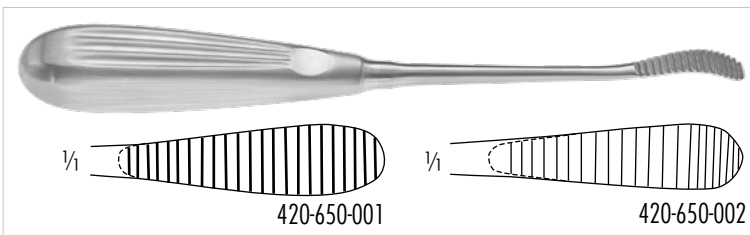

420-650-002

auf Druck schneidend/set to cut on up stroke

420-650-001

auf Zug schneidend/set to cut on down stroke

AUFRICHT

Raspel, 9 mm, 90° quer gerieft, 220 mm
Rasp, 9 mm, 90° cross-serrated, 8 3/4 inch

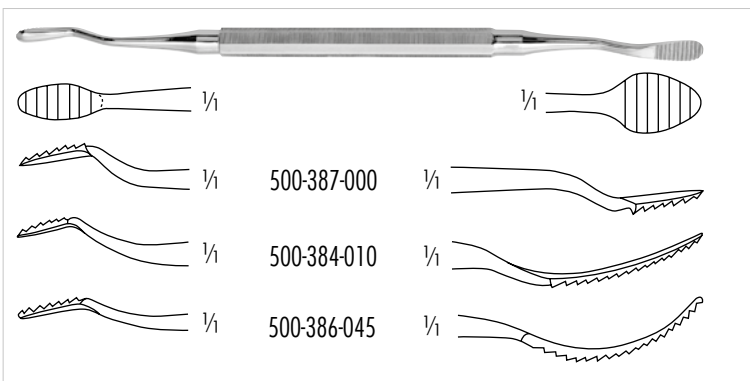

500-387-000

500-384-010

500-386-045

MILLER

Doppelraspel, 90° quer gerieft, auf Zug schneidend, 180 mm
Rasp, double-ended, 90° cross-serrated, set to cut on down stroke, 7 inch

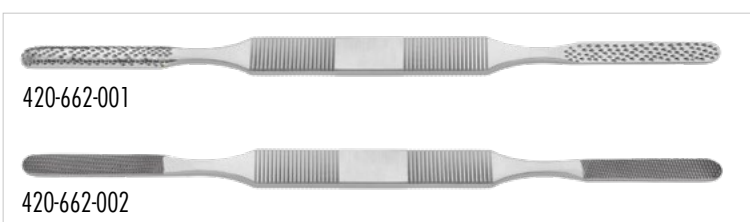

420-662-001

grob/coarse

420-662-002

fein/fine

FOMON

Nasenraspel, sehr leicht
Nasal rasp, lightweight

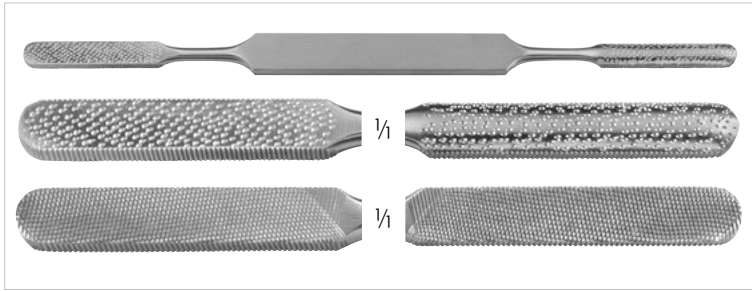

420-661-100

FOMON

Doppelraspel, Vorderseite grob, Rückseite fein, 215 mm
Rasp, double-ended, frontside coarse teeth, backside fine, 8 1/2 inch



420-656-000

KLEINERT-KUTZ

Nasenraspel, doppelendig, 4-seitig, 220mm
Nasal rasp, double-ended, 4-sided, 8 3/4 inch

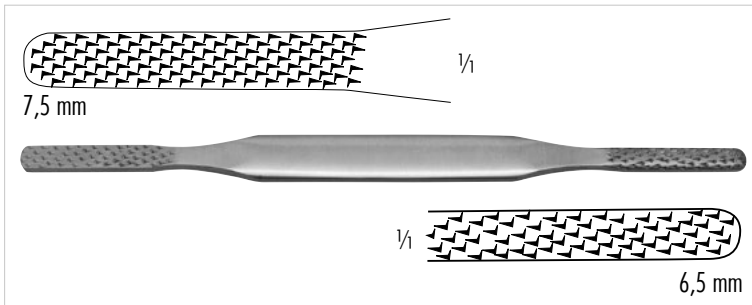

420-660-000

FOMON

Doppelraspel, grobe Zahnung, 215 mm
Rasp, double-ended, coarse teeth, 8 1/2 inch

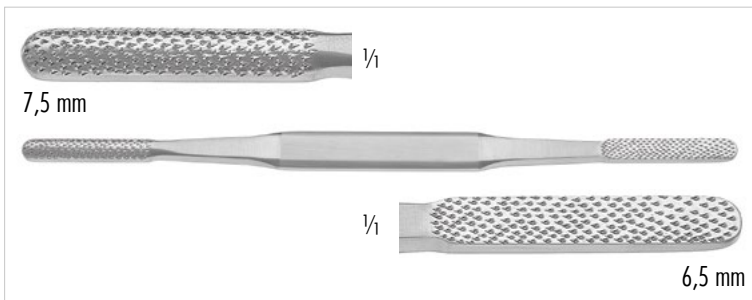

420-661-000

FOMON

Doppelraspel, feine Zahnung, 215 mm
Rasp, double-ended, fine teeth, 8 1/2 inch

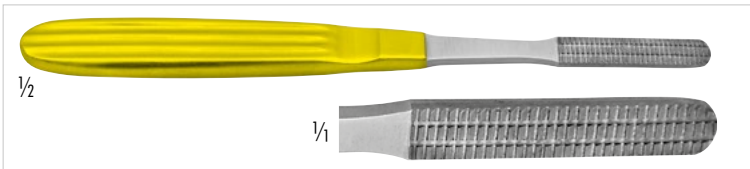
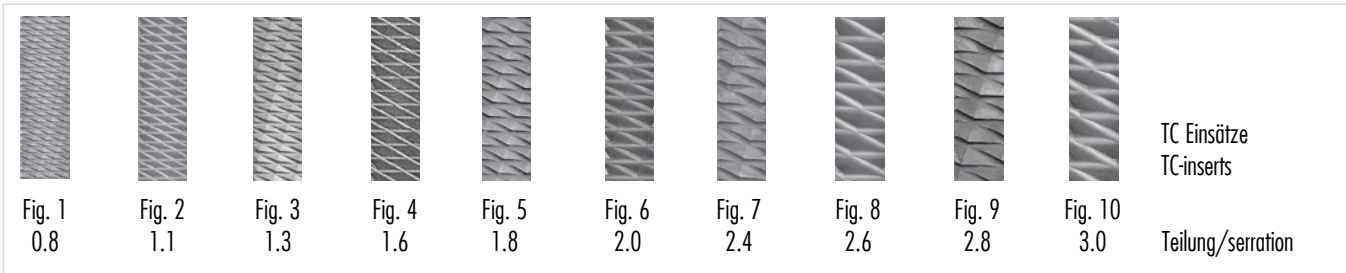

420-672-000

MALTZ

TC Nasenraspel, gerade, auf Zug schneidend, 180 mm

TC Nasal rasp, straight, reverse, 7 inch

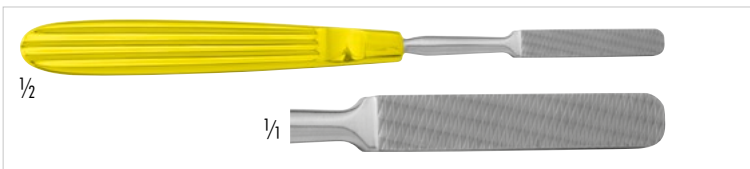

420-492-165 Fig. 2

420-493-165 Fig. 3

MALTZ

TC Nasenraspel, 170 mm

TC Nasal rasp, 6 2/3 inch

420-494-165 Fig. 4

420-495-165 Fig. 5

420-496-165 Fig. 6

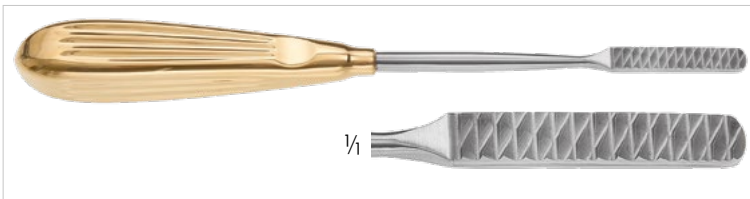

420-490-210 Fig. 1

420-491-210 Fig. 2

420-492-210 Fig. 3

420-493-210 Fig. 4

420-494-210 Fig. 5

PARKES

TC Raspel, 8 x 39 mm, gerade, 210 mm

TC Rasp, 8 x 39 mm, straight, 8 1/4 inch

420-495-210 Fig. 6

420-496-210 Fig. 7

420-497-210 Fig. 8

420-498-210 Fig. 9

420-499-210 Fig. 10

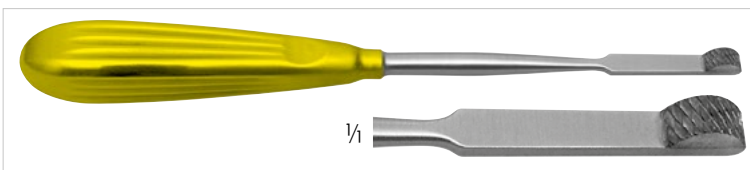

420-669-210

GLABELLA

TC Raspel, mittel, 210 mm

TC Rasp, medium, 8 1/4 inch

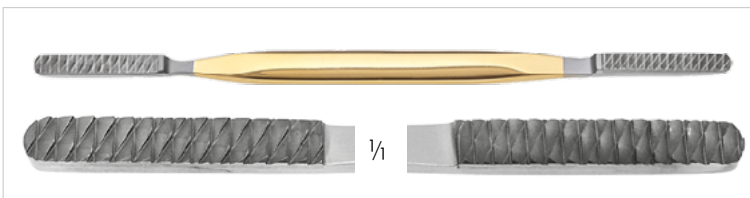

420-660-214 Fig. 3/Fig. 4

420-660-216 Fig. 5/Fig. 6

420-660-218 Fig. 7/Fig. 8

420-660-219 Fig. 1/Fig. 2

420-660-220 Fig. 9/Fig. 10

FOMON

TC Nasenraspel, doppelendig, 7 x 40 mm, 210 mm

TC Nasal Rasp, double ended, 7 x 40 mm, 8 1/4 inch

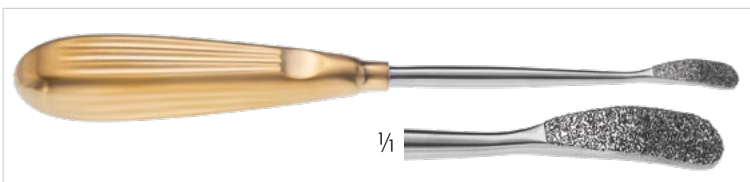

420-650-101

AUFRICHT

Nasenraspel, fein, gebogen, RZ diamantiert, 7 x 25 mm, 200 mm

Rasp, fine, curved, RZ diamond tip, 7 x 25 mm, 8 inch

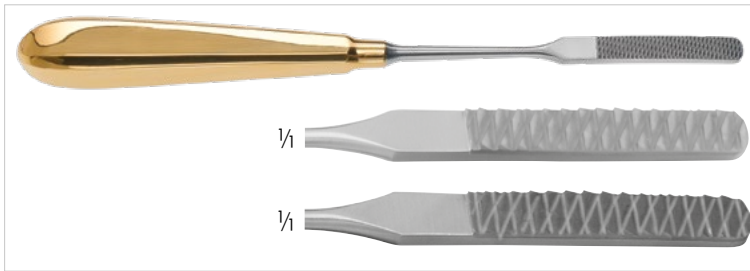

420-480-200 fein
420-488-200 grob

ASTON

Nasenraspel, 200 mm
Nasal rasp, 8 inch



420-650-100

PEET-COTTLE

Nasenraspel, gebogen, RZ diamantiert, 175 mm
Nasal rasp, curved, RZ diamond tip, 7 inch

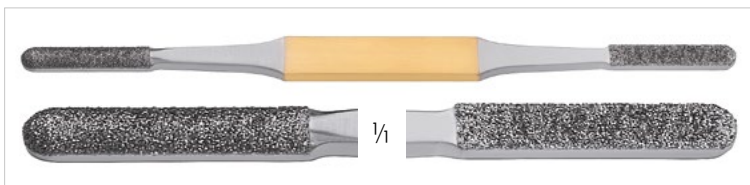

420-653-000

FOMON

Raspel, doppelendig, RZ diamantiert, grob,
convex/flach, 7 x 40 mm, 210 mm
Rasp, double ended, coarse RZ diamond tip,
convex on flat, 7 x 40 mm, 8 1/4 inch

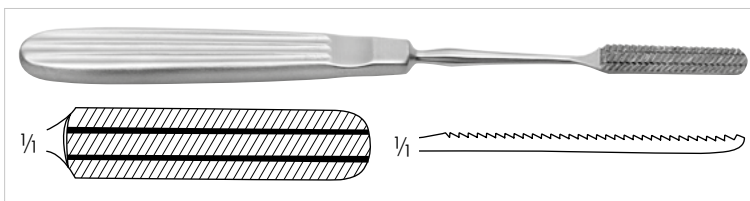

420-628-254

RUBIN

Nasenraspel, 30% schräg, konkav, 200 mm
Nasal rasp, 30% oblique, concave, 8 inch



420-654-180 auf Zug/backward cutting

420-657-180 auf Druck/forward cutting

ORIGINAL MALTZ

Nasenraspel, gerade, 180 mm
Nasal rasp, straight, 7 inch



420-655-180

MCINDOE

Nasenraspel, auf Zug, gerade, 180 mm
Nasal rasp, backward cutting, 7 inch



420-756-180

BARSKY-GLABELLA

Nasenraspel, auf Zug, gerade, 175 mm
Nasal rasp, backward cutting, 7 inch



260-500-001

Reinigungsbürste für TC Raspeln
Cleaning brushes for TC rasps



420-700-400
NOLST TRENITÉ
 Glabella Raspel, 8mm breit, 185mm
 Glabella Rasp, 8mm wide, 185mm



420-700-501 medium
 420-700-502 medium/fine
NOLST TRENITÉ
 Nasen Raspel, doppelendig, TC Einsätze, 200mm
 Nasal Rasp, double ended, TC Inserts, 200mm



420-700-001 1 Zahn / 1 prong
 420-700-002 2 Zähne / 2 prongs
NOLST TRENITÉ
 Mikro Hauthäkchen, 155mm
 Micro Skin Hook, 155mm



420-700-210
NOLST TRENITÉ
 Mikro Hauthäkchen, 2 Zähne, 10mm breit
 Micro Skin Hook, 2 prongs, 10mm wide



420-700-200
NOLST TRENITÉ
 Aufrecht Nasen Retraktor, 160mm
 Aufrecht Nasal Retractor, 160mm



420-700-020 2.0mm
 420-700-025 2.5mm
 420-700-030 3.0mm
 420-700-040 4.0mm
 420-700-060 6.0mm
NOLST TRENITÉ
 Mikro Osteotom
 Micro Osteotome



420-700-022 2.2mm
 420-700-023 3.0mm
 420-700-024 4.0mm

NOLST TRENITÉ

Mikro Osteotom mit Schutz
 Micro Osteotome with guard



420-700-100 10mm
 420-700-120 12mm
 420-700-140 14mm
 420-700-160 16mm
 420-700-180 18mm

NOLST TRENITÉ

Osteotom
 Osteotome

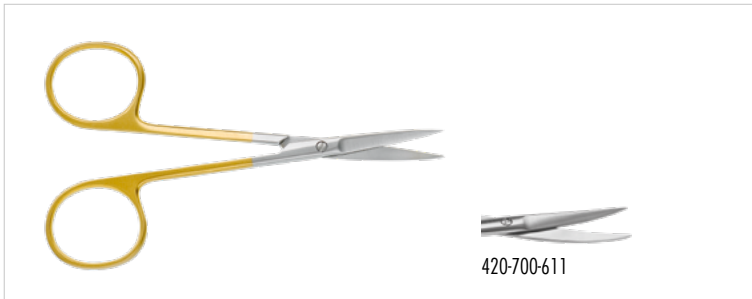

420-700-610 gerade / straight
 420-700-611 gebogen / curved

NOLST TRENITÉ

Rhinoplastik Schere, spitz 100mm
 Rhinoplasty Scissors, sharp, 100mm



420-700-340

NOLST TRENITÉ

Plastik Schere, Kilner Ausführung, 140mm
 Dissecting Scissors, Kilner type, 140mm



420-700-620

NOLST TRENITÉ

Gewinkelte Schere, Walter Ausführung, 100mm
 Angled Scissors, Walter type, 100mm



420-700-630

NOLST TRENITÉ

Chirurgische Pinzette mit seitlichen Zähnen, Adson-Brown Ausführung, 120mm

Tissue Forceps, side grasping teeth, Adson-Brown type, 120mm



420-700-640

NOLST TRENITÉ

Anatomische Pinzette, Adson-Ausführung, 120mm

Dressing Forceps, Adson type, 120mm

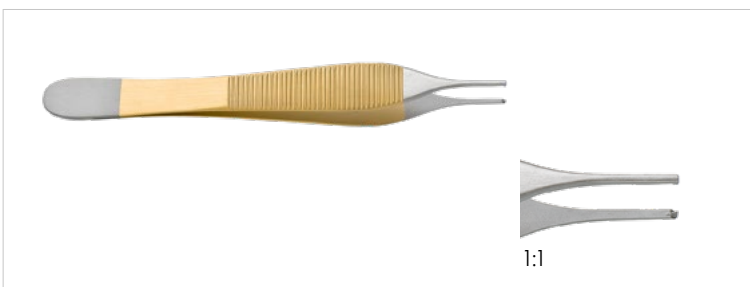

420-700-650

NOLST TRENITÉ

Chirurgische Pinzette, Adson-Ausführung, 120mm

Tissue Forceps, Adson type, 120mm



420-700-330

NOLST TRENITÉ

Nadelhalter mit TC Einsätzen, Hasley Ausführung, 130mm

Needle Holder, TC Inserts, Hasley Type, 130mm



420-700-700

NOLST TRENITÉ

Nasal Forceps, delicate, Blakesley type, 3.5mm, 85mm
Nasenzange, zart, Blakesley-Ausführung, 3,5mm, 85mm



420-700-888

NOLST TRENITÉ

Hammer, Cottle Ausführung
Mallet, Cottle type



420-700-777

NOLST TRENITÉ

Knorpelquetscher, Cottle Ausführung
Cartilage Crusher, Cottle type

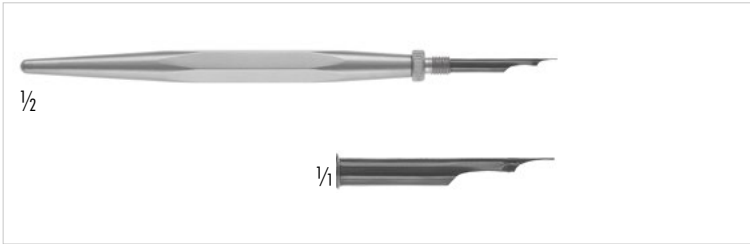

420-832-145

ECKHOFF

Hautmarkierstift, mit versenkbarer Spitze, verchromt, zum Schutz während der Sterilisation
Skin marking pen, with reversible holder for point, chromium plated

420-832-001

Ersatzfeder
Spare nib

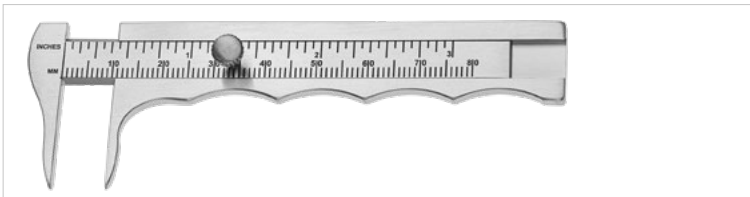

400-421-000

JAMESON

Zirkel mit Schlußschraube, graduert, 0 - 80 mm
Caliper with locking screw, graduated, 0 - 80 mm

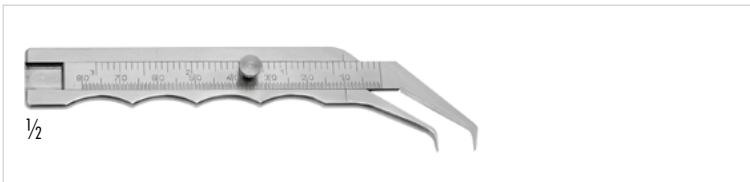

400-420-100

THORPE

Zirkel, mit Schlußschraube, 0-80 mm
Caliper, with locking screw, 0-80 mm



400-583-005

0 - 15 mm, 70mm

400-583-007

0 - 20 mm, 85mm

400-583-008

0 - 40 mm, 180mm

CASTROVIEJO

Hautmeßzirkel
Caliper

400-583-009

CASTROVIEJO

Hautmeßzirkel, Meßbereich 0 - 20 mm, gebogene Spitze, 70mm
Caliper, measuring range 0 - 20 mm, curved tip, 2 3/4 inch

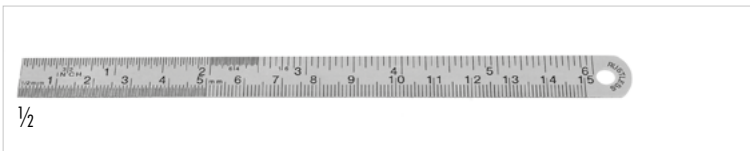

100-418-150

150mm, 6 inch

100-418-200

200mm, 8 inch

Lineal, mit mm und inch Markierung
Ruler, with mm and inch markings

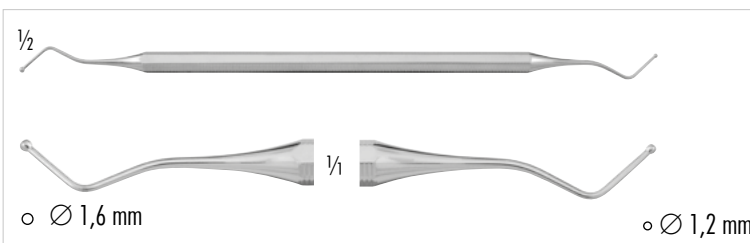

500-270-002

Tamponaden-Stopfer, doppelt, Ø 1,6/1,2 mm, 170 mm
Dressing plugger, double-ended, Ø 1.6/1.2 mm, 6 3/4 inch

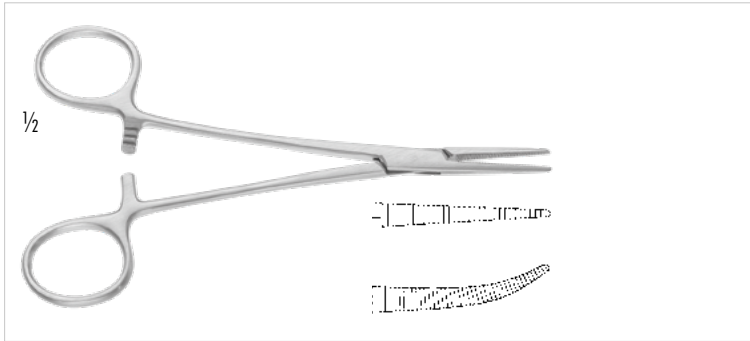

140-254-125 gerade/straight
 140-255-125 gebogen/curved
HALSTED-MOSQUITO
 Arterienklemme, 125 mm
 Hemostatic forceps, 5 inch

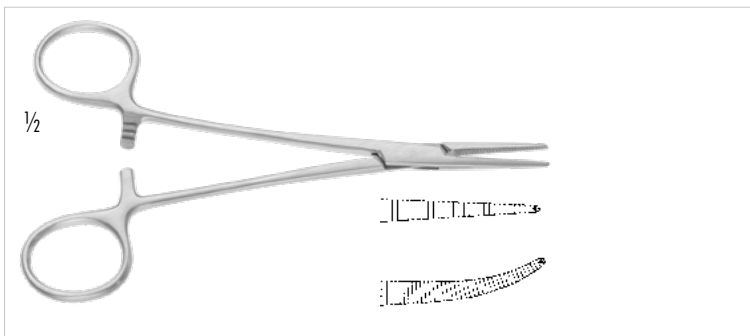

140-256-125 gerade/straight
 140-257-125 gebogen/curved
HALSTED-MOSQUITO
 Arterienklemme, 1 x 2 Zähne, 125 mm
 Hemostatic forceps, 1 x 2 teeth, 5 inch



140-280-140 gerade/straight
 140-281-140 gebogen/curved
KELLY
 Arterienklemme, gerieft, 140 mm
 Hemostatic forceps, serrated, 5 1/2 inch

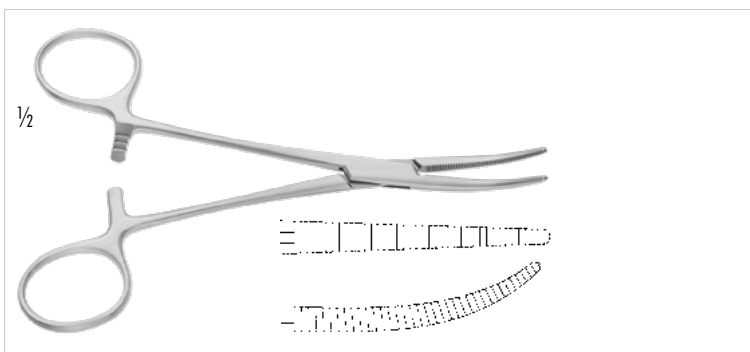

140-290-140 gerade/straight
 140-291-140 gebogen/curved
CRILE (FRASER-KELLY)
 Arterienklemme, 140 mm
 Hemostatic forceps, 5 1/2 inch



165-855-020 3 ml
 165-855-050 5 ml
 165-855-100 10 ml
 Spritze komplett
 Syringe complete



165-856-020 3 ml
 165-856-050 5 ml
 165-856-100 10 ml
 Glaszylinder, allein
 Glas cylinder, only



252-005-170
 Tonsillenkanüle, gerade, mit LUER-Lock-Ansatz, 160 mm
 Tonsil needle, straight, with LUER-lock attachment, 6 1/4 inch



252-003-170
 Septumkanüle, abgewinkelt, mit LUER-Lock Ansatz, 160 mm
 Septum needle, angled, with LUER-lock attachment, 6 1/4 inch



252-004-170
 Tonsillenkanüle, abgewinkelte Spitze, mit LUER-Lock-Ansatz
 Tonsil needle, angled tip, with LUER-lock attachment



252-001-170
 Septumkanüle, bajonettförmig gebogen, mit LUER-Lock Ansatz, 100 mm
 Septum needle, bayonet-shaped, with LUER-lock attachment, 4 inch

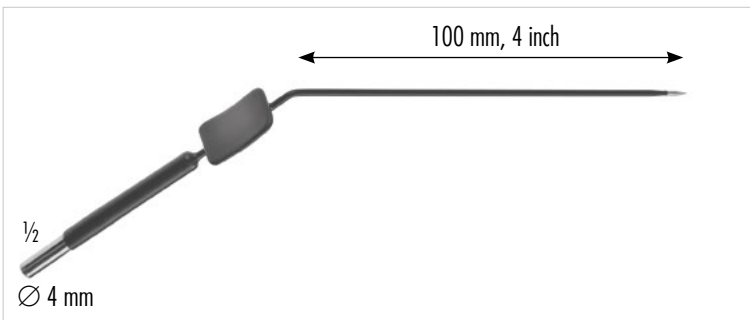

252-204-100
ABBEY
 Resektionsnadel, **isoliert**, mit monopolarem Anschluß
 Sub-mucosal resection needle, **insulated**, with monopolar connector

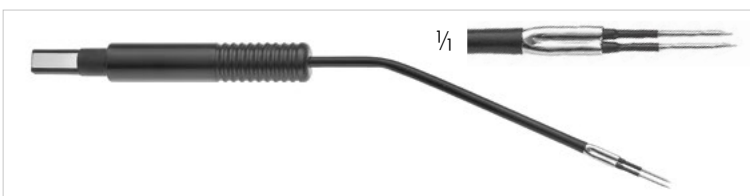

700-420-002
 Bipolare Elektrode für Nase, mit Flachstecker
 Bipolar Electrode for Nose, with flat plug



700-801-165
 Bipolare Pinzette kniegebogen, spitz, Flachstecker 165mm
 Bipolar Forceps angled, pointed, flat-plug square, 6 1/2 inch