

# NASAL RASPS



The major advantages of the RZ tungsten carbide rasps over conventional models are their superior rasping/cutting ability, increased longevity and a clean, precise tissue removal.



TC-Inserts	Fig. 1 0.8	Fig. 2 1.1	Fig. 3 1.3	Fig. 4 1.6	Fig. 5 1.8	Fig. 6 2.0	Fig. 7 2.4	Fig. 8 2.6	Fig. 9 2.8	Fig. 10 3.0
Partition										



Fig. 1	420-491-165
Fig. 2	420-492-165
Fig. 3	420-493-165
Fig. 4	420-494-165
Fig. 5	420-495-165
Fig. 6	420-496-165
Fig. 7	420-497-165
Fig. 8	420-498-165
Fig. 9	420-499-165
Fig. 10	420-500-165

**MALTZ**  
TC Nasal Rasp, 170mm, 6<sup>2</sup>/<sub>3</sub>"



Fig. 1	420-491-230
Fig. 2	420-492-230
Fig. 3	420-493-230
Fig. 4	420-494-230
Fig. 5	420-495-230
Fig. 6	420-496-230
Fig. 7	420-497-230
Fig. 8	420-498-230

**LAMB**  
TC Nasal Rasp, Ergo handle, 230mm, 9"



(Fig. 2 illustrated)

Fig. 2	420-480-200
Fig. 8	420-488-200

### ASTON

TC Nasal Rasp, backward cutting, 200mm, 8"



Fig. 1/Fig. 2	420-660-219
Fig. 3/Fig. 4	420-660-214
Fig. 5/Fig. 6	420-660-216
Fig. 7/Fig. 8	420-660-218
Fig. 9/Fig. 10	420-660-220

### FOMON

TC Nasal Rasp, 40x7mm, 210mm, 8<sup>1</sup>/<sub>4</sub>"



Fig. 1	420-490-210
Fig. 2	420-491-210
Fig. 3	420-492-210
Fig. 4	420-493-210
Fig. 5	420-494-210
Fig. 6	420-495-210
Fig. 7	420-496-210
Fig. 8	420-497-210
Fig. 9	420-498-210
Fig. 10	420-499-210

### PARKES

TC Nasal Rasp, 8x39mm, 210mm, 8<sup>1</sup>/<sub>4</sub>"



### ORIGINAL MALTZ

TC Nasal Rasp, 180mm, 7"

Backward cutting	420-672-000
------------------	-------------

Forward cutting	420-672-004
-----------------	-------------



### GLABELLA

TC Nasal Rasp, 210mm, 8<sup>1</sup>/<sub>4</sub>"

Coarse	420-668-210
--------	-------------

Medium	420-669-210
--------	-------------



### AUFRICHT (PEET)

Nasal Rasp, fine, curved, 25x7mm, diamond dusted

210mm, 8 <sup>1</sup> / <sub>4</sub> "	420-650-101
--	-------------



### PEET-COTTLE

Nasal Rasp, curved, RZ diamonds, 190mm, 7<sup>1</sup>/<sub>2</sub>"

Curved	420-650-100
--------	-------------

Straight	420-650-050
----------	-------------



### FOMON

Rasp, coarse, convex on flat, 40x7mm, diamond dusted

210mm, 8 <sup>1</sup> / <sub>4</sub> "	420-653-000
--	-------------

*Diamond dusted rasps are mainly used for final finishing.*





**FRIEDMAN**  
Nasal Rasp, coarse, round/flat

210mm, 8<sup>1/4</sup>"

420-677-210



**FOMON**  
Rasp, coarse, round/flat

215mm, 8<sup>1/2</sup>"

420-660-000

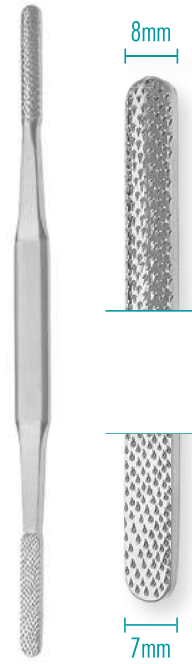

**FOMON**  
Rasp, fine, round/flat

215mm, 8<sup>1/2</sup>"

420-661-000

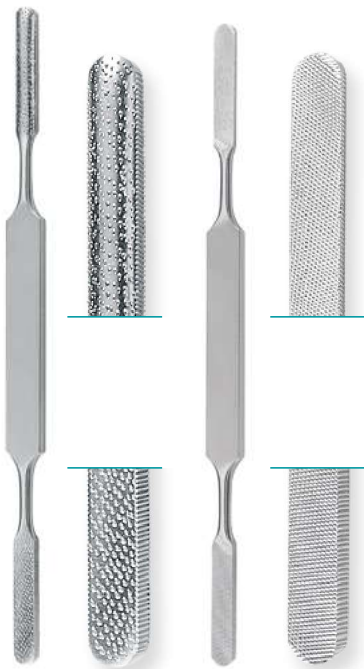

**FOMON**  
Rasp, 4 sides, round/flat, fine/course

210mm, 8<sup>1/4</sup>"

420-661-100

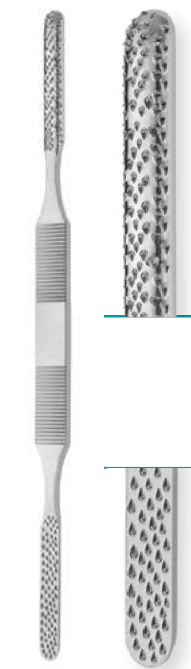

**FOMON**  
Rasp, coarse, lightweight handle design

215mm, 8<sup>1/2</sup>"

420-662-001

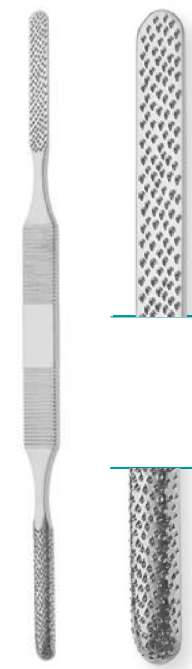

**FOMON**  
Rasp, fine, lightweight handle design

215mm, 8<sup>1/2</sup>"

420-662-002



### **BARSKY-GLABELLA**

Nasal Rasp, backward cutting, curved

175mm, 6<sup>7</sup>/<sub>8</sub>"

420-756-180



### **MCINDOE**

Nasal Rasp, straight, 180mm, 7"

Backward cutting

420-655-180

Forward cutting

420-656-180



### **ORIGINAL MALTZ**

Nasal Rasp, straight, 165mm, 6<sup>1</sup>/<sub>2</sub>"

Backward cutting

420-654-180

Forward cutting

420-657-180

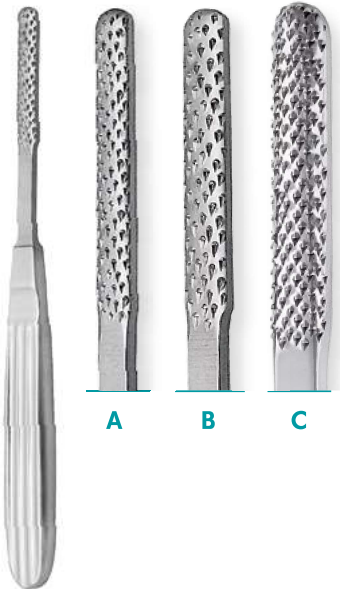

### **LAMONT**

Nasal Rasp, backward cutting, straight, 175mm, 6<sup>7</sup>/<sub>8</sub>"

**A** Delicate

420-690-200

**B** Standard

420-691-200

**C** Wide

420-692-200



### **AUFRICHT**

Nasal Rasp, curved, 210mm, 8<sup>1</sup>/<sub>4</sub>"

Forward cutting

420-650-001

Backward cutting

420-650-002



### **COTTLE**

Nasal Rasp, backward cutting, straight

210mm, 8<sup>1</sup>/<sub>4</sub>"

420-670-210



### GALLAHER

Nasal Rasp, with ring, coarse

170mm, 6<sup>2</sup>/<sub>3</sub>"

420-678-190

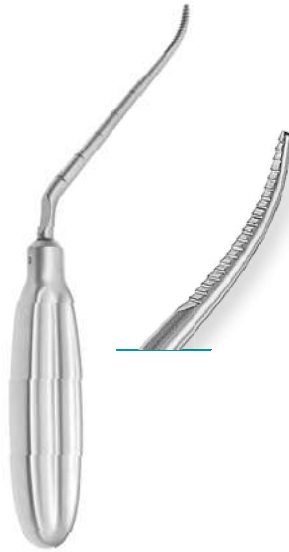

### WATSON-WILLIAMS

Nasal Rasp, convex blade, knee bent, 170mm, 6<sup>2</sup>/<sub>3</sub>"

Fine

420-520-170

Coarse

420-521-170

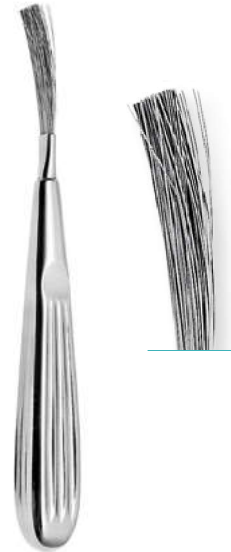

Wire Brush for cleaning Rasps

165mm, 6<sup>1</sup>/<sub>2</sub>"

260-500-001

### FOMON MODULAR Nasal Rasp System



420-660-200 Fomon Nasal Rasp Holder, double-ended



420-660-100 Fomon Nasal Rasp Holder, single ended



420-660-500 Fomon TC Nasal Rasp Set, complete in sterilization tray, incl. 10 inserts, 1 key and 2 handles (single+double)



420-660-101 Fomon TC Insert, Fig. 1

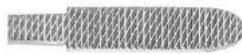

420-660-102 Fomon TC Insert, Fig. 2

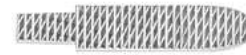

420-660-103 Fomon TC Insert, Fig. 3



420-660-104 Fomon TC Insert, Fig. 4



420-660-105 Fomon TC Insert, Fig. 5



420-660-106 Fomon TC Insert, Fig. 6



420-660-107 Fomon TC Insert, Fig. 7



420-660-108 Fomon TC Insert, Fig. 8



420-660-109 Fomon TC Insert, Fig. 9



420-660-110 Fomon TC Insert, Fig. 10



420-660-150 Key for nasal rasps on the handle



# CHISELS & OSTEOTOMES



## Osteotomes

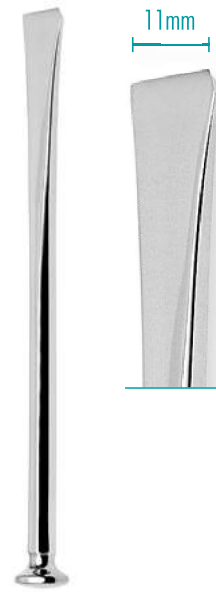
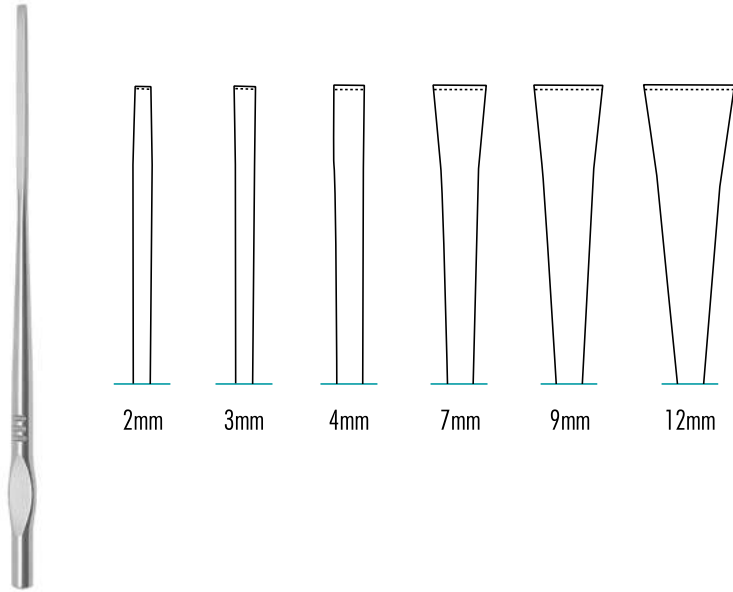

### WALTER

Osteotome, 190mm, 7<sup>1/2</sup>"

2mm	420-580-002	7mm	420-580-007
3mm	420-580-003	9mm	420-580-009
4mm	420-580-004	12mm	420-580-012

### MATTHEW

Osteotome, 180mm, 7"

11mm	420-503-011
------	-------------

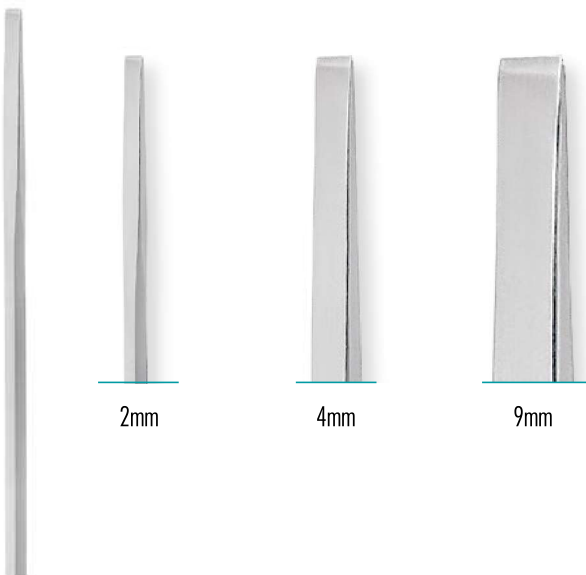

### SHEEHAN

Osteotome, 175mm, 6<sup>3/4</sup>"

2mm	420-594-002	9mm	420-594-009
3mm	420-594-003	10mm	420-594-010
4mm	420-594-004	11mm	420-594-011
5mm	420-594-005	12mm	420-594-012
6mm	420-594-006	15mm	420-594-015
8mm	420-594-008		

### REES

Osteotome, 200mm, 8", with aluminum handle

3.0 mm	420-500-200
--------	-------------

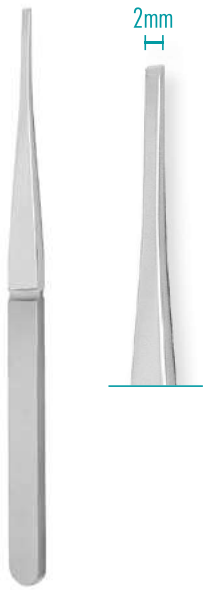

**RZ**  
Osteotome, 180mm, 7"

2mm	420-568-002	8mm	420-568-008
4mm	420-568-004	10mm	420-568-010
6mm	420-568-006		

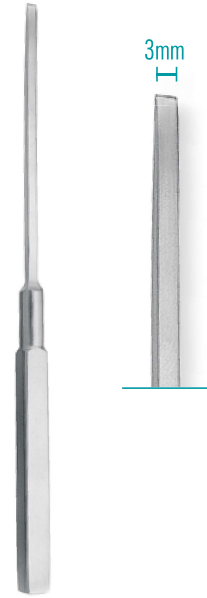

**WARD**  
Osteotome, 180mm, 7"

3mm	420-495-003
4mm	420-495-004
5mm	420-495-005

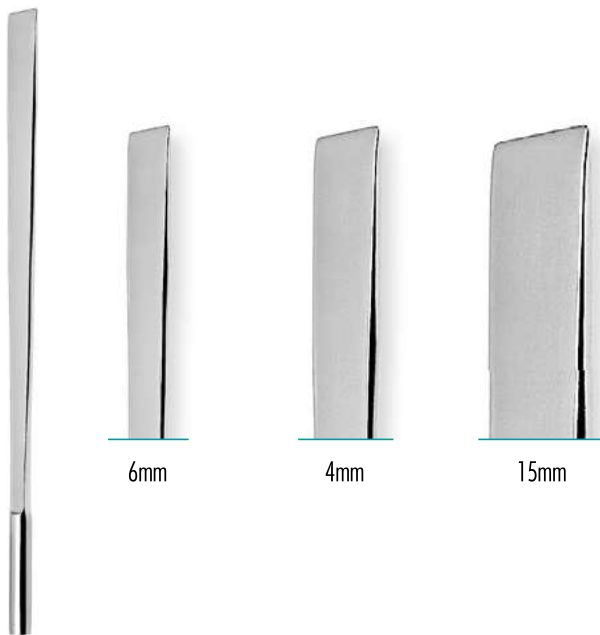

**JAYES**  
Osteotome, 190mm, 7<sup>1/2</sup>"

2mm	420-501-002	10mm	420-501-010
4mm	420-501-004	12mm	420-501-012
6mm	420-501-006	15mm	420-501-015
8mm	420-501-008		



**ROZNER**  
Osteotome, double guarded on the inclined cutting edge

180mm, 7"	420-507-010
-----------	-------------



14mm

### RUBIN

Osteotome, 167mm, 6<sup>1</sup>/<sub>2</sub>" , 8mm wide

8mm	420-587-008
10mm	420-587-010
12mm	420-587-012
14mm	420-587-014
16mm	420-587-016

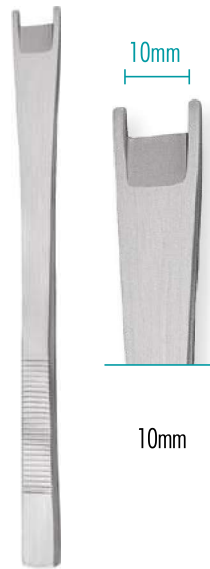

10mm

10mm

### CINELLI

Osteotome, double guarded, 160mm, 6<sup>1</sup>/<sub>4</sub>"

8mm	420-589-008
10mm	420-589-010
12mm	420-589-012
14mm	420-589-014
16mm	420-589-016

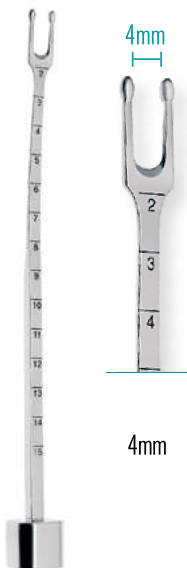

4mm

4mm

### OBWEGESER

Osteotome, buttoned, U-shape cutting edge, 185mm, 7<sup>1</sup>/<sub>4</sub>"

4mm	431-662-190
6mm	431-666-190
8mm	431-668-190



4mm

### OBWEGESER

Osteotome, with V-tip, 175mm, 6<sup>3</sup>/<sub>4</sub>"

Straight	420-460-004
Curved	420-460-005



6mm

### EPKER

Osteotome, straight, 180mm, 7"

4mm	420-498-004
6mm	420-498-006
8mm	420-498-008





5mm

### SILVER

Osteotome, with guard, 180mm, 7"

Straight	420-459-001
Right curved	420-459-002
Left curved	420-459-003

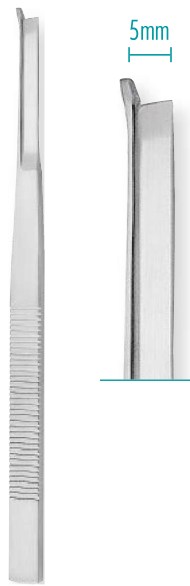

5mm

### MASING

Osteotome, with guard, 180mm, 7"

Straight	420-459-101
Right curved	420-459-102
Left curved	420-459-103

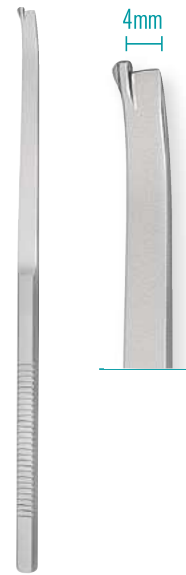

4mm

### ANDERSON-NEIVERT

Osteotome, with guard, 180mm, 7"

Straight	420-639-001
Right curved	420-639-002
Left curved	420-639-003



4mm

### FRENCHAY

Osteotome, with guard, 180mm, 7"

Straight	420-491-000
Right curved	420-491-002
Left curved	420-491-001



4mm

### FANOUS-GUBISCH

Osteotome, straight, 4mm wide, 200mm, 8" with guard

Straight	420-640-001
Right curved	420-640-002
Left curved	420-640-003



5mm

### BRAITHWAITE

Nasal Chisel, 5mm wide, 145mm, 5<sup>3</sup>/<sub>4</sub>"

Guard left	420-485-005
Guard right	420-486-005
Without guard	420-487-005

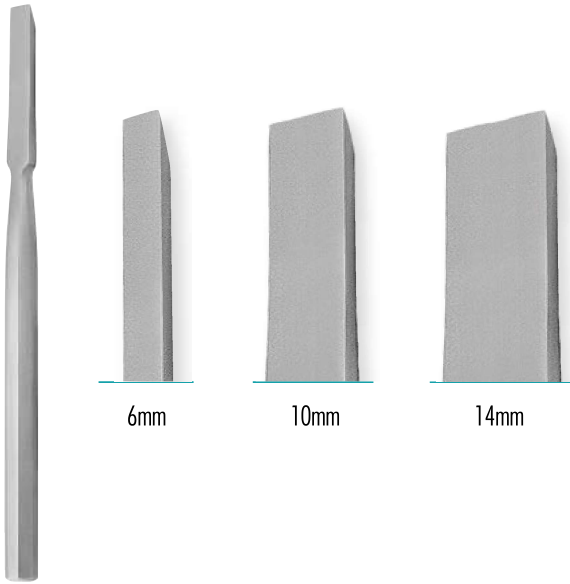

### JENKINS

Nasal Chisel, 145mm, 4"

2mm	420-494-002	10mm	420-494-010
4mm	420-494-004	12mm	420-494-012
6mm	420-494-006	14mm	420-494-014
8mm	420-494-008		



### MCINDOE

Nasal Chisel with Mushroom head, 150mm, 6"

9mm	420-487-009
11mm	420-487-011
13mm	420-487-013
15mm	420-487-015



### COTTLE

Nasal Chisel, black coated, 5mm, 7<sup>1</sup>/<sub>4</sub>"

5mm	420-505-005	11mm	420-505-011
7mm	420-505-007	16mm	420-505-016
9mm	420-505-009		



### MCINDOE

Nasal Chisel, 150mm, 6"

9mm	420-488-009
11mm	420-488-011
13mm	420-488-013
15mm	420-488-015

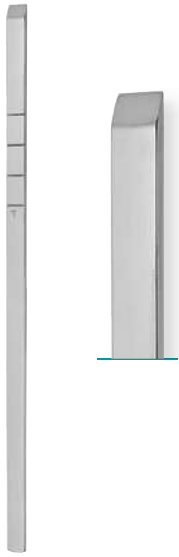

### COTTLE

Chisel, graduated, 185mm, 7<sup>1</sup>/<sub>4</sub>"

4mm	210-488-004	8mm	210-488-008
6mm	210-488-006	9mm	210-488-009
7mm	210-488-007	12mm	210-488-012

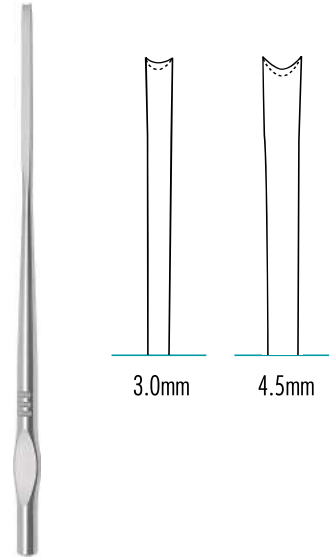

### WALTER

Chisel with notch, double guarded, 190mm, 7<sup>1</sup>/<sub>2</sub>"

3.0mm	420-582-003
4.5mm	420-582-045



### READ

Nasal Gouge, 180 mm, 7"

3mm	420-492-003
4mm	420-492-004
5mm	420-492-005
6mm	420-492-006



### KILLIAN

Septum Gouge, round cutting edge, 170mm, 6<sup>3</sup>/<sub>4</sub>"

6mm	420-552-170
-----	-------------



### KILLIAN-CLAUS

Septum Gouge, notched cutting edge, 170mm, 6<sup>3</sup>/<sub>4</sub>"

6mm	420-551-170
-----	-------------

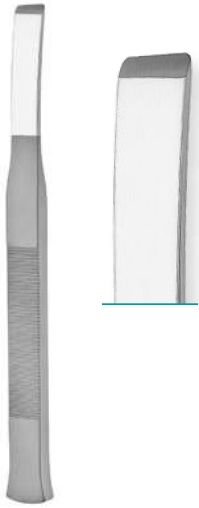

### TESSIER

Osteotome, straight, 160mm, 6<sup>1</sup>/<sub>4</sub>"

2mm	420-502-002	10mm	420-502-010
3mm	420-502-003	15mm	420-502-015
5mm	420-502-005	18mm	420-502-018
7mm	420-502-007		



### TESSIER

Osteotome, curved, 200mm, 8"

10mm	420-502-211
15mm	420-502-216



### TESSIER

Osteotome, straight, 200mm, 8"

10mm	420-502-210
15mm	420-502-215

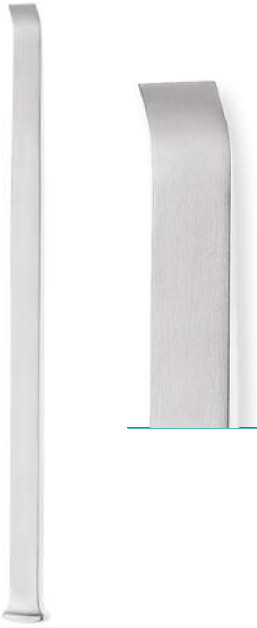

### OBWEGESER

Osteotome, curved, 230mm, 9"

8mm	431-643-008
-----	-------------

11mm	431-643-011
------	-------------



### OBWEGESER

Osteotome, thin blade, 220mm, 8<sup>3</sup>/<sub>4</sub>"

8mm	431-645-008
-----	-------------

12mm	431-645-012
------	-------------

16mm	431-645-016
------	-------------



### OBWEGESER-RAMUS

Osteotome, wedge-shaped, 220mm, 8<sup>3</sup>/<sub>4</sub>"

8mm	431-646-008
-----	-------------

12mm	431-646-012
------	-------------

16mm	431-646-016
------	-------------



### OBWEGESER

Osteotome, tapered, 220mm, 8<sup>3</sup>/<sub>4</sub>"

7mm	431-645-007
-----	-------------

10mm	431-645-010
------	-------------

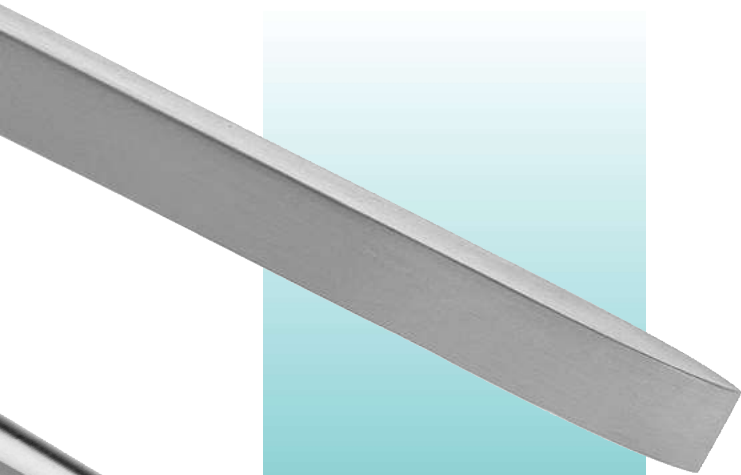

OSTEOTOME

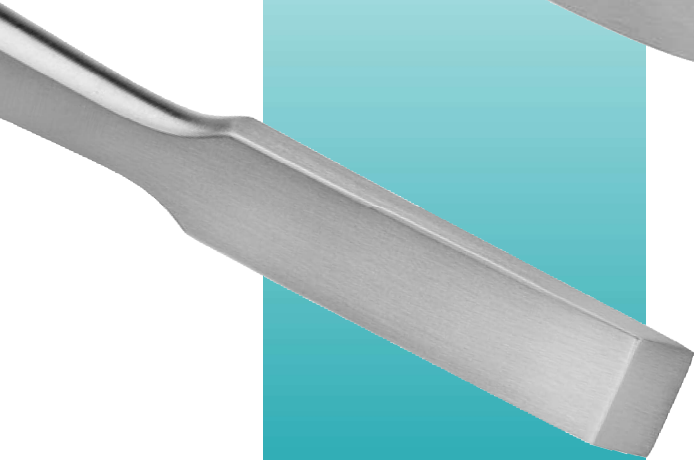

CHISEL

# ADVANCED RHINOPLASTIC SET

420-990-004



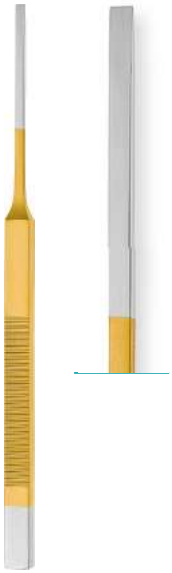

Micro Osteotome  
185mm, 7<sup>1</sup>/<sub>4</sub>"

2.0mm	420-700-020
2.5mm	420-700-025
3.0mm	420-700-030

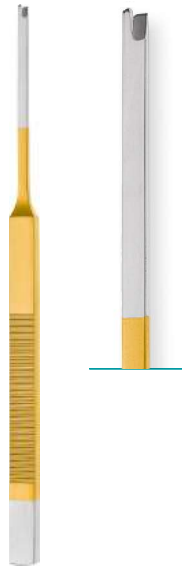

Micro Osteotome  
with guard, 185mm, 7<sup>1</sup>/<sub>4</sub>"

2.2mm	420-700-022
-------	-------------

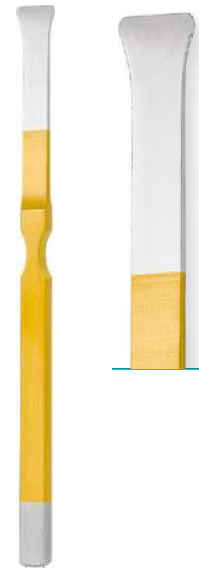

Micro Osteotome  
185mm, 7<sup>1</sup>/<sub>4</sub>"

10mm	420-700-100
12mm	420-700-120
14mm	420-700-140



**JOSEPH**  
Periosteal Elevator, 180mm, 7"

3mm	420-700-430
-----	-------------



Skin Hook  
2 prongs, 10mm wide

120mm, 4 <sup>3</sup> / <sub>4</sub> "	420-700-210
--	-------------



Micro Skin Hook  
155mm, 6"

1 prong	420-700-001
2 prongs	420-700-002





**Glabella Rasp**  
8mm wide

185mm, 7<sup>1</sup>/<sub>4</sub>"

420-700-400

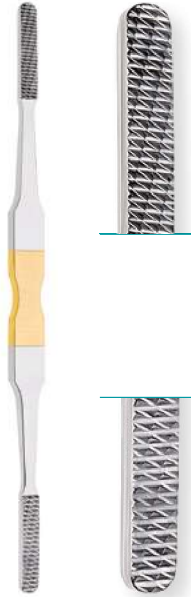

**TC Nasal Rasp**  
double-ended, 200mm, 7<sup>3</sup>/<sub>4</sub>"

Medium

420-700-501

Medium & fine

420-700-502



**AUFRICHT**  
Nasal Retractor, 160mm, 6<sup>1</sup>/<sub>4</sub>"

160mm, 6<sup>1</sup>/<sub>4</sub>"

420-700-200

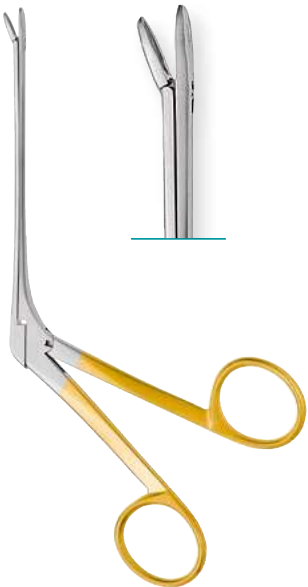

**BLAKESLEY**  
Nasal Forceps, delicate, 110mm, 4<sup>1</sup>/<sub>2</sub>"

110mm, 4<sup>1</sup>/<sub>2</sub>"

420-700-700



**HALSEY**  
TC Needle Holder, 130mm, 5"

130mm, 5"

420-700-330



**KILNER**  
Dissecting Scissors

140mm, 5<sup>1</sup>/<sub>2</sub>"

420-700-340



Rhinoplasty Scissors  
sharp, 100mm, 4"

Straight

420-700-610

Curved

420-700-611



**WALTER**  
Scissors, angled

100mm, 4"

420-700-620



**ADSON-BROWN**  
Tissue Forceps, lateral grasping teeth with 7x7 brown teeth

120mm, 4<sup>3</sup>/<sub>4</sub>"

420-700-630



**ADSON**  
Dressing Forceps

120mm, 4<sup>3</sup>/<sub>4</sub>"

420-700-640



**ADSON**  
Tissue Forceps, 1x 2 teeth

120mm, 4<sup>3</sup>/<sub>4</sub>"

420-700-650

# MALLETS





Weight	240g
Diameter	30mm

**COTTLE**  
Mallet, with plain and convex side

190mm, 7<sup>1</sup>/<sub>2</sub>"      210-240-180



Weight	140g
Diameter	25mm

**BERGMANN**  
Mallet, with exchangeable plastic discs

185mm, 7<sup>1</sup>/<sub>4</sub>"      210-264-140

Spare plastic discs

One pair      210-265-000



Weight	320g
Diameter	27mm

**MEAD**  
Mallet, with exchangeable plastic discs

190mm, 7<sup>1</sup>/<sub>2</sub>"      210-262-170

Spare plastic discs

One pair      210-263-000



Weight	130g
Diameter	27mm

**HAJEK**  
Mallet

220mm, 8<sup>3</sup>/<sub>4</sub>"      210-244-220



Weight	117g
Diameter	19mm

**RZ**  
Mallet, with copper head

170mm, 6<sup>2</sup>/<sub>3</sub>"      210-019-170

# NASAL SPECULA





**THUDICHUM (MARK HOVELL)**  
Nasal Speculum, non-insulated

Blade size	Total length	Order Number
8.5 x 6mm	70mm	420-050-001
9 x 7mm	70mm	420-050-002
12.5 x 8mm	70mm	420-050-003
15 x 8.5mm	70mm	420-050-004
16.5 x 9mm	70mm	420-050-005
18 x 10mm	70mm	420-050-006
19.5 x 10.5mm	70mm	420-050-007



**THUDICHUM (MARK HOVELL)**  
Nasal Speculum, insulated

Blade size	Total length	Order Number
8.5 x 6mm	70mm	420-050-101
9 x 7mm	70mm	420-050-102
12.5 x 8mm	70mm	420-050-103
15 x 8.5mm	70mm	420-050-104
16.5 x 9mm	70mm	420-050-105
18 x 10mm	70mm	420-050-106
19.5 x 10.5mm	70mm	420-050-107

8.5 x 6 mm

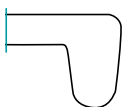

9 x 7 mm

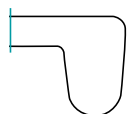

12.5 x 8 mm

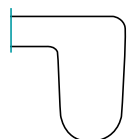

15 x 8.5mm

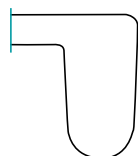

16.5 x 9 mm

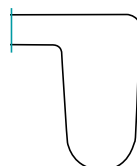

18 x 10mm

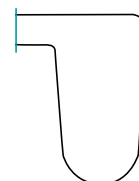

19.5 x 10.5mm

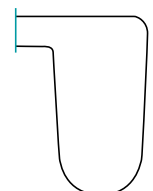



**ST. CLAIR THOMPSON**  
Nasal Speculum

Blade length	Total length	Order Number
38mm	73mm	420-052-001
50mm	73mm	420-052-002
65mm	73mm	420-052-003
75mm	73mm	420-052-004

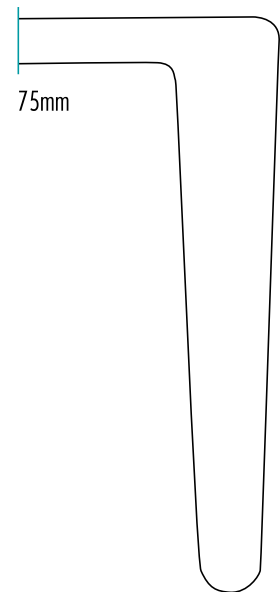
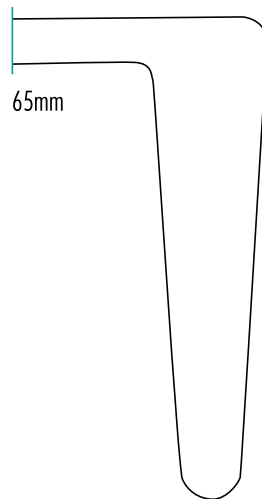
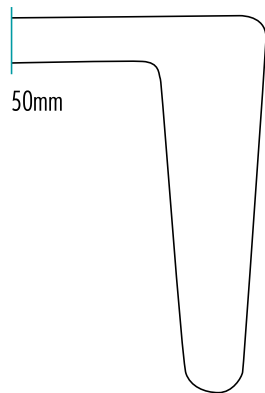
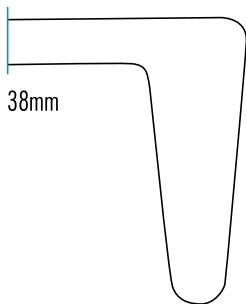

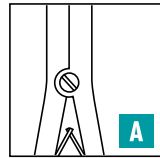

Blade length	Total length	A - Without locking screw
28mm	140mm	420-100-001
30mm	140mm	420-100-002
32mm	140mm	420-100-003

**WIENER MODELL**  
Nasal Speculum, screw joint

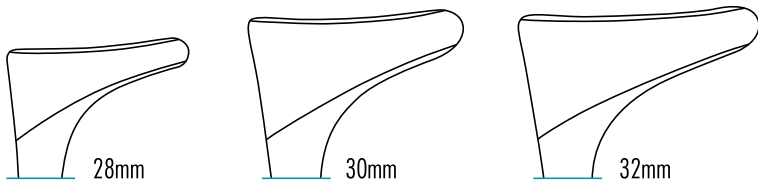



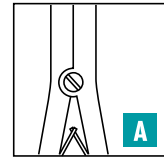

Blade length	Total length	A - Without locking screw
29mm	155mm	420-120-150
31mm	155mm	420-122-150
37mm	155mm	420-123-150

**HARTMANN-HALLE**  
Nasal Speculum, tapered blade, screw joint

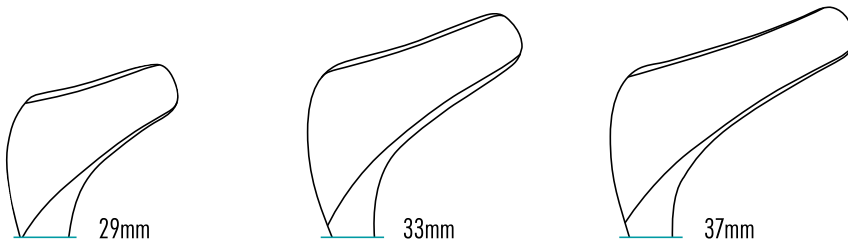

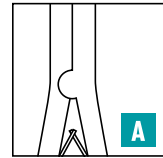

Blade length	Total length	A - Without locking screw
29mm	155mm	420-124-029
33mm	155mm	420-124-033
37mm	155mm	420-124-037

**HARTMANN-HALLE**  
Nasal Speculum, tapered blade, aseptic joint

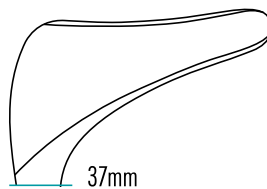
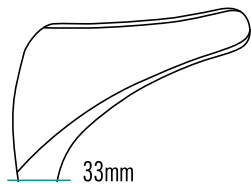
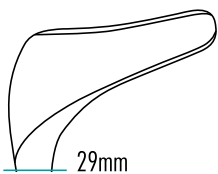

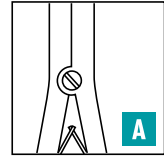

Blade length	Total length	A - Without locking screw
29mm	160mm	420-119-001
33mm	160mm	420-119-002
35mm	160mm	420-119-003

**HARTMANN**  
Nasal Speculum, screw joint

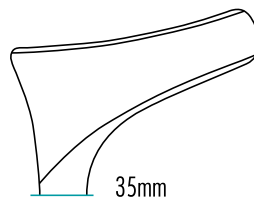
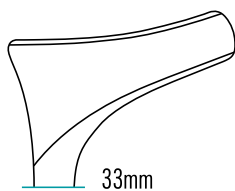
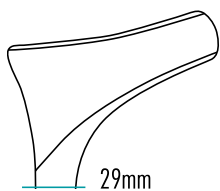

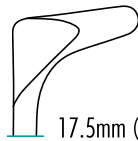
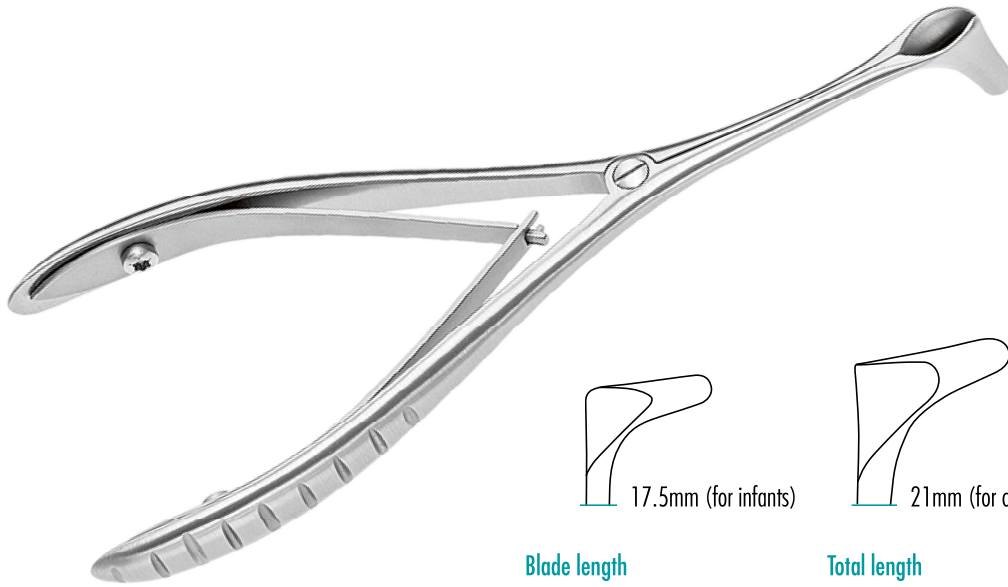

17.5mm (for infants)

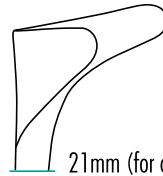

21mm (for children)

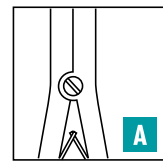

Blade length	Total length	A - Without locking screw
17.5mm (for infants)	130mm	420-140-135
21mm (for children)	130mm	420-142-135

### HALLÉ-TIECK

Nasal Speculum, screw joint

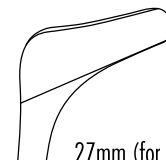
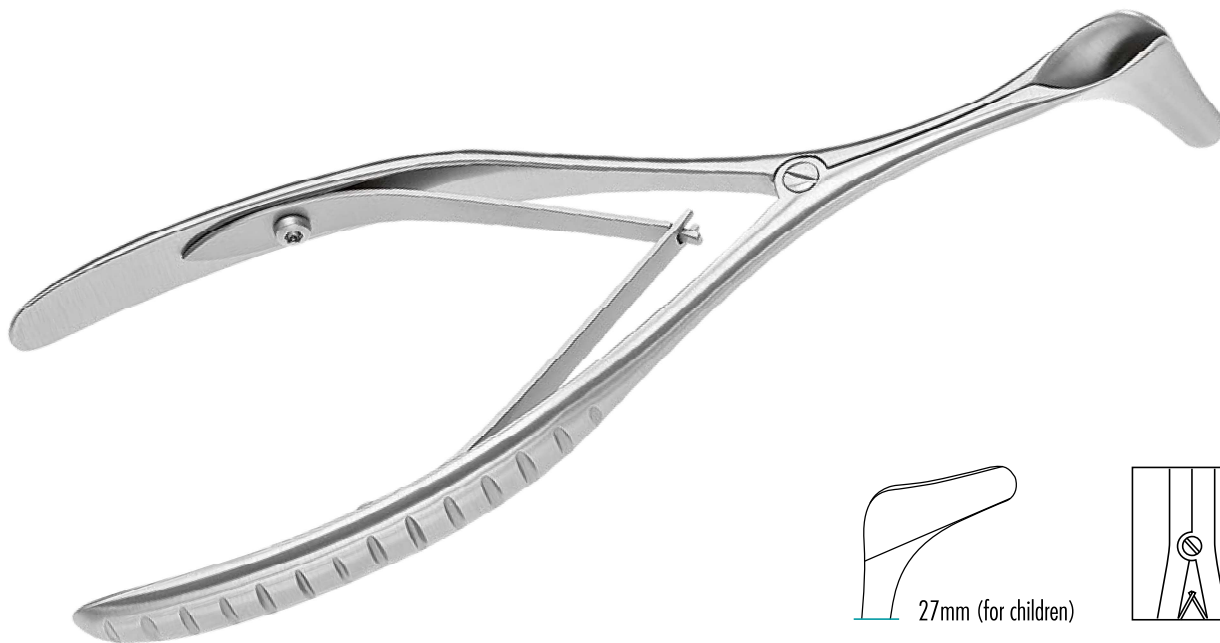

27mm (for children)

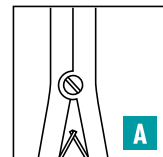

Blade length	Total length	A - Without locking screw
27mm (for children)	150mm	420-150-150

### HARTMANN-HALLE MOD. SONNENSCHN

Nasal Speculum, screw joint

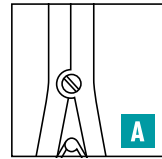
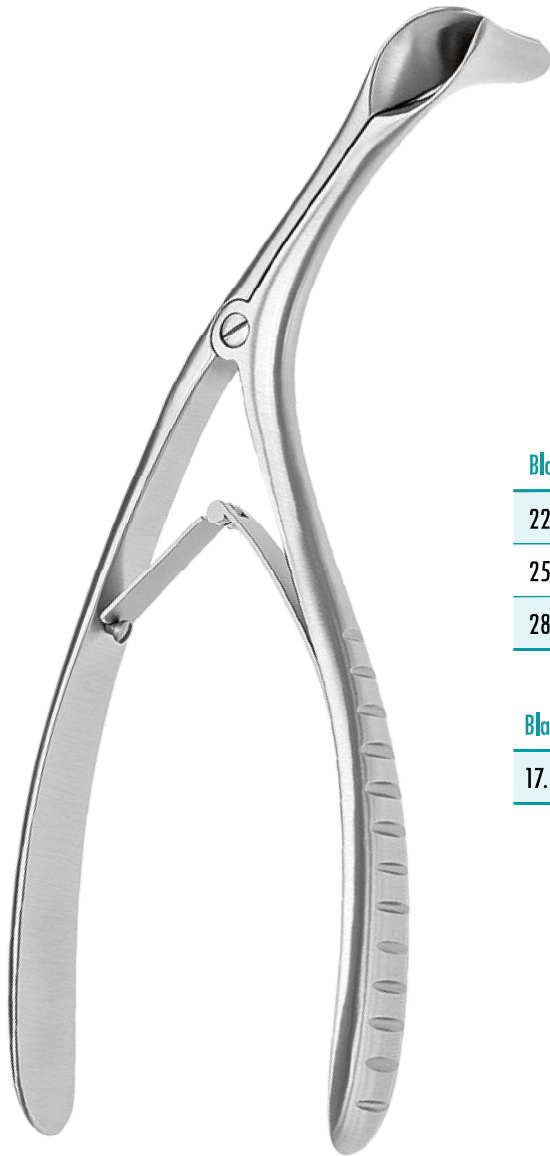

Blade length	Total length	A - Without locking screw
22mm	150mm	420-148-150
25mm	150mm	420-146-152
28mm	155mm	420-146-153

Blade length	Total length	A - Without locking screw
17.5mm (for infants)	130mm	420-147-140

**BECKMANN**  
Nasal Speculum, screw joint

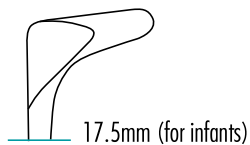
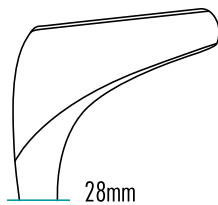
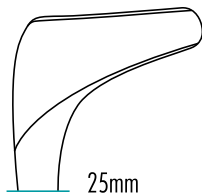
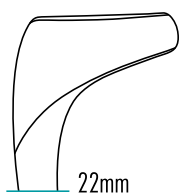

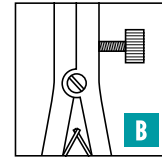
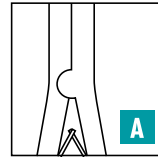
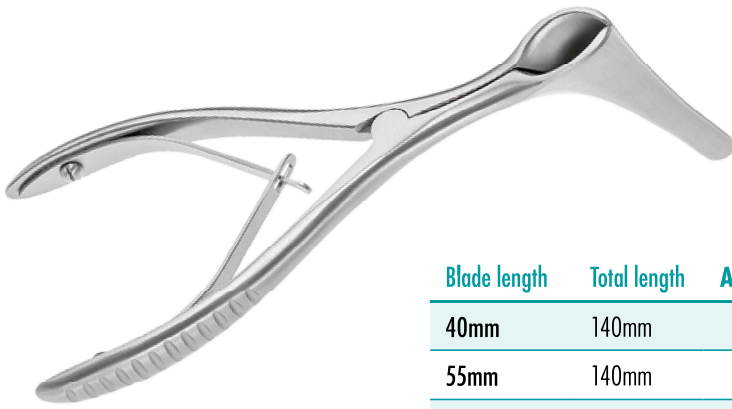

Blade length	Total length	A - Without locking screw, aseptic joint	B - With locking screw, screw joint
40mm	140mm	420-143-040	420-148-040
55mm	140mm	420-143-055	420-148-055
75mm	140mm	420-143-075	420-148-075
90mm	140mm	420-143-090	420-148-090

**KILLIAN STANDARD**  
Nasal Speculum

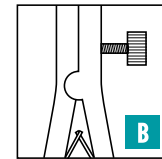
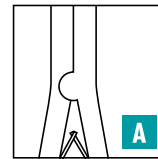
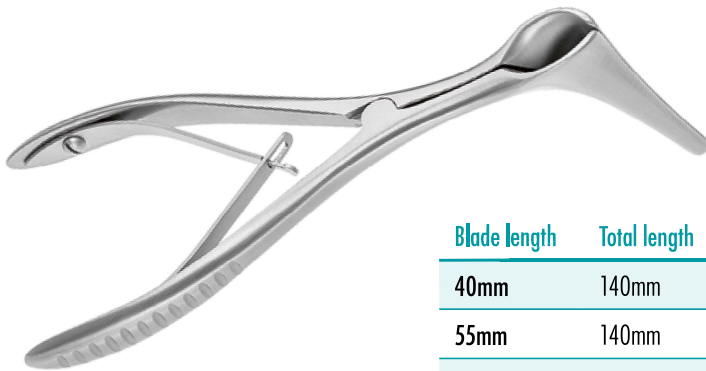
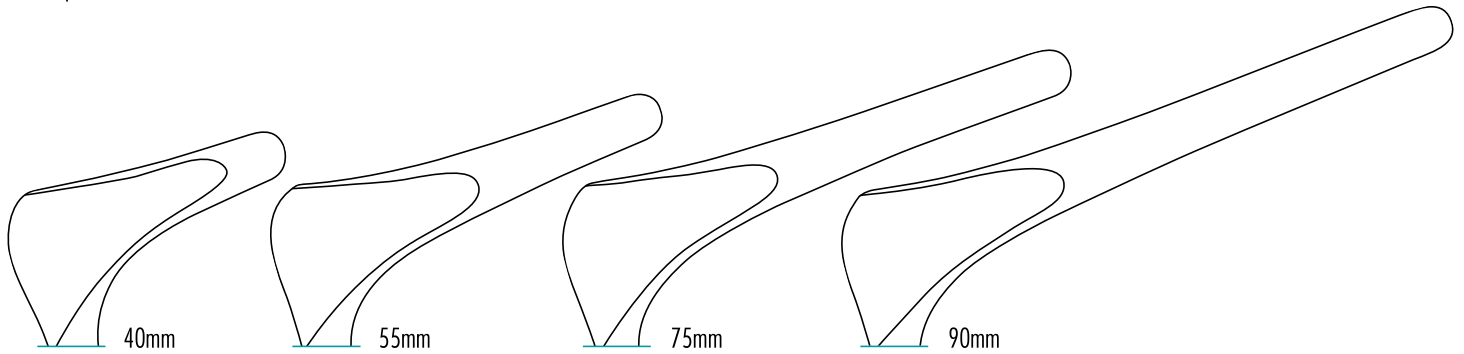

Blade length	Total length	A - Without locking screw	B - With locking screw
40mm	140mm	420-144-040	420-141-040
55mm	140mm	420-144-055	420-141-055
75mm	140mm	420-144-075	420-141-075
90mm	140mm	420-144-090	420-141-090

**KILLIAN**  
Nasal Speculum, tapered blades, aseptic joint

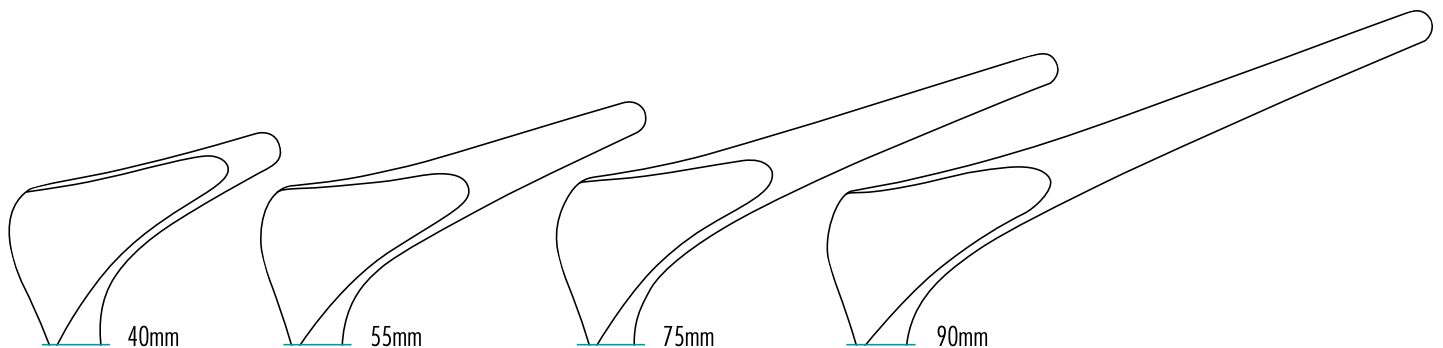

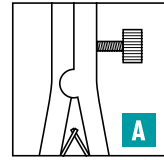
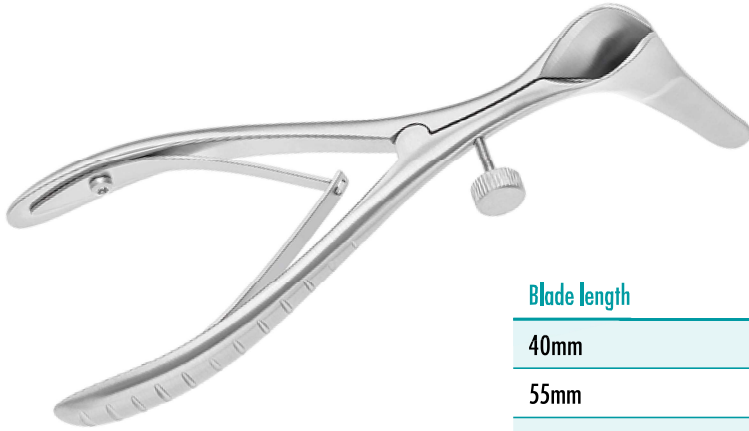

Blade length	Total length	A - With locking screw
40mm	140mm	420-138-040
55mm	140mm	420-138-055
75mm	140mm	420-138-075
90mm	140mm	420-138-090

### KILLIAN-WALTER

Nasal Speculum, thin blades, aseptic joint

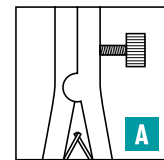
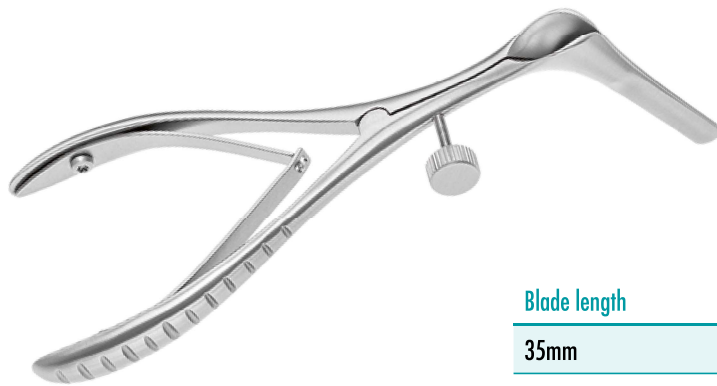
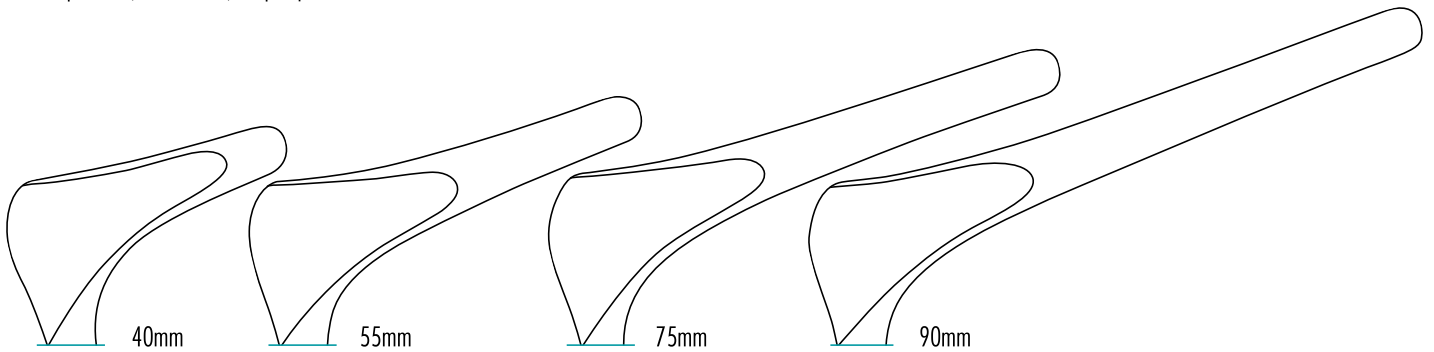

Blade length	Total length	A - With locking screw
35mm	130mm	420-139-035
55mm	130mm	420-139-055
75mm	130mm	420-139-075

### WALTER

Nasal Speculum, very thin blade, aseptic joint

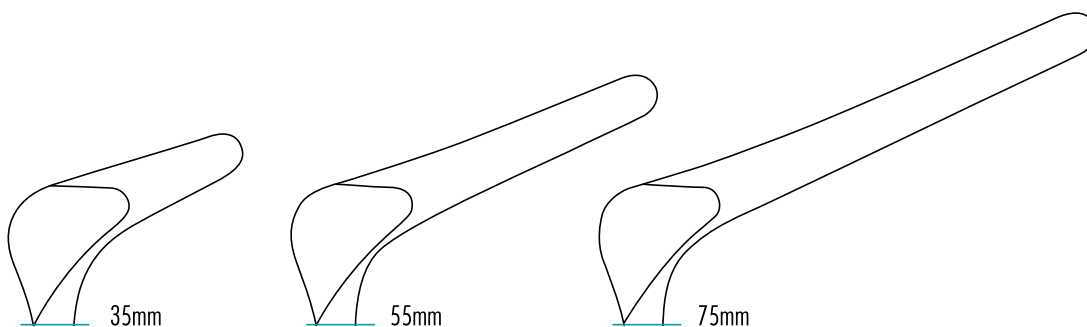

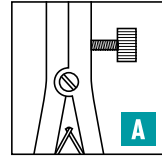
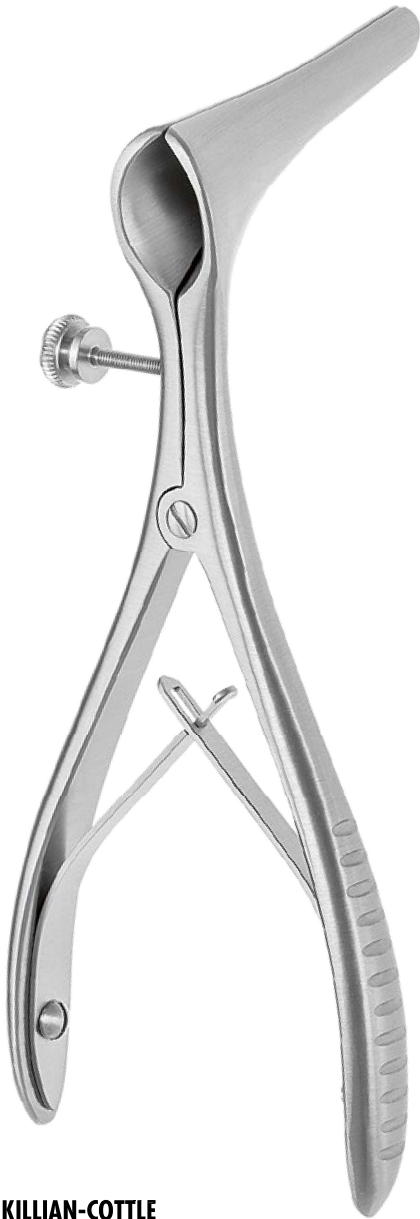

Blade length	Total length	A - With locking screw
30mm	135mm	420-136-020
38mm	135mm	420-136-035
55mm (tapered blade)	140mm	420-134-050
55mm	135mm	420-136-055
70mm	135mm	420-136-070
80mm	135mm	420-136-080
90mm	140mm	420-136-090

**KILLIAN-COTTLE**  
Nasal Speculum, screw joint

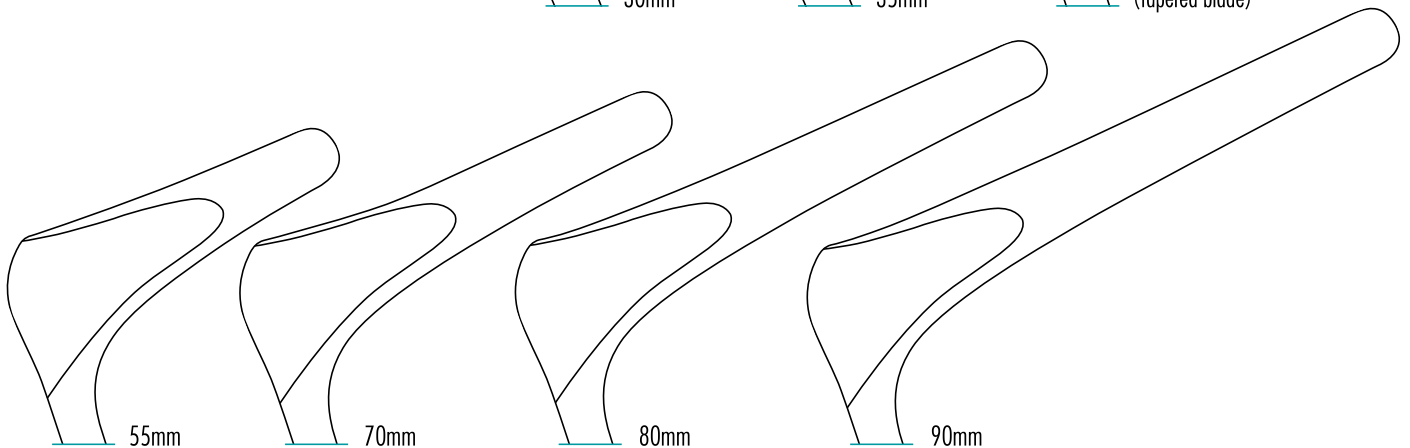
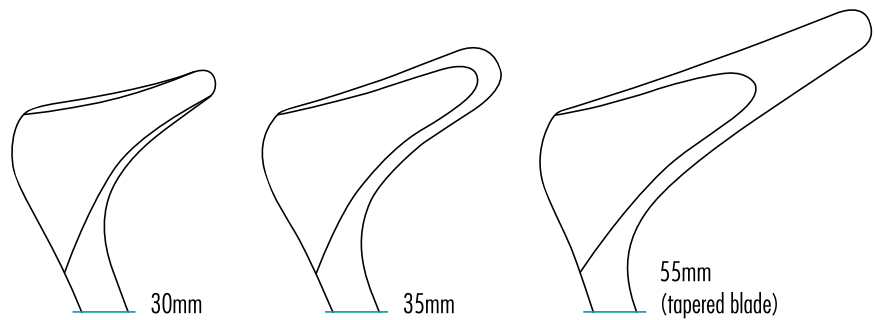



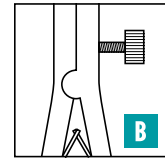
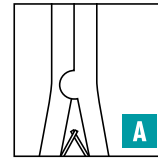

Blade length	Total length	A - Without locking screw	B - With locking screw
40mm	140mm	420-147-040	420-146-040
55mm	140mm	420-147-055	420-146-055
75mm	140mm	420-147-075	420-146-075
90mm	140mm	420-147-090	420-146-090

**KILLIAN-STRUYCKEN**  
Nasal Speculum, aseptic joint

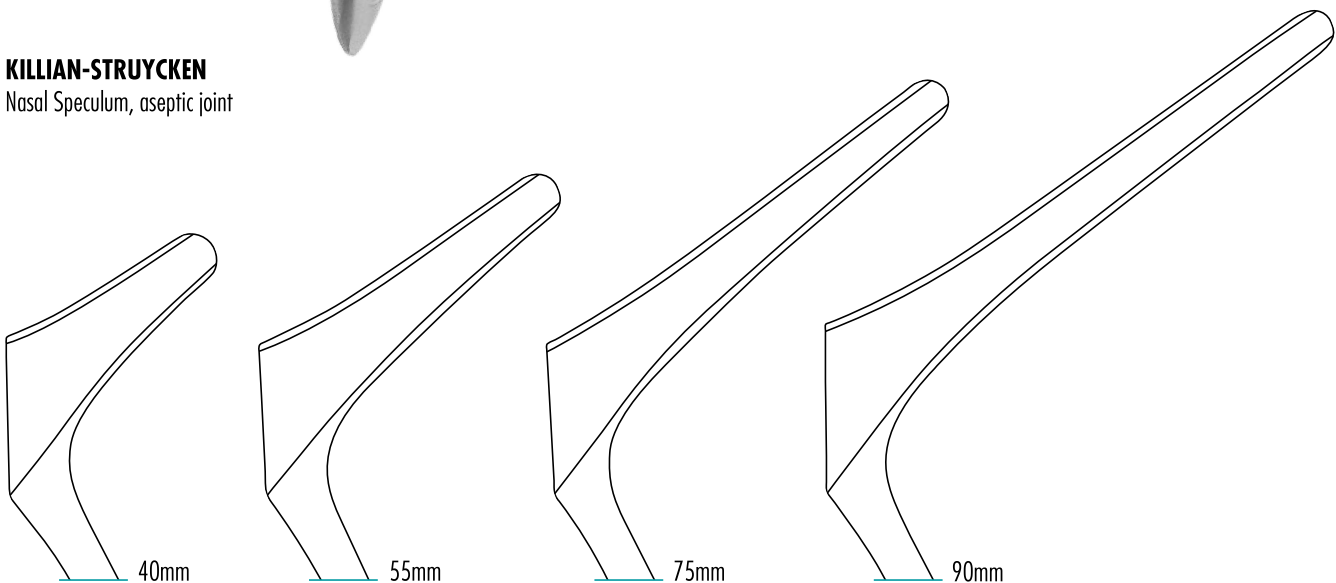



**COTTLE**  
Nasal Speculum, aseptic joint

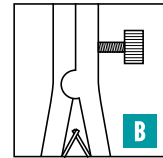
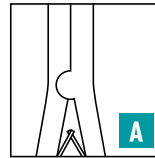

Blade length	Total length	A - Without locking screw	B - With locking screw
35mm	130mm	420-132-035	420-135-035
50mm	130mm	420-132-055	420-135-055
75mm	130mm	420-132-075	420-135-075
90mm	130mm	420-132-090	420-135-090

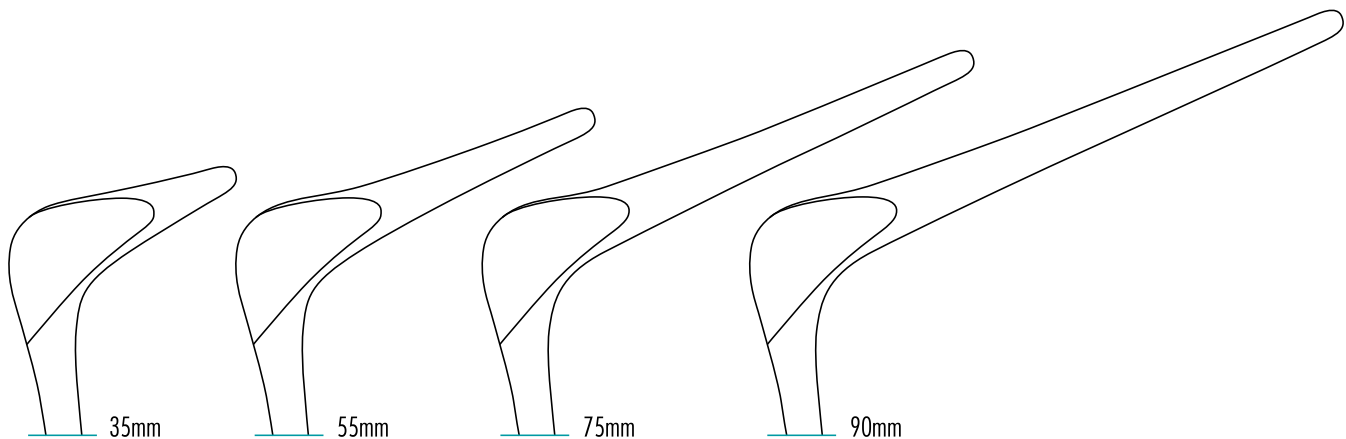

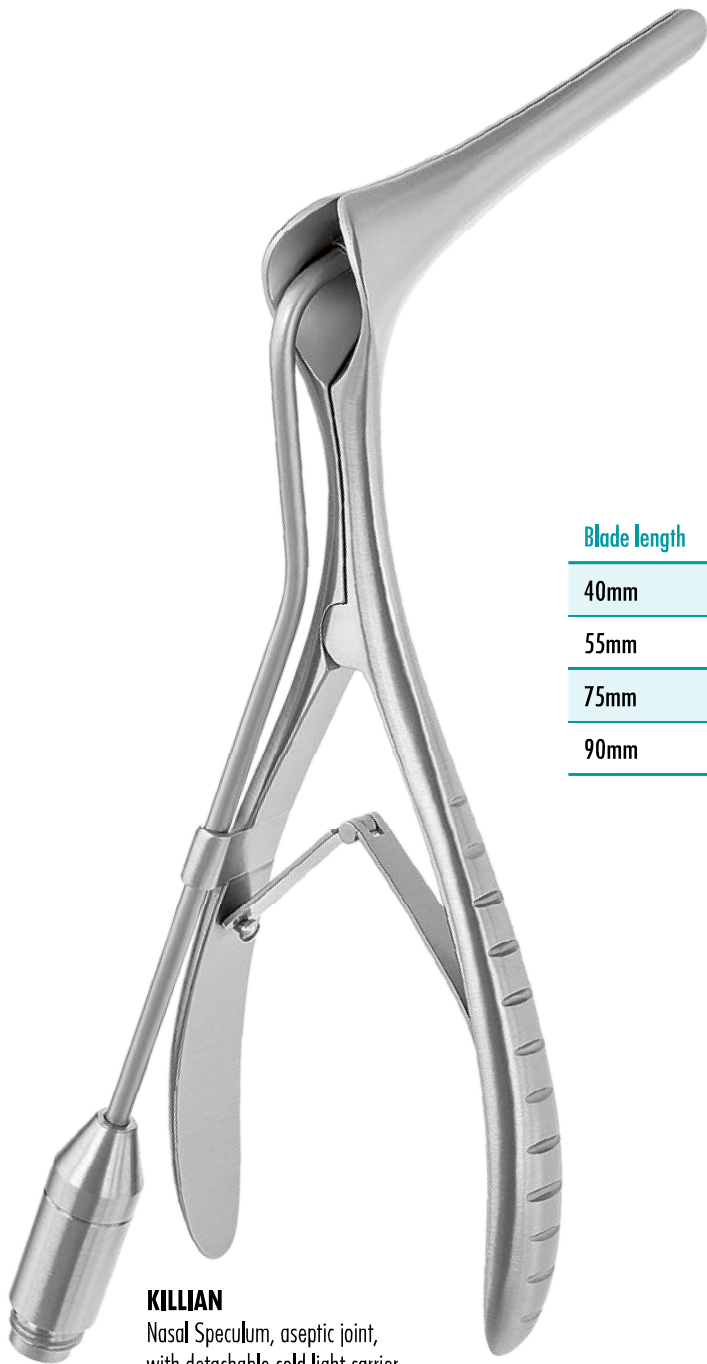

**KILLIAN**  
Nasal Speculum, aseptic joint,  
with detachable cold light carrier

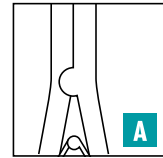

Blade length	Total length	A - Without locking screw
40mm	140mm	420-743-040
55mm	140mm	420-743-055
75mm	140mm	420-743-075
90mm	140mm	420-743-090

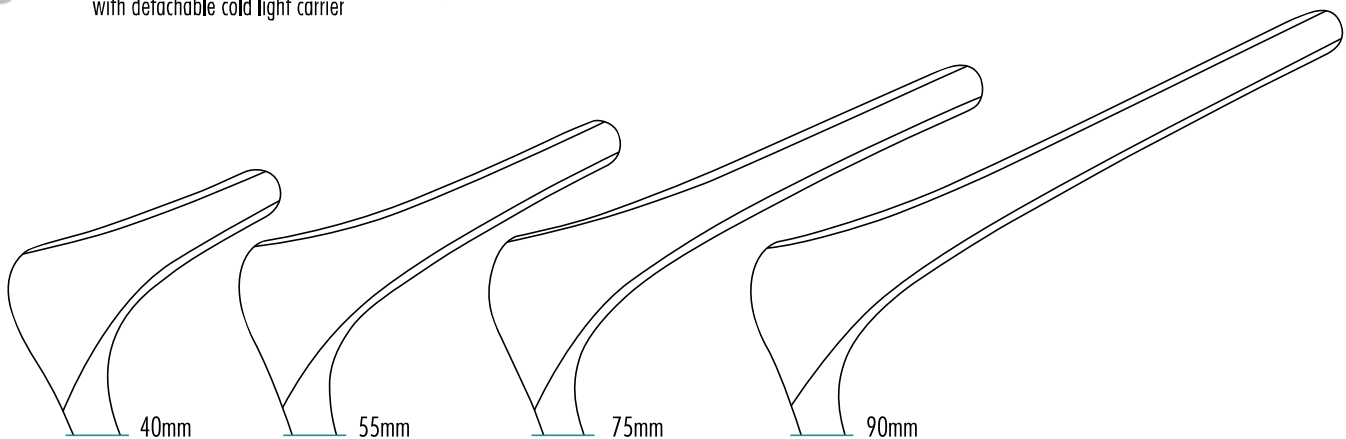



Nasal Specula Clamp for Flexible Arm

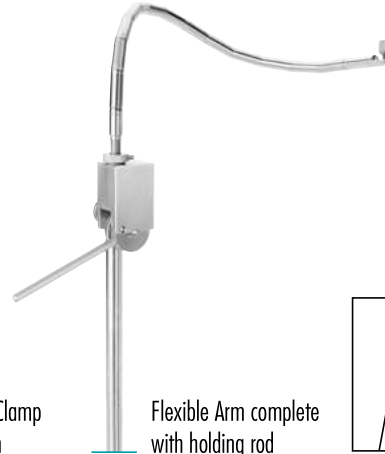

Flexible Arm complete with holding rod

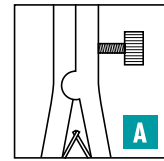

### COTTLE-MASING

Nasal Speculum, aseptic joint, for flexible arm

Blade length	Total length	A - With locking screw
35mm	140mm	420-140-035
50mm	140mm	420-140-050
75mm	140mm	420-140-075
90mm	140mm	420-140-090
100mm	140mm	420-140-100
Flexible Arm complete with holding rod		251-010-000
Nasal Specula Clamp for Flexible Arm		251-010-400

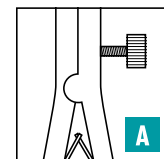
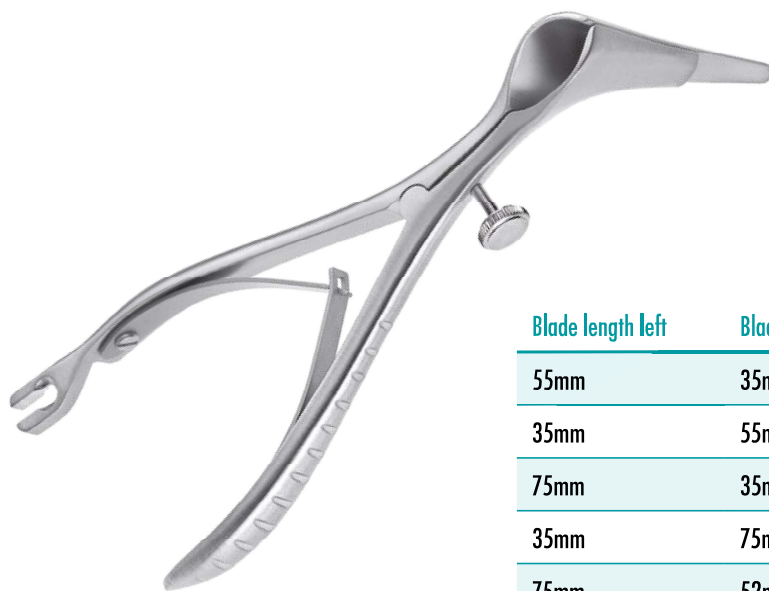

### SINUS

Nasal Speculum, aseptic joint, for flexible arm

Blade length left	Blade length right	Total length	A - With locking screw
55mm	35mm	140mm	420-150-101
35mm	55mm	140mm	420-150-102
75mm	35mm	140mm	420-150-105
35mm	75mm	140mm	420-150-106
75mm	52mm	140mm	420-150-107
52mm	75mm	140mm	420-150-108
Flexible Arm complete with holding rod			251-010-000
Nasal Specula Clamp for Flexible Arm			251-010-400

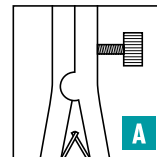
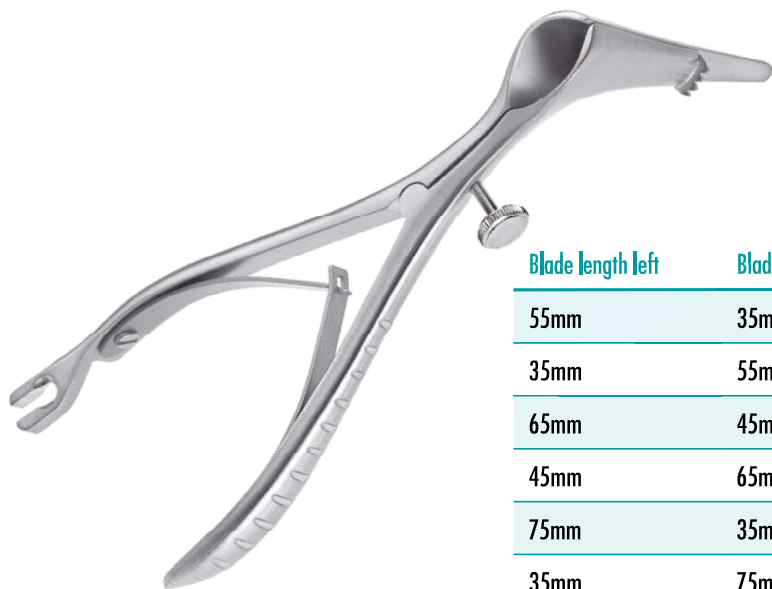

**Sinus**  
Nasal Speculum, with teeth,  
aseptic joint, for flexible arm

Blade length left	Blade length right	Total length	A - With locking screw
55mm	35mm	140mm	420-150-001
35mm	55mm	140mm	420-150-002
65mm	45mm	140mm	420-150-003
45mm	65mm	140mm	420-150-004
75mm	35mm	140mm	420-150-005
35mm	75mm	140mm	420-150-006
75mm	52mm	140mm	420-150-007
52mm	75mm	140mm	420-150-008
Flexible Arm complete with holding rod			251-010-000
Nasal Specula Clamp for Flexible Arm			251-010-400

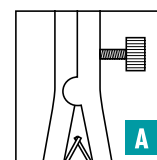
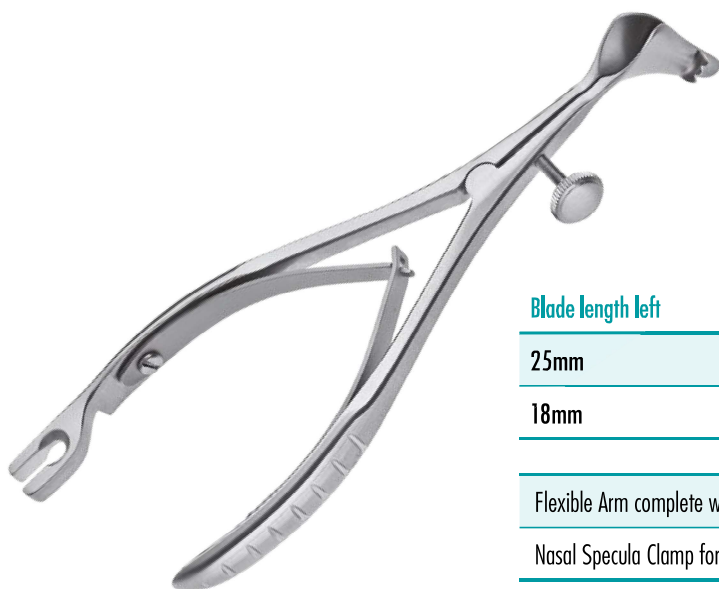

**Sinus**  
Nasal Speculum, for children,  
with teeth, aseptic joint,  
for flexible arm

Blade length left	Blade length right	Total length	A - With locking screw
25mm	18mm	140mm	420-150-301
18mm	25mm	140mm	420-150-302
Flexible Arm complete with holding rod			251-010-000
Nasal Specula Clamp for Flexible Arm			251-010-400

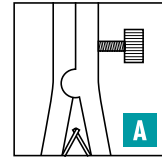
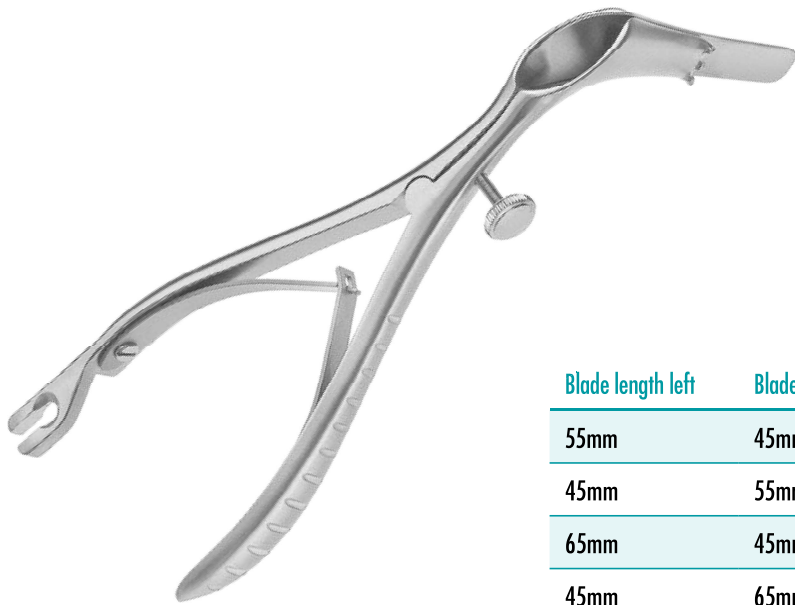

**Killian-Struycken Sinus**  
Nasal Speculum, with teeth,  
aseptic joint, for flexible arm

Blade length left	Blade length right	Total length	A - With locking screw
55mm	45mm	150mm	420-150-201
45mm	55mm	150mm	420-150-202
65mm	45mm	150mm	420-150-203
45mm	65mm	150mm	420-150-204
75mm	45mm	150mm	420-150-205
45mm	75mm	150mm	420-150-206
Flexible Arm complete with holding rod			251-010-000
Nasal Specula Clamp for Flexible Arm			251-010-400



Length of flexible arm 500mm

Flexible Arm complete with holding rod without Rotating Clamp

**Flexible Arm**

251-010-000

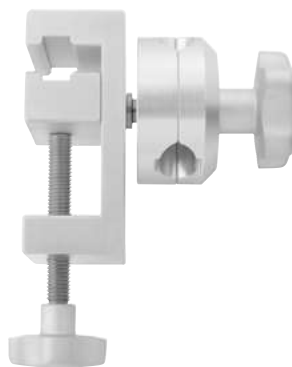

Rotating clamp for flexible tension arm attachable to operating table

**Rotating Clamp**

251-010-100



Nasal Specula Clamp for Flexible Arm

**Nasal Specula Clamp**

251-010-400

# NASAL INSTRUMENTS





### JOSEPH

Septum Raspatory, slightly curved, 170mm, 6<sup>2</sup>/<sub>3</sub>"

2mm	420-530-165
3mm	420-531-165
4mm	420-532-165



### JOSEPH

Periosteal Elevator, curved, 160mm, 6<sup>1</sup>/<sub>4</sub>"

4mm	420-585-160
-----	-------------



### OBWEGESER

Periosteal Elevator, curved, 175mm, 6<sup>5</sup>/<sub>8</sub>"

6mm	431-630-006
7mm	431-630-007
9mm	431-630-009
11mm	431-630-011



### WARD

Periosteal Elevator, curved rand blade, 170mm, 6<sup>3</sup>/<sub>4</sub>"

5.5mm	420-553-170
-------	-------------

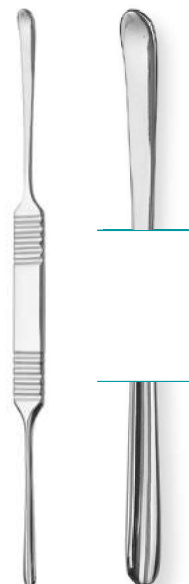

### READ

Elevator, double-ended, blunt

215mm, 8 <sup>1</sup> / <sub>2</sub> "	420-481-215
--	-------------

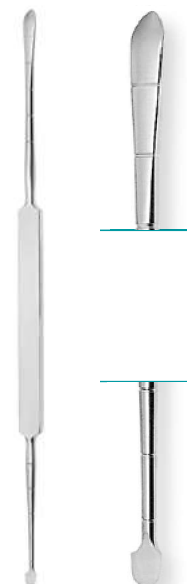

### COTTLE

Elevator, double-ended, graduated, sharp/blunt

210mm, 8 <sup>1</sup> / <sub>4</sub> "	420-550-230
--	-------------





**MASING**

Septum Elevator, double-ended, graduated, sharp/blunt

200mm, 8"

420-551-200

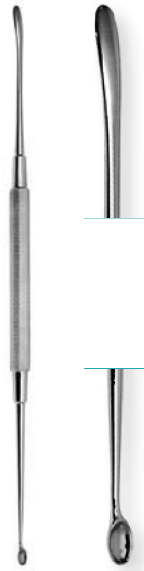

**CARTER**

Septum Elevator, double-ended

210mm, 8<sup>1</sup>/<sub>4</sub>"

420-551-210



**OBWEGESER-FREER**

Septum Elevator

200mm, 8"

420-532-200



**GOLDMANN**

Septum elevator, round, for straightening the nose

200mm, 8"

420-189-210



**BOIES**

Elevator for Septum Repositioning

170mm, 6<sup>3</sup>/<sub>4</sub>"

420-557-170



**BOIES**

Nasal Fracture Elevator, 9mm

195mm, 7<sup>3</sup>/<sub>4</sub>"

420-555-195

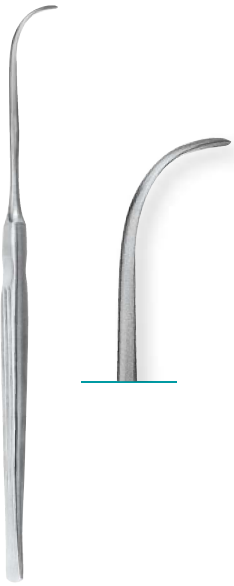

### LAMONT

Raspatory, strongly curved, sharp, 170mm, 6<sup>2</sup>/<sub>3</sub>"

3mm	430-531-170
-----	-------------

6mm	430-532-170
-----	-------------



### HOWARTH

Elevator, double-ended, sharp/blunt

215mm, 8 <sup>1</sup> / <sub>2</sub> "	420-552-215
--	-------------



### JOSEPH

Nasal Saw, 170mm, 6<sup>3</sup>/<sub>4</sub>"

Straight	230-202-000
----------	-------------

Bayonet, curved right	230-202-001
-----------------------	-------------

Bayonet, curved left	230-202-002
----------------------	-------------



### JOSEPH

Nasal Saw, 170mm, 6<sup>3</sup>/<sub>4</sub>"

Right-angled	230-210-170
--------------	-------------

Left-angled	230-211-170
-------------	-------------

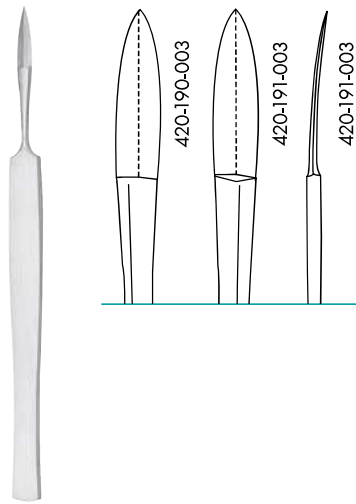

### JOSEPH

Nasal Knife, double-edge, sharp, 150mm, 6"

Straight	420-190-003
----------	-------------

Curved	420-191-003
--------	-------------

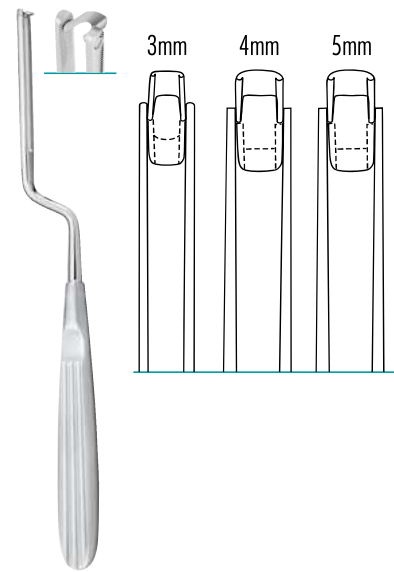

### BALLENGER

Swivel Knife, bayonet shaped, 210mm, 8<sup>1</sup>/<sub>4</sub>"

3mm	420-392-003
-----	-------------

4mm	420-392-004
-----	-------------

5mm	420-392-005
-----	-------------



### COTTLE-WALSHAM

Septum Straightening Forceps, aseptic lock, 230mm, 9"

Straight 420-450-230

Left 420-451-230

Right 420-452-230



### ASH

Septum Straightening Forceps, 8<sup>3</sup>/<sub>4</sub>"

220mm, 8<sup>3</sup>/<sub>4</sub>" 420-455-230



### GUNTER

TC Lower Lateral Morselizer

180mm, 7" 420-220-212

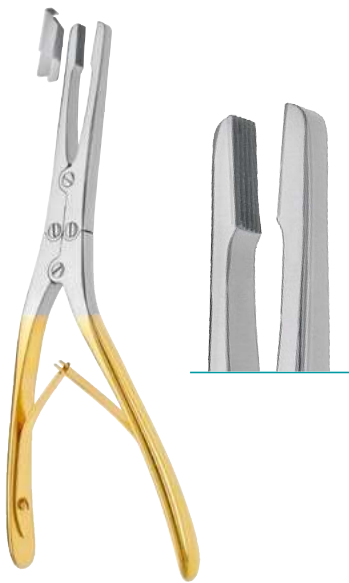

### GORNEY

Septal Morselizer, double action, angled, incl. guard

200mm, 8" 420-220-220

Guard, only

1 piece 420-221-200



### RÖTTGEN-RUSKIN

Bone Rongeur, curved, 5mm, double action

240mm, 9<sup>1</sup>/<sub>2</sub>" 210-792-230



### BEYER

Bone Rongeur, curved, double action, 180mm, 7"

4mm 210-790-180

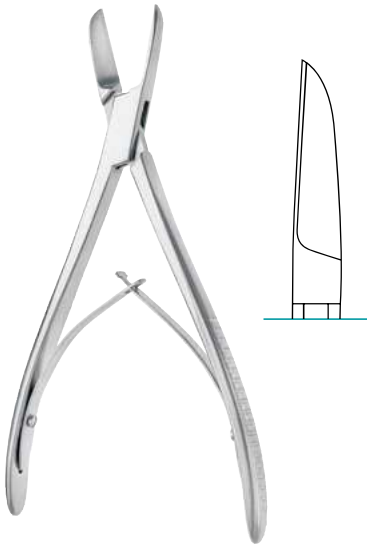

**COTTLE-KAZANJIAN**  
Bone Cutting Forceps, for removal of nasal hump

180mm, 7"

210-845-185

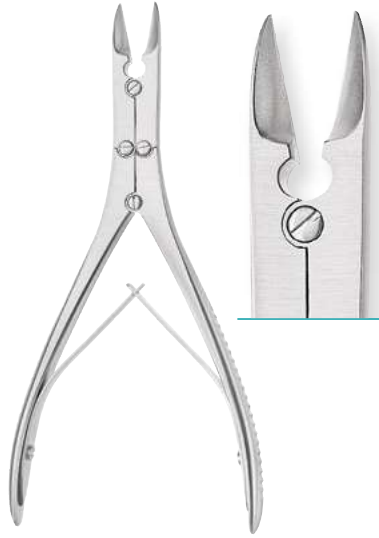

**RUSKIN-LISTON**  
Bone Cutting Forceps, straight

170mm, 6<sup>2</sup>/<sub>3</sub>"

210-844-170



**JANSEN-MIDDLETON**  
Nasal Forceps, through cutting, 4x14mm, 8<sup>1</sup>/<sub>4</sub>"

210mm, 8<sup>1</sup>/<sub>4</sub>"

252-031-190



**JANSEN-MIDDLETON**  
Nasal Forceps, 4x11mm, Spoon Jaw

170mm, 6<sup>3</sup>/<sub>4</sub>"

252-032-190



**LANGENBECK**  
Bone Holding Forceps

210mm, 8<sup>1</sup>/<sub>2</sub>"

210-722-210



**DINGMANN**  
Bone Holding Forceps

190mm, 7<sup>1</sup>/<sub>4</sub>"

210-626-190



### COTTLE

Bone Crusher, complete with clamp

28mm

420-365-000

*For preparation of bone graft material.*



### RZ

Cartilage Crusher

60 x 30mm

420-364-000



Plastic Plate, autoclavable, 85x55mm, 3x2"

85x55mm, 3x2"

420-367-000

*For preparation of bone grafts.*



### TOLSDORF

Bone Crusher

40mm, 7"

420-366-000

Inner Diameter



Without fibre-optic

**MALINIAC**  
Nasal Retractor, 9x45mm, 100mm, 4"

Without fibre-optic 420-652-100

With fibre-optic (light carrier) 420-752-100



**CONVERSE**  
Nasal Retractor, 11x44mm

110mm, 4<sup>1</sup>/<sub>3</sub>" 420-235-110



**CONVERSE**  
Nasal Retractor, fibre-optic light carrier, 11x44mm

110mm, 4<sup>1</sup>/<sub>3</sub>" 420-236-110



**CONVERSE**  
Nasal Retractor, 90mm, 3<sup>1</sup>/<sub>2</sub>"

10x20mm 420-237-095

12x30mm 420-238-095

12x40mm 420-239-090

12x50mm 420-239-095



**CONVERSE**  
Nasal Retractor, fibre-optic light carrier, 90mm, 3<sup>1</sup>/<sub>2</sub>"

10x20mm 420-237-195

12x30mm 420-238-195

12x40mm 420-239-190

12x50mm 420-239-195



**DEVINE-MILLARD-AUFRICHT**  
Nasal Retractor, fibre-optic light carrier, 10x45mm

180mm, 7" 420-257-160



**DEVINE-MILLARD-AUFRICHT**

Nasal Retractor, 10x45mm

180mm, 7"

420-057-160



**AUFRICHT**

Nasal Retractor, 10x45mm

160mm, 6<sup>1</sup>/<sub>4</sub>"

420-250-160



**AUFRICHT**

Nasal Retractor, fibre-optic light carrier, 120°, 10x45mm

180mm, 7"

420-255-160





# DERMATOLOGY INSTRUMENTS



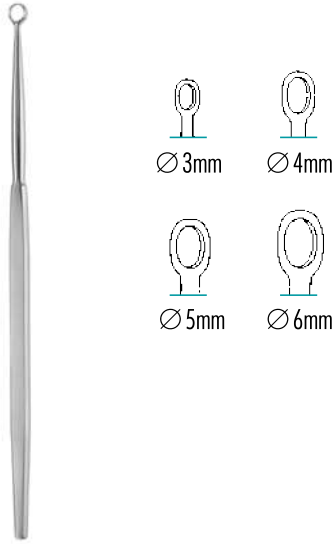

### FOX

Lupus curette, round, 140mm, 5<sup>1</sup>/<sub>2</sub>"

Ø 3mm	230-151-140
Ø 4mm	230-152-140
Ø 5mm	230-153-140
Ø 6mm	230-154-140

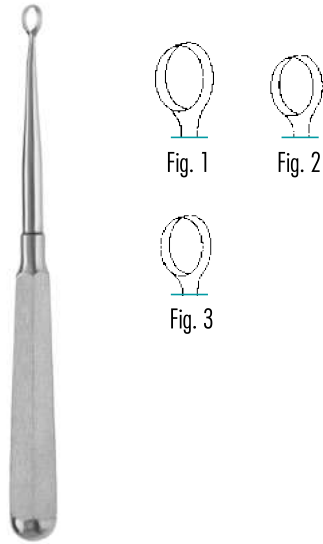

### PIFFARD

Lupus curette, 140mm, 5<sup>1</sup>/<sub>2</sub>"

Fig. 1	230-155-001
Fig. 2	230-155-002
Fig. 3	230-155-003

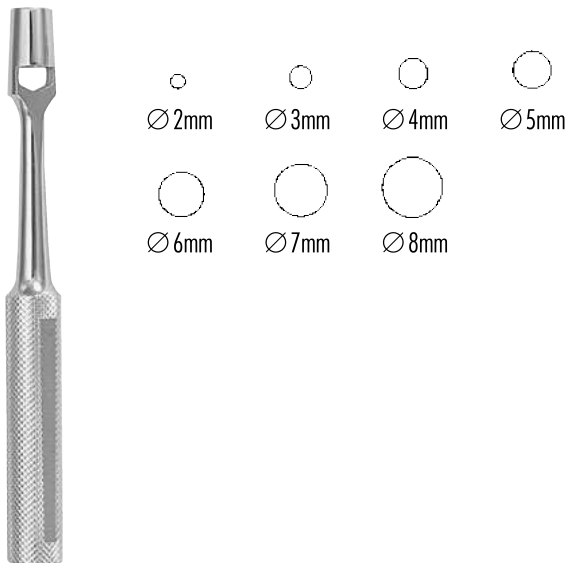

### KEYES

Dermal punch, 120mm, 4<sup>3</sup>/<sub>4</sub>"

Ø 2mm	230-160-002	Ø 6mm	230-160-006
Ø 3mm	230-160-003	Ø 7mm	230-160-007
Ø 4mm	230-160-004	Ø 8mm	230-160-008
Ø 5mm	230-160-005		

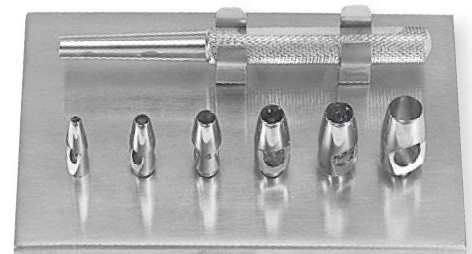
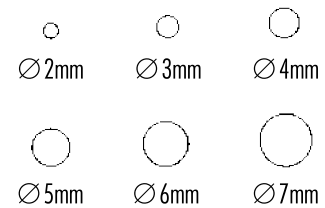

### KEYES

Dermal punch set, 1 handle,

Full set	230-160-000
----------	-------------



**UNNA**  
Comedo Extractor, double-ended, oval cup

140mm, 5<sup>3</sup>/<sub>4</sub>"

230-230-140



**UNNA**  
Comedo Extractor, double-ended, round cup

140mm, 5<sup>3</sup>/<sub>4</sub>"

230-232-140



**SAALFELD**  
Comedo Extractor, double-ended

100mm, 4"

230-239-100



**SAALFELD**  
Comedo Extractor, double-ended

140mm, 5<sup>3</sup>/<sub>4</sub>"

230-236-140



**SCHAMBERG**  
Comedo Extractor, double-ended

100mm, 4"

230-238-100

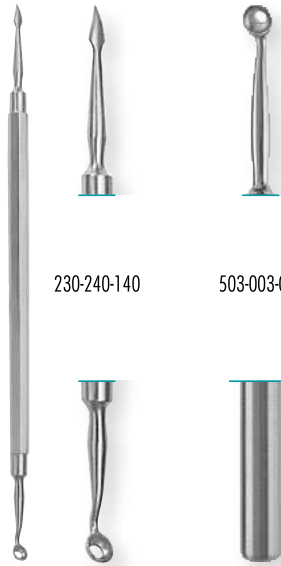

**WALTON**  
Comedone Extractor, double-ended

140mm, 5<sup>3</sup>/<sub>4</sub>"

230-240-140

160mm, 6<sup>1</sup>/<sub>4</sub>"  
(single ended)

503-003-000

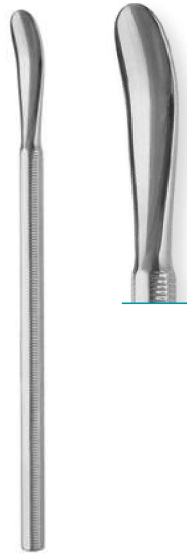

**FROST**  
Elevator

130mm, 5"

503-011-000

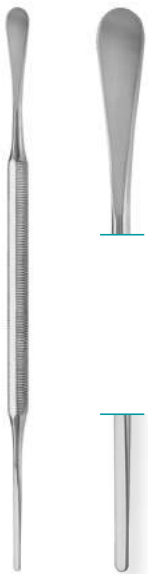

**FROST**  
Spatula Packer, double-ended

135mm, 5<sup>1</sup>/<sub>3</sub>"

503-013-000



Scalpel Handle, 130mm, 5"

No. 3	110-110-003
-------	-------------

No. 4	110-140-004
-------	-------------



**BARRON**  
Scalpel Handle

130mm, 5 <sup>1</sup> / <sub>8</sub> "	110-140-000
--	-------------



**CORWIN**  
Scalpel Handle

150mm, 6"	110-148-000
-----------	-------------



Nail Nipper

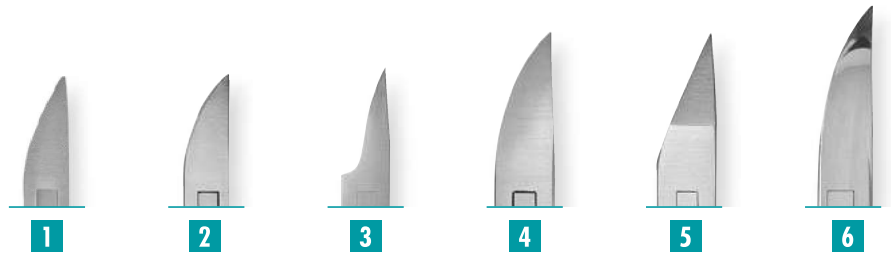

<b>1</b>	100mm, 4"	510-224-140	Straight jaws, double spring
<b>2</b>	110mm, 4 1/2"	510-225-140	Straight jaws, double spring
<b>3</b>	110mm, 4 1/2"	510-225-142	Delicate straight jaws, double spring
<b>4</b>	130mm, 5"	510-226-140	Straight jaws, double spring
<b>5</b>	130mm, 5"	510-226-142	Straight jaws, extra narrow, double spring
<b>6</b>	150mm, 6"	510-227-140	Straight jaws, double spring

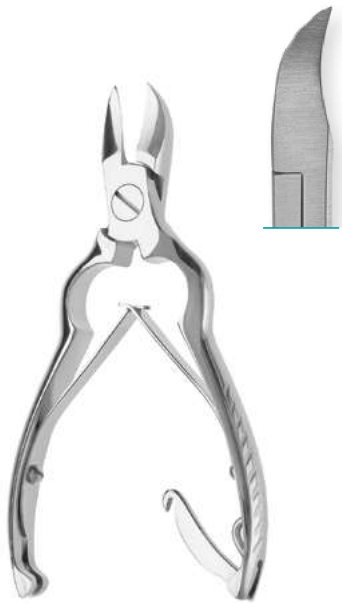

Nail nipper, concave jaws

115mm, 4 1/2" 510-205-115



Nail nipper

130mm, 5" 510-347-130



Nail nipper concave, spring handle, with lock

150mm, 6" 510-332-150



Nail Nipper, double spring, 140mm, 5 1/2"

1	510-210-140
2	510-215-140



Nail Nipper, angled concave jaws, double spring

140mm, 5 1/2"	510-215-140
---------------	-------------



Mycotic Nail Nipper, straight, heavy duty jaws double action

160mm, 6 1/4"	510-337-160
---------------	-------------



Mycotic Nail Nipper, concave, heavy duty jaws, double action

150mm, 6"	510-338-150
-----------	-------------



Nail Nipper, concave, single spring

115mm, 4 1/2"	510-200-115
---------------	-------------



Cuticle and tissue nipper, convex jaws

110mm, 4 1/2"      510-250-110

130mm, 5"      510-251-130

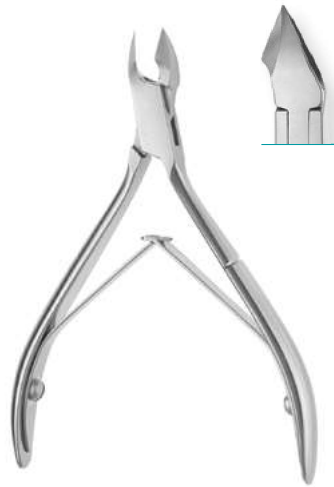

Cuticle and tissue nipper, convex jaws

100mm, 4"      510-245-100



Cuticle and tissue nipper, straight jaws, ring handle

100mm, 4"      510-220-100



### **RADOLF**

Nail extraction forceps, narrow jaws

140mm, 5 1/2"      510-463-140



Nail extraction forceps

135mm, 5 1/3"      510-462-130



Nail extraction forceps, duck shaped jaws

140mm, 5 1/2"      510-464-140





Nail splitting forceps

135mm, 5<sup>3</sup>/<sub>8</sub>"

510-334-140



Finger ring saw, with replaceable circular blade

170mm, 6<sup>2</sup>/<sub>3</sub>"

210-975-170



Nail Scissors, curved

90mm, 3<sup>1</sup>/<sub>2</sub>"

510-425-090

Spare circular blade

1 piece

210-976-000

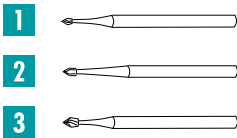

Finger drill only, 1 piece

1 510-460-001

2 510-460-002

3 510-460-003

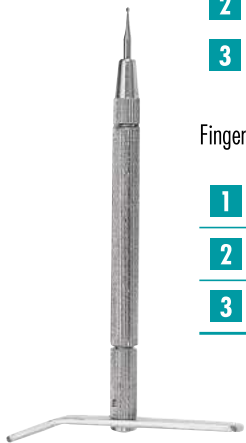

Finger nail drill complete with 3 drill points

170mm, 6<sup>2</sup>/<sub>3</sub>"

510-460-000

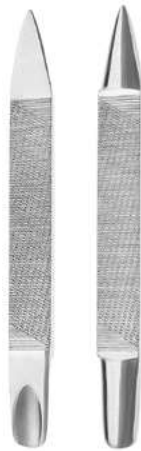

Nail rasp

100mm, 4"

510-050-100

120mm, 4<sup>3</sup>/<sub>4</sub>"

510-050-120



**FREER**  
Mucosa Knife

150mm, 6"

420-195-150



**JOSEPH**  
Button-end Knife, straight

150mm, 5<sup>1</sup>/<sub>2</sub>"

420-205-160



**DINGMAN**  
Otopraders, set of left and right pattern

160mm, 6<sup>1</sup>/<sub>4</sub>"

410-033-100

*For cutting inner ear cartilage during otoplasty.*



**STENSTRØM**  
Ear Scraper, 160mm, 6<sup>1</sup>/<sub>4</sub>"

Curved left

410-033-130

Curved right

410-033-131



**STENSTRØM**  
Ear Rasp, 160mm, 6<sup>1</sup>/<sub>4</sub>"

Curved left

410-033-132

Curved right

410-033-133



### GOULIAN

Hand Dermatome, 3 templates (0.2/0.25/0.3mm)

190mm, 7<sup>1</sup>/<sub>2</sub>"

110-096-180

Spare blades, non-sterile

5 pieces

110-096-185



### BRAITHWAITE (MODIF. HUMBY)

Hand Dermatome, complete, 305mm, 12"

Left handed

110-097-305

Right handed

110-098-305

Spare blades, non-sterile

10 pieces

110-098-399



### SCHINK

Dermatome, exchangeable blade, 2 straightening blades

305mm, 12"

110-090-000

Spare blade

1 piece

110-090-001



### SILVER

Skin Graft Knife

190mm, 7<sup>1</sup>/<sub>2</sub>"

110-096-019

Spare blade

1 piece

110-096-119



Skin Graft Board  
bevelled edge

200x100mm

110-090-150



### GABARRO

Skin Graft Measure

110-090-100



Diamond Knife, titanium handle, blade #11

260-800-011



Diamond Knife, titanium handle, blade #15

260-800-015

# CLEFT PALATE INSTRUMENTS





**CRONIN**  
Cleft Palate Elevator, 180mm, 7"

Large	430-100-600
Medium	430-100-601
Small	430-100-602



**BLAIR**  
Cleft Palate Elevator, right-angled, blunt

180mm, 7"	430-105-002
-----------	-------------



**BLAIR**  
Cleft Palate Elevator, flat, blunt

200mm, 8"	430-105-003
-----------	-------------



**BLAIR**  
Cleft Palate Elevator, L-Shaped, blunt, rounded

180mm, 7"	430-105-001
-----------	-------------

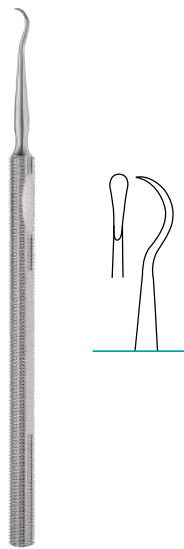

**JABOMA**  
Cleft Palate Periosteal Elevator

170mm, 6 <sup>3</sup> / <sub>4</sub> "	431-200-100
--	-------------



**CRONIN**  
Cleft Palate Knife, 180mm, 7"

Triangular	430-100-603
Rectangular	430-100-604

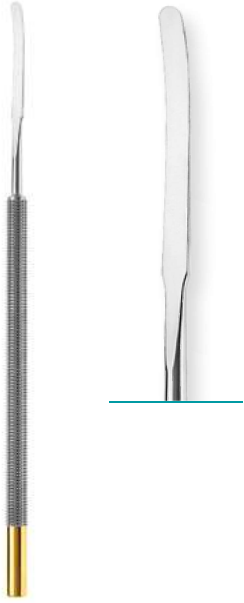

**SALYER**  
Cleft Palate Elevator, 180mm, 7"

Slightly curved	431-200-021
Curved	431-200-023

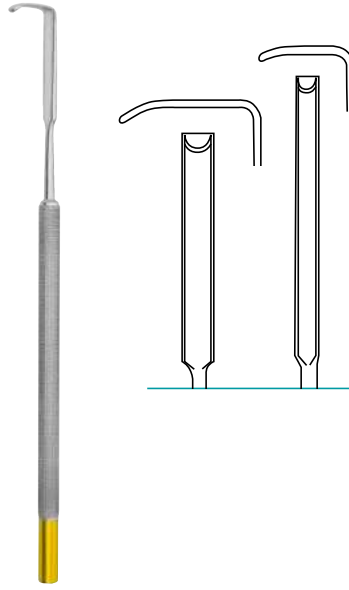

**SALYER**  
Cleft Palate Hooklet, 180mm, 7"

Short blade	431-200-001
Long blade	431-200-003

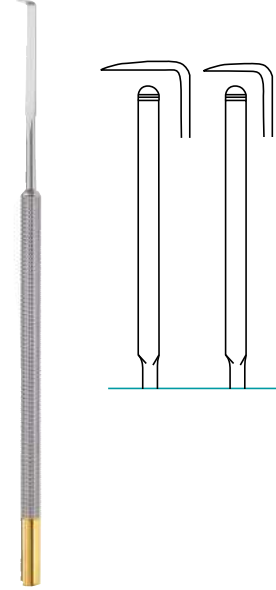

**SALYER**  
Cleft Palate Dissector, 180mm, 7"

Short blade	431-200-011
Long blade	431-200-013

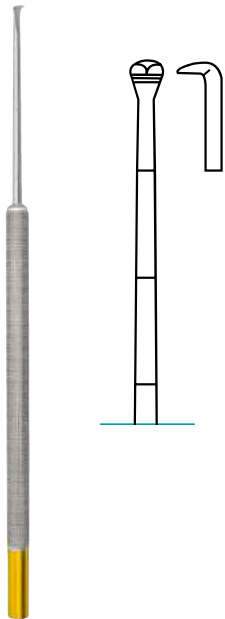

**SALYER**  
Cleft Palate Elevator, triangular blade, 180mm, 7"

Triangular blade	431-200-027
------------------	-------------



Cleft Palate Raspatory, 140mm, 5<sup>1</sup>/<sub>2</sub>"

Curv. upwards	420-580-145
Curv. downwards	420-583-145

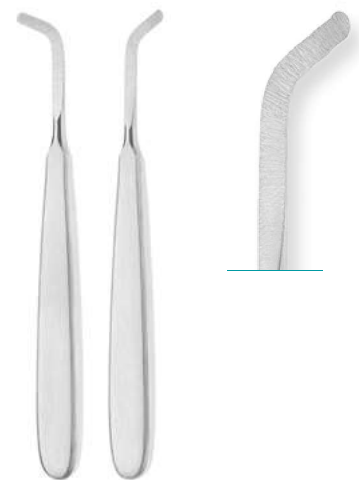

Cleft Palate Raspatory, 140mm, 5<sup>1</sup>/<sub>2</sub>"

Curv. upwards, right	420-581-140
Curv. upwards, left	420-582-140



Logan Bow, with teeth

<u>28mm / 1<sup>1</sup>/<sub>8</sub>" wide</u>	<u>420-985-013</u>
<u>32mm / 1<sup>1</sup>/<sub>4</sub>" wide</u>	<u>420-985-014</u>
<u>35mm / 1<sup>1</sup>/<sub>3</sub>" wide</u>	<u>420-985-015</u>



# SHAPERS

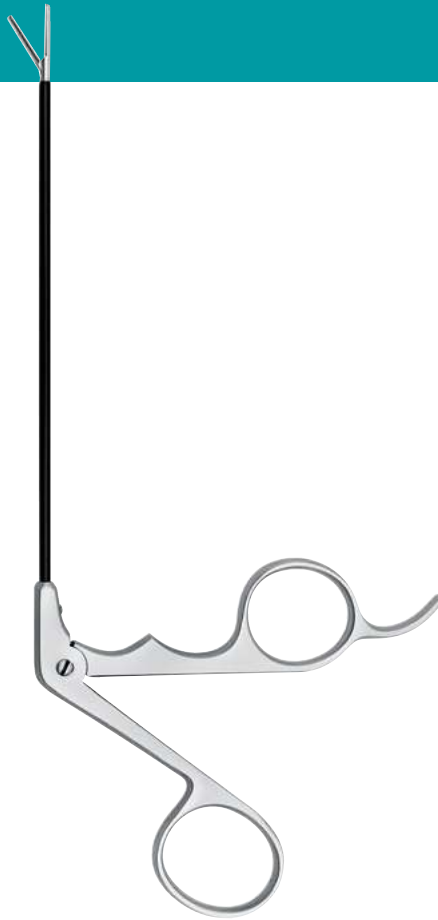



SHAPER Sheath with one rotating stopcock, with angled spatula tip for the best view during tissue dissection

Ø 4 mm	260-501-180
Ø 5 mm	260-501-185



SHAPER Sheath for plastic telescopes with one rotating stopcock, with large angled up spatula tip for the best view during tissue dissection

Ø 4 mm	260-502-180
Ø 5 mm	260-502-185



SHAPER Sheath for plastic Endoscopy, with one rotating stopcock, with a flat spatula tip

Ø 4 mm	251-140-175
Ø 5 mm	251-150-175



SHAPER Sheath for plastic telescopes, with two rotating stopcocks, with a flat spatula tip

Ø 4 mm	251-340-175
Ø 5 mm	251-345-175



SHAPER Telescope for Plastic Endoscopy, 30°, Wide Angle, autoclavable, for use with all SHAPER Sheaths

Ø 4 mm	260-104-030
--------	-------------