

NEURO & SPINAL SURGERY

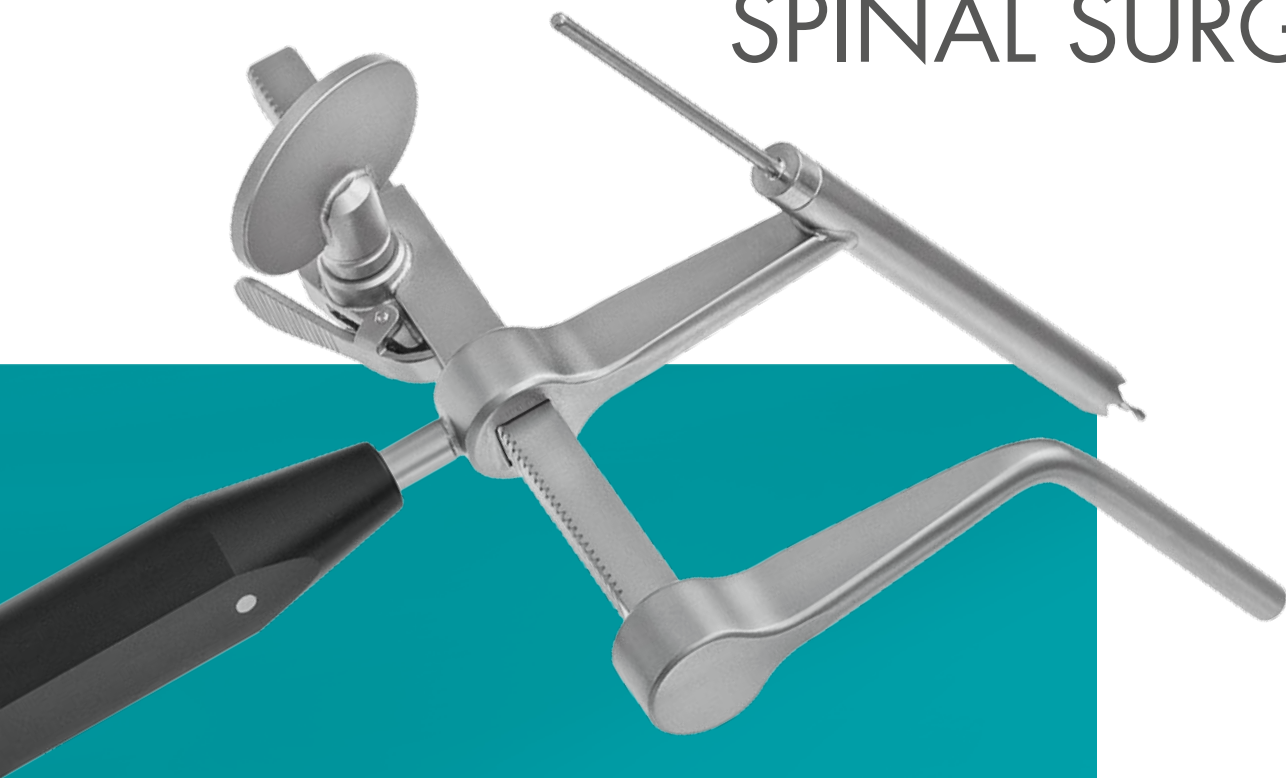

Kerrison Punches
Rongeurs
Micro Instruments
Hooks
Elevators / Dissectors
Raspatories / Knives
Micro Dissectors
Neuro Surgery
Periosteal Elevators

Retractors
Curettes
Chisels
Mallets
Spinal Retractors
Drills
Scalp Clips
Suction Tubes
Percussion Mallets

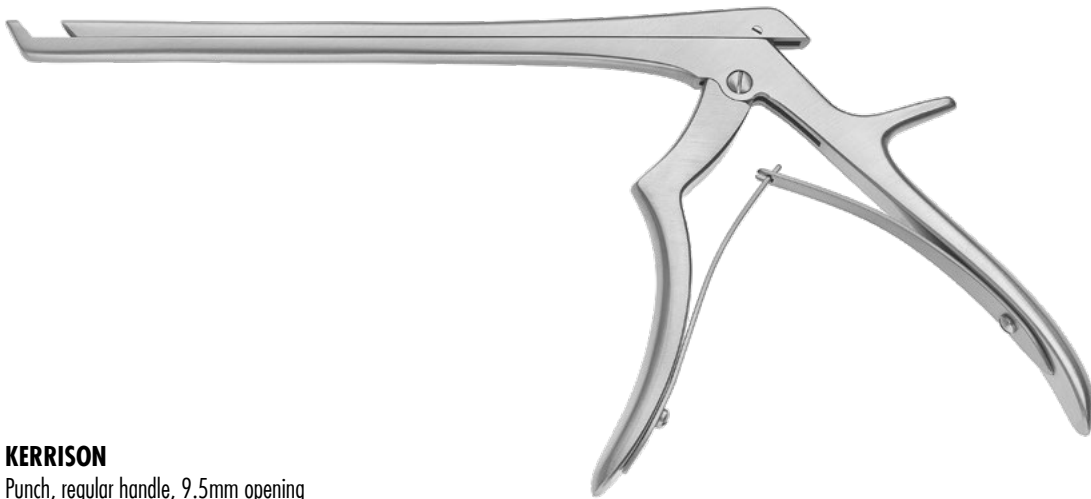

KERRISON

Punch, regular handle, 9.5mm opening



40° upwards cutting
180mm, 7"

1mm	250-400-181
2mm	250-400-182
3mm	250-400-183
4mm	250-400-184
5mm	250-400-185
6mm	250-400-186

200mm, 8"

1mm	250-400-201
2mm	250-400-202
3mm	250-400-203
4mm	250-400-204
5mm	250-400-205
6mm	250-400-206

230mm, 9"

1mm	250-400-231
2mm	250-400-232
3mm	250-400-233
4mm	250-400-234
5mm	250-400-235
6mm	250-400-236



90° upwards cutting
180mm, 7"

1mm	250-410-181
2mm	250-410-182
3mm	250-410-183
4mm	250-410-184
5mm	250-410-185
6mm	250-410-186

200mm, 8"

1mm	250-410-201
2mm	250-410-202
3mm	250-410-203
4mm	250-410-204
5mm	250-410-205
6mm	250-410-206

230mm, 9"

1mm	250-410-231
2mm	250-410-232
3mm	250-410-233
4mm	250-410-234
5mm	250-410-235
6mm	250-410-236



40° downwards cutting
180mm, 7"

1mm	250-420-181
2mm	250-420-182
3mm	250-420-183
4mm	250-420-184
5mm	250-420-185
6mm	250-420-186

200mm, 8"

1mm	250-420-201
2mm	250-420-202
3mm	250-420-203
4mm	250-420-204
5mm	250-420-205
6mm	250-420-206

230mm, 9"

1mm	250-420-231
2mm	250-420-232
3mm	250-420-233
4mm	250-420-234
5mm	250-420-235
6mm	250-420-236



90° downwards cutting
180mm, 7"

1mm	250-430-181
2mm	250-430-182
3mm	250-430-183
4mm	250-430-184
5mm	250-430-185
6mm	250-430-186

200mm, 8"

1mm	250-430-201
2mm	250-430-202
3mm	250-430-203
4mm	250-430-204
5mm	250-430-205
6mm	250-430-206

230mm, 9"

1mm	250-430-231
2mm	250-430-232
3mm	250-430-233
4mm	250-430-234
5mm	250-430-235
6mm	250-430-236

All Kerrison instruments are available with CERACUT® coating. Code number + CC (e.g. 250-400-181CC)



KERRISON

Punch, large handle,
15.5mm opening

40° upwards cutting
180mm, 7"

1mm	250-450-181
2mm	250-450-182
3mm	250-450-183
4mm	250-450-184
5mm	250-450-185
6mm	250-450-186

200mm, 8"

1mm	250-450-201
2mm	250-450-202
3mm	250-450-203
4mm	250-450-204
5mm	250-450-205
6mm	250-450-206

230mm, 9"

1mm	250-450-231
2mm	250-450-232
3mm	250-450-233
4mm	250-450-234
5mm	250-450-235
6mm	250-450-236

90° upwards cutting
180mm, 7"

1mm	250-460-181
2mm	250-460-182
3mm	250-460-183
4mm	250-460-184
5mm	250-460-185
6mm	250-460-186

200mm, 8"

1mm	250-460-201
2mm	250-460-202
3mm	250-460-203
4mm	250-460-204
5mm	250-460-205
6mm	250-460-206

230mm, 9"

1mm	250-460-231
2mm	250-460-232
3mm	250-460-233
4mm	250-460-234
5mm	250-460-235
6mm	250-460-236

40° downwards cutting
180mm, 7"

1mm	250-470-181
2mm	250-470-182
3mm	250-470-183
4mm	250-470-184
5mm	250-470-185
6mm	250-470-186

200mm, 8"

1mm	250-470-201
2mm	250-470-202
3mm	250-470-203
4mm	250-470-204
5mm	250-470-205
6mm	250-470-206

230mm, 9"

1mm	250-470-231
2mm	250-470-232
3mm	250-470-233
4mm	250-470-234
5mm	250-470-235
6mm	250-470-236

90° downwards cutting
180mm, 7"

1mm	250-480-181
2mm	250-480-182
3mm	250-480-183
4mm	250-480-184
5mm	250-480-185
6mm	250-480-186

200mm, 8"

1mm	250-480-201
2mm	250-480-202
3mm	250-480-203
4mm	250-480-204
5mm	250-480-205
6mm	250-480-206

230mm, 9"

1mm	250-480-231
2mm	250-480-232
3mm	250-480-233
4mm	250-480-234
5mm	250-480-235
6mm	250-480-236

All Kerrison instruments are available with CERACUT® coating. Code number + CC (e.g. 250-400-181CC)

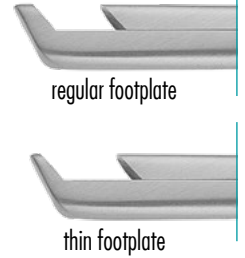
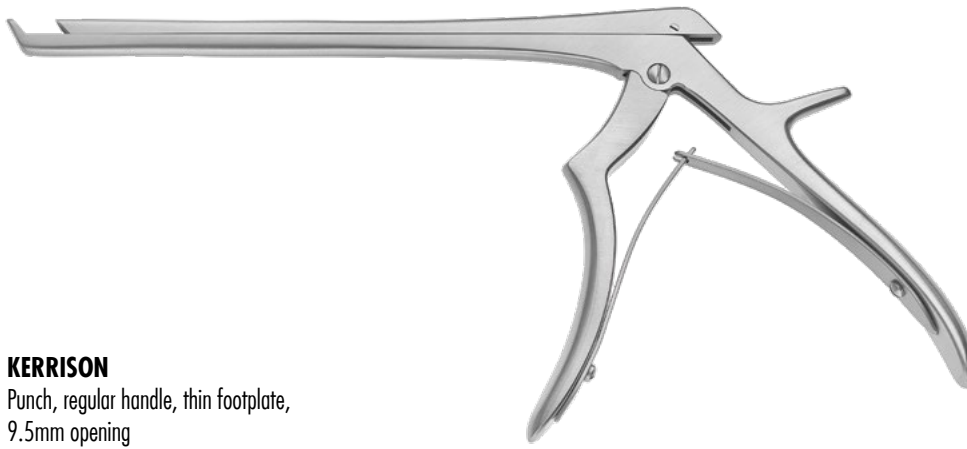

KERRISON

Punch, regular handle, thin footplate,
9.5mm opening

40° upwards cutting 180mm, 7"		90° upwards cutting 180mm, 7"		40° downwards cutting 180mm, 7"		90° downwards cutting 180mm, 7"	
1mm	250-401-181	1mm	250-411-181	1mm	250-421-181	1mm	250-431-181
2mm	250-401-182	2mm	250-411-182	2mm	250-421-182	2mm	250-431-182
3mm	250-401-183	3mm	250-411-183	3mm	250-421-183	3mm	250-431-183
4mm	250-401-184	4mm	250-411-184	4mm	250-421-184	4mm	250-431-184
5mm	250-401-185	5mm	250-411-185	5mm	250-421-185	5mm	250-431-185
200mm, 8"		200mm, 8"		200mm, 8"		200mm, 8"	
1mm	250-401-201	1mm	250-411-201	1mm	250-421-201	1mm	250-431-201
2mm	250-401-202	2mm	250-411-202	2mm	250-421-202	2mm	250-431-202
3mm	250-401-203	3mm	250-411-203	3mm	250-421-203	3mm	250-431-203
4mm	250-401-204	4mm	250-411-204	4mm	250-421-204	4mm	250-431-204
5mm	250-401-205	5mm	250-411-205	5mm	250-421-205	5mm	250-431-205
230mm, 9"		230mm, 9"		230mm, 9"		230mm, 9"	
1mm	250-401-231	1mm	250-411-231	1mm	250-421-231	1mm	250-431-231
2mm	250-401-232	2mm	250-411-231	2mm	250-421-231	2mm	250-431-231
3mm	250-401-233	3mm	250-411-231	3mm	250-421-231	3mm	250-431-231
4mm	250-401-234	4mm	250-411-231	4mm	250-421-231	4mm	250-431-231
5mm	250-401-235	5mm	250-411-231	5mm	250-421-231	5mm	250-431-231

All Kerrison instruments are available with CERACUT® coating. Code number + CC (e.g. 250-400-181CC)



KERRISON

Punch, regular handle, superflat footplate



180mm, 7"
40° upwards cutting

1mm	250-400-181SF
1.5mm	250-400-189SF
2mm	250-400-182SF
3mm	250-400-183SF
4mm	250-400-184SF
5mm	250-400-185SF
6mm	250-400-186SF

180mm, 7"
40° upwards cutting,
standard ejector

2mm	250-400-182ESF
3mm	250-400-183ESF
4mm	250-400-184ESF
5mm	250-400-185ESF
6mm	250-400-186ESF

180mm, 7"
40° upwards cutting, CERA-CUT®

1mm	250-400-181SFCC
2mm	250-400-182SFCC
3mm	250-400-183SFCC
4mm	250-400-184SFCC
5mm	250-400-185SFCC
6mm	250-400-186SFCC

200mm, 8"

1mm	250-400-201SF
1.5mm	250-400-209SF
2mm	250-400-202SF
3mm	250-400-203SF
4mm	250-400-204SF
5mm	250-400-205SF
6mm	250-400-206SF

200mm, 8"

2mm	250-400-202ESF
3mm	250-400-203ESF
4mm	250-400-204ESF
5mm	250-400-205ESF
6mm	250-400-206ESF

200mm, 8"

1mm	250-400-201SFCC
2mm	250-400-202SFCC
3mm	250-400-203SFCC
4mm	250-400-204SFCC
5mm	250-400-205SFCC
6mm	250-400-206SFCC

230mm, 9"

1mm	250-400-231SF
1.5mm	250-400-239SF
2mm	250-400-232SF
3mm	250-400-233SF
4mm	250-400-234SF
5mm	250-400-235SF
6mm	250-400-236SF

230mm, 9"

2mm	250-400-232ESF
3mm	250-400-233ESF
4mm	250-400-234ESF
5mm	250-400-235ESF
6mm	250-400-236ESF

230mm, 9"

1mm	250-400-231SFCC
2mm	250-400-232SFCC
3mm	250-400-233SFCC
4mm	250-400-234SFCC
5mm	250-400-235SFCC
6mm	250-400-236SFCC

All Kerrison instruments are available with CERACUT® coating. Code number + CC (e.g. 250-400-181CC)



KERRISON

Punch, regular handle, superflat footplate



180mm, 7"
90° upwards cutting

1mm	250-411-181SF
2mm	250-411-182SF
3mm	250-411-183SF
4mm	250-411-184SF
5mm	250-411-185SF
6mm	250-411-186SF



180mm, 7"
90° upwards cutting,
standard ejector

2mm	250-411-182ESF
3mm	250-411-183ESF
4mm	250-411-184ESF
5mm	250-411-185ESF
6mm	250-411-186ESF



180mm, 7"
90° upwards cutting, CERA-CUT®

1mm	250-411-181SFCC
2mm	250-411-182SFCC
3mm	250-411-183SFCC
4mm	250-411-184SFCC
5mm	250-411-185SFCC
6mm	250-411-186SFCC

200mm, 8"

1mm	250-411-201SF
2mm	250-411-202SF
3mm	250-411-203SF
4mm	250-411-204SF
5mm	250-411-205SF
6mm	250-411-206SF

200mm, 8"

2mm	250-411-202ESF
3mm	250-411-203ESF
4mm	250-411-204ESF
5mm	250-411-205ESF
6mm	250-411-206ESF

200mm, 8"

1mm	250-411-201SFCC
2mm	250-411-202SFCC
3mm	250-411-203SFCC
4mm	250-411-204SFCC
5mm	250-411-205SFCC
6mm	250-411-206SFCC

230mm, 9"

1mm	250-411-231SF
2mm	250-411-232SF
3mm	250-411-233SF
4mm	250-411-234SF
5mm	250-411-235SF
6mm	250-411-236SF

230mm, 9"

2mm	250-411-232ESF
3mm	250-411-233ESF
4mm	250-411-234ESF
5mm	250-411-235ESF
6mm	250-411-236ESF

230mm, 9"

1mm	250-411-231SFCC
2mm	250-411-232SFCC
3mm	250-411-233SFCC
4mm	250-411-234SFCC
5mm	250-411-235SFCC
6mm	250-411-236SFCC

All Kerrison instruments are available with CERACUT® coating. Code number + CC (e.g. 250-400-181CC)



KERRISON

Long Anterior Punch, regular handle,
9.5mm opening,
40° upwards cutting

15.5mm opening,
40° upwards cutting

250mm, 9⁷/₈"

280mm, 11"

250mm, 9⁷/₈"

280mm, 11"

2mm	250-400-252
3mm	250-400-253
4mm	250-400-254
5mm	250-400-255
6mm	250-400-256

2mm	250-400-282
3mm	250-400-283
4mm	250-400-284
5mm	250-400-285
6mm	250-400-286

2mm	250-450-252
3mm	250-450-253
4mm	250-450-254
5mm	250-450-255
6mm	250-450-256

2mm	250-450-282
3mm	250-450-283
4mm	250-450-284
5mm	250-450-285
6mm	250-450-286

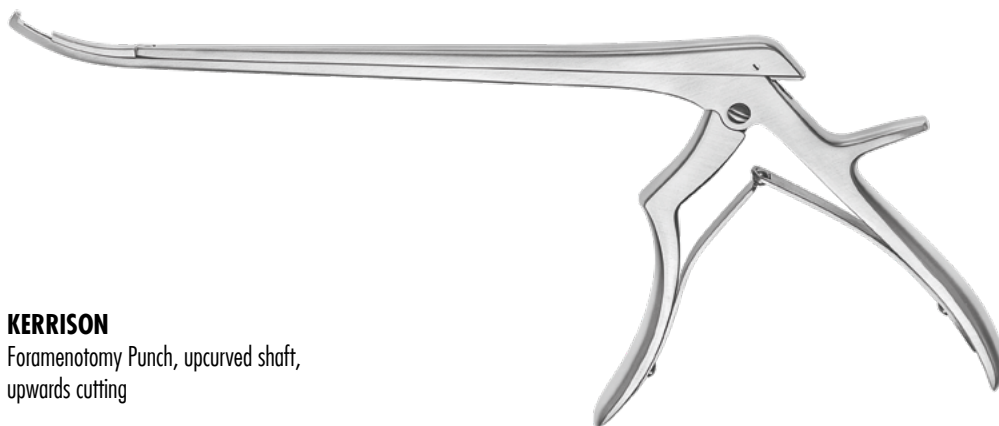

KERRISON

Foramenotomy Punch, upcurved shaft,
upwards cutting

180mm, 7"

200mm, 8"

2mm	210-728-002
3mm	210-728-003
4mm	210-728-004

2mm	210-728-102
3mm	210-728-103
4mm	210-728-104

All Kerrison instruments are available with CERACUT® coating. Code number + CC (e.g. 250-400-181CC)

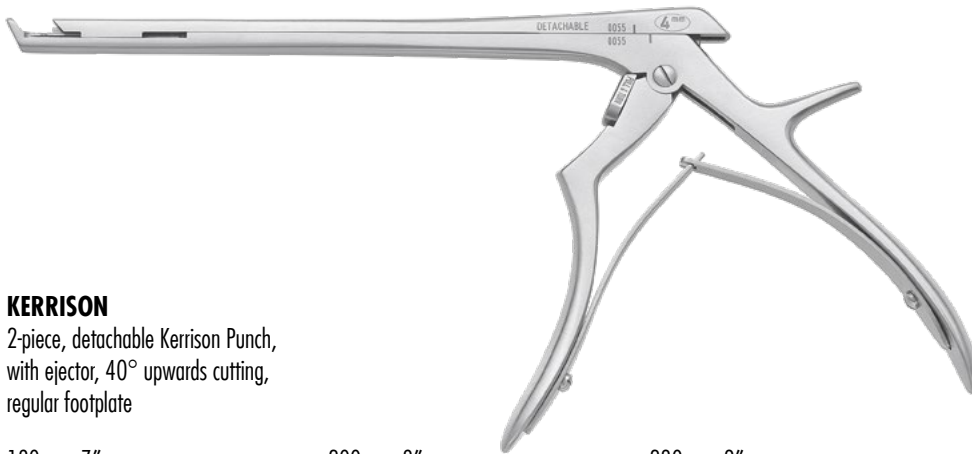
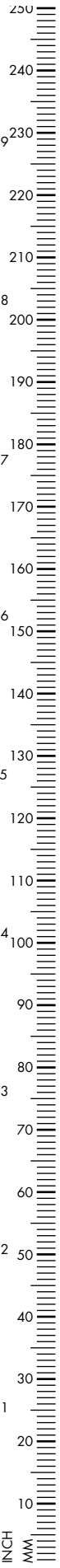

KERRISON

2-piece, detachable Kerrison Punch, with ejector, 40° upwards cutting, regular footplate

180mm, 7"		200mm, 8"		230mm, 9"	
1mm	250-500-181	1mm	250-500-201	1mm	250-500-231
2mm	250-500-182	2mm	250-500-202	2mm	250-500-232
3mm	250-500-183	3mm	250-500-203	3mm	250-500-233
4mm	250-500-184	4mm	250-500-204	4mm	250-500-234
5mm	250-500-185	5mm	250-500-205	5mm	250-500-235
6mm	250-500-186	6mm	250-500-206	6mm	250-500-236
thin footplate 180mm, 7"		thin footplate 200mm, 8"		thin footplate 230mm, 9"	
1mm	250-510-181	1mm	250-510-201	1mm	250-510-231
2mm	250-510-182	2mm	250-510-202	2mm	250-510-232
3mm	250-510-183	3mm	250-510-203	3mm	250-510-233
4mm	250-510-184	4mm	250-510-204	4mm	250-510-234

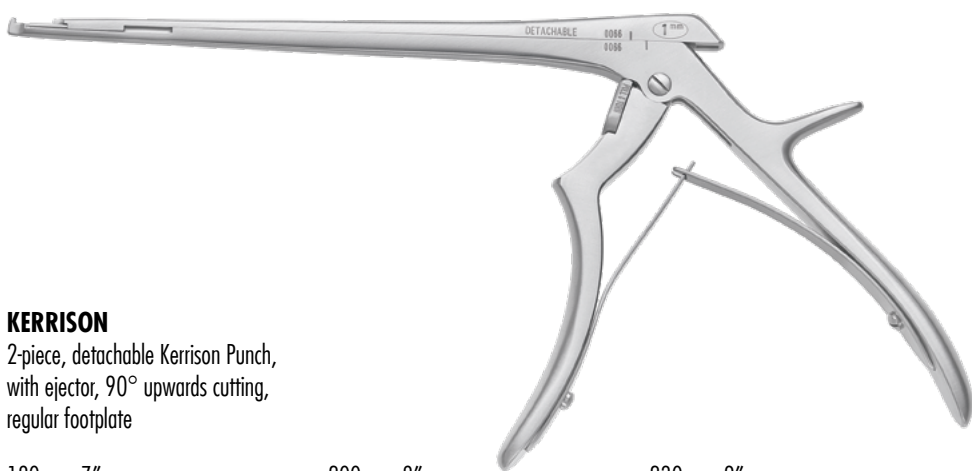

KERRISON

2-piece, detachable Kerrison Punch, with ejector, 90° upwards cutting, regular footplate

180mm, 7"		200mm, 8"		230mm, 9"	
1mm	250-590-181	1mm	250-590-201	1mm	250-590-231
2mm	250-590-182	2mm	250-590-202	2mm	250-590-232
3mm	250-590-183	3mm	250-590-203	3mm	250-590-233
4mm	250-590-184	4mm	250-590-204	4mm	250-590-234
5mm	250-590-185	5mm	250-590-205	5mm	250-590-235
6mm	250-590-186	6mm	250-590-206	6mm	250-590-236

All Kerrison instruments are available with CERACUT® coating. Code number + CC (e.g. 250-400-181CC)

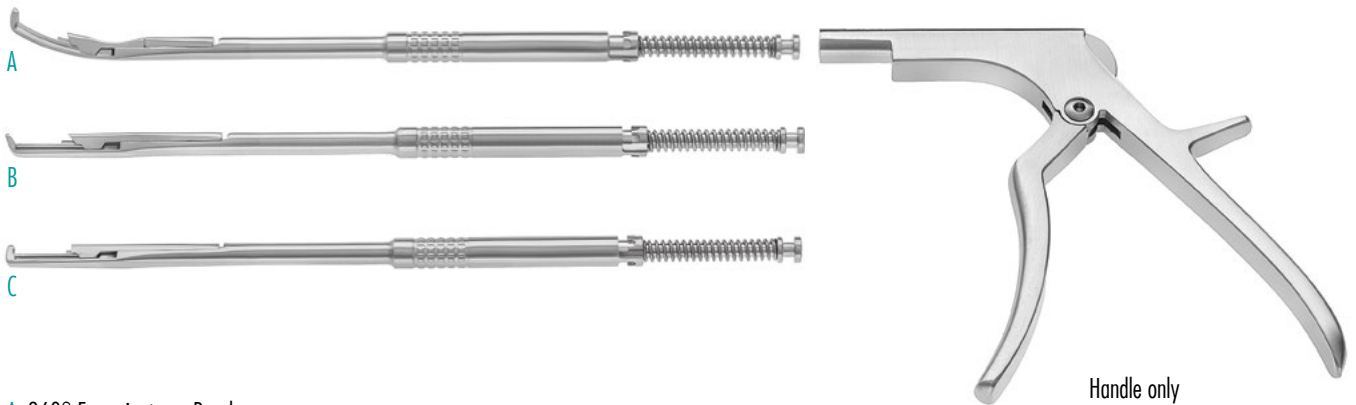

A 360° Foraminotomy Punch
exchangeable shaft, ejector, thin footplate
40° angled

180mm, 7"		200mm, 8"		230mm, 9"		250mm, 9 ⁷ / ₈ "	
2mm	250-280-182	2mm	250-280-202	2mm	250-280-232	2mm	250-280-252
3mm	250-280-183	3mm	250-280-203	3mm	250-280-233	3mm	250-280-253
4mm	250-280-184	4mm	250-280-204	4mm	250-280-234	4mm	250-280-254
5mm	250-280-185	5mm	250-280-205	5mm	250-280-235	5mm	250-280-255

B 360° Laminectomy Punch
exchangeable shaft, ejector, thin footplate
40° angled

180mm, 7"		200mm, 8"		230mm, 9"		250mm, 9 ⁷ / ₈ "	
1mm	250-210-181	1mm	250-210-201	1mm	250-210-231	1mm	250-210-251
1.5mm	250-210-180	1.5mm	250-210-200	2mm	250-210-232	2mm	250-210-252
2mm	250-210-182	2mm	250-210-202	3mm	250-210-233	3mm	250-210-253
3mm	250-210-183	3mm	250-210-203	4mm	250-210-234	4mm	250-210-254
4mm	250-210-183	4mm	250-210-204	5mm	250-210-235	5mm	250-210-255
5mm	250-210-185	5mm	250-210-205				

C 360° Laminectomy Punch
exchangeable shaft, ejector, thin footplate
90° angled

180mm, 7"		200mm, 8"		230mm, 9"		250mm, 9 ⁷ / ₈ "	
1mm	250-245-181	1mm	250-245-201	1mm	250-245-231	1mm	250-245-251
1.5mm	250-245-180	1.5mm	250-245-200	2mm	250-245-232	2mm	250-245-252
2mm	250-245-182	2mm	250-245-202	3mm	250-245-233	3mm	250-245-253
3mm	250-245-183	3mm	250-245-203	4mm	250-245-234	4mm	250-245-254
4mm	250-245-184	4mm	250-245-204	5mm	250-245-235	5mm	250-245-255
5mm	250-245-185	5mm	250-245-205				

All Kerrison instruments are available with CERACUT® coating. Code number + CC (e.g. 250-400-181CC)

KERRISON
Kerrison Swivel Punch
2-piece detachable punch

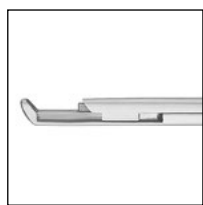

Regular footplate
40° upwards cutting

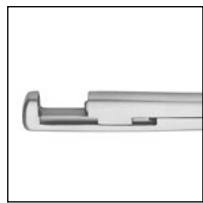

Regular footplate
90° upwards cutting



Regular footplate
40° downwards cutting

180mm, 7"

1mm	250-600-181
2mm	250-600-182
3mm	250-600-183
4mm	250-600-184
5mm	250-600-185
6mm	250-600-186

200mm, 8"

1mm	250-600-201
2mm	250-600-202
3mm	250-600-203
4mm	250-600-204
5mm	250-600-205
6mm	250-600-206

230mm, 9"

1mm	250-600-231
2mm	250-600-232
3mm	250-600-233
4mm	250-600-234
5mm	250-600-235
6mm	250-600-236

180mm, 7"

1mm	250-640-181
2mm	250-640-182
3mm	250-640-183
4mm	250-640-184
5mm	250-640-185
6mm	250-640-186

200mm, 8"

1mm	250-640-201
2mm	250-640-202
3mm	250-640-203
4mm	250-640-204
5mm	250-640-205
6mm	250-640-206

230mm, 9"

1mm	250-640-231
2mm	250-640-232
3mm	250-640-233
4mm	250-640-234
5mm	250-640-235
6mm	250-640-236

180mm, 7"

1mm	250-630-181
2mm	250-630-182
3mm	250-630-183
4mm	250-630-184
5mm	250-630-185
6mm	250-630-186

200mm, 8"

1mm	250-630-201
2mm	250-630-202
3mm	250-630-203
4mm	250-630-204
5mm	250-630-205
6mm	250-630-206

230mm, 9"

1mm	250-630-231
2mm	250-630-232
3mm	250-630-233
4mm	250-630-234
5mm	250-630-235
6mm	250-630-236

All instruments are available with CERACUT® coating. Code number + CC (e.g. 250-600-181CC)



KERRISON

Kerrison Swivel Punch
2-piece detachable punch



Regular footplate
90° downwards cutting

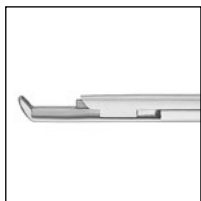

Thin footplate
40° upwards cutting



Thin footplate
40° downwards cutting



Foramenotomy
40° upwards cutting

180mm, 7"	
1mm	250-660-181
2mm	250-660-182
3mm	250-660-183
4mm	250-660-184
5mm	250-660-185
6mm	250-660-186

200mm, 8"	
1mm	250-660-201
2mm	250-660-202
3mm	250-660-203
4mm	250-660-204
5mm	250-660-205
6mm	250-660-206

230mm, 9"	
1mm	250-660-231
2mm	250-660-232
3mm	250-660-233
4mm	250-660-234
5mm	250-660-235
6mm	250-660-236

180mm, 7"	
1mm	250-610-181
2mm	250-610-182
3mm	250-610-183
4mm	250-610-184
5mm	250-610-185
6mm	250-610-186

200mm, 8"	
1mm	250-610-201
2mm	250-610-202
3mm	250-610-203
4mm	250-610-204
5mm	250-610-205
6mm	250-610-206

230mm, 9"	
1mm	250-610-231
2mm	250-610-232
3mm	250-610-233
4mm	250-610-234
5mm	250-610-235
6mm	250-610-236

180mm, 7"	
1mm	250-620-181
2mm	250-620-182
3mm	250-620-183
4mm	250-620-184
5mm	250-620-185
6mm	250-620-186

200mm, 8"	
1mm	250-620-201
2mm	250-620-202
3mm	250-620-203
4mm	250-620-204
5mm	250-620-205
6mm	250-620-206

230mm, 9"	
1mm	250-620-231
2mm	250-620-232
3mm	250-620-233
4mm	250-620-234
5mm	250-620-235
6mm	250-620-236

180mm, 7"	
1mm	250-680-181
2mm	250-680-182
3mm	250-680-183
4mm	250-680-184
5mm	250-680-185
6mm	250-680-186

200mm, 8"	
1mm	250-680-201
2mm	250-680-202
3mm	250-680-203
4mm	250-680-204
5mm	250-680-205
6mm	250-680-206

All instruments are available with CERACUT® coating. Code number + CC (e.g. 250-600-181CC)

KERRISON
Kerrison Swivel Punch
bayonet shaped shaft
2-piece detachable punch

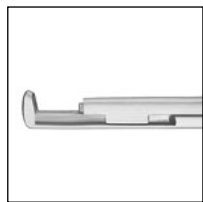
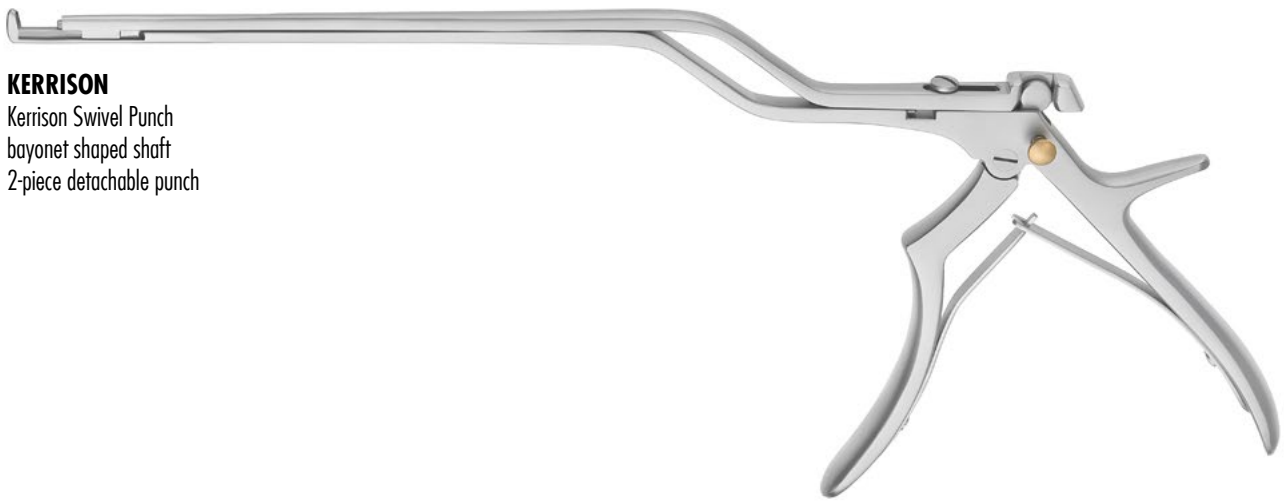

90° upwards cutting



90° upwards cutting
left curved jaw



90° upwards cutting
right curved jaw

180mm, 7"	
1mm	250-650-111
2mm	250-650-112
3mm	250-650-113
4mm	250-650-114
5mm	250-650-115
6mm	250-650-116

200mm, 8"	
1mm	250-650-151
2mm	250-650-152
3mm	250-650-153
4mm	250-650-154
5mm	250-650-155
6mm	250-650-156

230mm, 9"	
1mm	250-650-181
2mm	250-650-182
3mm	250-650-183
4mm	250-650-184
5mm	250-650-185
6mm	250-650-186

180mm, 7"	
1mm	250-651-111
2mm	250-651-112
3mm	250-651-113
4mm	250-651-114
5mm	250-651-115
6mm	250-651-116

200mm, 8"	
1mm	250-651-151
2mm	250-651-152
3mm	250-651-153
4mm	250-651-154
5mm	250-651-155
6mm	250-651-156

230mm, 9"	
1mm	250-651-181
2mm	250-651-182
3mm	250-651-183
4mm	250-651-184
5mm	250-651-185
6mm	250-651-186

180mm, 7"	
1mm	250-652-111
2mm	250-652-112
3mm	250-652-113
4mm	250-652-114
5mm	250-652-115
6mm	250-652-116

200mm, 8"	
1mm	250-652-151
2mm	250-652-152
3mm	250-652-153
4mm	250-652-154
5mm	250-652-155
6mm	250-652-156

230mm, 9"	
1mm	250-652-181
2mm	250-652-182
3mm	250-652-183
4mm	250-652-184
5mm	250-652-185
6mm	250-652-186

All instruments are available with CERACUT® coating. Code number + CC (e.g. 250-600-181CC)

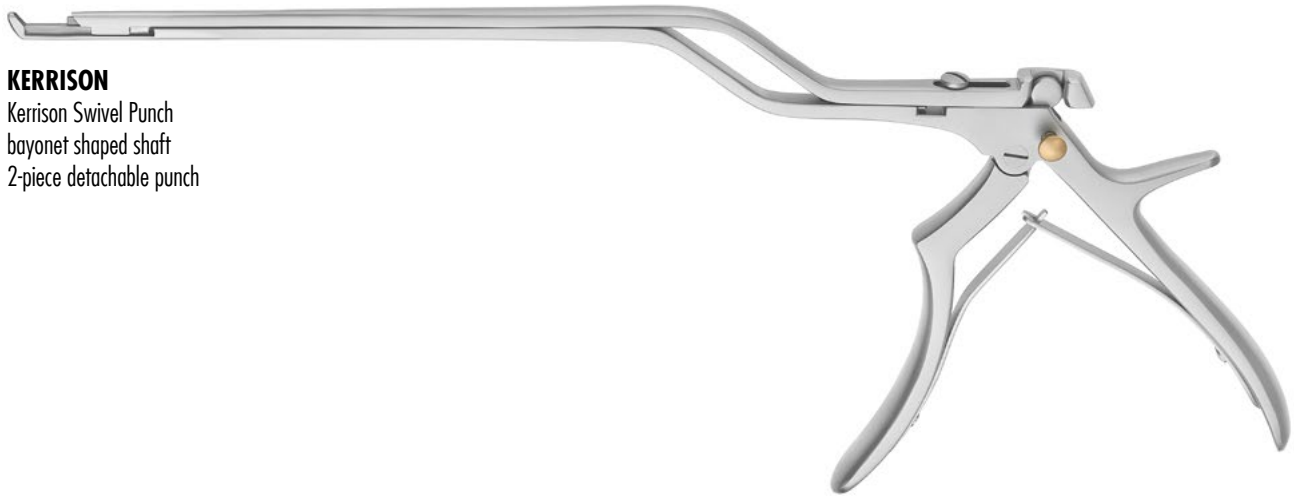

KERRISON

Kerrison Swivel Punch
bayonet shaped shaft
2-piece detachable punch

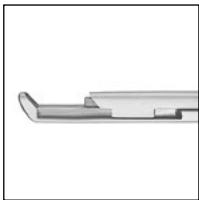

40° upwards cutting

180mm, 7"	
1mm	250-641-111
2mm	250-641-112
3mm	250-641-113
4mm	250-641-114
5mm	250-641-115
6mm	250-641-116

200mm, 8"	
1mm	250-641-151
2mm	250-641-152
3mm	250-641-153
4mm	250-641-154
5mm	250-641-155
6mm	250-641-156

230mm, 9"	
1mm	250-641-181
2mm	250-641-182
3mm	250-641-183
4mm	250-641-184
5mm	250-641-185
6mm	250-641-186



40° upwards cutting
left curved jaw

180mm, 7"	
1mm	250-643-111
2mm	250-643-112
3mm	250-643-113
4mm	250-643-114
5mm	250-643-115
6mm	250-643-116

200mm, 8"	
1mm	250-643-151
2mm	250-643-152
3mm	250-643-153
4mm	250-643-154
5mm	250-643-155
6mm	250-643-156

230mm, 9"	
1mm	250-643-181
2mm	250-643-182
3mm	250-643-183
4mm	250-643-184
5mm	250-643-185
6mm	250-643-186



40° upwards cutting
right curved jaw

180mm, 7"	
1mm	250-642-111
2mm	250-642-112
3mm	250-642-113
4mm	250-642-114
5mm	250-642-115
6mm	250-642-116

200mm, 8"	
1mm	250-642-151
2mm	250-642-152
3mm	250-642-153
4mm	250-642-154
5mm	250-642-155
6mm	250-642-156

230mm, 9"	
1mm	250-642-181
2mm	250-642-182
3mm	250-642-183
4mm	250-642-184
5mm	250-642-185
6mm	250-642-186

All instruments are available with CERACUT® coating. Code number + CC (e.g. 250-600-181CC)



KERRISON
Kerrison Swivel Punch
bayonet shaped shaft
black finish, handle with silicone coating



40° upwards cutting

140mm, 5¹/₂" working length

1mm	250-000-001
2mm	250-000-002
3mm	250-000-003
4mm	250-000-004
5mm	250-000-005



90° upwards cutting

140mm, 5¹/₂" working length

1mm	250-000-006
2mm	250-000-007
3mm	250-000-008
4mm	250-000-009
5mm	250-000-010

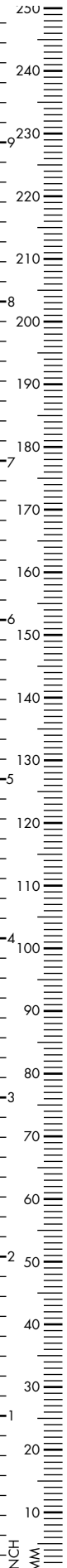

Disc Rongeurs



MINI-CUSHING

1.5x10mm bite

180mm, 7"	250-100-181
200mm, 8"	250-100-201

CUSHING

2x10mm bite

130mm, 5 ^{1/8} "	250-100-132
150mm, 6"	250-100-152
180mm, 7"	250-100-182
200mm, 8"	250-100-202
230mm, 9"	250-100-232



1.5x10mm bite

180mm, 7"	250-110-181
200mm, 8"	250-110-201

2x10mm bite

130mm, 5 ^{1/8} "	250-110-132
150mm, 6"	250-110-152
180mm, 7"	250-110-182
200mm, 8"	250-110-202
230mm, 9"	250-110-232



1.5x10mm bite

180mm, 7"	250-120-181
200mm, 8"	250-120-201

2x10mm bite

130mm, 5 ^{1/8} "	250-120-132
150mm, 6"	250-120-152
180mm, 7"	250-120-182
200mm, 8"	250-120-202
230mm, 9"	250-120-232

Laminectomy Rongeurs



LOVE GRUENWALD

straight, 3x10mm bite

130mm, 5 ¹ / ₈ "	250-100-133
150mm, 6"	250-100-153
180mm, 7"	250-100-183
200mm, 8"	250-100-203
230mm, 9"	250-100-233

upwards curved, 3x10mm bite

130mm, 5 ¹ / ₈ "	250-110-133
150mm, 6"	250-110-153
180mm, 7"	250-110-183
200mm, 8"	250-110-203
230mm, 9"	250-110-233

downwards curved, 3x10mm bite

130mm, 5 ¹ / ₈ "	250-120-133
150mm, 6"	250-120-153
180mm, 7"	250-120-183
200mm, 8"	250-120-203
230mm, 9"	250-120-233

SPURLING

straight, 4x10mm bite

130mm, 5 ¹ / ₈ "	250-100-134
150mm, 6"	250-100-154
180mm, 7"	250-100-184
200mm, 8"	250-100-204
230mm, 9"	250-100-234

upwards curved, 5x10mm bite

130mm, 5 ¹ / ₈ "	250-110-134
150mm, 6"	250-110-154
180mm, 7"	250-110-184
200mm, 8"	250-110-204
230mm, 9"	250-110-234

downwards curved, 5x10mm bite

130mm, 5 ¹ / ₈ "	250-120-134
150mm, 6"	250-120-154
180mm, 7"	250-120-184
200mm, 8"	250-120-204
230mm, 9"	250-120-234

CASPAR

straight, 5x10mm bite

130mm, 5 ¹ / ₈ "	250-100-135
150mm, 6"	250-100-155
180mm, 7"	250-100-185
200mm, 8"	250-100-205
230mm, 9"	250-100-235

upwards curved, 5x10mm bite

130mm, 5 ¹ / ₈ "	250-110-135
150mm, 6"	250-110-155
180mm, 7"	250-110-185
200mm, 8"	250-110-205
230mm, 9"	250-110-235

downwards curved, 5x10mm bite

130mm, 5 ¹ / ₈ "	250-120-135
150mm, 6"	250-120-155
180mm, 7"	250-120-185
200mm, 8"	250-120-205
230mm, 9"	250-120-235



CASPAR

Toothed Disc Rongeurs

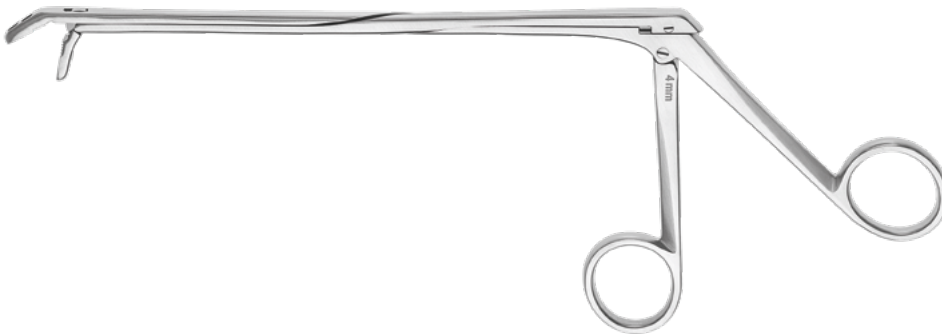

straight



upwards curved



downwards curved

2x12mm bite	
140mm, 5 ¹ / ₂ "	250-130-142
160mm, 6 ¹ / ₄ "	250-130-162
180mm, 7"	250-130-182

2x12mm bite	
140mm, 5 ¹ / ₂ "	250-140-142
160mm, 6 ¹ / ₄ "	250-140-162
180mm, 7"	250-140-182

2x12mm bite	
140mm, 5 ¹ / ₂ "	250-150-142
160mm, 6 ¹ / ₄ "	250-150-162
180mm, 7"	250-150-182

3x12mm bite	
140mm, 5 ¹ / ₂ "	250-130-143
160mm, 6 ¹ / ₄ "	250-130-163
180mm, 7"	250-130-183

3x12mm bite	
140mm, 5 ¹ / ₂ "	250-140-143
160mm, 6 ¹ / ₄ "	250-140-163
180mm, 7"	250-140-183

3x12mm bite	
140mm, 5 ¹ / ₂ "	250-150-143
160mm, 6 ¹ / ₄ "	250-150-163
180mm, 7"	250-150-183

straight, 4x14mm bite	
140mm, 5 ¹ / ₂ "	250-130-144
160mm, 6 ¹ / ₄ "	250-130-164
180mm, 7"	250-130-184

upwards curved, 4x14mm bite	
140mm, 5 ¹ / ₂ "	250-140-144
160mm, 6 ¹ / ₄ "	250-140-164
180mm, 7"	250-140-184

downwards curved, 4x14mm bite	
140mm, 5 ¹ / ₂ "	250-150-144
160mm, 6 ¹ / ₄ "	250-150-164
180mm, 7"	250-150-184

straight, 5x14mm bite	
140mm, 5 ¹ / ₂ "	250-130-145
160mm, 6 ¹ / ₄ "	250-130-165
180mm, 7"	250-130-185

upwards curved, 5x14mm bite	
140mm, 5 ¹ / ₂ "	250-140-145
160mm, 6 ¹ / ₄ "	250-140-165
180mm, 7"	250-140-185

downwards curved, 5x14mm bite	
140mm, 5 ¹ / ₂ "	250-150-145
160mm, 6 ¹ / ₄ "	250-150-165
180mm, 7"	250-150-185

straight, 6x16mm bite	
140mm, 5 ¹ / ₂ "	250-130-146
160mm, 6 ¹ / ₄ "	250-130-166
180mm, 7"	250-130-186

upwards curved, 6x16mm bite	
140mm, 5 ¹ / ₂ "	250-140-146
160mm, 6 ¹ / ₄ "	250-140-166
180mm, 7"	250-140-186

downwards curved, 6x16mm bite	
140mm, 5 ¹ / ₂ "	250-150-146
160mm, 6 ¹ / ₄ "	250-150-166
180mm, 7"	250-150-186

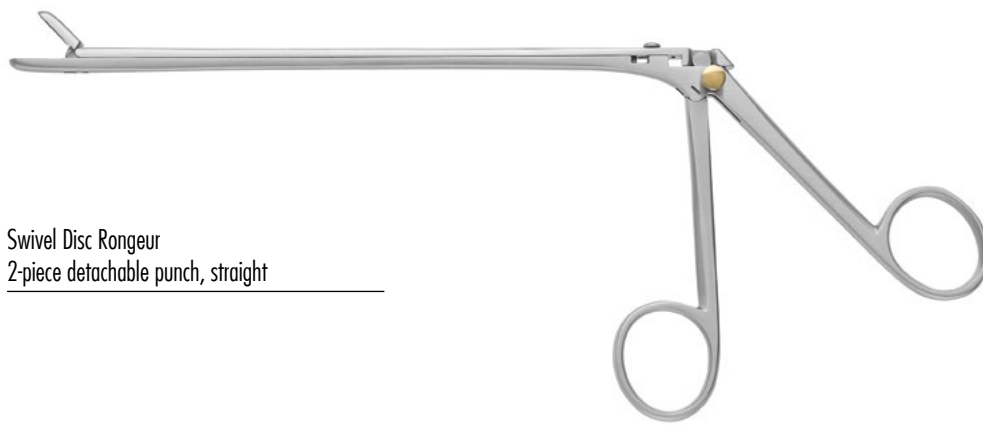

Swivel Disc Rongeur
2-piece detachable punch, straight

CUSHING
2x10mm

length	straight jaw	30° upwards jaw	30° downwards jaw
150mm, 6"	250-700-152	250-710-152	250-720-152
180mm, 7"	250-700-182	250-710-182	250-720-182
200mm, 8"	250-700-202	250-710-202	250-720-202

LOVE GRUENWALD
3x10mm

length	straight jaw	30° upwards jaw	30° downwards jaw
150mm, 6"	250-700-153	250-710-153	250-720-153
180mm, 7"	250-700-183	250-710-183	250-720-183
200mm, 8"	250-700-203	250-710-203	250-720-203

SPURLING
4x10mm

length	straight jaw	30° upwards jaw	30° downwards jaw
150mm, 6"	250-700-154	250-710-154	250-720-154
180mm, 7"	250-700-184	250-710-184	250-720-184
200mm, 8"	250-700-204	250-710-204	250-720-204

CASPAR
5x10mm

length	straight jaw	30° upwards jaw	30° downwards jaw
150mm, 6"	250-700-155	250-710-155	250-720-155
180mm, 7"	250-700-185	250-710-185	250-720-185
200mm, 8"	250-700-205	250-710-205	250-720-205



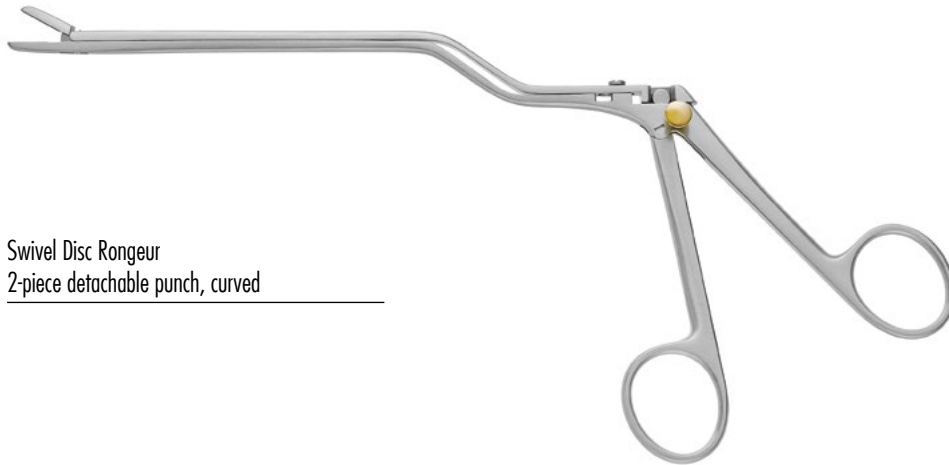

Swivel Disc Rongeur
2-piece detachable punch, curved

CUSHING

2x10mm

length

110mm, 4¹/₃"

150mm, 6"

180mm, 7"



bayonet right, straight jaw



bayonet left, straight jaw



bayonet up, straight jaw

250-750-112

250-760-112

250-770-112

250-750-152

250-760-152

250-770-152

250-750-182

250-760-182

250-770-182

LOVE GRUENWALD

3x10mm

length

110mm, 4¹/₃"

150mm, 6"

180mm, 7"

250-750-113

250-760-113

250-770-113

250-750-153

250-760-153

250-770-153

250-750-183

250-760-183

250-770-182

SPURLING

4x10mm

length

110mm, 4¹/₃"

150mm, 6"

180mm, 7"

250-750-114

250-760-114

250-770-114

250-750-154

250-760-154

250-770-154

250-750-184

250-760-184

250-770-184

CASPAR

5x10mm

length

110mm, 4¹/₃"

150mm, 6"

180mm, 7"

250-750-115

250-760-115

250-770-115

250-750-155

250-760-155

250-770-155

250-750-185

250-760-185

250-770-185

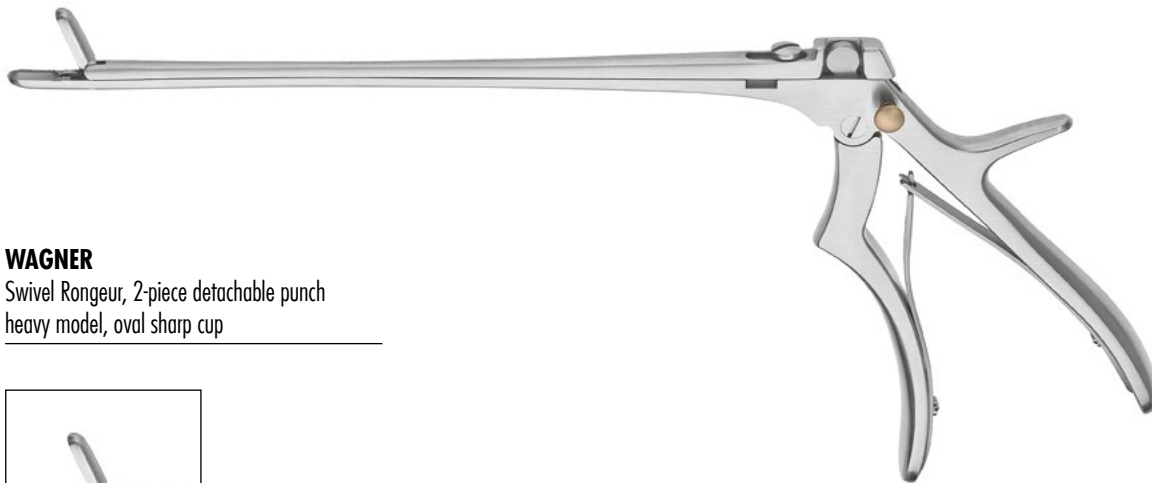

WAGNER

Swivel Rongeur, 2-piece detachable punch heavy model, oval sharp cup



straight
bite

	200mm, 8"	300mm, 11 ⁷ / ₈ "
--	-----------	---

3mm	250-670-203	250-670-303
-----	-------------	-------------

4mm	250-670-204	250-670-304
-----	-------------	-------------

5mm	250-670-205	250-670-305
-----	-------------	-------------



50° upwards
bite

	200mm, 8"	300mm, 11 ⁷ / ₈ "
--	-----------	---

4mm	250-671-204	250-671-304
-----	-------------	-------------



bayonet shape, straight jaw
bite

	110mm, 4 ¹ / ₃ "	150mm, 6"	180mm, 7"
--	--	-----------	-----------

3mm	250-672-113	250-672-153	250-672-183
-----	-------------	-------------	-------------

4mm	250-672-114	250-672-154	250-672-184
-----	-------------	-------------	-------------

5mm	250-672-115	250-672-155	250-672-185
-----	-------------	-------------	-------------

bayonet shape, 50° upwards

bite	110mm, 4 ¹ / ₃ "	150mm, 6"	180mm, 7"
------	--	-----------	-----------

4mm	250-673-114	250-673-154	250-673-184
-----	-------------	-------------	-------------

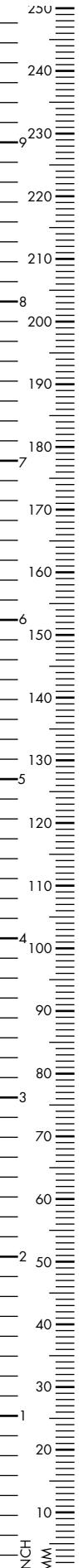

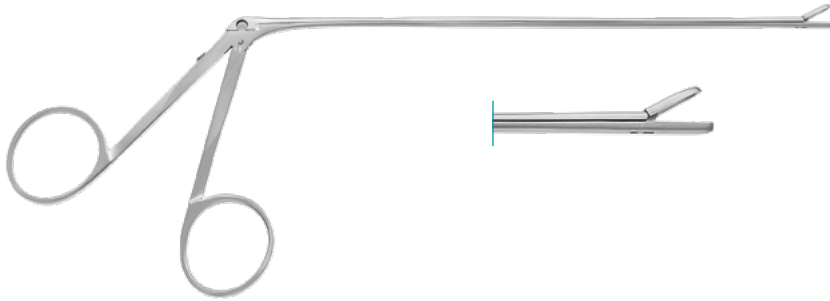

DECKER

Rongeur, fine model, 2x6mm jaw
150mm, 6"

straight	250-066-817
left curved	250-066-824
right curved	250-066-827

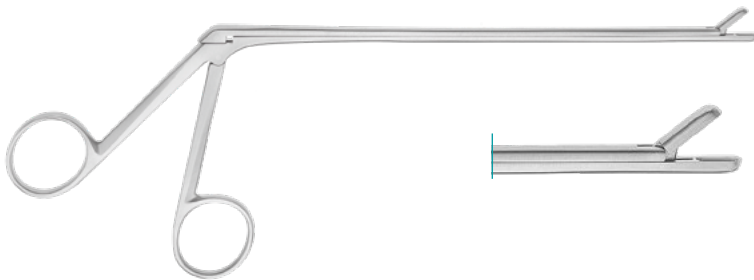

DECKER

Rongeur, 2x6mm jaw, straight

150mm, 6"	250-067-817
-----------	-------------

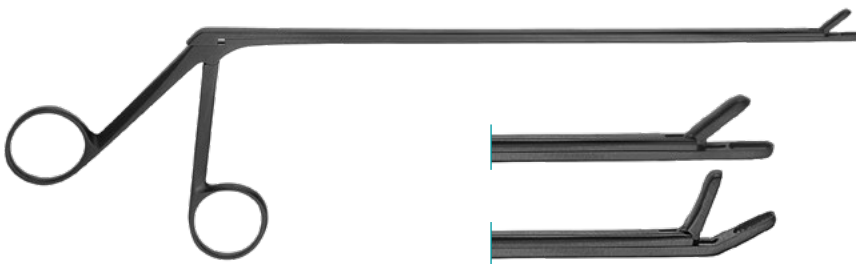

Micro Rongeur, CERA-CUT®
2mm jaw, 170mm, 6²/₃"

straight	250-300-170CC
upcurved	250-301-170CC

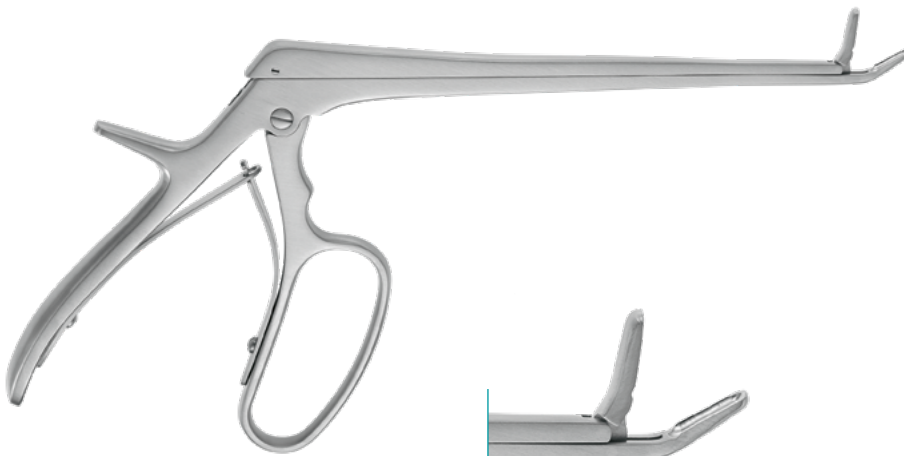
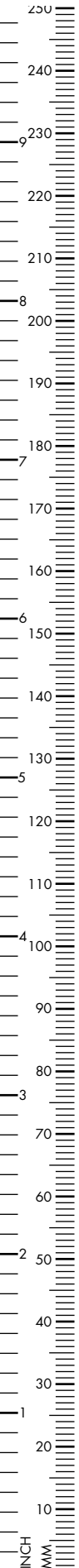

FERRIS SMITH

Disc Rongeur, straight
180mm, 7"

2mm	250-067-802
3mm	250-067-803
4mm	250-067-804
6mm	250-067-806

200mm, 8"

2mm	250-068-802
3mm	250-068-803
4mm	250-068-804
6mm	250-068-806

upwards angled
180mm, 7"

2mm	250-067-782
3mm	250-067-783
4mm	250-067-784
6mm	250-067-786

200mm, 8"

2mm	250-067-765
3mm	250-067-766
4mm	250-067-767
6mm	250-067-768

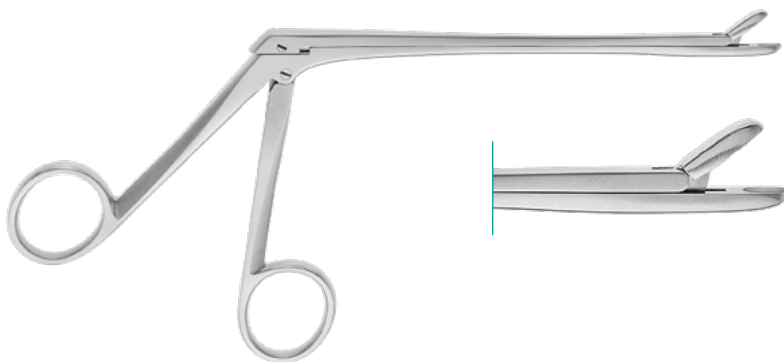

PEAPOD

Rongeur, 140mm, 5^{1/2}"
straight

2 x 6mm bite	250-115-140
2.5 x 7mm bite	250-118-140
3 x 10mm bite	250-116-140

upwards angled

2 x 6mm bite	250-114-140
2.5 x 7mm bite	250-119-140
3 x 10mm bite	250-117-140



CLOWARD

Rongeur, straight jaw, serrated
180mm, 7"

4mm	250-066-796
-----	-------------

6mm	250-066-797
-----	-------------

200mm, 8"	
-----------	--

4mm	250-066-786
-----	-------------

6mm	250-066-787
-----	-------------

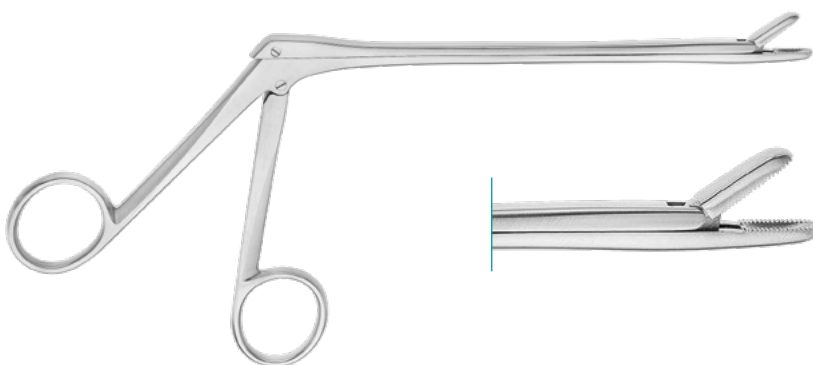

SCHLESINGER

Rongeur, straight jaw, fine serrated
150mm, 6"

2mm	259-195-002
-----	-------------

3mm	259-195-003
-----	-------------

4mm	259-195-004
-----	-------------

180mm, 7"	
-----------	--

2mm	259-196-002
-----	-------------

3mm	259-196-003
-----	-------------

4mm	259-196-004
-----	-------------

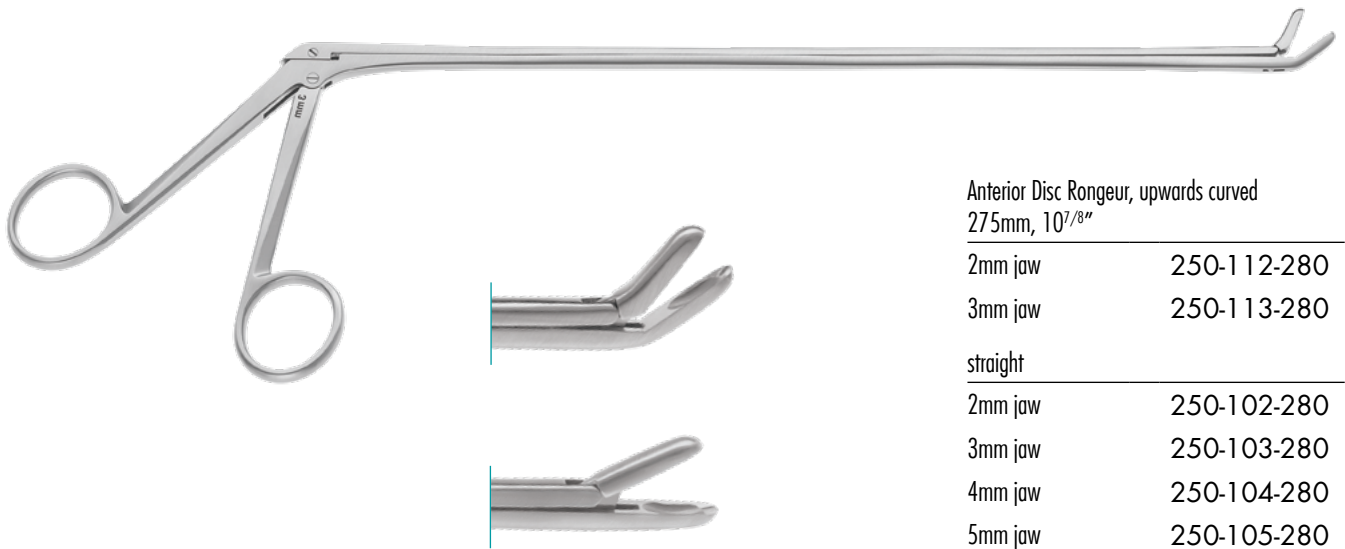

Anterior Disc Rongeur, upwards curved
275mm, 10⁷/₈"

2mm jaw	250-112-280
3mm jaw	250-113-280
straight	
2mm jaw	250-102-280
3mm jaw	250-103-280
4mm jaw	250-104-280
5mm jaw	250-105-280



VILBISS

Cranial Rongeur Forceps
with replacement blade

210mm, 8¹/₄" 250-066-798

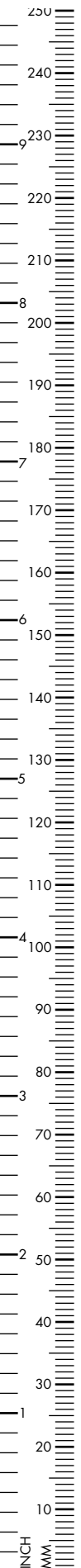

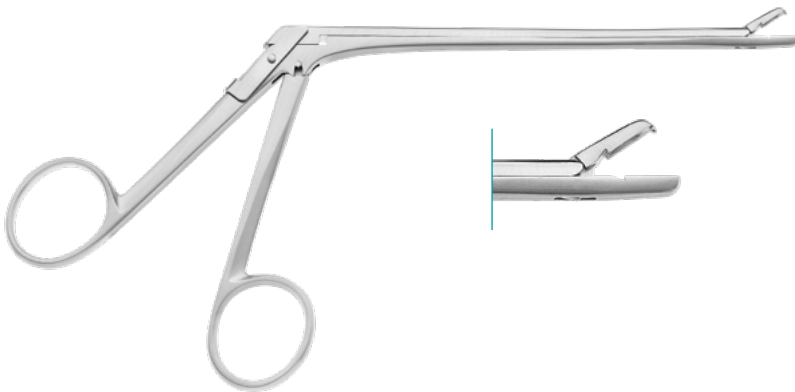

WILLIAMS

Dissectomy Rongeur, 2.3mm wide cup,
1.0mm single teeth

140mm, 5 ¹ / ₂ "	250-068-140
230mm, 9"	250-068-230

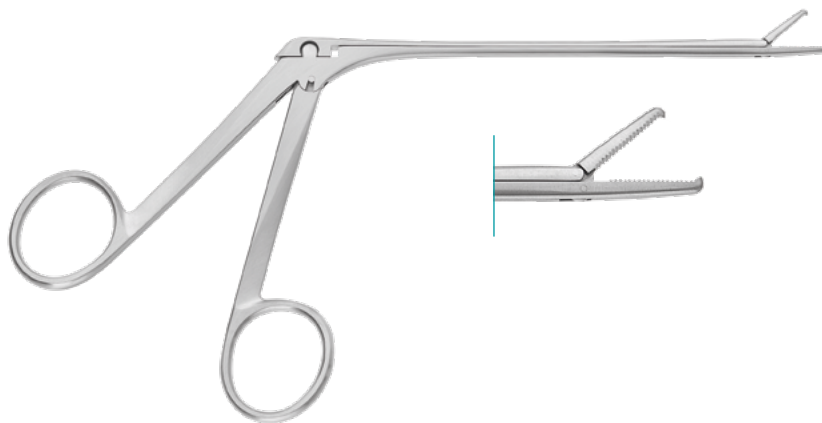

NOYES

Alligator Forceps, 1x2 teeth with serrated jaw

140mm, 5 ¹ / ₂ "	250-526-140
--	-------------

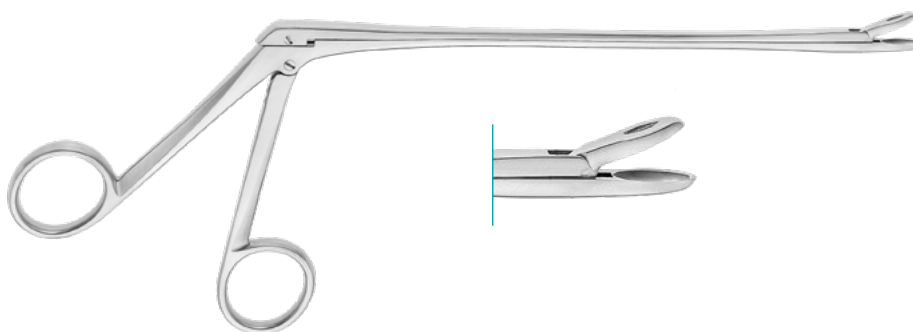

WEIL BLAKESLEY

Rongeur, fenestrated jaw, fine serrated
180mm, 7", straight

3.0mm	252-030-180
3.5mm	252-035-180
4.0mm	252-040-180
upwards angled	
3.0mm	252-030-181
3.5mm	252-035-181
4.0mm	252-040-181

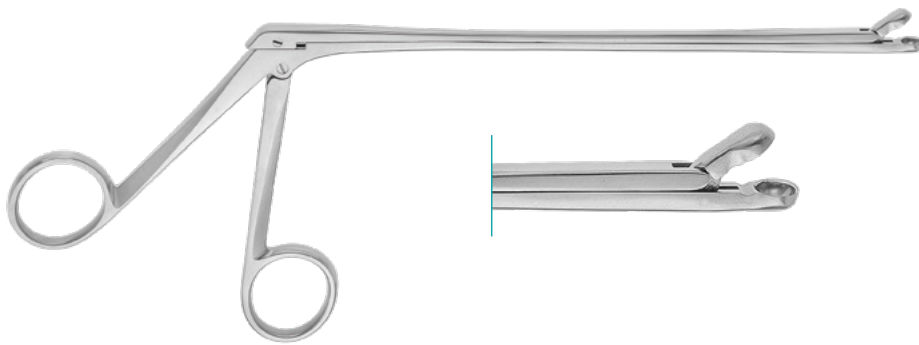

OLDBERG

Rongeur, Ø7mm

180mm, 7"

250-066-605

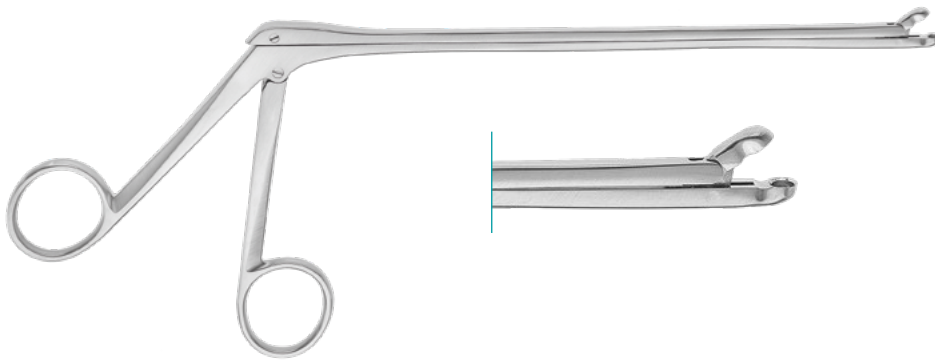

YASARGIL

Rongeur, 190mm, 7¹/₂"

Ø2.2mm

250-066-599

Ø3.5mm

250-066-600

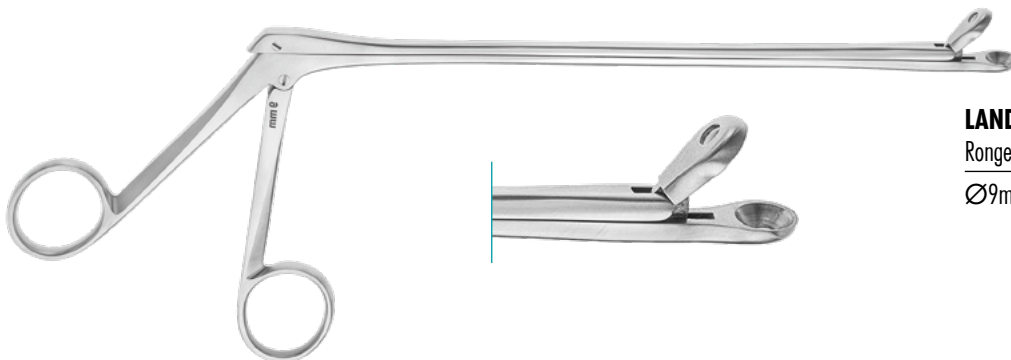

LANDOLT

Rongeur, 200mm, 8"

Ø9mm

250-066-345

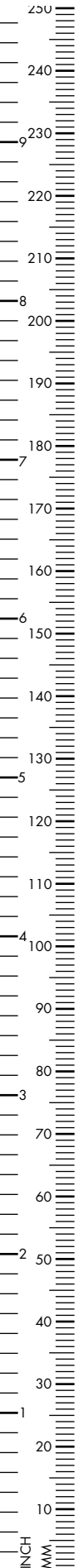



Micro Dissectomy Rongeur,
black coated, 180mm, 7"

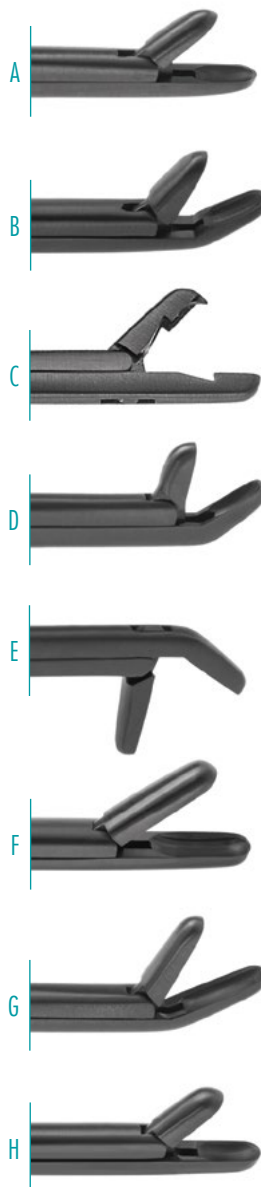

A	straight, 2x6mm	250-000-016
B	30° bent up, 2x6mm	250-000-017
C	Grasper, 2mm	250-000-018
D	40° upwards curved, 2x6mm	250-000-019
E	downwards curved, 2x6mm	250-000-020
F	straight, 4mm	250-000-021
G	upwards angled, 4mm	250-000-022
H	short straight, Kerrison handle 4mm	250-000-023



Micro Scissors, straight

A sharp/sharp, 70mm working length

190mm, 7¹/₂" 250-800-190

90mm working length

210mm, 8¹/₄" 250-800-210

120mm working length

240mm, 9¹/₂" 250-800-240

135mm working length

255mm, 10" 250-800-255

B sharp/blunt, 70mm working length

190mm, 7¹/₂" 250-802-190

90mm working length

210mm, 8¹/₄" 250-802-210

120mm working length

240mm, 9¹/₂" 250-802-240

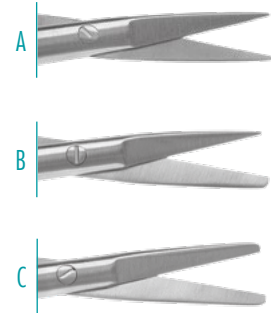

C blunt/blunt, 70mm working length

190mm, 7¹/₂" 250-804-190

90mm working length

210mm, 8¹/₄" 250-804-210

120mm working length

240mm, 9¹/₂" 250-804-240

135mm working length

255mm, 10" 250-804-255



Micro Scissors, curved

A sharp/sharp, 70mm working length

190mm, 7¹/₂" 250-801-190

90mm working length

210mm, 8¹/₄" 250-801-210

120mm working length

240mm, 9¹/₂" 250-801-240

135mm working length

255mm, 10" 250-801-255

B sharp/blunt, 70mm working length

190mm, 7¹/₂" 250-803-190

90mm working length

210mm, 8¹/₄" 250-803-210

120mm working length

240mm, 9¹/₂" 250-803-240

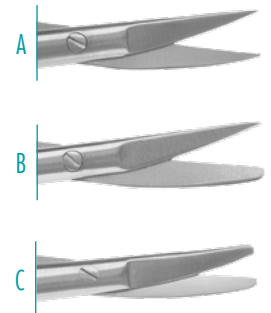

C blunt/blunt, 70mm working length

190mm, 7¹/₂" 250-805-190

90mm working length

210mm, 8¹/₄" 250-805-210

120mm working length

240mm, 9¹/₂" 250-805-240

135mm working length

255mm, 10" 250-805-255

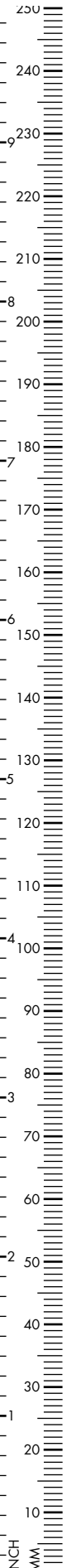

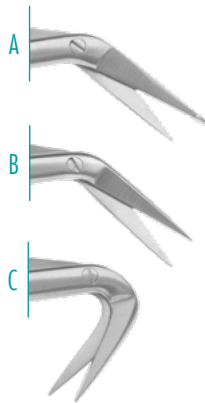

Micro Scissors, angled
90mm working length

A knob/sharp, 45° angled

210mm, 8 ¹ / ₄ "	250-811-210
--	-------------

B sharp/sharp, 45° angled

210mm, 8 ¹ / ₄ "	250-813-210
--	-------------

C sharp/sharp, 125° angled

210mm, 8 ¹ / ₄ "	250-815-210
--	-------------

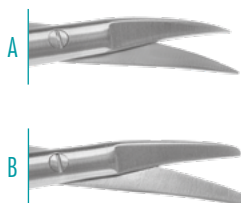

Micro Scissors, downward curved
90mm working length

A sharp/sharp

210mm, 8 ¹ / ₄ "	250-807-210
--	-------------

B blunt/blunt

210mm, 8 ¹ / ₄ "	250-809-210
--	-------------

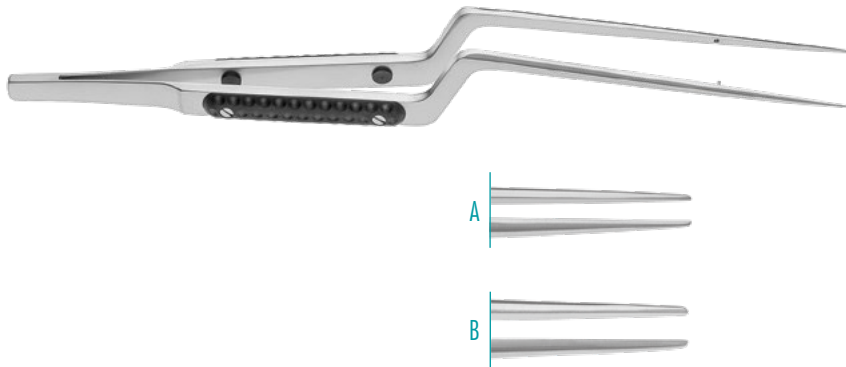

Micro Forceps

A 0.5mm jaw

190mm, 7 ¹ / ₂ "	250-820-190
--	-------------

210mm, 8 ¹ / ₄ "	250-820-210
--	-------------

240mm, 9 ¹ / ₂ "	250-820-240
--	-------------

Neuro Forceps

B 0.9mm jaw

190mm, 7 ¹ / ₂ "	250-822-190
--	-------------

210mm, 8 ¹ / ₄ "	250-822-210
--	-------------

240mm, 9 ¹ / ₂ "	250-822-240
--	-------------

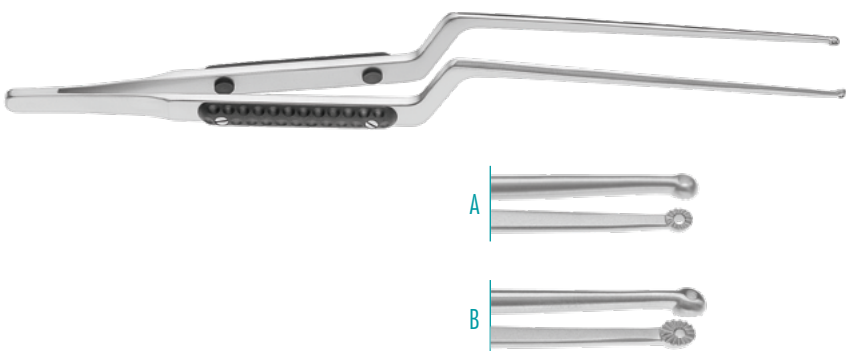

Micro Tumor Grasping Forceps

A Ø 2.5mm

210mm, 8 ¹ / ₄ "	250-830-210
--	-------------

245mm, 9 ² / ₃ "	250-830-245
--	-------------

B Ø 3.5mm

210mm, 8 ¹ / ₄ "	250-832-210
--	-------------

245mm, 9 ² / ₃ "	250-832-245
--	-------------

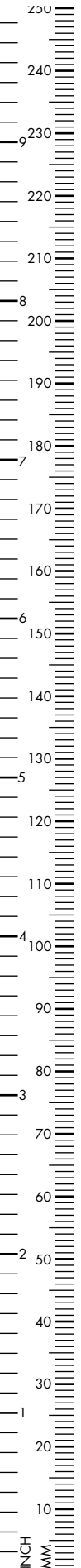

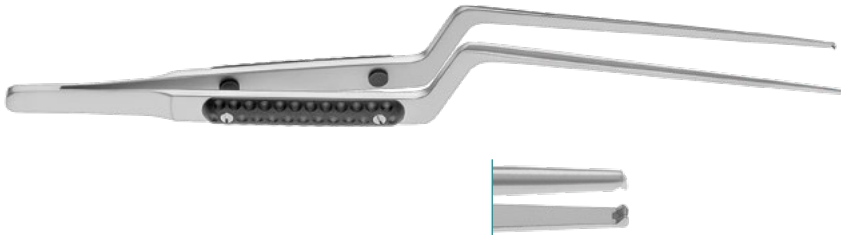

Micro Tissue Forceps
1x2 teeth

210mm, 8 ^{1/4} "	250-850-210
---------------------------	-------------

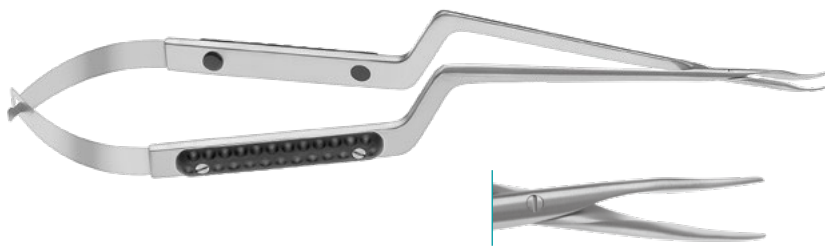

Micro Needle Holder,
curved, 0.5mm jaw,
70mm working length

200mm, 8"	250-841-200
-----------	-------------

90mm working length

220mm, 8 ^{2/3} "	250-841-220
---------------------------	-------------

120mm working length

250mm, 9 ^{7/8} "	250-841-250
---------------------------	-------------



Container, double layer system

265 x 255 x 65mm	600-407-255
------------------	-------------

400 x 290 x 75mm	600-407-260
------------------	-------------

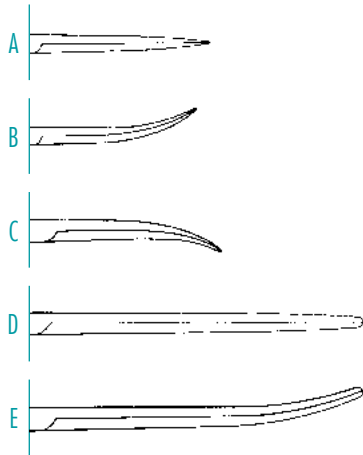
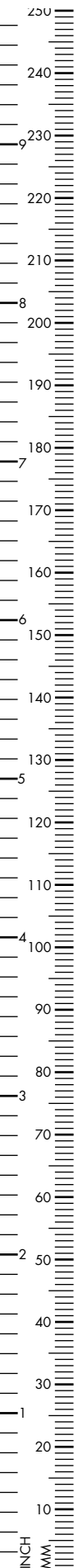

YASARGIL

A Micro Scissors, straight

165mm, 6 ^{1/2} "	250-064-030
200mm, 8"	250-064-034

B curved

165mm, 6 ^{1/2} "	250-064-031
200mm, 8"	250-064-035

C curved downwards

200mm, 8"	250-064-036
-----------	-------------

D straight, dissecting

200mm, 8"	250-064-032
-----------	-------------

E curved, dissecting

200mm, 8"	250-064-033
-----------	-------------

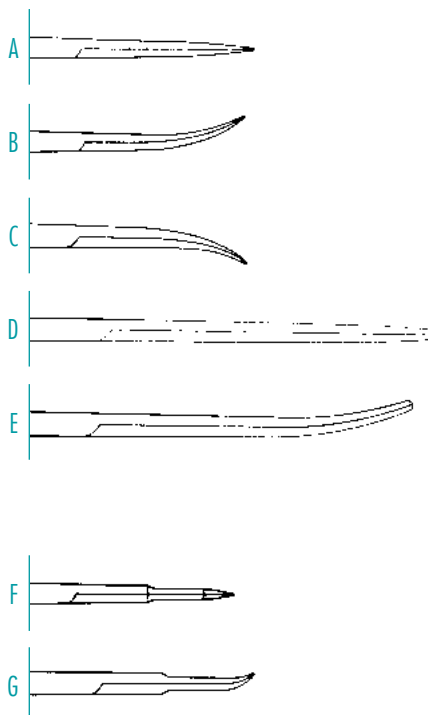

YASARGIL

A Micro Scissors, straight

225mm, 8 ^{7/8} "	250-064-038
toothed blades	250-064-060

B curved

225mm, 8 ^{7/8} "	250-064-039
245mm, 9 ^{2/3} "	250-064-061

C curved downwards

225mm, 8 ^{7/8} "	250-064-047
---------------------------	-------------

D Dissecting Scissors, straight

225mm, 8 ^{7/8} "	250-064-044
---------------------------	-------------

E Dissecting Scissors, curved

225mm, 8 ^{7/8} "	250-064-043
---------------------------	-------------

VANNAS

Micro Scissors, straight, 225mm, 8^{7/8}"

F straight	250-064-037
------------	-------------

G curved	250-064-040
----------	-------------

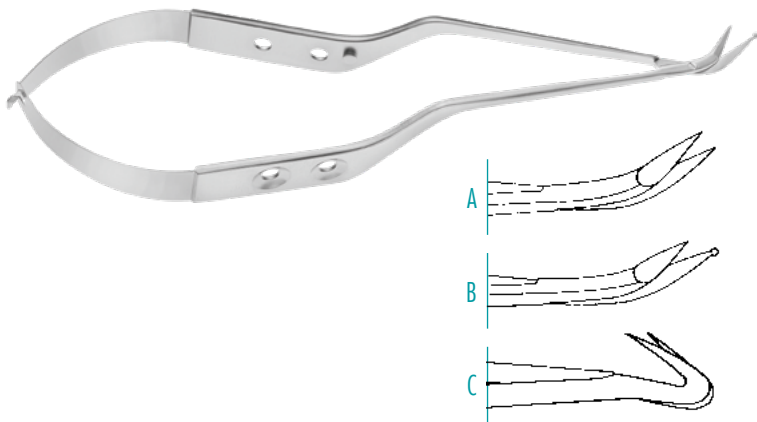

NAGEL

A Micro Scissors, 45°

200mm, 8" 250-064-056

B 45°, with probe-pointed blade

200mm, 8" 250-064-057

C 125°

190mm, 7^{1/2}" 250-064-059

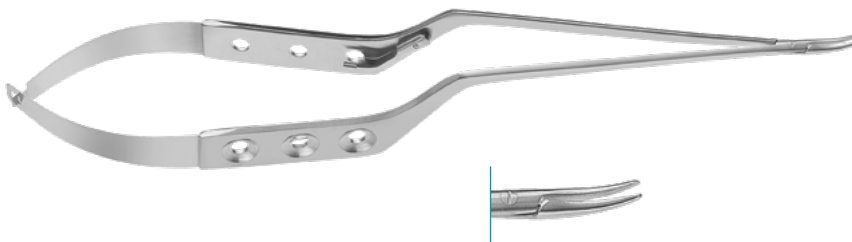

YASARGIL

Micro Needle Holder, straight

165mm, 6^{1/2}" 250-064-089

200mm, 8" 250-064-092

225mm, 8^{7/8}" 250-064-096

curved

165mm, 6^{1/2}" 250-064-089

200mm, 8" 250-064-093

225mm, 8^{7/8}" 250-064-097

245mm, 9^{2/3}" 250-064-099

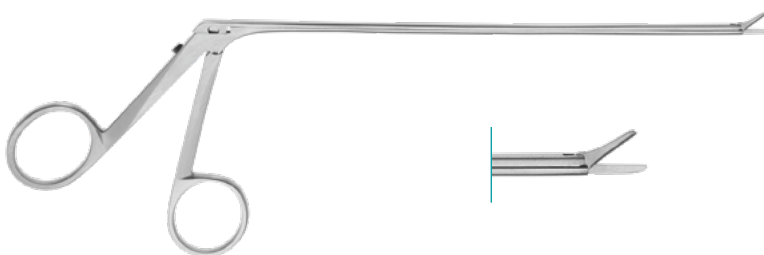

DECKER

Micro Scissors, fine model, 5mm

150mm, 6"

straight 250-066-601

left curved 250-066-602

right curved 250-066-603

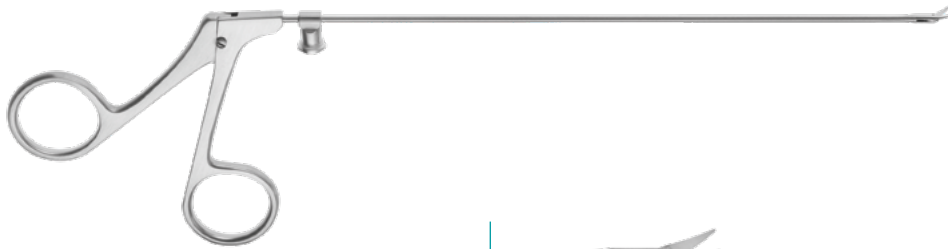

Micro Instruments with Luer-Lock
160mm, 6^{1/4}" working length

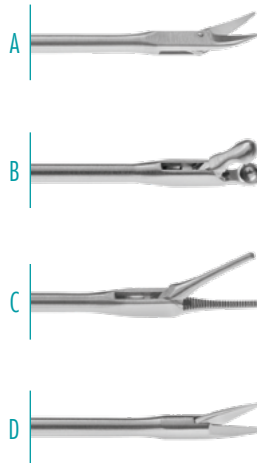

A FAHLBUSCH
Micro Scissors

250-064-223

B NICOLA
Micro Forceps, Ø 2.5mm

250-064-222

C YASARGIL NICOLA
Micro Grasping Forceps, 1mm conical jaw

250-064-224

D NICOLA
Micro Scissors, straight

250-064-226

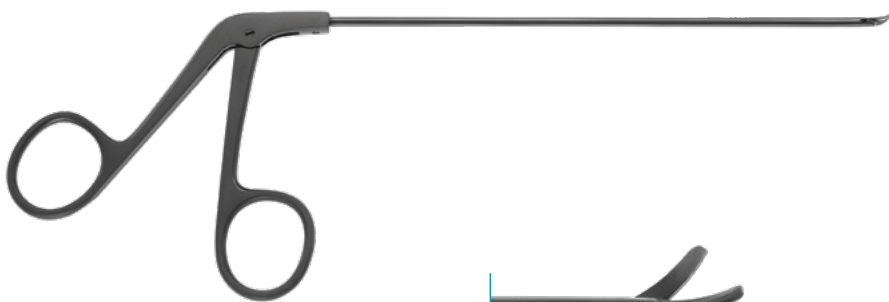

Micro Spinal Scissors
150mm, 6" working length, black coated,
2mm, curved

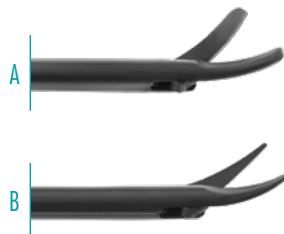

A blunt 250-000-033

B sharp 250-000-034

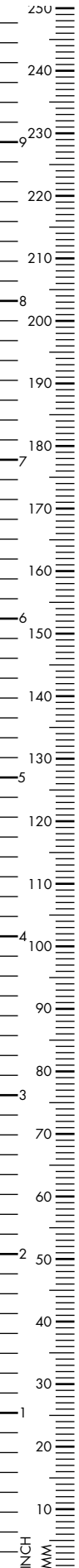



Titanium Micro Needle Holder, straight, with box catch, 1mm diamond dusted jaw, 8mm round handle

210mm, 8 ¹ / ₄ "	250-218-210
--	-------------



Micro Needle Holder, without catch, 160mm, 6¹/₄" working length

straight	250-069-076
----------	-------------

curved	250-069-079
--------	-------------

180mm, 7" working length

straight	250-069-080
----------	-------------

curved	250-069-081
--------	-------------



Micro Needle Holder, diamond dusted without catch, 160mm, 6¹/₄" working length

straight	250-269-076
----------	-------------

curved	250-269-079
--------	-------------

180mm, 7" working length

straight	250-269-080
----------	-------------

curved	250-269-081
--------	-------------

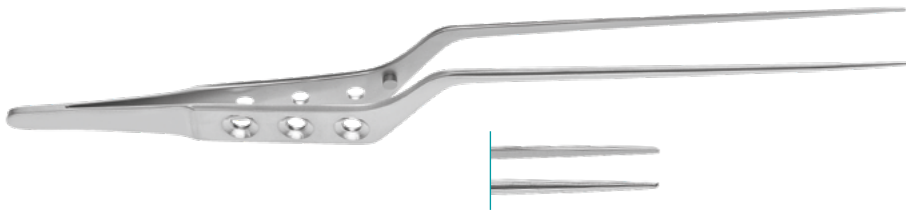
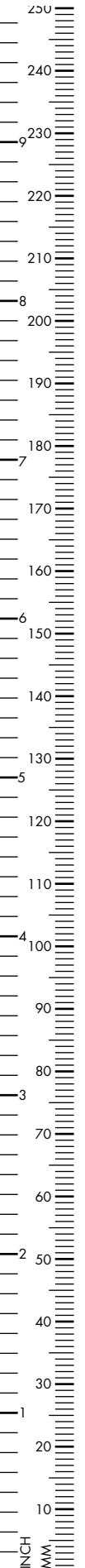

YASARGIL

Micro Forceps, 0.6mm tip

160mm, 6 ¹ / ₄ "	250-024-830
180mm, 7"	250-024-835
200mm, 8"	250-024-840
220mm, 8 ² / ₃ "	250-024-845
240mm, 9 ¹ / ₂ "	250-024-850

0.9mm tip

160mm, 6 ¹ / ₄ "	250-024-831
180mm, 7"	250-024-836
200mm, 8"	250-024-841
220mm, 8 ² / ₃ "	250-024-846
240mm, 9 ¹ / ₂ "	250-024-851

1x2 teeth

180mm, 7"	250-024-837
-----------	-------------

YASARGIL

A Micro Grasping Forceps Ø 3mm

220mm, 8 ² / ₃ "	250-064-210
--	-------------

B Ø 5mm

220mm, 8 ² / ₃ "	250-064-212
--	-------------

C Ø 3mm, flat jaw, serrated

220mm, 8 ² / ₃ "	250-064-214
--	-------------

D Ø 5mm, flat jaw, serrated

220mm, 8 ² / ₃ "	250-064-216
--	-------------

YASARGIL SAMII

E Ø 3mm, spoon-shaped

240mm, 9 ¹ / ₂ "	250-064-200
--	-------------

F Ø 5mm, spoon-shaped

240mm, 9 ¹ / ₂ "	250-064-202
--	-------------

G Ø 7mm, spoon-shaped

240mm, 9 ¹ / ₂ "	250-064-204
--	-------------

HEIFETZ

H Ø 3mm, curette jaw, toothed

220mm, 8 ² / ₃ "	250-064-215
--	-------------

I Ø 5mm, curette jaw, toothed

220mm, 8 ² / ₃ "	250-064-217
--	-------------

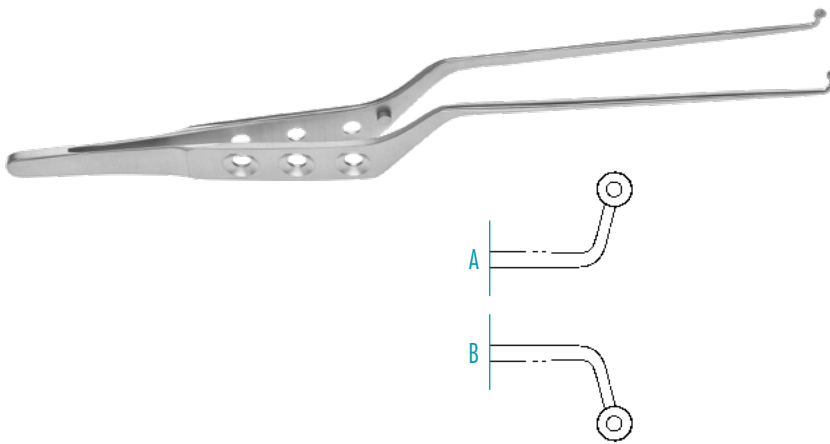

SAMII

A Micro Grasping Forceps, 230mm, 9" left angled

Ø 3mm	250-064-190
Ø 4mm	250-064-191
Ø 5mm	250-064-192

B right angled

Ø 3mm	250-064-195
Ø 4mm	250-064-196
Ø 5mm	250-064-197

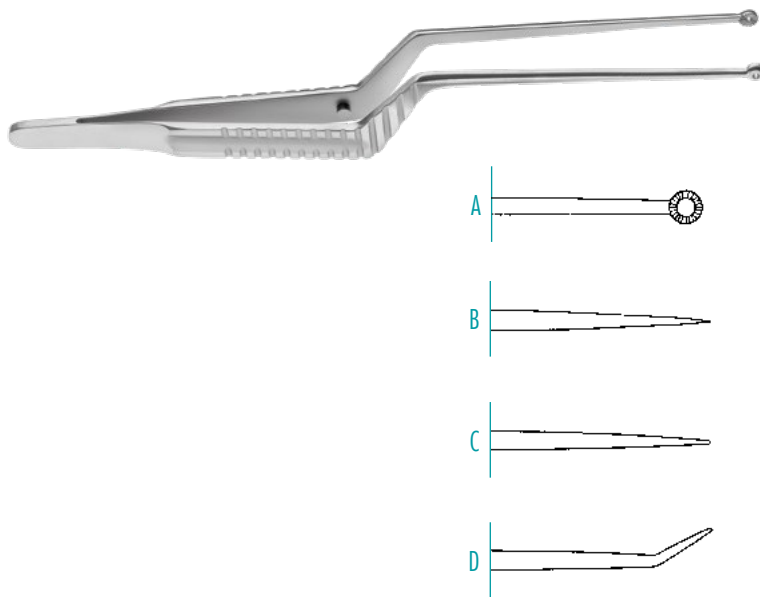

HUNT

A Tumor Tissue Forceps, Ø 5mm flat jaw, serrated, straight

200mm, 8"	250-024-766
-----------	-------------

B fine tip

185mm, 7 ^{1/4} "	250-064-110
---------------------------	-------------

C broad tip

185mm, 7 ^{1/4} "	250-064-111
---------------------------	-------------

D broad tip, angled

185mm, 7 ^{1/4} "	250-064-112
---------------------------	-------------



HUNT

Tumor Tissue Forceps, Ø 5mm serrated jaw

200mm, 8"	250-024-765
-----------	-------------

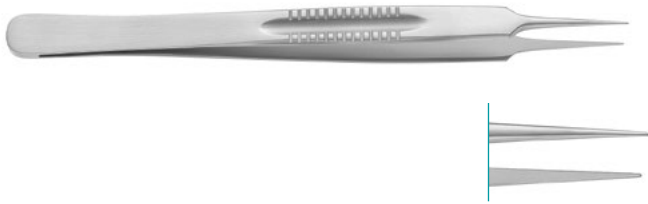
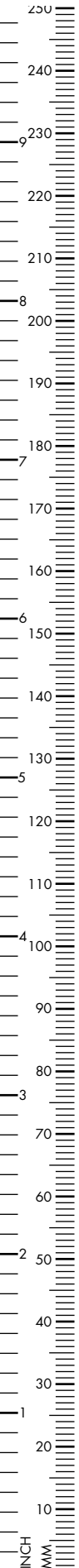

LAZAR

Micro Suture Tying Forceps
155mm, 6^{1/8}"

0.5mm tip	250-024-260
0.8mm tip	250-024-261

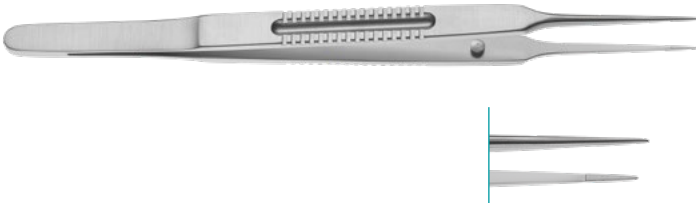

Micro Suture Tying Forceps
185mm, 7^{1/4}"

0.5mm tip	250-024-264
-----------	-------------

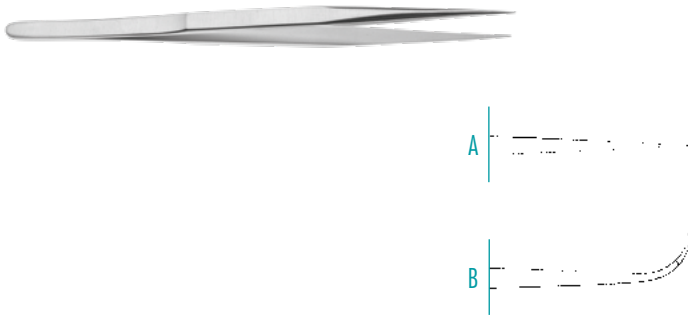

VISE

Micro Suture Tying Forceps
A straight, 0.3mm tip

120mm, 4 ^{3/4} "	250-024-338
135mm, 5 ^{1/3} "	250-024-336

B curved, 0.3mm tip

135mm, 5 ^{1/3} "	250-024-337
---------------------------	-------------

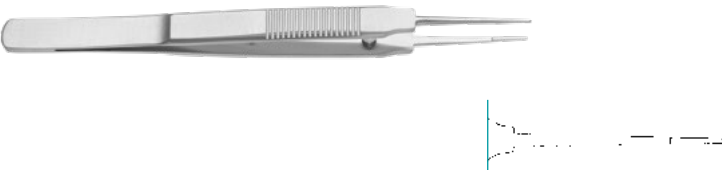

AUSTIN

Micro Suture Tying Forceps,
0.8mm tip

140mm, 5 ^{1/2} "	250-024-340
180mm, 7"	250-024-342

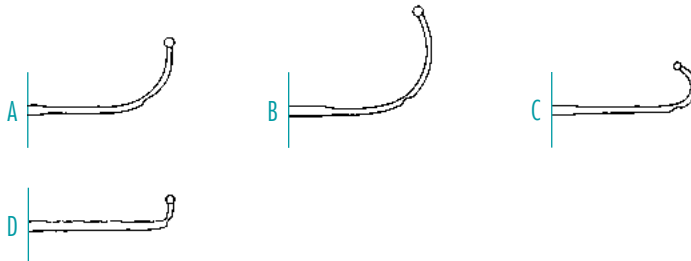

YASARGIL

Ligature Guide, 185mm, 7¹/₄"

A	250-064-270
B	250-064-271
C	250-064-272
D	250-064-273

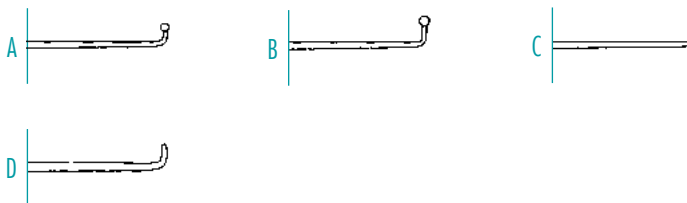

KRAYENBÜHL

Nerve / Vessel Hook, 185mm, 7¹/₄"

A	250-064-396
B	250-064-397
C	250-064-398
D	250-064-399

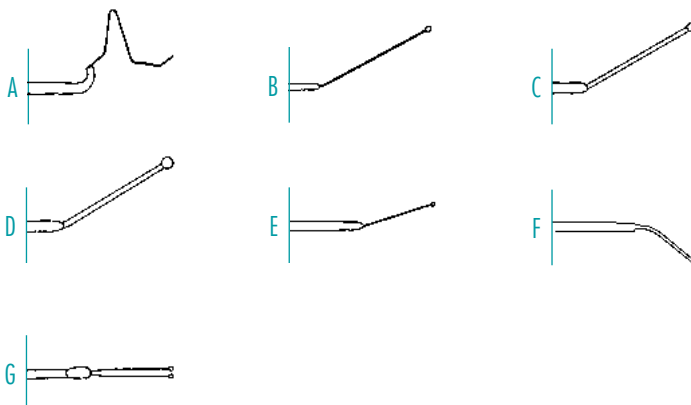

BIEMER

A Vessel Spreader,

160mm, 6¹/₄" 250-064-310

Vessel Dilator, 125mm, 5"

B Ø 0.5mm	250-064-306
C Ø 1.0mm	250-064-307
D Ø 1.5mm	250-064-308

JACOBSON

Vessel Probe, 185mm, 7¹/₄"

E	250-064-311
F	250-064-313
G	250-064-312

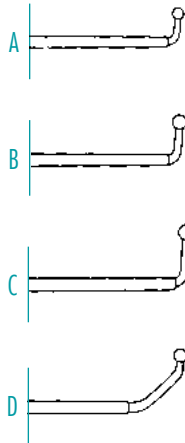
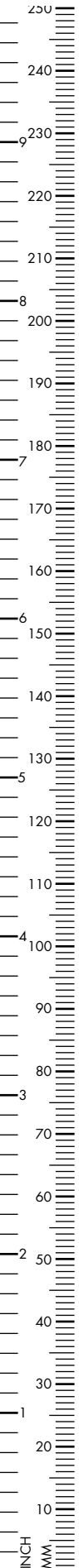

CASPAR

Exploration / Coagulation Hook,
245mm, 9²/₃" , insulated

A	250-020-088
B	250-020-089
C	250-020-090
D	250-020-091

non-insulated

A	250-010-088
B	250-010-089
C	250-010-090
D	250-010-091

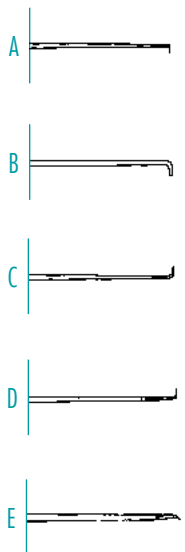

Micro Hook, 90°, 230mm, 9"

A sharp	250-064-330
B blunt	250-064-331

FISCH

90°, sharp, 185mm, 7¹/₄"

C curved	250-064-375
D angled	250-064-376

JACOBSON

Micro Vessel Knife, 185mm, 7¹/₄"

E	250-064-350
---	-------------



Tissue Pick, Ø 1.8mm

185mm, 7 ¹ / ₄ "	250-064-392
--	-------------



FRAZIER

Dura Hook, sharp

130mm, 5^{1/8}"

170-013-130



O'CONNOR

Nerve Hook, sharp

120mm, 4^{3/4}"

170-040-160



DANDY

Nerve Hook, 3mm, 200mm, 8"

straight 250-746-000

right curved 250-746-001

left curved 250-746-002

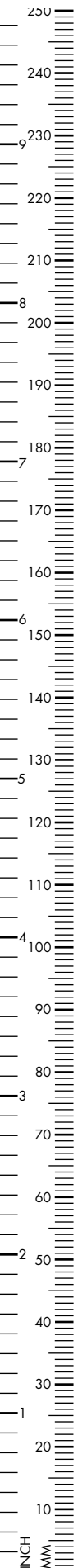

COTTLE

Nerve Hook, 168mm, 6²/₃"

180° retrograde curved	230-286-160
120° retrograde curved	230-285-160



SACHS

Dura Hook

185mm, 7 ¹ / ₄ "	250-403-185
--	-------------



SMITHWICK

Nerve Hook

170mm, 6 ² / ₃ "	250-507-170
--	-------------



GRAHAM

Dura Hook

165mm, 6 ¹ / ₂ "	250-405-160
--	-------------



CUSHING

Nerve Hook, 190mm, 7¹/₂"

small	170-060-001
-------	-------------

large	170-060-002
-------	-------------



ADSON

Dura Hook, 200mm, 8"

blunt	250-407-200
-------	-------------

sharp	250-409-200
-------	-------------



WEARY

Nerve Hook, fine, blunt, black coated

200mm, 8"	250-408-200
-----------	-------------

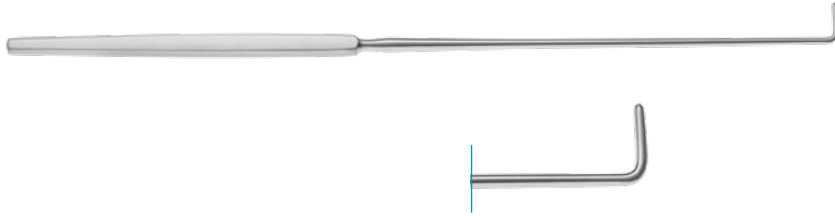
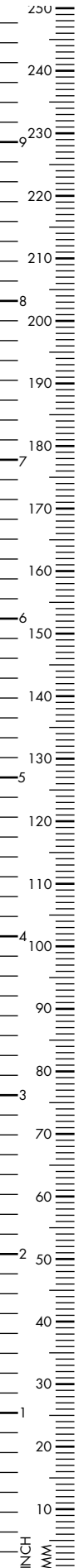

HOEN

Hook, 90°

220mm, 8^{2/3}"

250-747-220

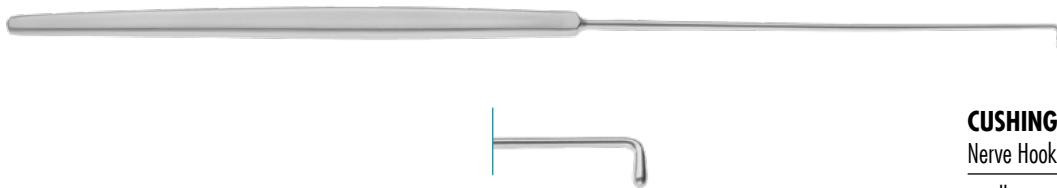

CUSHING

Nerve Hook, 280mm, 11"

small

250-742-280

large

250-743-280

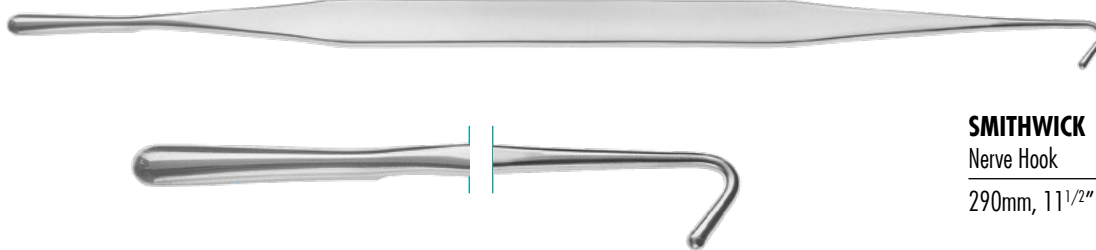

SMITHWICK

Nerve Hook

290mm, 11^{1/2}"

250-507-290

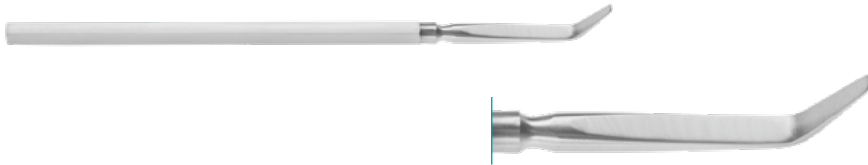

FRAZIER

Elevator

160mm, 6¹/₄"

250-746-150

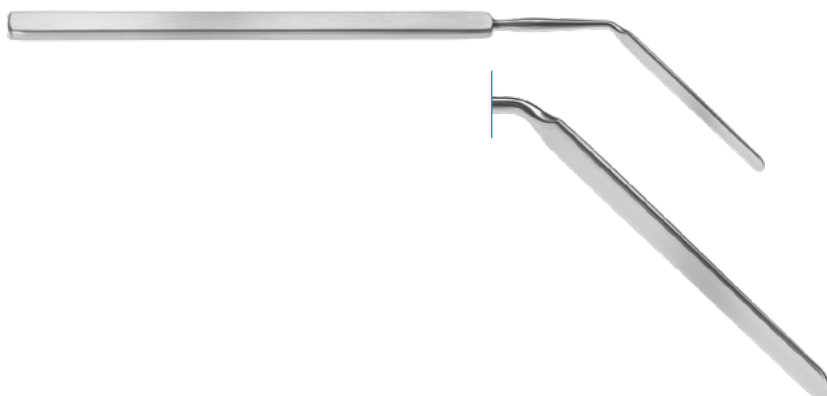

HORSLEY

Dissector, angled

200mm, 8"

250-750-200



HOEN

Elevator, 150mm, 6"

45°

250-747-150

90°

250-747-153

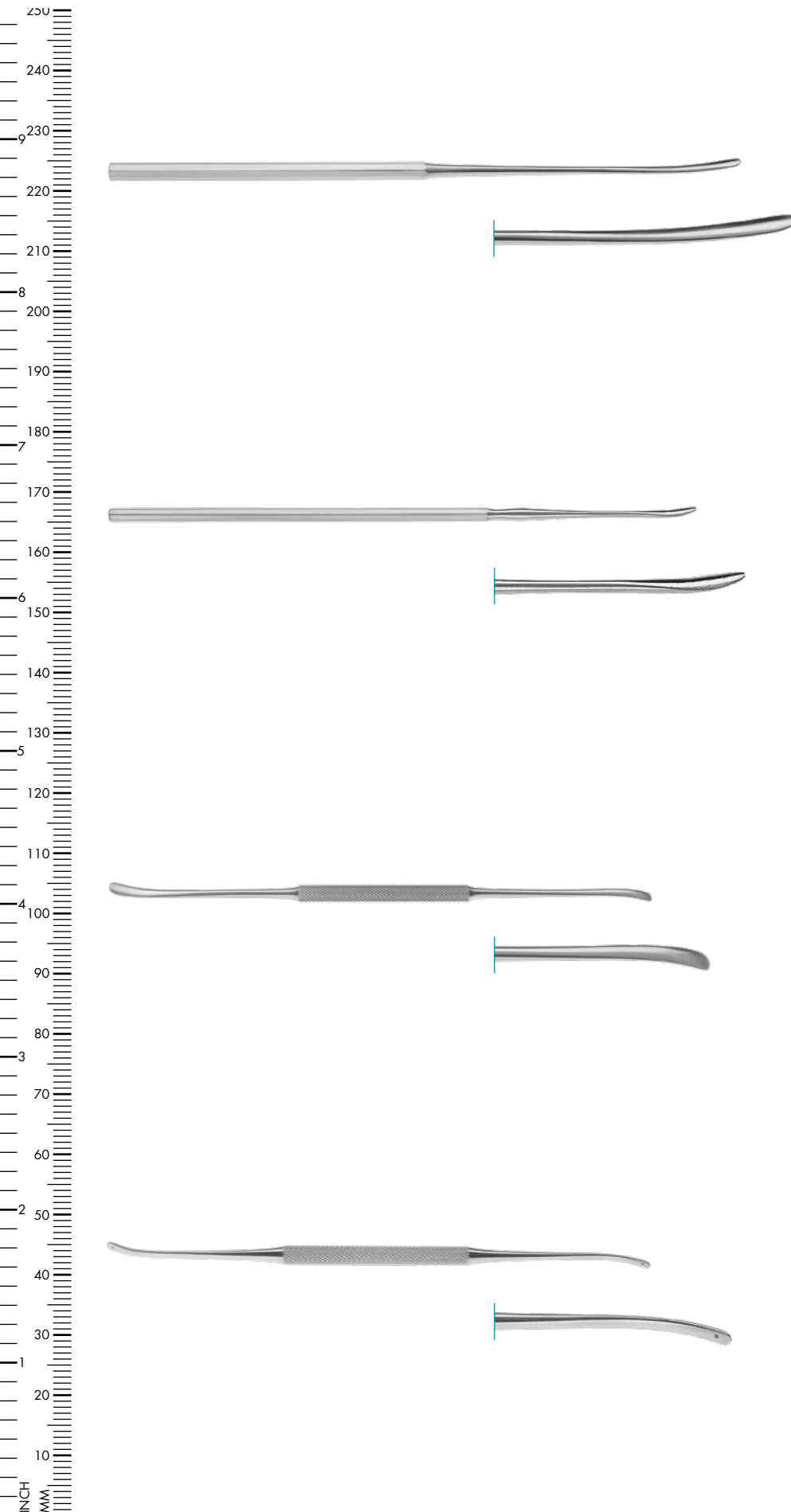

SACHS

Dissector, sharp

210mm, 8¹/₄"

250-687-210

DAVIS

Dissector

195mm, 7³/₄"

250-696-195

OLIVECRONA

Dissector, double-ended

4 x 5mm, heavy pattern

180mm, 7"

250-694-180

240mm, 9¹/₂"

250-694-240

OLIVECRONA

Dissector, double-ended, fenestrated tip,

2 x 3mm

180mm, 7"

250-696-180

240mm, 9¹/₂"

250-696-240

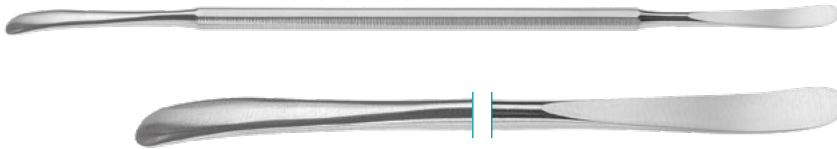

Dissector, double ended

220mm, 8²/₃"

290-500-220

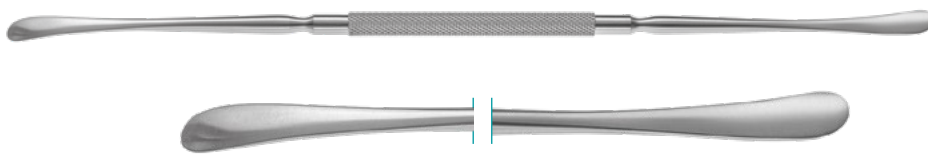

DAVIS

Vascular Dissector, double ended

245mm, 9²/₃"

290-300-245

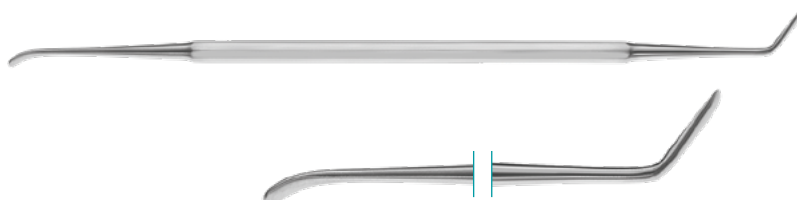

MILLIGAN

Dura Dissector, double ended

210mm, 8¹/₄"

250-685-210

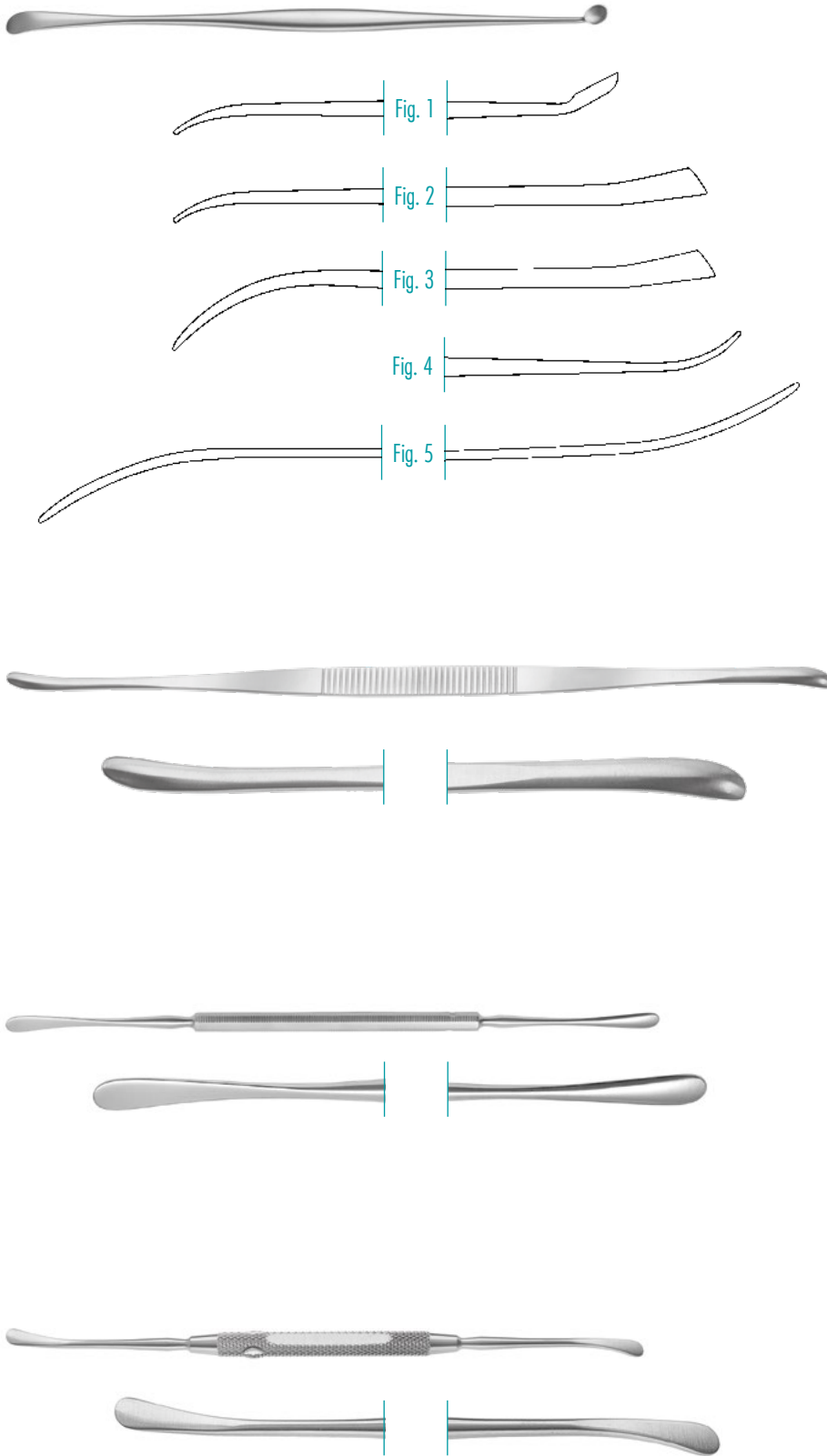
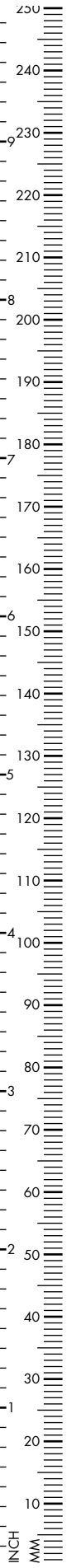

PENFIELD

Dissector

Fig. 1	175mm, 6 ⁷ / ₈ "	250-691-175
Fig. 2	195mm, 7 ³ / ₄ "	250-692-195
Fig. 3	195mm, 7 ³ / ₄ "	250-693-195
Fig. 4	215mm, 8 ¹ / ₂ "	250-694-215
Fig. 5	290mm, 11 ¹ / ₂ "	250-695-290

TOENNIS

Dissector, blunt/blunt

Fig. 1	3+4mm	250-301-240
Fig. 2	5+6mm	250-302-240

FREER

Septum Elevator, sharp/blunt, 200mm, 8"

4.5mm	420-545-001
6.5mm	420-545-002

FREER

Septum Elevator, sharp/blunt, 5mm

185mm, 7 ¹ / ₄ "	420-546-180
--	-------------

T_i

Nerve Micro Dissection Instruments, Titanium
190mm, 7¹/₂"



↑Scale 1:2

↓Scale 3:1 (A - S)

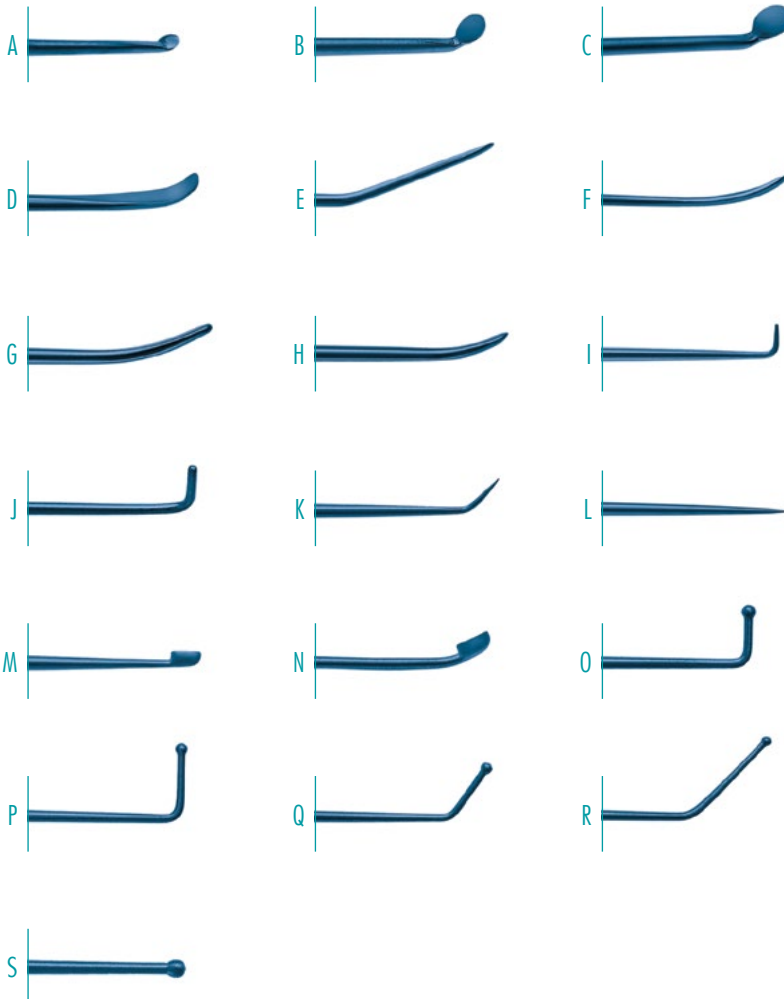

A round, Ø 1mm	250-501-190
B round, Ø 2mm	250-502-190
C round, Ø 3mm	250-503-190
D curved, 2.8mm	250-514-190
E angled, 1.2mm	250-515-190
F narrow, 1.0mm	250-517-190
G medium, 1.5mm	250-518-190
H wide, 2.0mm	250-519-190
I 90°, semi-sharp	250-520-190
J 90°, blunt	250-521-190
K 45°, semi-sharp	250-522-190
L straight, sharp	250-523-190
M straight, 1x2mm	250-524-190
N angled, 1x2mm	250-525-190
O 90°, 3mm	250-526-190
P 90°, 5mm	250-527-190
Q 45°, 4mm	250-528-190
R 45°, 8mm	250-529-190
S straight	250-530-190
T Set (+Tray)	250-501-001

Stainless Steel

A round, Ø 1mm	250-101-190
B round, Ø 2mm	250-102-190
C round, Ø 3mm	250-103-190
D curved, 2.8mm	250-114-190
E angled, 1.2mm	250-115-190
F narrow, 1.0mm	250-117-190
G medium, 1.5mm	250-118-190
H wide, 2.0mm	250-119-190
I 90°, blunt, 2.3mm	250-120-190
J 90°, blunt, 2.9mm	250-121-190
K 45°, semi-sharp	250-122-190
L straight, sharp	250-123-190
M straight, 1x2mm	250-124-190
N angled, 1x2mm	250-125-190
O 90°, 3mm	250-126-190
P 90°, 5mm	250-127-190
Q 45°, 4mm	250-128-190
R 45°, 8mm	250-129-190
S straight	250-130-190
T Set (+tray)	250-101-001

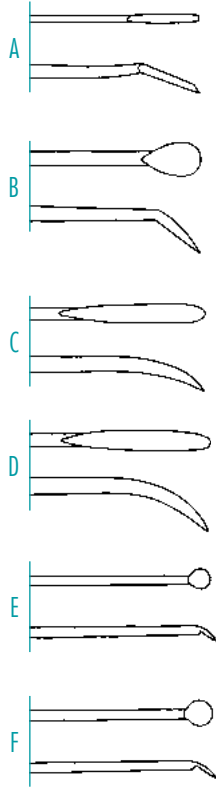
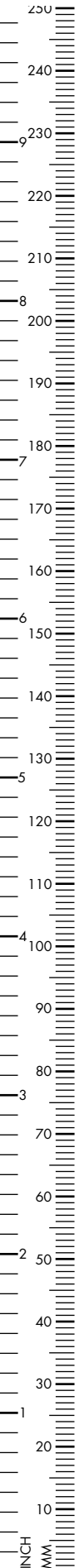

YASARGIL

Micro Raspatory, 185mm, 7¹/₄"

A	250-064-301
B	250-064-303
C	250-064-304
D	250-064-305

Micro Raspatory, round blade,
230mm, 9"

E	250-064-337
F	250-064-338

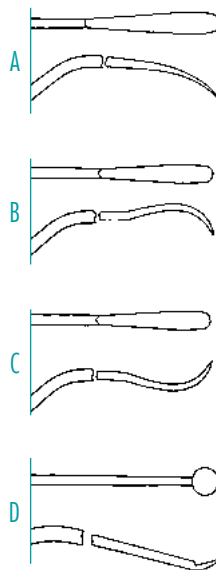

YASARGIL

Micro Raspatory, 185mm, 7¹/₄"

A	250-064-320
B	250-064-321
C	250-064-322

Micro Raspatory, 230mm, 9"

D	250-064-346
---	-------------

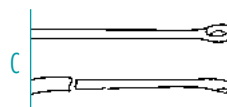
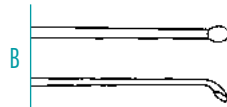
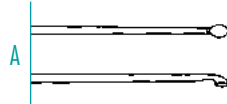

Micro Scoop, 230mm, 9"

A 250-064-335

B 250-064-336

YASARGIL

Micro Raspatory, bayonet-shape, 185mm, 7¹/₄"

C 250-064-325

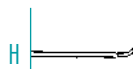
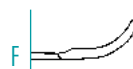
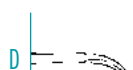
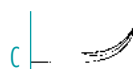
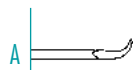

KOOS

Micro Vessel Knife, 185mm, 7¹/₄"

A 250-064-351

B 250-064-352

C 250-064-353

D 250-064-354

E 250-064-356

F 250-064-357

YASARGIL

G 250-064-365

H 250-064-366

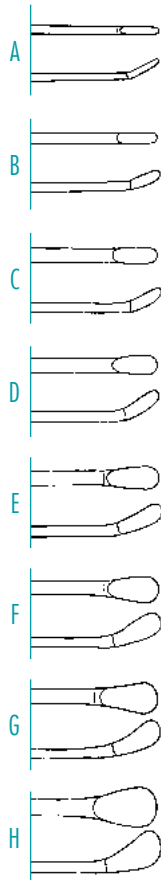
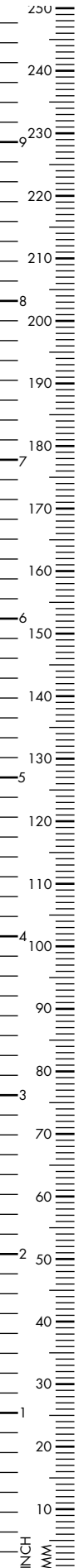

SAMII

Tumor Knife, 200mm, 8"

A 1.0mm	250-064-400
B 1.5mm	250-064-401
C 2.0mm	250-064-402
D 2.5mm	250-064-403
E 3.0mm	250-064-404
F 3.5mm	250-064-405
G 4.0mm	250-064-406
H 5.0mm	250-064-408

230mm, 9"

A 1.0mm	250-064-410
B 1.5mm	250-064-411
C 2.0mm	250-064-412
D 2.5mm	250-064-413
E 3.0mm	250-064-414
F 3.5mm	250-064-415
G 4.0mm	250-064-416
H 5.0mm	250-064-418

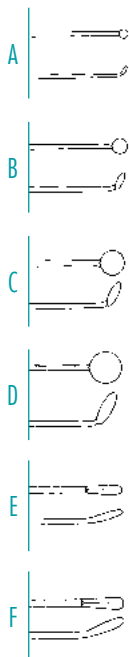

SAMII

Tumor Knife, 200mm, 8"

A 1.5mm	250-064-851
B 3.0mm	250-064-854
C 4.5mm	250-064-856
D 6.0mm	250-064-858

230mm, 9"

A 1.5mm	250-064-861
B 3.0mm	250-064-864
C 4.5mm	250-064-866
D 6.0mm	250-064-868
E 1.8mm	250-064-298
F 2.5mm	250-064-299

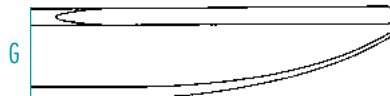
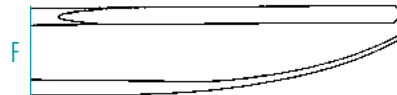
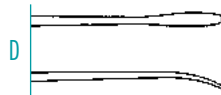
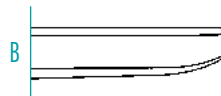
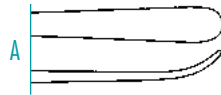

CASPAR

Micro Dissector, 230mm, 9"

A 4.5mm 250-066-303

C 1.4mm 250-064-332

D 2.0mm 250-064-333

E 1.8mm 250-064-334

185mm, 7¹/₄"

F 3.0mm 250-062-150

200mm, 8"

B 1.0mm 250-066-310

215mm, 8¹/₂"

G 3.0mm 250-062-151

YASARGIL

185mm, 7¹/₄"

H 250-064-302

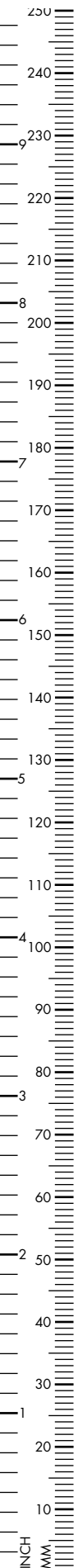

A Nerve Hook, 262mm, 10^{1/4}" bayonet length, black coated, 125mm, 5" working length

left	250-000-043
straight	250-000-042
right	250-000-044



B Micro Nerve Hook

left	250-000-046
straight	250-000-045
right	250-000-047



C Dissector

left	250-000-049
straight	250-000-048
right	250-000-050



A Probe, 269mm, 10^{2/3}" bayonet length, black coated, 125mm, 5" working length

WOODSON	250-000-035
----------------	-------------



B Hook, short, 6mm

left	250-000-037
straight	250-000-036
right	250-000-038



C Hook, long, 9mm

left	250-000-040
straight	250-000-039
right	250-000-041



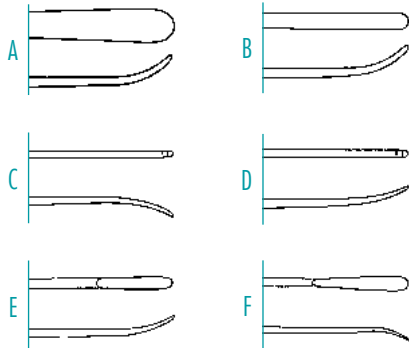

CASPAR

Micro Dissector, 230mm, 9"

A 4.5mm 250-066-305

B 2.0mm 250-066-307

210mm, 8^{1/4}"

C 1.0mm 250-066-311

D 1.0mm 250-066-312

Micro Dissector, 230mm, 9"

E 250-064-343

F 250-064-344

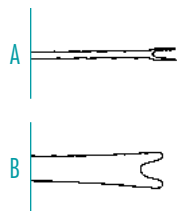

JACOBSON

A Suture Pusher

185mm, 7^{1/4}" 250-064-315

CASPAR

B Suture Pusher, bayonet-shape

230mm, 9" 250-066-309

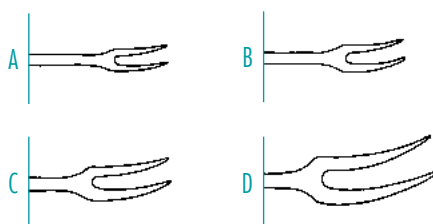

OKONEK YASARGIL

Tumor Fork, 230mm, 9"

A 3.0mm 250-064-380

B 2.0mm 250-064-381

C 5.0mm 250-064-382

D 8.0mm 250-064-384

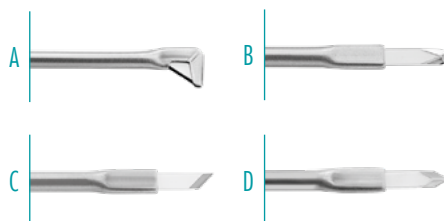

Diamond Knife, 7 facets, single sided

1.0 x 0.17mm, 205mm, 8^{1/8}"

A hook 1.4 x 0.17mm 250-001-100

B round 250-001-101

C straight, 45° 250-001-102

D lancet, 60° 250-001-103

LEYLAR RETRACTOR SYSTEM



YASARGIL

Retractor, 1 flexible arm, self-retaining, flexible, complete set consisting of:
 Fixation (250-066-267)
 Flexible Arm (250-066-270)
 Flat Spatula Holder (250-066-271)

250-066-260

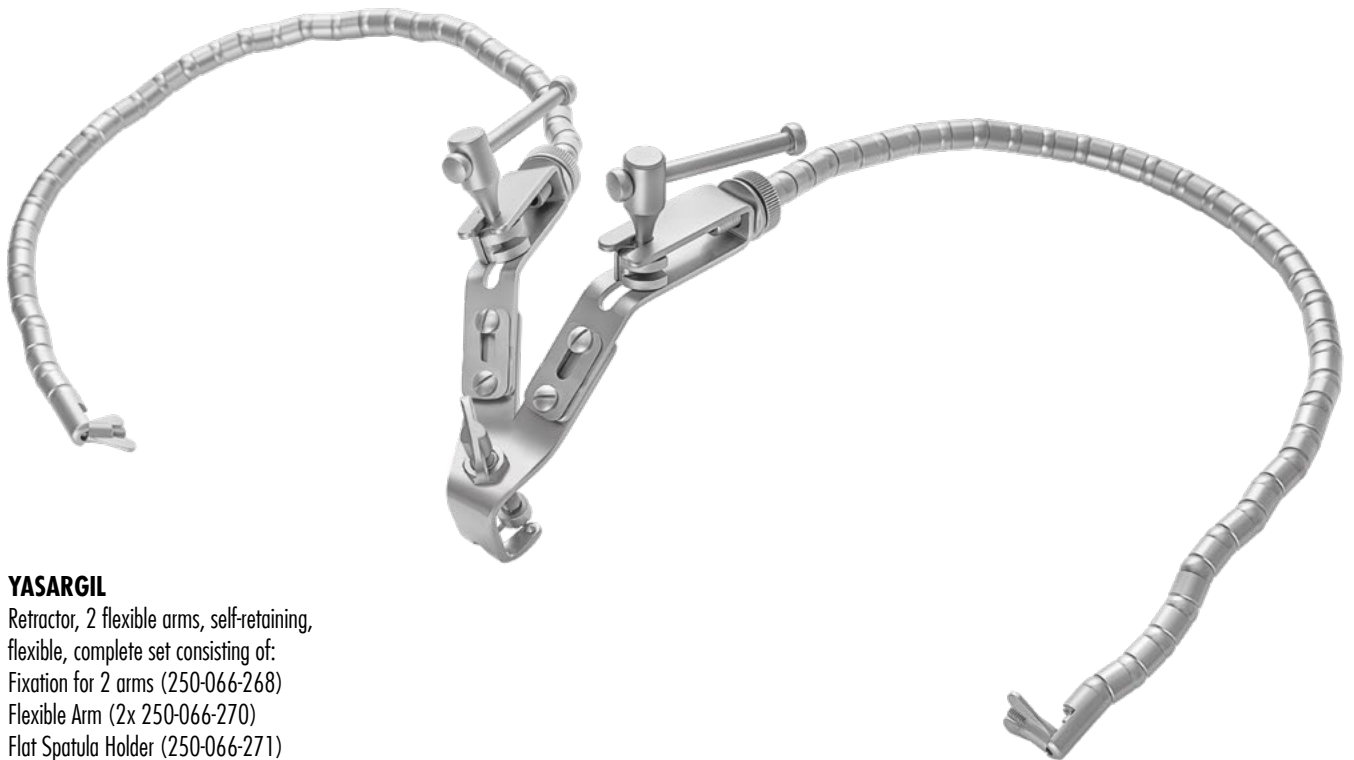

YASARGIL

Retractor, 2 flexible arms, self-retaining, flexible, complete set consisting of:
 Fixation for 2 arms (250-066-268)
 Flexible Arm (2x 250-066-270)
 Flat Spatula Holder (250-066-271)

250-066-262

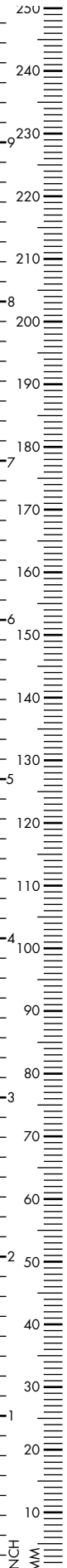

LEYLAR RETRACTOR SYSTEM

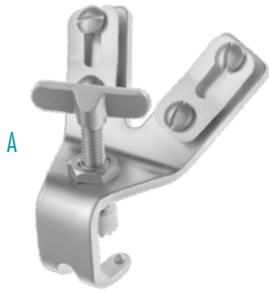

A



B



C

Fixation

A for 2 arms (skull)	250-066-268
B for 1 arm (skull)	250-066-267
C for 1 arm (base)	250-066-266



A

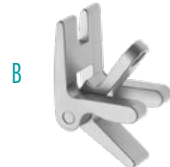

B

YASARGIL

Spatula Holder

A for round shaft	250-066-272
B for flat Spatula	250-066-271



YASARGIL

Spatula, malleable

200 x 9mm	250-066-220
200 x 12mm	250-066-221
250 x 12mm	250-066-222



Spatula, malleable

200 x 14mm	250-066-231
200 x 17mm	250-066-232
200 x 20mm	250-066-233



HEIFETZ

Spatula, malleable

155 x 8mm	250-066-256
155 x 11mm	250-066-257
155 x 14mm	250-066-258
155 x 17mm	250-066-259

LEYLAR RETRACTOR SYSTEM

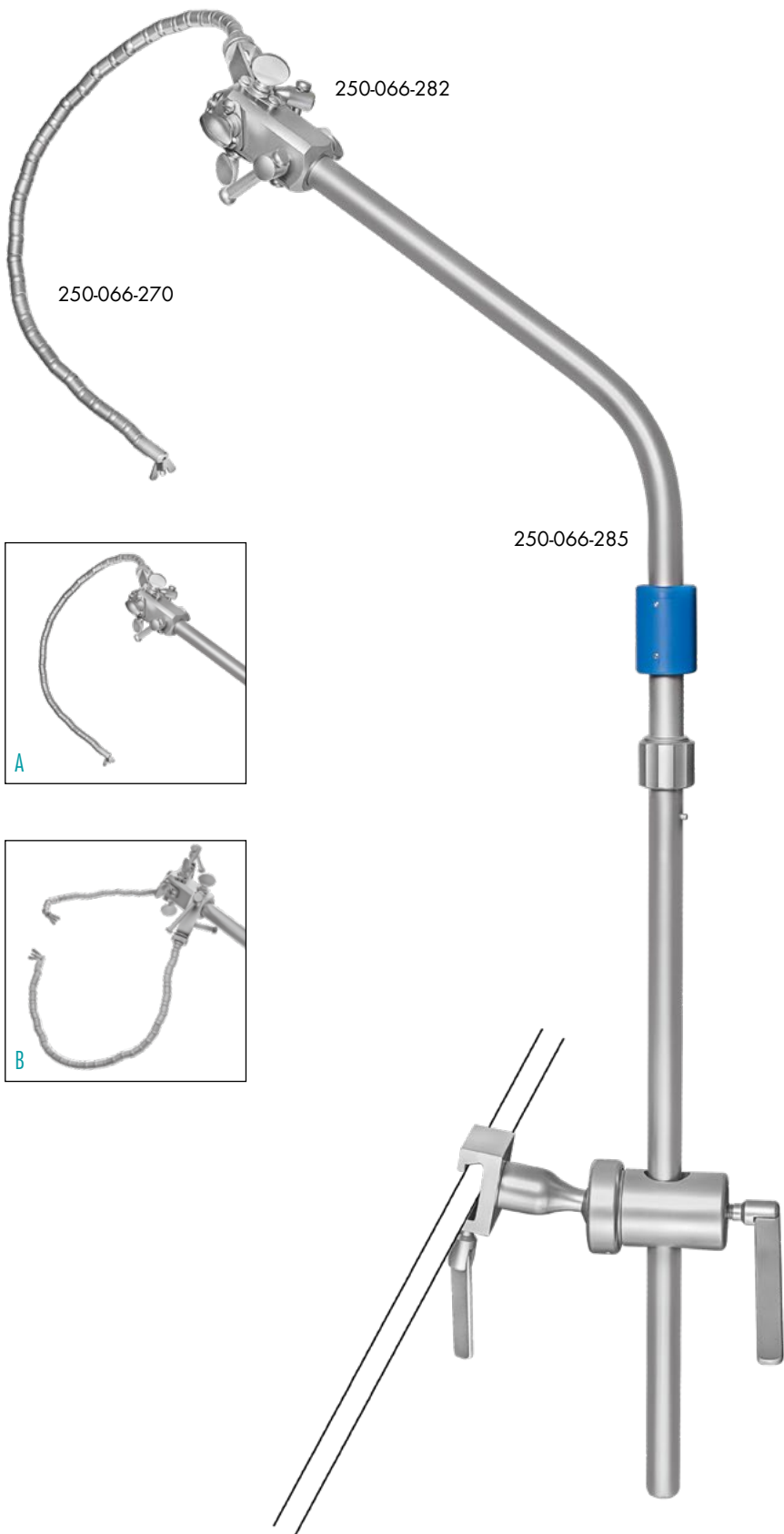

A 250-066-287

LEYLAR

Retractor Set,
1 Arm for fixation to/or table siderails
consisting of:

Ball and socket joint, articulated	250-066-280
Holding rod	250-066-285
Coupling head	250-066-282
Flexible Arm	250-066-270
Flat Spatula Holder	250-066-271

B 250-066-288

2 Arms
consisting of:

Ball and socket joint, articulated	250-066-280
Holding rod	250-066-285
Coupling head	250-066-282
Coupling head, rotatable	250-066-283
Fixation Base	250-066-266
Flexible Arm	250-066-270
Flat Spatula Holder	250-066-271

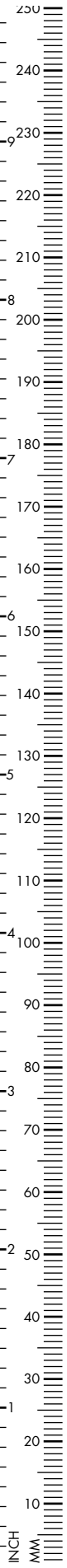



CUSHING

Spatula, 170mm, 6^{2/3}"

7 x 9mm	250-066-212
7 x 9mm CeraCut®	250-066-212CC
8 x 10mm	250-066-213
8 x 10mm CeraCut®	250-066-213CC

200mm, 8"

7 x 9mm	250-066-214
7 x 9mm CeraCut®	250-066-214CC

280mm, 11"

16 x 18mm	250-066-215
16 x 18mm CeraCut®	250-066-215CC



OLIVECRONA

Spatula, flexible, 180mm, 7"

7 x 9mm	250-066-216
11 x 13mm	250-066-217
15 x 18mm	250-066-218
18 x 22mm	250-066-219

CeraCut®

7 x 9mm	250-066-216CC
11 x 13mm	250-066-217CC
15 x 18mm	250-066-218CC
18 x 22mm	250-066-219CC



AACHEN

Spatula, 200mm 8"

7 x 8mm	250-066-441
11 x 11mm	250-066-442
13 x 14mm	250-066-443
16 x 17mm	250-066-444
19 x 20mm	250-066-445
22 x 25mm	250-066-446



SCOVILLE

Spatula, 203mm, 8"

13 x 9.5mm	250-066-202
19 x 16mm	250-066-203

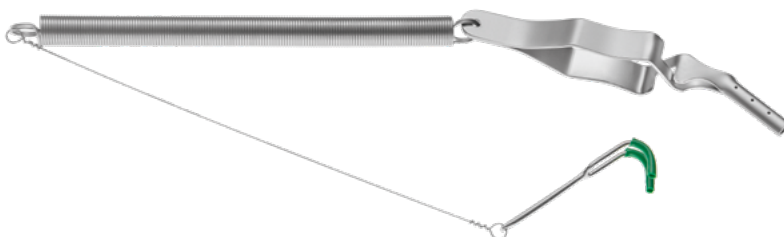

YASARGIL

Galea Hook, 310mm, 12^{1/4}"

Ø 7mm	250-066-020
410mm, 16"	
Ø 9mm	250-066-022

GRUENBERG RETRACTOR & HAND REST SYSTEM

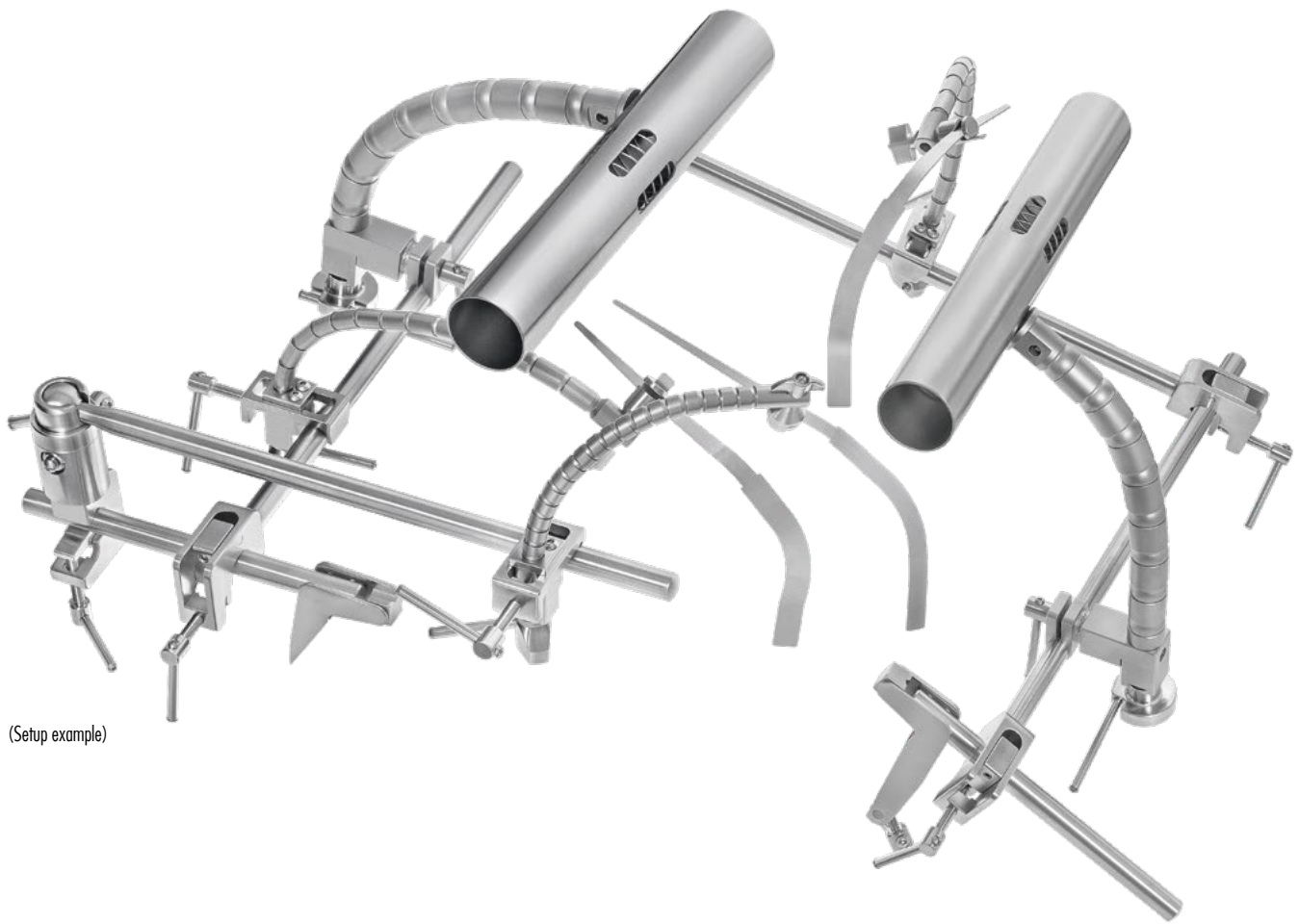

(Setup example)

250-050-150

GRUENBERG

Retractor Kit, consisting of:

Primary Bar (2x)	250-050-007
Secondary Bar (4x)	250-050-002
Large Arm Retractor (4x)	250-050-009
Blade 1.6 x 19mm (1x)	250-050-050
Blade 2.0 x 10mm (1x)	250-050-051
Blade 3.0 x 13mm (1x)	250-050-052
Blade 4.0 x 16mm (1x)	250-050-053
Blade 6.0 x 19mm (1x)	250-050-054
Hand Rest (1x)	250-050-012
Pattie Tray (1x)	250-066-513

GRUENBERG RETRACTOR & HAND REST SYSTEM

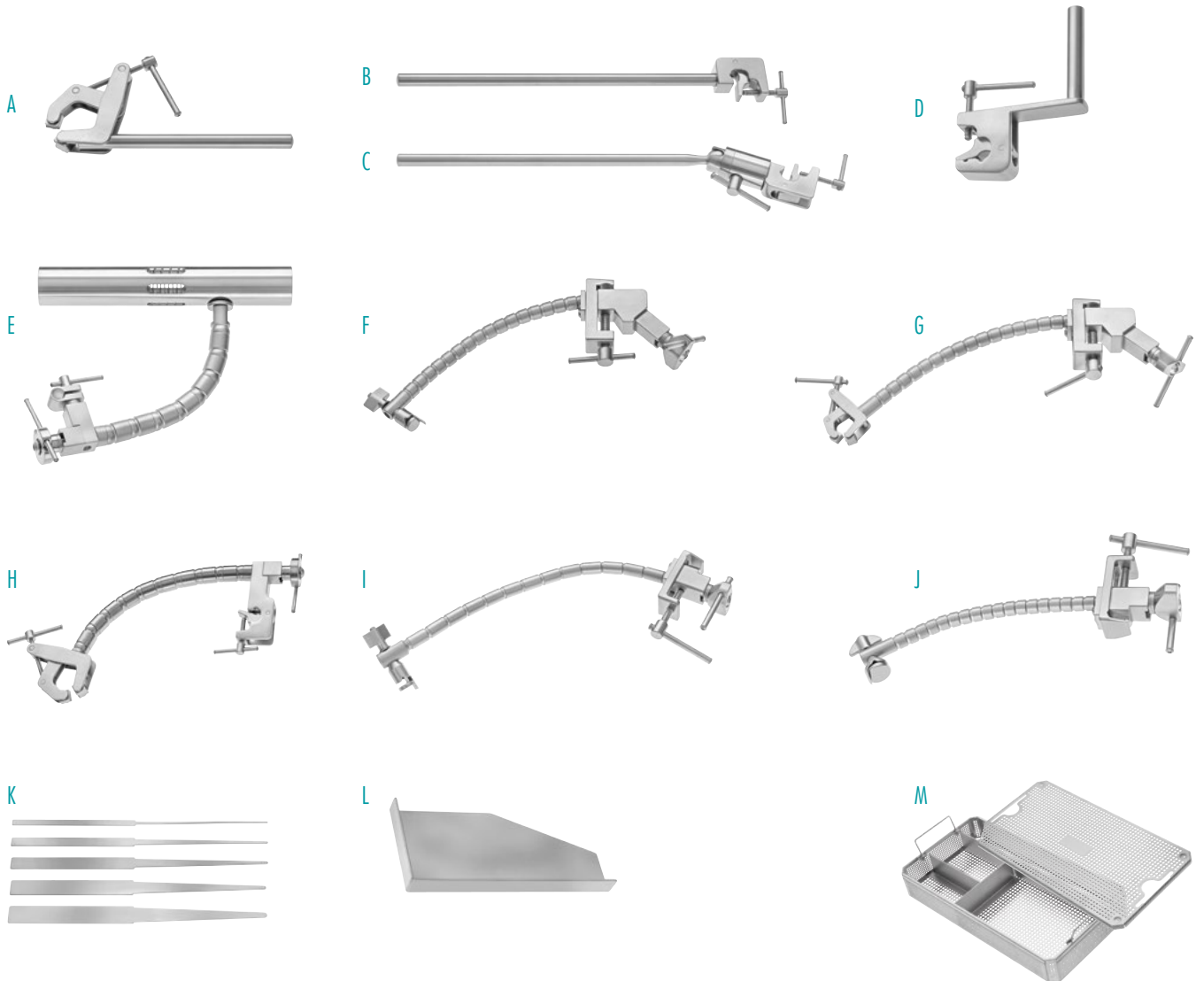

GRUENBERG

Single Parts

A	Primary Bar, 152mm	250-050-007	K	Blade, 1.6 x 19mm	250-050-050
B	Secondary Bar, 305mm	250-050-002		Blade, 2.0 x 10mm	250-050-051
C	Floating Secondary Bar	250-050-003		Blade, 3.0 x 13mm	250-050-052
D	Short Coupler	250-050-004		Blade, 4.0 x 16mm	250-050-053
E	Hand Rest	250-050-012		Blade, 6.0 x 19mm	250-050-054
F	Small Instrument Holder (up to 8mm)	250-050-030	L	Pattie Tray with towel clamps, 75 x 170 x 20mm	250-066-513
G	Large Instrument Holder (up to 25mm)	250-050-031	M	Sterilization Tray with 4 components, 480 x 253 x 70mm	600-050-514
H	Extra Large Instrument Holder (up to 51mm)	250-050-032			
I	Micro Instrument Holder (up to 3mm)	250-050-033			
J	Arm Retractor, short (165mm)	250-050-011			
	Arm Retractor, large (240mm)	250-050-009			



A MF Headrest System,
complete with skull clamp

Aluminium 250-140-100

B MF Headrest System,
with horseshoe headrest

Aluminium 250-140-105

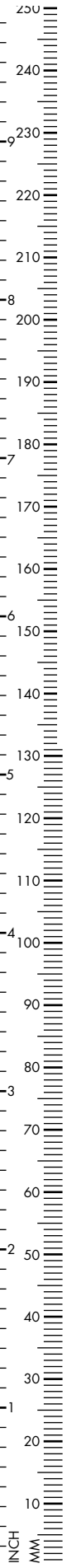

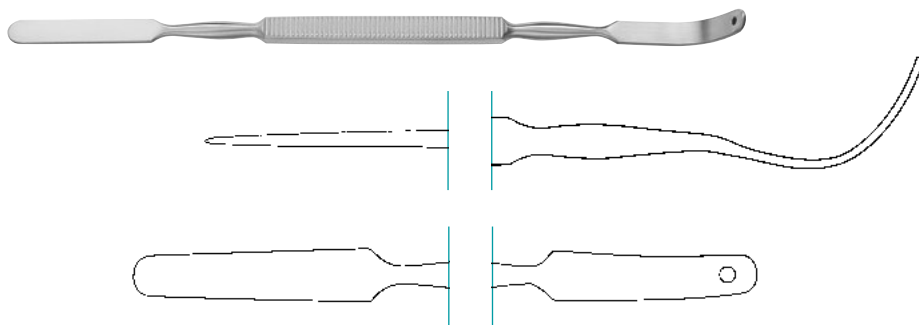

MCDONALD

Elevator, straight / curved

190mm, 7^{1/2}"

210-527-190

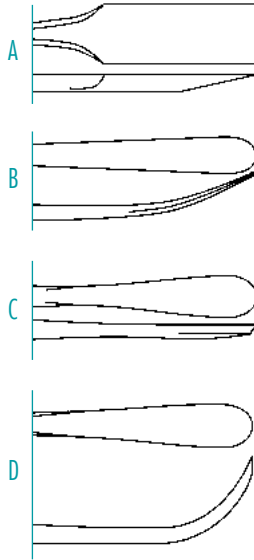

ADSON

Elevator, 8mm, 170mm, 6^{2/3}"

A straight, sharp 210-484-170

B curved, blunt 210-485-170

7mm

C straight, semi-sharp 210-486-170

D curved, semi-sharp 210-487-170

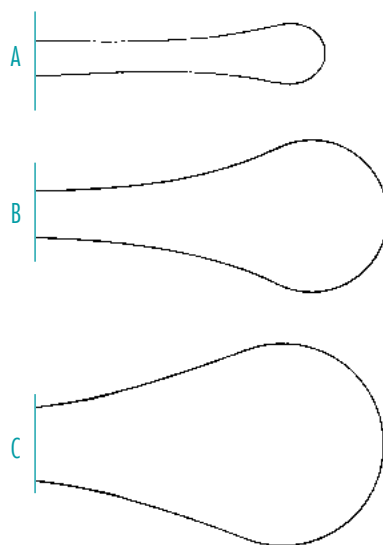

HOEN

Periosteal Elevator, 7mm

A 160mm, 6^{1/4}" 210-455-007

15mm

B 185mm, 7^{1/4}" 210-455-015

20mm

C 190mm, 7^{1/2}" 210-455-020



CUSHING

Periosteal Elevator
sharp end with rounded edge, 15mm

A	190mm, 7 ¹ / ₂ "	210-460-001
---	--	-------------

sharp end with square edge

B	190mm, 7 ¹ / ₂ "	210-460-003
---	--	-------------

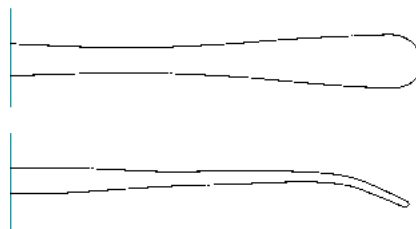

CUSHING LITTLE JOKER

Periosteal Elevator

150mm, 6"	210-488-150
-----------	-------------

190mm, 7 ¹ / ₂ "	210-488-190
--	-------------

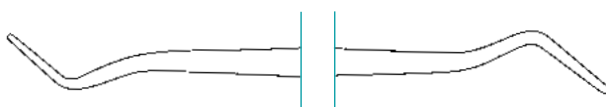

WOODSON

Elevator and Spatula, semi-sharp, 3mm,
flat end 4mm

254mm 10"	250-746-250
-----------	-------------



CLOWARD

Osteophyte Elevator, round handle,
90° curved tip, sharp

200mm, 8"

259-252-000

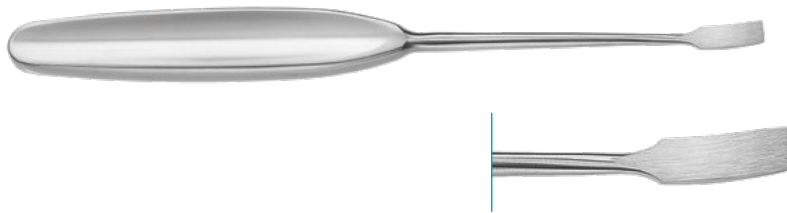

Periosteal Elevator
curved tip, 200mm, 8"

5.0mm

250-285-394

6.5mm

250-285-395

8.0mm

250-285-396

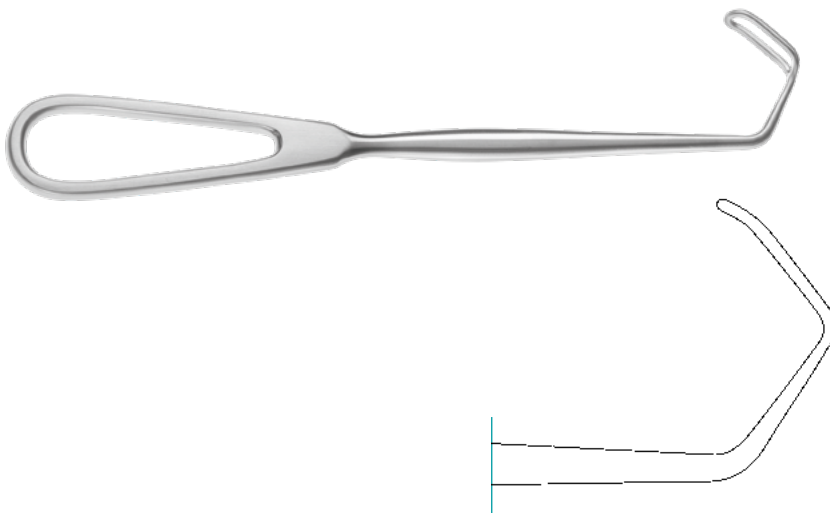

CUSHING

Retractor
22mm wide, open handle

210mm, 8^{1/4}"

170-237-210

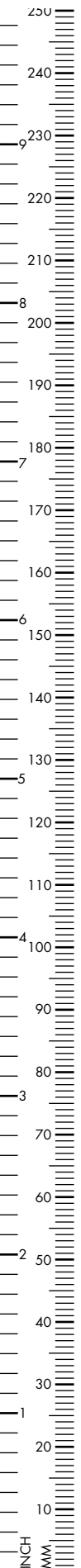



LOVE

Nerve Root Retractor
190mm, 7^{1/2}"

straight	250-694-190
45°	250-695-190
90°	250-697-190

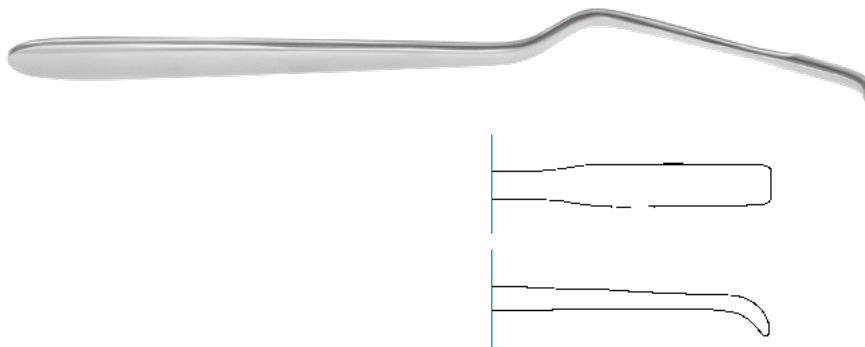

D'ERRICO

Nerve Spatula, bayonet shaped,
6mm wide

230mm, 9"	250-689-230
-----------	-------------

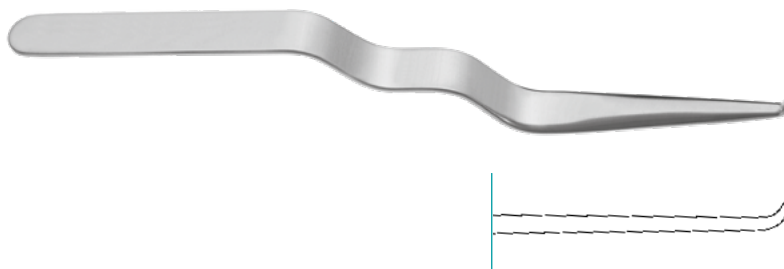

KRAYENBÜHL

Nerve Root Retractor
with guide groove, double bayonet shaped

210mm, 8 ^{1/4} "	250-688-210
245mm, 9 ^{2/3} "	250-688-245

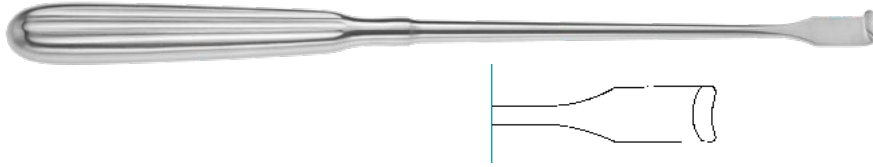

SCOVILLE

Nerve Root Retractor, 230mm, 9"

straight	250-698-230
45°	
90°	

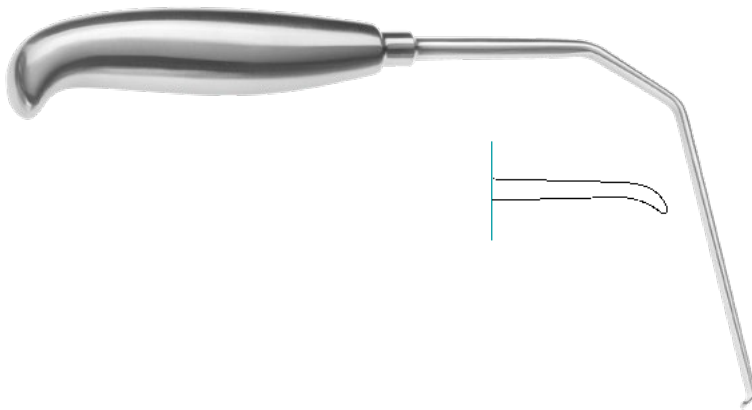

HESS

Nerve Root Retractor, angled
175mm, 6⁷/₈"

3mm	250-690-030
4mm	250-690-040
5mm	250-690-050
7mm	250-690-070

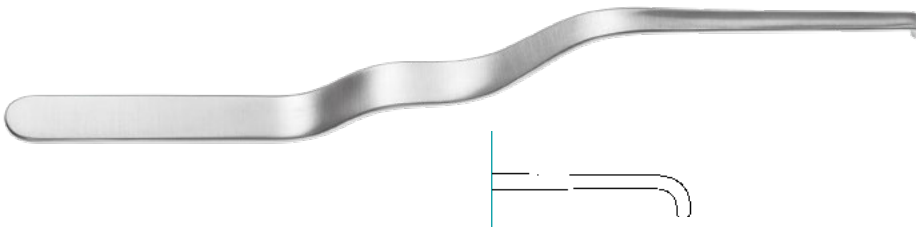

CASPAR

Nerve Root Retractor
240mm, 9¹/₂"

4mm	250-690-240
6mm	250-691-240
8mm	250-692-240
10mm	250-693-240

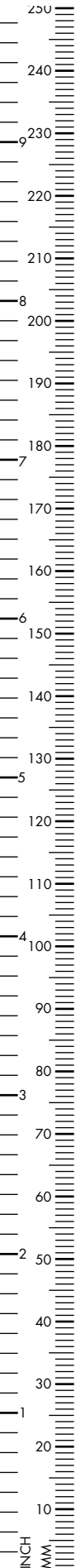



A Forward straight

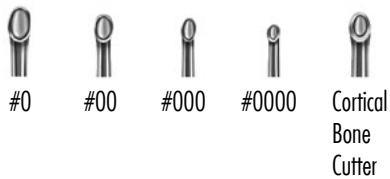

B Forward angled

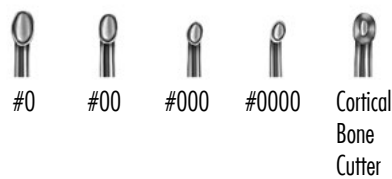

C Backward straight

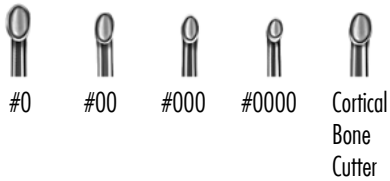

D Backward angled

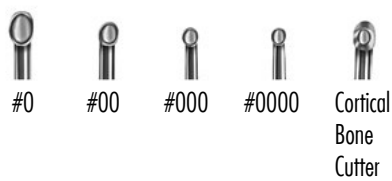

E Hooks

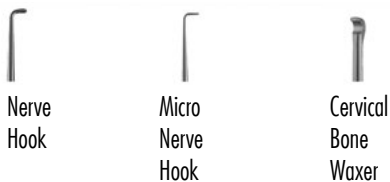

Microdissectomy
Cervical Curette, 210mm, 8¹/₄"

A forward straight

#0	259-100-100
#00	259-100-200
#000	259-100-300
#0000	259-100-400
Cortical Bone Cutter	259-100-500

B forward angled

#0	259-101-100
#00	259-101-200
#000	259-101-300
#0000	259-101-400
Cortical Bone Cutter	259-101-500

C backward straight

#0	259-102-100
#00	259-102-200
#000	259-102-300
#0000	259-102-400
Cortical Bone Cutter	259-102-500

D backward angled

#0	259-103-100
#00	259-103-200
#000	259-103-300
#0000	259-103-400
Cortical Bone Cutter	259-103-500

E Hooks

Nerve Hook	259-104-001
Micro Nerve Hook	259-104-002
Cervical Bone Waxer	259-104-003



A Forward straight

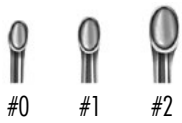

B Forward angled



C Forward down angled



D Backward straight

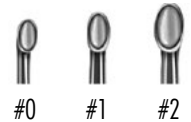

E Backward angled



F Backward down angled



G Instruments

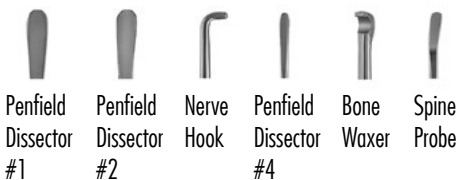

Microdissectomy
Lumbar Curette, 240mm, 9¹/₂"

A forward straight

#0	259-120-100
#1	259-120-001
#2	259-120-002

B forward angled

#0	259-121-100
#1	259-121-001
#2	259-121-002

C forward down angled

#0	259-122-100
#1	259-122-001
#2	259-122-002

D backward straight

#0	259-124-100
#1	259-124-001
#2	259-124-002

E backward angled

#0	259-125-100
#1	259-125-001
#2	259-125-002

F backward down angled

#0	259-126-100
#1	259-126-001
#2	259-126-002

G Instruments

Penfield Dissector #1	259-127-001
Penfield Dissector #2	259-127-002
Nerve Hook	259-127-003
Penfield Dissector #4	259-127-004
Bone Waxer	259-127-005
Spine Probe	259-127-006



A Forward straight

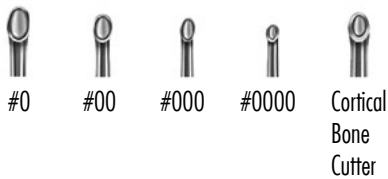

B Forward angled

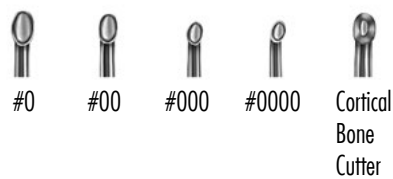

C Backward straight

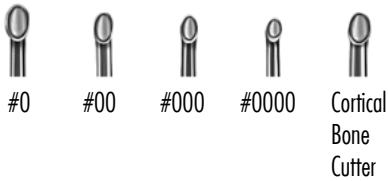

D Backward angled

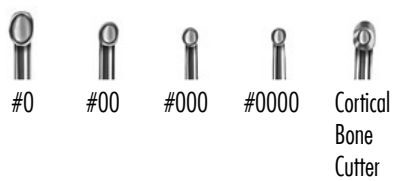

E Hooks

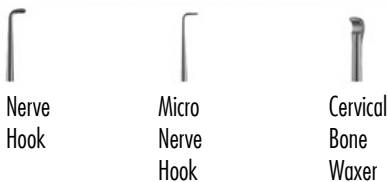

Microdissection Cervical Curette, 240mm, 9¹/₂"

A forward straight

#0	259-110-100
#00	259-110-200
#000	259-110-300
#0000	259-110-400
Cortical Bone Cutter	259-110-500

B forward angled

#0	259-111-100
#00	259-111-200
#000	259-111-300
#0000	259-111-400
Cortical Bone Cutter	259-111-500

C backward straight

#0	259-112-100
#00	259-112-200
#000	259-112-300
#0000	259-112-400
Cortical Bone Cutter	259-112-500

D backward angled

#0	259-113-100
#00	259-113-200
#000	259-113-300
#0000	259-113-400
Cortical Bone Cutter	259-113-500

E Hooks

Nerve Hook	259-114-001
Micro Nerve Hook	259-114-002
Cervical Bone Waxer	259-114-003



259-100-000
Cervical Microdiscectomy Set
consisting of:

- 259-100-200
- 259-100-300
- 259-100-400
- 259-101-100
- 259-101-300
- 259-101-400
- 259-102-300
- 259-102-400
- 259-103-200
- 259-103-300
- 259-104-001
- 259-104-002
- 600-404-000

259-110-000
Cervical Microdiscectomy Set
consisting of:

- 259-110-100
- 259-110-300
- 259-110-400
- 259-111-100
- 259-111-200
- 259-111-300
- 259-112-100
- 259-112-200
- 259-112-300
- 259-113-100
- 259-113-300
- 259-113-400
- 600-404-000

259-120-000
Lumbar Microdiscectomy Set
consisting of:

- 259-120-001
- 259-120-002
- 259-121-001
- 259-121-002
- 259-122-001
- 259-122-002
- 259-124-002
- 259-125-001
- 259-126-100
- 259-126-001
- 259-127-001
- 259-127-004
- 600-404-000

Case for Micro Curettes,
12 Instruments (not illustrated)

265 x 255 x 45mm 600-404-000



A Bayonet straight



B Bayonet 45° angled



C Bayonet 80° angled

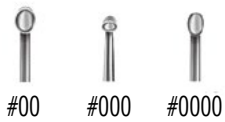

Micro Spinal Curettes, 210mm, 8^{1/4}"

A Bayonet straight

#00	259-140-200
#000	259-140-300
#0000	259-140-400

B Bayonet 45° angled

#00	259-141-200
#000	259-141-300
#0000	259-141-400

C Bayonet 80° angled

#00	259-142-200
#000	259-142-300
#0000	259-142-400



A Forward angled



B Backward angled



C Dissectors



Micro Spinal Curette, 250mm, 9^{7/8}"

A forward angled

#1	259-130-001
#2	259-130-002
#3	259-130-003
#4	259-130-004
#5	259-130-005

B backward angled

#1	259-131-001
#2	259-131-002
#3	259-131-003
#4	259-131-004
#5	259-131-005

C Dissector, straight

3mm	259-132-003
5mm	259-132-005



Curette measurements

Overall length	320mm, 12 ¹ / ₂ "
Handle length	200mm, 8"
Working length	125mm, 5"
Handle diameter	28mm, 1 ¹ / ₁₀ "

XL Curette measurements

Overall length	340mm, 13 ¹ / ₃ "
Handle length	220mm, 8 ² / ₃ "
Working length	125mm, 5"
Handle diameter	32mm, 1 ¹ / ₃ "

Cup Curette Set with 12 Curettes consisting of:

straight		
A	7mm	259-152-007
B	9mm	259-152-009
C	11mm	259-152-011
D	13mm	259-152-013
E	15mm	259-152-015
F	17mm	259-152-017
G	19mm	259-152-019
forward angled		
H	7mm	259-152-107
I	9mm	259-152-109
J	11mm	259-152-111
backward angled		
K	7mm	259-152-207
L	9mm	259-152-209

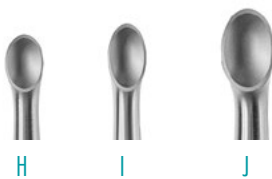

Cup Curette Set with 12 XL Curettes consisting of:

straight		
A	7mm	259-155-007
B	9mm	259-155-009
C	11mm	259-155-011
D	13mm	259-155-013
E	15mm	259-155-015
F	17mm	259-155-017
G	19mm	259-155-019
forward angled		
H	7mm	259-155-107
I	9mm	259-155-109
J	11mm	259-155-111
backward angled		
K	7mm	259-155-207
L	9mm	259-155-209

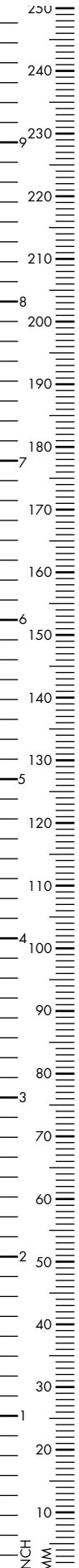



Chisel Set with 6 Chisels, straight
consisting of:

A	6mm	259-151-006
B	10mm	259-151-010
C	15mm	259-151-015
D	20mm	259-151-020
E	25mm	259-151-025
F	30mm	259-151-030
Sterilizing Case		259-151-002

Chisel measurements

Overall length	270mm, 10 ² / ₃ "
Handle length	145mm, 5 ³ / ₄ "
Working length	125mm, 5"
Handle diameter	32mm, 1 ¹ / ₃ "



Chisel Set with 6 Chisels, curved
consisting of:

A	6mm	259-151-106
B	10mm	259-151-110
C	15mm	259-151-115
D	20mm	259-151-120
E	25mm	259-151-125
F	30mm	259-151-130
Sterilizing Case		259-151-002



A



B



C



D



E

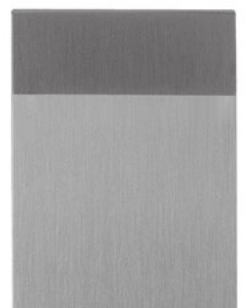

F



Ring Curette measurements

Overall length	320mm, 12 ¹ / ₂ "
Handle length	200mm, 8"
Working length	125mm, 5"
Handle diameter	28mm, 1 ¹ / ₁₀ "

XL Ring Curette measurements

Overall length	340mm, 13 ¹ / ₃ "
Handle length	220mm, 8 ² / ₃ "
Working length	125mm, 5"
Handle diameter	32mm, 1 ¹ / ₃ "

Ring Curette Set with 6 Ring Curettes
consisting of:
straight

A	6mm	259-153-006
B	8mm	259-153-008
C	11mm	259-153-010

angled

A	6mm	259-153-106
B	8mm	259-153-108
C	11mm	259-153-110

Ring Curette Set with 6 XL Ring Curettes
consisting of:
straight

A	6mm	259-154-006
B	8mm	259-154-008
C	11mm	259-154-010

angled

A	6mm	259-154-106
B	8mm	259-154-108
C	11mm	259-154-110

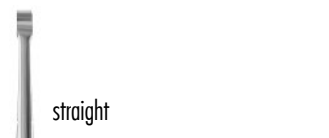

A B C



A B C

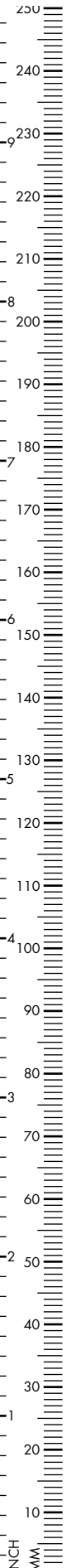



Elevator measurements

Overall length	320mm, 12 ¹ / ₂ "
Handle length	200mm, 8"
Working length	125mm, 5"
Handle Diameter	28mm, 1 ¹ / ₁₀ "

XL Elevator measurements

Overall length	340mm, 13 ¹ / ₃ "
Handle length	220mm, 8 ² / ₃ "
Working length	125mm, 5"
Handle diameter	32mm, 1 ¹ / ₃ "

Elevator Set with 6 Elevators consisting of:

A	10mm	259-157-010
B	15mm	259-157-015
C	20mm	259-157-020
D	25mm	259-157-025
E	30mm	259-157-030
F	35mm	259-157-035

Elevator Set with XL 6 Elevators consisting of:

A	10mm	259-158-010
B	15mm	259-158-015
C	20mm	259-158-020
D	25mm	259-158-025
E	30mm	259-158-030
F	35mm	259-158-035



A



B



C



D



E



F



SMITH PETERSON

Mallet with brass head, aluminium handle,
 \varnothing 38mm, 282g

Overall length 259-149-165
 165mm, 6^{1/2}"

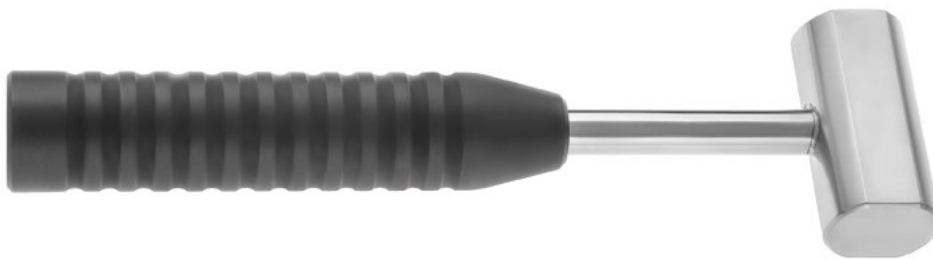

Mallet, large, \varnothing 31.8mm, 340g

Overall length 259-149-002
 247mm, 9^{2/3}"



Mallet, small, \varnothing 22.5mm, 193g

Overall length 259-149-001
 241mm, 9^{1/3}"

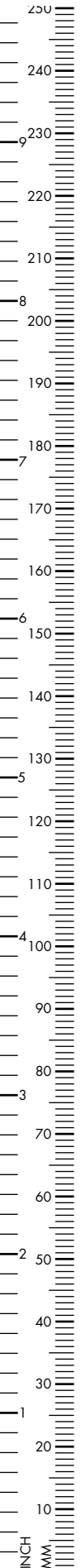



CLOWARD

Retractor, 112mm handle length

70x13mm	259-260-001
75x18mm	259-260-002
75x20mm	259-260-003
75x23mm	259-260-004



TAYLOR

Spinal Retractor, 185mm, 7¹/₄"

70x30mm	210-571-165
85x30mm	210-572-165
100x30mm	210-573-165



HIBBS

Retractor, Fig. 0, 230mm, 9"

25x13mm	170-200-000
Fig. 1, 230mm, 9"	
75x25mm	170-200-001
Fig. 2, 240mm, 9 ¹ / ₂ "	
80x25mm	170-200-002



HIBBS
 2-piece Retractor Set
 19x50mm blade
 235mm, 9¹/₄" 250-979-235



INGE
 Lamina Spreader, with teeth
 170mm, 6²/₃" 250-975-170
 270mm, 10²/₃" 250-975-270



Lamina Spreader
 265mm, 10¹/₂" 250-978-265



CUSHING LANDOLT

Specula for transsphenoidal hypophysectomy, black finishing

70 x 15mm	250-150-100
100 x 15mm	250-150-102



PAPAVERO CASPAR

Specula for trans-sphenoidal hypophysectomy, stainless steel

80 x 11mm	250-150-589
90 x 13mm	250-150-590
100 x 15mm	250-150-591

black finishing

80 x 11mm	250-150-689
90 x 13mm	250-150-690
100 x 15mm	250-150-691

Key for specula

250-150-592



Transnasal Speculum, stainless steel, matted

80 x 9mm	250-150-280
90 x 9mm	250-150-290
100 x 9mm	250-150-300



MEYERDING

Laminectomy Retractor, 200mm, 8"

25x32mm blade	170-791-001
25x54mm blade	170-791-002
19x60mm blade	170-791-003
25x60mm blade	170-791-004



MEYERDING

Hemi Laminectomy Retractor, 180mm, 7"

10mm wide blade, solid blade left

50mm	170-792-001
60mm	170-792-002
70mm	170-792-006

solid blade right

50mm	170-793-001
60mm	170-793-008
70mm	170-793-007

20mm wide blade, solid blade left

50mm	170-792-004
60mm	170-792-003
70mm	170-792-005

solid blade right

50mm	170-793-004
60mm	170-793-005
70mm	170-793-002



MARKHAM MEYERDING

Laminectomy Retractor, 165mm, 6^{1/2}"

solid blade left

25x65mm	170-790-007
---------	-------------

solid blade right

25x65mm	170-790-008
---------	-------------

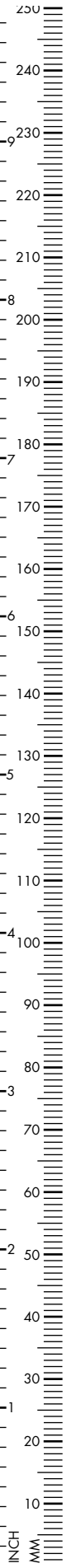



Vertebral Distractor, 127mm length

18mm spread	250-259-018
-------------	-------------

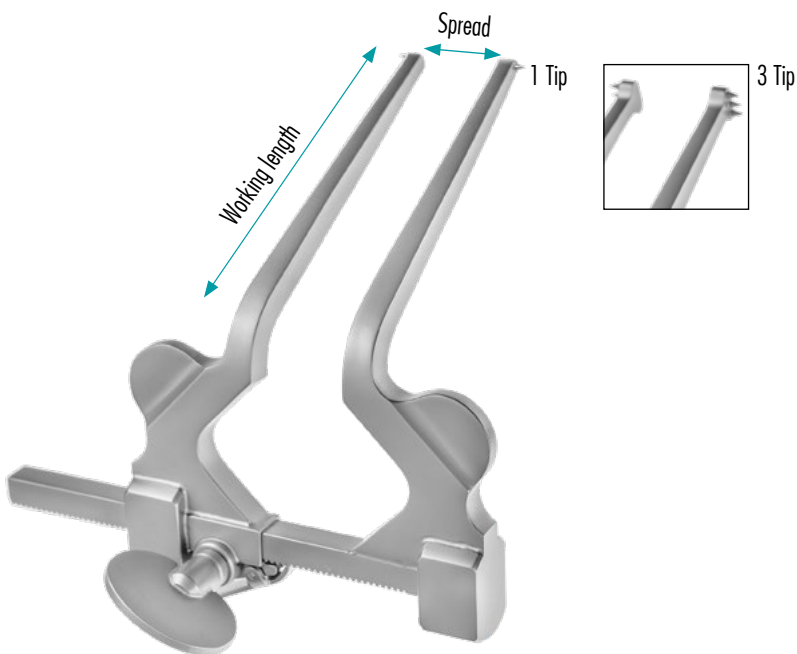

Vertebral Distractor, with 3 tips,
70mm working length

70mm spread	250-259-070
-------------	-------------



CLOWARD
Lamina Spreader

160mm, 6 ¹ / ₄ "	250-973-160
--	-------------



CLOWARD

Self-Retaining Retractor Set, 150mm, 6"
complete with 5 blades

58mm spread 170-780-160

Blades

40mm, 1⁵/₈" 170-780-040

45mm, 1⁶/₈" 170-780-045

50mm, 2" 170-780-050

55mm, 2¹/₈" 170-780-055

60mm, 2³/₈" 170-780-060

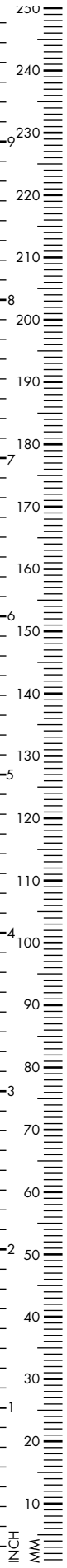

**CLOWARD**

Self-Retaining Retractor

250mm, 9⁷/₈" 170-774-250

Blades (pair)

40mm, 1⁵/₈" 170-774-04045mm, 1⁶/₈" 170-774-045

50mm, 2" 170-774-050

55mm, 2¹/₈" 170-774-05560mm, 2³/₈" 170-774-060

SCOVILLE DISTRACTOR



SCOVILLE HAVERFIELD

Spreader, rigid arms, without valves

171mm spread 170-906-000

hinged arms, without valves

171mm spread 170-906-001



Hook, blunt

51mm 170-906-102

75mm 170-906-104



Hook, with crossbar

51mm 170-906-106

75mm 170-906-108



Blade, toothed

26 x 63mm 170-906-122

51 x 63mm 170-906-124

32 x 66mm 170-906-126

26 x 89mm 170-906-128



Blade, forked, blunt

38 x 41mm 170-906-144

48 x 66mm 170-906-145



MEYERDING

Blade, toothed

26 x 61mm	170-906-162
26 x 67mm	170-906-164
51 x 89mm	170-906-166



HIBBS

Blade, toothed

26 x 51mm	170-906-182
51 x 51mm	170-906-184
26 x 76mm	170-906-190
38 x 76mm	170-906-192
51 x 76mm	170-906-194
26 x 101mm	170-906-196
51 x 101mm	170-906-198



TAYLOR

Blade

32 x 76mm	170-906-120
32 x 101mm	170-906-121



TAYLOR

Blade, forked, sharp

38 x 44mm	170-906-132
-----------	-------------



TAYLOR

Blade, forked, blunt

51 x 48mm	170-906-141
63 x 63mm	170-906-142
58 x 82mm	170-906-143

CASPAR CERVICAL DISTRACTOR

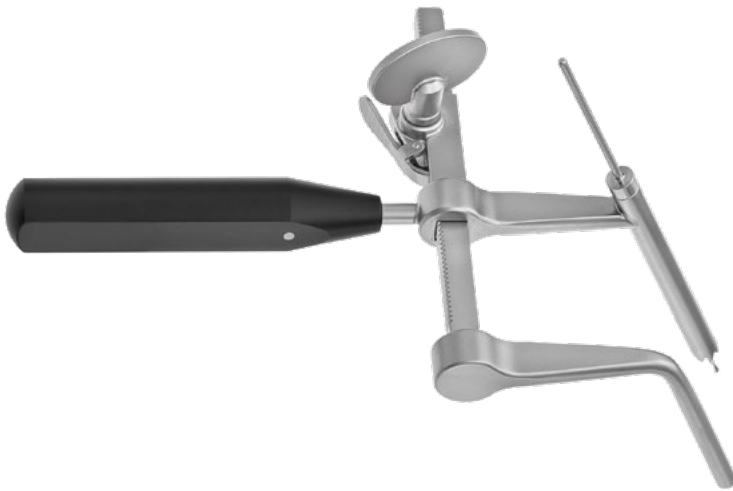

CASPAR
Cervical Distractor System



CASPAR
Cervical Distractor with 110mm rack
for two-level distraction

left approach	259-190-110
right approach	259-190-111

with 130mm rack
for multi-level distraction

left approach	259-190-130
right approach	259-190-131



CASPAR
Drill Guide

left	259-190-200
right	259-190-300

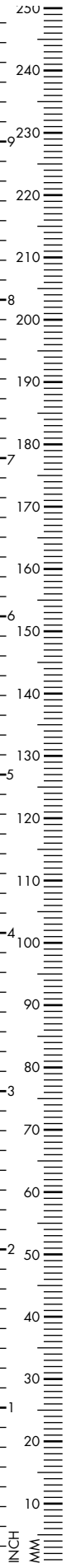

CASPAR CERVICAL DISTRACTOR



CASPAR

Drill Bit, 2.35mm shank, 148mm overall length
 Ø 1.7mm

8mm drilling depth 259-190-408

14mm drilling depth 259-190-414



CASPAR

Distraction Screw, self-drilling

12mm 259-190-512

14mm 259-190-514

16mm 259-190-516

18mm 259-190-518



CASPAR

Screw Driver, 200mm overall length

259-190-550

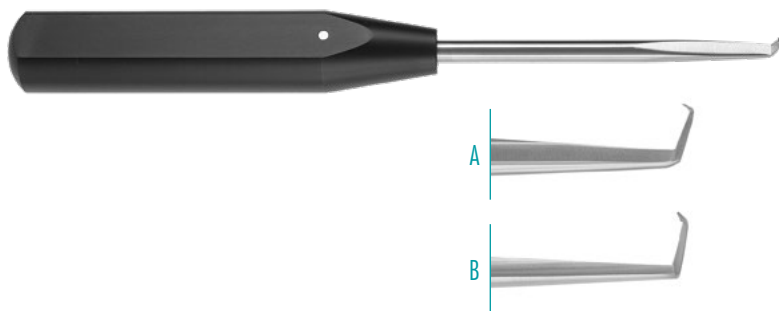

CASPAR

Dissector, 205mm, 8¹/₄"

A 259-185-917

B 259-185-918

CASPAR CERVICAL RETRACTOR SYSTEM



CASPAR

CCR Basis Retractor, double hinged arms, reverse butterfly screw, distal hinge made of titanium

259-180-490



CASPAR

Basis Counter Retractor, double hinged arms, distal hinge made of titanium

259-180-470



CASPAR

Counter Retractor, distal hinge made of titanium

259-180-480

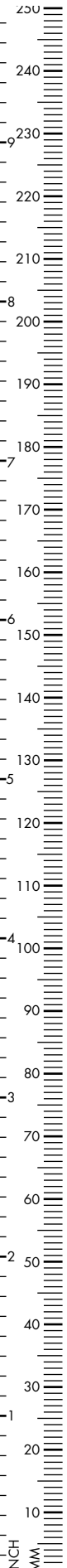

CASPAR CERVICAL RETRACTOR SYSTEM



CASPAR

Side Load Handle for use with titanium blades

259-180-100



CASPAR

Caspar Handle for blades, side load, cannulated, with Luer Lock, ratchet mechanism

259-180-101



CASPAR

Depth Gauge

259-180-200

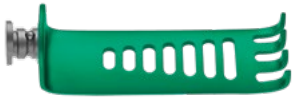

Titanium Medial/Lateral Blade, 4 prongs,
19mm width

25mm	259-180-125
30mm	259-180-130
35mm	259-180-135
40mm	259-180-140
45mm	259-180-145
50mm	259-180-150
55mm	259-180-155
60mm	259-180-160
65mm	259-180-165
70mm	259-180-170
75mm	259-180-175

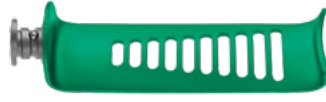

Titanium Longitudinal Blade, blunt
19mm width

25mm	259-180-225
30mm	259-180-230
35mm	259-180-235
40mm	259-180-240
45mm	259-180-245
50mm	259-180-250
55mm	259-180-255
60mm	259-180-260
65mm	259-180-265
70mm	259-180-270
75mm	259-180-275

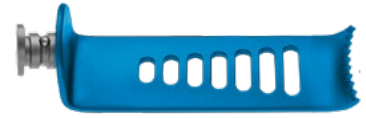

Titanium Lateral Blade, 8 teeth
24mm width

25mm	259-180-325
30mm	259-180-330
35mm	259-180-335
40mm	259-180-340
45mm	259-180-345
50mm	259-180-350
55mm	259-180-355
60mm	259-180-360
65mm	259-180-365
70mm	259-180-370
75mm	259-180-375



Titanium Medial Blade, 5 prongs,
24mm width

25mm	259-180-425
30mm	259-180-430
35mm	259-180-435
40mm	259-180-440
45mm	259-180-445
50mm	259-180-450
55mm	259-180-455
60mm	259-180-460
65mm	259-180-465
70mm	259-180-471
75mm	259-180-475



Titanium Longitudinal Blade, blunt
24mm width

25mm	259-180-525
30mm	259-180-530
35mm	259-180-535
40mm	259-180-540
45mm	259-180-545
50mm	259-180-550
55mm	259-180-555
60mm	259-180-560
65mm	259-180-565
70mm	259-180-570
75mm	259-180-575

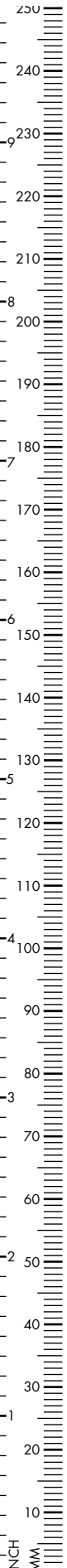

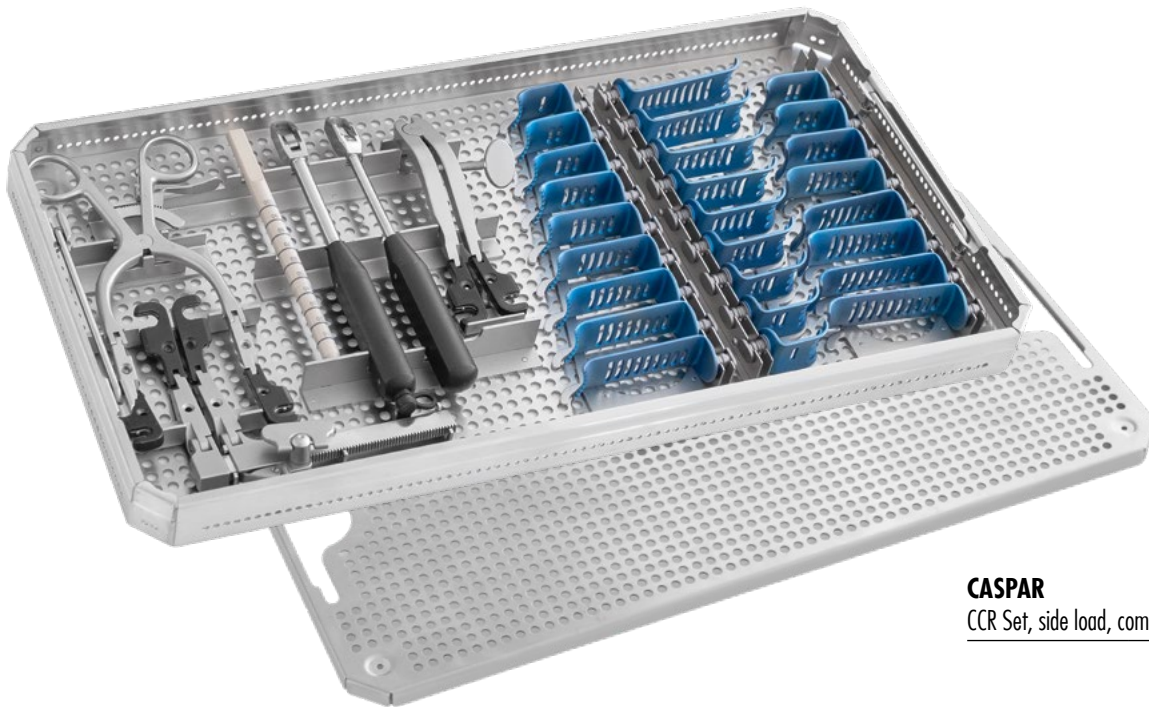

CASPAR

CCR Set, side load, complete

259-180-000

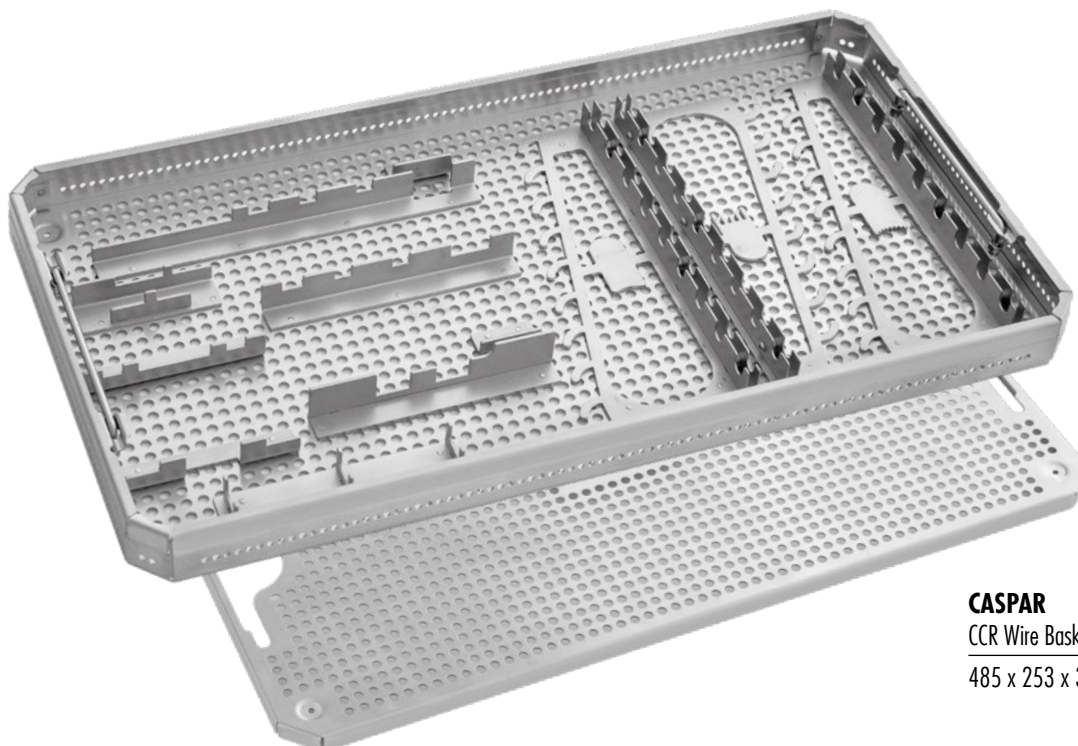

CASPAR

CCR Wire Basket, with lid

485 x 253 x 30mm 259-180-001

RAINBOW CERVICAL RETRACTOR

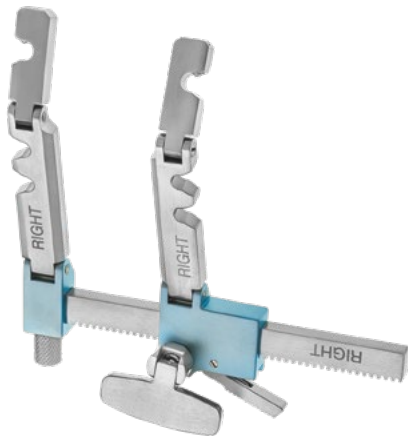

Rainbow Cervical Retractor Frame Right
 Max opening: 65mm
 Arm length: 80mm

259-188-001



Rainbow Cervical Retractor Frame Left
 Max opening: 65mm
 Arm length: 80mm

259-188-002



Rainbow Cervical Retractor Offset
 Max opening: 80mm
 Arm length: 80mm

259-188-003



Rainbow Lumbar Retractor Frame
 with instrument coupling
 Max opening: 80mm
 Arm length: 80mm

259-188-101

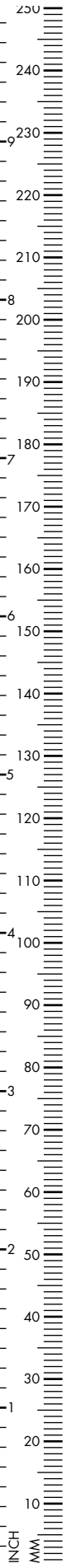

RAINBOW CERVICAL RETRACTOR



Rainbow Cervical Toothed Rack
with finger screw

259-188-032



Rainbow Handle

259-188-005

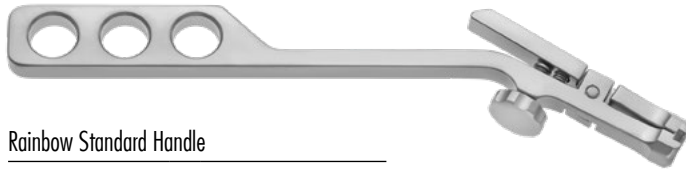

Rainbow Standard Handle

259-188-102



Rainbow Cervical Depth Gauge
with color markings

259-188-102

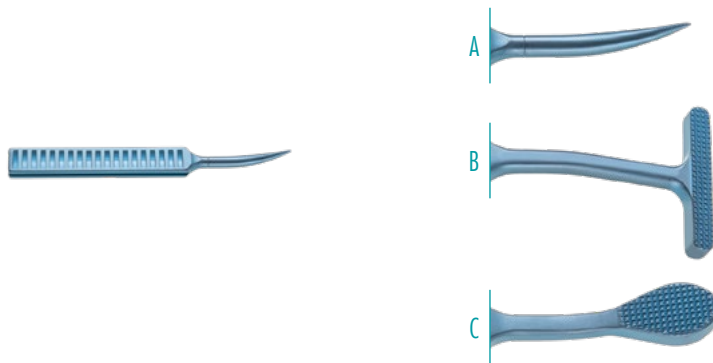

Rainbow Valve

- A Sharp 259-188-029
- B T-Valve 259-188-030
- C Ligament 259-188-031



Rainbow Instrument Coupling

259-188-028

RAINBOW CERVICAL RETRACTOR



Rainbow Valve, 4 prongs

34mm	●	259-188-013
40mm	●	259-188-014
45mm	●	259-188-015
50mm	●	259-188-016
55mm	●	259-188-017
60mm	●	259-188-018
70mm	●	259-188-019
85mm	●	259-188-020



Rainbow Depth Valve, 4 prongs

40mm	●	259-188-007
47mm	●	259-188-008
55mm	●	259-188-009



Rainbow Depth Valve

40mm	●	259-188-010
47mm	●	259-188-011
55mm	●	259-188-012



Rainbow Blunt Valve

34mm	●	259-188-021
40mm	●	259-188-022
45mm	●	259-188-023
50mm	●	259-188-024
55mm	●	259-188-025
60mm	●	259-188-026
70mm	●	259-188-027

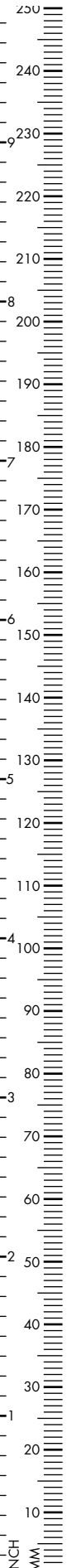

RAINBOW CERVICAL RETRACTOR

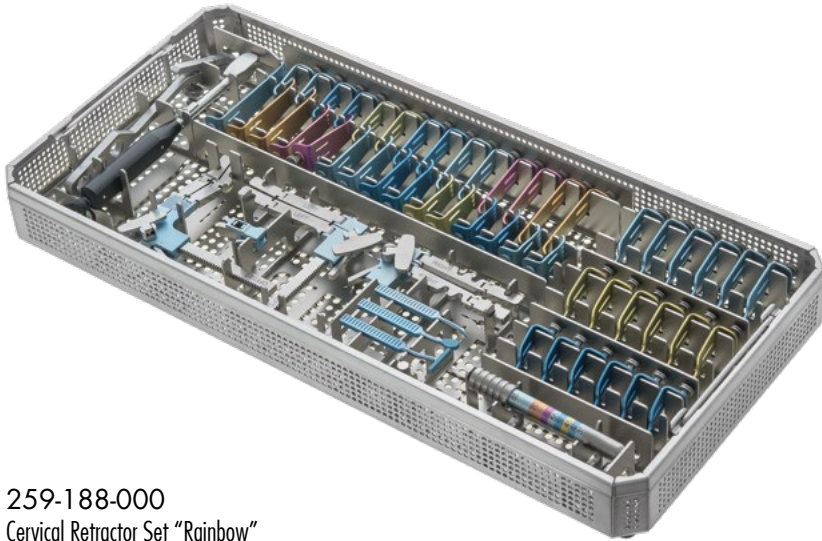

259-188-000
Cervical Retractor Set "Rainbow"
consisting of:

1x	259-188-001	2x	●	259-188-012	2x	●	259-188-023
1x	259-188-002	2x	●	259-188-013	2x	●	259-188-024
1x	259-188-003	2x	●	259-188-014	2x	●	259-188-025
1x	259-188-004	2x	●	259-188-015	2x	●	259-188-026
1x	259-188-005	2x	●	259-188-016	2x	●	259-188-027
1x	259-188-102	2x	●	259-188-017	1x		259-188-028
4x ●	259-188-007	2x	●	259-188-018	1x		259-188-029
4x ●	259-188-008	2x	●	259-188-019	1x		259-188-030
4x ●	259-188-009	1x	●	259-188-020	1x		259-188-031
2x ●	259-188-010	2x	●	259-188-021	1x		259-188-032
2x ●	259-188-011	2x	●	259-188-022	1x (Container only)		259-188-033

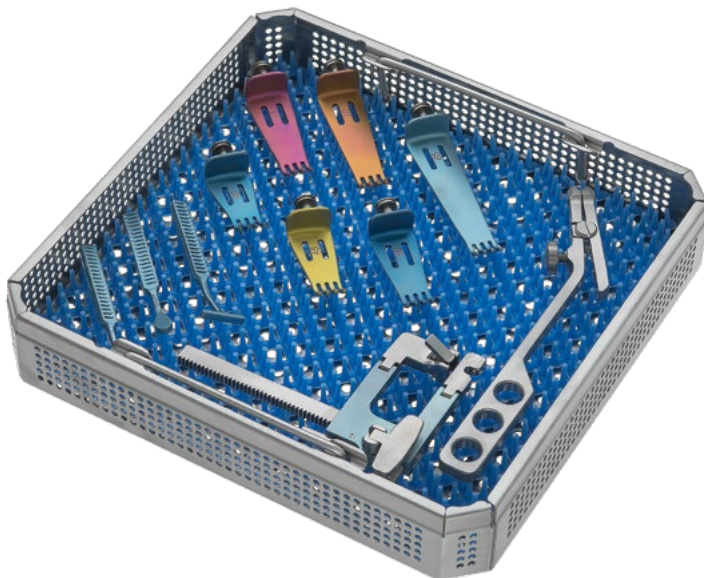

259-188-100
Lumbar Microdiscectomy Retractor Set
"Rainbow"
consisting of:

1x	259-188-101
1x	259-188-102
1x	259-188-029
1x	259-188-030
1x	259-188-031
1x	259-188-014
1x	259-188-015
1x	259-188-016
1x	259-188-018
1x	259-188-019
1x	259-188-020
1x (Container only)	259-188-133

CASPAR LUMBAR RETRACTOR



CLR Retractor side-load

259-190-610



CCR/CLR handle for blades, with black PPSU handle

259-180-100



CCR/CLR handle for blades, cannulated with luer-lock, with black PPSU handle

259-180-101



CCR/CLR Depth Gauge instrument, natural

259-180-200

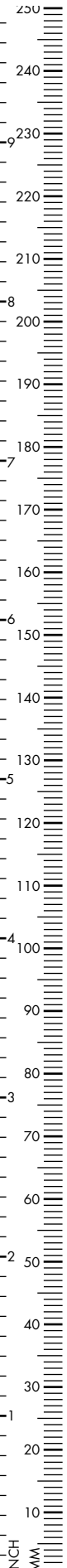

CASPAR LUMBAR RETRACTOR



CLR Blade, side load, width: 20mm,
color: blue, 3 prongs

20 x 35mm	259-190-235
20 x 40mm	259-190-240
20 x 45mm	259-190-245
20 x 55mm	259-190-255
20 x 65mm	259-190-265



CLR Blade, side load, width: 40mm,
color: blue, 3 prongs

40 x 35mm	259-190-435
40 x 40mm	259-190-440
40 x 45mm	259-190-445
40 x 55mm	259-190-455
40 x 65mm	259-190-465
40 x 75mm	259-190-475



CLR Blade, side load, width: 60mm,
color: blue, 3 prongs

60 x 35mm	259-190-635
60 x 40mm	259-190-640
60 x 45mm	259-190-645
60 x 55mm	259-190-655
60 x 65mm	259-190-665
60 x 75mm	259-190-675
60 x 85mm	259-190-685



Hemi-laminectomy hook, color: blue

small	259-190-231
large	259-190-232

CASPAR LUMBAR RETRACTOR

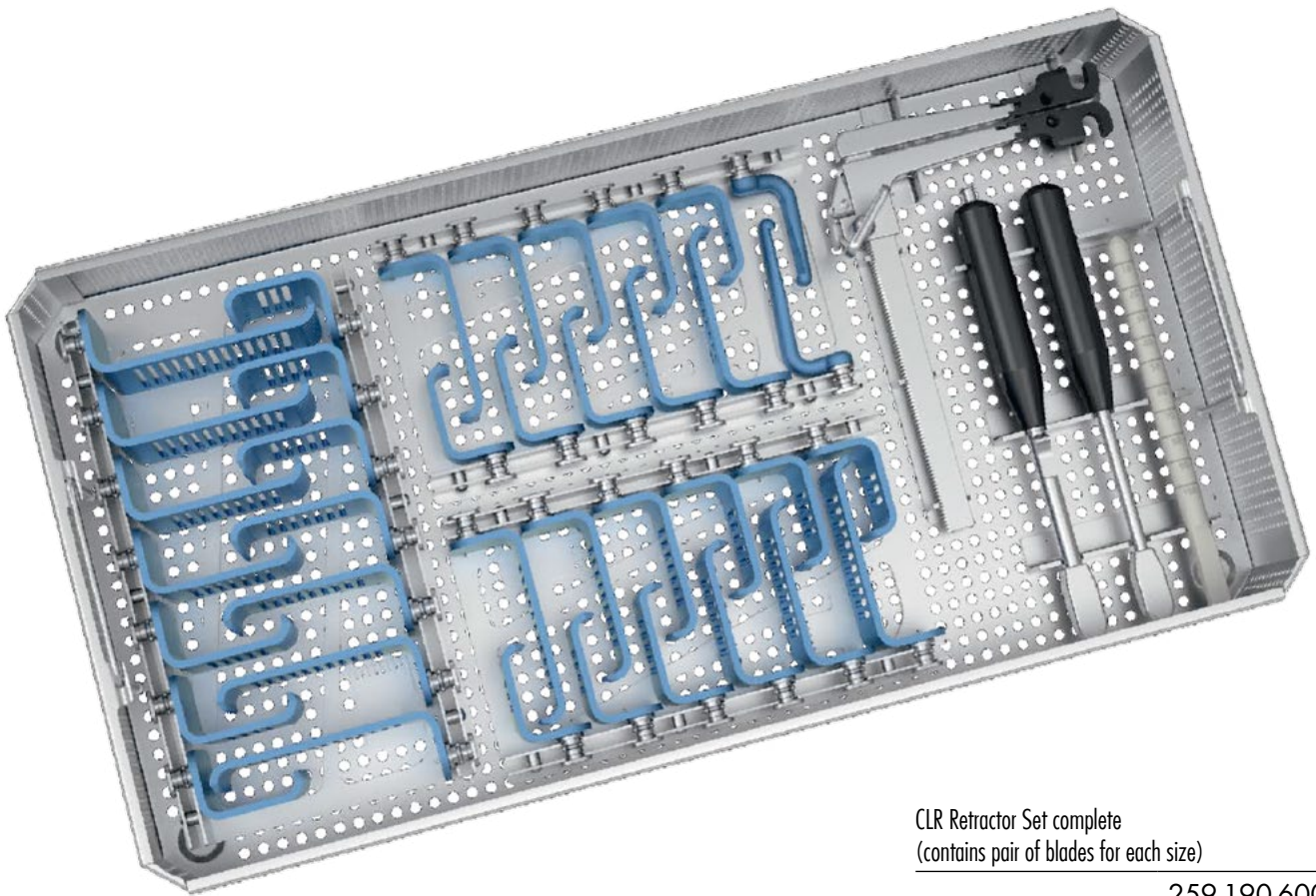

CLR Retractor Set complete
(contains pair of blades for each size)

259-190-600

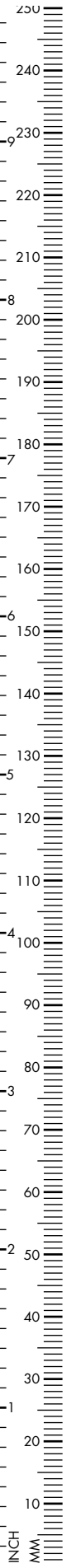

CASPAR LUMBAR RETRACTOR

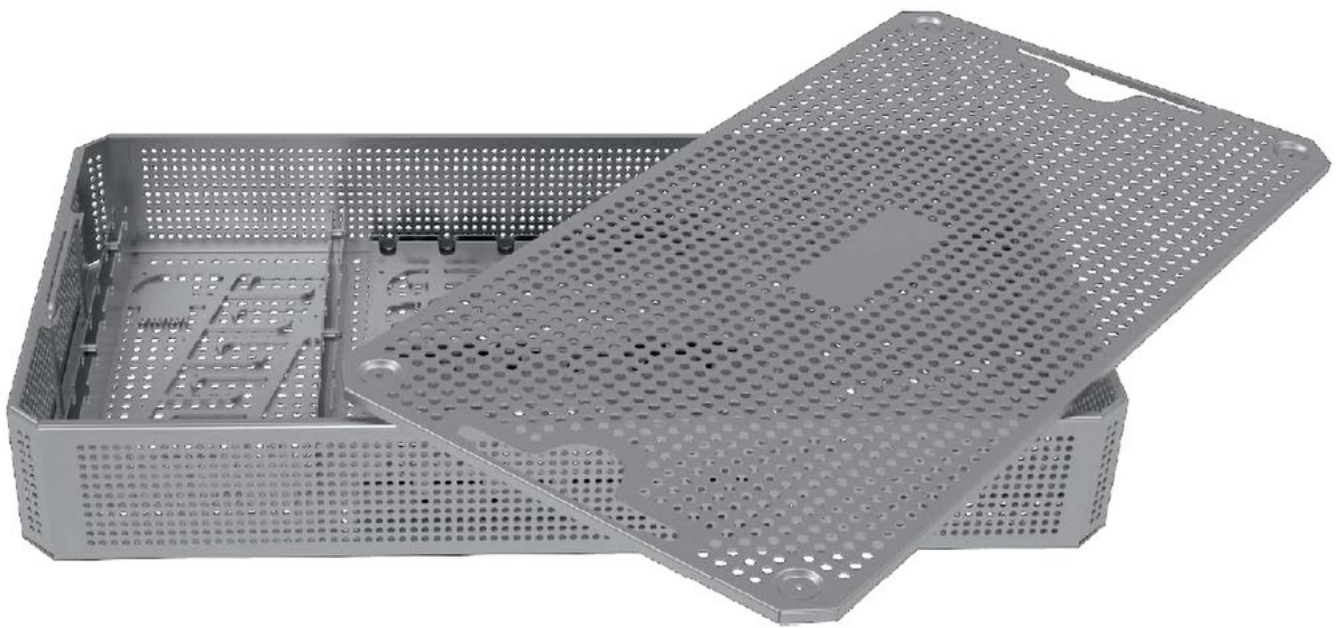

CLR Retractor Set Tray empty

259-190-601

BUTTERFLY SPINE RETRACTOR SET

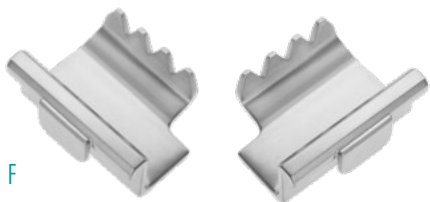
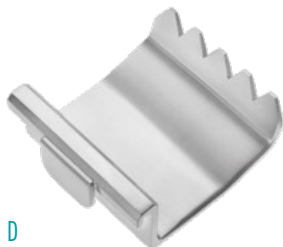
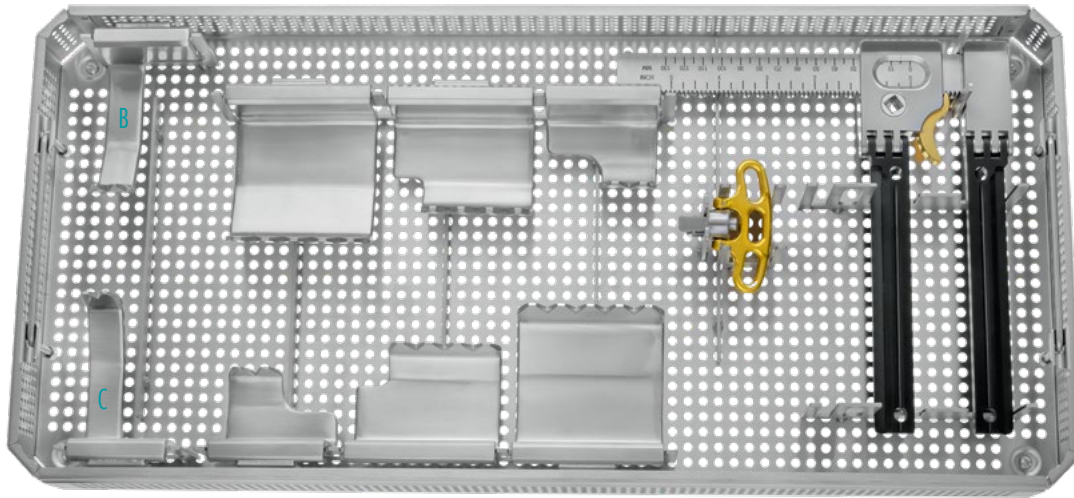

Lightweight, new designed set

with tray 290-300-340

without tray 290-300-330

B + C optional, not included in the set

Set consists of

Type	Width	Length	Quantity	
A Retractor			1	290-300-311
D Retractor 5 teeth	76mm	64mm	2	290-300-312
E Retractor left	31mm	38mm	1	290-300-313
E Retractor right	31mm	38mm	1	290-300-314
F Retractor left	57mm	44mm	1	290-300-315
F Retractor right	57mm	44mm	1	290-300-316

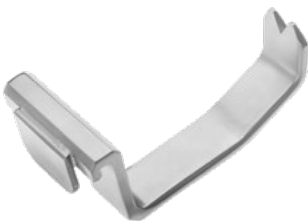
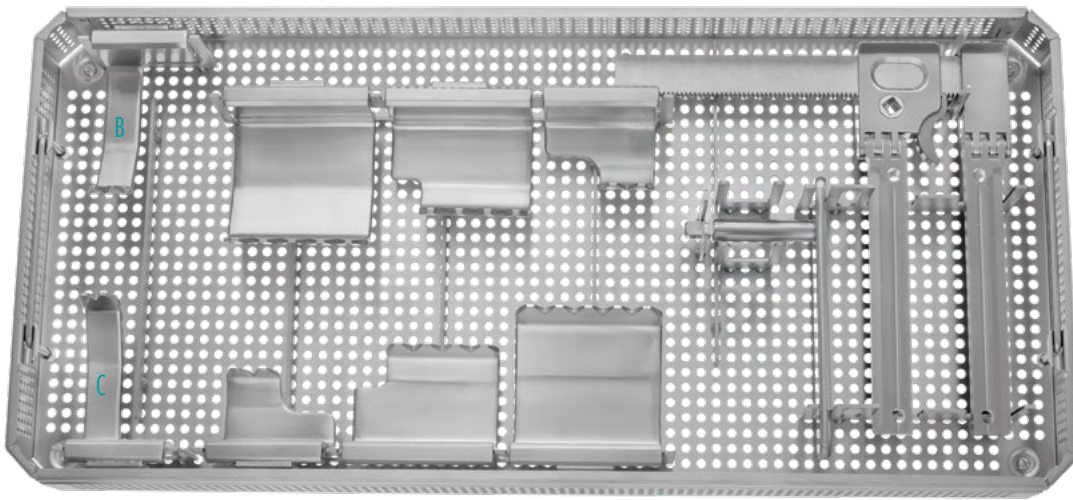

Standard Butterfly Set

with tray and lid 290-300-320

without tray and lid 290-300-310

B + C optional, not included in the set

Set consists of

Type	Width	Length	Quantity	
G Standard Retractor			1	290-300-301
D Retractor 5 teeth	76mm	64mm	2	290-300-302
E Retractor left	31mm	38mm	1	290-300-303
E Retractor right	31mm	38mm	1	290-300-304
F Retractor left	57mm	44mm	1	290-300-305
F Retractor right	57mm	44mm	1	290-300-306

Optional Retractors, right/left angled (standard), for B + C

Width	Length	Quantity	
19mm	31mm	2	290-300-205
19mm	44mm	2	290-300-206
19mm	57mm	2	290-300-207
19mm	83mm	2	290-300-209
19mm	76mm	2	290-300-208
19mm	102mm	2	290-300-210
51mm	102mm	2	290-300-216 (not offset)

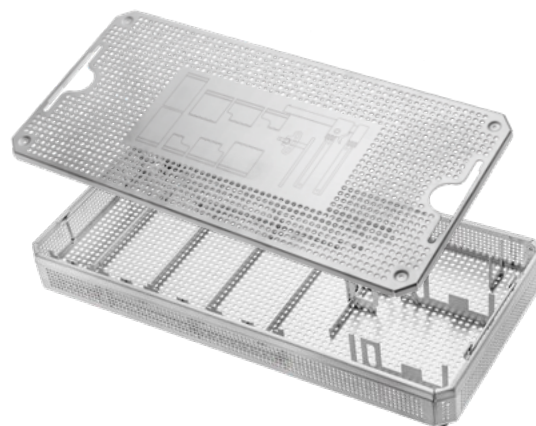

Tray with lid (fits for standard and lightweight)

290-300-350

LT - SET FOR LUMBAR RETRACTION



LT Lumbar Retraction Set, complete with tray

259-197-000

Tray only

540x253x170mm

259-197-001

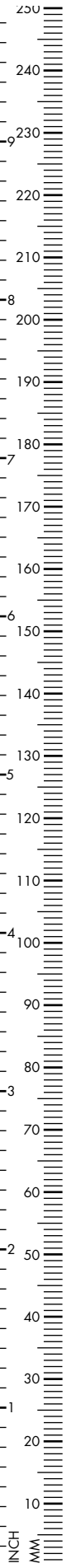
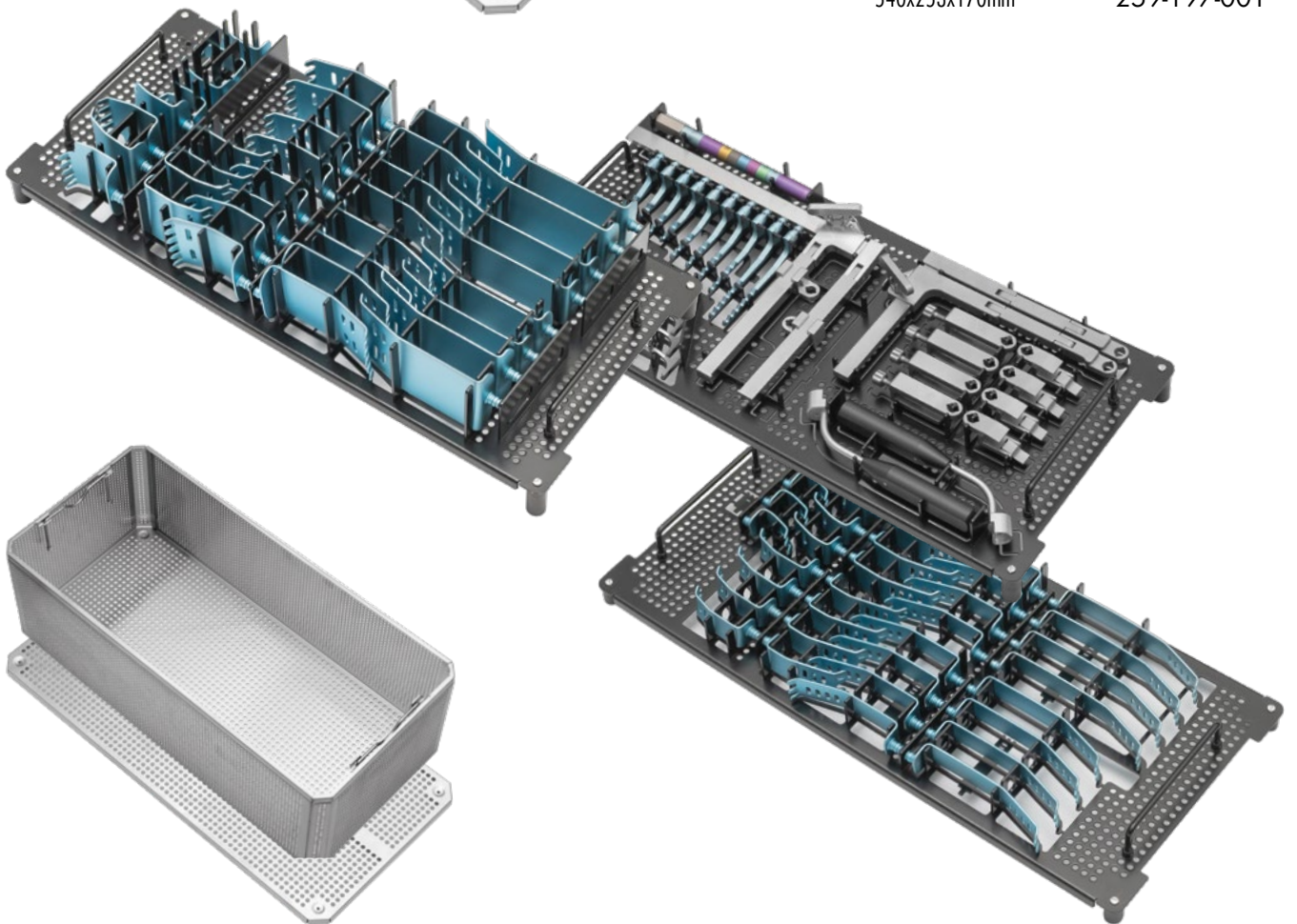

LT - SET FOR LUMBAR RETRACTION

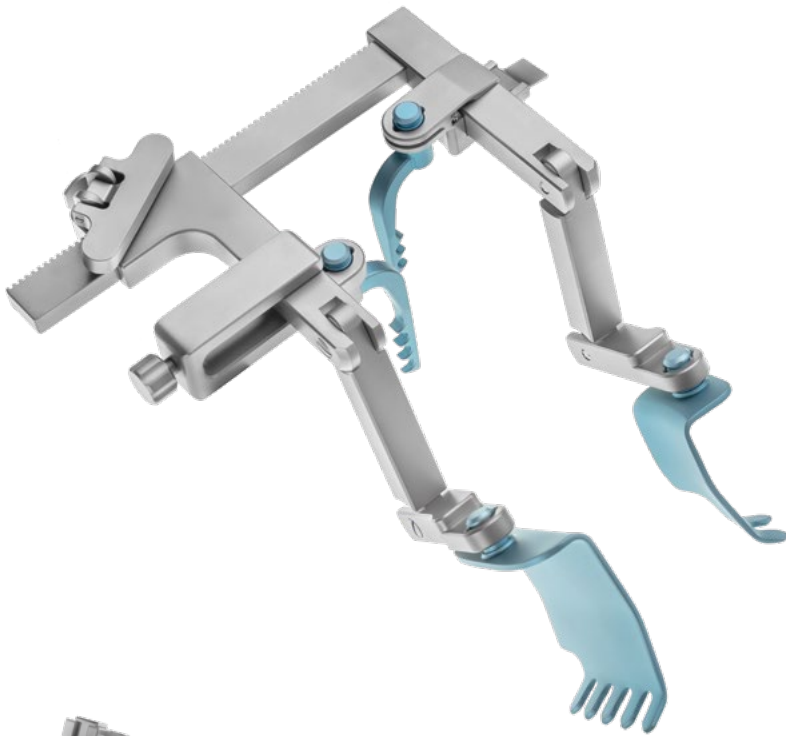

LT Retractor, hinged
 209mm spread 259-197-002



LT Retractor, double hinged
 102mm spread 259-197-003
 209mm spread 259-197-004

LT - SET FOR LUMBAR RETRACTION



Blade connector with quick coupling

259-197-005



Blade connector with screw connection

259-197-006

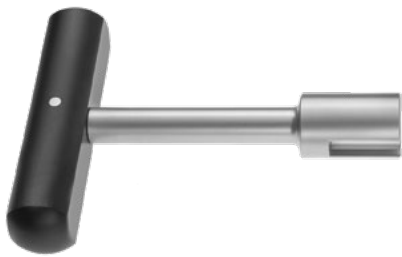

T-Handle

259-197-007



Handle, manual blade retraction

259-197-009



Depth Gauge

259-197-008

LT - SET FOR LUMBAR RETRACTION



LT Valve, 6 prongs, 60mm wide

50mm depth	259-197-650
60mm depth	259-197-660
70mm depth	259-197-670
80mm depth	259-197-680
90mm depth	259-197-690
110mm depth	259-197-691
130mm depth	259-197-693

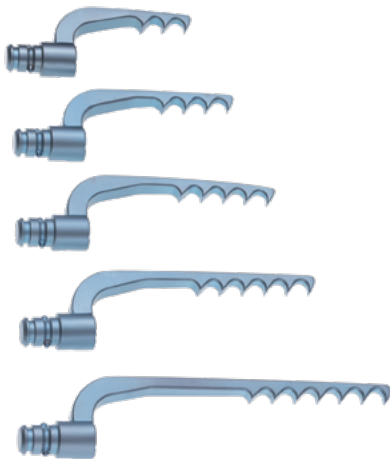

LT Hook, toothed

34mm depth, 3 teeth	259-197-103
44mm depth, 4 teeth	259-197-104
54mm depth, 5 teeth	259-197-105
64mm depth, 6 teeth	259-197-106
84mm depth, 7 teeth	259-197-107



LT Valve, left, 2 prongs

30mm width, 40mm depth	259-197-111
60mm width, 45mm depth	259-197-112



right, 5 prongs

30mm width, 40mm depth	259-197-113
60mm width, 45mm depth	259-197-114

LT - SET FOR LUMBAR RETRACTION



LT Valve, 3 prongs, 24mm wide

30mm depth	259-197-330
40mm depth	259-197-340
50mm depth	259-197-350
60mm depth	259-197-360
70mm depth	259-197-370
80mm depth	259-197-380
90mm depth	259-197-390
110mm depth	259-197-410
130mm depth	259-197-430



LT Valve, 5 prongs, 45mm wide

50mm depth	259-197-550
60mm depth	259-197-560
70mm depth	259-197-570
80mm depth	259-197-580
90mm depth	259-197-590
110mm depth	259-197-591
130mm depth	259-197-593



LT T-Valve, 25mm wide

40mm depth	259-197-254
50mm depth	259-197-255
60mm depth	259-197-256
70mm depth	259-197-257

CASPAR MICRO DISCECTOMY RETRACTOR



CASPAR

Counter Retractor, hinged arms

259-185-100

CASPAR

Specula

40mm	259-185-040
45mm	259-185-045
50mm	259-185-050
55mm	259-185-055
60mm	259-185-060
65mm	259-185-065
75mm	259-185-070
80mm	259-185-080
85mm	259-185-085

CASPAR MICRO DISCECTOMY RETRACTOR



Lateral blade with snap lock

35mm	259-185-235
40mm	259-185-240
45mm	259-185-245
50mm	259-185-250
55mm	259-185-255
60mm	259-185-260
65mm	259-185-265
75mm	259-185-275
80mm	259-185-280
85mm	259-185-285

Medial blade

40mm	259-185-340
45mm	259-185-345
50mm	259-185-350
55mm	259-185-355
60mm	259-185-360
65mm	259-185-365
70mm	259-185-370

Blade Ejector Forceps

115mm, 4 ¹ / ₂ "	259-185-101
--	-------------

MCCULLOCH MICRO DISCECTOMY RETRACTOR

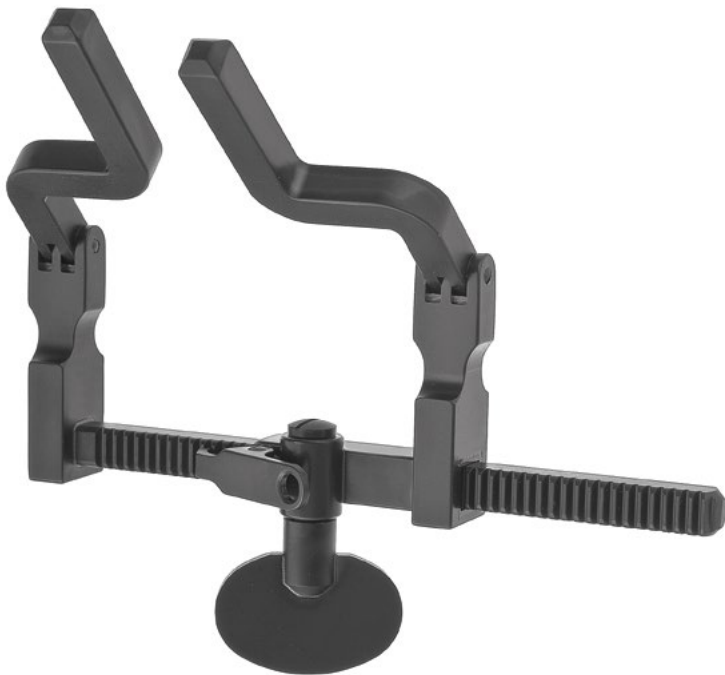
**MCCULLOCH**

Retractor Frame, with hinged arms

85mm, 3" 259-170-200

with rigid arms

85mm, 3" 259-170-100



MCCULLOCH MICRO DISCECTOMY RETRACTOR

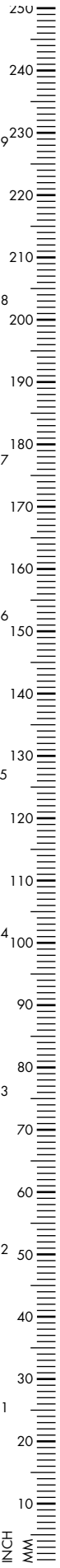

MCCULLOCH

Muscle blade, 27mm wide, 6 teeth

30mm, 1 ¹ / ₅ "	259-170-130
40mm, 1 ² / ₃ "	259-170-140
50mm, 2"	259-170-150
60mm, 2 ¹ / ₃ "	259-170-160
70mm, 2 ⁴ / ₅ "	259-170-170
80mm, 3 ¹ / ₅ "	259-170-180
90mm, 3 ¹ / ₂ "	259-170-190

Blade Set, large

Set with 12 pcs. (2 blades each) 259-170-130 to 259-170-180	259-170-110
--	-------------

Blade Set, small

Set with 8 pcs. (2 blades each) 259-170-140 to 259-170-170	259-170-111
---	-------------



MCCULLOCH

Muscle blade, 20mm wide, 4 teeth

30mm, 1 ¹ / ₅ "	259-170-230
40mm, 1 ² / ₃ "	259-170-240
50mm, 2"	259-170-250
60mm, 2 ¹ / ₃ "	259-170-260
70mm, 2 ⁴ / ₅ "	259-170-270
80mm, 3 ¹ / ₅ "	259-170-280

Blade Set, large

Set with 12 pcs. (2 blades each) 259-170-230 to 259-170-280	259-170-210
--	-------------

Blade Set, small

Set with 8 pcs. (2 blades each) 259-170-240 to 259-170-270	259-170-211
---	-------------



MCCULLOCH

Muscle blade, 17mm wide, 2 teeth

30mm, 1 ¹ / ₅ "	259-170-330
40mm, 1 ² / ₃ "	259-170-340
50mm, 2"	259-170-350
60mm, 2 ¹ / ₃ "	259-170-360
70mm, 2 ⁴ / ₅ "	259-170-370
80mm, 3 ¹ / ₅ "	259-170-380
90mm, 3 ¹ / ₂ "	259-170-390

Blade Set, large

Set with 12 pcs. (2 blades each) 259-170-330 to 259-170-380	259-170-310
--	-------------

Blade Set, small

Set with 8 pcs. (2 blades each) 259-170-340 to 259-170-370	259-170-311
---	-------------

MCCULLOCH MICRO DISCECTOMY RETRACTOR



MCCULLOCH

Cervical blade, 20mm wide, 2 teeth

50mm, 2"	259-170-650
60mm, 2 ¹ / ₃ "	259-170-660
70mm, 2 ⁴ / ₅ "	259-170-670



MCCULLOCH

Hook #1

20mm, 4/5"	259-170-420
30mm, 1 ¹ / ₅ "	259-170-430
40mm, 1 ² / ₃ "	259-170-440
50mm, 2"	259-170-450
60mm, 2 ¹ / ₃ "	259-170-460
70mm, 2 ⁴ / ₅ "	259-170-470
80mm, 3 ¹ / ₅ "	259-170-480

Blade Set, large

Set with 12 pcs. (2 blades each) 259-170-420 to 259-170-470	259-170-410
--	-------------

Blade Set, small

Set with 8 pcs. (2 blades each) 259-170-430 to 259-170-460	259-170-411
---	-------------



MCCULLOCH

Hook #2

20mm, 4/5"	259-170-520
30mm, 1 ¹ / ₅ "	259-170-530
40mm, 1 ² / ₃ "	259-170-540
50mm, 2"	259-170-550
60mm, 2 ¹ / ₃ "	259-170-560
70mm, 2 ⁴ / ₅ "	259-170-570
80mm, 3 ¹ / ₅ "	259-170-580

Blade Set, large

Set with 12 pcs. (2 blades each) 259-170-520 to 259-170-570	259-170-510
--	-------------

Blade Set, small

Set with 8 pcs. (2 blades each) 259-170-530 to 259-170-560	259-170-511
---	-------------

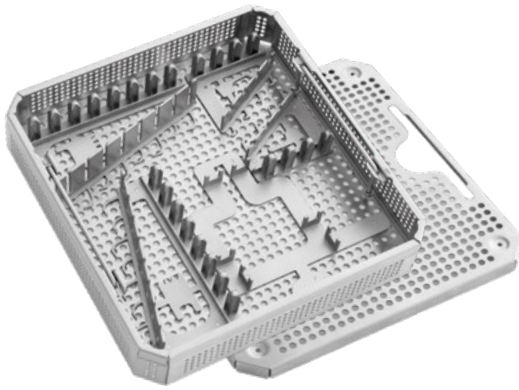

MCCULLOCH

Tray, small, with lid

253 x 253 x 50mm 259-170-000



MCCULLOCH

Set with Tray, small 259-170-000
and hinged retractors,
blades 2 each, 1 hook each

259-170-001

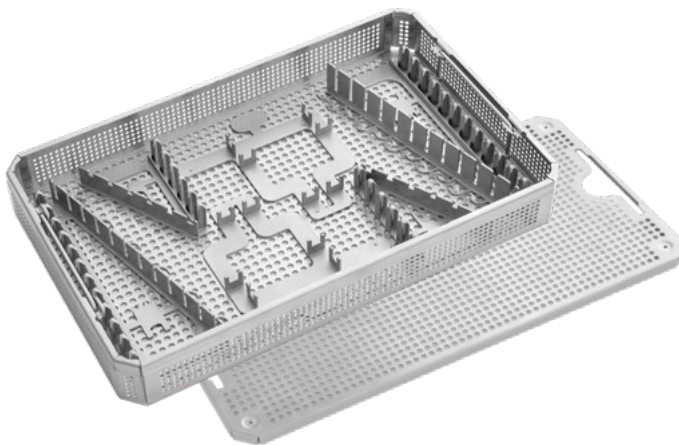

MCCULLOCH

Tray, large, with lid

405 x 253 x 50mm 259-170-002

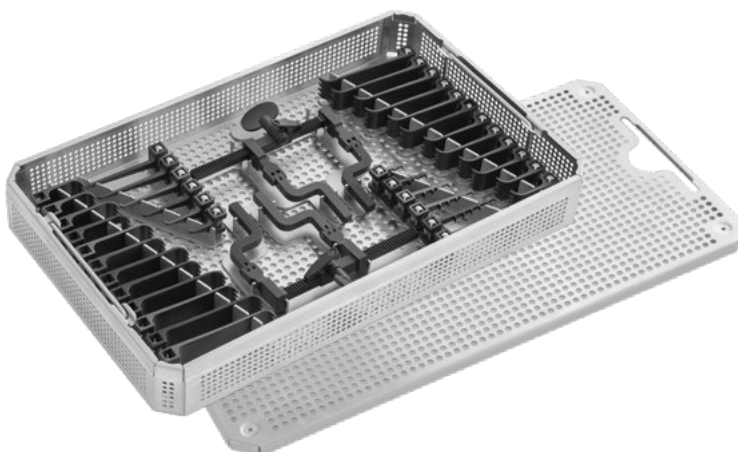

MCCULLOCH

Set with Tray, large 259-170-002
and hinged retractors,
blades 2 each, 1 hook each

259-170-003

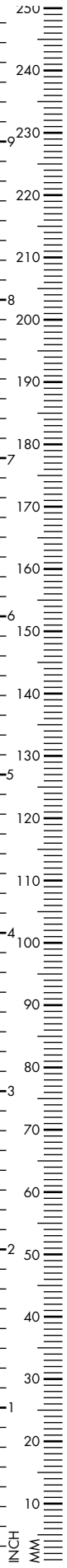

MCCULLOCH MICRO DISCECTOMY RETRACTOR

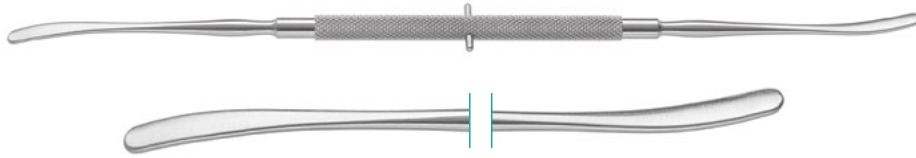

Double Ended Elevator
230mm, 9" 259-160-042



Osteotome, 215mm, 8¹/₂"
4mm wide 259-210-004
6mm wide 259-210-006



Hockey-Stick Chisel, 215mm, 8¹/₂"
left curved 259-210-005
right curved 259-211-005

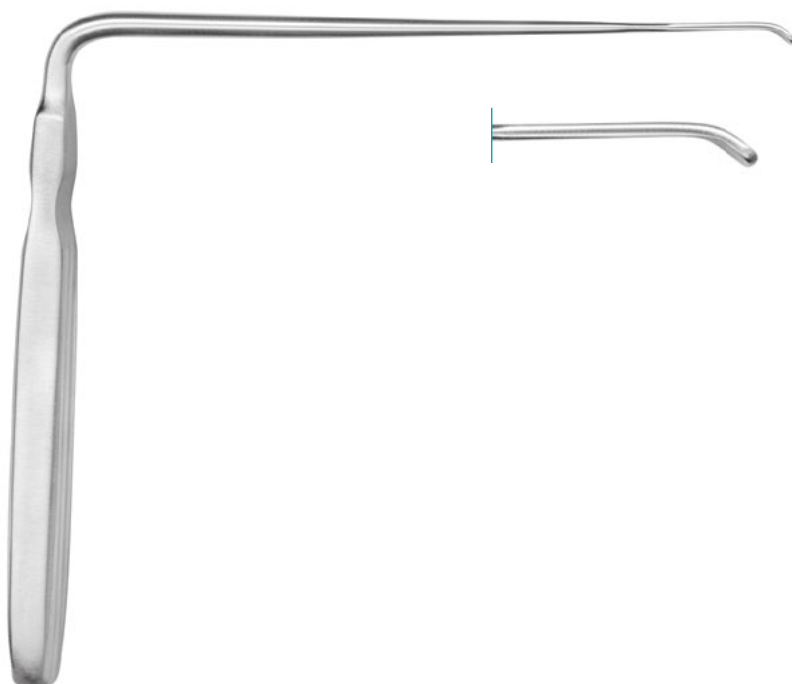

Nerve Root Retractor, 90° angled shaft
6mm wide tip 259-160-006

MCCULLOCH MICRO DISCECTOMY RETRACTOR



Ball Probe, 235mm, 9¹/₄"

A 4mm tip 259-230-004

B 7mm tip 259-230-007

Manipulation Hook, 235mm, 9¹/₄"

C 4mm tip 259-230-104



Spinal Elevator, semi-sharp, 290mm, 11¹/₂"

12mm wide tip 259-440-100

19mm wide tip 259-450-100

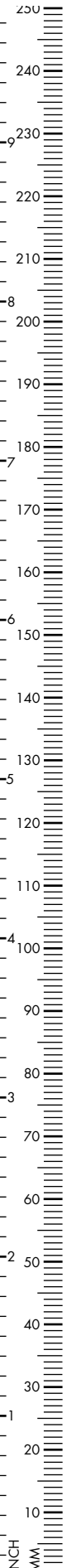

CASPAR WOUND RETRACTOR



CASPAR

Retractor with key

259-185-449



CASPAR

Hook

38mm 259-185-435

58mm 259-185-437



CASPAR

Blade, 2 prongs

32x22mm 259-185-442

52x22mm 259-185-445

62x22mm 259-185-447



CASPAR

Blade, 3 prongs

37x37mm 259-185-452

62x37mm 259-185-457



CASPAR

Blade, 4 prongs

37x52mm 259-185-462

67x52mm 259-185-467



HUDSON

Hand Drill, complete with 4 burrs and extension
(Hudson tightening screw)

270mm, 10^{2/3}" 200-152-000

Hand Drill only with clamping screw

200-150-000

Hand Drill only with Hudson snap lock

200-151-000



Burrs, 60mm length

A Ø 9mm 200-152-001

B Ø 14mm 200-152-002

C Ø 16mm 200-152-003

D Ø 22mm 200-152-004



Extension piece

200-152-009

**RANEY**

Scalp Haemostasis Clip, 10 pcs. per package

250-066-001

black

250-066-002

**RANEY**Applying and Removing Forceps
for 250-066-001160mm, 6¹/₄"

250-066-003

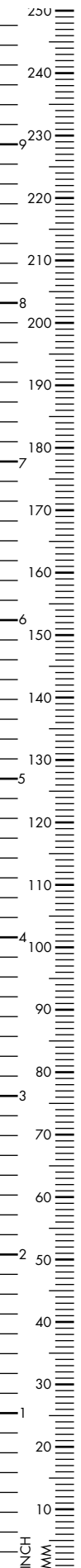

YASARGIL

Suction Cannula, Ø 1.5mm

130mm, 5 ¹ / ₈ "	250-064-152
150mm, 6"	250-064-154
180mm, 7"	250-064-156
220mm, 8 ² / ₃ "	250-064-158

Ø 2.0mm

130mm, 5 ¹ / ₈ "	250-064-162
150mm, 6"	250-064-164
180mm, 7"	250-064-166
220mm, 8 ² / ₃ "	250-064-168

Ø 2.5mm

130mm, 5 ¹ / ₈ "	250-064-172
150mm, 6"	250-064-174
180mm, 7"	250-064-176
220mm, 8 ² / ₃ "	250-064-178

Ø 3.5mm

130mm, 5 ¹ / ₈ "	250-064-182
150mm, 6"	250-064-184
180mm, 7"	250-064-186
220mm, 8 ² / ₃ "	250-064-188

Ø 4.5mm

180mm, 7"	250-064-189
-----------	-------------



FUKUSHIMA

Suction tube, conical, malleable, 165mm, 6^{1/2}"

3 Charr.	165-533-163
4 Charr.	165-533-164
5 Charr.	165-533-165
6 Charr.	165-533-166



FUKUSHIMA

Suction tube, conical, malleable, 180mm, 7"

3 Charr.	165-533-183
4 Charr.	165-533-184
5 Charr.	165-533-185
6 Charr.	165-533-186
7 Charr.	165-533-187
8 Charr.	165-533-188
9 Charr.	165-533-189

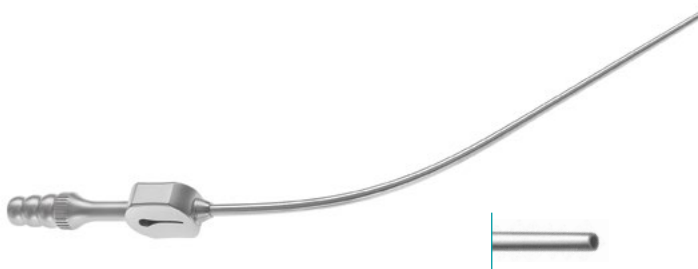

FUKUSHIMA

Suction tube, conical, malleable, 205mm, 8^{1/8}"

3 Charr.	165-533-203
4 Charr.	165-533-204
5 Charr.	165-533-205
6 Charr.	165-533-206
7 Charr.	165-533-207
8 Charr.	165-533-208
9 Charr.	165-533-209
10 Charr.	165-533-210
12 Charr.	165-533-212

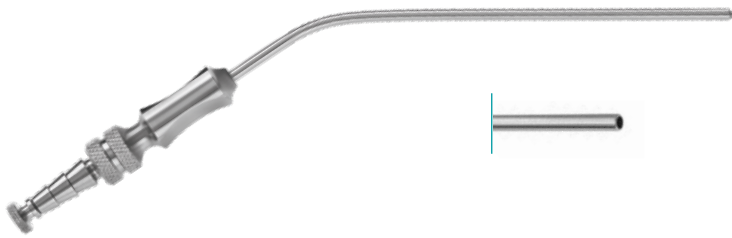
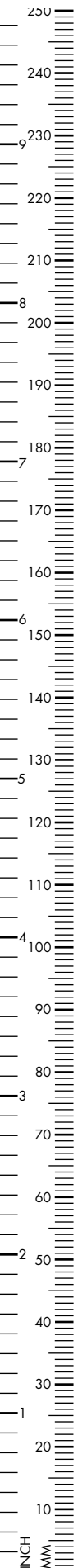

FRAZIER

Suction tube, 30° angled,
190mm, 7¹/₂" overall length

5 Charr.	165-523-005
6 Charr.	165-523-006
7 Charr.	165-523-007
8 Charr.	165-523-008
9 Charr.	165-523-009
10 Charr.	165-523-010
11 Charr.	165-523-011
12 Charr.	165-523-012
15 Charr.	165-523-015



FRAZIER

Suction tube, straight,
130mm, 5¹/₈" working length

6 Charr.	165-522-106
8 Charr.	165-522-108
10 Charr.	165-522-110
12 Charr.	165-522-112



BARON

Suction tube, finger cut-off, stylet, 100mm, 4"

3 Charr.	165-539-003
5 Charr.	165-539-005
7 Charr.	165-539-007



ADSON

Suction tube, Ø 4mm, 210mm, 8¹/₄"

12 Charr.	165-521-004
-----------	-------------



TAYLOR

Percussion Mallet

170mm, 6²/₃" 100-111-170

200mm, 8" 100-111-200



TROEMNER

Percussion Mallet

240mm, 9¹/₂" 100-113-240

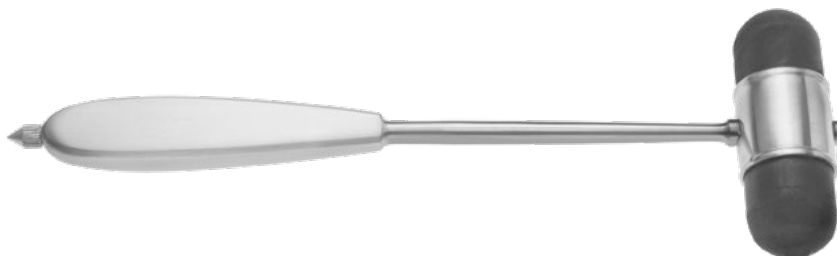

DERJERINE

Percussion Mallet with needle

200mm, 8" 100-115-200

