

# ORTHOPAEDICS

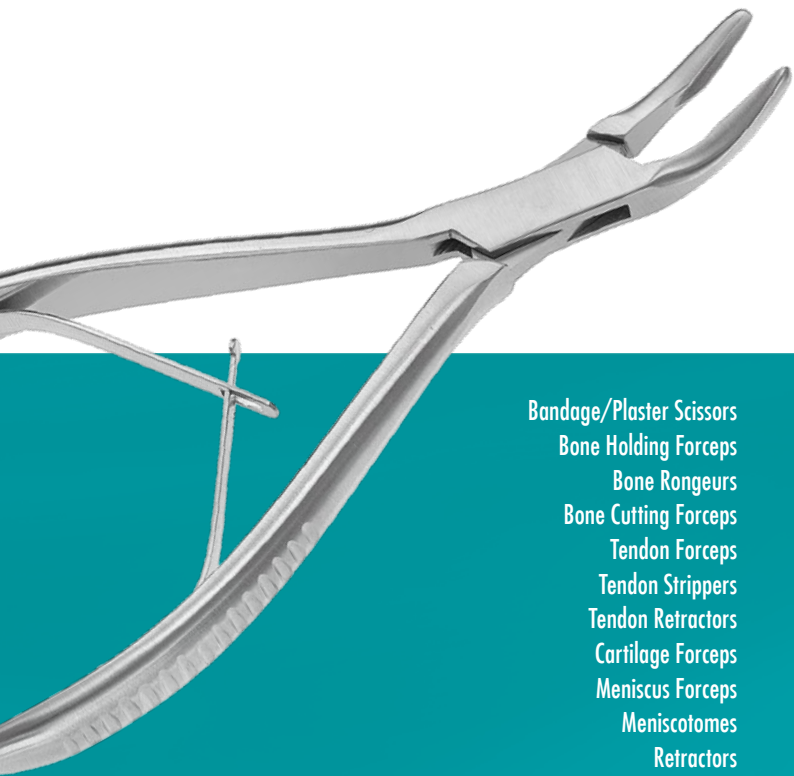

Bandage/Plaster Scissors  
Bone Holding Forceps  
Bone Rongeurs  
Bone Cutting Forceps  
Tendon Forceps  
Tendon Strippers  
Tendon Retractors  
Cartilage Forceps  
Meniscus Forceps  
Meniscotomes  
Retractors  
Bone Levers  
Elevators  
Periosteal Elevators  
Dissectors

Raspatories  
Curettes  
Osteotomes/Gouges/Chisels  
Mallets  
Bone Tampers  
Rasps  
Wire Instruments  
Wire Cutters  
Wire Guides  
Wire Extension  
Reamers, Trephines / Awls  
Hand Drills  
Screw Drivers  
Rulers/Calipers  
Amputation



### LISTER

Plaster Cast / Bandage Scissors

90mm, 3 <sup>1</sup> / <sub>2</sub> "	190-165-090
110mm, 4 <sup>1</sup> / <sub>3</sub> "	190-165-110
140mm, 5 <sup>1</sup> / <sub>2</sub> "	190-165-140
180mm, 7"	190-165-180
200mm, 8"	190-165-200



### TC LISTER

Bandage Scissors

180mm, 7"	190-291-180
-----------	-------------



### LISTER EXCENTRIC

Plaster Cast / Bandage Scissors, serrated

160mm, 6 <sup>1</sup> / <sub>4</sub> "	190-177-160
190mm, 7 <sup>1</sup> / <sub>2</sub> "	190-177-190



### BRUNS

Plaster Scissors, 240mm, 9<sup>1</sup>/<sub>2</sub>"

serrated blade	190-223-240
smooth blade	190-224-240

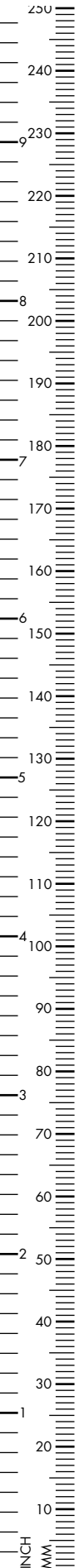



Cloth Scissors, serrated

200mm, 8"	190-211-200
-----------	-------------



**BERGMANN**

Plaster Scissors

230mm, 9"	190-195-230
-----------	-------------



**ESMARCH**

Plaster Scissors

200mm, 8"	190-205-200
-----------	-------------

220mm, 8 <sup>2/3</sup> "	190-205-220
---------------------------	-------------

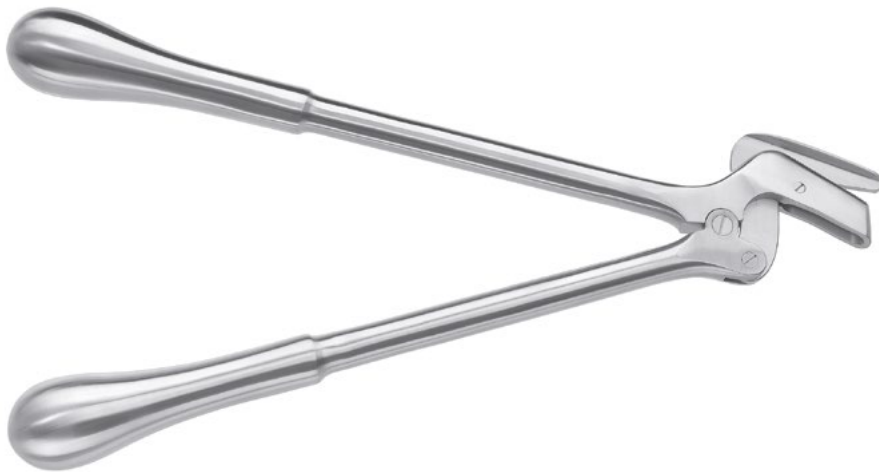

### STILLE

Plaster Cast Scissors

260mm, 10<sup>1</sup>/<sub>4</sub>" 190-250-260

370mm, 14<sup>1</sup>/<sub>2</sub>" 190-250-370



### WALTON

Plaster Cast Spreader, single hand model

230mm, 9" 190-522-230



### HENNING

Plaster Spreader

280mm, 11" 190-516-280



### WOLFF BOEHLER

Plaster Cast Breaker

180mm, 7" 190-530-180

240mm, 9<sup>1</sup>/<sub>2</sub>" 190-530-240

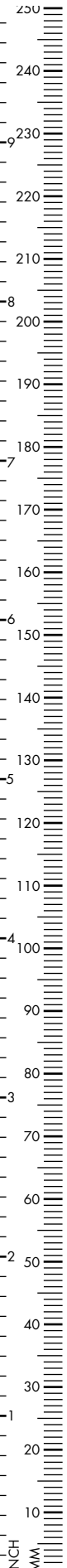





### UNIVERSAL

Plaster and cloth scissors, small,  
140mm, 5 1/2"

black	190-209-151
red	190-209-152
yellow	190-209-153
green	190-209-154



### UNIVERSAL

Plaster and cloth scissors, big,  
180mm, 7"

blue	190-209-180
black	190-209-181
red	190-209-182
yellow	190-209-183
green	190-209-184
orange	190-209-185





Plaster Saw, incl. round saw blade 65mm,  
50mm, pair of wrenches, hexagonal key

230V (black) 200-115-100

110V (blue) 200-115-101



Carry Case with foam inlay

230V 200-115-500



Spare Blade, plaster

Ø 45mm 200-115-145

Ø 50mm 200-115-150

Ø 65mm 200-115-165

Synthetic Cast

Ø 45mm 200-116-145

Ø 50mm 200-116-150

Ø 65mm 200-116-165

PTFE coated (non-stick)

Ø 50mm 200-117-150

Ø 65mm 200-117-165



Vacuum Cleaner

230V 200-118-100



Bone Reposition Forceps

95mm, 3<sup>3</sup>/<sub>4</sub>"

210-651-095



**STAGBETLE**

Bone Reposition Forceps, curved fine tip,  
for small fragments

120mm, 4<sup>3</sup>/<sub>4</sub>"

210-651-120

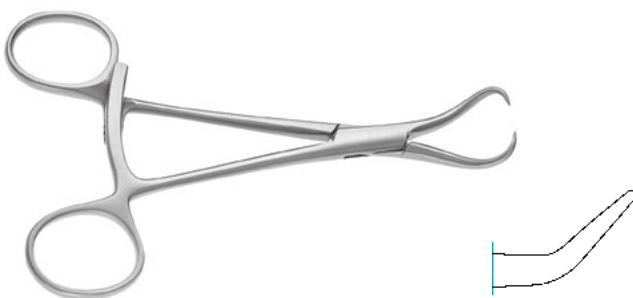

**STEINHAUSER**

Bone Reposition Forceps,  
extra long ratchet

135mm, 5<sup>1</sup>/<sub>3</sub>"

210-651-135

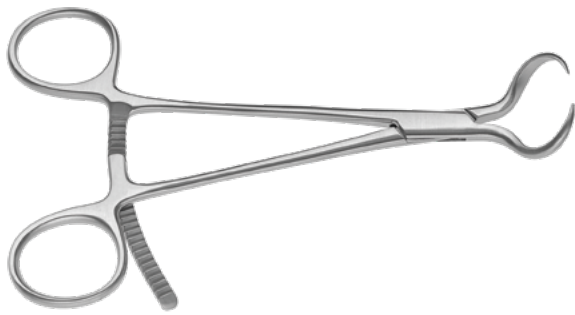

**STEINHAUSER**

Reposition Forceps, extra long ratchet

150mm, 6"

210-651-150



Bone Reposition Forceps  
for maxillary reposition

135mm, 5<sup>1</sup>/<sub>3</sub>"

210-651-130



Bone Reduction Forceps, curved,  
stepped point

135mm, 5<sup>1</sup>/<sub>3</sub>"

210-665-135

170mm, 6<sup>2</sup>/<sub>3</sub>"

210-665-170



**HAASE**

Reposition Forceps

165mm, 6<sup>1</sup>/<sub>2</sub>"

210-251-165

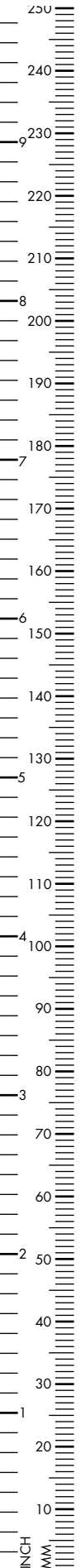



**REILL**

Reposition Forceps

170mm, 6<sup>2</sup>/<sub>3</sub>"

210-649-170

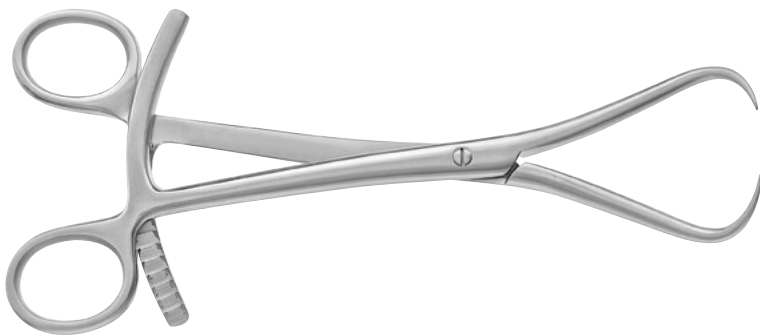

Reposition Forceps

200mm, 8"

210-651-200

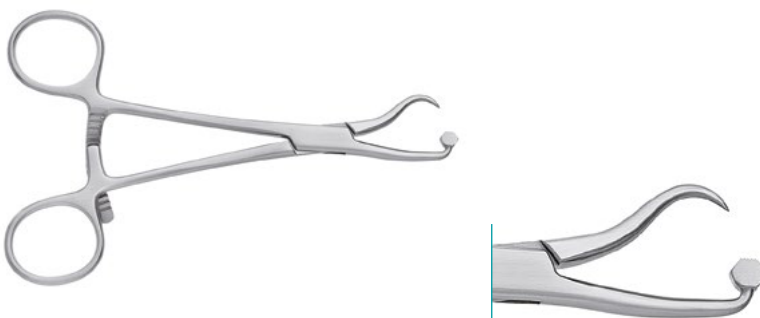

Bone Fragment Clamp

120mm, 4<sup>3</sup>/<sub>4</sub>"

210-631-120

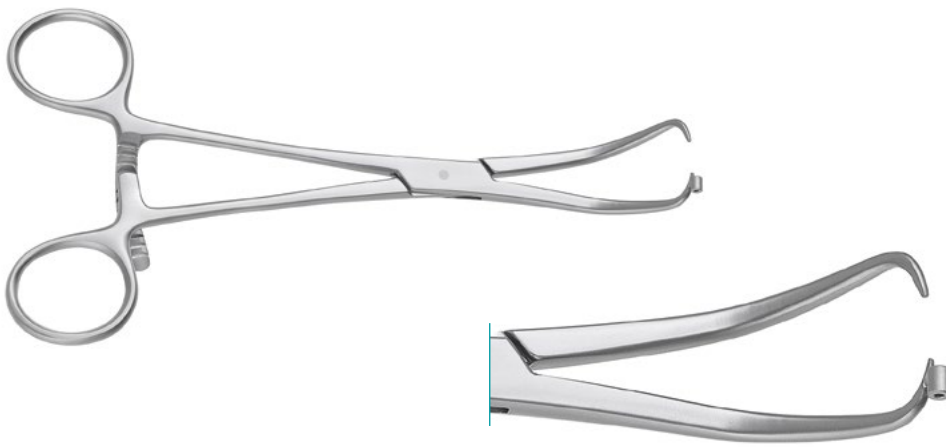

### MEYER

Reposition Forceps for Finger,  
with drill guide

170mm, 6 <sup>2</sup> / <sub>3</sub> "	210-650-170
200mm, 8"	210-650-200

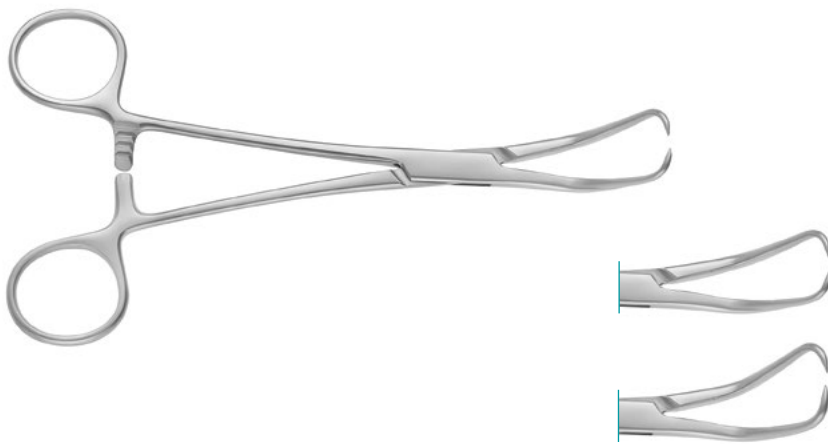

### BANKART

Perforating Forceps, 170mm, 6<sup>2</sup>/<sub>3</sub>"

slightly curved	259-900-000
strongly curved	259-900-001

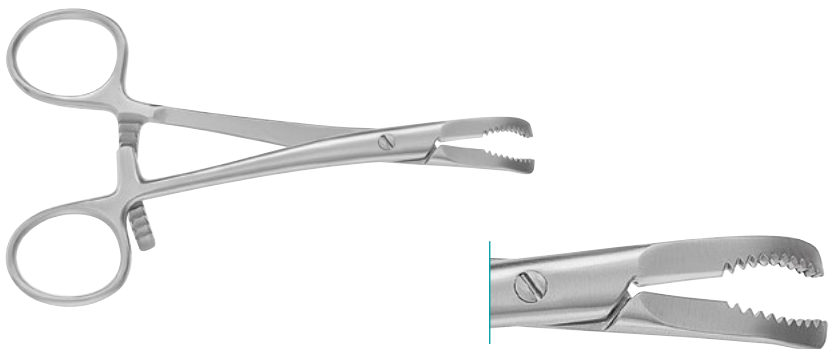

### Reposition Forceps

140mm, 5 <sup>1</sup> / <sub>2</sub> "	210-718-140
--	-------------

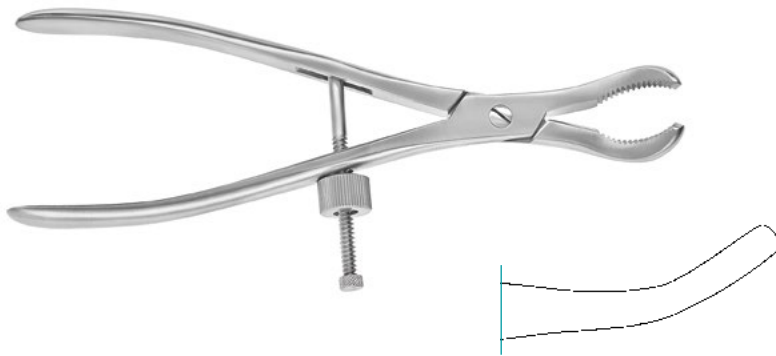

### SETTER

Bone Holding Forceps, curved, speed lock

160mm, 6 <sup>1</sup> / <sub>4</sub> "	210-719-160
225mm, 8 <sup>7</sup> / <sub>8</sub> "	210-719-220

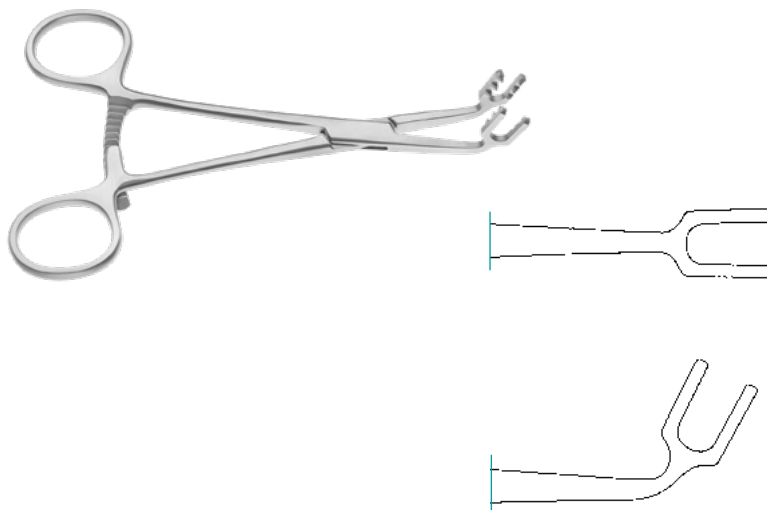

### IKUTA

Bone Clamp, 8 pointed teeth jaw,  
140mm, 5<sup>1</sup>/<sub>2</sub>", straight

5mm space opening	210-654-005
8mm space opening	210-654-008
160mm, 6 <sup>1</sup> / <sub>4</sub> ", straight	
10mm space opening	210-654-010
curved	
5mm space opening	210-655-005
8mm space opening	210-655-008
160mm, 6 <sup>1</sup> / <sub>4</sub> ", curved	
10mm space opening	210-655-010



**LEWIN**

Bone Holding Forceps, serrated, slightly curved

180mm, 7"

210-618-175



Patella Holding Forceps, 2x2 sharp teeth

185mm, 7<sup>1/4</sup>"

210-654-185

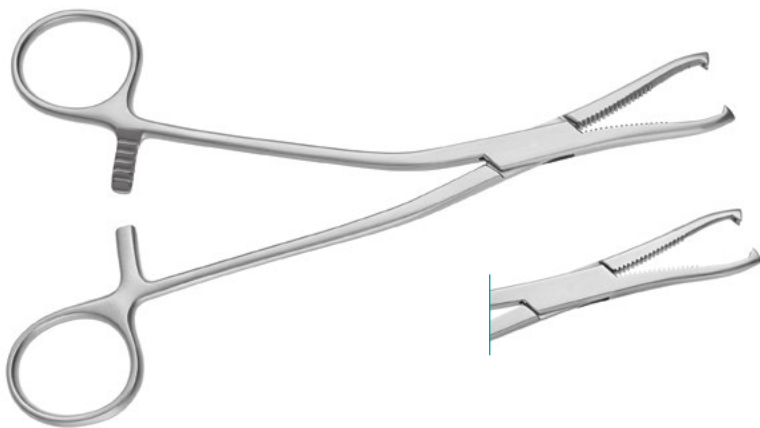
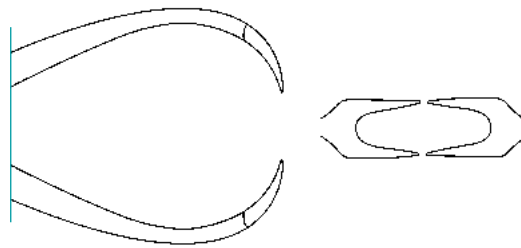

**DINGMANN**

Bone Holding Forceps, delicate pattern

190mm, 7<sup>1/2</sup>"

210-625-190

heavy pattern

190mm, 7<sup>1/2</sup>"

210-626-190

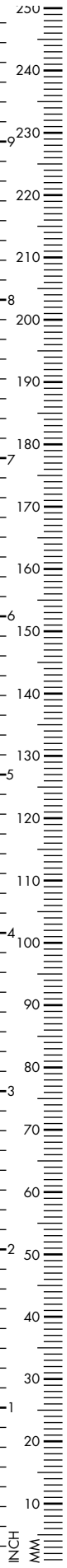



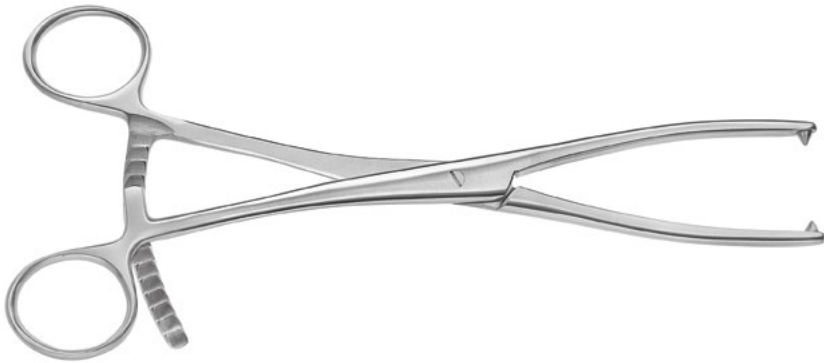

**MEYER**

Malleolar Reposition Forceps

210mm, 8<sup>1/4</sup>"

210-656-210



Bone Holding Forceps

200mm, 8"

210-657-200



**FROSCH**

Bone Holding Forceps

180mm, 7"

210-726-180

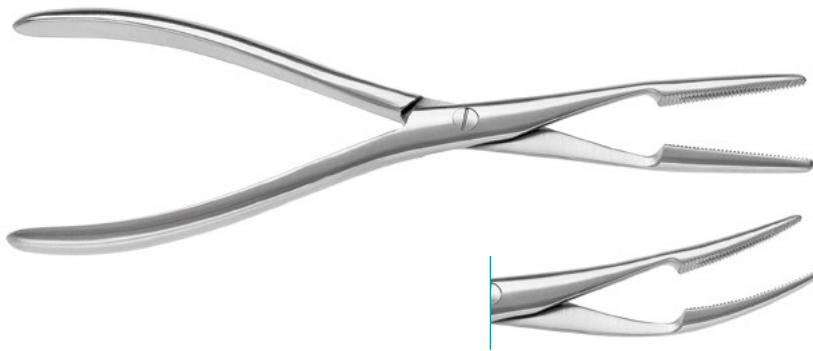

Sequestrum Forceps, 200mm, 8"

Straight 210-610-200

Curved 210-611-200



### VAN BUREN

Sequestrum Forceps, curved

230mm, 9" 210-615-230



### LANGENBECK

Bone Holding Forceps, 11mm wide

210mm, 8<sup>1</sup>/<sub>4</sub>" 210-722-210



### FERGUSON

Bone Holding Forceps, 12mm wide

210mm, 8<sup>1</sup>/<sub>4</sub>" 210-724-210

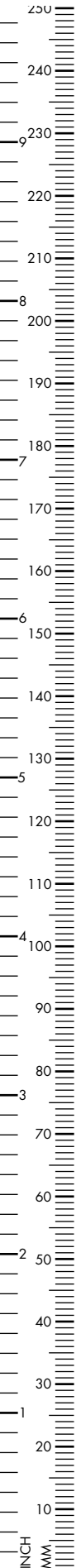



### SEM B

Bone Holding Forceps, laterally curved  
with ratchet

190mm, 7 <sup>1/2</sup> "	210-624-190
---------------------------	-------------

without ratchet

190mm, 7 <sup>1/2</sup> "	210-623-190
---------------------------	-------------



### FARABEU F

Bone Holding Forceps

230mm, 9"	210-630-230
-----------	-------------

260mm, 10 <sup>1/4</sup> "	210-630-260
----------------------------	-------------



### FARABEU LAMBOTTE

Bone Holding Forceps, with ratchet

260mm, 10 <sup>1/4</sup> "	210-634-260
----------------------------	-------------

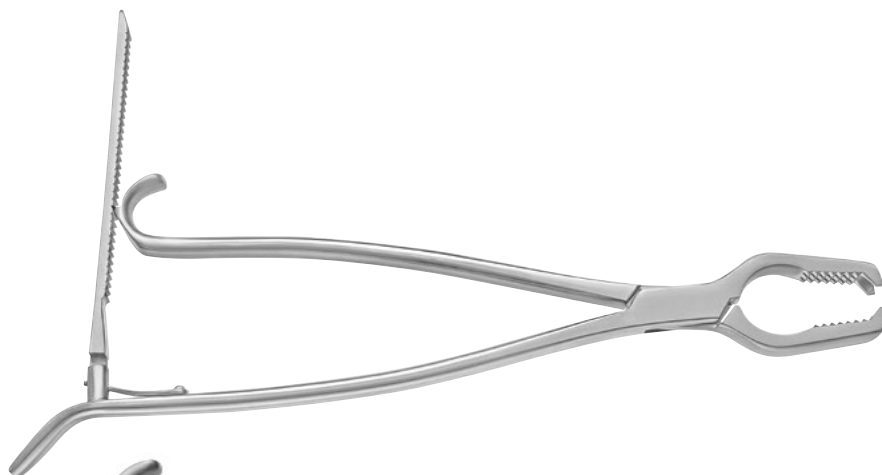
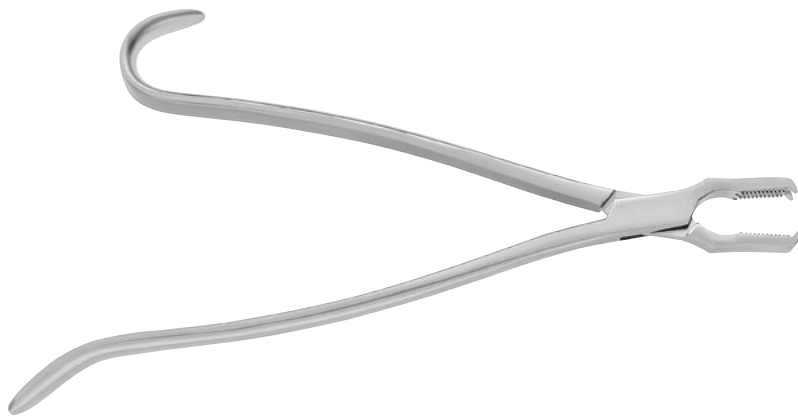
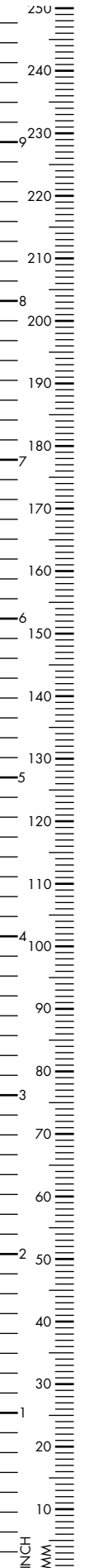

### KERN

Bone Holding Forceps, with ratchet

170mm, 6<sup>2</sup>/<sub>3</sub>" 210-621-170

240mm, 9<sup>1</sup>/<sub>2</sub>" 210-621-210

without ratchet

170mm, 6<sup>2</sup>/<sub>3</sub>" 210-620-170

240mm, 9<sup>1</sup>/<sub>2</sub>" 210-620-210

### LANE

Bone Holding Forceps, with ratchet

330mm, 13" 210-612-330

450mm, 17<sup>3</sup>/<sub>4</sub>" 210-612-450

without ratchet

330mm, 13" 210-610-330

450mm, 17<sup>3</sup>/<sub>4</sub>" 210-610-450



### VERBRUGGE

Bone Holding Forceps

175mm, 6 <sup>7</sup> / <sub>8</sub> "	210-605-170
250mm, 9 <sup>7</sup> / <sub>8</sub> "	210-605-250
260mm, 10 <sup>1</sup> / <sub>4</sub> "	210-605-260
270mm, 10 <sup>2</sup> / <sub>3</sub> "	210-605-270



Bone Holding Forceps, self-centering

150mm, 6"	210-603-150
190mm, 7 <sup>1</sup> / <sub>2</sub> "	210-603-190
240mm, 9 <sup>1</sup> / <sub>2</sub> "	210-603-240
260mm, 10 <sup>1</sup> / <sub>4</sub> "	210-603-260
280mm, 11"	210-603-280



### LAMBOTTE

Bone Holding Forceps, movable jaw

220mm, 8 <sup>2</sup> / <sub>3</sub> ", 10mm jaw width	210-640-220
260mm, 10 <sup>1</sup> / <sub>4</sub> " 13mm jaw width	210-640-270
330mm, 11 <sup>7</sup> / <sub>8</sub> " 16mm jaw width	210-640-300



### HEY GROVE

Bone Holding Forceps

210mm, 8 <sup>1</sup> / <sub>4</sub> "	210-600-230
245mm, 9 <sup>2</sup> / <sub>3</sub> "	210-600-250
270mm, 10 <sup>2</sup> / <sub>3</sub> "	210-600-270
300mm, 11 <sup>7</sup> / <sub>8</sub> "	210-600-300



### ULRICH

Bone Holding Forceps, straight

190mm, 7 <sup>1</sup> / <sub>2</sub> " Fig. 0	210-602-190
230mm, 9" Fig. 1	210-602-230
250mm, 9 <sup>7</sup> / <sub>8</sub> " Fig. 2	210-602-250
280mm, 11" Fig. 3	210-602-280



### ULRICH

Bone Holding Forceps, laterally angled

190mm, 7 <sup>1</sup> / <sub>2</sub> " Fig. 0	210-601-190
230mm, 9" Fig. 1	210-601-230
250mm, 9 <sup>7</sup> / <sub>8</sub> " Fig. 2	210-601-250
280mm, 11" Fig. 3	210-601-280



### LOWMAN

Bone Holding Clamp, 1x2 teeth

130mm, 5 <sup>1</sup> / <sub>8</sub> "	210-980-130
185mm, 7 <sup>1</sup> / <sub>4</sub> "	210-980-185
200mm, 8"	210-980-200
220mm, 8 <sup>2</sup> / <sub>3</sub> "	210-980-220

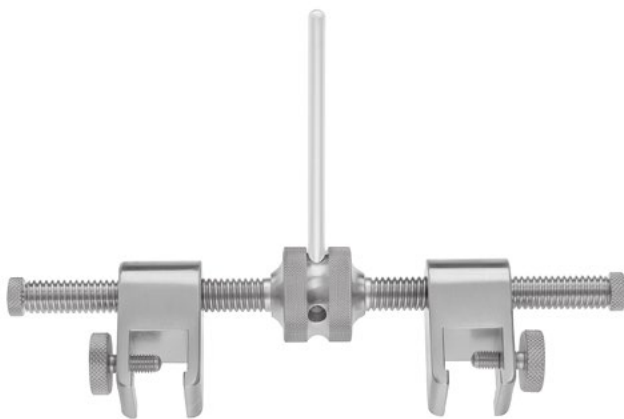

### GERSTER

Traction Bar, max. Ø 25mm

160mm, 6 <sup>1</sup> / <sub>4</sub> "	210-981-150
--	-------------

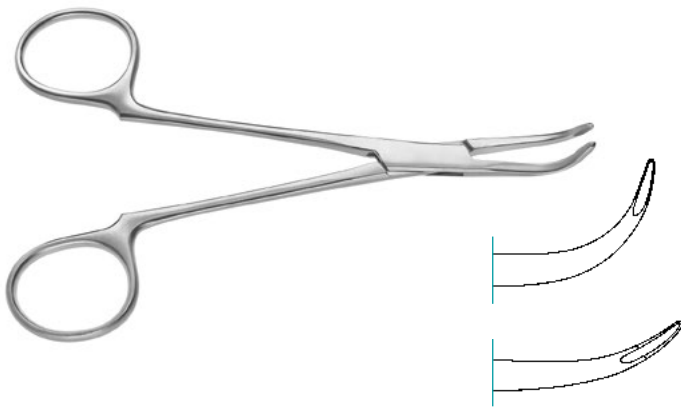
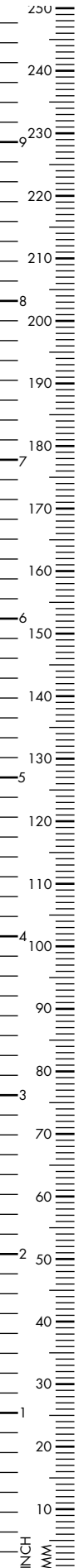

Synovectomy Rongeur, 1.2mm wide jaw  
130mm, 5<sup>1/8</sup>"

Strongly curved 210-773-130

Slightly curved 210-774-130

2.0mm wide jaw

Strongly curved 210-775-130

Slightly curved 210-776-130



### FRIEDMANN

Bone Rongeur, 90°, curved

140mm, 5<sup>1/2</sup>" 210-642-120

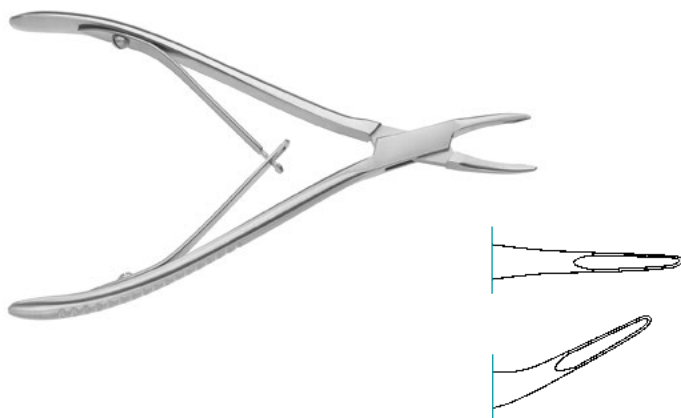

### MINI FRIEDMANN

Bone Rongeur, 1.1mm delicate jaw

140mm, 5<sup>1/2</sup>"

Straight 210-640-150

Curved 210-641-150



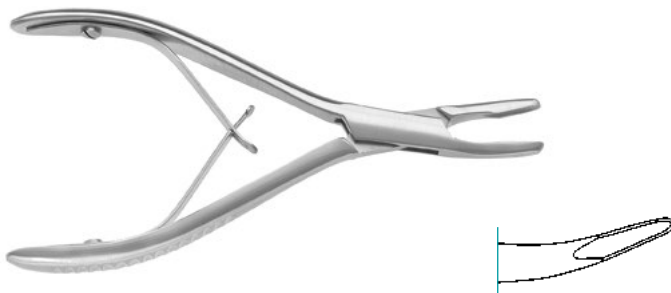

**FRIEDMANN**

Bone Rongeur, 140mm, 5<sup>1</sup>/<sub>2</sub>"

Curved 210-640-140

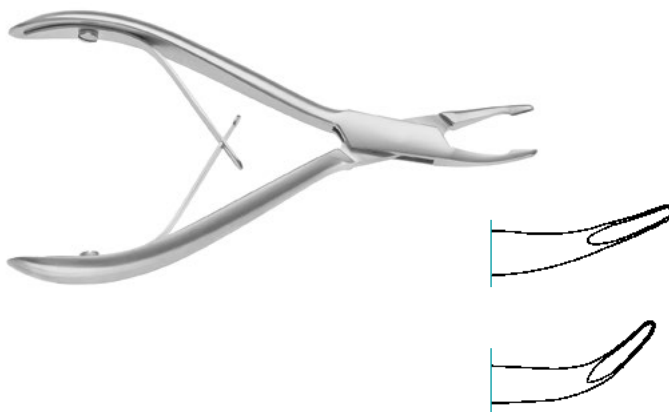

**KLEINERT KUTZ**

Bone Rongeur, 2mm jaw,  
140mm, 5<sup>1</sup>/<sub>2</sub>"

Slightly curved 210-642-140

Strongly curved 210-643-140

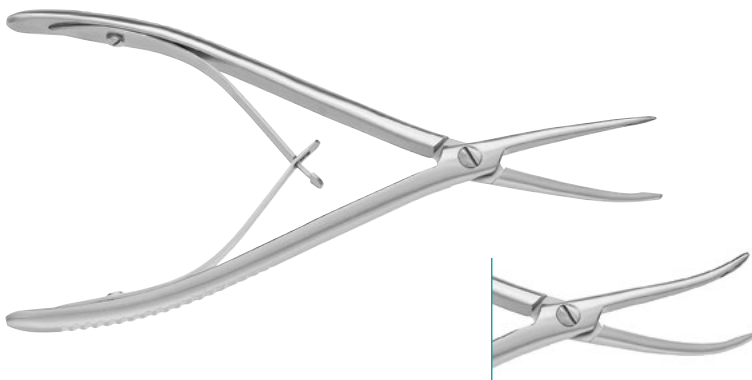

**STELLBRINK**

Synovectomy Rongeur, 2mm jaw,  
170mm, 6<sup>2</sup>/<sub>3</sub>"

Slightly curved 210-777-001

Strongly curved 210-777-002

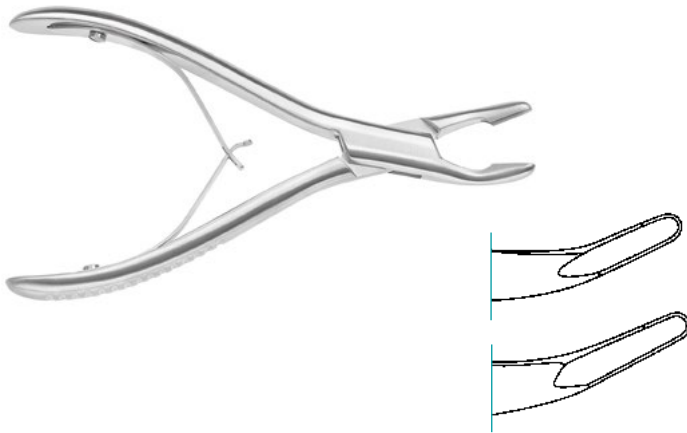
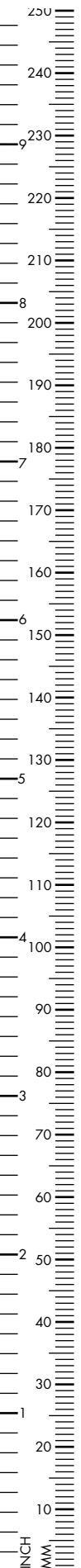

### MEAD CLEVELAND

Bone Rongeur

#4 (Mead)	210-805-140
140mm, 5 <sup>1</sup> / <sub>2</sub> "	
#4A (Cleveland)	210-805-170
170mm, 6 <sup>2</sup> / <sub>3</sub> "	

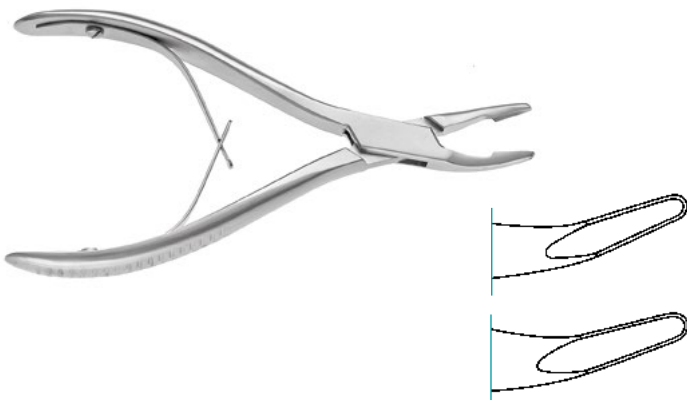

### MEAD

Bone Rongeur

#1, 140mm, 5 <sup>1</sup> / <sub>2</sub> "	210-815-140
#1A, 170mm, 6 <sup>2</sup> / <sub>3</sub> "	210-815-165

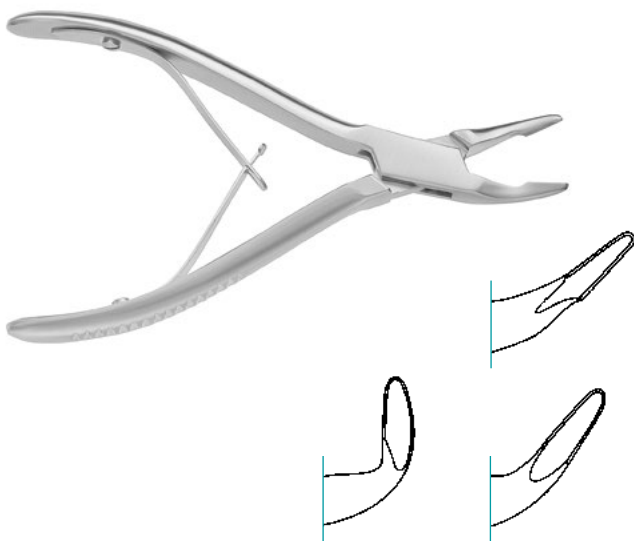

### BLUMENTHAL

Bone Rongeur, 155mm, 6<sup>1</sup>/<sub>8</sub>"

30°	210-691-150
45°	210-693-150
90°	210-695-150



### HARTMANN

Bone Rongeur

160mm, 6<sup>1/4</sup>"

210-819-180

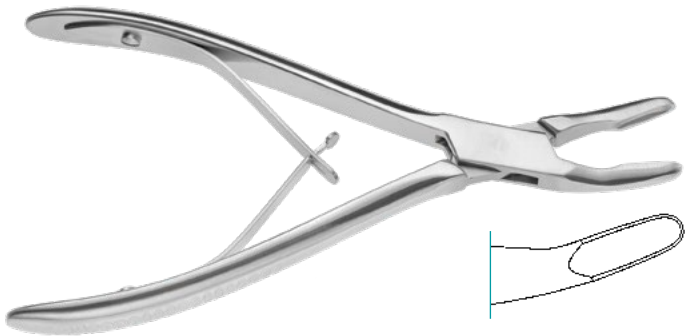

### BANE

Bone Rongeur

180mm, 7"

210-787-180

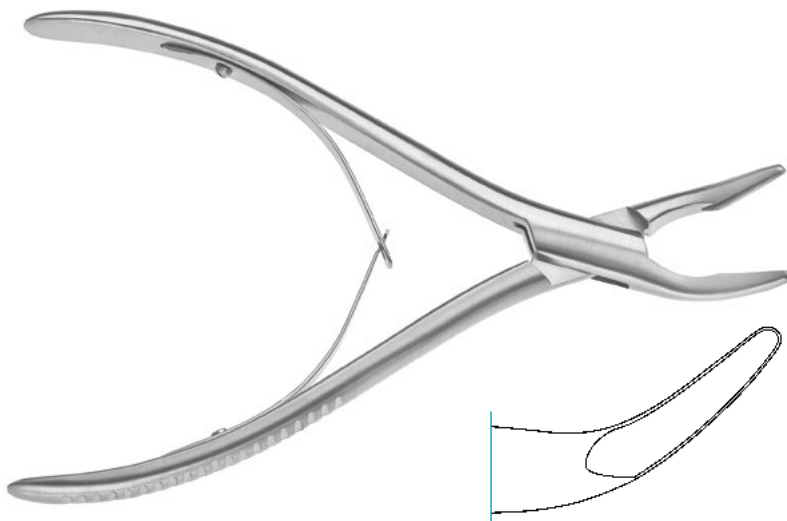

### OLIVECRONA

Bone Rongeur

200mm, 8"

210-470-205

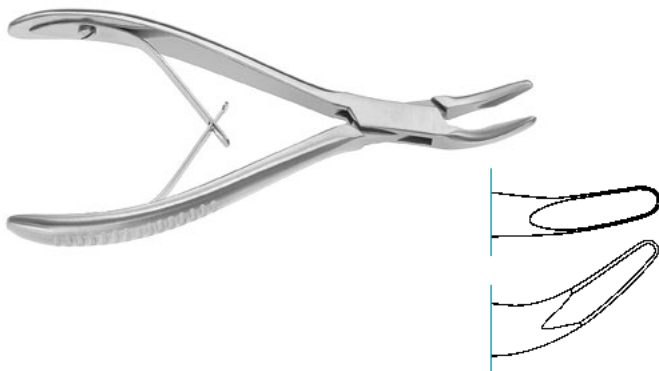
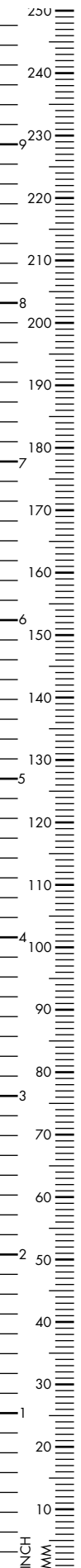

**LUER**

Bone Rongeur, 140mm, 5<sup>1</sup>/<sub>2</sub>"

Slightly curved	210-685-150
Strongly curved	210-687-150

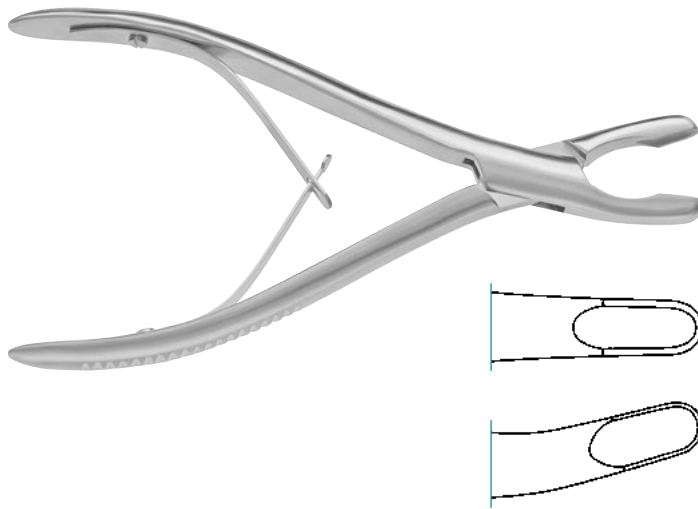

**LUER**

Bone Rongeur, 170mm, 6<sup>2</sup>/<sub>3</sub>"

Straight	210-846-170
Curved	210-847-170

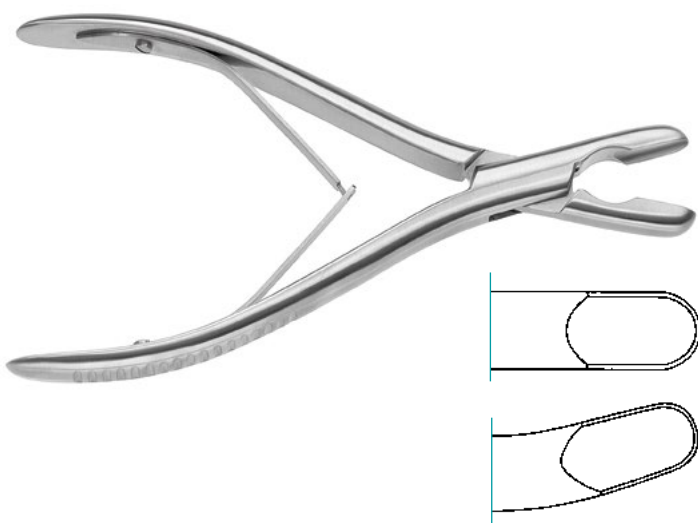

**LUER**

Bone Rongeur, 180mm, 7"

Straight	210-862-180
Curved	210-863-180

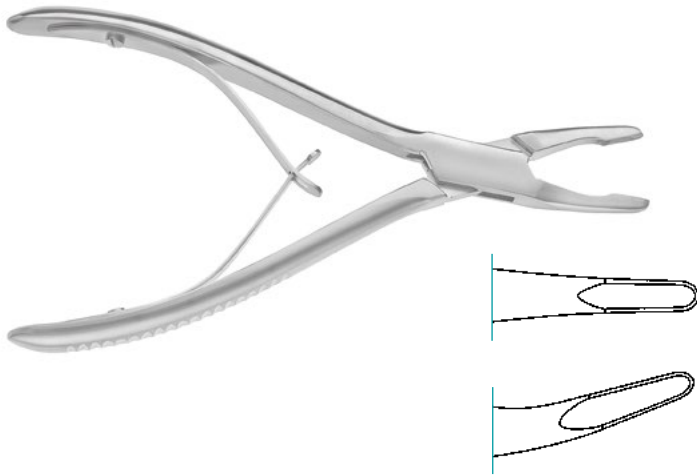

### JANSEN

Bone Rongeur, 170mm, 6<sup>2</sup>/<sub>3</sub>"

Straight 210-826-180

Curved 210-829-180

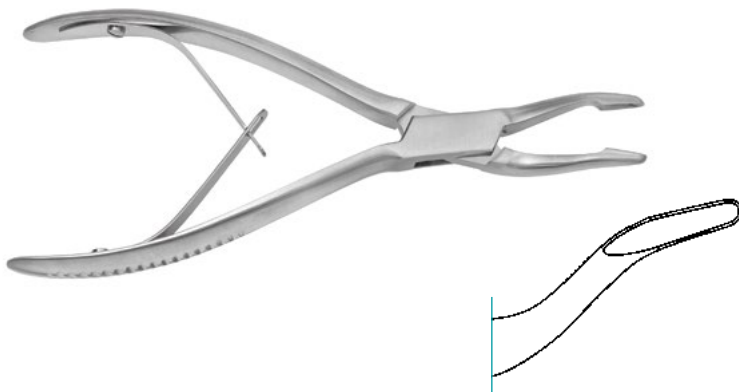

### JANSEN

Bone Rongeur, s-shaped

170mm, 6<sup>2</sup>/<sub>3</sub>" 210-829-170

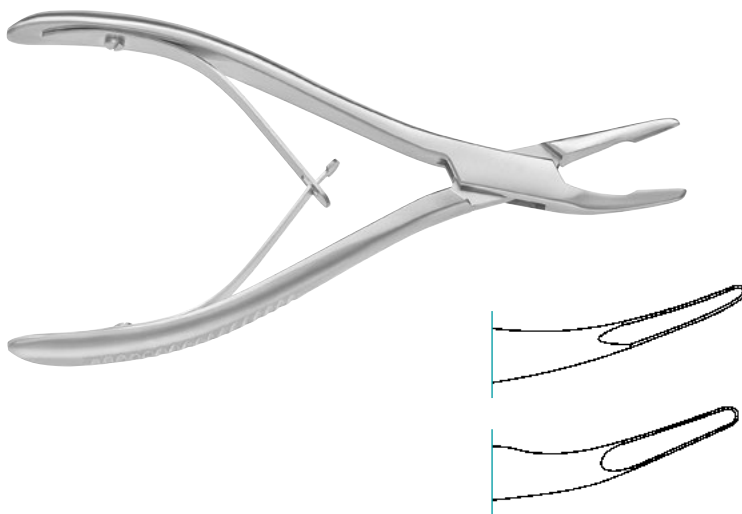

### BEYER

Bone Rongeur, 3x16mm, 180mm, 7"

Curved 210-830-180

Strongly Curved 210-831-180

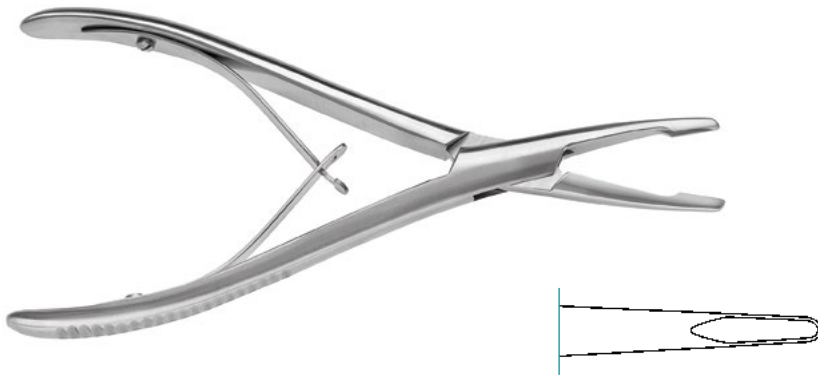

### DEFOURMENTEL

Bone Rongeur, 3mm jaw

190mm, 7<sup>1</sup>/<sub>2</sub>"

210-772-190

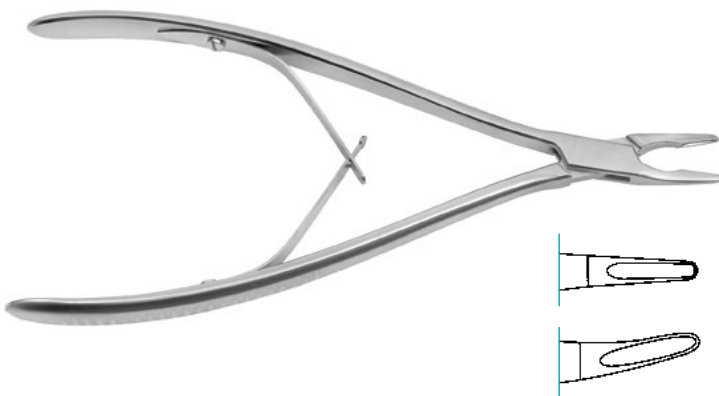

### LEMPERT

Bone Rongeur, 190mm, 7<sup>1</sup>/<sub>2</sub>"

Straight

210-832-185

Curved

210-833-185

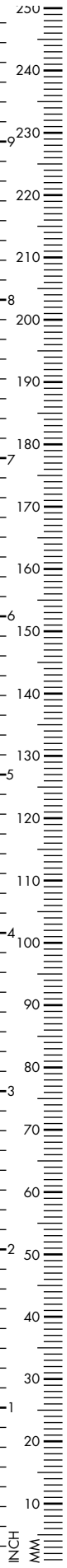

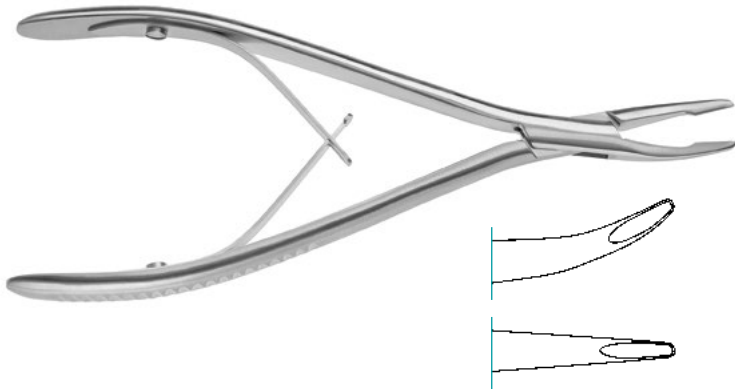

### LEMPERT

Bone Rongeur, curved

160mm, 6<sup>1</sup>/<sub>4</sub>" 210-771-160

straight

160mm, 6<sup>1</sup>/<sub>4</sub>" 210-770-160



### PENNYBACKER

Bone Rongeur, 4mm jaw

200mm, 8" 210-794-200

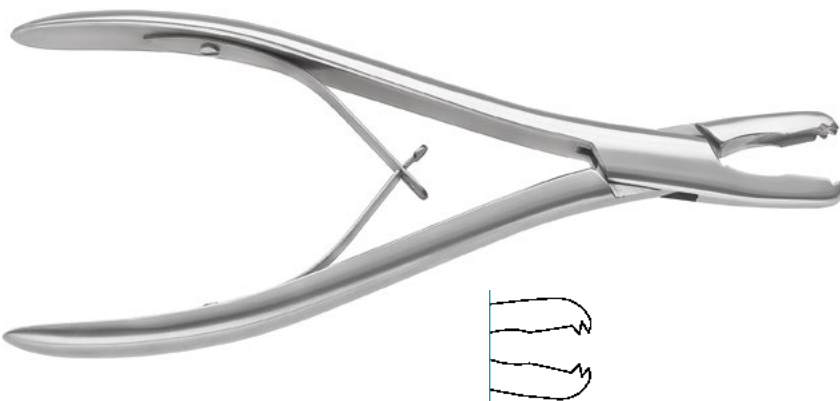

Bone Rongeur, Rat toothed, 3x3 teeth

210, 8<sup>1</sup>/<sub>4</sub>" 210-781-210

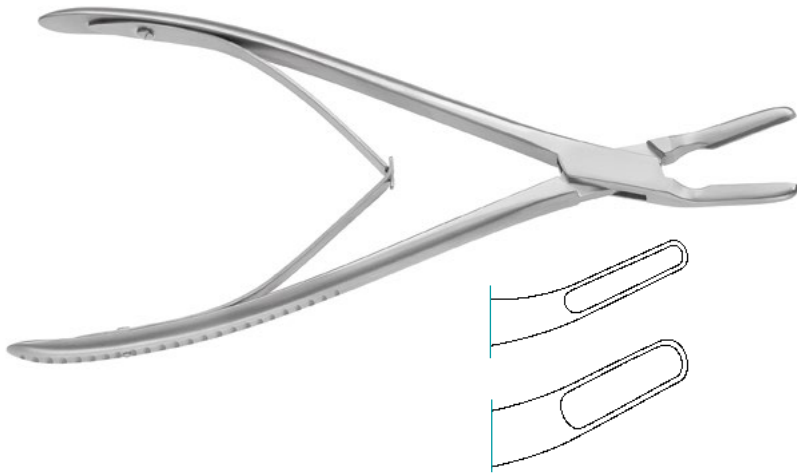

### ZIELKE

Bone Rongeur, 210mm, 8<sup>1</sup>/<sub>4</sub>"

3mm jaw 210-730-003

5mm jaw 210-730-005

250mm, 9<sup>7</sup>/<sub>8</sub>"

3mm jaw 210-731-003

5mm jaw 210-731-005

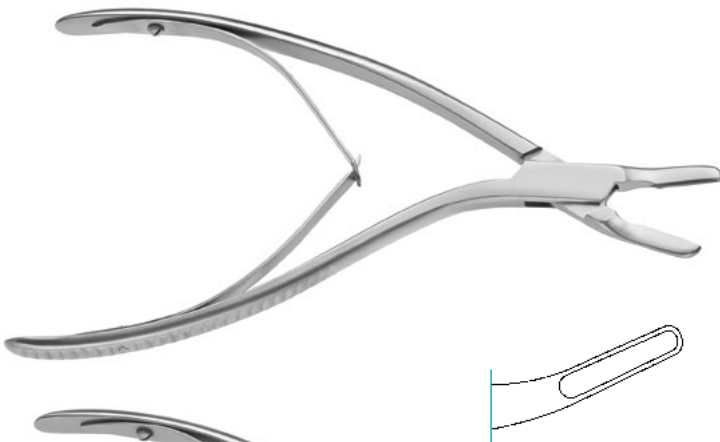

### ZIELKE

Bone Rongeur, 3mm jaw,  
shanks curved right

190mm, 7<sup>1</sup>/<sub>2</sub>" 210-732-002

shanks curved left

190mm, 7<sup>1</sup>/<sub>2</sub>" 210-733-003

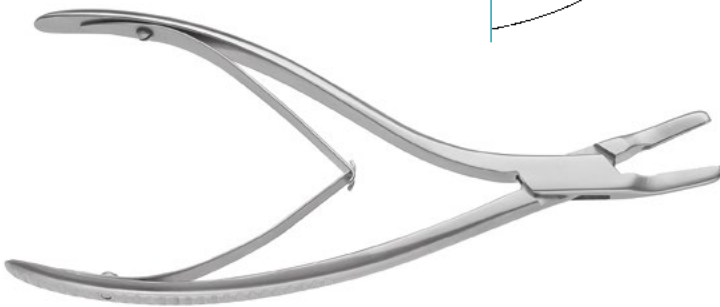

230  
240  
230  
220  
210  
200  
190  
180  
170  
160  
150  
140  
130  
120  
110  
100  
90  
80  
70  
60  
50  
40  
30  
20  
10  
INCH  
MM



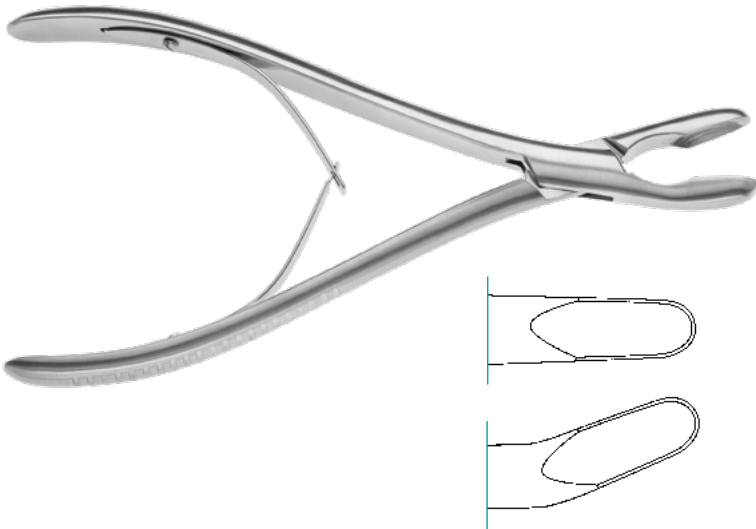

### ADSON

Bone Rongeur, 200mm, 8"

Straight	210-845-200
Curved	210-846-200

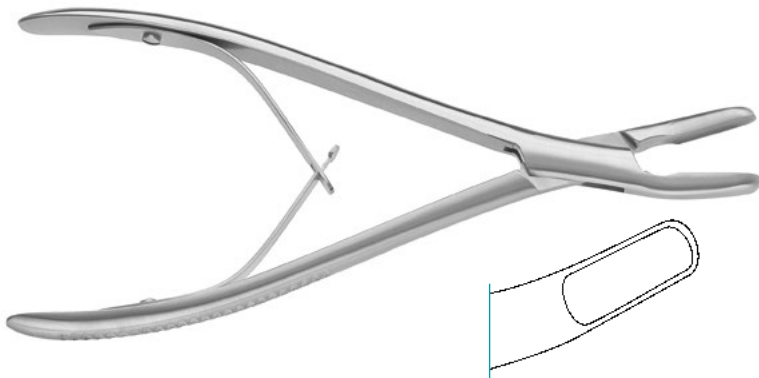

### MATZEN

Intervertebral Bone Rongeur, 8mm jaw

200mm, 8"	210-732-200
-----------	-------------

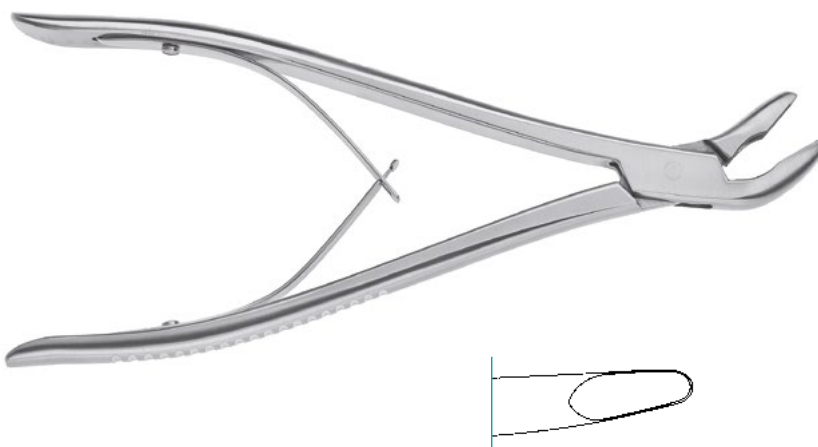

### BACON

Bone Rongeur, angled jaw

200mm, 8"	210-795-195
-----------	-------------

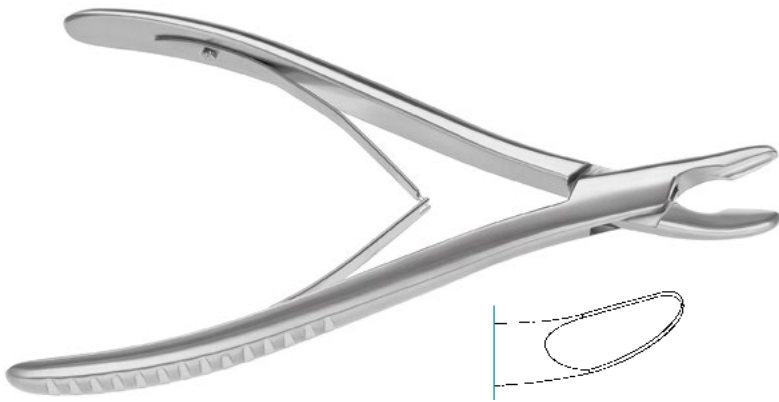
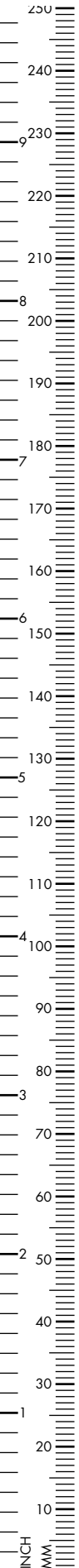

**GULEKE**

Bone Rongeur, curved

205mm, 8<sup>1/8</sup>"

210-847-205



**HAKANSSON**

Bone Rongeur, curved laterally

160mm, 6<sup>1/4</sup>"

210-825-160



**TROTTER**

Bone Rongeur, angled laterally

200mm, 8"

210-839-200

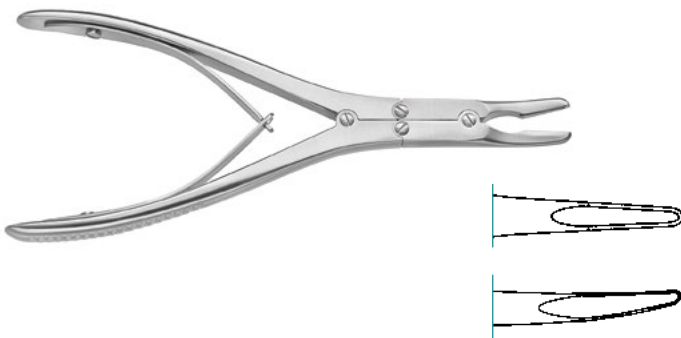

### MINI RUSKIN

Bone Rongeur, 2mm, 150mm, 6"

Straight	210-802-150
Curved	210-812-150

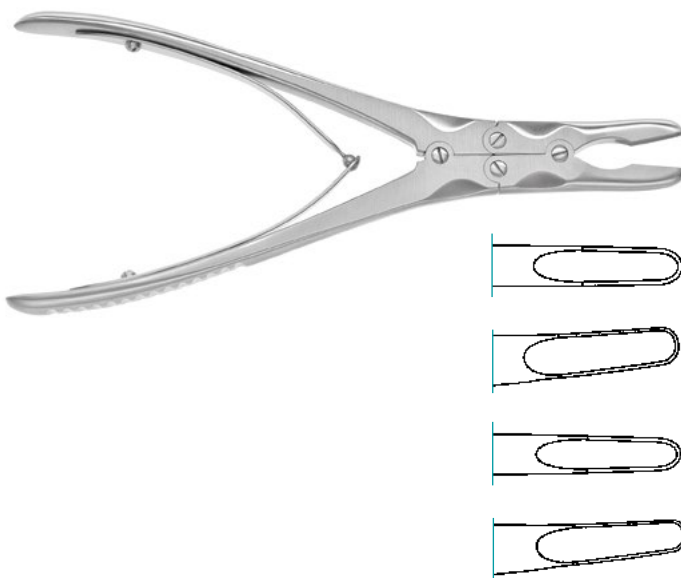

### RUSKIN

Bone Rongeur, 5mm, 180mm, 7"

Straight	210-800-180
Curved	210-801-180

### 4mm

Straight	210-802-180
Curved	210-803-180

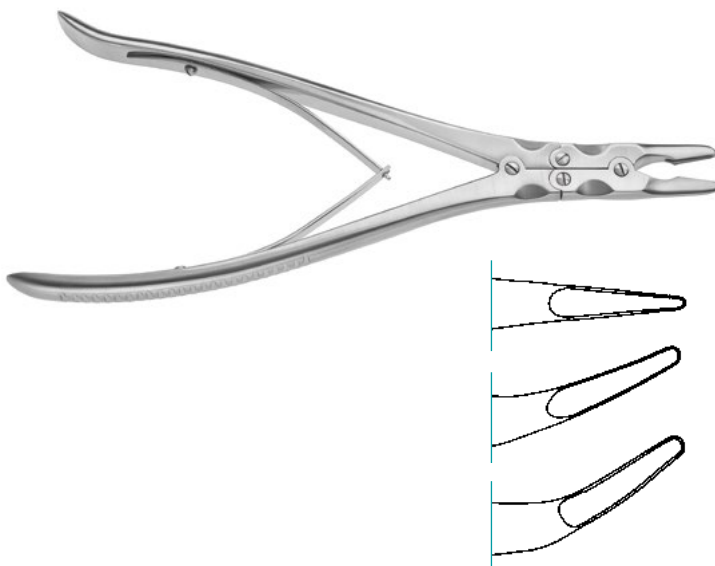

### SMITH PETERSEN

Bone Rongeur, 3mm jaw, 190mm, 7<sup>1/2</sup>"

Straight	210-832-190
Slightly Curved	210-834-190
Strongly Curved	210-836-190

### 4mm jaw

Straight	210-832-194
Slightly Curved	210-834-194
Strongly Curved	210-836-194

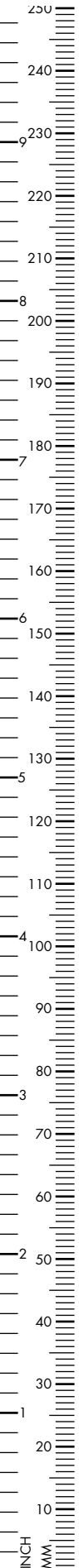

### BOEHLER

Bone Rongeur, curved, 150mm, 6"

3mm jaw 210-789-150

straight

3mm jaw 210-788-150

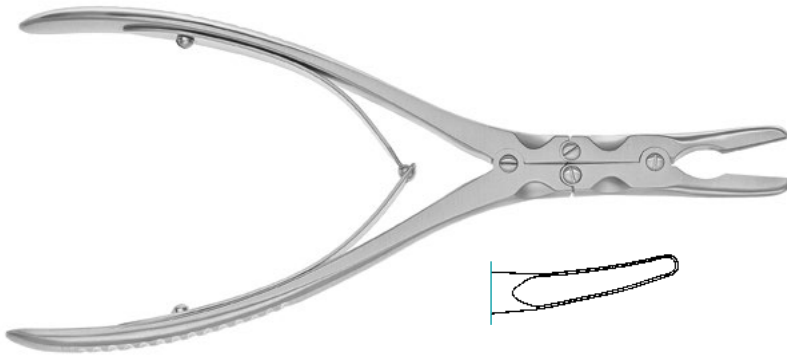

### MARQUARDT

Bone Rongeur, curved, 3mm

200mm, 8" 210-780-200



### BEYER

Bone Rongeur, curved,  
180mm, 7"

3mm 210-789-180

4mm 210-790-180



### ZAUFAL JANSEN

Bone Rongeur, curved, 5mm jaw

180mm, 7" 210-791-180

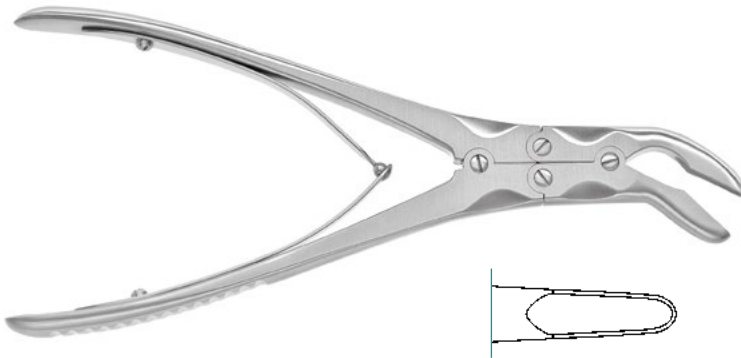

### RUSKIN

Bone Rongeur, angled laterally

180mm, 7"

210-805-180

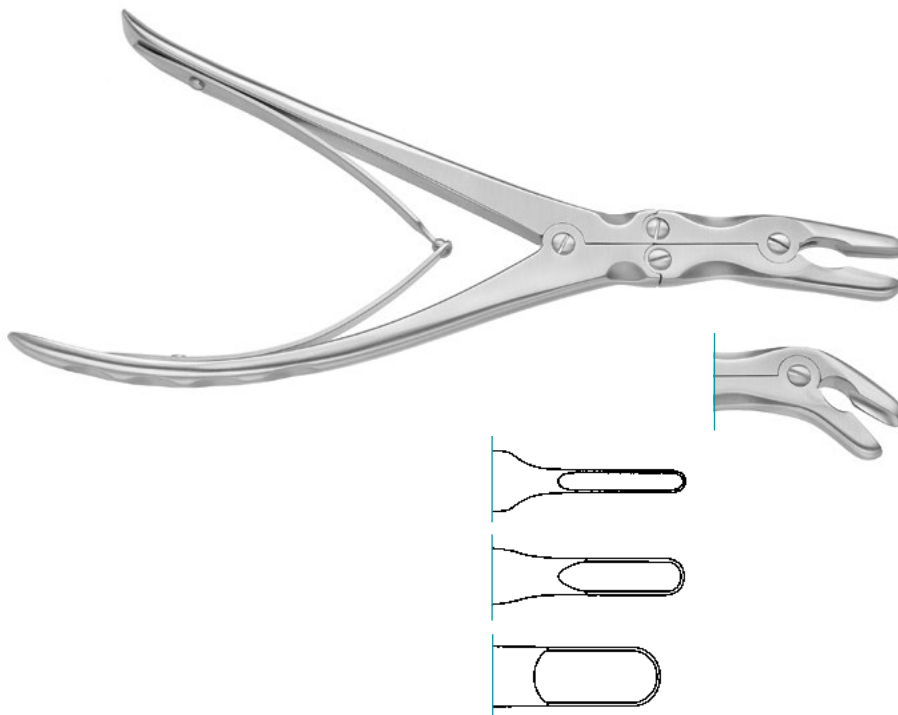

### LEKSELL STILLE

Bone Rongeur, curved laterally, 240mm, 9<sup>1</sup>/<sub>2</sub>"

3mm

210-843-240

5mm

210-851-240

8mm

210-850-240

curved strongly laterally

5mm

210-852-240

8mm

210-858-240

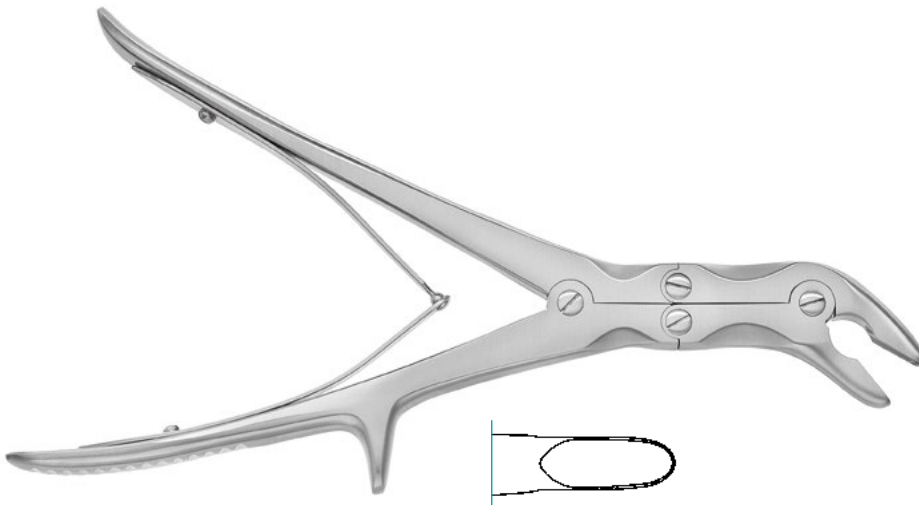

### STILLE

Bone Rongeur, sideways curved, 230mm, 9"

6mm	210-907-230
8mm	210-908-230

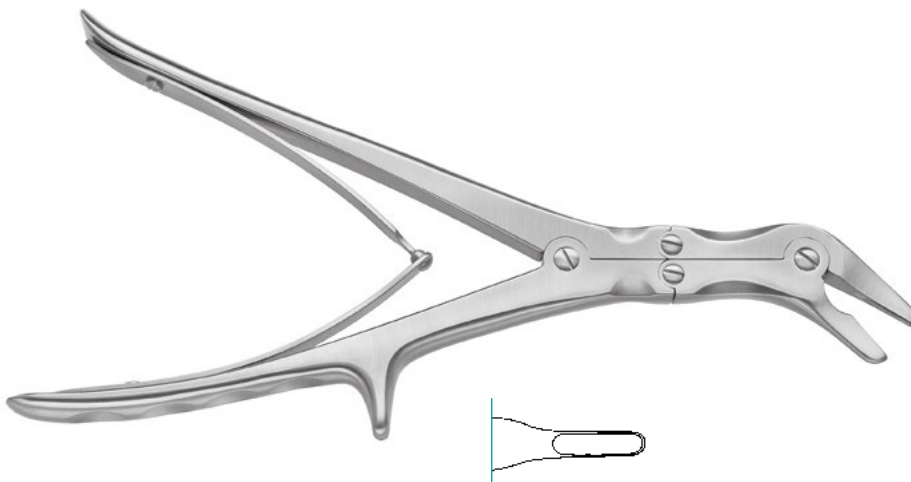

### ECHLIN

Bone Rongeur, 230mm, 9"

2x10mm	210-798-230
3x10mm	210-799-230
4x10mm	210-797-230

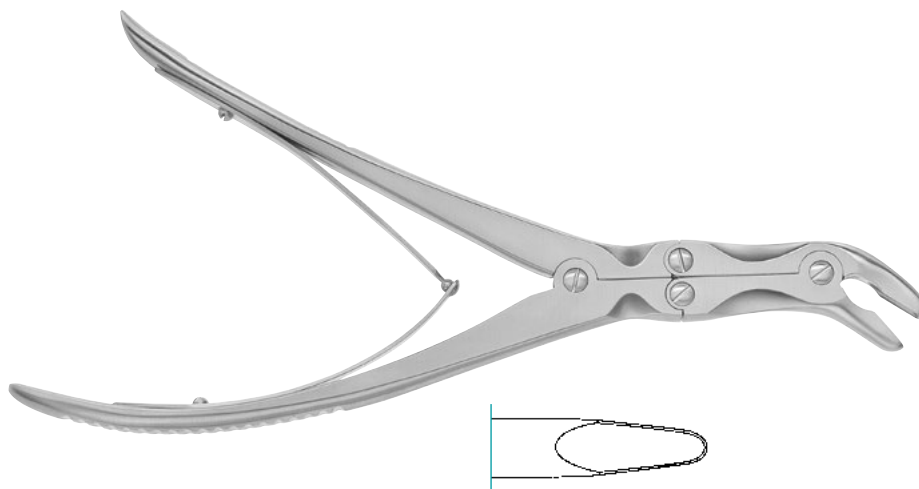

### FRYKHOLM

Bone Rongeur, s-curved, 5mm jaw

240mm, 9 <sup>1</sup> / <sub>2</sub> "	210-855-240
--	-------------

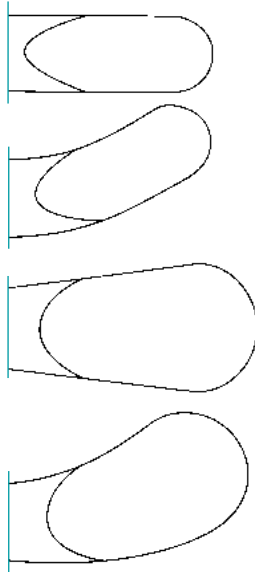
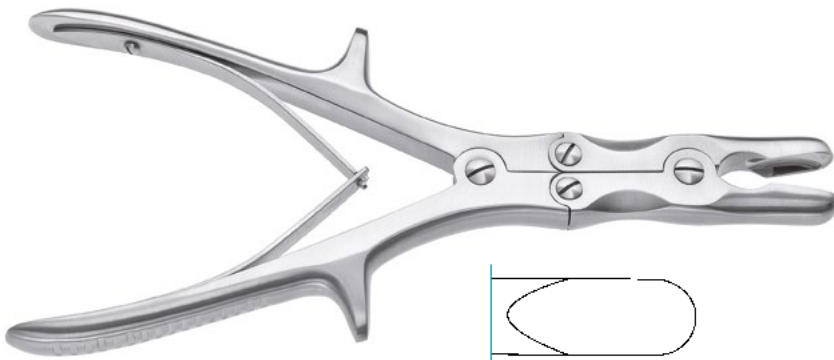

### STILLE LUER

Bone Rongeur, straight, 220mm, 8<sup>2</sup>/<sub>3</sub>"

10mm	210-907-220
------	-------------

17mm	210-910-220
------	-------------

curved

10mm	210-911-220
------	-------------

17mm	210-909-220
------	-------------

straight, 270mm, 10<sup>2</sup>/<sub>3</sub>"

17mm	210-910-260
------	-------------

curved

17mm	210-911-260
------	-------------

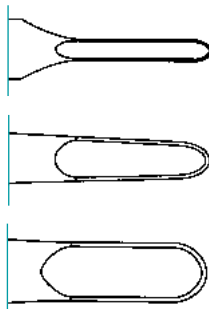

### DALE LEKSELL

Bone Rongeur, XL Handle

3mm	210-843-360
-----	-------------

5mm	210-845-360
-----	-------------

8mm	210-848-360
-----	-------------

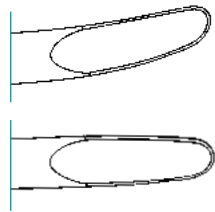
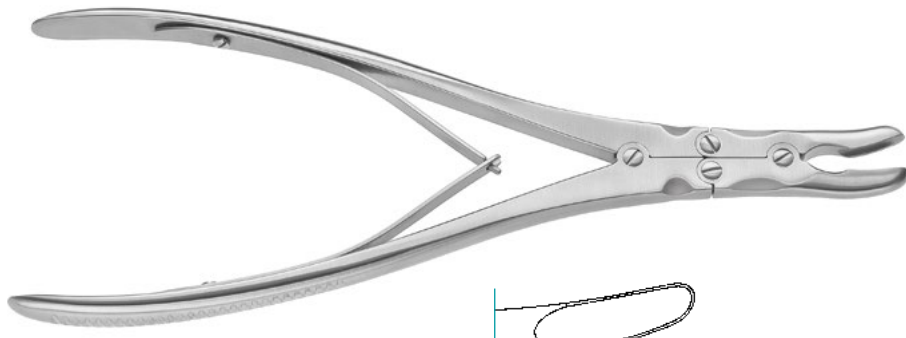
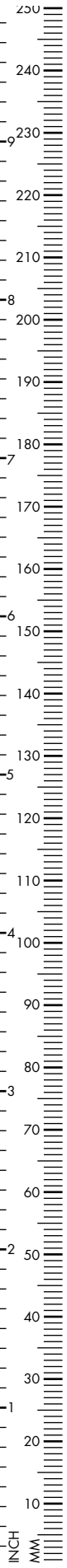

### ROETTGEN RUSKIN

Bone Rongeur, 240mm, 9<sup>1</sup>/<sub>2</sub>"

5mm, curved	210-792-230
5mm, straight	210-793-230
6mm, curved	210-796-230

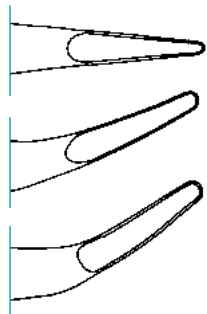
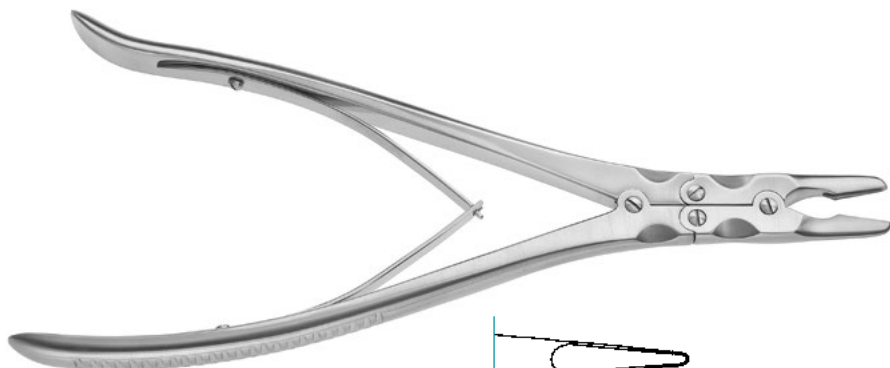

### SMITH PETERSEN

Bone Rongeur, 3mm jaw, 240mm, 9<sup>1</sup>/<sub>2</sub>"

Straight	210-832-240
Slightly Curved	210-834-240
Strongly Curved	210-836-240

### 4mm jaw

Straight	210-832-244
Slightly Curved	210-834-244
Strongly Curved	210-836-244



### STILLE RUSKIN

Bone Rongeur, 6mm jaw, 230mm, 9"

Straight	210-898-230
Curved	210-899-230

### 8mm jaw

Straight	210-900-230
Curved	210-901-230





### SYPERT

Bone Rongeur, straight, 350mm, 14"

3mm	210-813-350
5mm	210-815-350
8mm	210-818-350
curved	
3mm	210-803-350
5mm	210-805-350
8mm	210-808-350

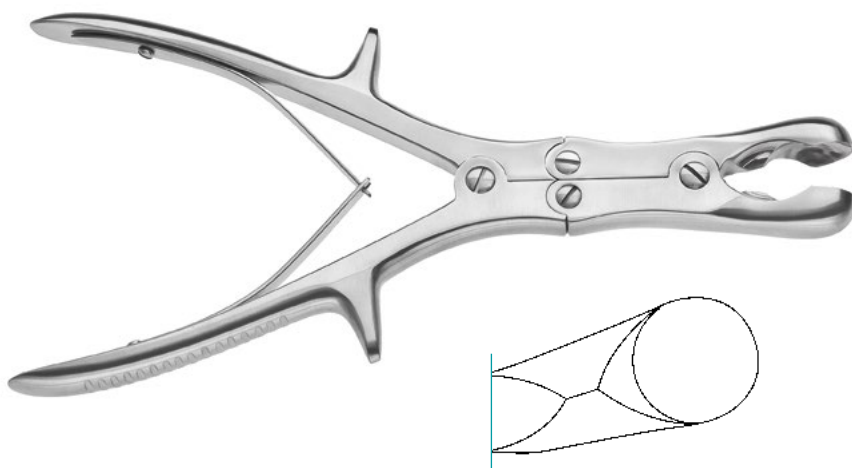

### SEMB

Bone Rongeur, curved

225mm, 8 <sup>7/8</sup> "	210-905-225
---------------------------	-------------

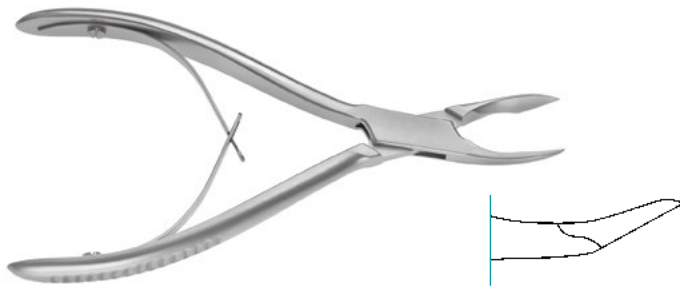
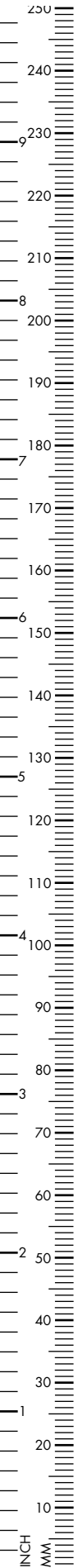

### NIRO

Bone Cutting Forceps, angled

140mm, 5 <sup>1</sup> / <sub>2</sub> "	210-845-130
--	-------------

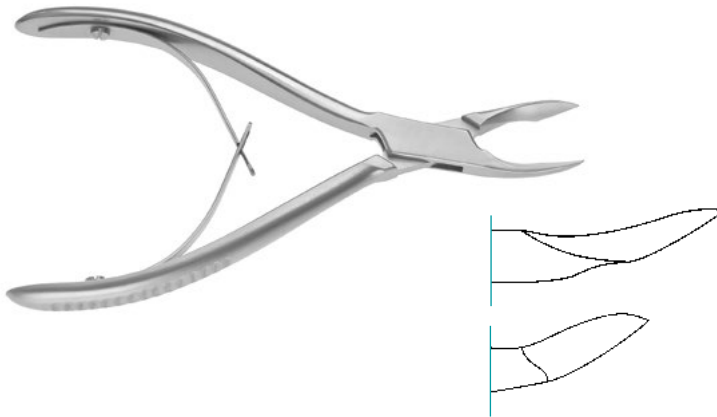

### CLEVELAND

Bone Cutting Forceps, angled on flat

145mm, 5 <sup>3</sup> / <sub>4</sub> "	210-845-145
170mm, 6 <sup>2</sup> / <sub>3</sub> "	210-845-170



### LITTAUER

Bone Cutting Forceps with spring

150mm, 6"	210-397-150
-----------	-------------

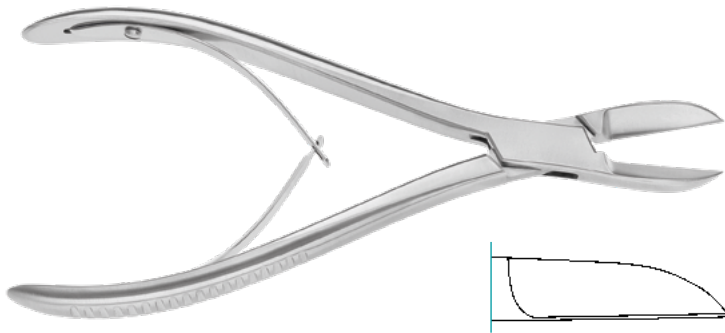

### **COTTLE KAZANJIAN**

Bone Cutting Forceps, straight

180mm, 7"

210-845-185

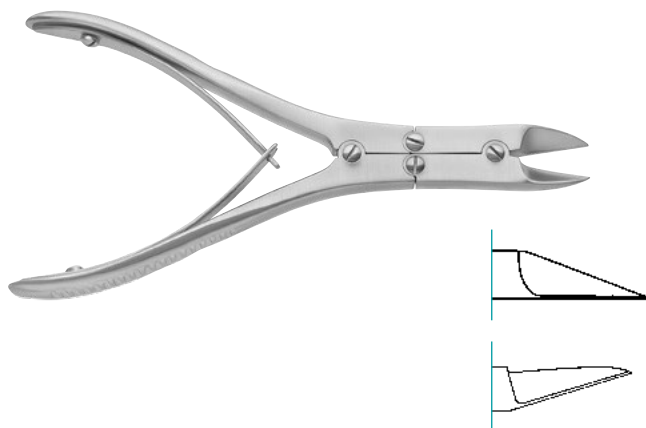

### **BOEHLER**

Bone Cutting Forceps, double action,  
straight

150mm, 6"

210-892-150

curved on flat

150mm, 6"

210-890-150

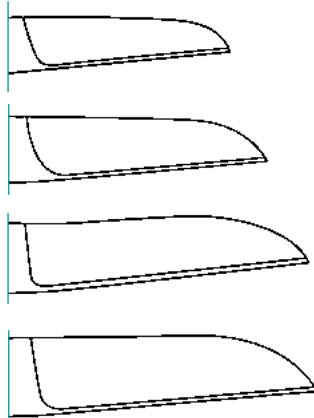

### LISTON

Bone Cutting Forceps, straight

140mm, 5 <sup>1</sup> / <sub>2</sub> "	210-934-140
170mm, 6 <sup>2</sup> / <sub>3</sub> "	210-934-170
190mm, 7 <sup>1</sup> / <sub>2</sub> "	210-934-190
220mm, 8 <sup>2</sup> / <sub>3</sub> "	210-934-220

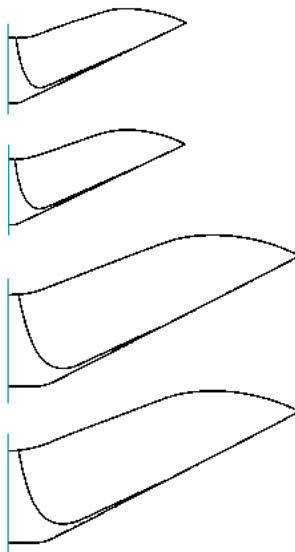

### LISTON

Bone Cutting Forceps, angled

140mm, 5 <sup>1</sup> / <sub>2</sub> "	210-935-140
170mm, 6 <sup>2</sup> / <sub>3</sub> "	210-935-170
190mm, 7 <sup>1</sup> / <sub>2</sub> "	210-935-190
220mm, 8 <sup>2</sup> / <sub>3</sub> "	210-935-220

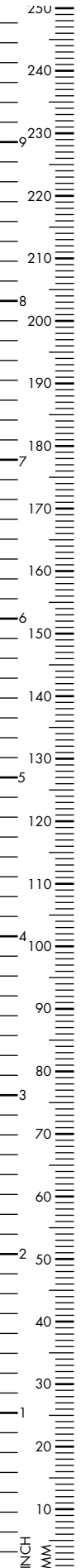

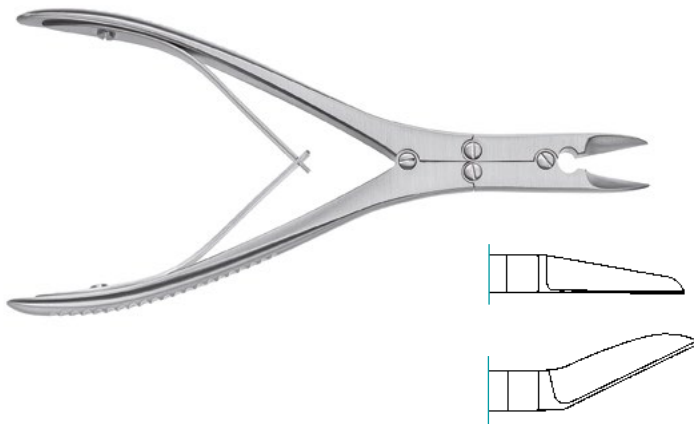

### RUSKIN LISTON

Bone Cutting Forceps, double action,  
170mm, 6<sup>2/3</sup>"

Straight	210-844-170
Angled	210-843-170

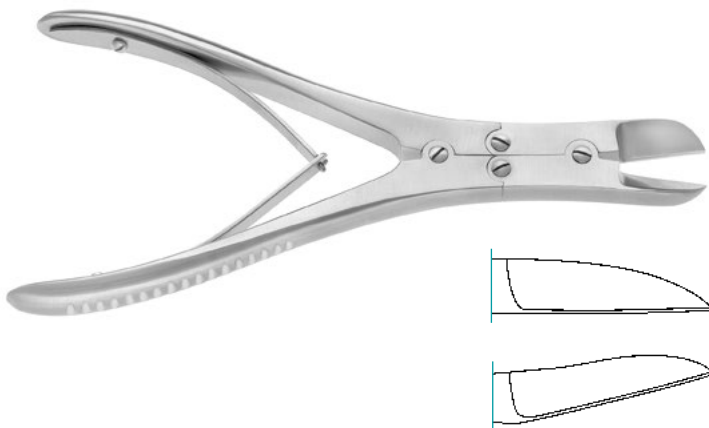

### RUSKIN LISTON

Bone Cutting Forceps, double action,  
185mm, 7<sup>1/4</sup>"

Straight	210-900-185
Angled	210-901-185



### MCINDOE

Bone Cutting Forceps, double action

175mm, 6<sup>7</sup>/<sub>8</sub>"

210-880-175

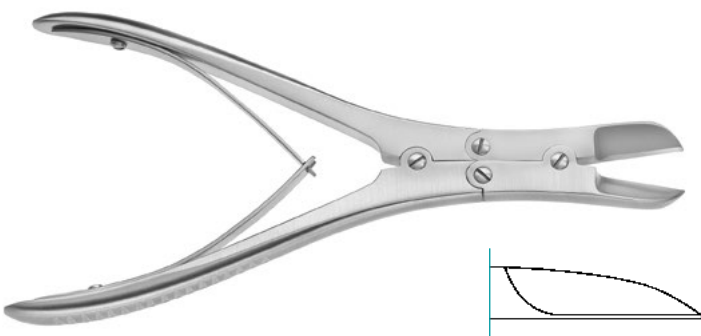

### RUSKIN ROWLAND

Bone Cutting Forceps, double action, straight

180mm, 7"

210-855-180

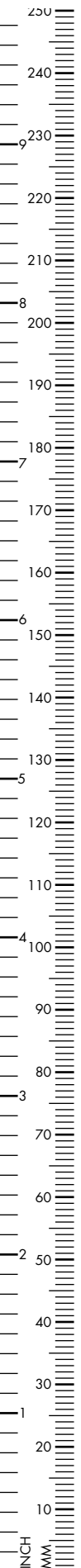

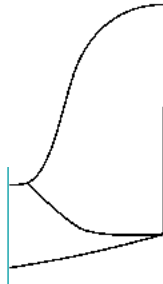
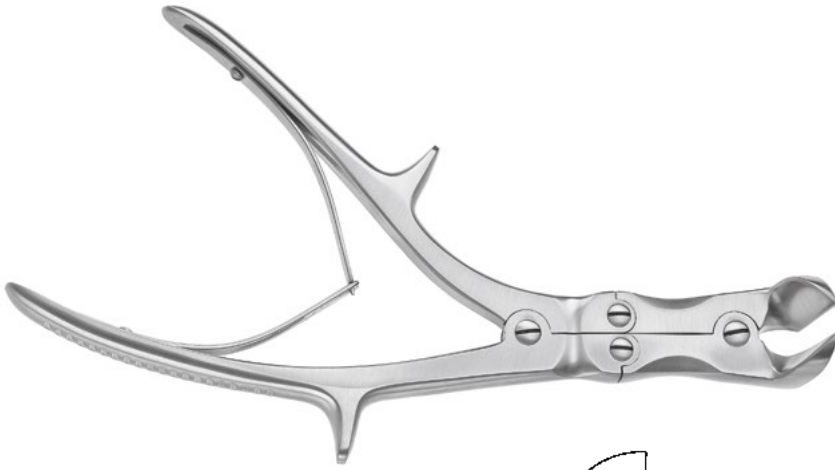

**SEMB**

Bone Cutting Forceps, double action,  
shanks lateral angled

245mm, 9<sup>2</sup>/<sub>3</sub>"

210-911-245

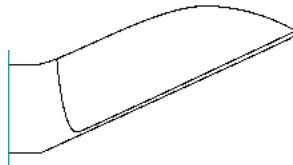
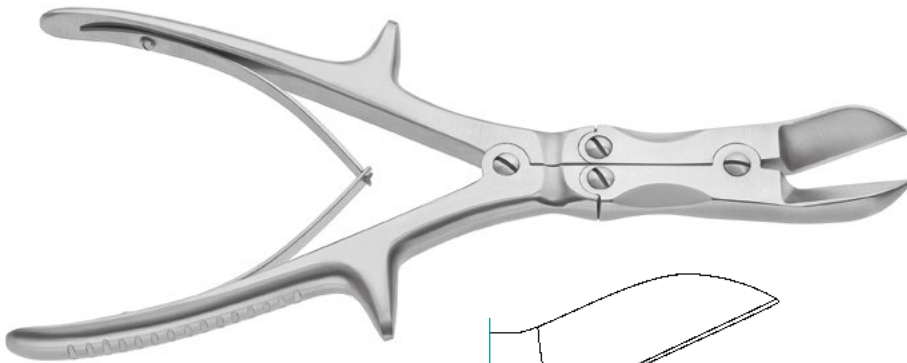

**LISTON**

Bone Cutting Forceps, double action,  
angled

240mm, 9<sup>1</sup>/<sub>2</sub>"

210-905-240

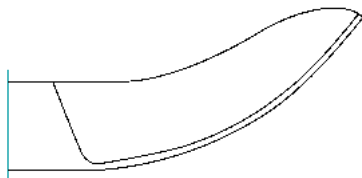
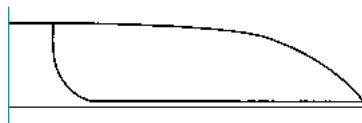
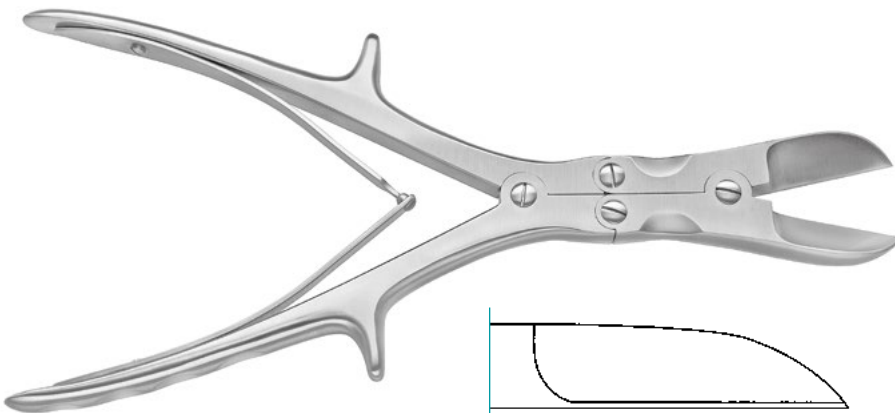

**STILLE LISTON**

Bone Cutting Forceps, double action  
270mm, 10<sup>2</sup>/<sub>3</sub>"

Straight

210-904-270

Angled

210-902-270

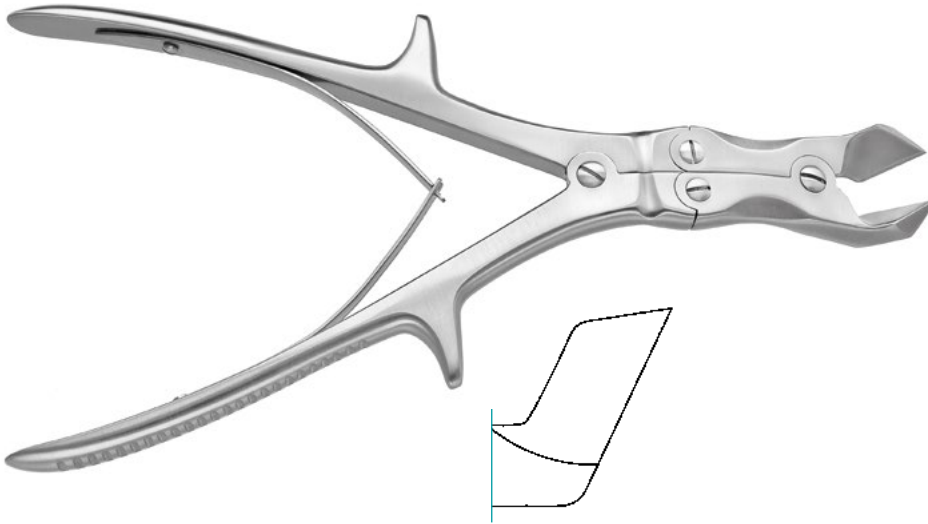

**LISTON KEY HORSLEY**  
Bone Cutting Forceps, double action,  
s-shaped

255mm, 10" 210-910-255

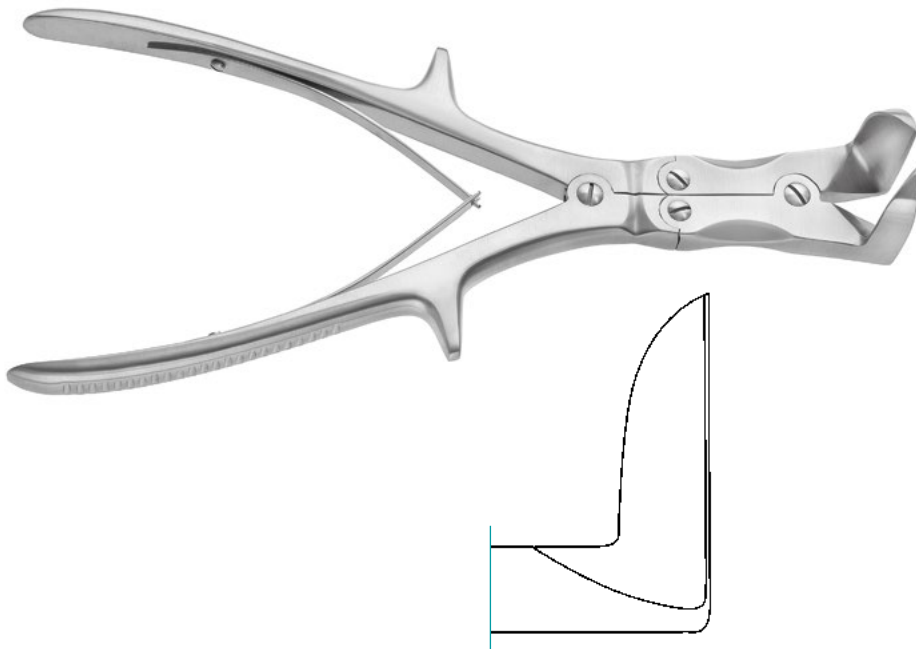

**STILLE LISTON**  
Bone Cutting Forceps, double action,  
90° angled

270mm, 10<sup>2/3</sup>" 210-908-270

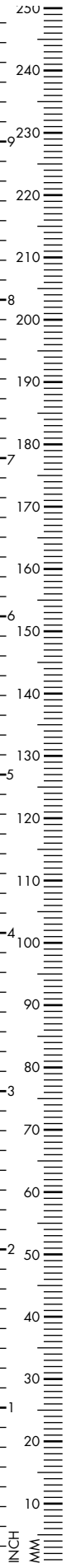





Tendon Grasping Forceps,  
100mm, 4"

2.0mm jaw	210-675-002
3.0mm jaw	210-675-003
4.0mm jaw	210-675-004
5.0mm jaw	210-675-005

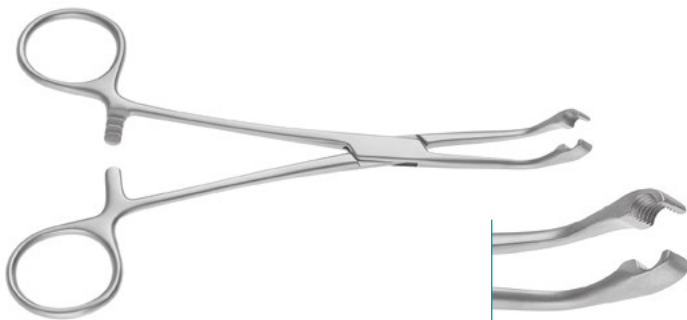

Tendon Grasping Forceps

155mm, 6 <sup>1</sup> / <sub>8</sub> "	140-584-155
--	-------------



Nerve and Tendon Holding Forceps

Ø 2.5mm	270-202-025
Ø 3.0mm	270-202-030
Ø 3.5mm	270-202-035
Ø 4.0mm	270-202-040
Ø 5.0mm	270-202-050
Ø 6.0mm	270-202-060
Ø 7.0mm	270-202-070

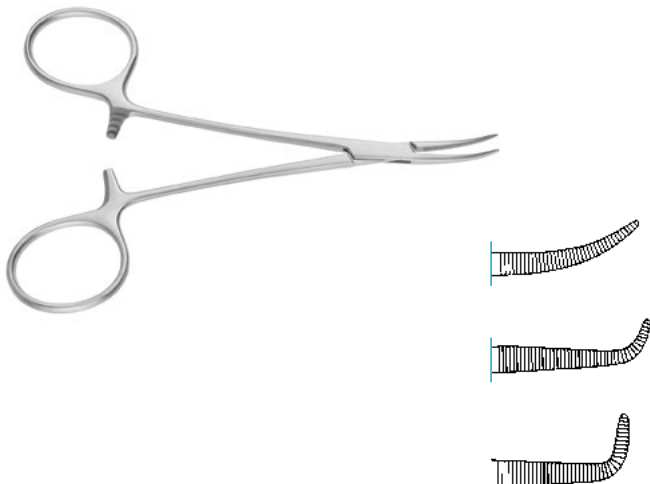

### HALSTED MOSQUITO

Tendon Grasping Forceps,  
125mm, 5"

light curve	140-354-001
medium curve	140-354-002
strong curve	140-354-003

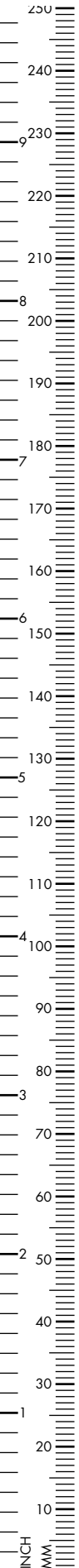

**ENGLERT**

Tendon Grasping Forceps,  
4x5 traumatic teeth

145mm, 5<sup>3</sup>/<sub>4</sub>"

140-355-145

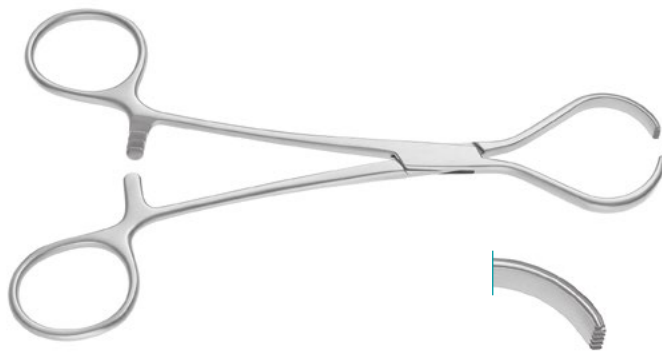

**OMBREDANNE (ISELIN)**

Tendon Holding Forceps,  
4x5 teeth

160mm, 6<sup>1</sup>/<sub>4</sub>"

140-583-160

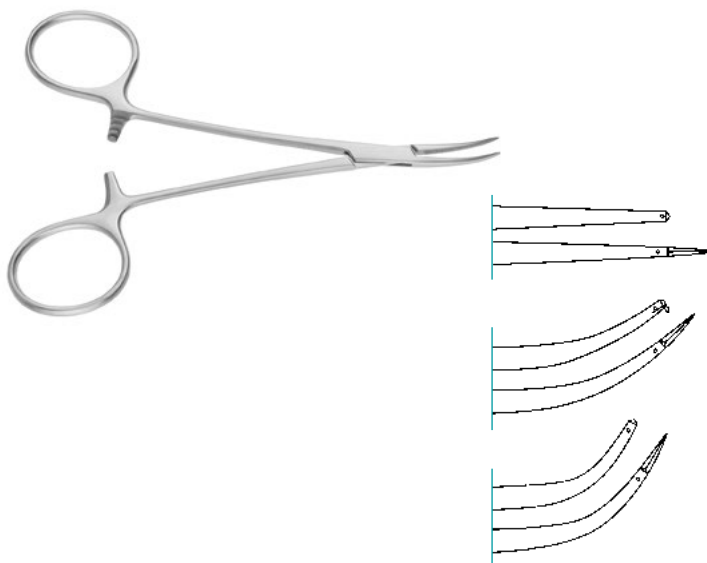

Tendon Interlacing Forceps,  
150mm, 6"

straight 210-682-150

curved 210-683-150

strongly curved 210-684-150

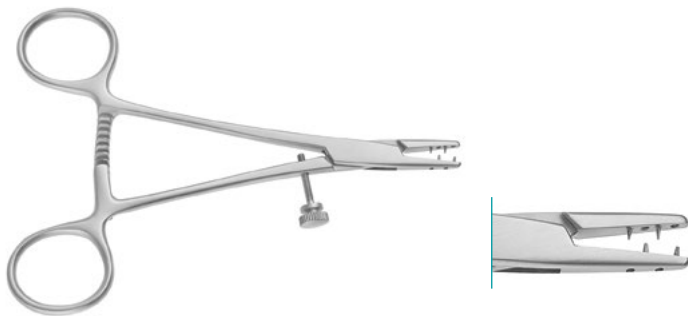

Tendon Seizing Forceps, 4 pins

120mm, 4<sup>3/4</sup>"

210-650-120

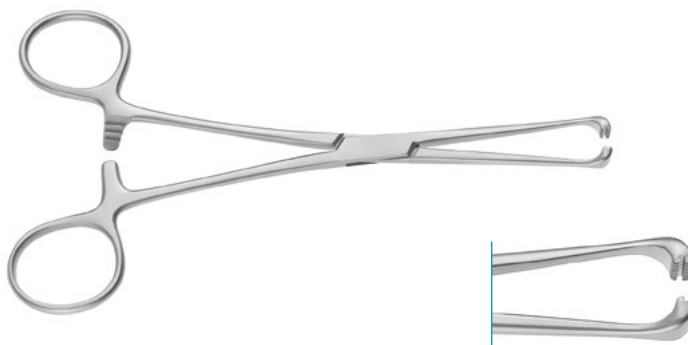

**STEINMANN**

Tendon Seizing Forceps

160mm, 6<sup>1/4</sup>"

210-674-160

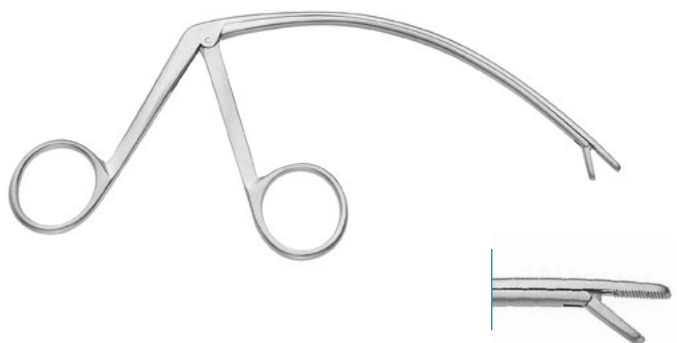

**CARROLL**

Tendon Forceps, curved

110mm, 4<sup>1/3</sup>"

210-679-110

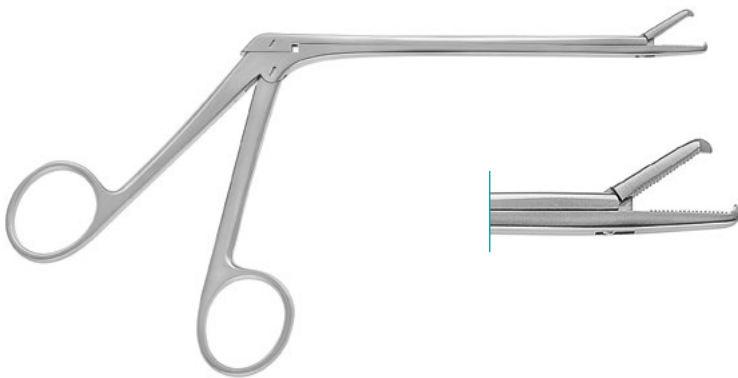

**HOEN**

Tendon Grasping Forceps, 1x2 teeth

120mm, 4 <sup>3</sup> / <sub>4</sub> "	210-660-120
--	-------------

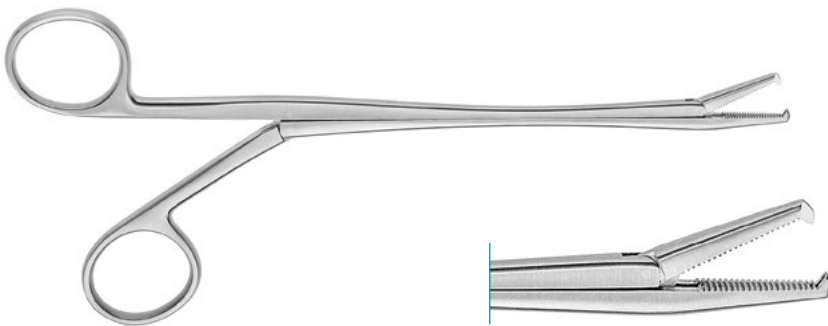

**BRAND**

Tendon Seizing Forceps, 1x2 teeth

150mm, 6"	210-665-150
-----------	-------------

190mm, 7 <sup>1</sup> / <sub>2</sub> "	210-665-190
--	-------------

245mm, 9 <sup>2</sup> / <sub>3</sub> "	210-665-240
--	-------------



**BRAND**

Tendon Seizing Forceps, curved, 1x2 teeth

150mm, 6"	210-663-150
-----------	-------------

190mm, 7 <sup>1</sup> / <sub>2</sub> "	210-663-190
--	-------------

250mm, 9 <sup>7</sup> / <sub>8</sub> "	210-663-250
--	-------------

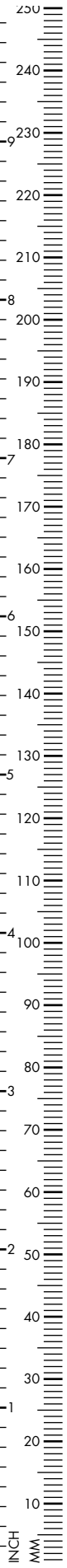

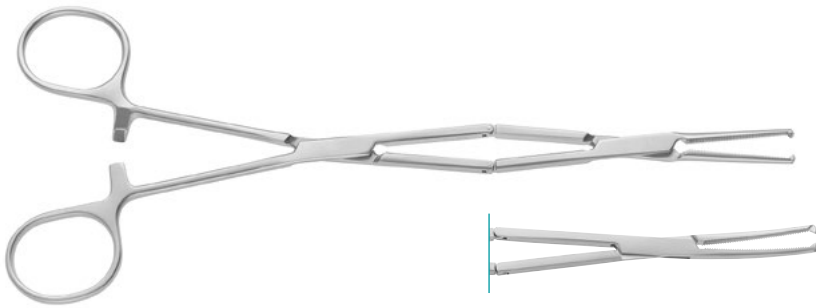

Tendon Seizing Forceps, 1x2 teeth,  
210mm, 8<sup>1/4</sup>"

straight	210-668-210
curved	210-669-210

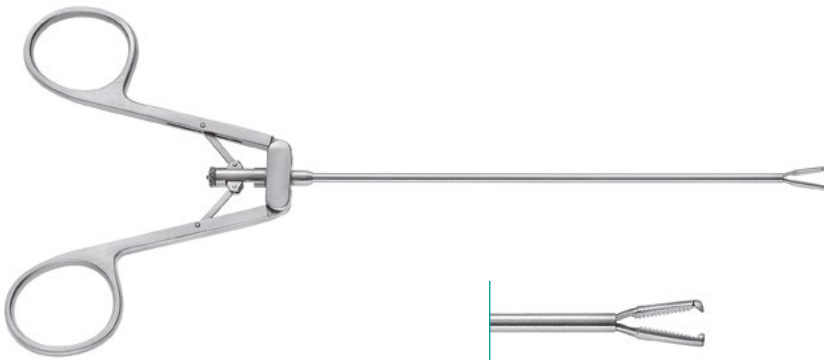

### **KLEINERT KUTZ**

Tendon Seizing Forceps, 1x2 teeth, flexible,  
1x8mm serrated jaw

210mm, 8 <sup>1/4</sup> "	210-681-200
---------------------------	-------------



Tenolysis Knife, for tenolysis superficial  
and deep to the tendon



A	210-681-001
---	-------------

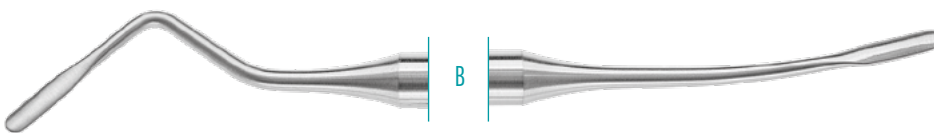

B	210-681-002
---	-------------

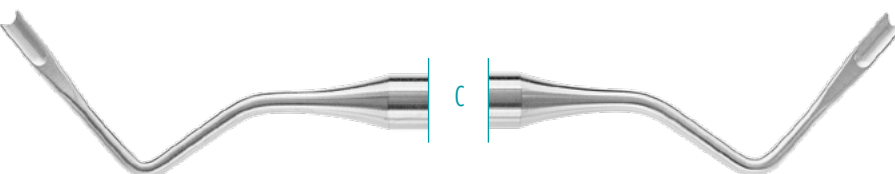

C	210-681-003
---	-------------

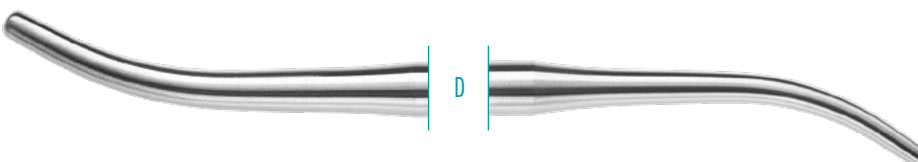

D	210-681-004
---	-------------



### FISCHER

Tendon Stripper, blunt,  
synthetic handle

310mm, 12<sup>1/4</sup>" 210-855-310



Tendon Stripper, synthetic handle,  
inner-Ø 3mm

285mm, 11<sup>1/4</sup>" 210-663-280

350mm, 14" 210-663-350

600mm, 24" 210-663-600

with slot

285mm, 11<sup>1/4</sup>" 210-663-281

350mm, 14" 210-663-351

#### Inner-Ø 4mm

285mm, 11<sup>1/4</sup>" 210-664-280

350mm, 14" 210-664-350

600mm, 24" 210-664-600

with slot

285mm, 11<sup>1/4</sup>" 210-664-281

350mm, 14" 210-664-351

#### Inner-Ø 5mm

285mm, 11<sup>1/4</sup>" 210-665-280

350mm, 14" 210-665-350

600mm, 24" 210-665-600

with slot

285mm, 11<sup>1/4</sup>" 210-665-281

350mm, 14" 210-665-351

#### Inner-Ø 6mm

285mm, 11<sup>1/4</sup>" 210-666-280

350mm, 14" 210-666-350

600mm, 24" 210-666-600

with slot

285mm, 11<sup>1/4</sup>" 210-666-281

350mm, 14" 210-666-351



### BUNNELL

Tendon Stripper, 150mm, 6"

Ø 2.5mm 210-652-001

Ø 3.0mm 210-652-002

Ø 4.0mm 210-652-003

Ø 5.0mm 210-652-004

Ø 6.5mm 210-652-005

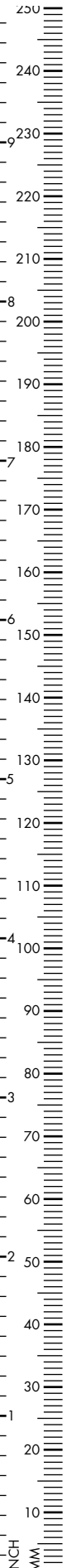



### PAUL

Tendon Retractor, blunt, 3 prongs

125mm, 5"

170-177-125



### KLAPP

Tendon Retractor, blunt, 175mm, 6<sup>7</sup>/<sub>8</sub>"

2 prongs

170-181-002

3 prongs

170-181-003

4 prongs

170-181-004

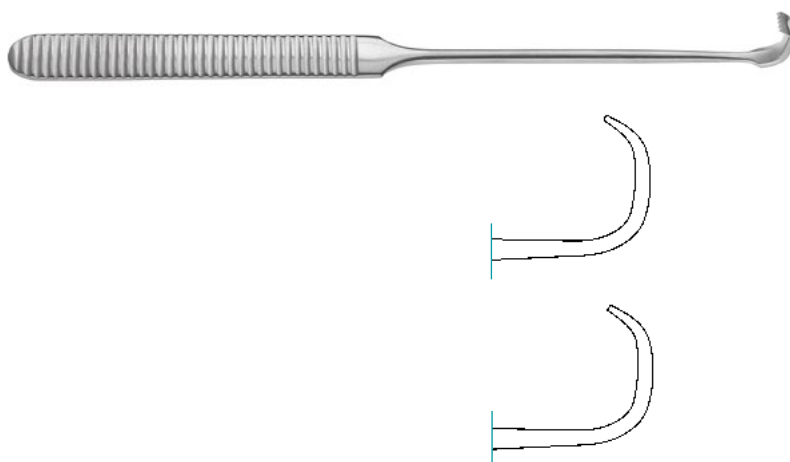

### STRANDELL STILLE

Tendon Retractor, 15x6mm, 190mm, 7<sup>1</sup>/<sub>2</sub>"

blunt

170-237-001

toothed

170-237-002

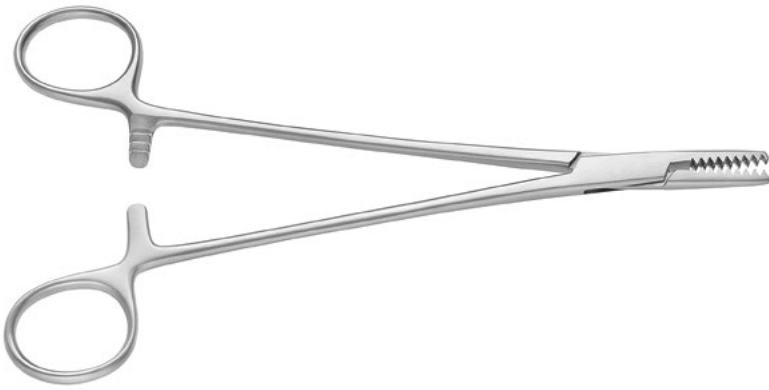
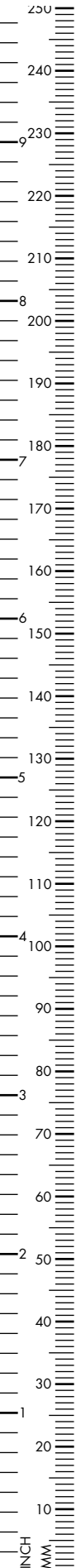

### MARTIN

Cartilage Holding Forceps, straight

190mm, 7<sup>1/2</sup>"

210-652-190

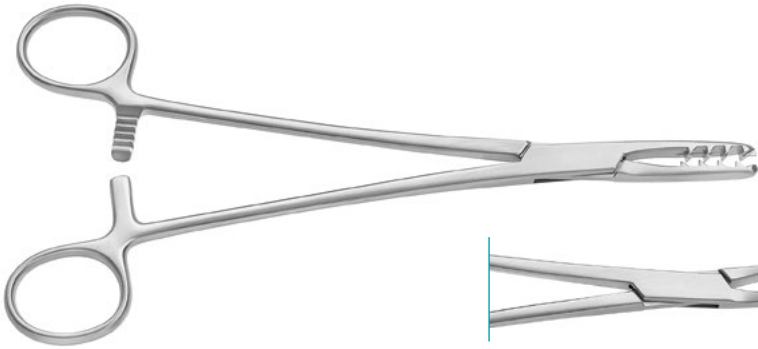

### BIRCHER GANSKE

Cartilage Holding Forceps, 200mm, 8"

straight

210-620-200

angled

210-621-200

laterally curved

210-623-200



### WALTON

Cartilage Forceps, slightly curved, with pins

185mm, 7<sup>1/4</sup>"

210-626-185

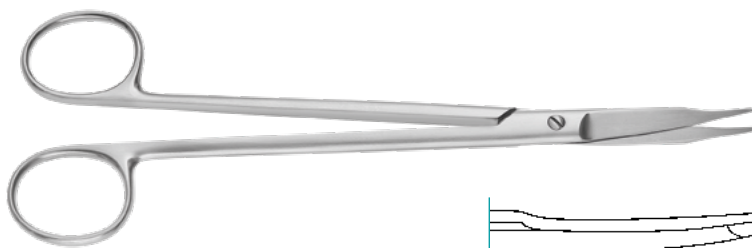

### MARTIN

Cartilage Scissors

200mm, 8"

120-206-200





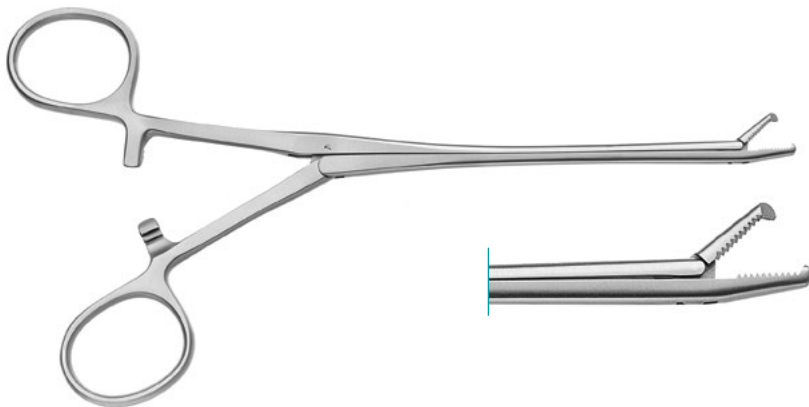

Meniscus Grasping Forceps with ratchet  
1x2 teeth, straight

200mm, 8" 225-360-000

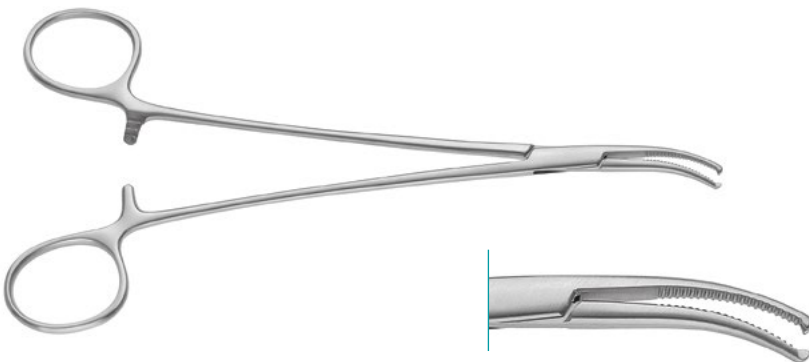

**PRESTON**

Meniscus Ligament Flavum Forceps,  
1x2 teeth, serrated jaw

190mm, 7<sup>1</sup>/<sub>2</sub>" 210-660-190

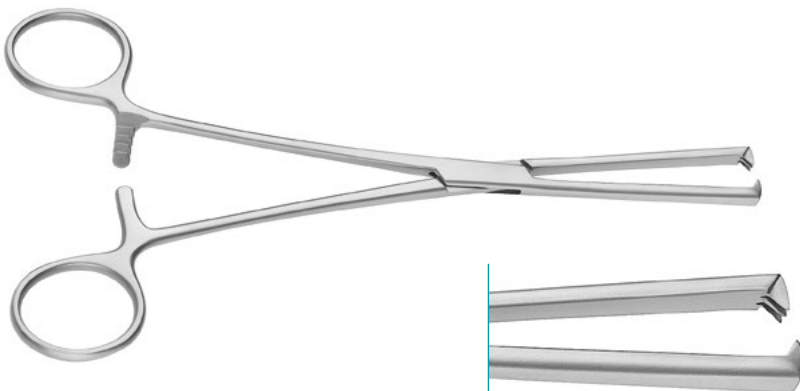

**BIRCHER**

Meniscus Grasping Forceps, 200mm, 8"

straight 210-624-200

curved 210-625-200

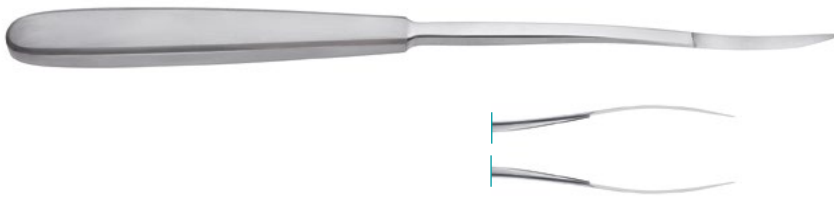
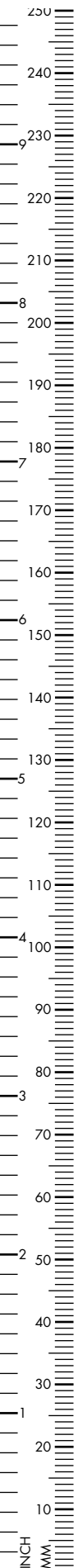

Meniscotome, 220mm, 8<sup>2</sup>/<sub>3</sub>"

Left side 210-650-220

Right side 210-651-220

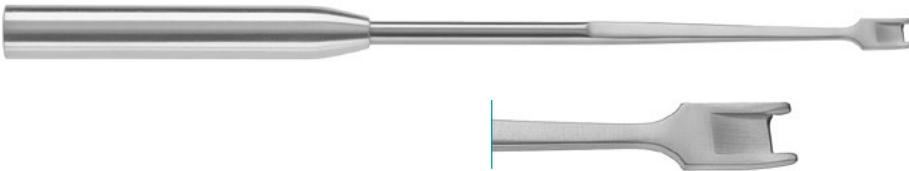

**LOWE BRECK**

Meniscotome

250mm, 9<sup>7</sup>/<sub>8</sub>" 210-637-250

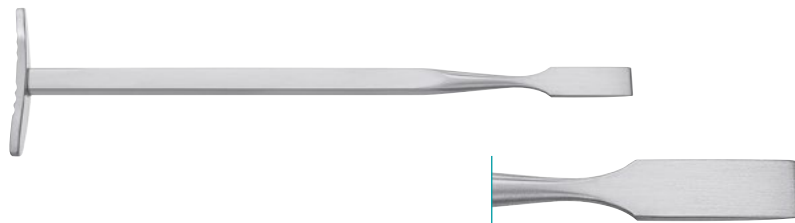

**SMILIE**

Meniscotome, straight

170mm, 6<sup>2</sup>/<sub>3</sub>" 210-630-170

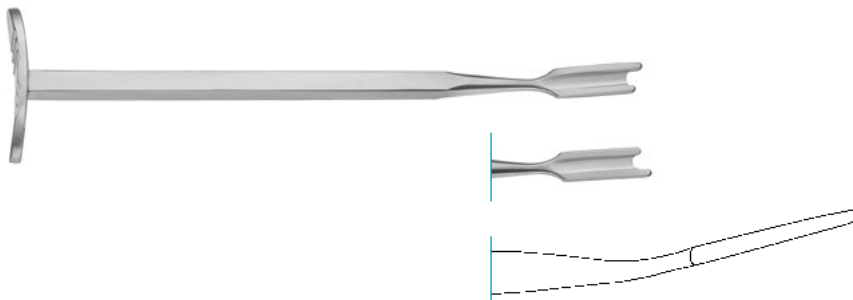

**SMILLIE**

Meniscotome with guards, 170mm, 6<sup>2</sup>/<sub>3</sub>"

Left 210-631-170

Right 210-633-170



Meniscotome, double edge, 180mm, 7"

Slightly curved 210-641-180



Meniscotome, 220mm, 8<sup>2</sup>/<sub>3</sub>"

Curved right 210-645-220

Curved left 210-643-220



Meniscotome, curved

190mm, 7<sup>1</sup>/<sub>2</sub>" 210-613-190

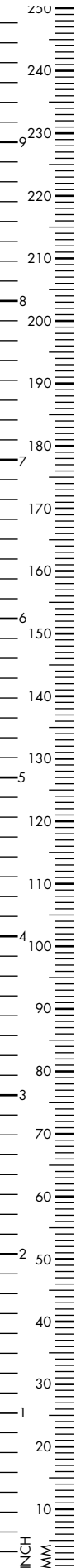

### DOANE

Knee Retractor

57 x 70mm blade	210-700-150
64 x 76mm blade	210-700-190



### SMILLIE

Knee wound retractor, 140mm, 5 1/2"

A 32 x 19mm	210-628-001
B 45 x 19mm	210-628-002
C 60 x 19mm	210-628-003
D 52 x 13mm	210-628-004
E 21 x 13mm	210-628-005
F 13 x 15mm	210-628-006

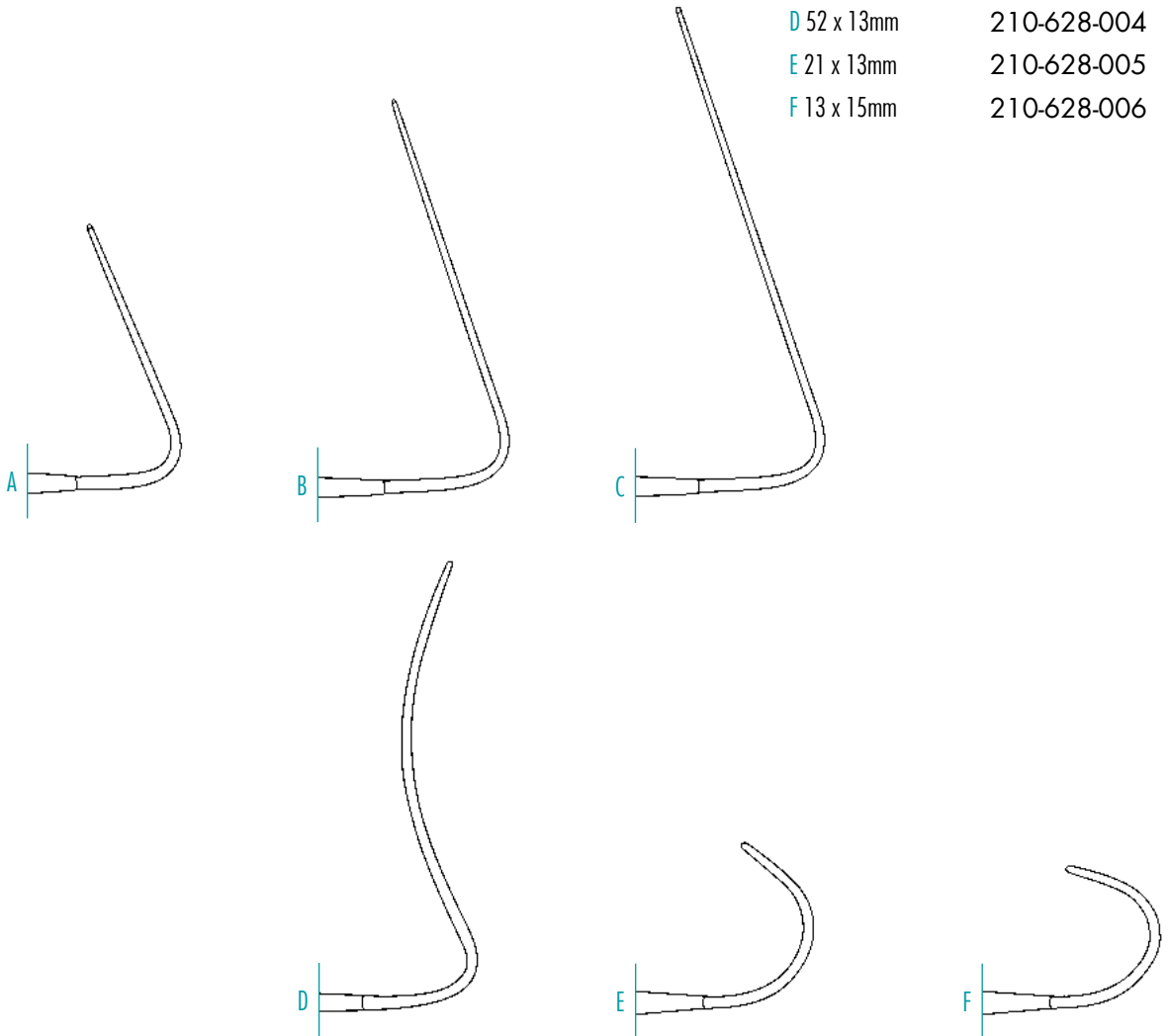

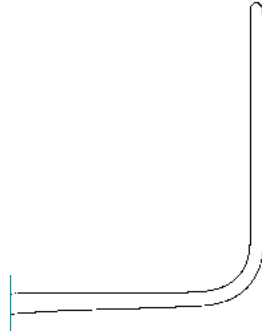

Knee Retractor, 38 x 9mm

210mm, 8<sup>1</sup>/<sub>4</sub>"

210-568-210

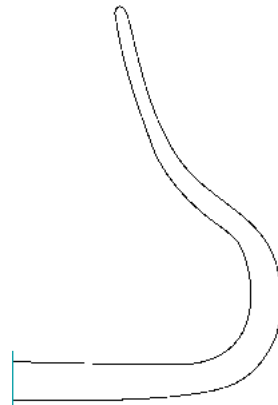

**BLOUNT**

Knee Retractor

175mm, 6<sup>7</sup>/<sub>8</sub>"

210-567-170



Knee and Meniscus Retractor

175mm, 6<sup>7</sup>/<sub>8</sub>"

210-569-170

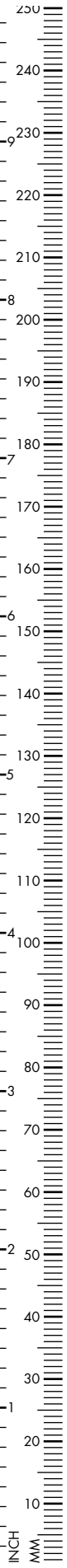

Bone Hook, sharp, hollow handle,  
230mm, 9"

9.5mm	210-230-101
19mm	210-230-102
25mm	210-230-103



Bone Hook, 1 tooth, sharp

245mm, 9 <sup>2</sup> / <sub>3</sub> "	170-292-245
--	-------------

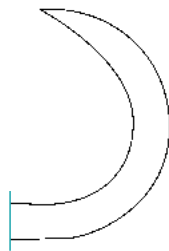

Bone Hook, 1 tooth, 200mm, 8"

Blunt	170-280-200
Sharp	170-282-200

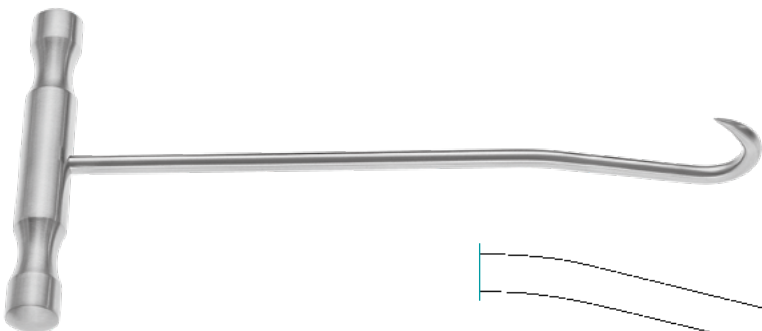

Bone Hook with T-Handle, sharp, 21mm

200mm, 8"	200-410-200
-----------	-------------

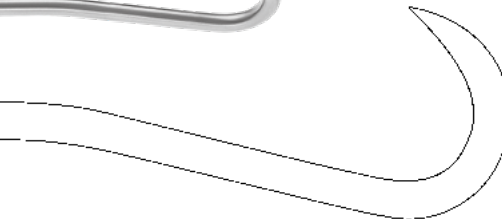

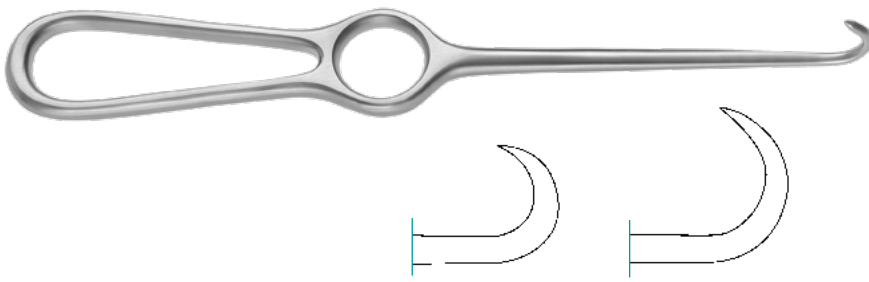

Bone Hook, 1 tooth, sharp, 230mm, 9"

Medium	200-410-001
Small	200-410-002

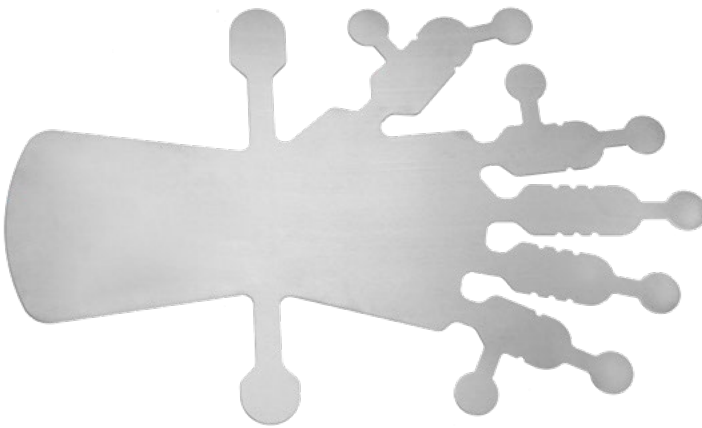

Lead Hand

Children	260-988-002
Adolescents	260-988-003
Adults	260-988-001

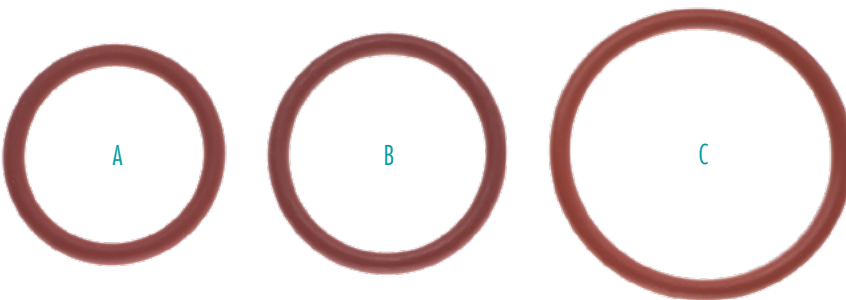

Fixation Rings (Scale 1:1)

A Children	260-988-004
B Adolescent	260-988-005
C Adults	260-988-006



Silicone Hand, malleable, black  
with fixation rings

260-988-000



### CHARNLEY

Charnley Initial Incision Retractor  
frame and blade small 25 x 38mm  
big blade 25 x 44mm  
with weight and chain

Complete set	170-300-001
Frame	170-300-123
Weight and Chain	170-300-122



Blades, small (width x depth)

25 x 25mm	170-300-025
25 x 38mm	170-300-038
25 x 50mm	170-300-050
25 x 57mm	170-300-057
25 x 63mm	170-300-010
25 x 75mm	170-300-013
25 x 101mm	170-300-017
25 x 114mm	170-300-114
25 x 127mm	170-300-016



Blades, large (width x depth)

25 x 25mm	170-301-025
25 x 44mm	170-301-044
25 x 50mm	170-301-050
25 x 57mm	170-301-057
25 x 63mm	170-301-012
25 x 75mm	170-301-014
25 x 101mm	170-301-101
25 x 114mm	170-301-114
25 x 127mm	170-301-015

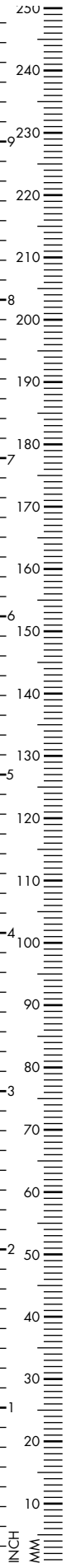



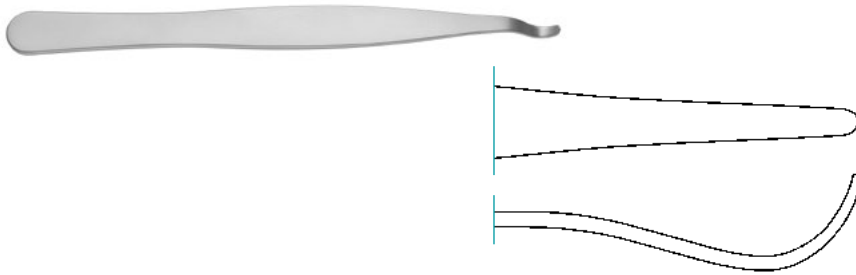

### HAYES

Phalangeal Elevator, 3mm wide blade

150mm, 6"

210-473-150

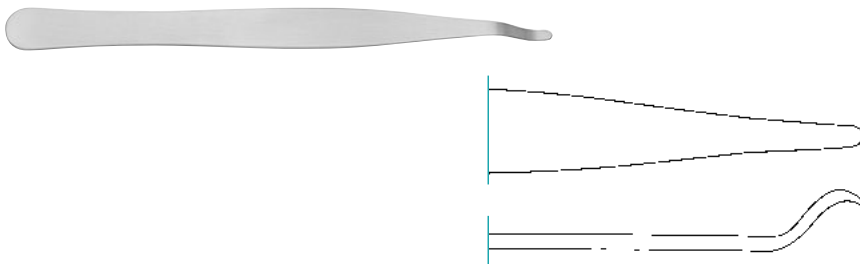

Bone Lever, 2.8mm

140mm, 5<sup>1/2</sup>"

210-539-110

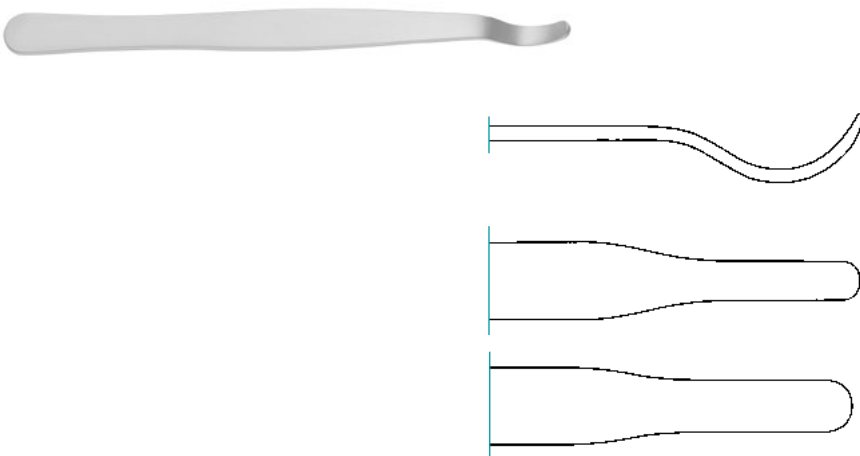

Phalangeal Elevator, 150mm, 6"

5mm

210-475-150

7mm

210-477-150

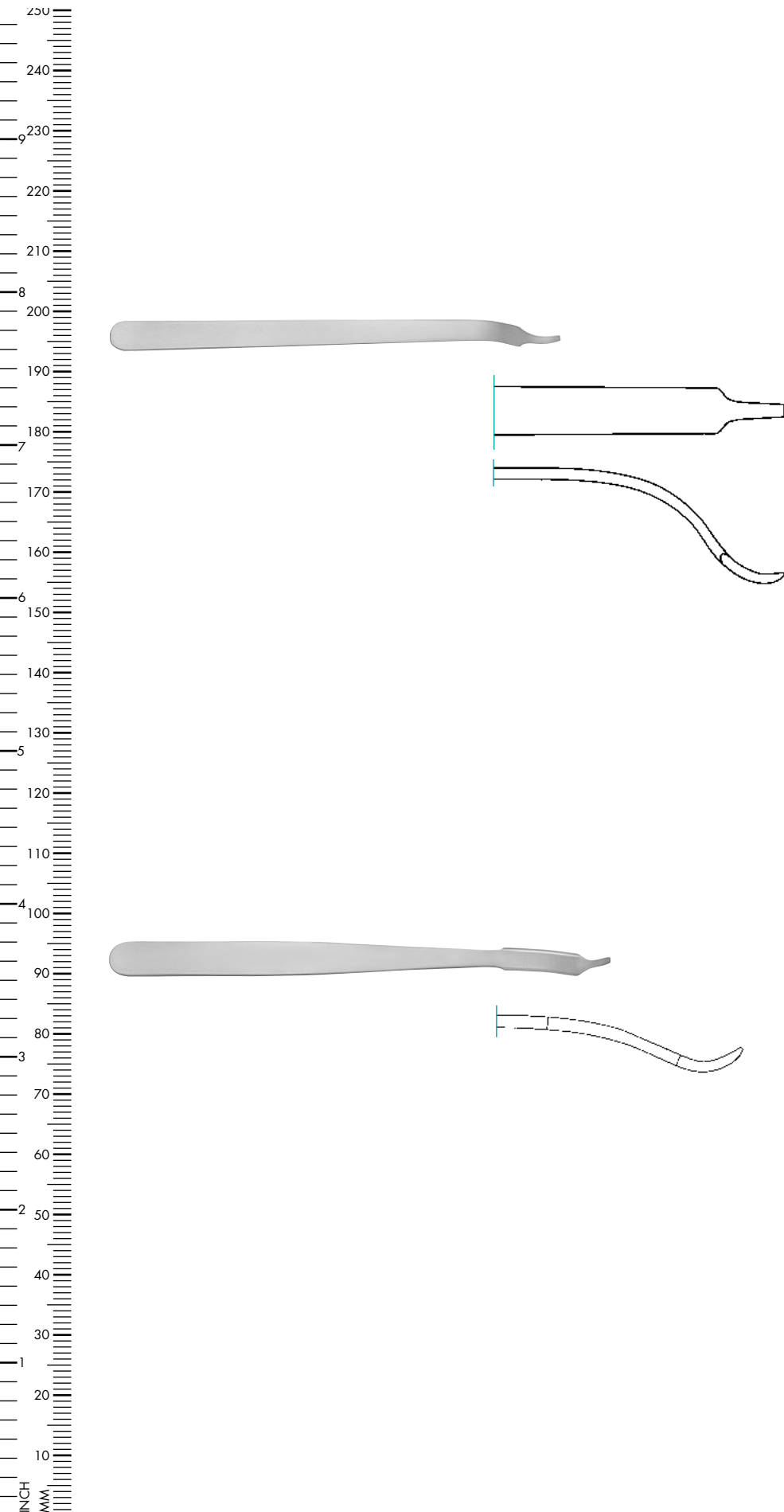

### BUCK GRAMCKO

Bone Lever, 7.5mm wide, 2mm tip

150mm, 6"

210-541-075

### MINI HOHMANN

Bone Lever, 6mm wide, 2mm tip

160mm, 6<sup>1/4</sup>"

210-539-060

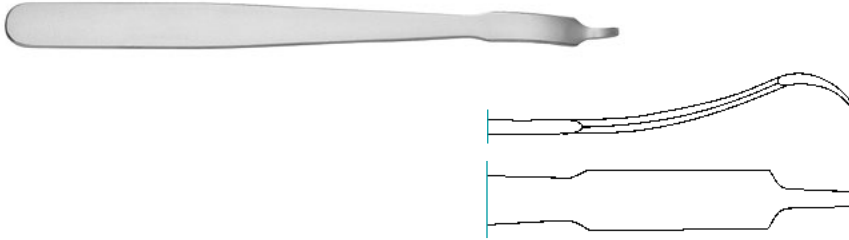

**HOHMANN**

Bone Lever, 2mm tip, 8mm wide

160mm, 6<sup>1/4</sup>" 210-541-080

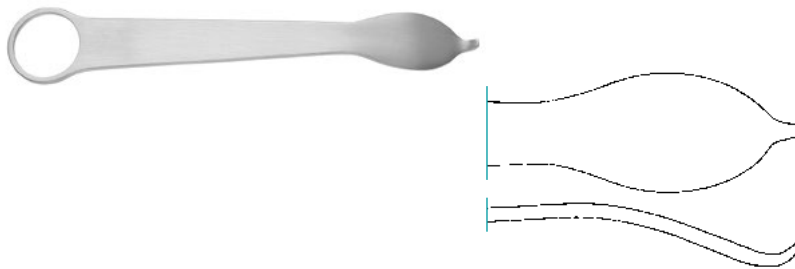

**HOHMANN**

Bone Lever, 15mm wide tip, with finger ring

120mm, 4<sup>3/4</sup>" 210-541-150

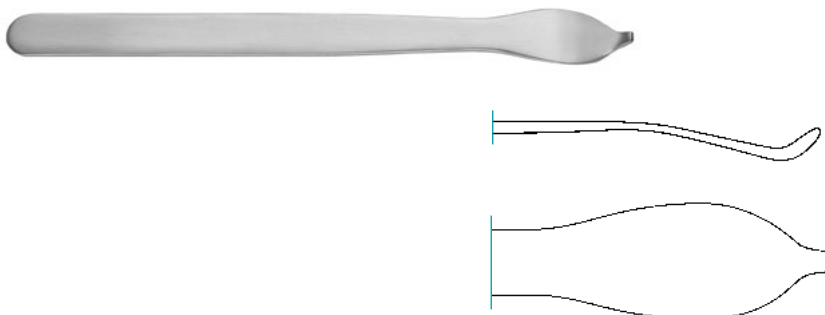

Mini Bone Lever, 15mm wide tip

160mm, 6<sup>1/4</sup>" 210-539-150



### LANGE BABY

Bone Lever, 17mm wide

170mm, 6<sup>2</sup>/<sub>3</sub>"

210-534-170

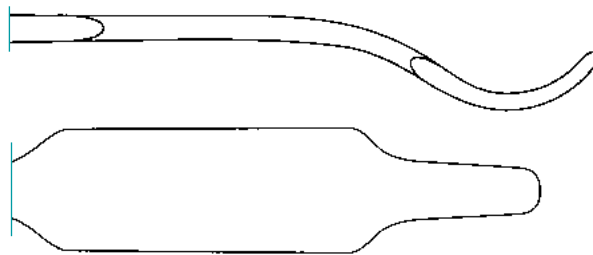

### HOHMANN

Bone Lever, 240mm, 9<sup>1</sup>/<sub>2</sub>"

8mm 210-541-108

10mm 210-541-100

18mm 210-541-180

24mm 210-541-240

43mm 210-541-430

70mm 210-541-700

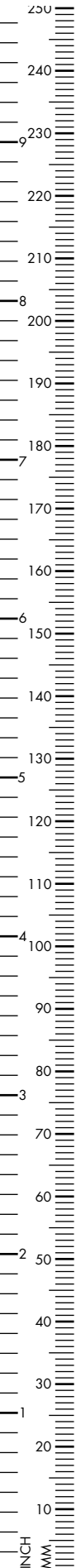
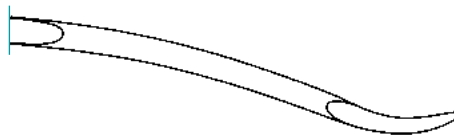



**HOHMANN**

Bone Lever, 17mm, sharp

240mm, 9<sup>1</sup>/<sub>2</sub>"

210-542-180

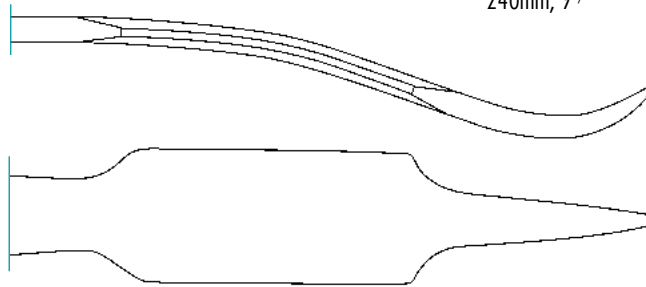

**HOHMANN**

Bone Lever, 25mm wide, 13mm tip

270mm, 10<sup>2</sup>/<sub>3</sub>"

210-541-250

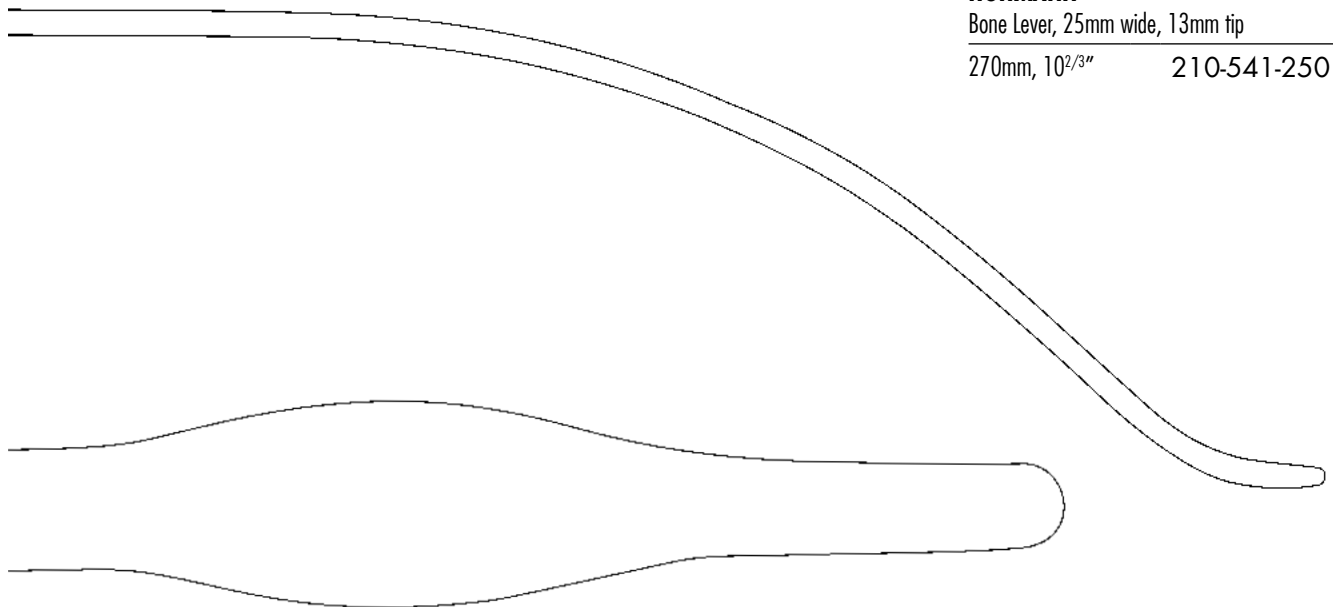



**WAGNER**

Bone Lever, 17mm

220mm, 8<sup>2/3</sup>"

210-540-220

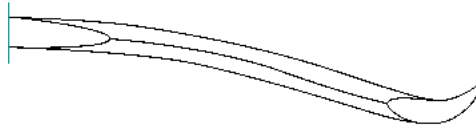

**HOHMANN**

Bone Lever, 24mm

260mm, 10<sup>1/4</sup>"

210-545-220

35mm

285mm, 11<sup>1/4</sup>"

210-545-350

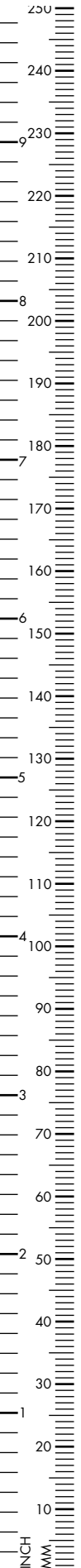
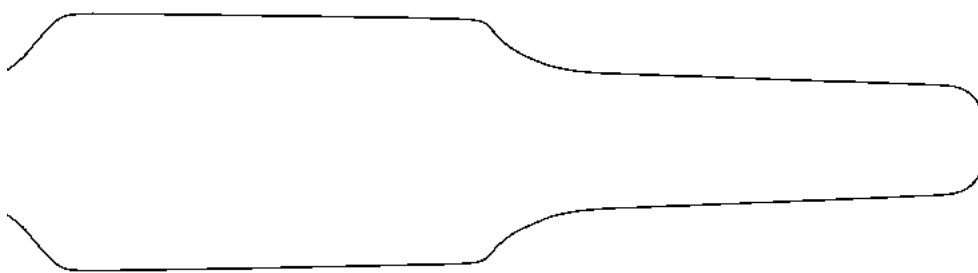
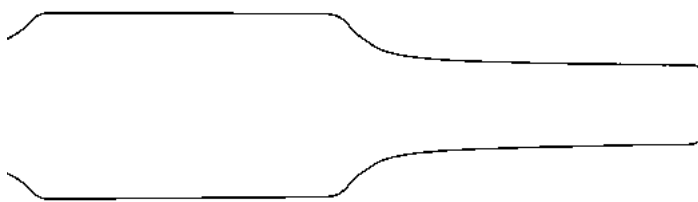
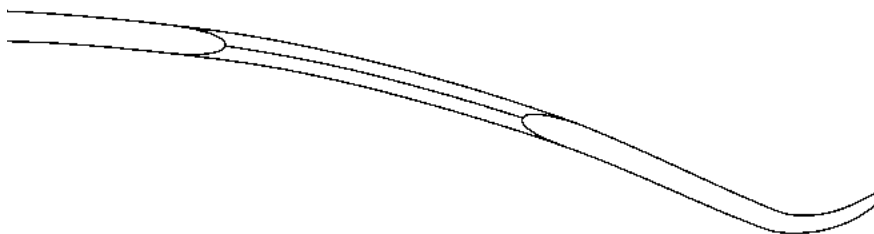

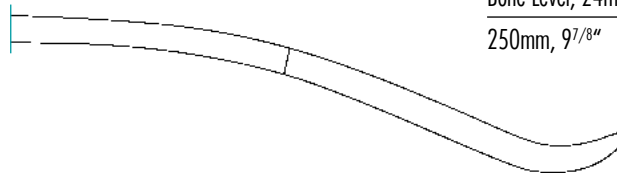

**LANGE HOHMANN**

Bone Lever, 24mm wide

250mm, 9<sup>7</sup>/<sub>8</sub>"

210-557-250

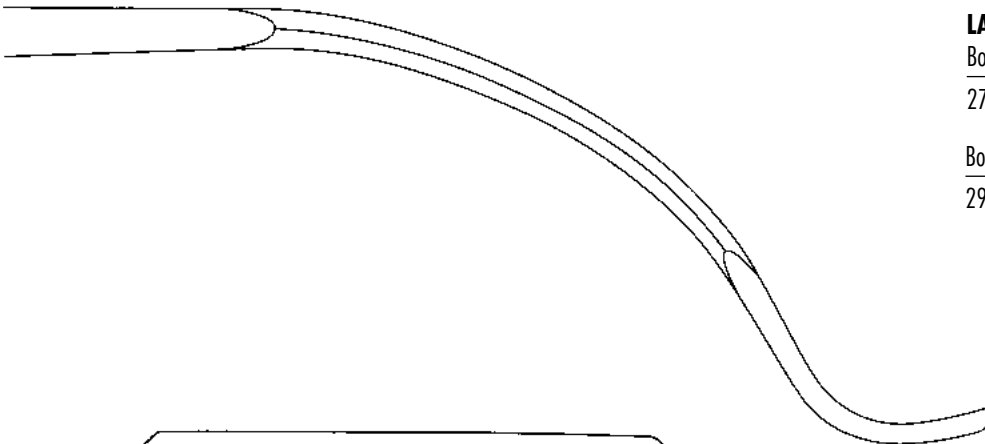

**LANGE HOHMANN**

Bone Lever, 30mm

270mm, 10<sup>2</sup>/<sub>3</sub>"

210-557-270

Bone Lever, 33mm

290mm, 11<sup>1</sup>/<sub>2</sub>"

210-557-290

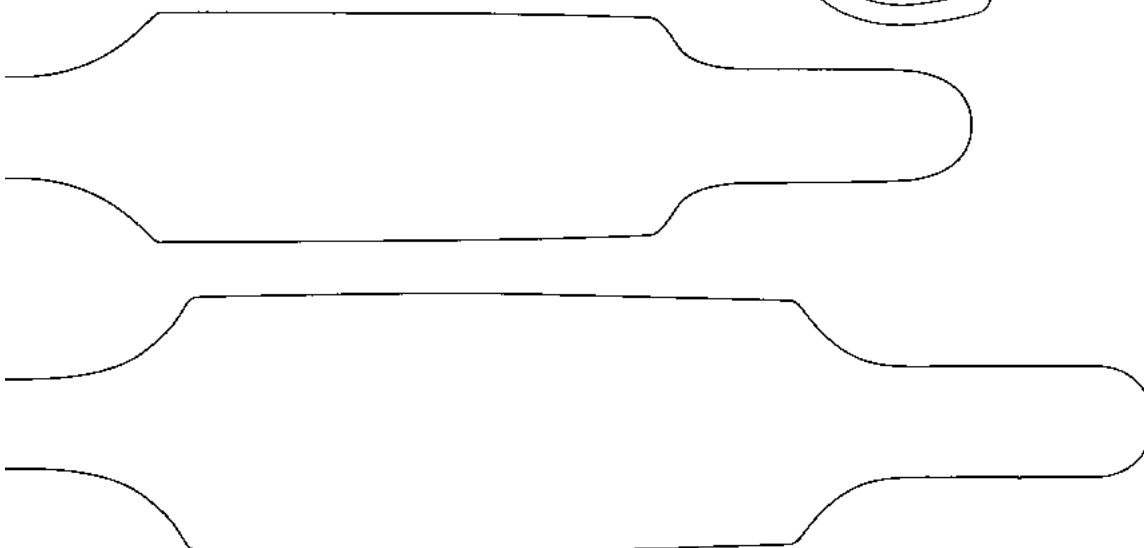

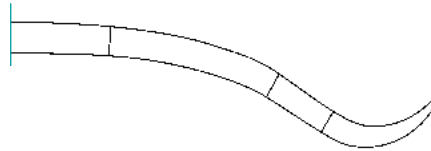
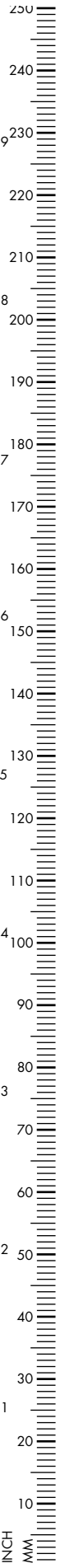

### VERBRUGGE

Bone Lever, 25mm

200mm, 8" 210-542-025

45mm

230mm, 9" 210-542-045

70mm

250mm, 9<sup>7</sup>/<sub>8</sub>" 210-542-070

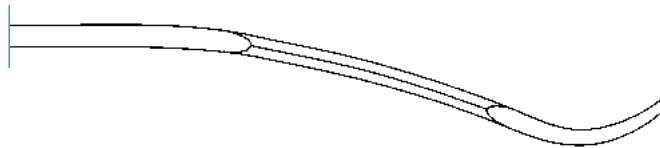

### VERBRUGGE HOHMANN

Bone Lever, 44mm

240mm, 9<sup>1</sup>/<sub>2</sub>" 210-541-043

65mm

250mm, 9<sup>7</sup>/<sub>8</sub>" 210-541-065

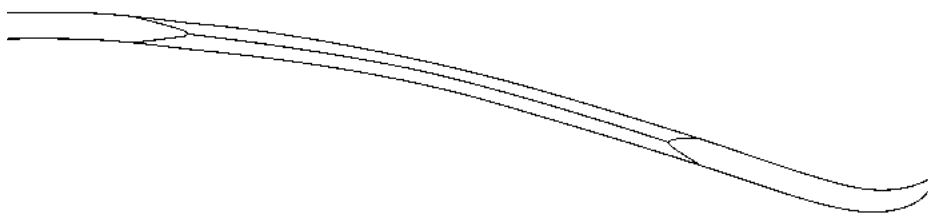

### HOHMANN

Bone Lever, 43mm

235mm, 9<sup>1</sup>/<sub>4</sub>" 210-543-430



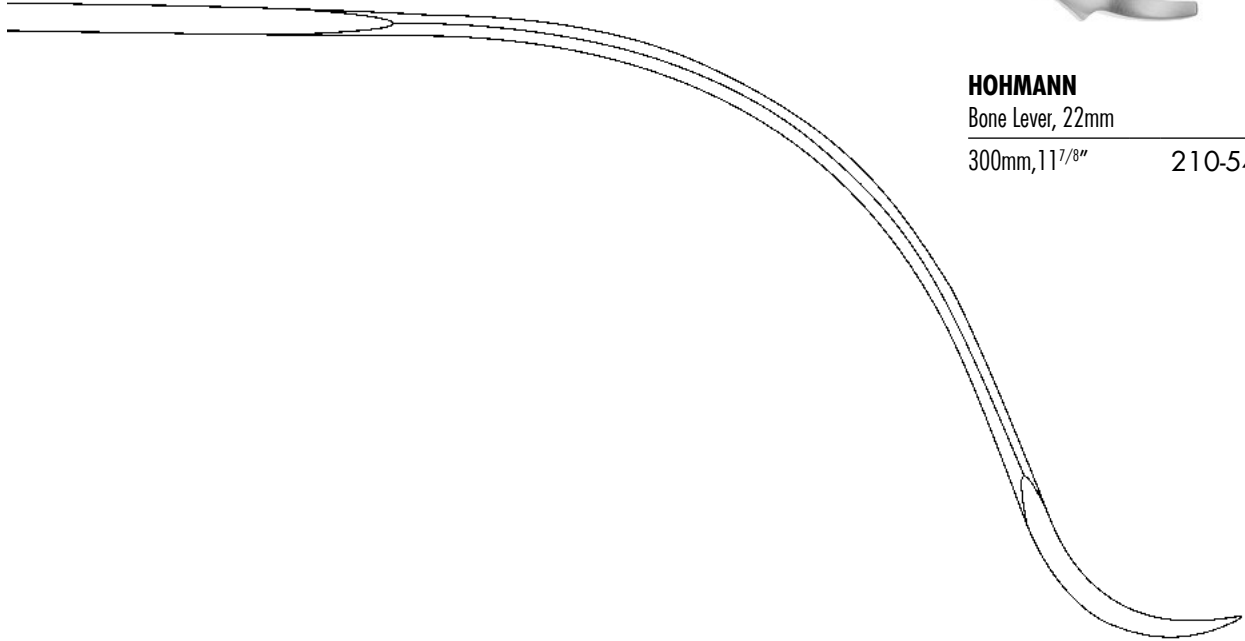
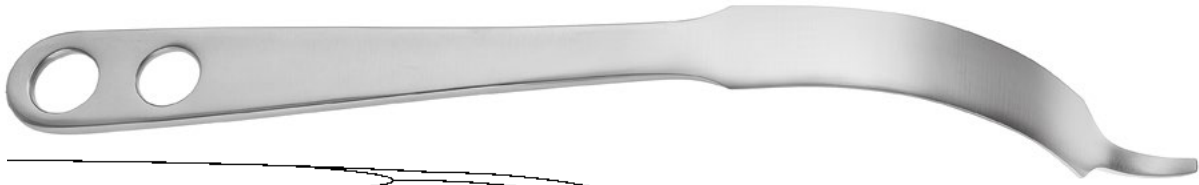

**HOHMANN**

Bone Lever, 22mm

300mm, 11<sup>7</sup>/<sub>8</sub>"

210-545-221

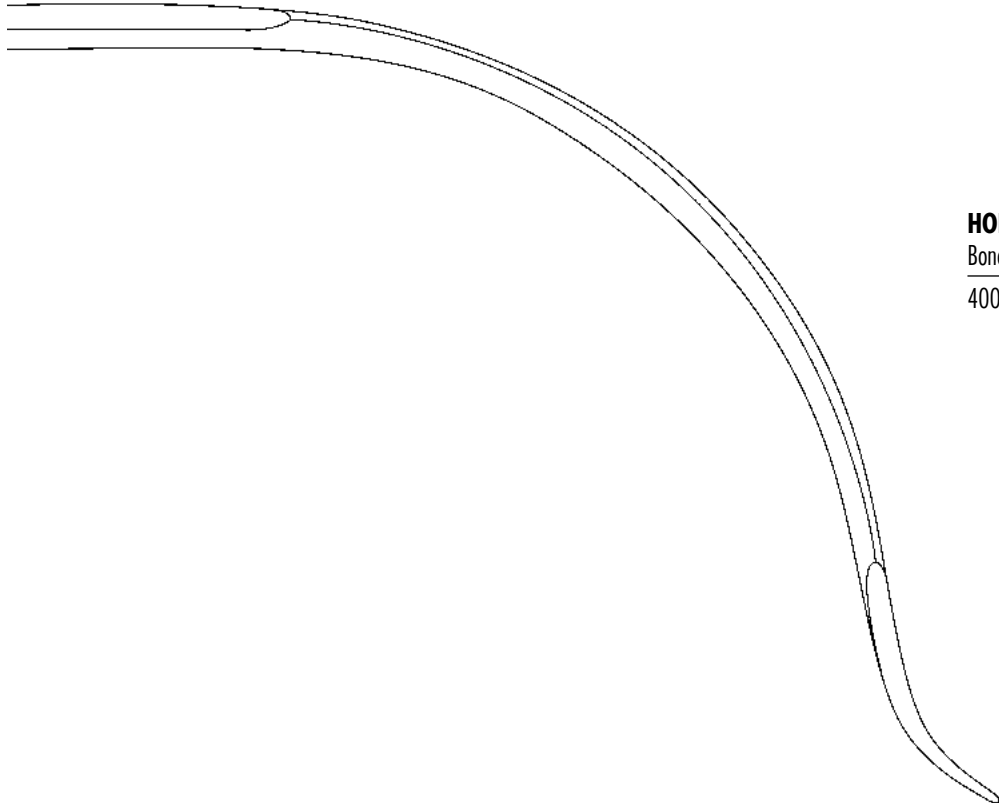
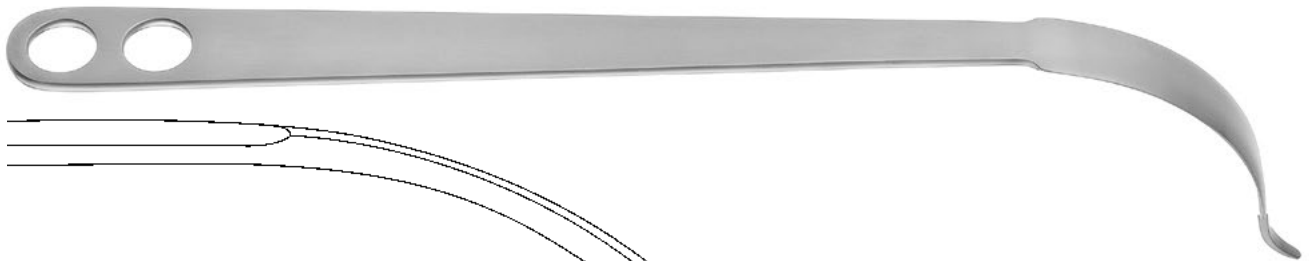

**HOHMANN**

Bone Lever, 120° curved, 22mm

400mm, 16"

210-541-400

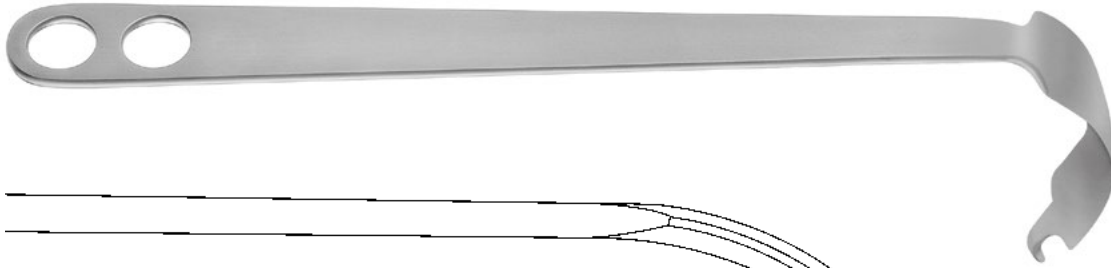

**HOHMANN**

Bone Lever, 90° curved, 43mm

330mm, 13"

210-541-330

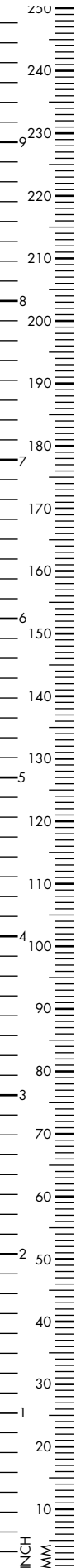

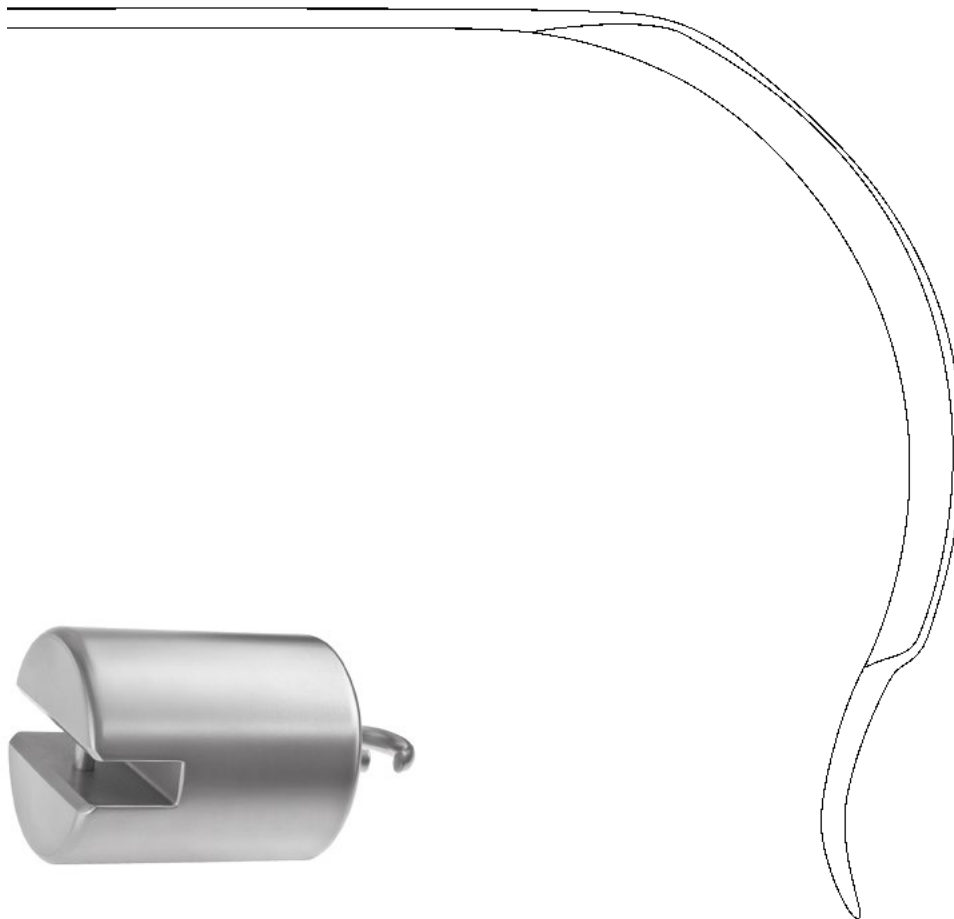
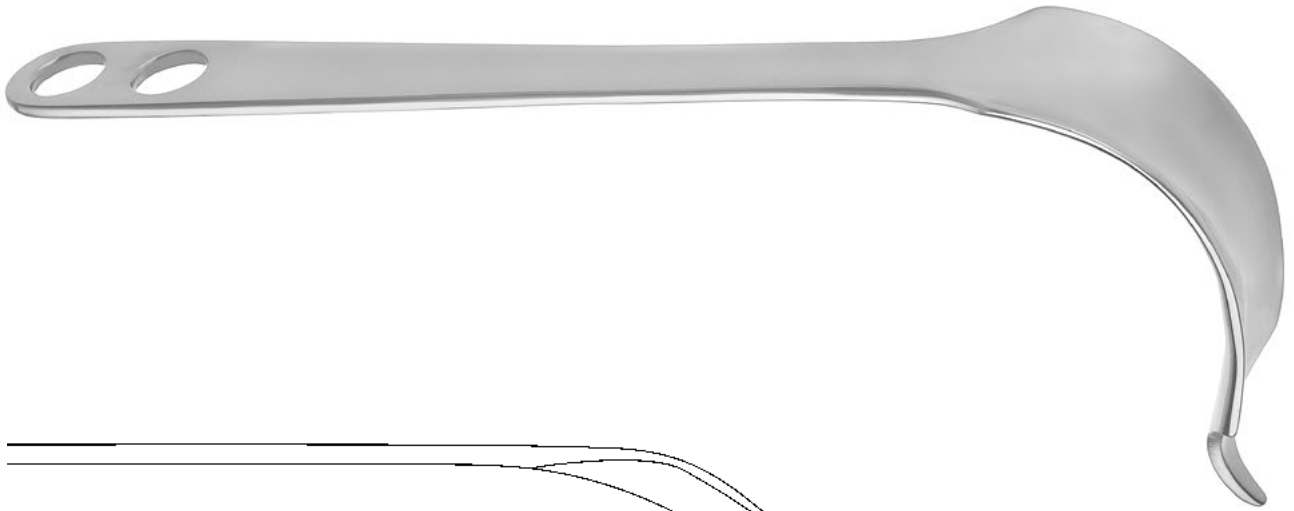

**HOHMANN**

Bone Lever, 40mm

300mm, 11<sup>7</sup>/<sub>8</sub>"

210-545-400



Weight for Hohmann Bone Levers,  
combinable

1200gr

210-541-000



**HOHMANN**

Bone Lever, 22mm,  
with opening for impactor

250mm, 9<sup>7</sup>/<sub>8</sub>"

210-544-250

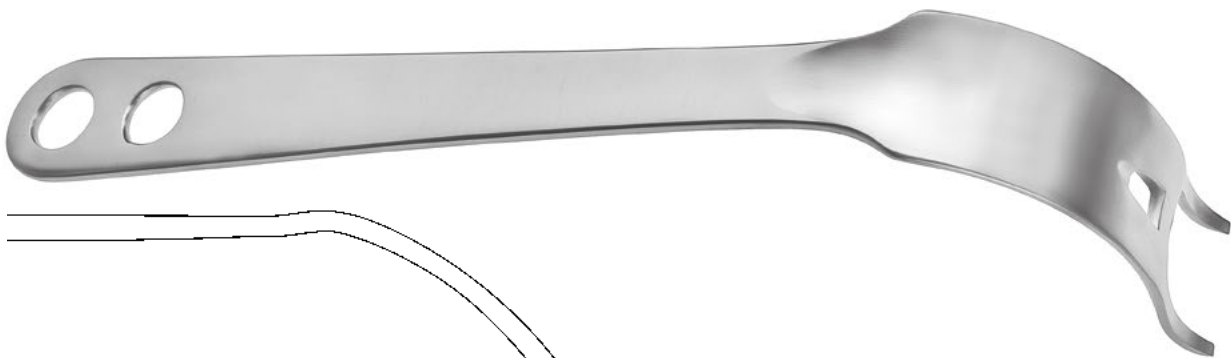
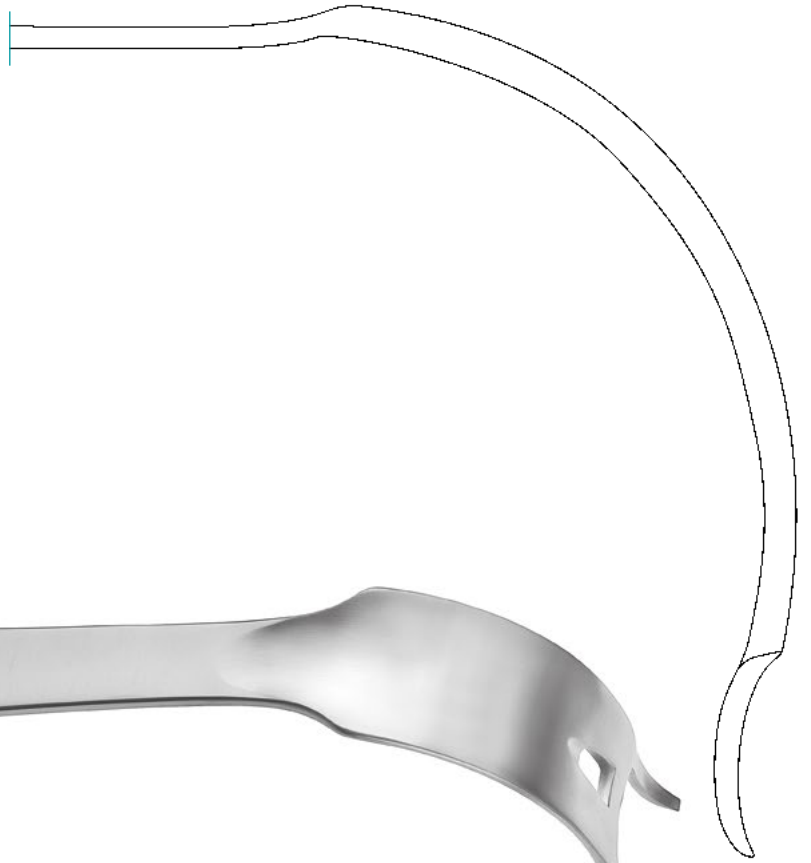

**HOHMANN**

Bone Lever, 40mm,  
with opening for impactor

320mm, 12<sup>1</sup>/<sub>2</sub>"

210-544-320

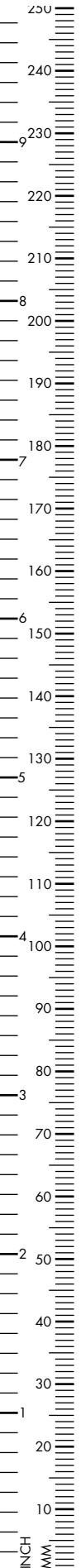
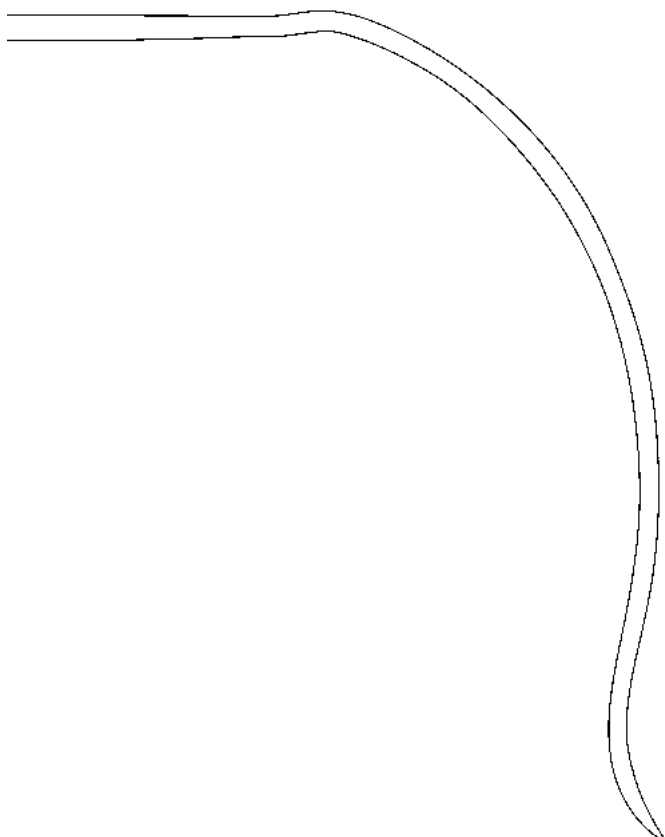



**HOHMANN**  
Bone Lever, 25mm,  
with opening for impactor

270mm, 10<sup>2</sup>/<sub>3</sub>" 210-544-270

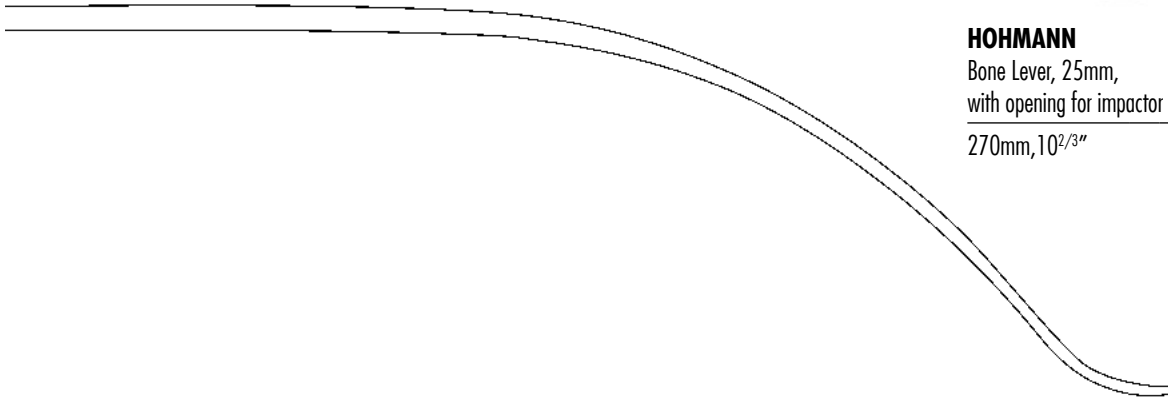

**HOHMANN ALDINGER**  
Bone Lever, 24mm

270mm, 10<sup>2</sup>/<sub>3</sub>" 210-543-270

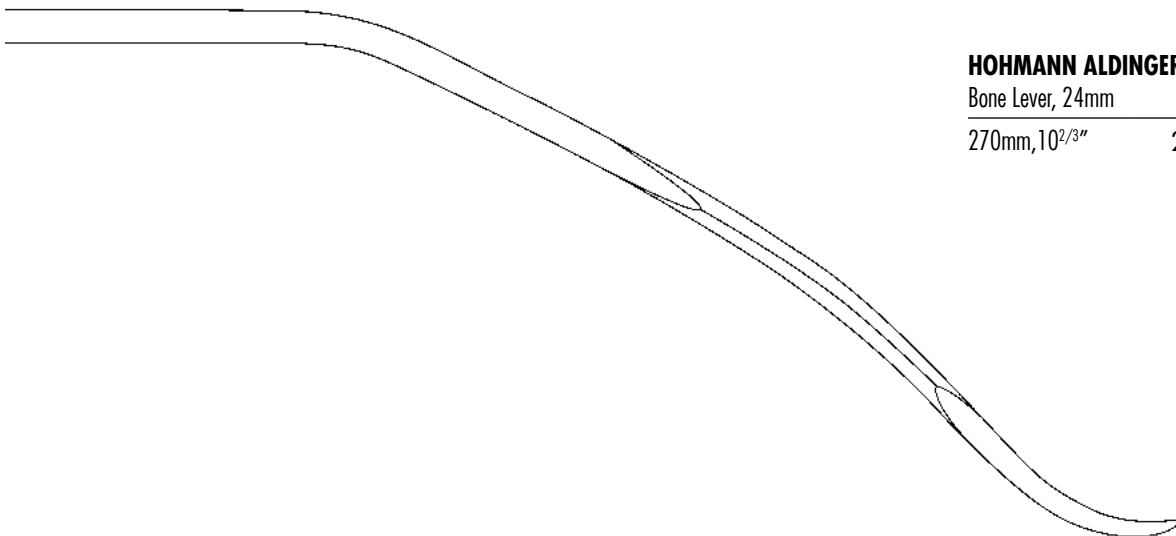

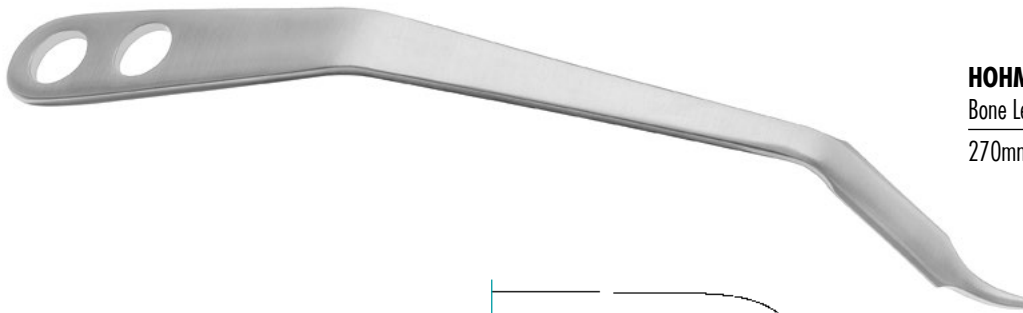

**HOHMANN**

Bone Lever, 15mm, double-angled handle

270mm, 10<sup>2</sup>/<sub>3</sub>"

210-541-270

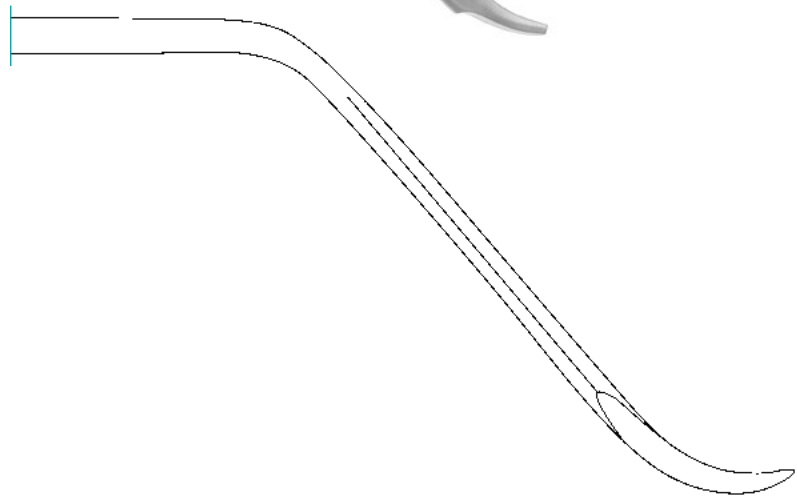

**HOHMANN**

Bone Lever, 18mm, angled handle

225mm, 8<sup>7</sup>/<sub>8</sub>"

210-541-225

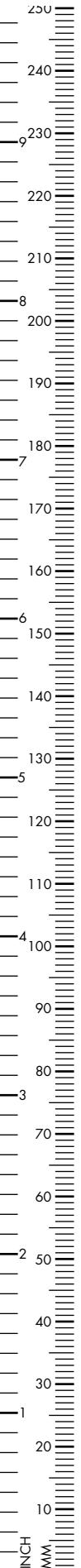
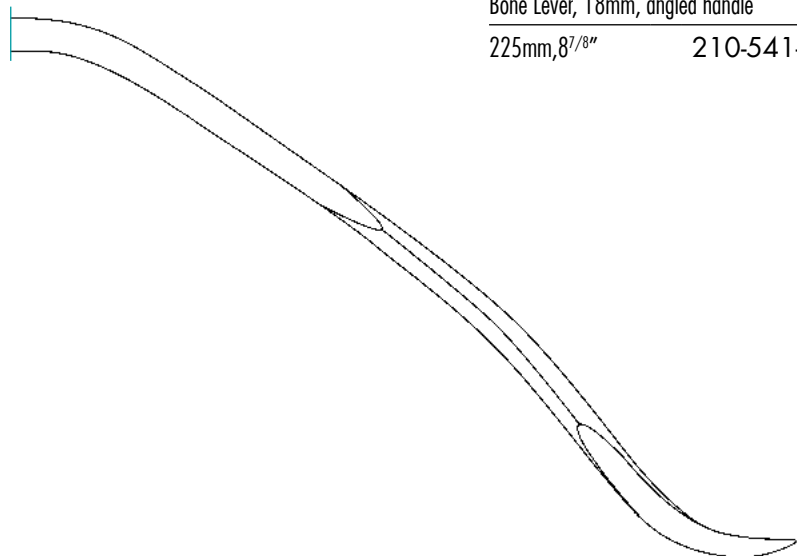

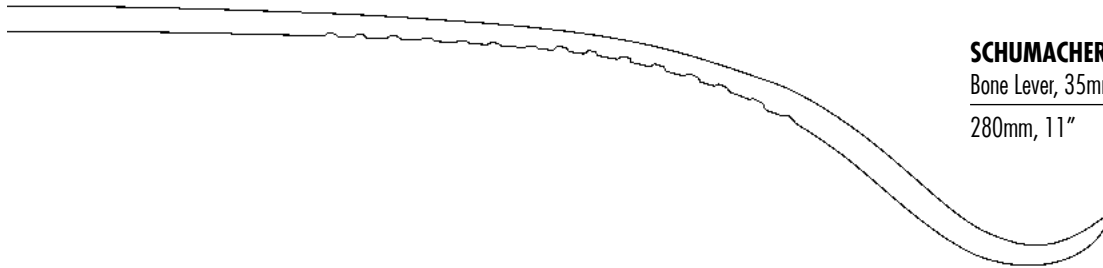

**SCHUMACHER**

Bone Lever, 35mm

280mm, 11"

210-550-280

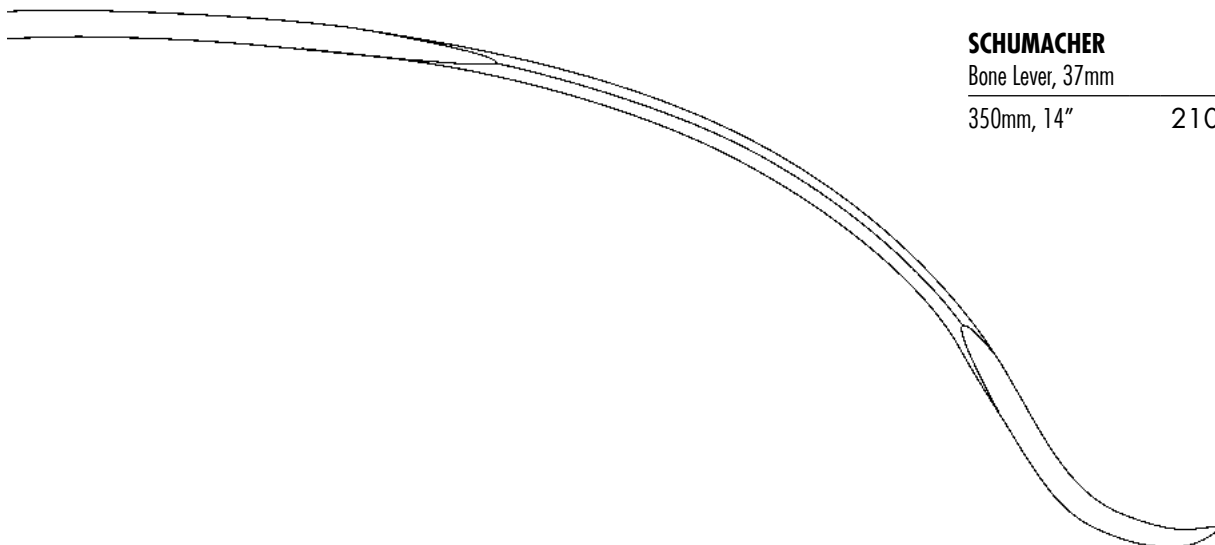
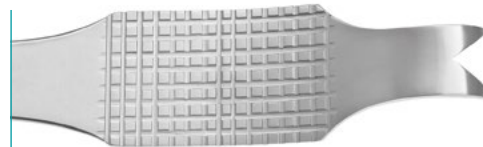

**SCHUMACHER**

Bone Lever, 37mm

350mm, 14"

210-550-350



**WAGNER**

Bone Lever, 8mm, synthetic handle

330mm, 13"

210-540-330

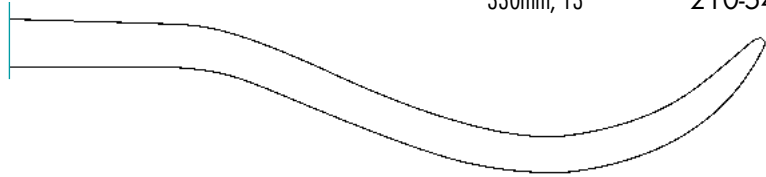

**WATSON JONES**

Bone Lever

280mm, 11"

210-545-280

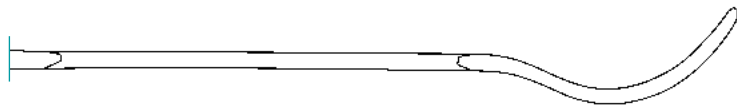

**BENNET**

Bone Lever, 240mm, 9<sup>1/2</sup>"

45mm

210-561-045

65mm

210-561-065

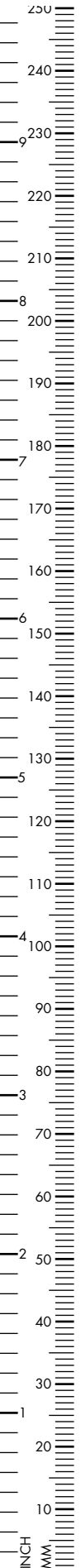



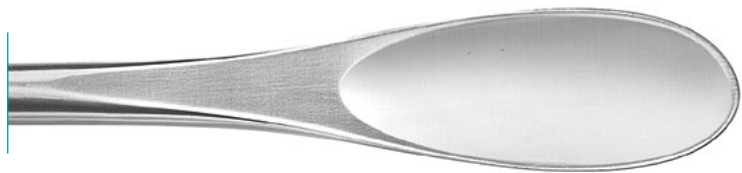

Luxation Lever, synthetic handle, 25mm  
280mm, 11"      210-151-280



Luxation Lever, synthetic handle, 25mm  
310mm, 12<sup>1</sup>/<sub>4</sub>"      210-151-310

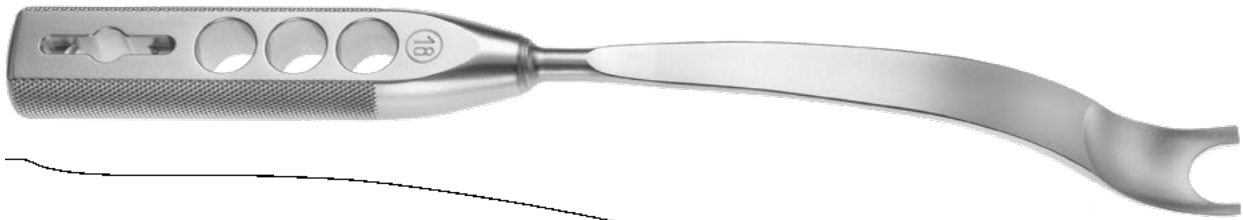

### MÜLLER

Femoral Retractor Lever, 26mm wide

330mm, 13"

210-580-330

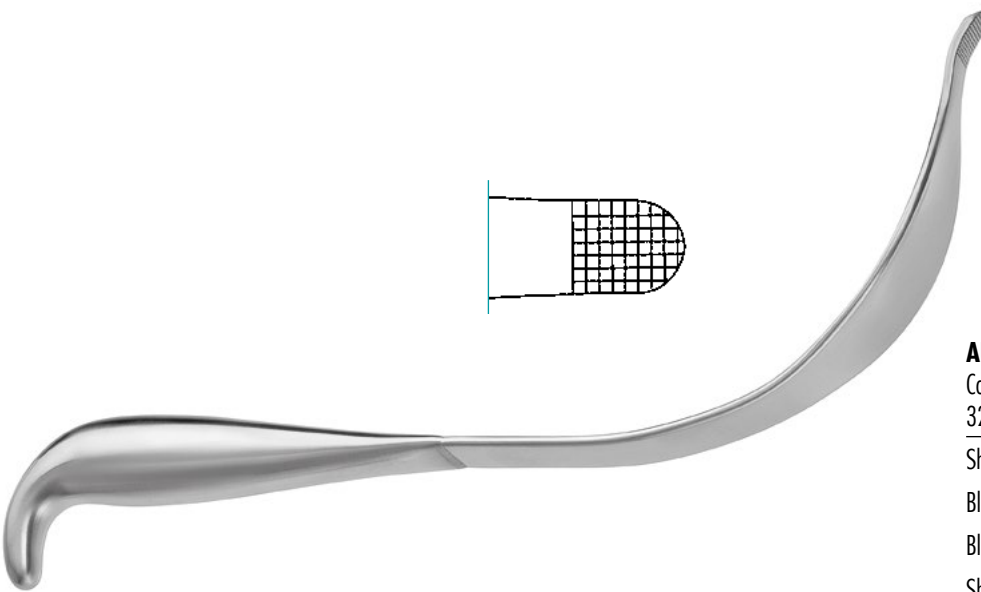

### AUFRANC

Cobra Elevator, 260mm, 10<sup>1</sup>/<sub>4</sub>"

32mm

Sharp, serrated 210-568-260

Blunt, serrated 210-569-260

Blunt, smooth 210-570-260

Sharp, smooth 210-571-260

44mm

Blunt, serrated 210-572-260

Sharp, serrated 210-573-260

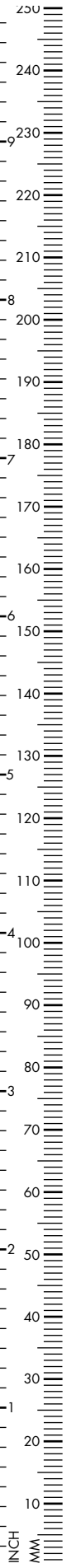



**MURPHY LANE**

Luxation Lever, 30mm

280mm, 11"

210-575-340



**BLOUNT**

Shoulder Retractor, 2 prongs

260mm, 10<sup>1</sup>/<sub>4</sub>"

210-565-260

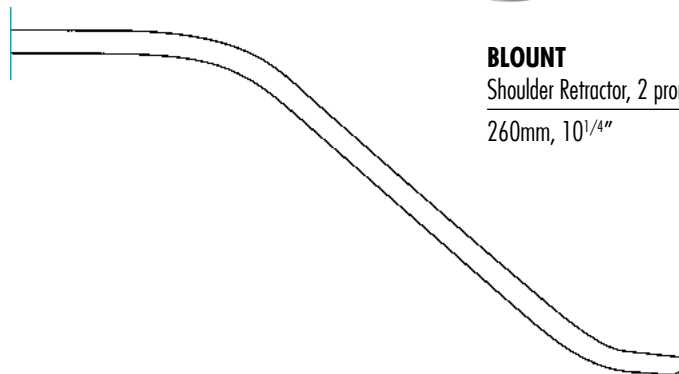



**BLOUNT**  
Bone Lever

260mm, 10<sup>1</sup>/<sub>4</sub>" 210-563-260

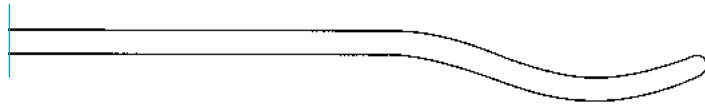

Humeral Head Retractor, strongly curved,  
18mm wide, 1 blunt prong

210mm, 8<sup>1</sup>/<sub>4</sub>" 210-536-180

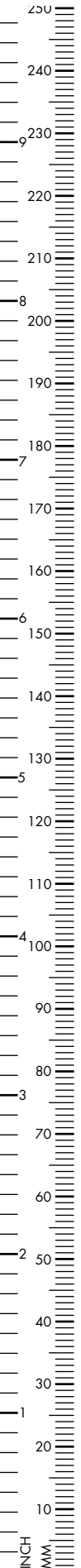

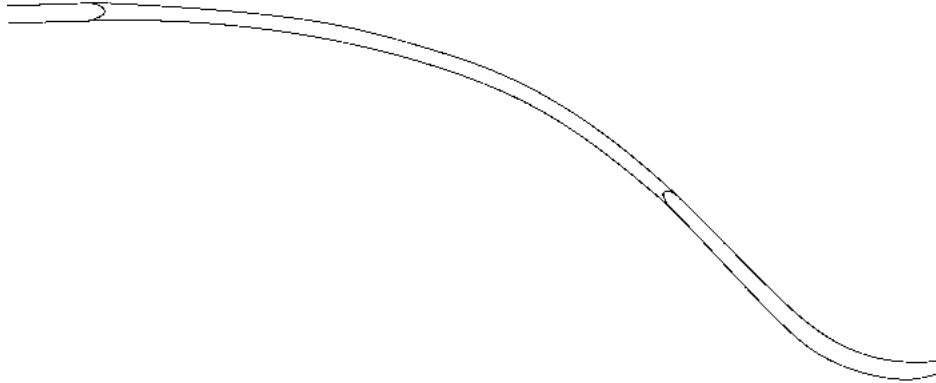

**MIOS**

Hip Retractor, 90°, femoral neck tip, 22mm

300mm, 11<sup>7</sup>/<sub>8</sub>" 210-590-240

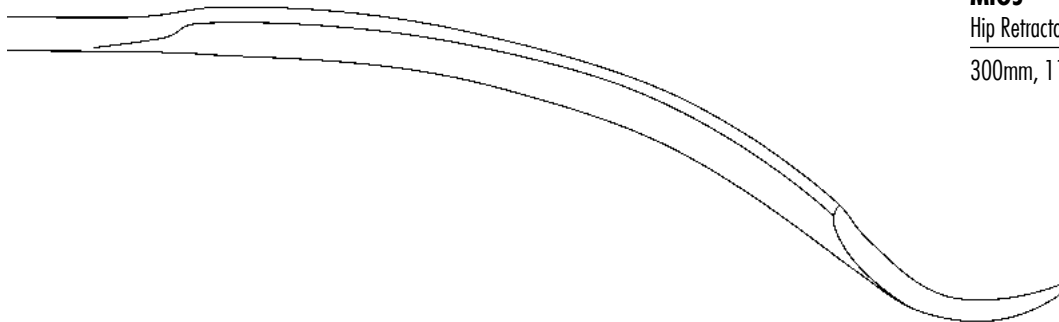

**MIOS**

Hip Retractor, 45°, blunt tip, 28mm

300mm, 11<sup>7</sup>/<sub>8</sub>" 210-545-302

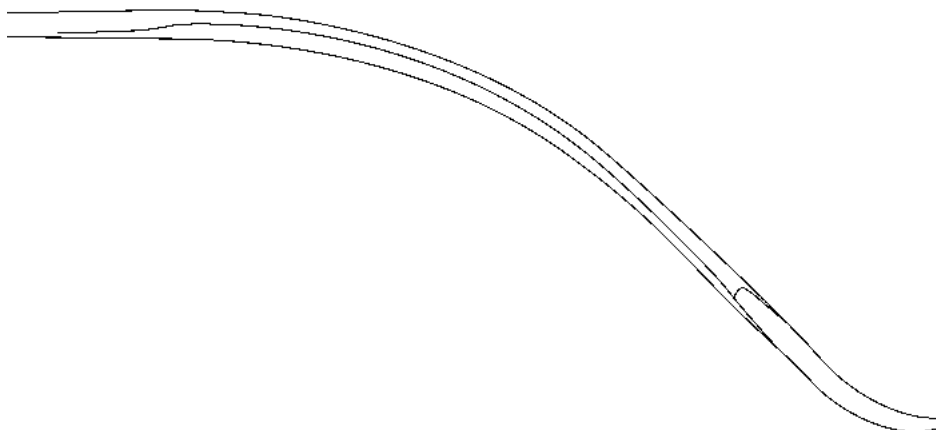

**MIOS**

Hip Retractor, 45°, V-tip, 28mm

300mm, 11<sup>7</sup>/<sub>8</sub>" 210-545-300



**MIOS**

Hip Retractor, 30°, V-tip, 28mm

315mm, 12<sup>1/2</sup>"

210-530-315

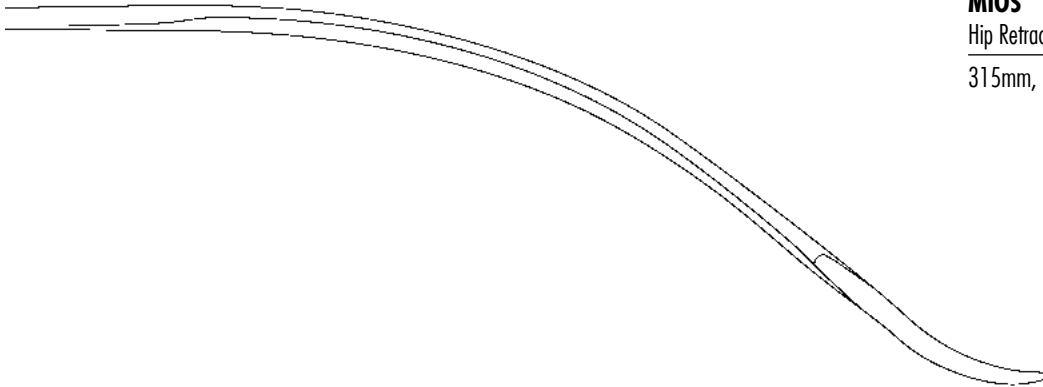

**MIOS**

Hip Retractor, 30°, U-tip, 28mm

315mm, 12<sup>1/2</sup>"

210-520-315

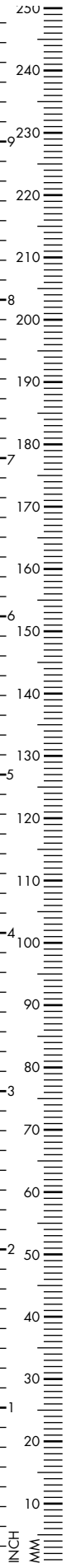
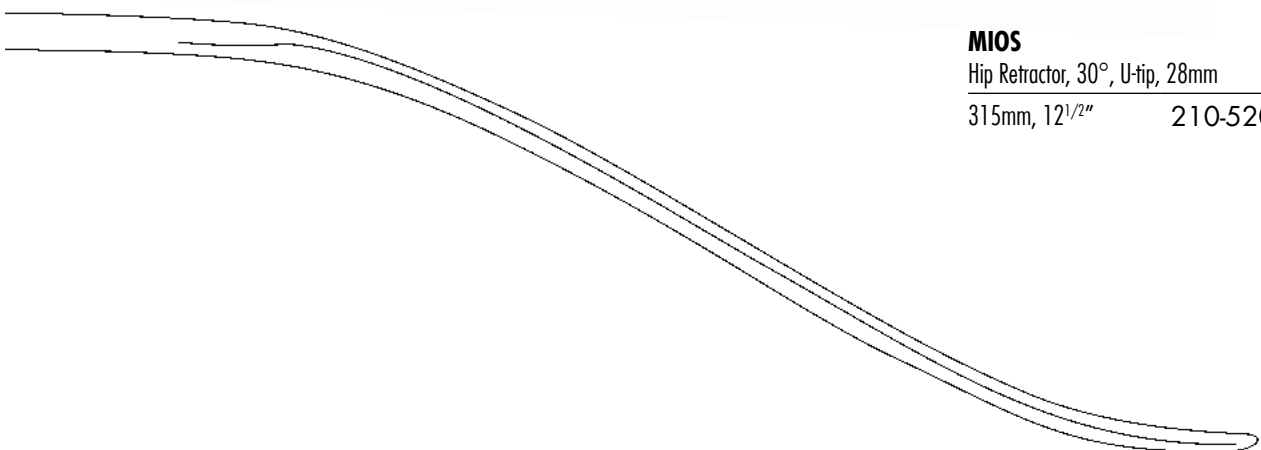

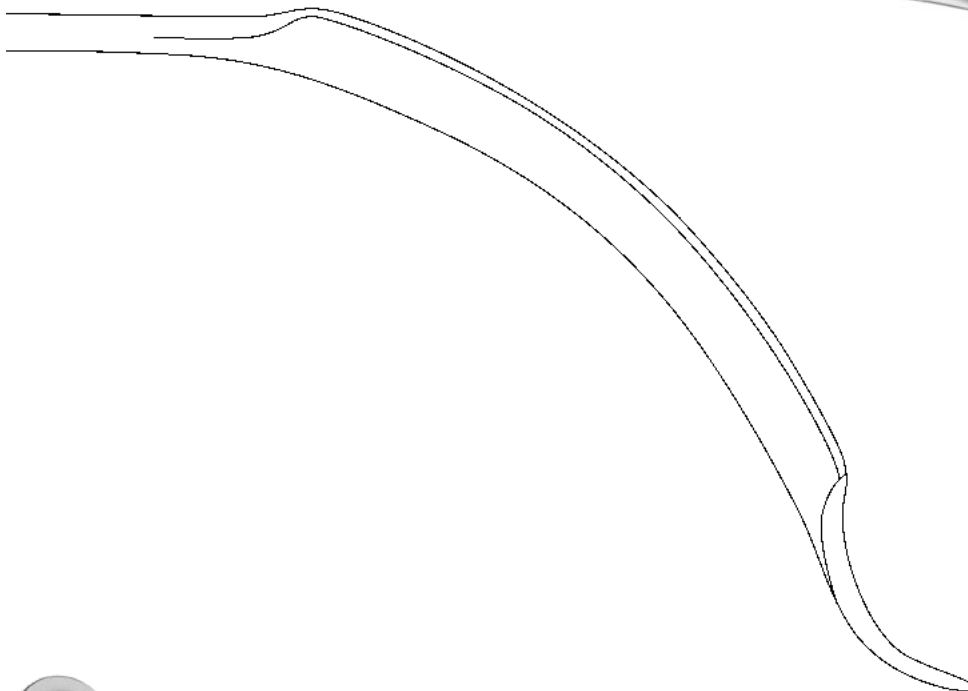
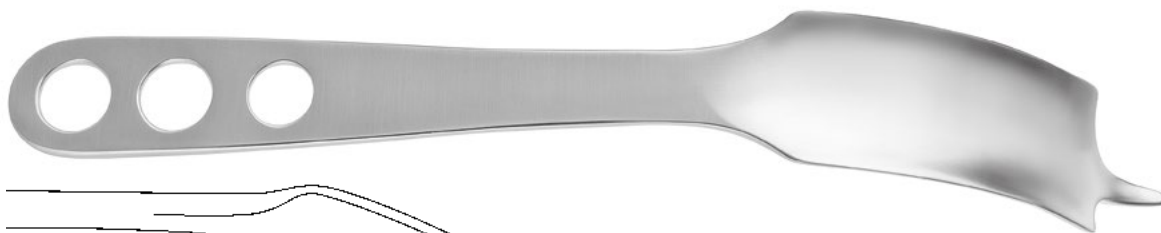

**MIOS**

Hip Retractor, 90°, blunt tip, 40mm

300mm, 11<sup>7/8</sup>"

210-590-241



(210-590-001)

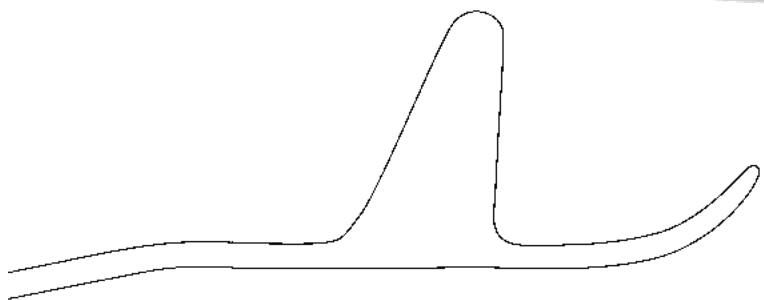

Infero - Posterior Acetabular  
Capsule Retractor

left 210-590-001

right 210-590-002

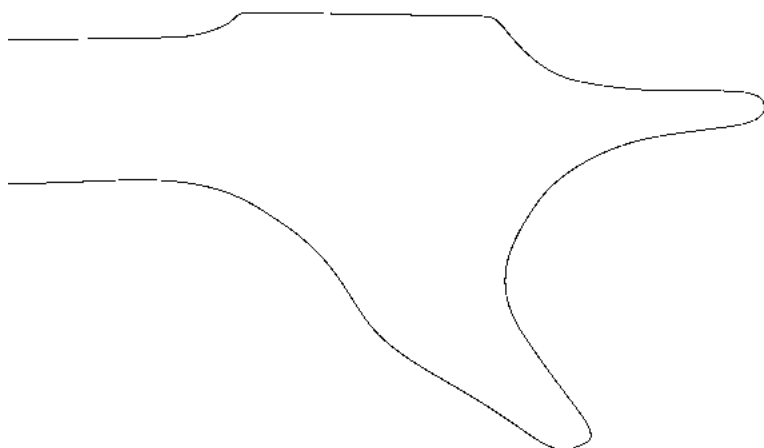



### FUKUDA

Retractor, 180mm, 7"

small, 32mm blade 259-901-180

large, 38mm blade 259-902-180



### FUKUDA KUJAT

Retractor, 225mm, 8<sup>7/8</sup>"

small, 30mm blade 259-900-225

large, 35mm blade 259-903-225



### FUKUDA

Retractor, 170mm, 6<sup>2/3</sup>"

small, 32mm blade 259-904-032

large, 40mm blade 259-904-040

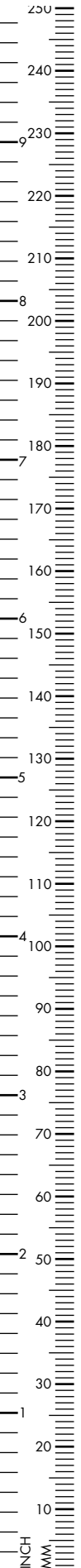





### DARRACH

Shoulder Elevator, 260mm, 10<sup>1/4</sup>"

9mm wide tip	259-260-009
12mm wide tip	259-260-012
16mm wide tip	259-260-016
20mm wide tip	259-260-020
<hr/>	
360mm, 14 <sup>1/8</sup> "	
25mm wide tip	259-260-025



### KÖLBEL

Shoulder Elevator, 2 sharp prongs



15mm wide tip	210-537-281
20mm wide tip	210-537-282
15mm wide tip, hook end	210-537-283
20mm wide tip, hook end	210-537-284
<hr/>	
slightly curved, smooth end	
18mm wide tip	210-537-285

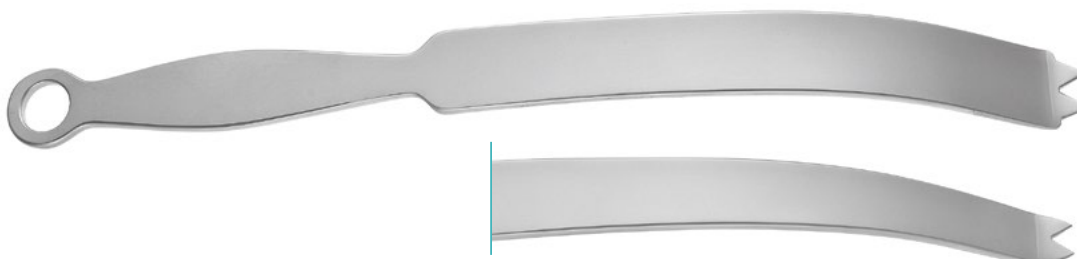

Thin Glenoid Neck Retractor  
280mm, 11"

wide, 22mm	259-258-422
narrow, 14mm	259-258-414

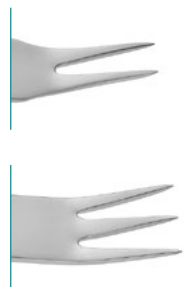
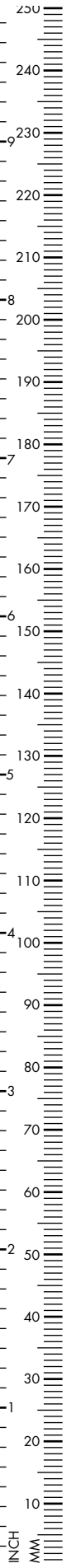

Capsule Retractor for use in Bankhart surgery  
250mm, 9<sup>7</sup>/<sub>8</sub>"

---

1 prong	259-258-251
2 prongs	259-258-252
3 prongs	259-258-253



**BRISTOW BANKHART**  
Capsule Retractor, 20mm wide  
250mm, 9<sup>7</sup>/<sub>8</sub>"

---

	259-254-020
--	-------------



**BRISTOW BANKHART**  
Soft Tissue Retractor, 3 blunt prongs  
21mm blade width  
190mm, 7<sup>1</sup>/<sub>2</sub>"

---

	259-253-180
--	-------------



Anterior Glenoid Neck Retractor  
 25mm wide tip

---

280mm, 11"      259-258-100



Posterior Glenoid Neck Retractor,  
 30mm wide blade

---

250mm, 9<sup>7</sup>/<sub>8</sub>"      259-258-200



**GOLDSTEIN**

Glenoid Neck Retractor, 18mm wide tip at teeth

215mm, 8<sup>1</sup>/<sub>2</sub>"

259-258-400



**BHATTMAN**

Humeral Head Retractor,

36mm wide blade

255mm, 10"

259-258-600



**SKID**

Bone Elevator, double ended

280mm, 11"

259-258-700

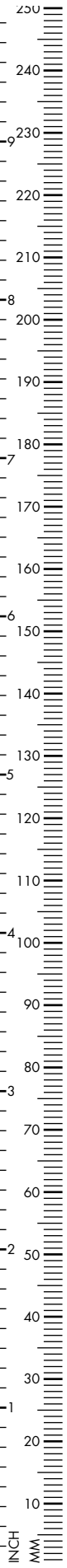



Humeral Head Retractor  
 180mm, 7" 259-258-500



Humeral Head Retractor  
 190mm, 7<sup>1/2</sup>" 259-258-550



**BROWNE**  
 Deltoid Retractor, 60x65mm blade  
 270mm, 10<sup>2/3</sup>" 259-258-270



### BRISTOW BANKART

Humerus Retractor,  
2 blunt prongs, hollow handle

25 x 102mm

259-252-180



### CHANDLER

Tissue Retractor, 230mm, 9"

16mm wide tip

259-258-316

19mm wide tip

259-258-319

25mm wide tip

259-258-325

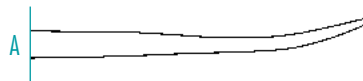

### KOENIG

Elevator, 4.5mm wide, 155mm, 6<sup>1</sup>/<sub>8</sub>"

A Slightly curved	210-551-150
B Strongly curved	210-552-150

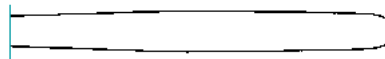

Phalangeal Elevator, 5.5mm wide,  
bayonet strongly curved

165mm, 6 <sup>1</sup> / <sub>2</sub> "	210-523-175
--	-------------

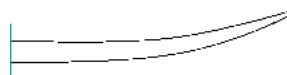

### WILLIGER

Elevator, 160mm, 6<sup>1</sup>/<sub>4</sub>"

5.5mm	210-395-160
7.0mm	210-396-170

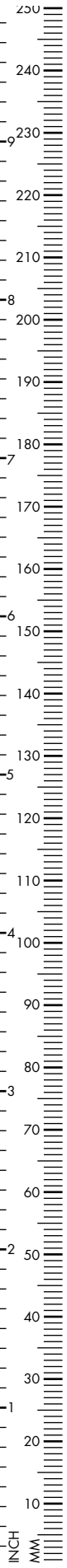

**CAIRNS**  
Skull Flap Elevator

175mm, 6<sup>7</sup>/<sub>8</sub>" 250-066-141

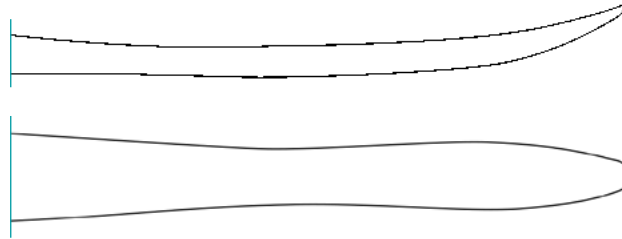

**QUERVAIN**  
Elevator, 6mm

200mm, 8" 210-386-200

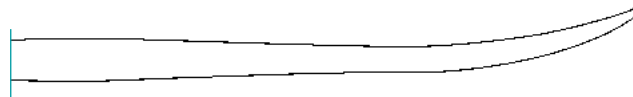

**SEBILEAU**  
Elevator, 5mm

175mm, 6<sup>7</sup>/<sub>8</sub>" 210-395-175

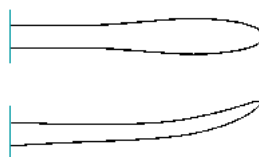





**LANGENBECK**

Elevator, 200mm, 8"

7mm 210-395-200

10mm 210-397-200

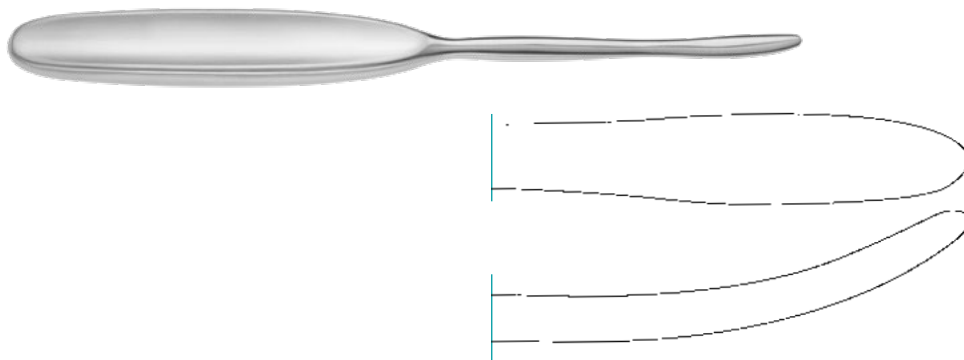

**LANGENBECK**

Elevator, 6.5mm

210mm, 8<sup>1/4</sup>" 210-396-210

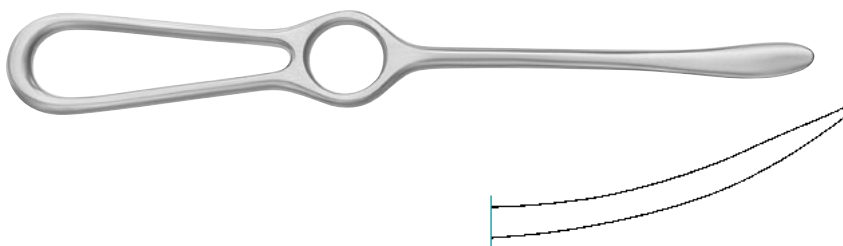

**LANGENBECK**

Elevator, 11mm

230mm, 9" 210-398-230

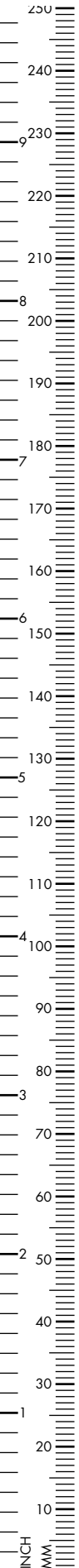

### HOWARTH

Elevator, double-ended, sharp/blunt

215mm, 8<sup>1/2</sup>"

420-552-215

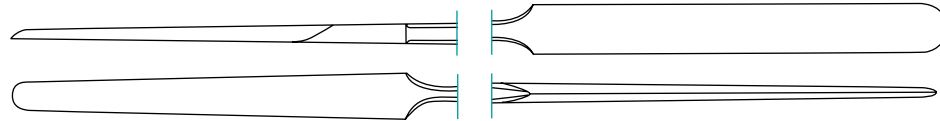

### KILLIAN

Elevator, double-ended, sharp/blunt

185mm, 7<sup>1/4</sup>"

420-541-180



### COTTLE

Elevator, double-ended, graduated,  
sharp/sharp

200mm, 8"

420-550-230

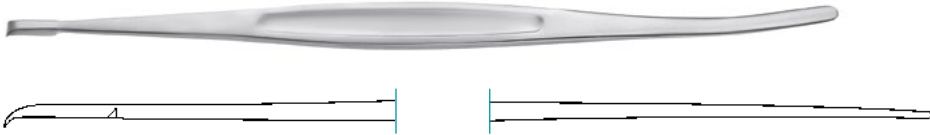

### HILL

Elevator, double-ended, blunt/sharp

220mm, 8<sup>2/3</sup>"

420-554-220

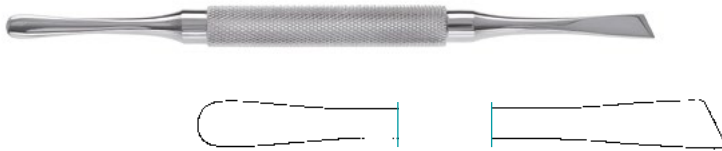

### MEAD

Elevator, double-ended, oblique/rounded

165mm, 6<sup>1/2</sup>"

500-446-165

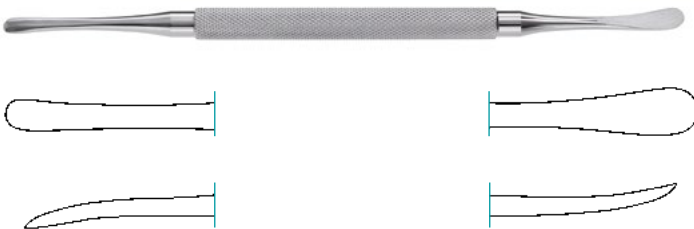

### MOLT

Elevator, double-ended, sharp/sharp

165mm, 6<sup>1/2</sup>"

500-440-180

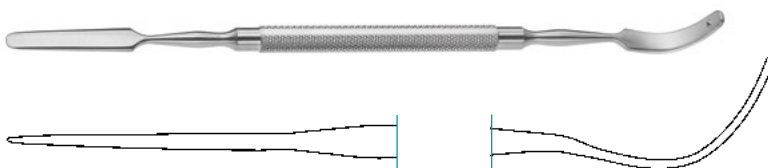

### MCDONALD

Elevator, double-ended, straight / curved

190mm, 7<sup>1/2</sup>"

210-527-190

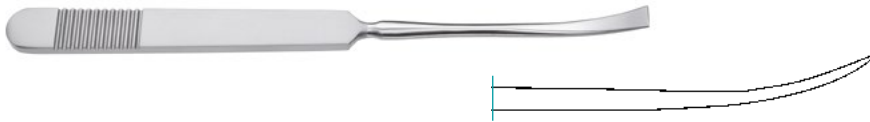

**PENNYBAKER**

Elevator, sharp, 6mm

150mm, 6"

210-488-170



**JANSEN**

Periosteal Elevator, curved

165mm, 6 1/2"

210-303-165

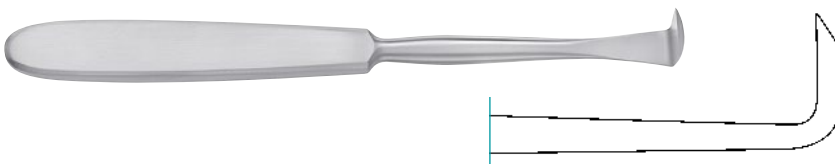

**LANGENBECK**

Periosteal Elevator, 14mm, hollow handle

180mm, 7"

210-301-180

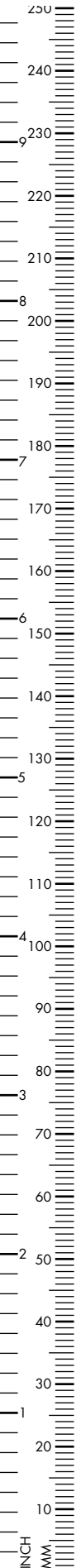



### KEY

Elevator, 180mm, 7"

3mm	210-489-003
-----	-------------

6mm	210-489-006
-----	-------------

190mm, 7<sup>1/2</sup>"

10mm	210-489-010
------	-------------

12mm	210-489-012
------	-------------

13mm	210-489-013
------	-------------

16mm	210-489-016
------	-------------

200mm, 8"

19mm	210-489-019
------	-------------

210mm, 8<sup>1/4</sup>"

25mm	210-489-025
------	-------------



### CREGO

Elevator, 200mm, 8"

7mm	170-492-001
-----	-------------

14mm	170-492-004
------	-------------

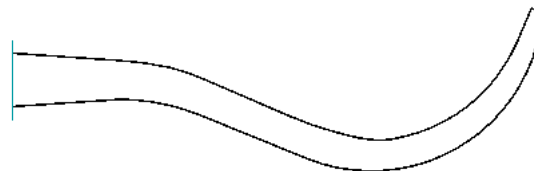

### COBB

Elevator, 240mm, 9<sup>1/2</sup>"

9mm	210-401-095
-----	-------------

13mm	210-401-127
------	-------------

19mm	210-401-019
------	-------------

25mm	210-401-025
------	-------------

32mm	210-401-032
------	-------------



**COBB**

Spinal Elevator, 240mm, 9<sup>1</sup>/<sub>2</sub>"

9mm	210-400-001
13mm	210-400-002
19mm	210-400-003
25mm	210-400-004
32mm	210-400-005

290mm, 11<sup>1</sup>/<sub>2</sub>"

9mm	210-402-009
13mm	210-402-013
19mm	210-402-019
25mm	210-402-025
32mm	210-402-032



**COBB**

Elevator, semi-sharp, slightly curved, synthetic handle, 250mm, 9<sup>7</sup>/<sub>8</sub>"

10mm	210-420-010
13mm	210-420-013
19mm	210-420-019
25mm	210-420-025



**COBB**

Elevator, synthetic handle, 340mm, 13<sup>1</sup>/<sub>2</sub>"

10mm	210-405-010
15mm	210-405-015
20mm	210-405-020
25mm	210-405-025
30mm	210-405-030
35mm	210-405-035

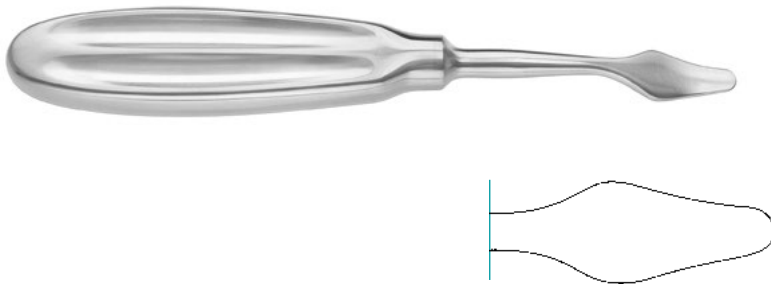

### CHANDLER

Elevator, 180mm, 7"

13mm	210-490-013
------	-------------

200mm, 8"	
-----------	--

19mm	210-490-019
------	-------------

25mm	210-490-025
------	-------------

250mm, 9 <sup>7</sup> / <sub>8</sub> "	
--	--

31mm	210-491-030
------	-------------



### LANE

Periosteal Elevator, 190mm, 7<sup>1</sup>/<sub>2</sub>"

7mm	210-483-190
-----	-------------

10mm	210-484-190
------	-------------



### SAYRE

Periosteal Elevator, double-ended, 9.5mm,  
170mm, 6<sup>2</sup>/<sub>3</sub>"

sharp	210-397-170
-------	-------------

blunt	210-340-170
-------	-------------

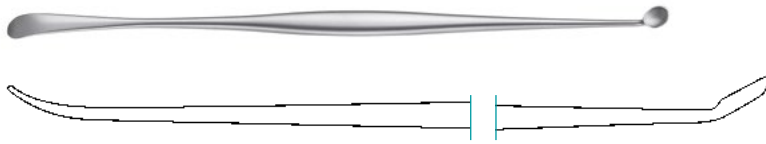
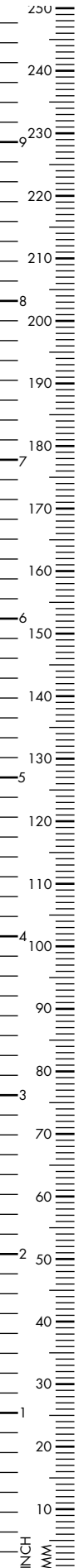

**PENFIELD**

Dissector, Fig. 1

175mm, 6<sup>7/8</sup>"

250-691-175

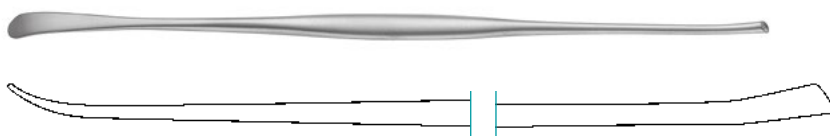

**PENFIELD**

Dissector, Fig. 2

195mm, 7<sup>3/4</sup>"

250-692-195

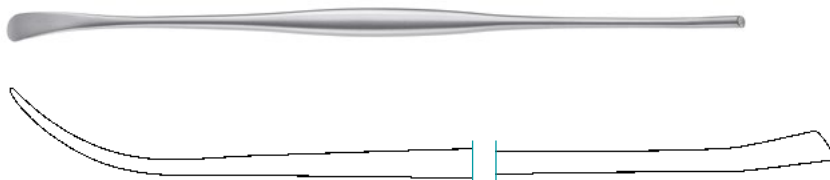

**PENFIELD**

Dissector, Fig. 3

195mm, 7<sup>3/4</sup>"

250-693-195





**PENFIELD**

Dissector, Fig. 4

205mm, 8<sup>1</sup>/<sub>8</sub>"

250-694-215

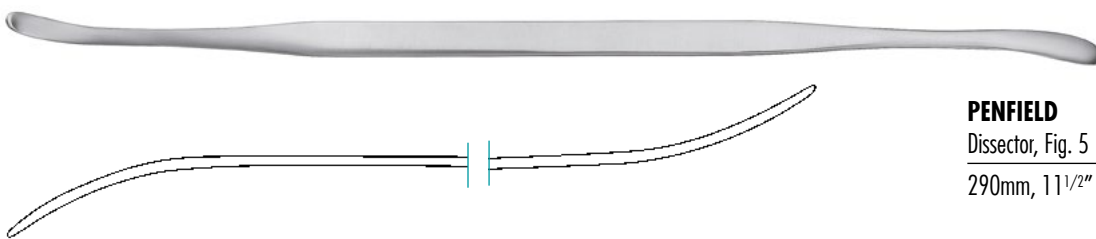

**PENFIELD**

Dissector, Fig. 5

290mm, 11<sup>1</sup>/<sub>2</sub>"

250-695-290

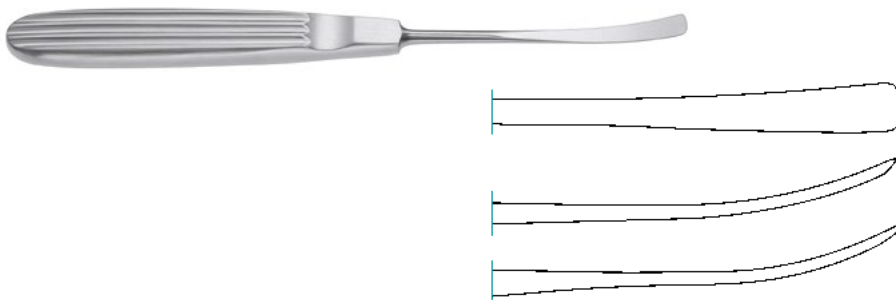

**CASPAR**

Dissector, 6.2mm, 180mm, 7"

sharp

259-185-328

blunt

259-185-329



### MCKENTY

Raspatory, 150mm, 6"

4mm 420-547-004

5mm 420-547-005



### KOENIG

Raspatory, 5mm

150mm, 6" 210-553-150



### FREER

Raspatory, 4mm, 190mm, 7 1/2"

blunt 420-547-190

sharp 420-548-190

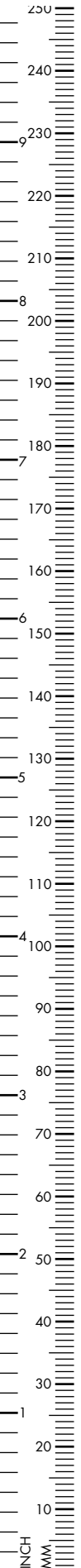



### SEWALL

Raspatory, 6mm, blunt

200mm, 8"

420-549-200



### KILLIAN

Raspatory, 6mm, sharp/blunt

180mm, 7"

420-540-180

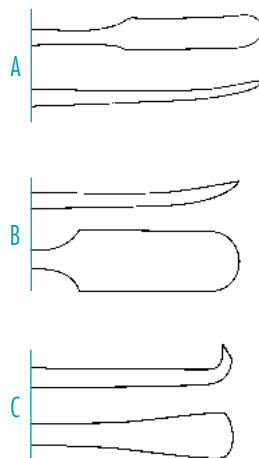

### MANNERFELT

Raspatory, 155mm, 6<sup>1</sup>/<sub>8</sub>"

A 6mm

420-556-004

B 8mm

420-556-005

C 6mm

420-557-008

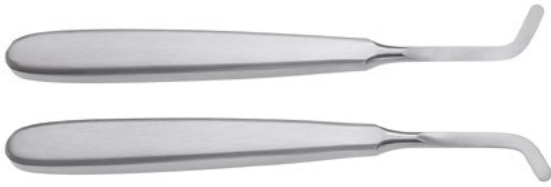
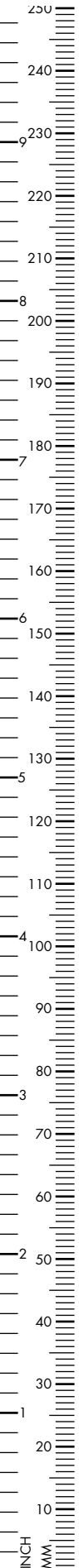

Raspatory, 4mm, 140mm, 5<sup>1</sup>/<sub>2</sub>"

Curved left 210-552-140

Curved right 210-551-140

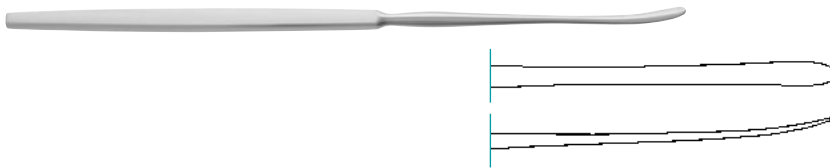

### **HALLE**

Raspatory, 4mm, blunt

180mm, 7" 420-544-165



### **WILLIGER**

Raspatory, 4mm

130mm, 5<sup>1</sup>/<sub>8</sub>" 210-434-130

160mm, 6<sup>1</sup>/<sub>4</sub>"

5mm 210-436-160

7mm 210-438-160



### JOSEPH

Raspatory, 4mm

160mm, 6<sup>1/4</sup>"

210-396-160



### LEMPERT

Raspatory, 4mm

185mm, 7<sup>1/4</sup>"

210-397-185



### COTTLE

Raspatory, 8mm, sharp

190mm, 7<sup>1/2</sup>"

210-438-195



### LANDOLT

Raspatory, 4.5mm

175mm, 6<sup>7</sup>/<sub>8</sub>"

210-439-175

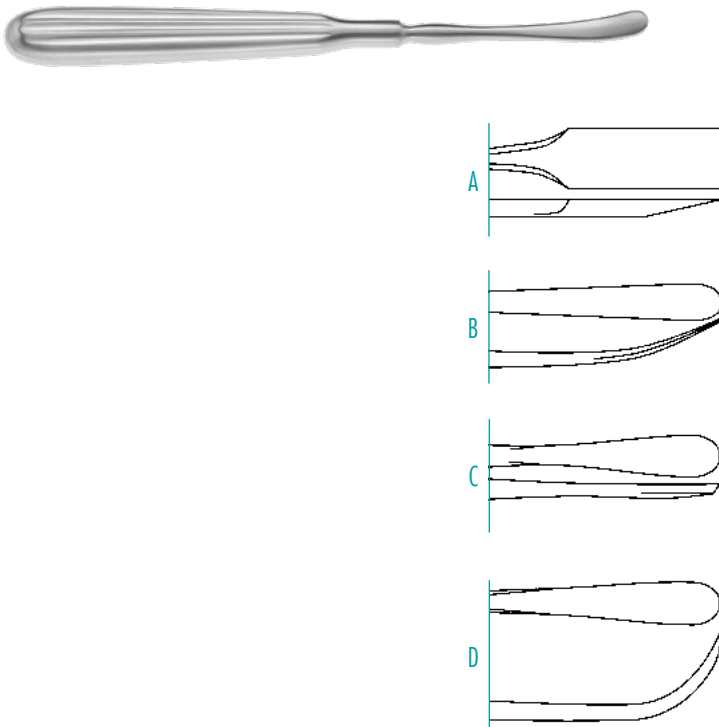

### ADSON

Raspatory, 170mm, 6<sup>2</sup>/<sub>3</sub>"

A 8mm, sharp

210-484-170

B 8mm, blunt

210-485-170

C 7mm, semi-sharp

210-486-170

D 7mm, semi-sharp

210-487-170

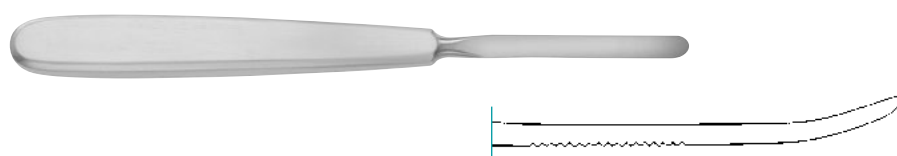

Raspatory, 170mm, 6<sup>2</sup>/<sub>3</sub>"

6mm

210-439-006

8mm

210-439-008

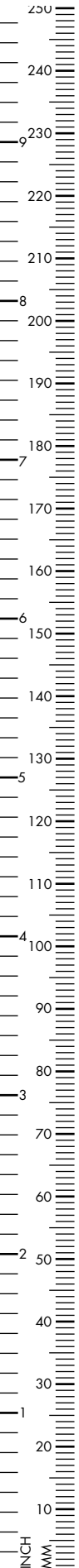

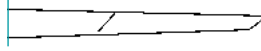

Raspatory, synthetic handle,  
6mm

190mm, 7<sup>1</sup>/<sub>2</sub>" 210-434-180

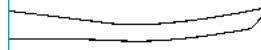

3mm

185mm, 7<sup>1</sup>/<sub>4</sub>" 210-432-185

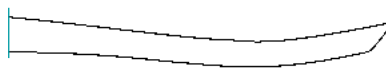

6mm

185mm, 7<sup>1</sup>/<sub>4</sub>" 210-433-180

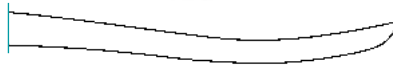

6mm

185mm, 7<sup>1</sup>/<sub>4</sub>" 210-432-180



Raspatory, synthetic handle,  
13mm

185mm, 7<sup>1</sup>/<sub>4</sub>" 210-433-185



14mm

200mm, 8" 210-430-200



14mm

200mm, 8" 210-431-000

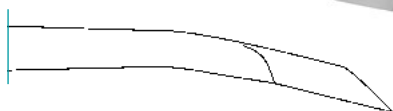

Raspatory, 13mm, synthetic handle

230mm, 9" 210-433-230

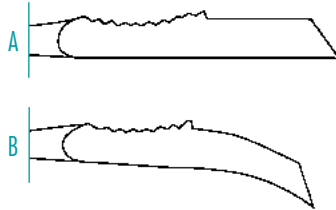

### FARABEU

Raspatory, 12.5mm, 150mm, 6"

A straight 210-310-150

B curved 210-311-150

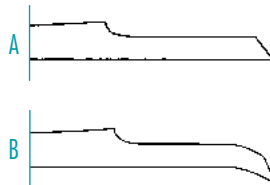

### FARABEU COLLIN

Raspatory, 11mm, 155mm, 6<sup>1</sup>/<sub>8</sub>"

A straight 210-312-155

B curved 210-313-155

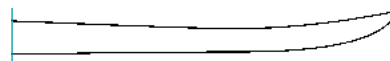

### SEDILLOT

Raspatory, 18mm, hollow handle

190mm, 7<sup>1</sup>/<sub>2</sub>" 210-316-190

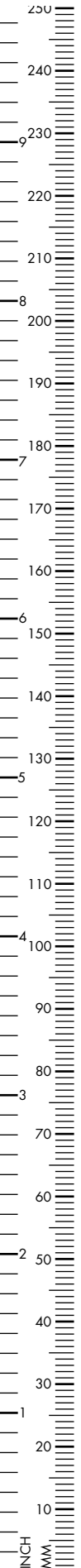





### HENAHAN

Raspatory, curved, 170mm, 6<sup>2</sup>/<sub>3</sub>"

10mm 210-410-170

12mm 210-412-170



### KRAEMER

Raspatory, 10mm, round blade

185mm, 7<sup>1</sup>/<sub>4</sub>" 210-313-185



### KRAEMER

Raspatory, 10mm, straight blade

185mm, 7<sup>1</sup>/<sub>4</sub>" 210-313-185

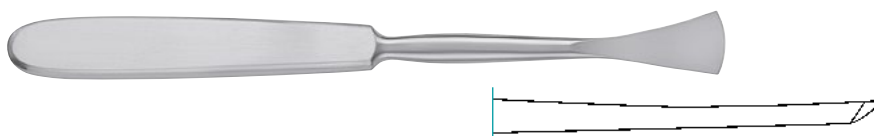

### LANGENBECK

Raspatory, 16mm, hollow handle

190mm, 7<sup>1</sup>/<sub>2</sub>" 210-303-190

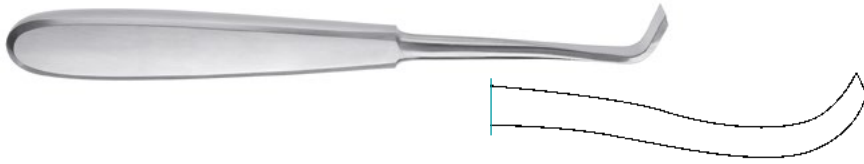

**SCHNEIDER**

Raspatory, 13mm

175mm, 6<sup>7</sup>/<sub>8</sub>"

210-315-175

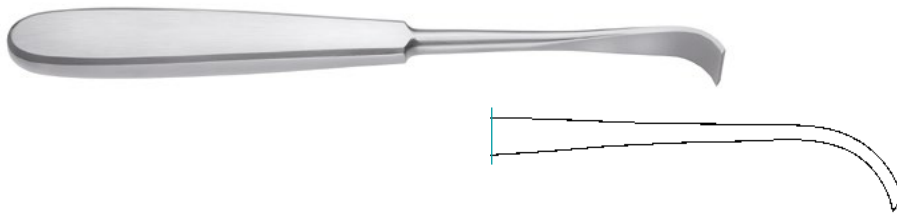

**SCHNEIDER SAUERBRUCH**

Raspatory, 13mm

190mm, 7<sup>1</sup>/<sub>2</sub>"

210-315-190

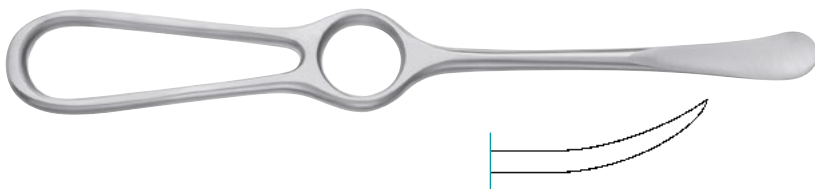

**SEDILLOT**

Raspatory, 15mm

210mm, 8<sup>1</sup>/<sub>4</sub>"

210-315-210

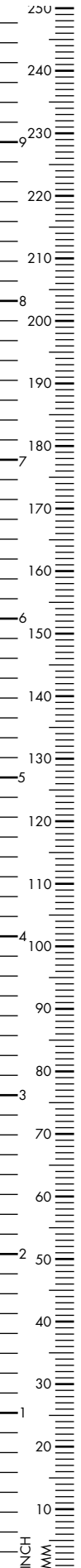



### LAMBOTTE

Raspatory, 210mm, 8<sup>1</sup>/<sub>4</sub>"

5mm	210-461-005
10mm	210-461-210
15mm	210-462-210
20mm	210-463-210
25mm	210-464-210



### ALEXANDER

Periosteotome, 12mm

210mm, 8 <sup>1</sup> / <sub>4</sub> "	210-440-200
--	-------------



### MCGLAMRY

Raspatory, 210mm, 8<sup>1</sup>/<sub>4</sub>"

9mm	170-160-010
11mm	170-160-012
15mm	170-160-015
17mm	170-160-017



Trapeziectomy screw with handle

190mm, 7 <sup>1</sup> / <sub>2</sub> "	225-810-500
--	-------------

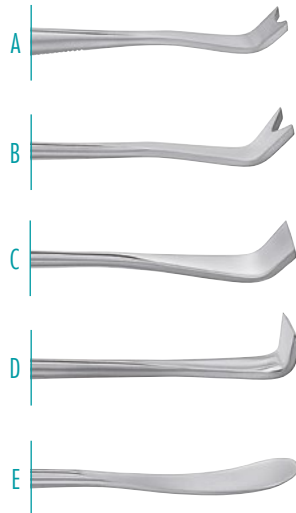
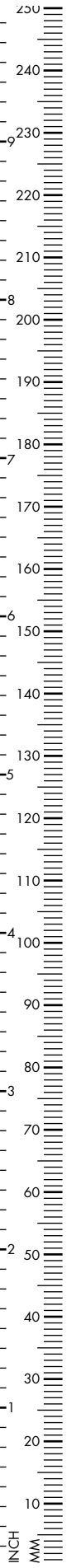

**SEM B**

Raspatory, hollow handle, 190mm, 7<sup>1</sup>/<sub>2</sub>"

A 12mm	210-450-001
230mm, 9"	
B 12mm	210-450-002
C 13mm	210-450-003
D 13mm	210-450-004
E 15mm	210-450-005



Hip Raspatory, synthetic handle, 20mm

275mm, 10<sup>7</sup>/<sub>8</sub>" 210-420-275

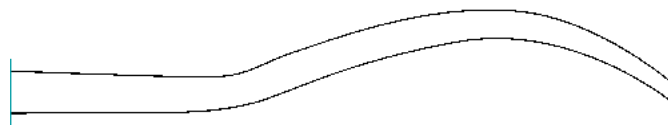

**WAGNER**

Raspatory, synthetic handle, 330mm, 13"

8mm	210-428-330
17mm	210-417-330



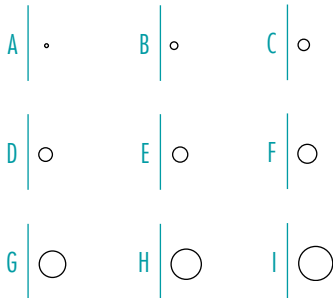

### MEYERHOFER

Chalazion Curette, 130mm, 5<sup>1</sup>/<sub>8</sub>"

A Size 000, Ø 0.5mm	400-402-005
B Size 00, Ø 1.0mm	400-402-010
C Size 0, Ø 1.5mm	400-402-015
D Size 1, Ø 1.8mm	400-402-018
E Size 2, Ø 2.0mm	400-402-020
F Size 3, Ø 2.5mm	400-402-025
G Size 4, Ø 3.5mm	400-402-035
H Size 5, Ø 4.0mm	400-402-040
I Size 6, Ø 4.5mm	400-402-045



### MARTINI

Double Curette, round/round, 140mm, 5<sup>1</sup>/<sub>2</sub>"

A #00/0 (Ø 3.0 / 3.2mm)	210-218-140
B #0/1 (Ø 3.2 / 4.0mm)	210-219-140
C #1/2 (Ø 4.0 / 4.8mm)	210-218-012



### WILLIGER

Double Curette, oval/oval, 140mm, 5<sup>1</sup>/<sub>2</sub>"

A #00/0 (Ø 2.5 / 3.0mm)	210-216-000
B #0/1 (Ø 3.0 / 3.5mm)	210-216-001
C #1/2 (Ø 3.5 / 4.2mm)	210-216-002

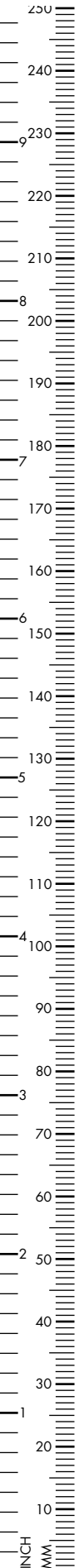

**JACOBSON**  
Double Curette

140mm, 5<sup>1/2</sup>" 210-213-140



**JANSEN**  
Double Curette, 4.0/3.0mm

160mm, 6<sup>1/4</sup>" 210-218-160



**JANSEN**  
Double Curette, 4.0/3.0mm

210mm, 8<sup>1/4</sup>" 210-214-210

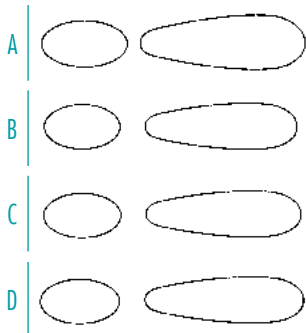

### VOLKMANN

Double Curette, 130mm, 5<sup>1</sup>/<sub>8</sub>"

A 6.5 / 7.7mm 210-210-130

140mm, 5<sup>1</sup>/<sub>2</sub>"

B 6.2 / 6.8mm 210-210-140

170mm, 6<sup>2</sup>/<sub>3</sub>"

C 6.8 / 6.8mm 210-210-170

200mm, 8"

D 6.2 / 7.5mm 210-210-200

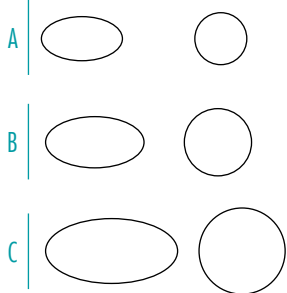

### VOLKMANN

Double Curette, 130mm, 5<sup>1</sup>/<sub>8</sub>"

A 6.8 / 6.3mm 210-211-130

160mm, 6<sup>1</sup>/<sub>4</sub>"

B 9.0 / 7.0mm 210-211-160

200mm, 8"

C 11.0 / 9.0mm 210-211-200

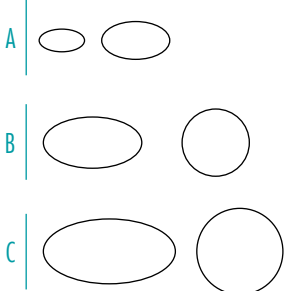

### VOLKMANN

Double Curette, 220mm, 8<sup>2</sup>/<sub>3</sub>"

A #1 3.0/5.0mm 410-746-001

B #2 4.0/6.0mm 410-746-002

C #3 5.0/7.0mm 410-746-003

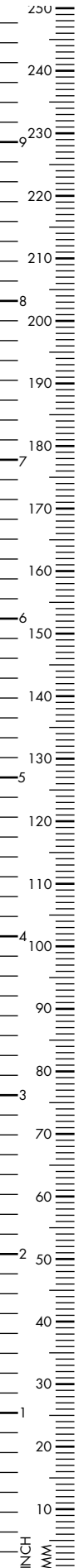

**WILLIGER**

Double Curette, 160mm, 6<sup>1</sup>/<sub>4</sub>"

A #00/00

210-216-020



**JANSEN**

Double Curette, 3.0/4.0mm

150mm, 6"

210-216-150



**HEMINGWAY**

Double Curette, #4

180mm, 7"

210-215-004



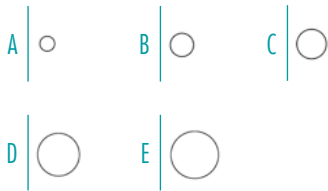

### BUCK

Bone Curette, 145mm, 5<sup>3</sup>/<sub>4</sub>"

A Fig. 1	210-201-145
B Fig. 2	210-202-145
C Fig. 3	210-203-145
D Fig. 4	210-204-145
E Fig. 5	210-205-145

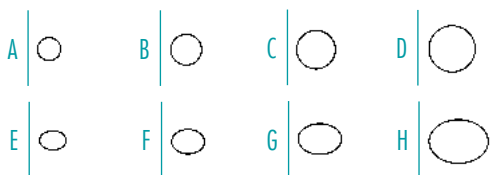

### BUCK

Bone Curette, round, 170mm, 6<sup>2</sup>/<sub>3</sub>"

A Fig. 00, 3.0mm	210-213-175
B Fig. 0, 4.0mm	210-214-175
C Fig. 1, 5.0mm	210-215-175
D Fig. 2, 6.0mm	210-216-175

oval

E Fig. 00, 2.5mm	210-294-010
F Fig. 0, 3.2mm	210-294-020
G Fig. 1, 4.0mm	210-294-040
H Fig. 2, 5.7mm	210-294-050

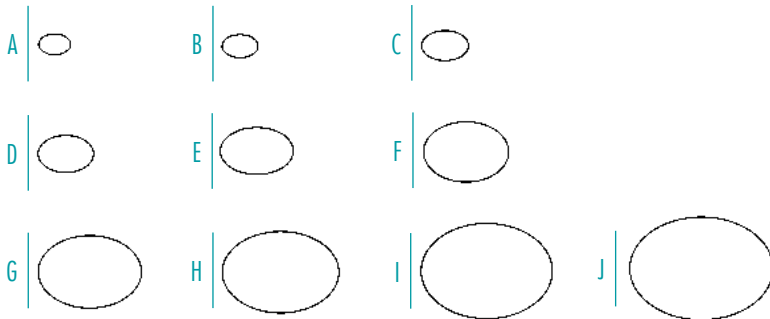

### VOLKMANN

Bone Curette, 170mm, 6<sup>2</sup>/<sub>3</sub>"

A #0000	210-304-400
B #000	210-304-300
C #00	210-304-200
D #0	210-304-100
E #1	210-304-010
F #2	210-304-020
G #3	210-304-030
H #4	210-304-040
I #5	210-304-050
J #6	210-304-060

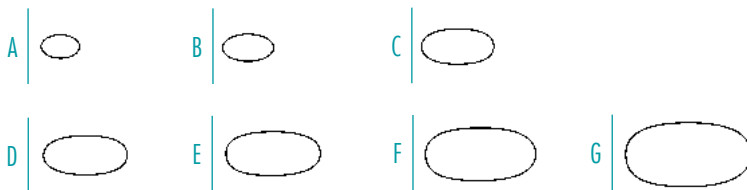

### SCHEDE

Bone Curette, 170mm, 6<sup>2</sup>/<sub>3</sub>"

A #000	210-300-300
B #00	210-300-200
C #0	210-300-100
D #1	210-300-010
E #2	210-300-020
F #3	210-300-030
G #4	210-300-040

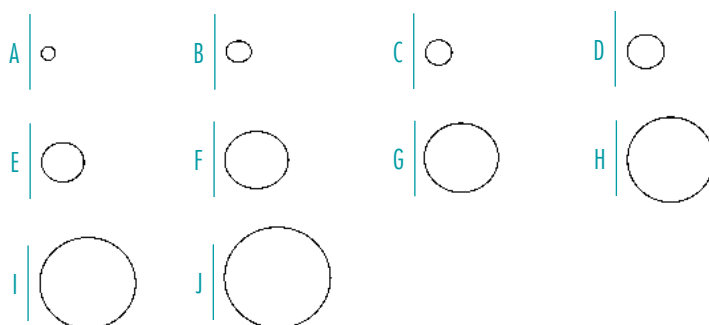

### BRUNS

Bone Curette, round, 170mm, 6<sup>2</sup>/<sub>3</sub>"

A #0000	210-306-400
B #000	210-306-300
C #00	210-306-200
D #0	210-306-100
E #1	210-306-010
F #2	210-306-020
G #3	210-306-030
H #4	210-306-040
I #5	210-306-050
J #6	210-306-060

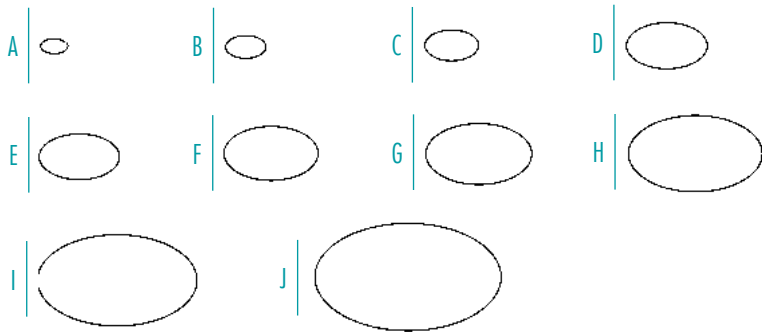

### STILLE

Bone Curette, oval, 170mm, 6<sup>2</sup>/<sub>3</sub>"

A Ø 2mm	210-249-002
B Ø 3mm	210-249-003
C Ø 4mm	210-249-004

195mm, 7<sup>3</sup>/<sub>4</sub>"

D Ø 5mm	210-249-005
E Ø 6mm	210-249-006
F Ø 7mm	210-249-007

200mm, 8"

G Ø 8mm	210-249-008
---------	-------------

205mm, 8<sup>1</sup>/<sub>8</sub>"

H Ø 10mm	210-249-010
I Ø 12mm	210-249-012
J Ø 14mm	210-249-014

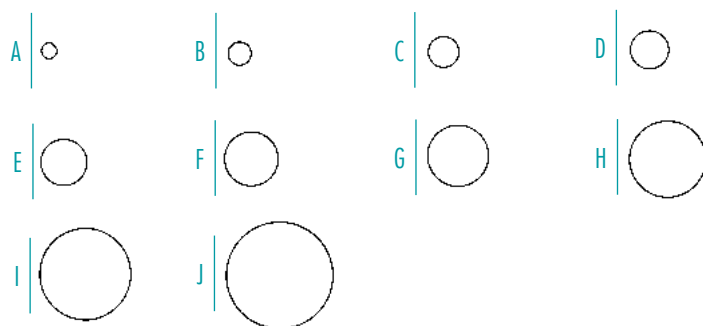

### STILLE

Bone Curette, round, 170mm, 6<sup>2</sup>/<sub>3</sub>"

A Ø 2mm	210-248-002
B Ø 3mm	210-248-003
C Ø 4mm	210-248-004

195mm, 7<sup>3</sup>/<sub>4</sub>"

D Ø 5mm	210-248-005
E Ø 6mm	210-248-006
F Ø 7mm	210-248-007

200mm, 8"

G Ø 8mm	210-248-008
---------	-------------

205mm, 8<sup>1</sup>/<sub>8</sub>"

H Ø 10mm	210-248-010
I Ø 12mm	210-248-012
J Ø 14mm	210-248-014

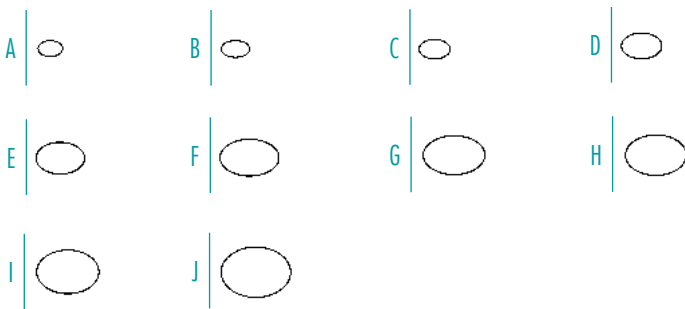
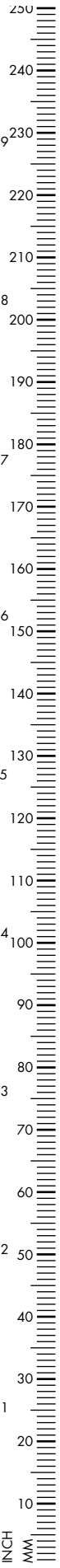

### SPRATT

Bone Curette, oval, 170mm, 6<sup>2</sup>/<sub>3</sub>"

A #0000, 2.5mm	210-308-008
B #000, 3.0mm	210-308-000
C #00, 4.0mm	210-308-001
D #0, 4.5mm	210-308-002
E #1, 5.0mm	210-308-003
F #2, 6.0mm	210-308-004
G #3, 7.0mm	210-308-005
H #4, 8.0mm	210-308-006
I #5, 9.6mm	210-308-007
J #6 11.5mm	210-308-009

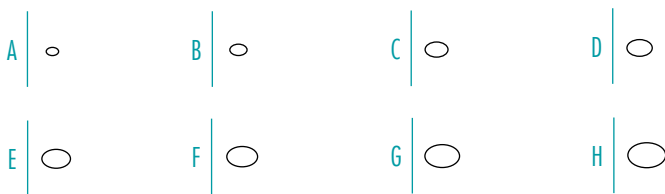

### LEMPERT

Bone Curette, 200mm, 8"

A #000000, 1mm	210-348-600
B #00000, 1.5mm	210-348-500
C #0000, 2.0mm	210-348-400
D #000, 2.2mm	210-348-300
E #00, 2.5mm	210-348-200
F #0, 2.7mm	210-348-100
G #1, 3.0mm	210-348-010
H #2, 3.3mm	210-348-002

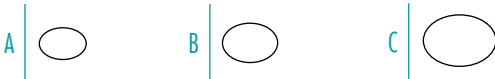

### HALLÉ

Bone Curette, malleable, 210mm, 8<sup>1</sup>/<sub>4</sub>"

A #1, 4.8mm	210-350-200
B #2, 5.8mm	210-350-100
C #3, 6.8mm	210-350-010

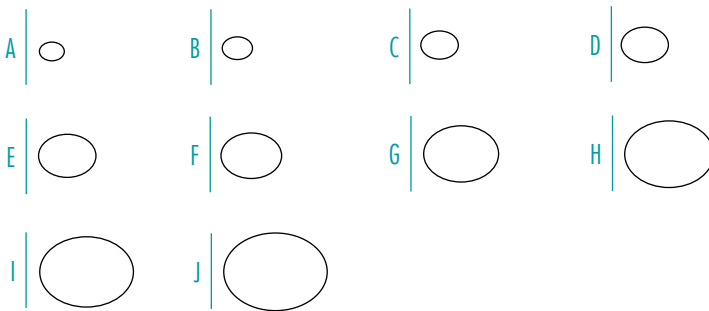

### BRUNS

Bone Curette, synthetic handle, 170mm, 6<sup>2</sup>/<sub>3</sub>"

A #0000, 2.5mm	210-302-100
B #000, 3.0mm	210-302-101
C #00, 3.7mm	210-302-102
D #0, 4.7mm	210-302-103
E #1, 5.7mm	210-302-104
F #2, 6.0mm	210-302-105
G #3, 7.4mm	210-302-106
H #4, 8.8mm	210-302-107
I #5, 9.2mm	210-302-108
J #6, 10.3mm	210-302-109



### DAUBENSPECK

Bone Curette, 200mm, 8"

A Fig. 00, 2.8mm	210-217-200
B Fig.0, 3.6mm	210-217-100
C Fig. 1, 4.4mm	210-217-010
D Fig. 2, 5.2mm	210-217-020

### SPINAL

#### Bone Curette

A straight

B forward angled

C reverse angled

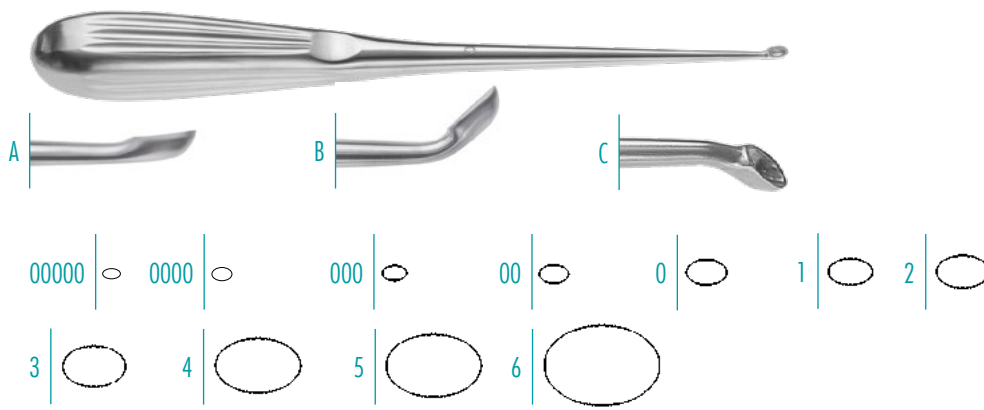

tip shape	size	200mm, 8"	230mm, 9"	300mm, 11 <sup>7</sup> / <sub>8</sub> "
straight	00000	210-299-500	210-326-500	210-330-500
straight	0000	210-299-400	210-326-400	210-330-400
straight	000	210-299-300	210-326-300	210-330-300
straight	00	210-299-200	210-326-200	210-330-200
straight	0	210-299-100	210-326-100	210-330-100
straight	1	210-299-001	210-326-001	210-330-001
straight	2	210-299-002	210-326-002	210-330-002
straight	3	210-299-003	210-326-003	210-330-003
straight	4	210-299-004	210-326-004	210-330-004
straight	5	210-299-005	210-326-005	210-330-005
straight	6	210-299-006	210-326-006	210-330-006
forward angled	00000	210-301-500	210-328-500	210-331-500
forward angled	0000	210-301-400	210-328-400	210-331-400
forward angled	000	210-301-300	210-328-300	210-331-300
forward angled	00	210-301-200	210-328-200	210-331-200
forward angled	0	210-301-100	210-328-100	210-331-100
forward angled	1	210-301-001	210-328-001	210-331-001
forward angled	2	210-301-002	210-328-002	210-331-002
forward angled	3	210-301-003	210-328-003	210-331-003
forward angled	4	210-301-004	210-328-004	210-331-004
forward angled	5	210-301-005	210-328-005	210-331-005
forward angled	6	210-301-006	210-328-006	210-331-006
reverse angled	00000	210-327-500	210-329-500	210-333-500
reverse angled	0000	210-327-400	210-329-400	210-333-400
reverse angled	000	210-327-300	210-329-300	210-333-300
reverse angled	00	210-327-200	210-329-200	210-333-200
reverse angled	0	210-327-100	210-329-100	210-333-100
reverse angled	1	210-327-001	210-329-001	210-333-001
reverse angled	2	210-327-002	210-329-002	210-333-002
reverse angled	3	210-327-003	210-329-003	210-333-003
reverse angled	4	210-327-004	210-329-004	210-333-004
reverse angled	5	210-327-005	210-329-005	210-333-005
reverse angled	6	210-327-006	210-329-006	210-333-006

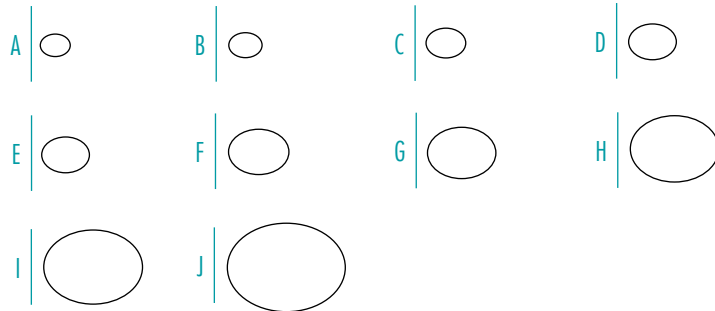

### VOLKMANN BRUNS

Bone Curette, 230mm, 9"  
straight jaw

A #0000	210-314-400
B #000	210-314-300
C #00	210-314-200
D #0	210-314-100
E #1	210-314-001
F #2	210-314-002
G #3	210-314-003
H #4	210-314-004
I #5	210-314-005
J #6	210-314-006

### angled

A #0000	210-315-400
B #000	210-315-300
C #00	210-315-200
D #0	210-315-100
E #1	210-315-001
F #2	210-315-002
G #3	210-315-003
H #4	210-315-004
I #5	210-315-005
J #6	210-315-006

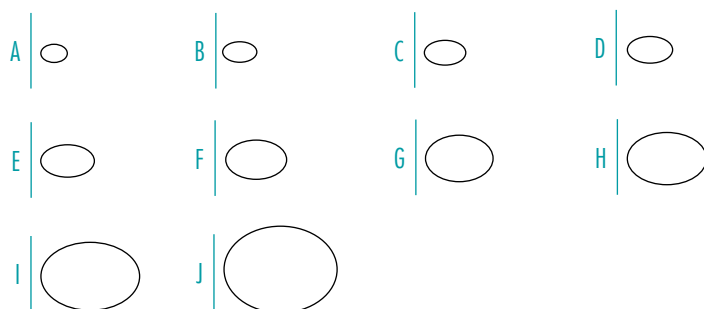

### BRUNS

Bone Curette, 230mm, 9"

A #0000	210-296-400
B #000	210-296-300
C #00	210-296-200
D #0	210-296-100
E #1	210-296-001
F #2	210-296-002
G #3	210-296-003
H #4	210-296-004
I #5	210-296-005
J #6	210-296-006

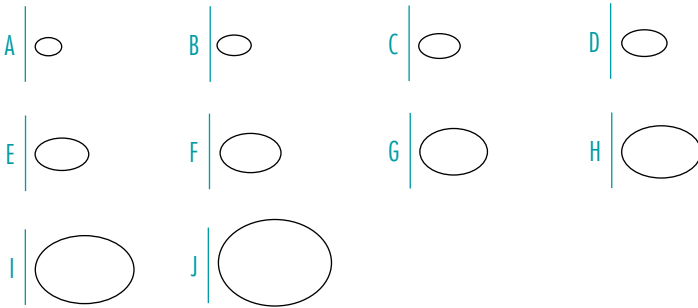
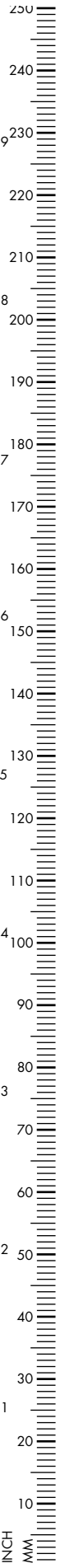

### BRUNS

Bone Curette, synthetic handle,  
270mm, 10<sup>2</sup>/<sub>3</sub>"

A #0000	210-302-000
B #000	210-302-001
C #00	210-302-002
D #0	210-302-003
E #1	210-302-004
F #2	210-302-005
G #3	210-302-006
H #4	210-302-007
I #5	210-302-008
J #6	210-302-009

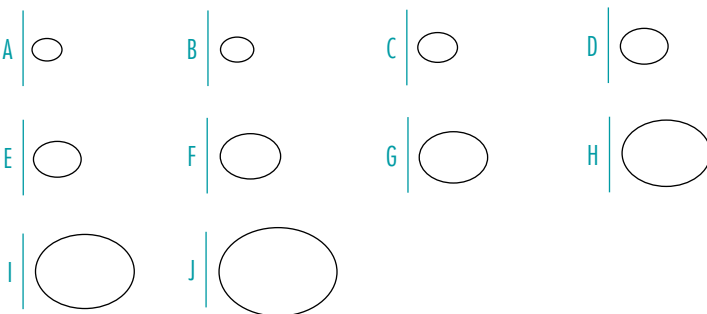

### VOLKMAN SCOVILLE

Bone Curette, 250mm, 9<sup>7</sup>/<sub>8</sub>"  
straight jaw

A #0000	210-215-250
B #000	210-214-250
C #00	210-213-250
D #0	210-212-250
E #1	210-211-250
F #2	210-202-250
G #3	210-203-250
H #4	210-204-250
I #5	210-205-250
J #6	210-206-250

### angled jaw

A #0000	210-315-250
B #000	210-314-250
C #00	210-313-250
D #0	210-312-250
E #1	210-311-250
F #2	210-302-250
G #3	210-303-250
H #4	210-304-250
I #5	210-305-250
J #6	210-306-250





### CASPAR

Bone Curette, synthetic handle, 220mm, 8<sup>2</sup>/<sub>3</sub>" straight

A #000	259-185-912
B #00	259-185-913
C #0	259-185-914

angled

A #000	259-185-921
B #00	259-185-922
C #0	259-185-919

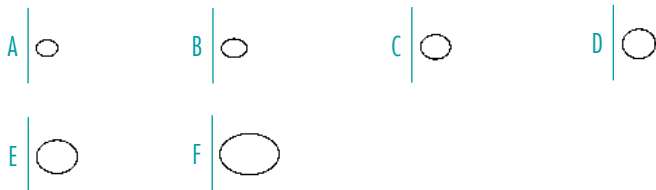

### SIMON

Bone Curette, 230mm, 9<sup>1</sup>/<sub>2</sub>"

A #1	210-298-001
B #2	210-298-002
C #3	210-298-003
D #4	210-298-004
E #5	210-298-005
F #6	210-298-006

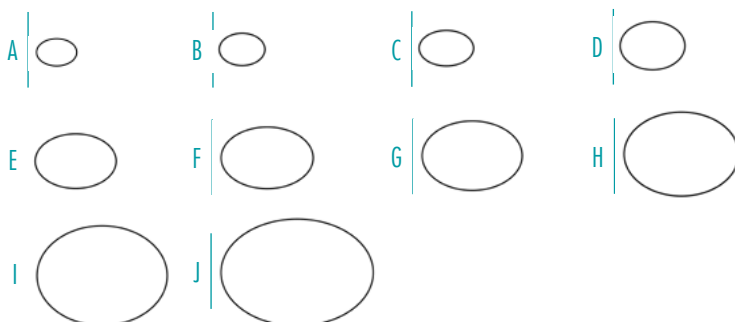

Bone Curette, synthetic handle, 190mm, 7<sup>1</sup>/<sub>2</sub>"

A #0000	210-166-030
B #000	210-166-020
C #00	210-166-010
D #0	210-166-000
E #1	210-166-001
F #2	210-166-002
G #3	210-166-003
H #4	210-166-004
I #5	210-166-005
J #6	210-166-006



### EPSTEIN

Bone Curette, hollow handle, 200mm, 8"

A #000	210-309-003
B #00	210-309-002
C #0	210-309-001



### BUSHE

Bone Curette, upwards cutting, 250mm, 9<sup>7</sup>/<sub>8</sub>"

A 3mm	210-338-250
B 4mm	210-339-250
C 5mm	210-340-250
D 6mm	210-341-250

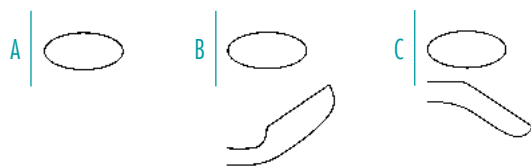

### SCOVILLE

Bone Curette, hollow handle, 250mm, 9<sup>7</sup>/<sub>8</sub>"

A straight	210-316-250
B forward angled	210-318-250
C backward angled	210-317-250

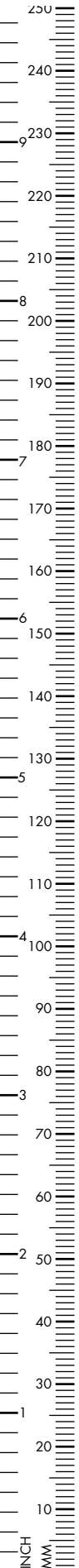

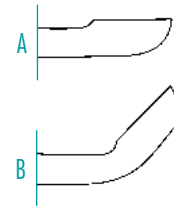

### SPINAL

Bone Curette, oval, 280mm, 11"

**A** straight, massive aluminium handle

#000, 2.5mm	210-320-011
#00, 3.0mm	210-320-012
#0, 3.5mm	210-320-013
#1, 4.0mm	210-320-014
#2, 4.5mm	210-320-015
#3, 5.0mm	210-320-016
#4, 5.5mm	210-320-017
#5, 6.5mm	210-320-018
#6, 8.0mm	210-320-019

**A** straight, hollow, stainless steel handle

#000, 2.5mm	210-320-111
#00, 3.0mm	210-320-112
#0, 3.5mm	210-320-113
#1, 4.0mm	210-320-114
#2, 4.5mm	210-320-115
#3, 5.0mm	210-320-116
#4, 5.5mm	210-320-117
#5, 6.5mm	210-320-118
#6, 8.0mm	210-320-119

**B** curved, massive aluminium handle

#000, 2.5mm	210-321-011
#00, 3.0mm	210-321-012
#0, 3.5mm	210-321-013
#1, 4.0mm	210-321-014
#2, 4.5mm	210-321-015
#3, 5.0mm	210-321-016
#4, 5.5mm	210-321-017
#5, 6.5mm	210-321-018
#6, 8.0mm	210-321-019

**B** curved, hollow, stainless steel handle

#000, 2.5mm	210-321-111
#00, 3.0mm	210-321-112
#0, 3.5mm	210-321-113
#1, 4.0mm	210-321-114
#2, 4.5mm	210-321-115
#3, 5.0mm	210-321-116
#4, 5.5mm	210-321-117
#5, 6.5mm	210-321-118
#6, 8.0mm	210-321-119

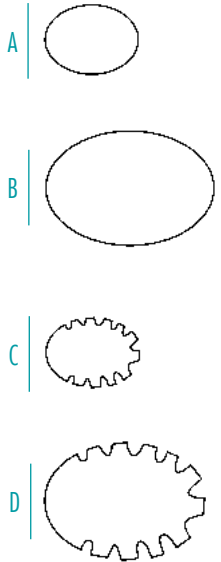
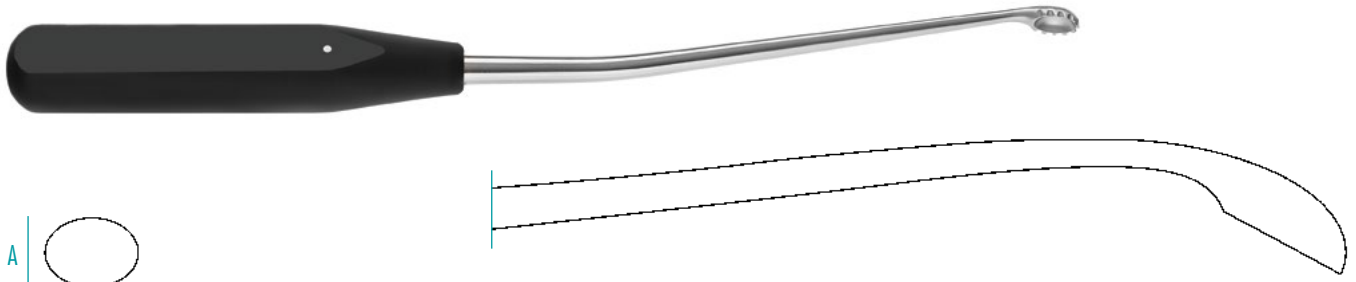
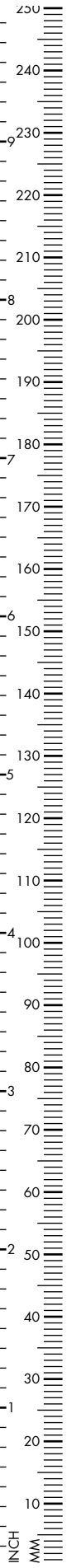

Bone Curette, synthetic handle  
270mm, 10<sup>2</sup>/<sub>3</sub>"

A 9.0mm	210-163-009
B 15.0mm	210-163-015
toothed	
C 9.0mm	210-164-009
D 15.0mm	210-164-015



Bone Curette, synthetic handle,  
toothed, double angled, 9mm

270mm, 10 <sup>2</sup> / <sub>3</sub> "	210-164-109
---	-------------



Bone Curette, synthetic handle, 27mm  
small

240mm, 9 <sup>1</sup> / <sub>2</sub> "	210-184-503
medium	
270mm, 10 <sup>2</sup> / <sub>3</sub> "	210-184-504
large	
320mm, 12 <sup>2</sup> / <sub>3</sub> "	210-184-505

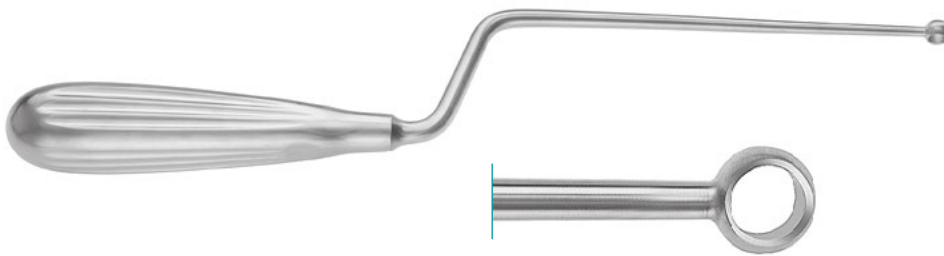

### KRAEMER

Ring Curette, sharpened double-sided,  
250mm, 9<sup>7/8</sup>"

4.0mm	210-321-004
5.0mm	210-321-005
6.0mm	210-321-006

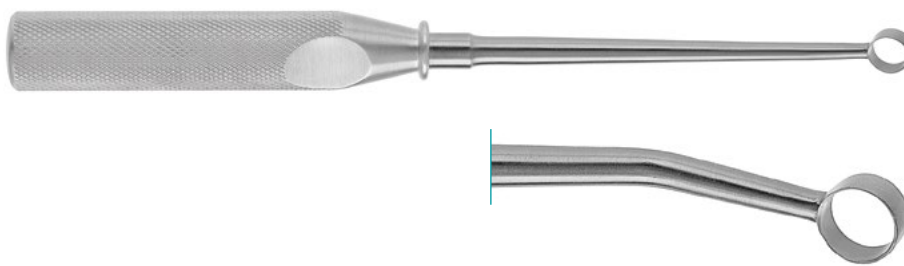

### CONE

Ring Curette, 230mm, 9"  
straight

#3 3mm	210-320-003
#2 6mm	210-320-002
#1 8mm	210-320-001

angled

#3 3mm	210-319-003
#2 6mm	210-319-002
#1 8mm	210-319-001

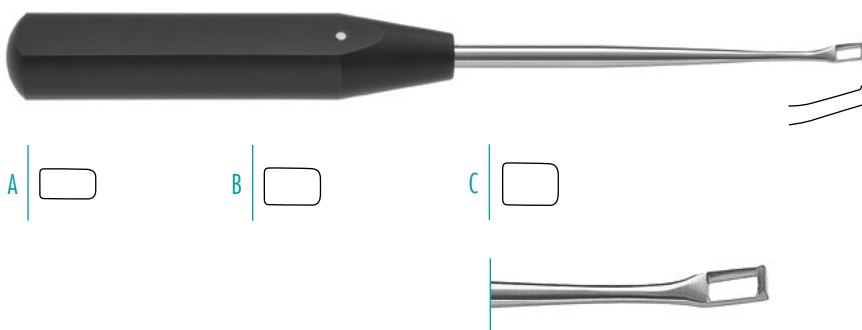

### CASPAR

Bone Scoop, curved, toothed, synthetic handle  
220mm, 8<sup>2/3</sup>"

A 4.0mm	259-185-915
B 5.0mm	259-185-916
C 6.0mm	259-185-910



### SEMMEs

Spinal Curette, 4x7mm, 230mm, 9"

A straight	210-294-001
B slightly curved	210-294-002
C fully curved	210-294-003

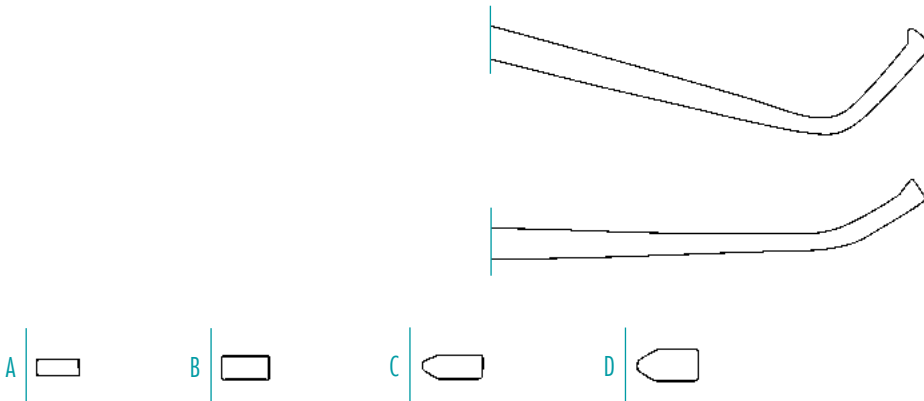

### CASPAR

Curette, serrated, 270mm, 10<sup>2</sup>/<sub>3</sub>"  
knee bent shaft

A 3.0mm	210-340-003
B 4.0mm	210-340-004
250mm, 9 <sup>7</sup> / <sub>8</sub> ", curved shaft	
C 4.0mm	210-342-004
D 5.0mm	210-342-005

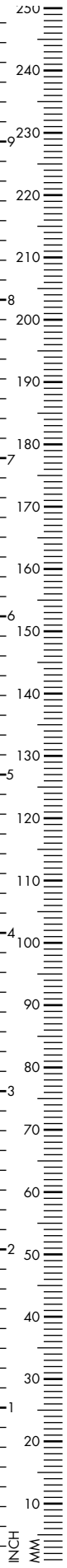

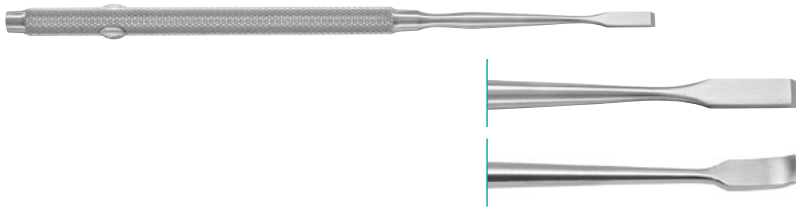

### FREER

Septum Chisel, 4mm, 160mm, 6<sup>1</sup>/<sub>4</sub>"

straight	420-590-004
curved	420-591-004



### THIES

Gouge, straight, 160mm, 6<sup>1</sup>/<sub>4</sub>"

2mm	210-100-162
3mm	210-100-163
4mm	210-100-164

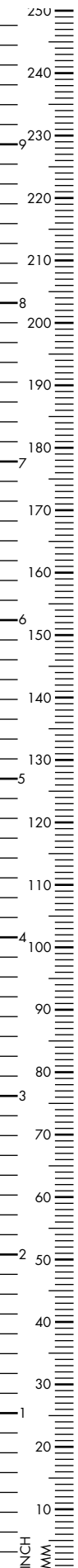

### PARTSCH

Osteotome, 140mm, 5<sup>1</sup>/<sub>2</sub>"

4mm	210-100-004
6mm	210-100-006
8mm	210-100-008
10mm	210-100-010
12mm	210-100-012

### PARTSCH

Chisel, 135mm, 5<sup>1</sup>/<sub>3</sub>"

2mm	210-302-135
3mm	210-303-135
5mm	210-305-135
6mm	210-306-135
7mm	210-307-135
8mm	210-308-135

170mm, 6<sup>2</sup>/<sub>3</sub>"

2mm	210-302-170
3mm	210-303-170
5mm	210-305-170
6mm	210-306-170
7mm	210-307-170
8mm	210-308-170

### PARTSCH

Gouge, 140mm, 5<sup>1</sup>/<sub>2</sub>"

2mm	210-109-002
3mm	210-109-003
4mm	210-109-004
5mm	210-109-005
6mm	210-109-006
7mm	210-109-007
8mm	210-109-008

170mm, 6<sup>2</sup>/<sub>3</sub>"

2mm	210-110-002
3mm	210-110-003
4mm	210-110-004
5mm	210-110-005
6mm	210-110-006
7mm	210-110-007
8mm	210-110-008





**LUCAS**

Chisel, 160mm, 6<sup>1</sup>/<sub>4</sub>"

4mm	210-204-160
-----	-------------



**LUCAS**

Gouge, 160mm, 6<sup>1</sup>/<sub>4</sub>"

3mm	210-103-160
-----	-------------

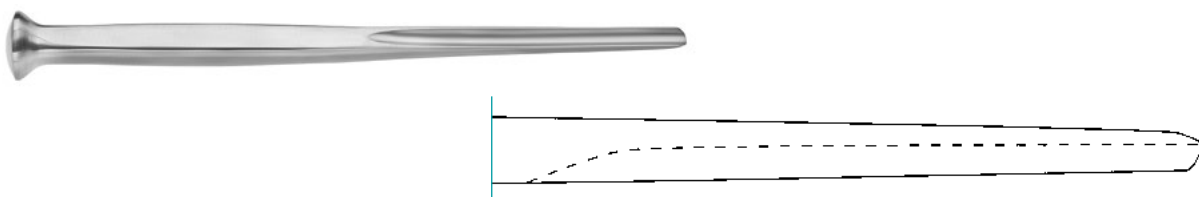

**ALEXANDER**

Gouge, 180mm, 7"

4mm	210-604-180
6mm	210-606-180
8mm	210-608-180
10mm	210-610-180
12mm	210-612-180
14mm	210-614-180

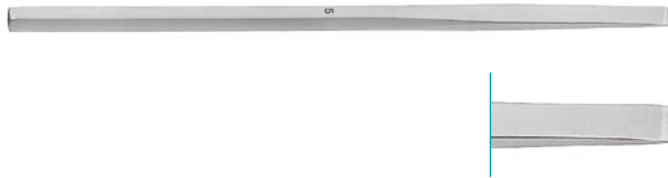
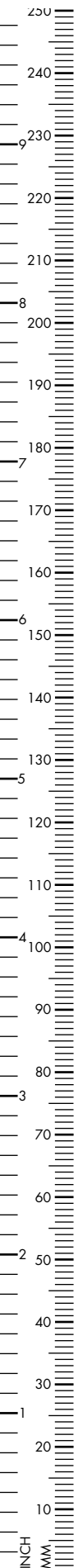

### SHEEHAN

Osteotome, 160mm, 6<sup>1</sup>/<sub>4</sub>"

2mm	420-594-002
3mm	420-594-003
4mm	420-594-004
5mm	420-594-005
6mm	420-594-006
7mm	420-594-007
8mm	420-594-008
10mm	420-594-010
12mm	420-594-012
15mm	420-594-015



### COTTLE

Osteotome with depth marking, 180mm, 7"

4mm	210-487-004
7mm	210-487-007
8mm	210-487-008
10mm	210-487-010
12mm	210-487-012



### COTTLE

Chisel with depth marking, 180mm, 7"

4mm	210-488-004
7mm	210-488-007
9mm	210-488-009
12mm	210-488-012



### COTTLE

Fishtail Osteotome, protecting ends, double guarded, 8mm

180mm, 7" 210-486-008



### HARDT DELIMA

Osteotome, straight, 130mm, 5<sup>1</sup>/<sub>8</sub>"

2mm 210-134-102

4mm 210-134-104

6mm 210-134-106

8mm 210-134-108

10mm 210-134-110

12mm 210-134-112

15mm 210-134-115

170mm, 6<sup>2</sup>/<sub>3</sub>"

2mm 210-134-202

4mm 210-134-204

6mm 210-134-206

8mm 210-134-208

10mm 210-134-210

12mm 210-134-212

15mm 210-134-215



### CARROLL

Osteotome, 145mm, 5<sup>3</sup>/<sub>4</sub>"

3mm 210-226-003

6mm 210-226-006

10mm 210-226-010

13mm 210-226-013

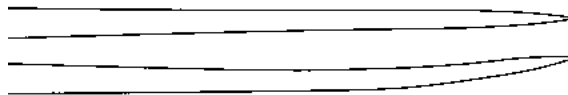
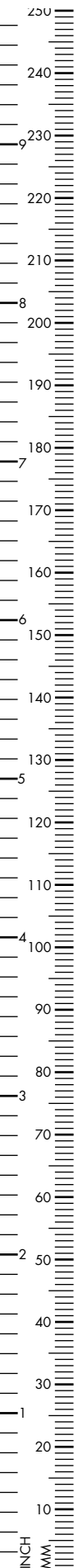

### MINI LAMBOTTE

Osteotome, 125mm, 5"

2mm	210-136-002
3mm	210-136-003
4mm	210-136-004
5mm	210-136-005
6mm	210-136-006
7mm	210-136-007
8mm	210-136-008
9mm	210-136-009
10mm	210-136-010
12mm	210-136-012
14mm	210-136-014
15mm	210-136-015

### MINI LAMBOTTE

Osteotome, curved, 125mm, 5"

2mm	210-137-002
4mm	210-137-005
6mm	210-137-007
8mm	210-137-009
10mm	210-137-011
12mm	210-137-013

### LAMBOTTE

Osteotome, 240mm, 9 1/2"

straight		curved	
4mm	210-132-004	4mm	210-133-004
6mm	210-132-006	6mm	210-133-006
8mm	210-132-008	8mm	210-133-008
10mm	210-132-010	10mm	210-133-010
12mm	210-132-012	12mm	210-133-012
15mm	210-132-015	15mm	210-133-015
20mm	210-132-020	20mm	210-133-020
25mm	210-132-025	25mm	210-133-025
30mm	210-132-030	30mm	210-133-032
38mm	210-132-038	38mm	210-133-038
44mm	210-132-044	44mm	210-133-044
50mm	210-132-050	50mm	210-133-050

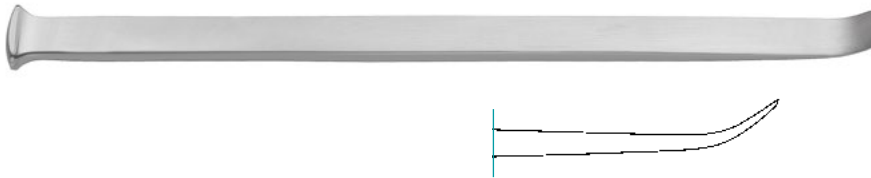

### OBWEGESER

Osteotome, curved, 13mm

235mm, 9<sup>1/4</sup>"

431-656-235

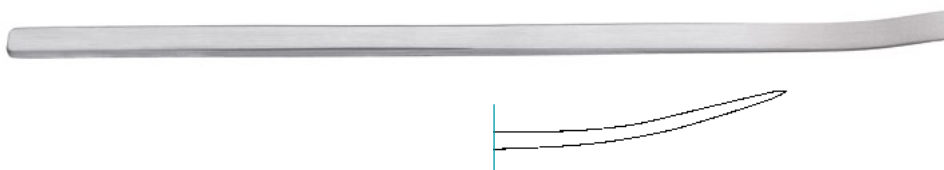

### NIEDERDELLMANN

Osteotome, curved, 250mm, 9<sup>7/8</sup>"

8mm

431-658-250

10mm

431-660-250

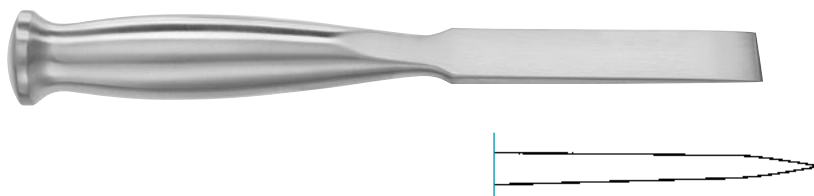

### SMITH PETERSEN

Osteotome, straight, 200mm, 8"

6mm

210-106-200

9mm

210-109-200

13mm

210-113-200

16mm

210-116-200

19mm

210-119-200

25mm

210-125-200

32mm

210-132-200

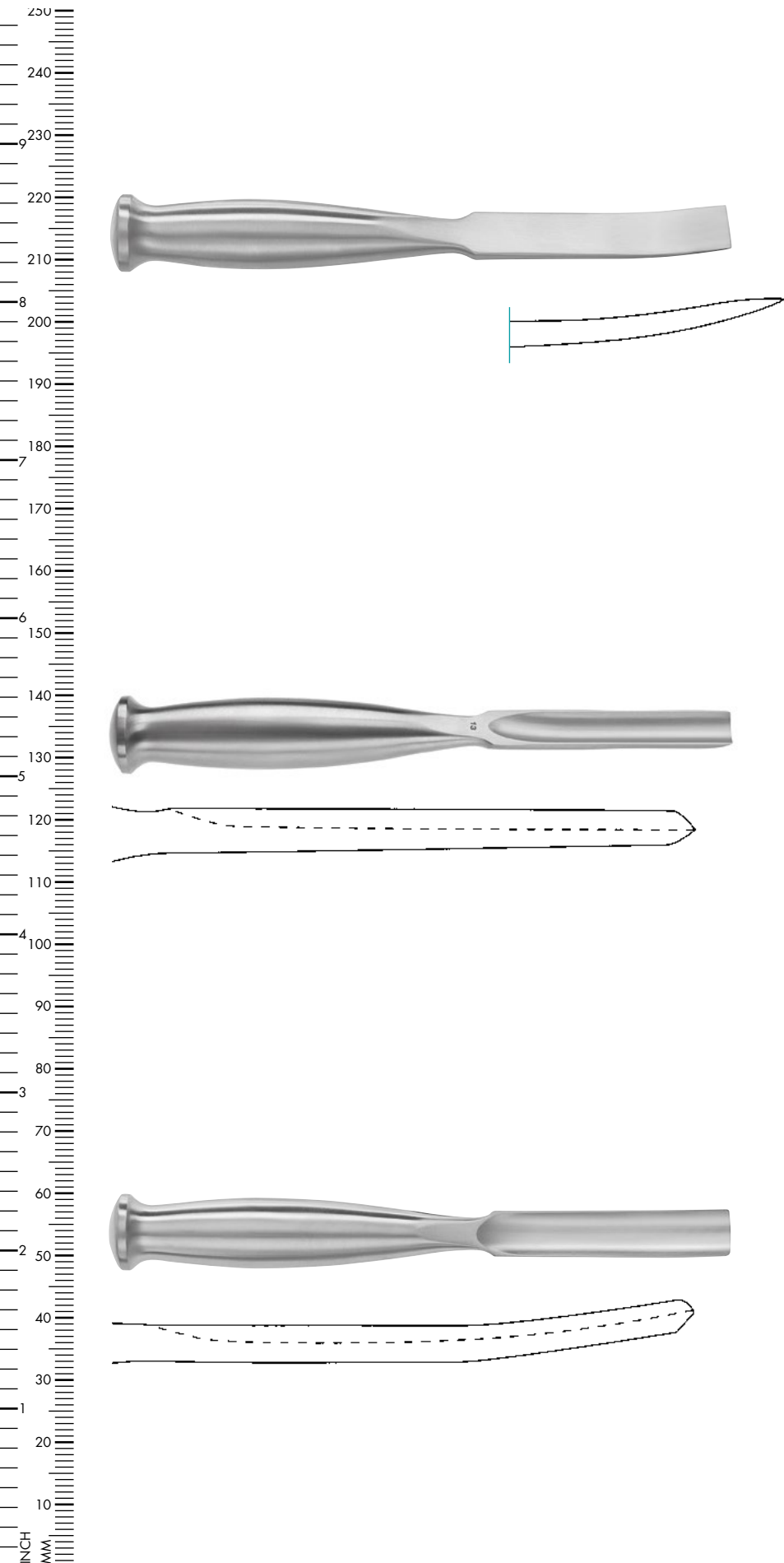

### SMITH PETERSEN

Osteotome, curved, 200mm, 8"

6mm	210-206-200
9mm	210-209-200
13mm	210-213-200
16mm	210-216-200
19mm	210-219-200
25mm	210-225-200
32mm	210-232-200

### SMITH PETERSEN

Gouge, straight, 200mm, 8"

6mm	210-305-200
9mm	210-309-200
13mm	210-313-200
16mm	210-316-200
19mm	210-319-200
25mm	210-325-200
32mm	210-332-200

### SMITH PETERSEN

Gouge, curved, 200mm, 8"

6mm	210-406-200
9mm	210-409-200
13mm	210-413-200
16mm	210-416-200
19mm	210-419-200
25mm	210-425-200
32mm	210-432-200



### STILLE

Chisel, 200mm, 8"

10mm	210-810-200
12mm	210-812-200
15mm	210-815-200
20mm	210-820-200
25mm	210-825-200

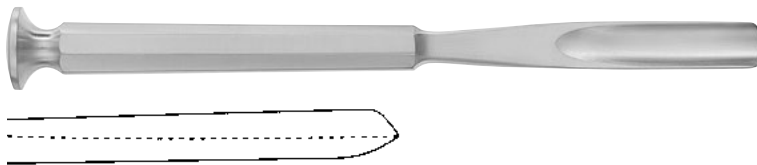

### STILLE

Gouge, 200mm, 8"

8mm	210-508-200
10mm	210-510-200
12mm	210-512-200
15mm	210-515-200
20mm	210-520-200
25mm	210-525-200

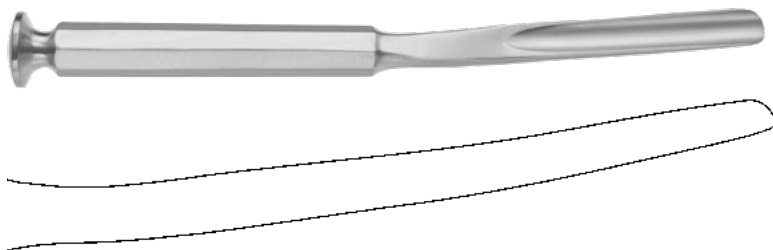

### WALTER

Gouge, for rip graft, 200mm, 8"

10mm	210-701-010
15mm	210-701-015

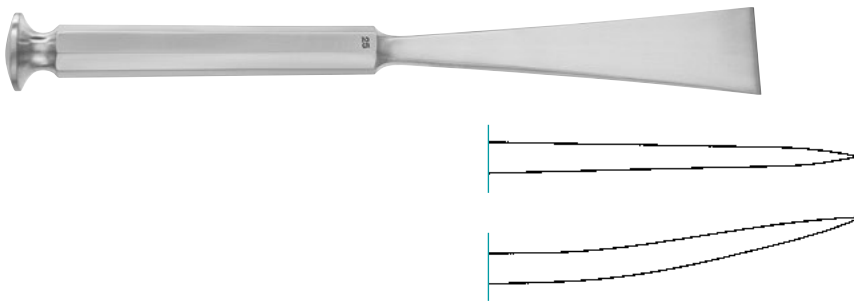
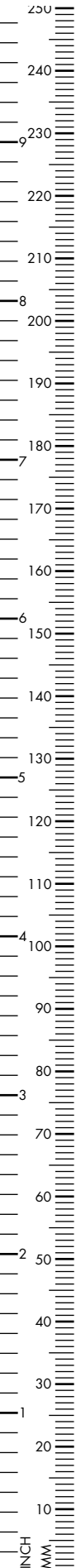

### STILLE

Osteotome, 200mm, 8"  
straight

8mm	210-708-200
10mm	210-710-200
12mm	210-712-200
15mm	210-715-200
20mm	210-720-200
25mm	210-725-200

### curved

8mm	210-908-200
10mm	210-910-200
12mm	210-912-200
15mm	210-915-200
20mm	210-920-200
25mm	210-925-200



### STILLE

Osteotome, fine model, 200mm, 8"

10mm	210-410-200
12mm	210-412-200
15mm	210-415-200
20mm	210-420-200

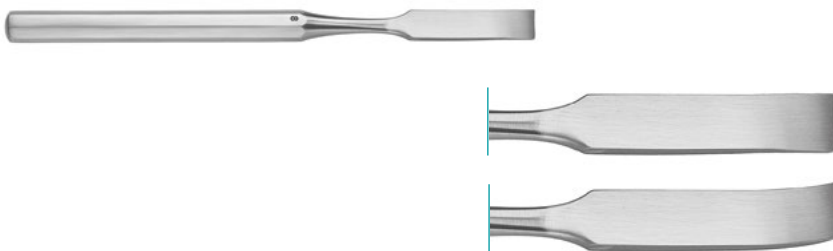

### HOKE

Osteotome, 140mm, 5 1/2"  
straight

3mm	210-219-003
5mm	210-219-005
6mm	210-219-006
8mm	210-219-008
9mm	210-219-009
12mm	210-219-012
16mm	210-219-016

### curved

3mm	210-218-103
5mm	210-218-105
6mm	210-218-106
8mm	210-218-108
9mm	210-218-110
12mm	210-218-113
16mm	210-218-116





### HIBBS

Osteotome, 240mm, 9<sup>1/2</sup>"  
straight

6mm	210-212-006
9mm	210-212-010
13mm	210-212-013
16mm	210-212-016
19mm	210-212-019
22mm	210-212-022
25mm	210-212-025
28mm	210-212-028
32mm	210-212-032
38mm	210-212-038



### curved

6mm	210-213-006
9mm	210-213-010
13mm	210-213-013
16mm	210-213-016
19mm	210-213-019
22mm	210-213-022
25mm	210-213-025
28mm	210-213-028
32mm	210-213-032
38mm	210-213-038



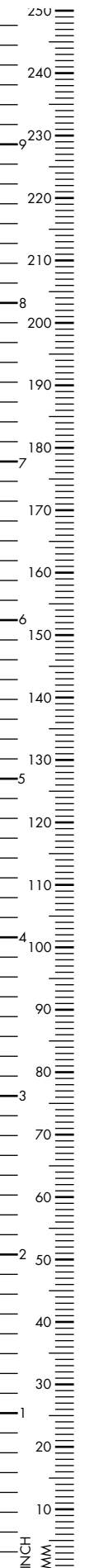

### HIBBS

Chisel, 240mm, 9 1/2"  
straight

6mm	210-206-006
9mm	210-206-010
13mm	210-206-013
16mm	210-206-016
19mm	210-206-019
22mm	210-206-022
25mm	210-206-025
28mm	210-206-028
32mm	210-206-032
38mm	210-206-038

### curved

6mm	210-207-006
9mm	210-207-010
13mm	210-207-013
16mm	210-207-016
19mm	210-207-019
22mm	210-207-022
25mm	210-207-025
28mm	210-207-028
32mm	210-207-032
38mm	210-207-038

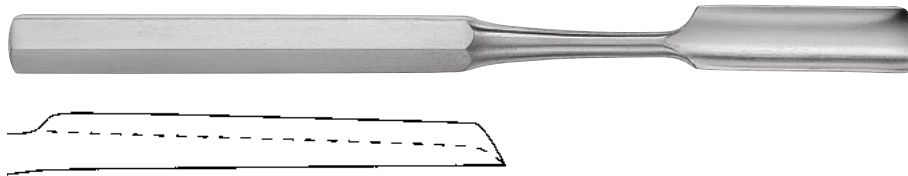

### HIBBS

Gouge, 240mm, 9<sup>1</sup>/<sub>2</sub>"  
straight

6mm	210-144-060
9mm	210-144-090
13mm	210-144-130
16mm	210-144-150
19mm	210-144-190
22mm	210-144-220
25mm	210-144-250
28mm	210-144-280
32mm	210-144-320
38mm	210-144-380

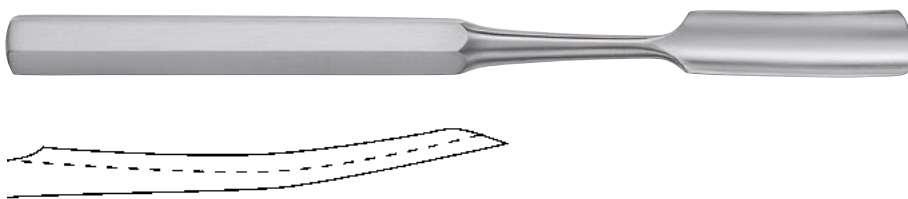

### HIBBS

Gouge, 240mm, 9<sup>1</sup>/<sub>2</sub>"  
curved

6mm	210-145-060
9mm	210-145-090
13mm	210-145-130
16mm	210-145-150
19mm	210-145-190
22mm	210-145-220
25mm	210-145-250
28mm	210-145-280
32mm	210-145-320
38mm	210-145-380

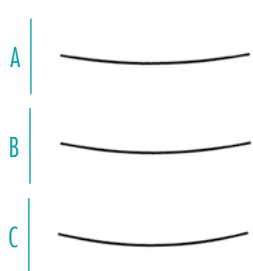
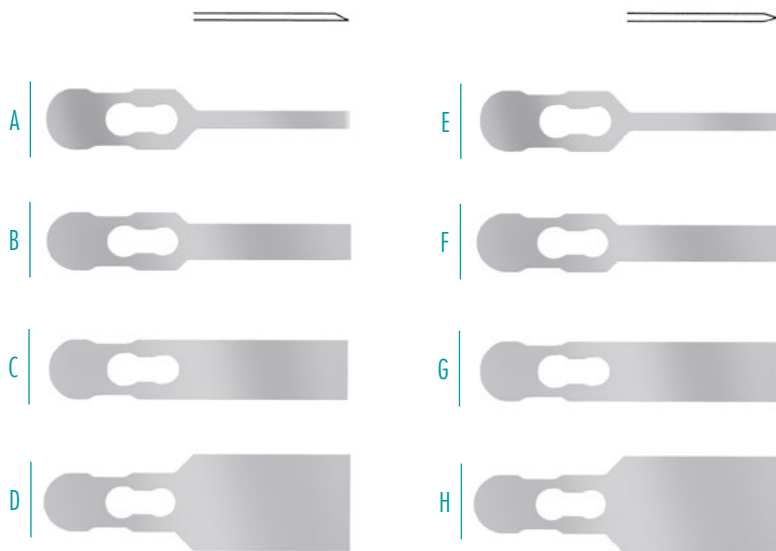
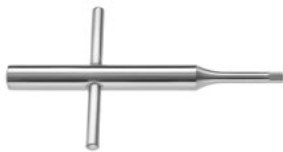
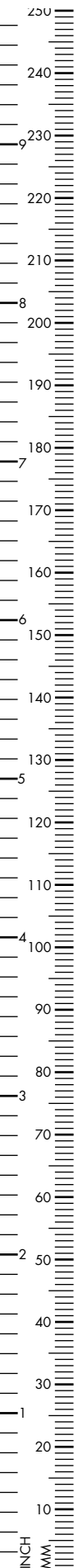

Handle for interchangeable blades,  
synthetic handle

210-130-000

Spare Screw (not illustrated)

210-130-001

Wrench

90mm, 3 1/2"

210-130-500

Chisel Blade, 85mm, 3 1/4"

A 5mm 210-130-005

B 10mm 210-130-010

C 16mm 210-130-016

D 25mm 210-130-025

Osteotome Blade, 85mm, 3 1/4"

E 5mm 210-130-105

F 10mm 210-130-110

G 16mm 210-130-116

H 25mm 210-130-125

Gouge Blade, 85mm, 3 1/4"

A r = 50mm 210-130-050

B r = 60mm 210-130-060

C r = 70mm 210-130-070

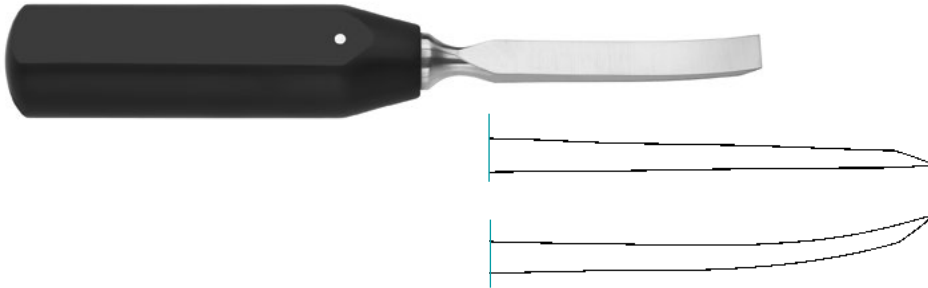

Osteotome, synthetic handle, 200mm, 8"  
straight

10mm	210-435-010
15mm	210-435-015
20mm	210-435-020

curved	
10mm	210-437-010
15mm	210-437-015
20mm	210-437-020



### LEXER MINI

Osteotome, synthetic handle, 180mm, 7"

4mm	210-137-004
6mm	210-137-006
8mm	210-137-008
10mm	210-137-010
12mm	210-137-012



### LEXER MINI

Gouge, synthetic handle, 180mm, 7"

2mm	210-138-002
4mm	210-138-004
6mm	210-138-006
8mm	210-138-008
10mm	210-138-010
12mm	210-138-012
15mm	210-138-015

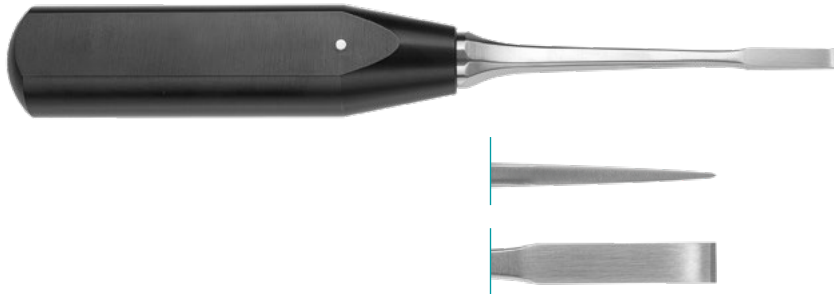
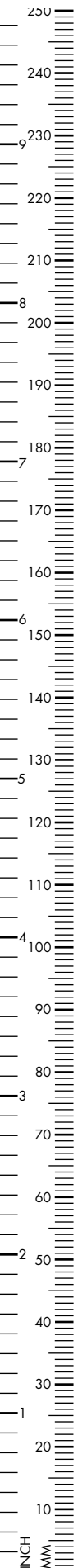

### LEXER

Osteotome, synthetic handle, 220mm, 8<sup>2</sup>/<sub>3</sub>"

5mm	210-134-005
7mm	210-134-007
10mm	210-134-010
12mm	210-134-012
15mm	210-134-015
20mm	210-134-020
25mm	210-134-025
30mm	210-134-030

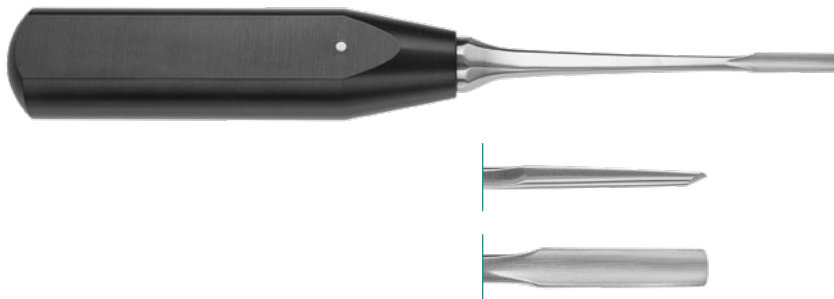

### LEXER

Gouge, synthetic handle, 220mm, 8<sup>2</sup>/<sub>3</sub>"

5mm	210-135-005
7mm	210-135-007
10mm	210-135-010
12mm	210-135-012
15mm	210-135-015
20mm	210-135-020
25mm	210-135-025
30mm	210-135-030

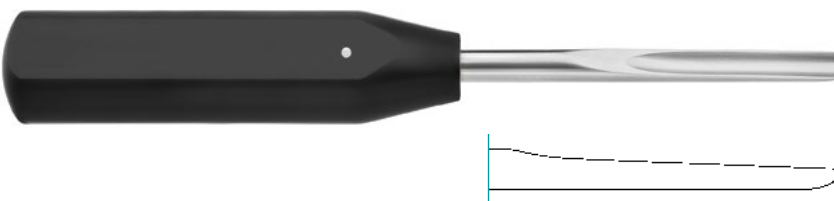

Gouge, for removing broken screws,  
synthetic handle,  
220mm, 8<sup>2</sup>/<sub>3</sub>"

10mm	210-153-010
------	-------------



**ZIELKE**

Gouge, synthetic handle, 230mm, 9"

6mm 210-500-006

9mm 210-500-009

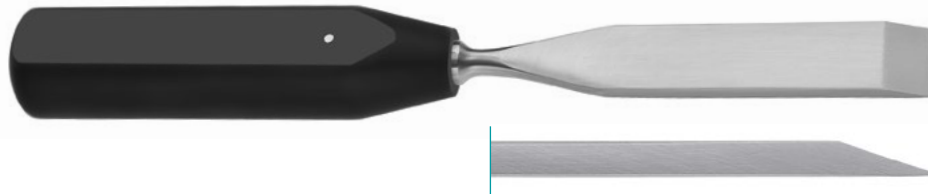

Chisel, synthetic handle, 20mm, straight

245mm, 9<sup>2</sup>/<sub>3</sub>" 210-146-240



Chisel, synthetic handle, 16mm, curved

265mm, 10<sup>1</sup>/<sub>2</sub>" 210-149-260



**LEXER**

Osteotome, synthetic handle, angled,  
275mm, 10<sup>7/8</sup>"

10mm	210-251-010
15mm	210-251-015



**LEXER**

Gouge, synthetic handle, angled,  
275mm, 10<sup>7/8</sup>"

10mm	210-252-010
15mm	210-252-015



**LEXER**

Spongiosa Gouge, synthetic handle,  
250mm, 9<sup>7/8</sup>", straight

5mm	210-240-005
10mm	210-240-010
15mm	210-240-015

curved

5mm	210-240-105
10mm	210-240-110
15mm	210-240-115

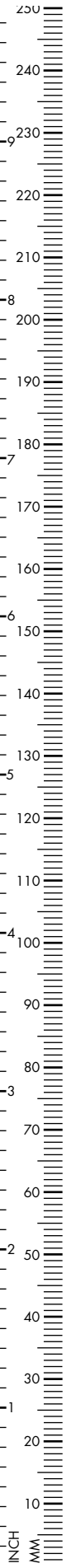
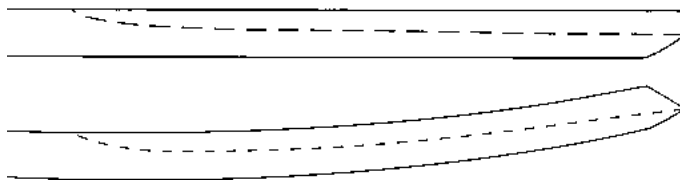





### CAPENER

Lamina Gouge, synthetic handle,  
240mm, 9<sup>1</sup>/<sub>2</sub>"

6mm	210-235-006
8mm	210-235-008
10mm	210-235-010
11mm	210-235-011
13mm	210-235-013
16mm	210-235-016
19mm	210-235-019

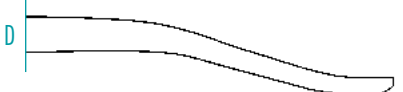
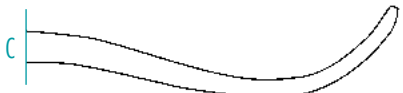
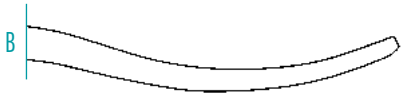
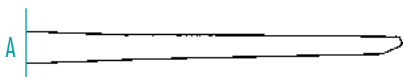

### COBB

Gouge, synthetic handle, 4mm  
280mm, 11"

A straight (8mm)	210-405-195
B slightly curved	210-405-295
C strongly curved	210-405-395
D backwards curved	210-405-495

Hexagonal Handle, 4mm  
240mm, 9<sup>1</sup>/<sub>2</sub>"

A straight	210-405-100
B slightly curved	210-405-101
C strongly curved	210-405-102
D backwards curved	210-405-103

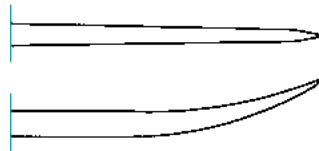

### COBB

Osteotome, 280mm, 11"  
straight

6mm	210-403-006
9mm	210-403-009
13mm	210-403-013
16mm	210-403-016
19mm	210-403-019
25mm	210-403-025
32mm	210-403-032

### curved

6mm	210-406-006
9mm	210-406-009
13mm	210-406-013
16mm	210-406-016
19mm	210-406-019
25mm	210-406-025
32mm	210-406-032

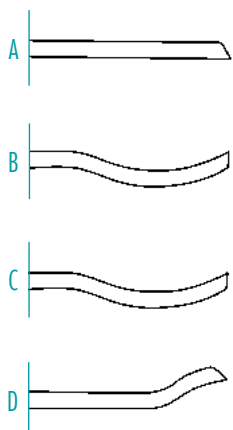

### COBB

Gouge, 7.5mm, 280mm, 11"

A straight	210-405-300
B slightly curved	210-405-301
C strongly curved	210-405-302
D backwards curved	210-405-303

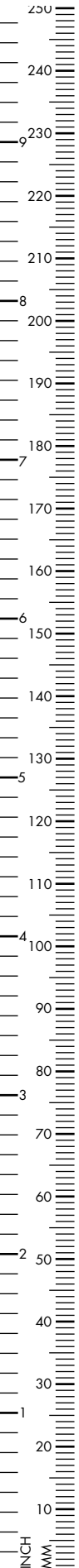

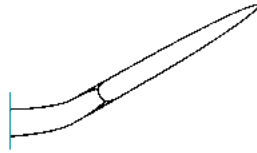
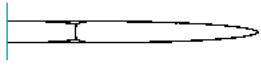

### DAHMEN

Osteotome, synthetic handle, 300mm, 11<sup>7/8</sup>"  
straight

4mm	210-111-004
5mm	210-111-005
6mm	210-111-006
8mm	210-111-008
10mm	210-111-010
12mm	210-111-012
15mm	210-111-015
20mm	210-111-020
22mm	210-111-022
25mm	210-111-025

angled

4mm	210-118-004
5mm	210-118-005
6mm	210-118-006
8mm	210-118-008
10mm	210-118-010
12mm	210-118-012
15mm	210-118-015
20mm	210-118-020
22mm	210-118-022
25mm	210-118-025

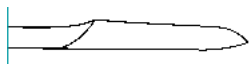

### DAHMEN

Gouge, synthetic handle, 300mm, 11<sup>7/8</sup>"  
straight

4mm	210-112-004
5mm	210-112-005
6mm	210-112-006
8mm	210-112-008
10mm	210-112-010
12mm	210-112-012
15mm	210-112-015
20mm	210-112-020
22mm	210-112-022
25mm	210-112-025

angled backward

4mm	210-119-004
5mm	210-119-005
6mm	210-119-006
8mm	210-119-008
10mm	210-119-010
12mm	210-119-012
15mm	210-119-015
20mm	210-119-020
22mm	210-119-022
25mm	210-119-025

angled forward

4mm	210-113-004
5mm	210-113-005
6mm	210-113-006
8mm	210-113-008
10mm	210-113-010
12mm	210-113-012
15mm	210-113-015
20mm	210-113-020
22mm	210-113-022
25mm	210-113-025

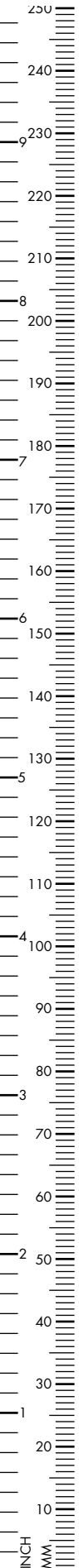

**LEXER**

Gouge, synthetic handle, 5mm

280mm, 11" 210-135-050

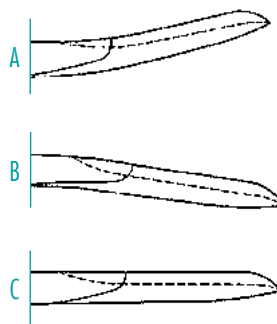

**WAGNER**

Gouge, synthetic handle, 340mm, 13<sup>1/2</sup>"

**A** angled forward

9mm 210-409-341

15mm 210-415-341

**B** angled backward

9mm 210-409-342

15mm 210-415-342

**C** straight

9mm 210-409-340

15mm 210-415-340



Osteophyt Chisel, synthetic handle,  
curved, 16mm

200mm, 8"	210-437-160
-----------	-------------



### LEXER

Chisel, synthetic handle, 16mm  
250mm, 9<sup>7</sup>/<sub>8</sub>"

straight	210-148-250
----------	-------------

curved	210-149-250
--------	-------------

320mm, 12<sup>1</sup>/<sub>2</sub>"

straight	210-148-320
----------	-------------

curved	210-149-320
--------	-------------

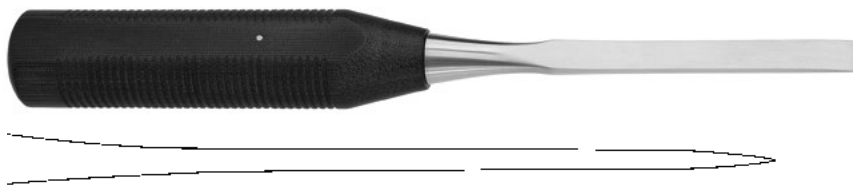

### CAPENER

Osteotome, synthetic handle, 12.7mm  
255mm, 10", straight

		curved	
6mm	210-230-006	6mm	210-231-006
10mm	210-230-010	10mm	210-231-010
12mm	210-230-012	12mm	210-231-012
15mm	210-230-015	15mm	210-231-015
20mm	210-230-020	20mm	210-231-020
25mm	210-230-025	25mm	210-231-025
30mm	210-230-030	30mm	210-231-030



Swan Neck Gouge, 25mm

A 285mm, 11<sup>1</sup>/<sub>4</sub>" 210-410-280

16mm

B 270mm, 10<sup>2</sup>/<sub>3</sub>" 210-410-260

B 320mm, 12<sup>1</sup>/<sub>2</sub>" 210-410-320



Gouge for cement removal,  
synthetic handle, 8mm

320mm, 12<sup>1</sup>/<sub>2</sub>" 210-154-320

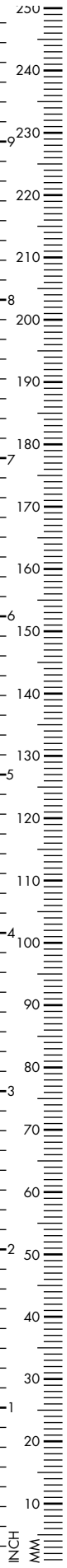



**LEXER**

Chisel, synthetic handle, 25mm

315mm, 12<sup>1</sup>/<sub>2</sub>"

210-251-025



**LEXER**

Chisel, synthetic handle, 8mm

280mm, 11"

210-251-280

330mm, 13"

210-251-330



Chisel for cement removal, synthetic handle,  
5mm, 45° angled upwards

310mm, 12<sup>1</sup>/<sub>4</sub>"

210-153-310

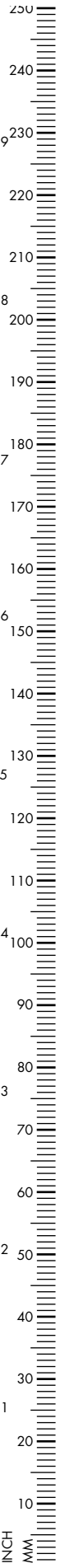

Gouge for cement removal, synthetic handle, 9mm, 340mm, 13<sup>1/3</sup>"

A 210-159-009

B 210-156-009



Gouge, bayonet-shaped, synthetic handle, 8mm

320mm, 12<sup>3/4</sup>" 210-154-300



Chisel, synthetic handle, 280mm, 11"

A For cement extraction, 9mm 210-157-009

B For cement splitting, 8.5mm 210-515-280





Mallet, lead filled head, Ø 20mm,  
80g

---

165mm, 6<sup>1</sup>/<sub>2</sub>" 210-220-080

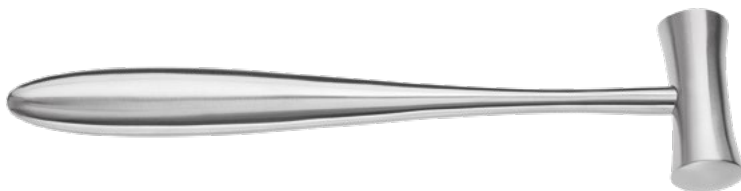

**LUCAE**  
Mallet, Ø 19mm  
80g

---

190mm, 7<sup>1</sup>/<sub>2</sub>" 210-230-190



**LUCAE**  
Mallet, Ø 25mm  
140g

---

190mm, 7<sup>1</sup>/<sub>2</sub>" 210-231-190



**PARTSCH**

Mallet, Ø 22mm  
120g

180mm, 7"

210-225-180



**DOYEN**

Mallet, Ø 25mm  
120g

210mm, 8<sup>1</sup>/<sub>4</sub>"

210-250-210



**BERGMANN**

Mallet, Ø 45mm  
300g

240mm, 9<sup>1</sup>/<sub>2</sub>"

210-300-240

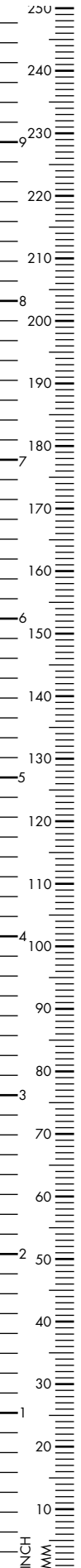



**CLOWARD**

Mallet, lead filled, Ø 19mm

215g

190mm, 7<sup>1</sup>/<sub>2</sub>"

210-215-190



**COLLIN (LUCAE)**

Mallet, Ø 30mm

220g

200mm, 8"

210-220-200



Mallet, 2 interchangeable plastic discs,

Ø 25mm

140g

185mm, 7<sup>1</sup>/<sub>4</sub>"

210-264-140

Spare Discs, pair

210-265-000



Mallet, anodized aluminium handle and head,  
 Ø 32mm  
 140g

225mm, 8<sup>7/8</sup>" 210-264-220

Spare Discs, pair 210-264-221



### WAGNER

Mallet,  
 complete with plastic discs 210-235-132,  
 Ø 35mm  
 130g

235mm, 9<sup>1/4</sup>" 210-235-130

Plastic Discs, pair 210-235-132

Metal Discs, pair,  
 215g 210-235-131

Wrench 210-235-133

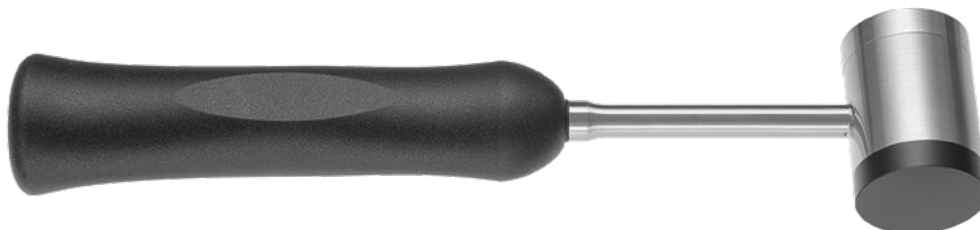

Mallet with plastic/ metal disks, black  
 308g

210-265-260

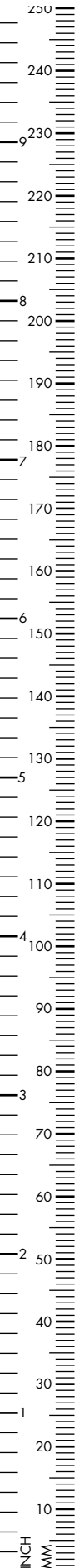



**HAJEK**

Mallet, Ø 27mm

140g

220mm, 8<sup>2/3</sup>"

210-244-220



**DOYEN**

Mallet, Ø 30mm

180g

210mm, 8<sup>1/4</sup>"

210-300-210



Mallet, exchangeable disc,  
1 teflon insert / 1 metal insert

Ø 25mm

205g

190mm, 7<sup>1/2</sup>"

210-261-191

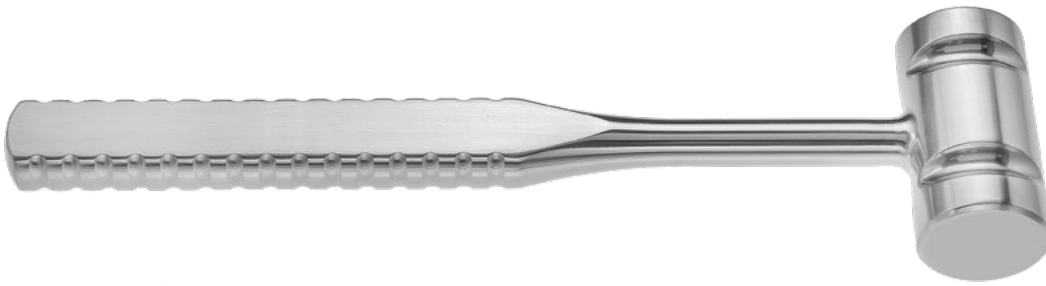

Mallet, handle with recessed grip,  
 Ø 35mm, 265mm, 10<sup>1</sup>/<sub>2</sub>"

450g	210-265-450
900g	210-265-900



**USA MODEL**

Mallet, Ø 35mm  
 485g

180mm, 7"	210-300-180
-----------	-------------



**USA MODEL**

Mallet, Ø 38mm  
 900g

190mm, 7 <sup>1</sup> / <sub>2</sub> "	210-300-190
--	-------------

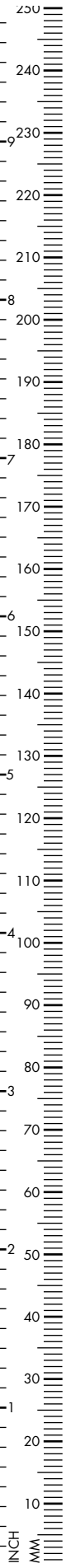



**CLOWARD**

Mallet, Ø 25mm  
220g

---

230mm, 9" 210-220-230



**BERGMANN (HIBBS)**

Mallet, Ø 40mm  
260g

---

230mm, 9" 210-500-230



**MEAD**

Mallet, with 2 interchangeable plastic discs,  
Ø 27mm  
180g

---

190mm, 7 1/2" 210-262-170

Spare Discs, pair 210-263-000



**WILLIGER**

Mallet, Ø 26mm  
300g

---

240mm, 9 1/2" 210-240-300



Mallet, lead filled head, reperussion-free,  
synthetic handle  
Ø 30mm  
290g

265mm, 10 <sup>1</sup> / <sub>2</sub> "	210-290-260
Spare Discs, pair	210-290-000



Mallet, Ø 30mm / 42mm, synthetic handle,  
420g

260mm, 10 <sup>1</sup> / <sub>4</sub> "	210-242-240
---	-------------



Mallet with full metal head, black  
335g

210-265-280
-------------

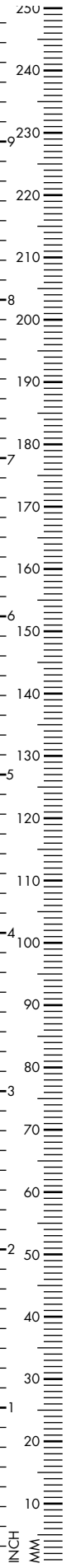





Mallet, Ø 37mm, ferrozell handle and discs,  
240g  
250mm, 9<sup>7</sup>/<sub>8</sub>" 210-240-250  
Spare Discs, pair 210-240-000



Mallet, Ø 35mm, ferrozell  
240mm, 9<sup>1</sup>/<sub>2</sub>" 210-260-150  
Ø 42mm  
260mm, 10<sup>1</sup>/<sub>4</sub>" 210-260-240  
Ø 50mm  
260mm, 10<sup>1</sup>/<sub>4</sub>" 210-260-330



Mallet, synthetic handle,  
Ø 30mm, 350g  
250mm, 9<sup>7</sup>/<sub>8</sub>" 210-260-350  
Ø 35mm, 500g  
250mm, 9<sup>7</sup>/<sub>8</sub>" 210-260-500  
Ø 40mm, 700g  
250mm, 9<sup>7</sup>/<sub>8</sub>" 210-260-700



**GERZOG**

Mallet, lead filled head, Ø 30mm  
300g

190mm, 7<sup>1/2</sup>"

210-180-400



**BERGMANN**

Mallet, Ø 30mm  
300g

230mm, 9"

210-218-230



**WILLIGER**

Mallet, Ø 28mm  
300g

240mm, 9<sup>1/2</sup>"

210-240-340

Ø 30mm, 400g

240mm, 9<sup>1/2</sup>"

210-240-400

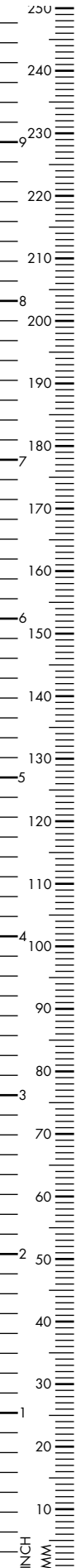



Mallet, Ø 35mm  
450g

280mm, 11" 210-298-280



**BERGMANN**  
Mallet, Ø 30mm  
450g

230mm, 9" 210-329-230



Mallet, synthetic handle, Ø 35mm  
450g

265mm, 10½" 210-240-450

Ø 50mm, 900g

265mm, 10½" 210-240-451



Mallet, Ø 40mm  
520g

185mm, 7<sup>1/4</sup>" 210-240-520



### OMBREDANNE

Mallet, Ø 40mm  
520g

265mm, 10<sup>1/2</sup>" 210-271-240



### KIRK

Mallet, Ø 40mm  
690g

195mm, 7<sup>3/4</sup>" 210-225-185



### HEATH

Mallet, copper filled head, Ø 40mm  
700g

---

185mm, 7<sup>1</sup>/<sub>4</sub>" 210-270-185



### OMBREDANNE

Mallet, Ø 40mm  
710g

---

240mm, 9<sup>1</sup>/<sub>2</sub>" 210-270-240

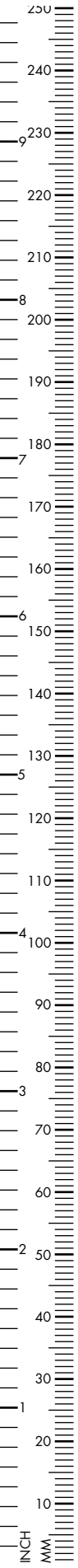

### BRUENINGS

Bone Tamper,  
160mm, 6<sup>1/4</sup>"

A	Ø 3mm	210-115-003
B	Ø 5mm	210-115-005
C	Ø 7mm	210-115-007
D	Ø 9mm	210-115-009

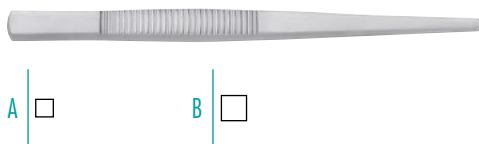

### PASSOW

Bone Tamper,  
120mm, 4<sup>3/4</sup>"

A	Ø 2.5mm	210-325-120
B	Ø 3.5mm	210-335-120

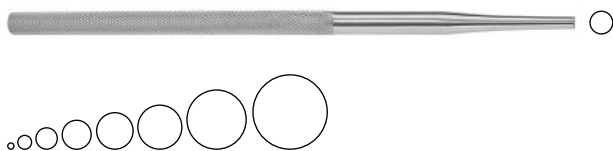

Bone Tamper, round handle, smooth  
150mm, 6"

1mm	210-275-151
2mm	210-275-152
3mm	210-275-153
4mm	210-275-154
5mm	210-275-155
6mm	210-275-156
8mm	210-275-158
10mm	210-275-160

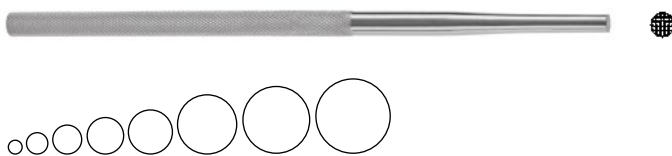

Bone Tamper, smooth round handle, serrated  
155mm, 6<sup>1/8</sup>"

2mm	210-090-002
3mm	210-090-003
4mm	210-090-004
5mm	210-090-005
6mm	210-090-006
8mm	210-090-008
9mm	210-090-009
10mm	210-090-010

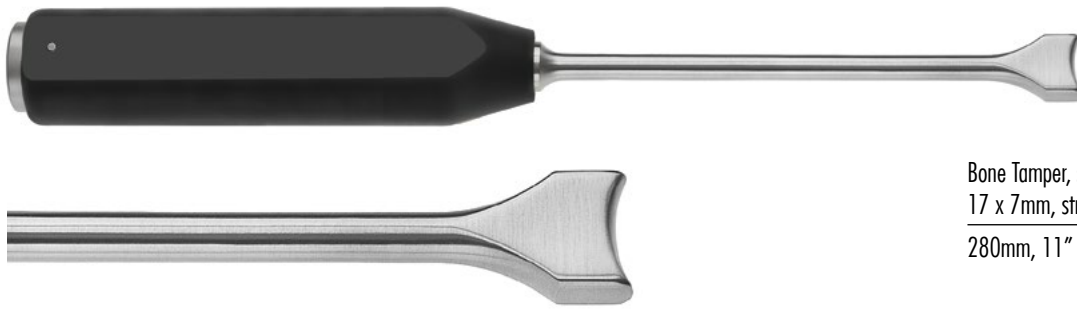

Bone Tamper, synthetic handle,  
17 x 7mm, straight

280mm, 11" 210-090-020

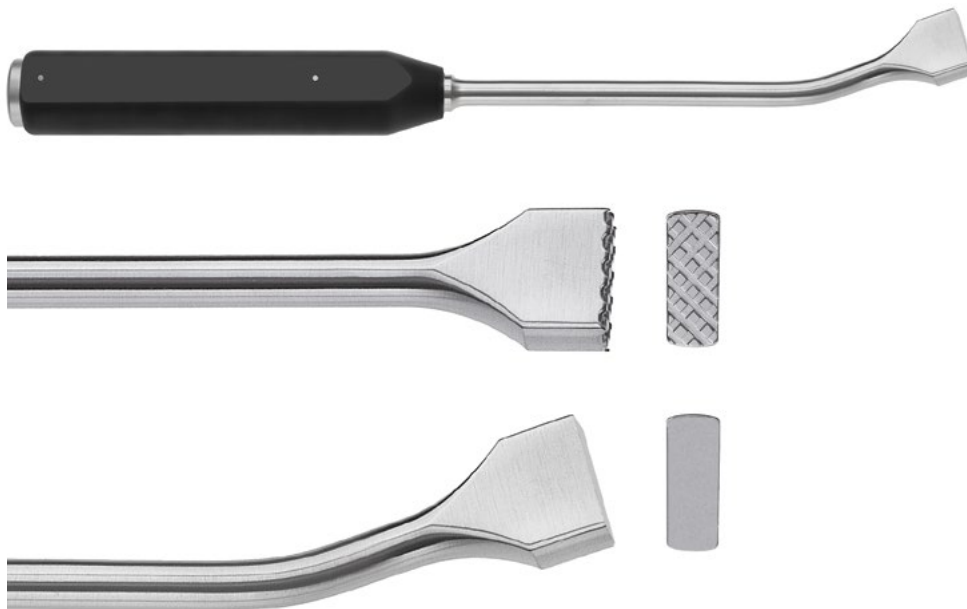

Bone Tamper, synthetic handle,  
15 x 6mm, straight, serrated

255mm, 10" 210-090-021

280mm, 11" 210-090-030

315mm, 12<sup>1/3</sup>" 210-090-033

straight, smooth

255mm, 10" 210-090-023

280mm, 11" 210-090-032

315mm, 12<sup>1/3</sup>" 210-090-035

curved, smooth

255mm, 10" 210-090-022

280mm, 11" 210-090-031

315mm, 12<sup>1/3</sup>" 210-090-034

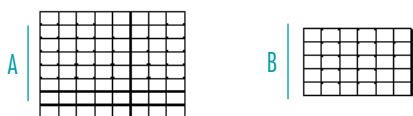

Bone Tamper, synthetic handle,  
350mm, 14"

A 19 x 14mm 210-090-012

B 15 x 10mm 210-090-011



### SYPERT

Bone Tamper, synthetic handle  
190mm, 7<sup>1</sup>/<sub>2</sub>"

A	3 x 8mm	210-091-100
B	4 x 10mm	210-091-101
C	5 x 15mm	210-091-102
D	6 x 20mm	210-091-103



### CASPAR

Bone Tamper, synthetic handle, 200mm, 8"

3mm	210-273-200
5mm	210-274-200
8mm	210-275-200
12mm	210-212-200
14mm	210-214-200
16mm	210-215-200

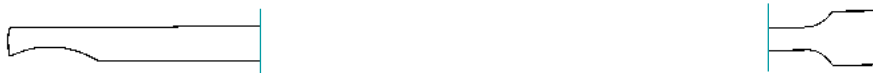

Cement Tamper, small, double-ended,  
7mm / 3mm

230mm, 9"	210-093-230
-----------	-------------



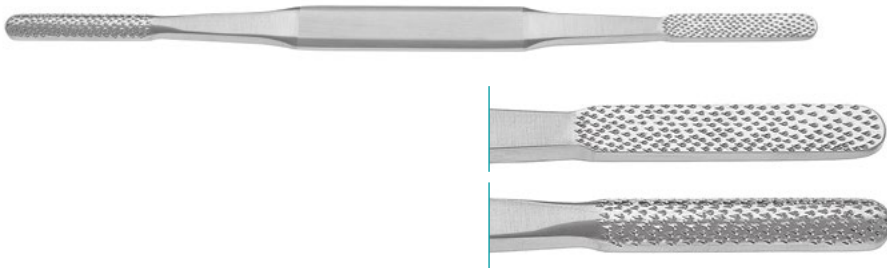

**FOMON**

Rasp, fine, double-ended, 7.5mm / 6.5mm

215mm, 8<sup>1</sup>/<sub>2</sub>"

420-661-000

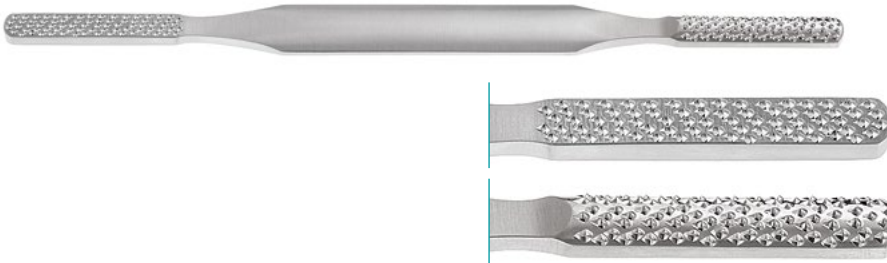

**FOMON**

Rasp, coarse, double-ended, 7.0mm / 8.0mm

215mm, 8<sup>1</sup>/<sub>2</sub>"

420-660-000

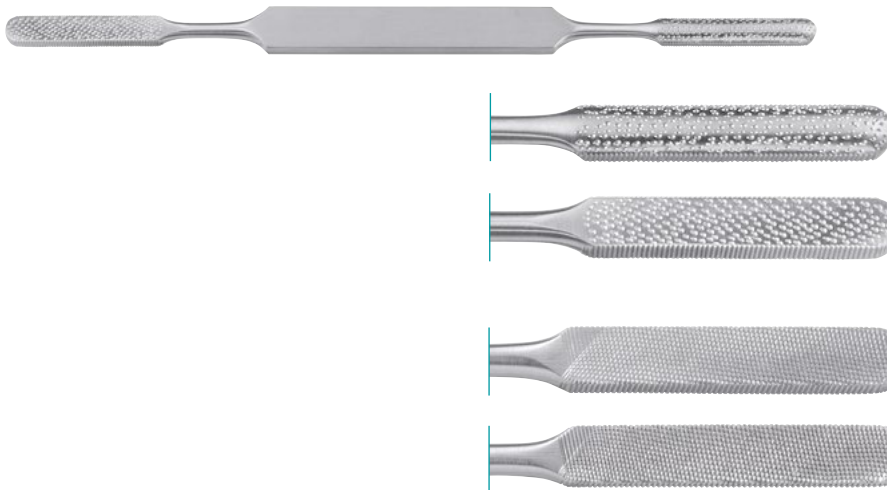

**FOMON**

Rasp, fine/coarse, double-ended, 4 sides

215mm, 8<sup>1</sup>/<sub>2</sub>"

420-661-100

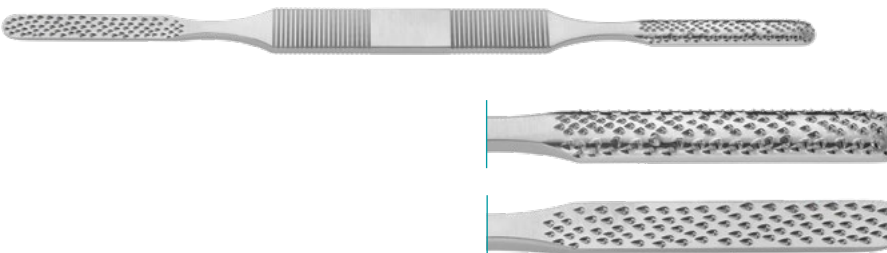

**FOMON LIGHTWEIGHT**

Rasp, double-ended, 7.0mm

215mm, 8<sup>1</sup>/<sub>2</sub>"

Coarse

420-662-001

Fine

420-662-002

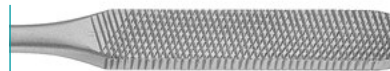
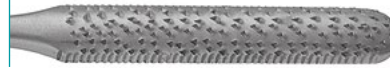
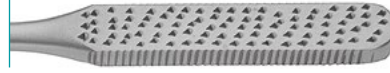

### KLEINERT KUTZ

Rasp, double-ended, 4 sides

220mm, 8<sup>2</sup>/<sub>3</sub>"

420-656-000



Fig. 1



Fig. 2

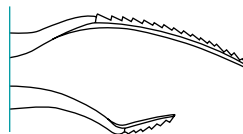
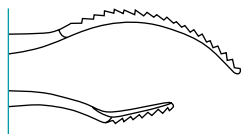

Fig. 3



### MILLER

Rasp, 90° cross-serrated, backwards cutting, 180mm, 7"

Fig. 1 8mm / 5mm

500-387-000

Fig. 2 6mm / 4mm

500-384-010

Fig. 3 6mm / 5mm

500-386-045



### MALTZ

Rasp, straight, backward cutting

180mm, 7"

420-654-180

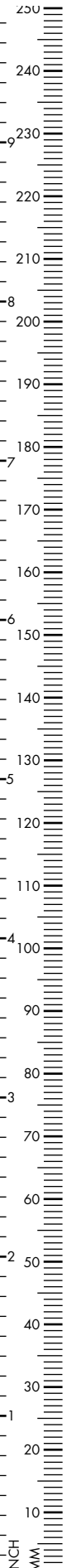



### FOMON

TC Rasp, double-ended, 7 x 40mm  
210mm, 8<sup>1/4</sup>"

Fig. 1 / Fig. 2	420-660-219
Fig. 3 / Fig. 4	420-660-214
Fig. 5 / Fig. 6	420-660-216
Fig. 7 / Fig. 8	420-660-218
Fig. 9 / Fig. 10	420-660-200



### PARKES

TC Rasp, straight, 8 x 39mm  
210mm, 8<sup>1/4</sup>"

Fig. 1	420-490-210
Fig. 2	420-491-210
Fig. 3	420-492-210
Fig. 4	420-493-210
Fig. 5	420-494-210
Fig. 6	420-495-210
Fig. 7	420-496-210
Fig. 8	420-497-210
Fig. 9	420-498-210
Fig. 10	420-499-210



### MALTZ

TC Rasp,  
165mm, 6<sup>1/2</sup>"

Fig. 2	420-492-165
Fig. 3	420-493-165
Fig. 4	420-494-165
Fig. 5	420-495-165
Fig. 6	420-496-165



Fig.1  
0.8



Fig.2  
1.1



Fig.3  
1.3



Fig.4  
1.6



Fig.5  
1.8



Fig.6  
2.0



Fig.7  
2.4



Fig.8  
2.6



Fig.9  
2.8



Fig.10  
3.0

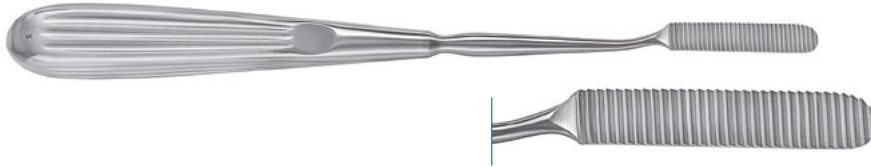

**MALTZ (COTTLE)**

Rasp, backward cutting

210mm, 8<sup>1</sup>/<sub>4</sub>"

420-670-210



**GALLAHER**

Rasp, with ring, coarse

170mm, 6<sup>2</sup>/<sub>3</sub>"

420-678-190



**PUTTI**

Bone File

300mm, 11<sup>7</sup>/<sub>8</sub>"

210-181-300



**PUTTI**

Bone File

270mm, 10<sup>2</sup>/<sub>3</sub>"

210-183-270

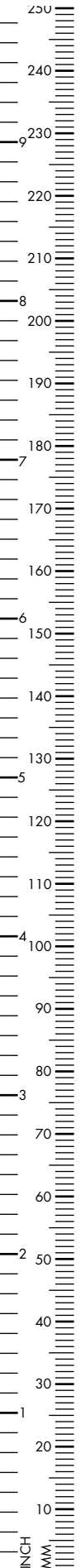



**PUTTI**

Rasp, angled shaft, silicone handle

310mm, 12<sup>1</sup>/<sub>4</sub>"

210-183-270



Bone File / Rasp

220mm, 8<sup>2</sup>/<sub>3</sub>"

210-178-220



Bone File, hollow handle,

**A** semi-round

280mm, 11"

210-176-280

**B** bayonet-shaped

240mm, 9<sup>1</sup>/<sub>2</sub>"

210-177-245



TC Wire Twisting Forceps

150mm, 6"	180-501-150
-----------	-------------

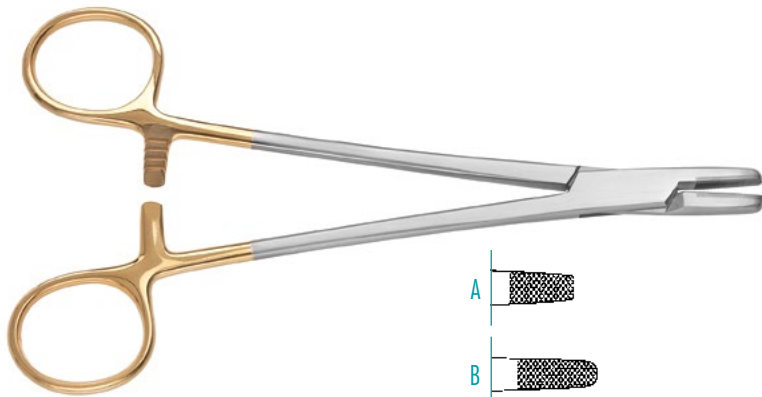

**BERRY**

TC Heavy Sternal Needle Holder

150mm, 6"

A	180-307-150
---	-------------

B	180-308-150
---	-------------

180mm, 7"

C	180-307-180
---	-------------

D	180-308-180
---	-------------

200mm, 8"

E	180-307-200
---	-------------

F	180-308-200
---	-------------

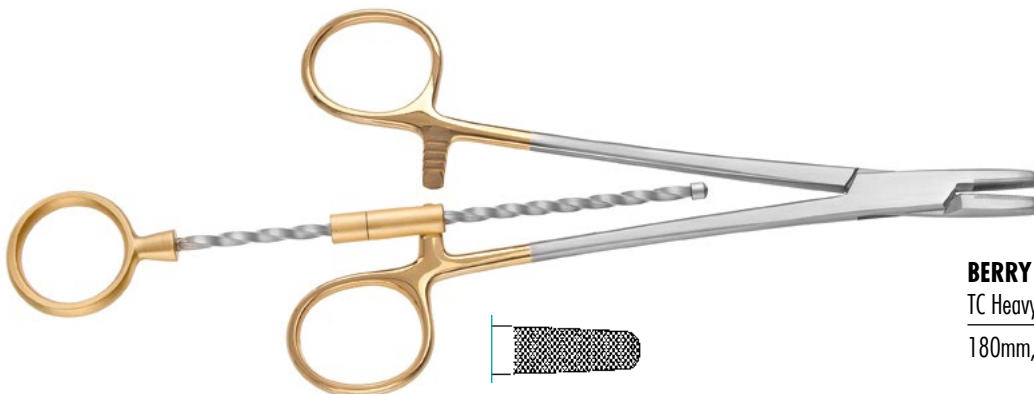
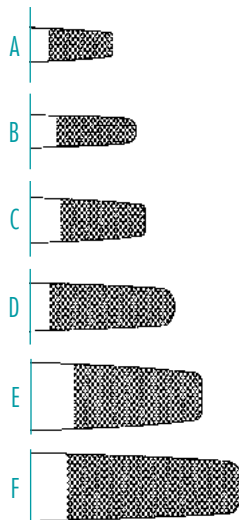

**BERRY**

TC Heavy Sternal Needle Holder

180mm, 7"

180-309-180
-------------

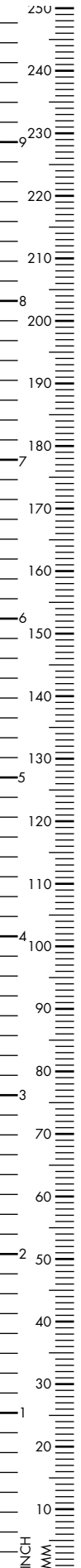



TC Wire Holding Clamp, round jaw

130mm, 5<sup>1</sup>/<sub>8</sub>"

180-569-130

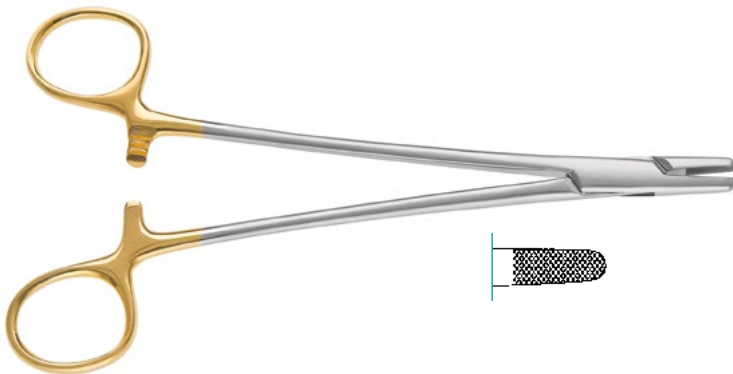

TC Wire Holding Clamp / Sternum

180mm, 7"

180-569-180

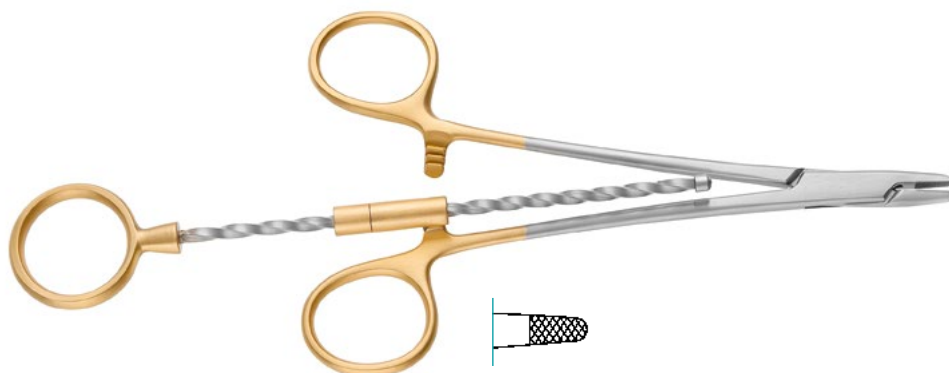

### CORWIN

TC Wire Twister with drill

130mm, 5<sup>1</sup>/<sub>8</sub>"

180-811-130

185mm, 7<sup>1</sup>/<sub>4</sub>"

180-810-185



Wire Extraction Plier, lateral support  
to hold wire in place, 170mm, 6<sup>2</sup>/<sub>3</sub>"

without drill 200-514-170

with drill 200-515-170

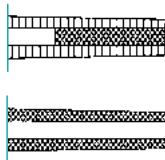
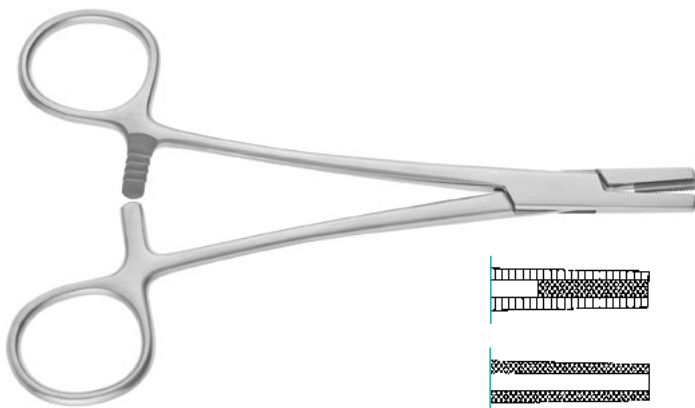

Wire Pulling Forceps

165mm, 6<sup>1</sup>/<sub>2</sub>" 200-503-165

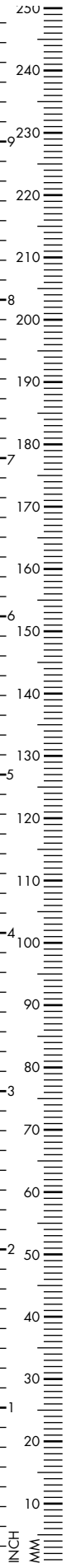





Wire Holding Forceps

140mm, 5 1/2" 200-515-140



Flat Nose Plier, distal jaw, smooth

140mm, 5 1/2" 180-507-140



Flat Nose Plier, serrated jaw

140mm, 5 1/2" 180-511-140

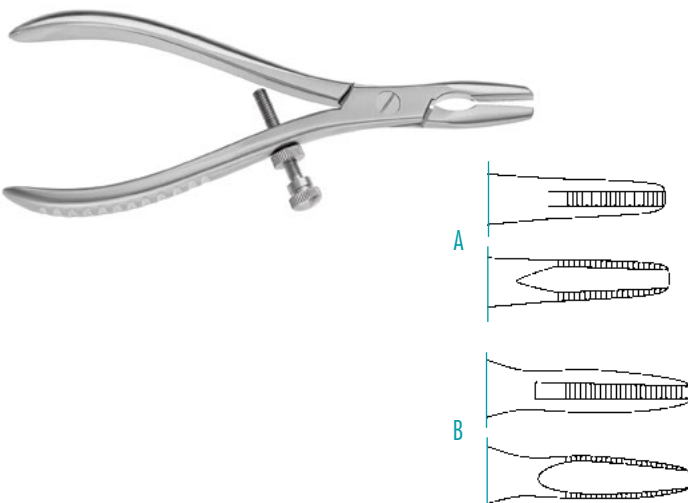

Wire Extraction Forceps

A 130mm, 5 1/8" 200-507-130

B 180mm, 7" 200-507-180

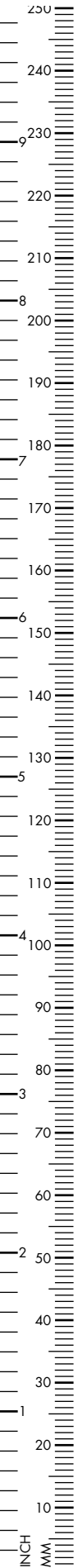

Wire Twister / Tightener

160mm, 6<sup>1</sup>/<sub>4</sub>" 180-512-160

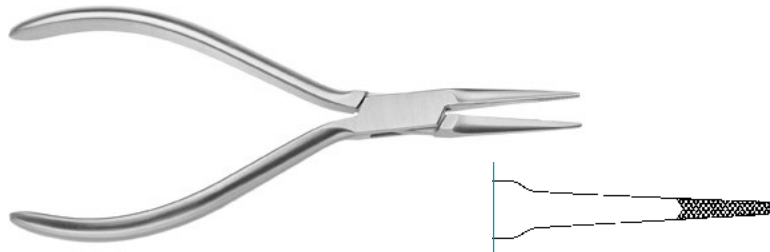

Flat Nose Plier, delicate long jaw,  
2mm wide tip

160mm, 6<sup>1</sup>/<sub>4</sub>" 180-515-160



Flat Nose Plier, sharp

195mm, 7<sup>3</sup>/<sub>4</sub>" 180-500-180

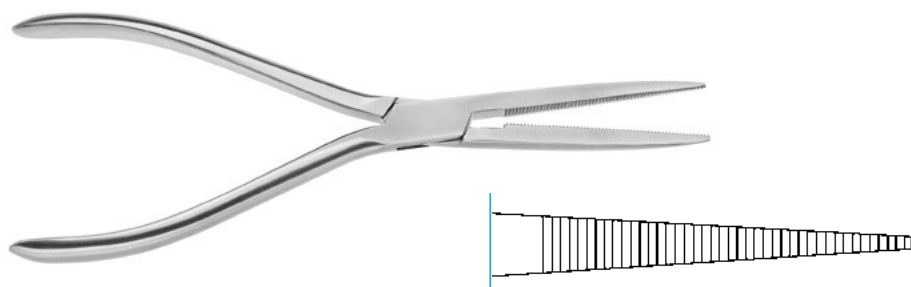

Long Jaw Needle Nose Plier,  
parallel serrated jaw

178mm, 7" 180-513-170

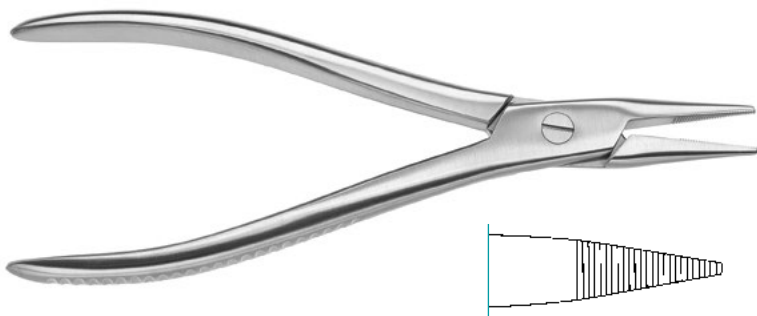

Narrow Nose Wire Pulling Forceps,  
3mm jaw

190mm, 7<sup>1</sup>/<sub>2</sub>" 180-513-190

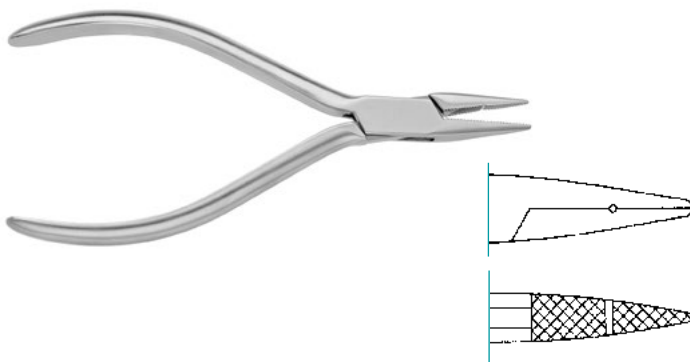

Needle Nose Plier,  
wire with groove, for 1mm cerclage

140mm, 5<sup>1</sup>/<sub>2</sub>" 200-518-140



Flat Nose Plier, with groove

160mm, 6<sup>1</sup>/<sub>4</sub>" 200-518-160

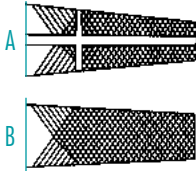
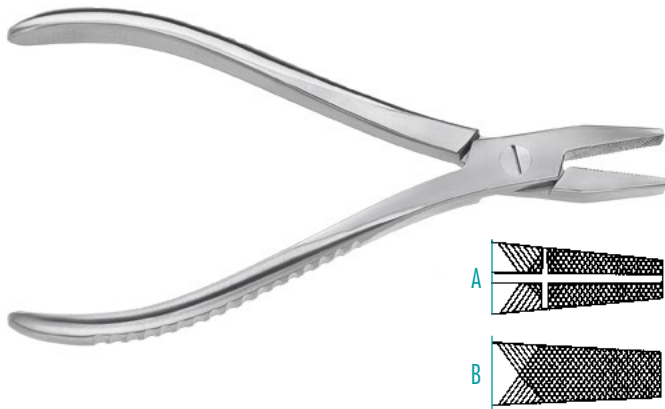
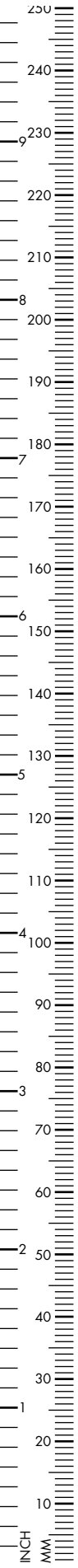

Wire Holding Pliers,  
with longitudinal and transversal grooves,  
170mm, 6<sup>2</sup>/<sub>3</sub>"

A	180-500-170
B	180-501-170

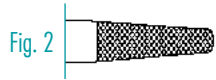
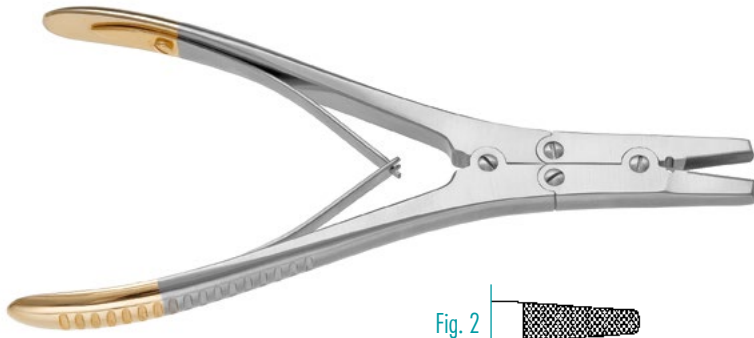

TC Flat Nose Plier, double action  
180mm, 7"

Fig. 2	200-511-002
--------	-------------

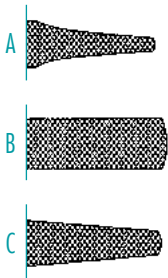
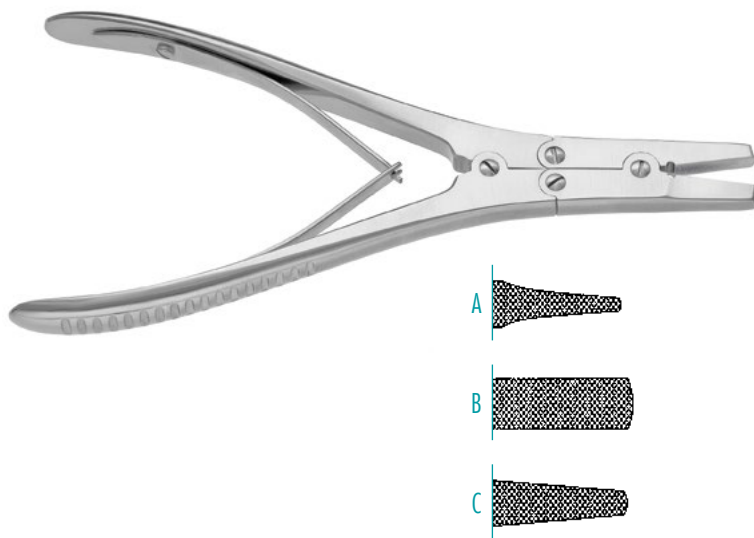

Wire Extraction Plier, double action  
145mm, 5<sup>3</sup>/<sub>4</sub>"

A	200-514-145
180mm, 7"	
B	200-507-180
C	200-514-180



Flat Nose Plier, 2mm tapered tip

140mm, 5<sup>1/2</sup>" 180-510-140

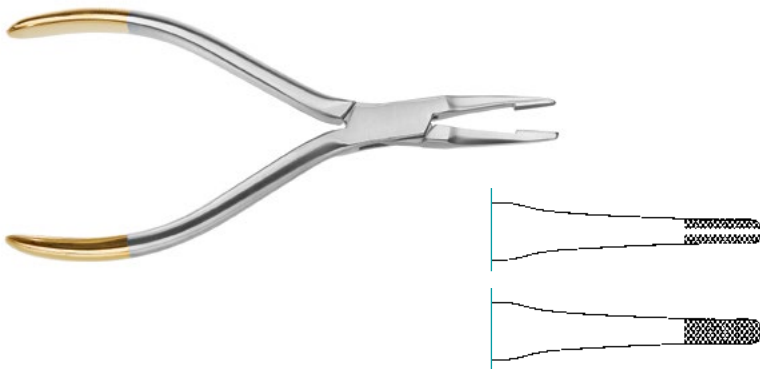

Pin Pulling Forceps, 1 TC Insert

140mm, 5<sup>1/2</sup>" 180-512-140



**LANGENBECK**

Round Plier, smooth, round jaw

140mm, 5<sup>1/2</sup>" 180-634-140

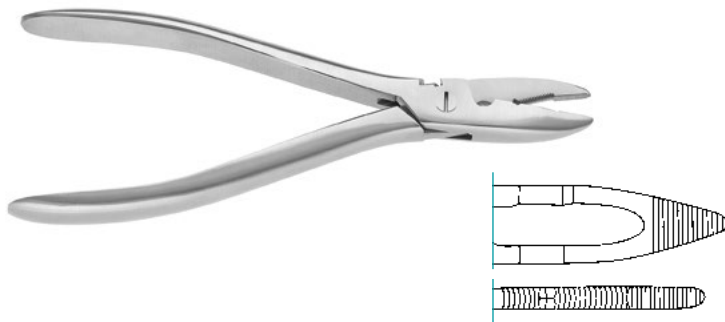

**WALDSACHS**

Universal Plier

155mm, 6<sup>1/8</sup>"

180-790-150

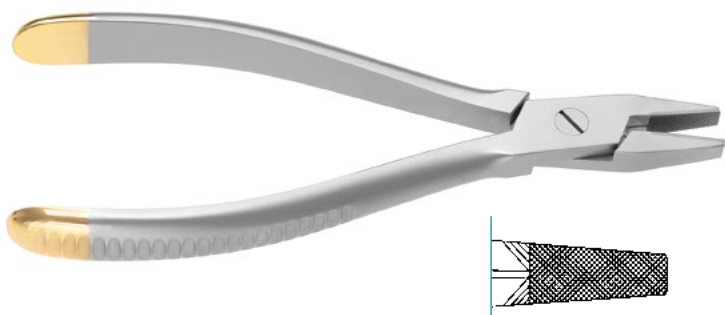

**TC Multi-Purpose Plier**

190mm, 7<sup>1/2</sup>"

180-501-190



**PEESO**

Wire Bending Plier

135mm, 5<sup>1/3</sup>"

180-843-135

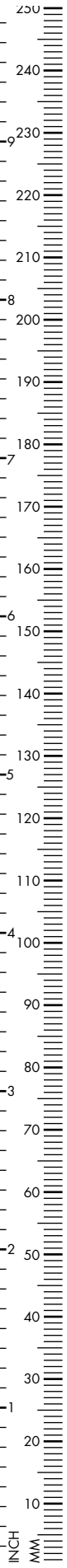



Wire and Pin Bender / up to 3.2mm

150mm, 6"

200-204-150



**LOUTE**

Wire Tightener

210mm, 8<sup>1</sup>/<sub>4</sub>"

200-513-210

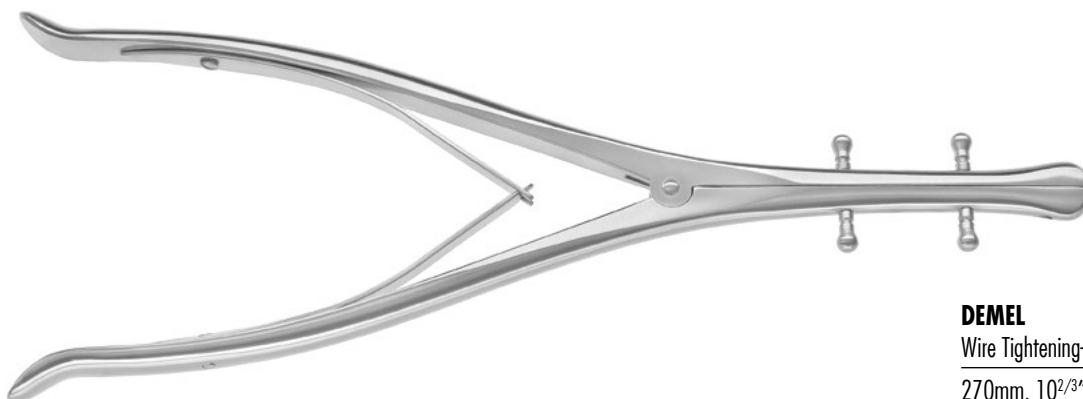

**DEMEL**

Wire Tightening- and Twisting Forceps

270mm, 10<sup>2</sup>/<sub>3</sub>"

200-755-270



Needle Nose Locking Plier

**A** 220mm, 8<sup>2</sup>/<sub>3</sub>" / small

Regular model 200-515-220

For Extraction Mallet 200-515-221

**B** 250mm, 9<sup>7</sup>/<sub>8</sub>" / medium

Regular model 200-515-250

For Extraction Mallet 200-515-251

**C** 300mm, 11<sup>7</sup>/<sub>8</sub>" / large

Regular model 200-515-300

For Extraction Mallet 200-515-301

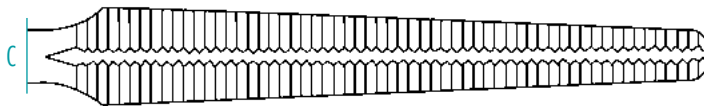
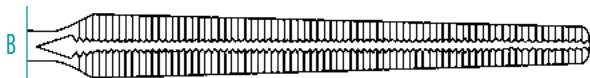

Extraction Mallet  
for small and medium models

400g

350mm, 14" 210-400-350

for large models

700g

400mm, 15<sup>3</sup>/<sub>4</sub>" 210-700-350



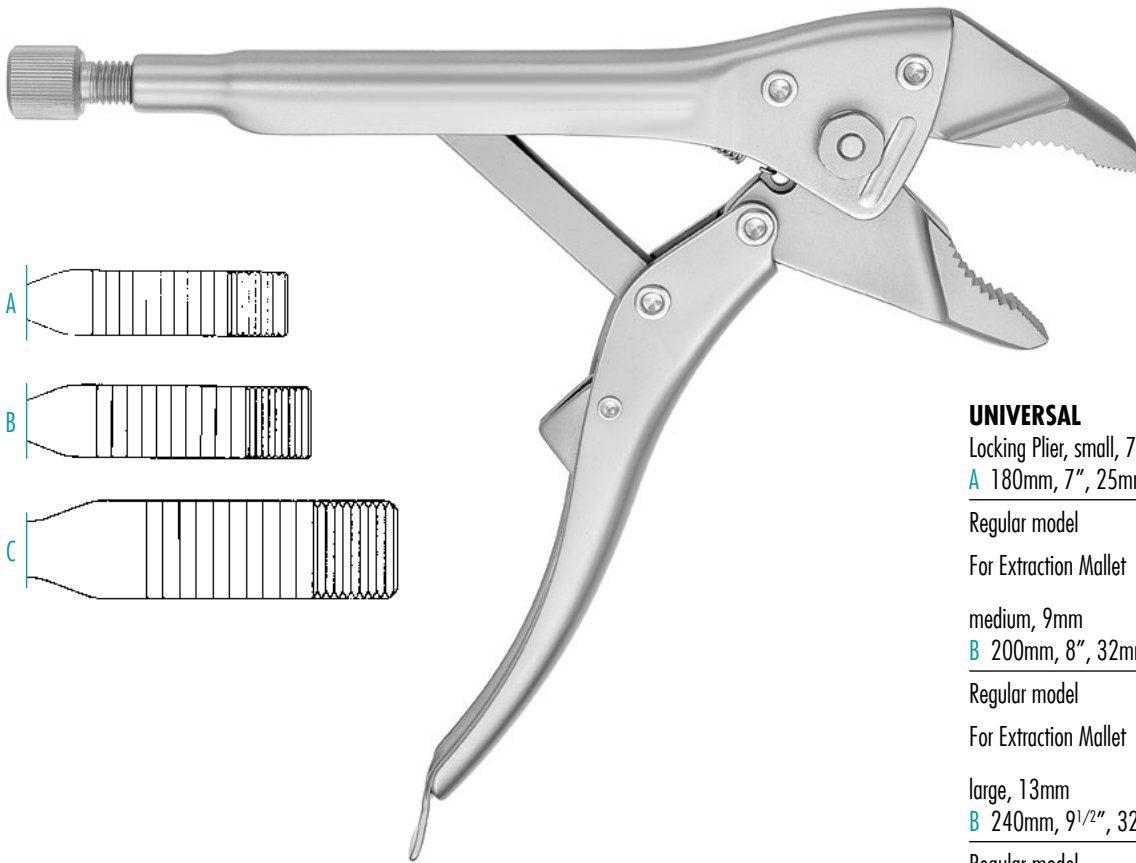

### UNIVERSAL

Locking Plier, small, 7mm

A 180mm, 7", 25mm jaw spreading

Regular model 200-511-180

For Extraction Mallet 200-511-181

medium, 9mm

B 200mm, 8", 32mm jaw spreading

Regular model 200-511-200

For Extraction Mallet 200-511-201

large, 13mm

B 240mm, 9 1/2", 32mm jaw spreading

Regular model 200-511-240

For Extraction Mallet 200-511-241



### UNIVERSAL

Wire sizing Forceps,  
max. opening 50mm

200mm, 8" 180-502-200



Wire Gripper, parallel closure

185mm, 7 1/4" 200-513-185

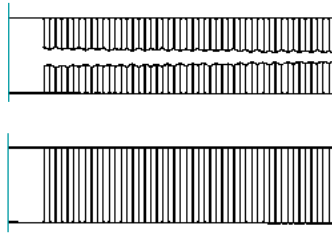
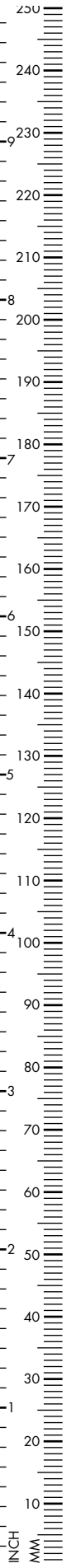

Combined Wire Cutter and Gripper

180mm, 7"

200-512-185



Flat Nose Plier, 3.5mm jaw

160mm, 6<sup>1/4</sup>"

180-535-160

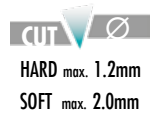
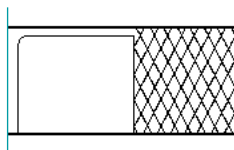
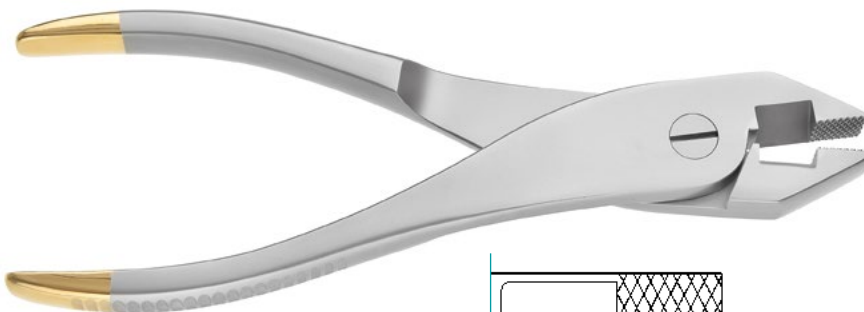

**LINEMAN**

Plier with cutting edge

220mm, 8<sup>2/3</sup>"

200-516-220

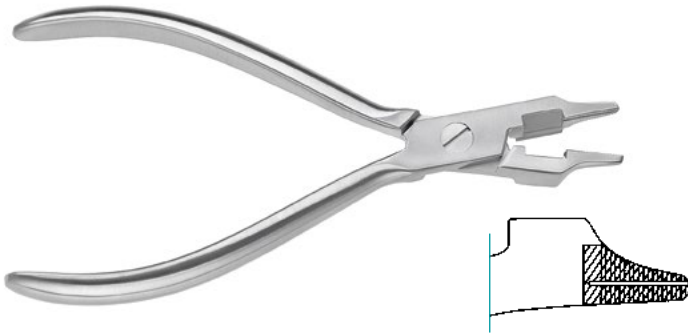

**CUT**   
 HARD max. 1.0mm  
 SOFT max. 1.5mm

**UNIVERSAL**

Wire Cutting and Bending Forceps

150mm, 6" 200-513-150

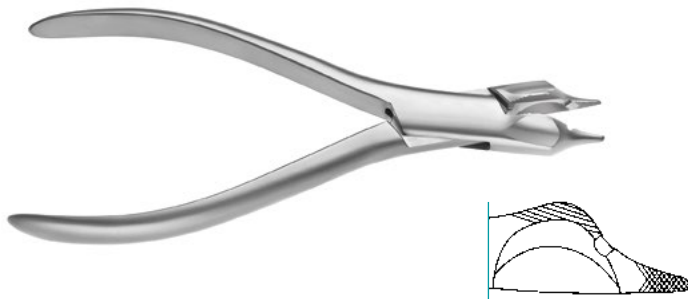

**CUT**   
 HARD max. 0.7mm  
 SOFT max. 1.0mm

Wire Cutting / Bending Forceps

150mm, 6" 200-514-150

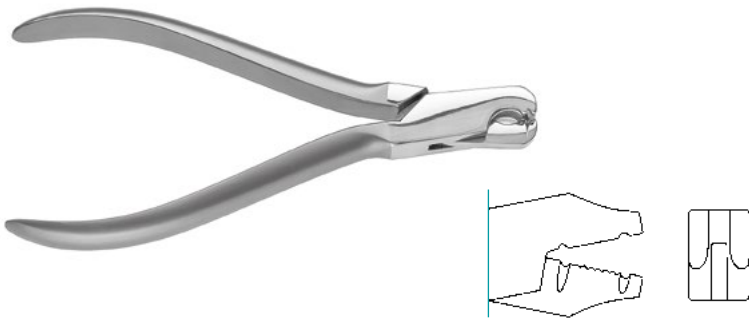

K-Wire and Plate Bending Forceps,  
 for mini plates up to 1.6mm,  
 90° - bending for K-Wires

140mm, 5<sup>1</sup>/<sub>2</sub>" 200-416-140

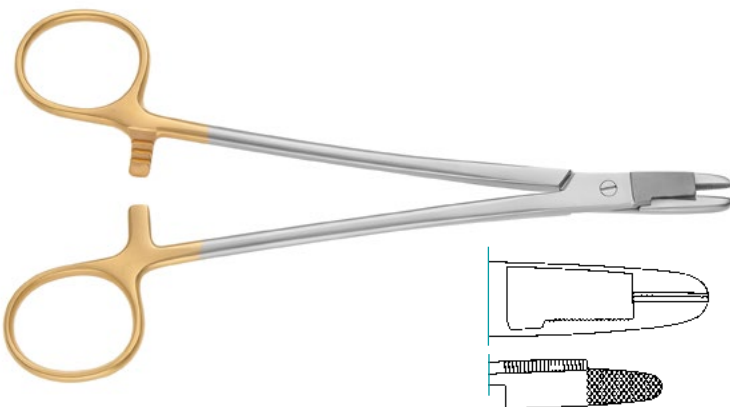

**KOPPELMANN**

Wire Twister and Scissors

185mm, 7<sup>1</sup>/<sub>4</sub>" 180-572-185

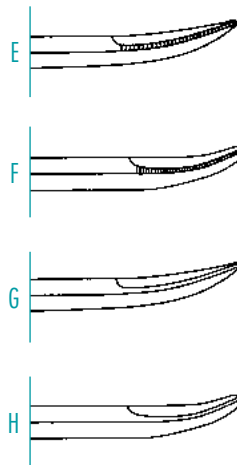
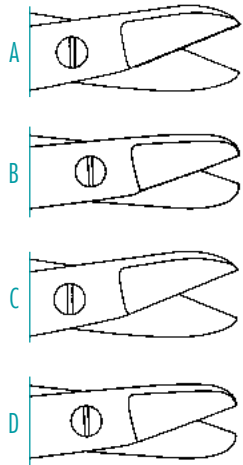

Crown & Collar Scissors, 100mm, 4"

A	Straight, sharp, serrated	120-296-100
B	Straight, blunt, serrated	120-300-100
C	Straight, sharp	120-294-100
D	Straight, blunt	120-298-100
E	Curved, sharp, serrated	120-297-100
F	Curved, blunt, serrated	120-301-100
G	Curved, sharp	120-295-100
H	Curved, blunt	120-299-100

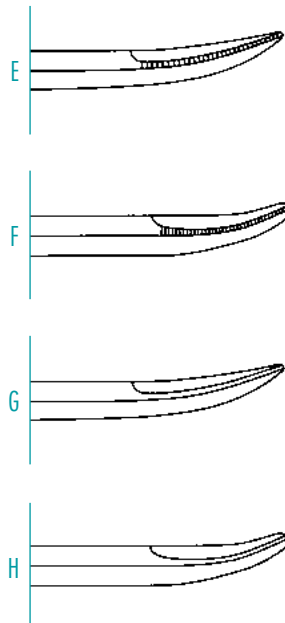
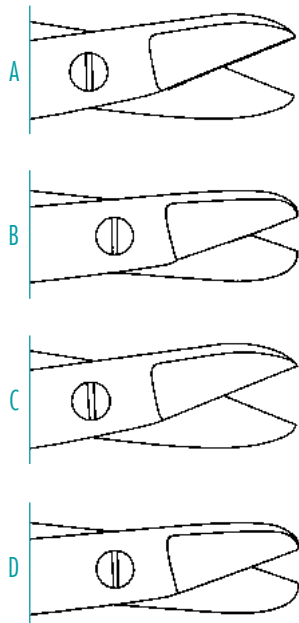

Crown & Collar Scissors, 120mm, 4<sup>3</sup>/<sub>4</sub>"

A	Straight, sharp, serrated	120-296-120
B	Straight, blunt, serrated	120-300-120
C	Straight, sharp	120-294-120
D	Straight, blunt	120-298-120
E	Curved, sharp, serrated	120-297-120
F	Curved, blunt, serrated	120-301-120
G	Curved, sharp	120-295-120
H	Curved, blunt	120-299-120

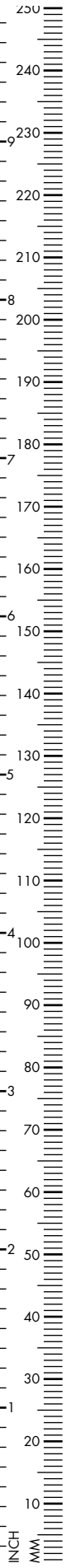

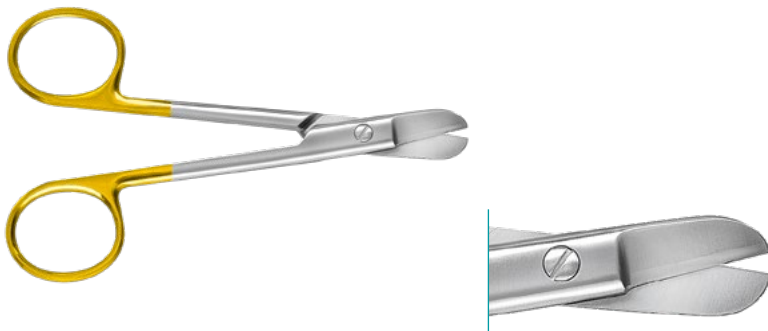

TC Wire Scissors  
120mm, 4<sup>3/4</sup>" 120-596-120

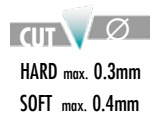
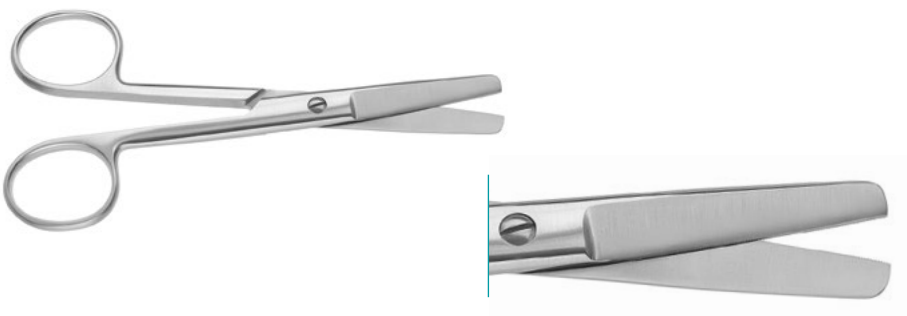

**HARVEY**  
Wire Cutting Scissors, serrated  
125mm, 5" 120-262-125

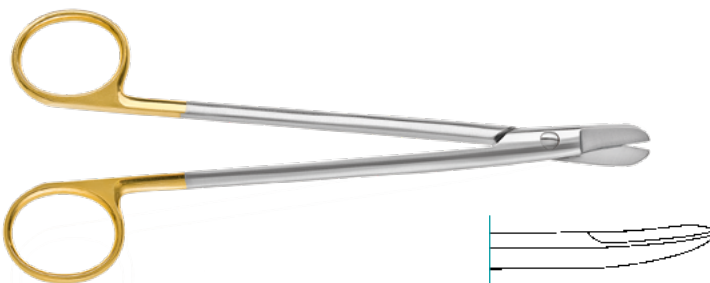

**SMITH**  
TC Wire Scissors, serrated, 160mm, 6<sup>1/4</sup>"  
straight 120-570-160  
curved 120-571-160

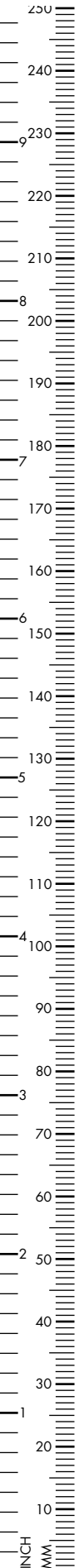

### SCHUKNECHT

Wire Scissors, straight, short blade

100mm, 4"

120-120-100



HARD max. 0.8mm

SOFT max. 1.2mm

### UNIVERSAL

Wire & Plate Scissors, serrated

120mm, 4<sup>3/4</sup>"

120-265-120

With TC inserts

120mm, 4<sup>3/4</sup>"

120-565-120

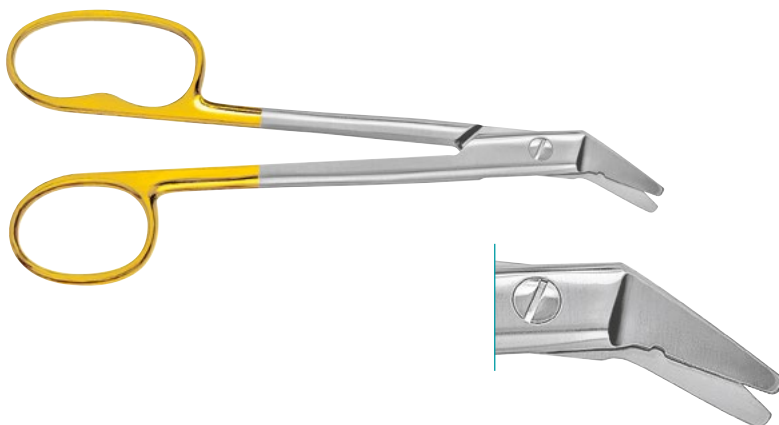

### UNIVERSAL

TC Wire & Plate Scissors

170mm, 6<sup>2/3</sup>"

120-565-170



TC Wire Cutter, up to 0.7mm  
 110mm, 4<sup>1/3</sup>" 200-500-110

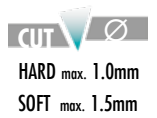

TC Wire Cutter  
 150mm, 6" 180-513-530

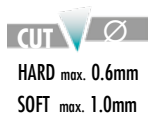
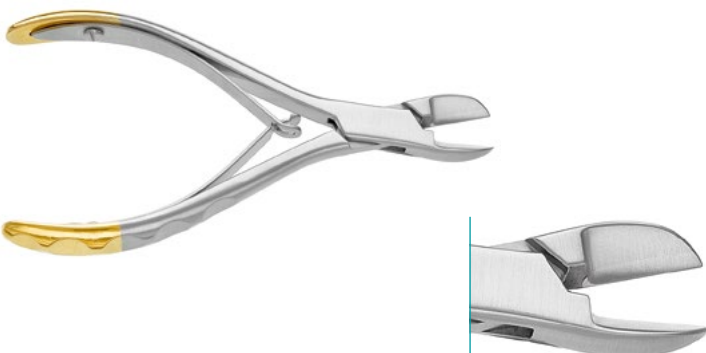

TC Wire Cutter  
 120mm, 4<sup>3/4</sup>" 200-500-120

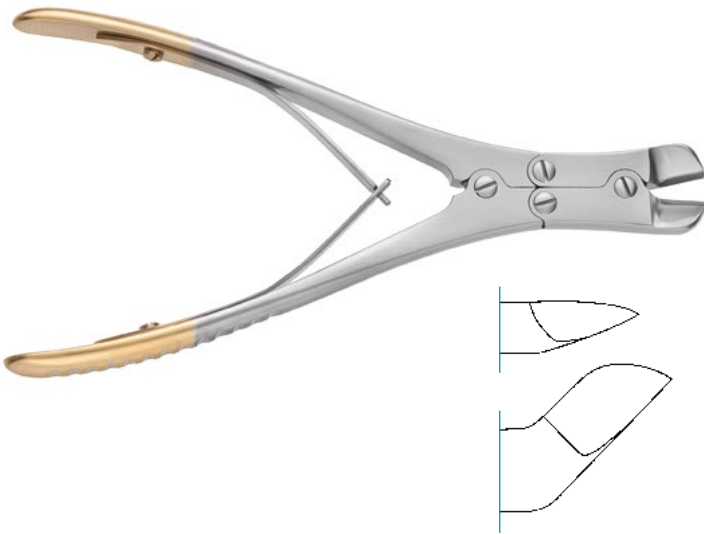
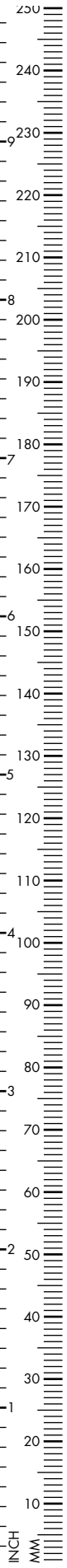

**CUT**   
 HARD max. 1.6mm  
 SOFT max. 2.0mm

TC Wire Cutter, angled  
 170mm, 6<sup>2</sup>/<sub>3</sub>" 200-500-160

**CUT**   
 HARD max. 1.8mm  
 SOFT max. 2.2mm

**REILL**  
 TC Wire Cutter, angled  
 220mm, 8<sup>2</sup>/<sub>3</sub>" 200-500-220

**CUT**   
 HARD max. 2.2mm  
 SOFT max. 3.0mm



TC Wire Cutter, 45° angled jaw  
 235mm, 9<sup>1</sup>/<sub>4</sub>" 200-504-235

**CUT**   
 HARD max. 2.2mm  
 SOFT max. 3.0mm



TC Wire Cutter, 12° angled jaw  
 235mm, 9<sup>1</sup>/<sub>4</sub>" 200-503-235



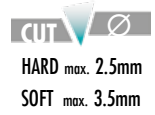

TC Front Wire Cutter  
220mm, 8<sup>2</sup>/<sub>3</sub>" 200-506-220

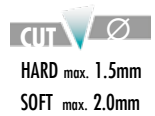

TC Front and Lateral Wire Cutter  
150mm, 6" 200-510-150

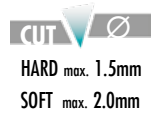

Wire Cutter, 180mm, 7"  
200-502-180  
TC Inserts 200-504-180

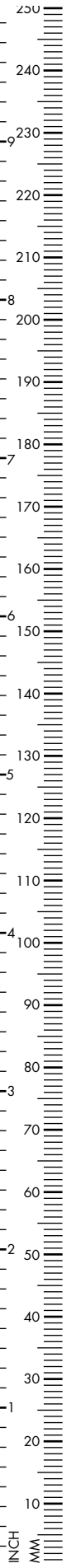



**CUT**   
**HARD** max. 0.7mm  
**SOFT** max. 1.0mm

TC Wire Cutter

145mm, 5<sup>3/4</sup>"

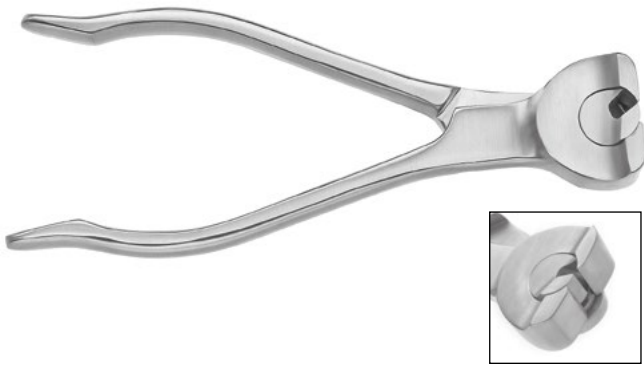
200-510-145



**CUT**   
**HARD** max. 1.6mm  
**SOFT** max. 2.0mm

Diamond Head-Wire Cutter, front action

160mm, 6<sup>1/4</sup>"

200-510-160



**CUT**   
**HARD** max. 1.6mm  
**SOFT** max. 2.4mm

Head Cutter, cannulated

185mm, 7<sup>1/4</sup>"

200-502-185

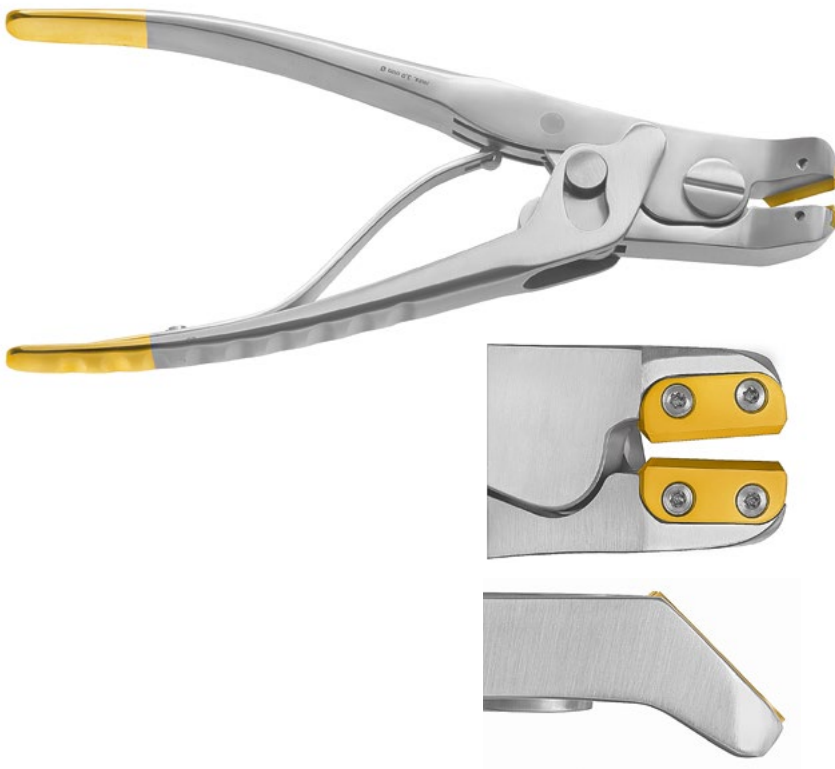

**CUT**  $\varnothing$   
 HARD max. 2.2mm  
 SOFT max. 2.8mm

TC "Easy Cut" Wire Cutter

200mm, 8"

200-502-200



**CUT**  $\varnothing$   
 HARD max. 2.2mm  
 SOFT max. 2.8mm

TC Wire Cutter,  
 exchangeable TC Blades and rubber jaw  
 up to  $\varnothing$  3.0mm

230mm, 9"

200-500-230

up to  $\varnothing$  4.0mm

280mm, 11"

200-502-280

TC Blades spare set

200-502-997

Rubber jaw spare set

200-502-998

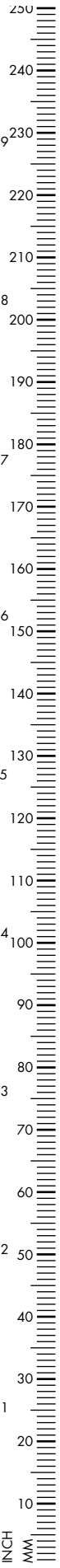

TC Wire Cutter for right-hander,  
exchangeable TC blades and rubber jaw

180mm, 7" 200-505-180



TC Front and Side Cutter,  
exchangeable TC blades and rubber jaw

180mm, 7" 200-509-180

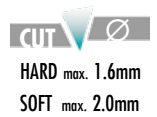

TC Flush Wire Cutter

180mm, 7" 200-508-180



UP TO 3.2mm

TC Wire Cutter, double action

240mm, 9<sup>1</sup>/<sub>2</sub>"

200-522-240



UP TO 6.35mm

Pin Cutter, detachable handles

575mm, 22<sup>1</sup>/<sub>2</sub>"

200-500-585



TC Pin Cutter

470mm, 18 1/2"

200-500-470



TC Front Cutter

380mm, 15"

200-500-380

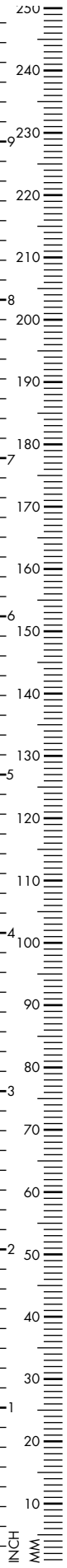

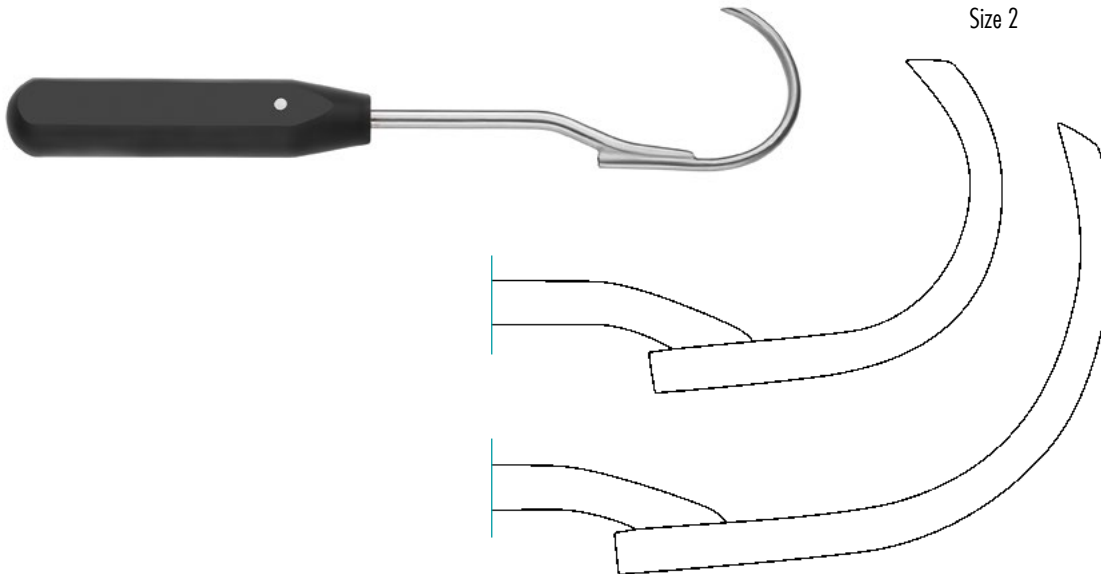

Wire Guide, synthetic handle, 210mm, 8<sup>1</sup>/<sub>4</sub>"

Size 1 180-751-018

Size 2 180-751-020



Bone Wire Guide, hollow, sharp

240mm, 9<sup>1</sup>/<sub>2</sub>" 180-751-014

270mm, 10<sup>2</sup>/<sub>3</sub>" 180-751-016

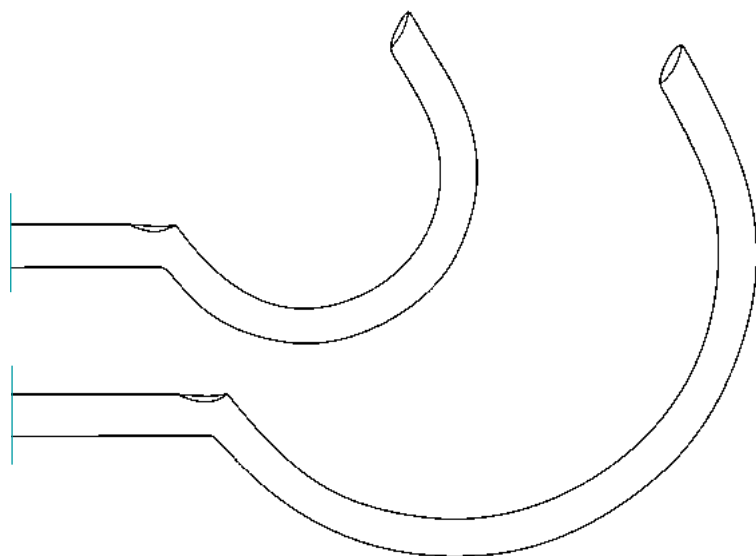

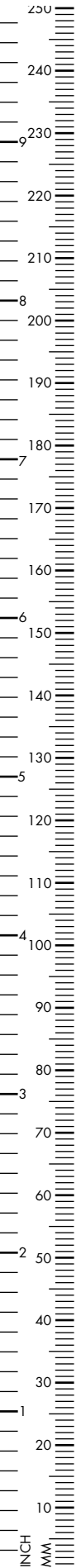

**DEMEL**

Bone Wire Guide, 280mm, 11"

#1 180-751-001

#2 180-751-002

305mm, 12"

#3 180-751-003

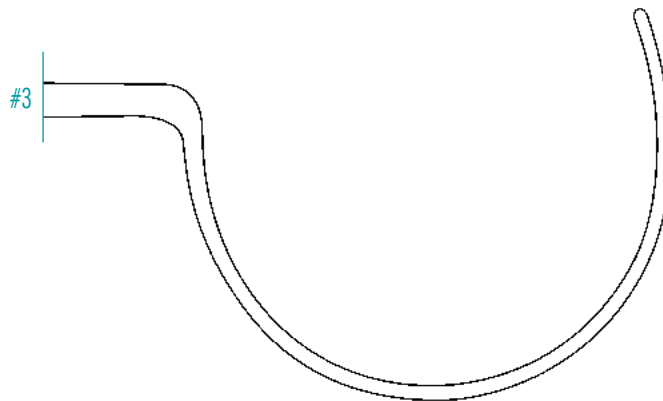
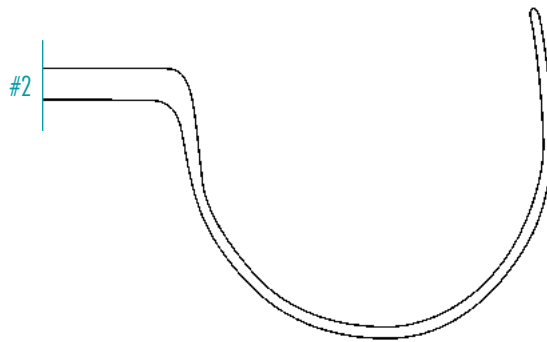
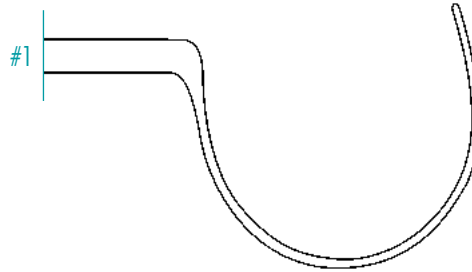



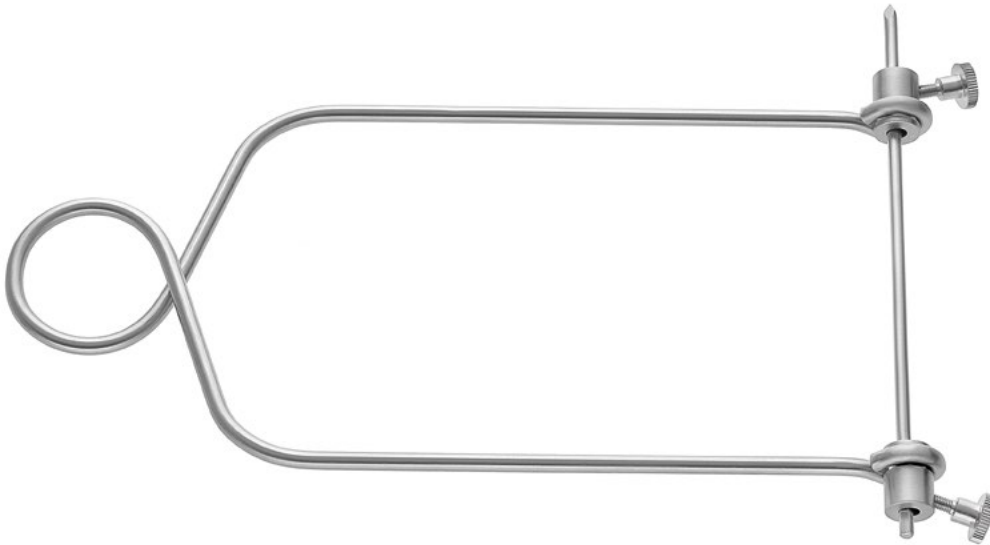

### BOEHLER

Extension Bow, without pin  
for 3.5 - 5.0mm Steinmann Pins  
for arm

90 x 160mm	200-552-160
without pin	200-550-160

for knee and femur

110 x 210mm	200-552-210
without pin	200-550-210

for thigh and knee

150 x 210mm	200-552-250
without pin	200-550-250



### KIRSCHNER

Extension Bow  
Max. opening: medium

130mm, 5 <sup>1</sup> / <sub>8</sub> "	200-555-180
--	-------------

Max. opening: large

185mm, 7 <sup>1</sup> / <sub>4</sub> "	200-555-220
--	-------------

Max. opening: extra large

220mm, 8 <sup>2</sup> / <sub>3</sub> "	200-555-220
--	-------------



### KIRSCHNER

Extension Bow,  
complete with 3 traction hooks  
180 x 100mm

small pattern	200-601-140
---------------	-------------

270 x 160mm

large pattern	200-601-220
---------------	-------------



Traction Hook for Kirschner Bows  
(set of 3 hooks)

large	200-560-050
-------	-------------

small	200-560-030
-------	-------------



Wire Finger Grip

small	215-000-001
-------	-------------

medium	215-000-002
--------	-------------

large	215-000-003
-------	-------------



Bone Fragment Distractor,  
2.5mm and 1.6mm pin holes,  
outspread

150mm, 6"	210-974-300
-----------	-------------

210mm, 8 1/4"	210-974-310
---------------	-------------

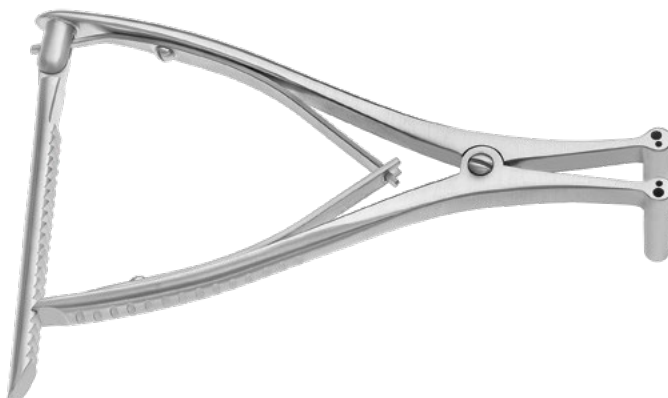

Bone Fragment Distractor,  
2.5mm and 1.6mm pin holes,  
closed

150mm, 6"	210-974-301
-----------	-------------

210mm, 8 1/4"	210-974-311
---------------	-------------

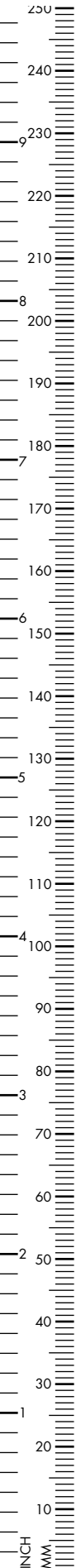



Wire Strainer for Kirschner Extension Bow  
200-557-000



Traction Hook for Kirschner Bows  
(set of 3 hooks)  
large 200-560-050  
small 200-560-030



Screw Nut Wrench  
200-558-000

### KIRSCHNER

Extension Bow,  
complete with 3 traction hooks

B 155mm A 200mm	
for hip	200-560-200
B 120mm A 120mm	
for knee	200-560-120
B 95mm A 70mm	
for arm	200-560-070

B 155mm A 155mm	
for femur	200-560-155
B 105mm A 100mm	
for knee	200-560-105
B 60mm A 50mm	
for elbow	200-560-060

B 135mm A 130mm	
for knee	200-560-135
B 95mm A 110mm	
for heel	200-560-095

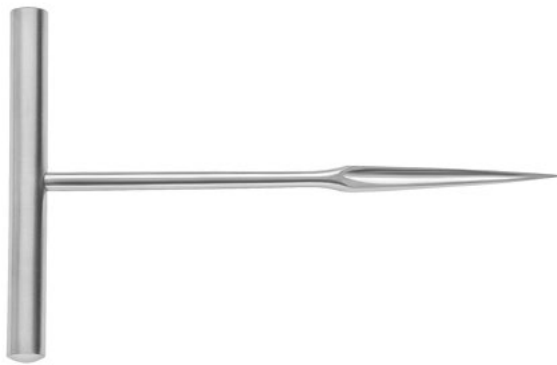
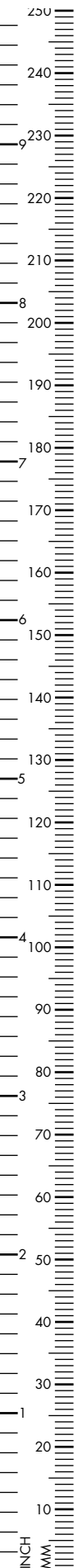

Awl with T-Handle

150mm, 6"

200-124-140

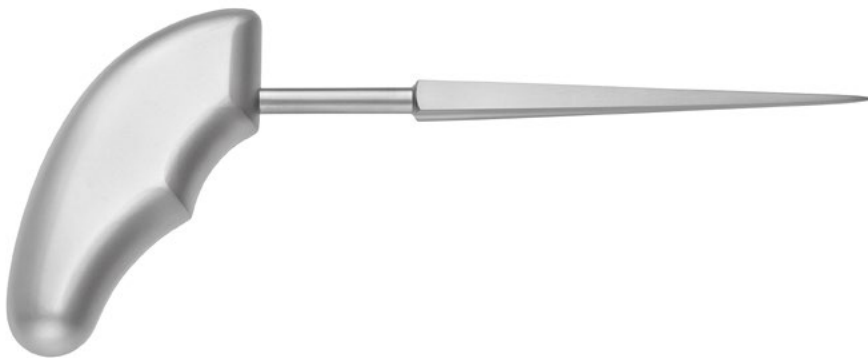

**PERTHES**

Reamer, square

220mm, 8<sup>2/3</sup>"

200-122-210



Reamer, Ø 2.5 - 3.5mm

160mm, 6<sup>1/4</sup>"

200-120-140



Large Awl, 235mm, 9<sup>1</sup>/<sub>4</sub>" , pyramidal tip

large 259-258-145

small 259-258-144

Crotched Hook Awl, 235mm, 9<sup>1</sup>/<sub>4</sub>"

large 259-258-146

small 259-258-147



### **PERTHES**

Bone Drill

210mm, 8<sup>1</sup>/<sub>4</sub>" 200-160-210

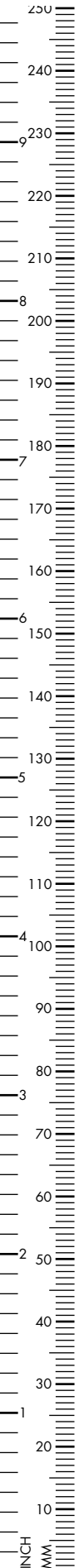

**OBWEGESER**

Awl

230mm, 9"

430-500-230

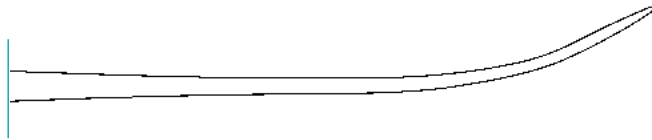

**BRUNNER**

Awl, malleable

230mm, 9"

200-124-230

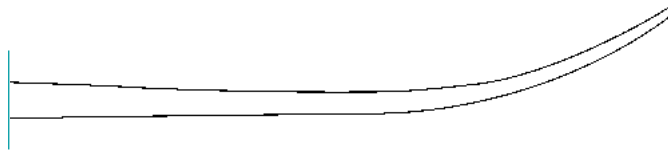

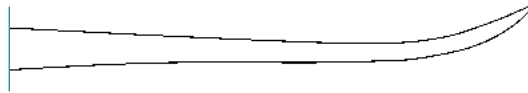

### OBWEGESER

Awl

180mm, 7"

430-504-180



### BRUNNER

Awl, curved

300mm, 11<sup>7</sup>/<sub>8</sub>"

200-122-300

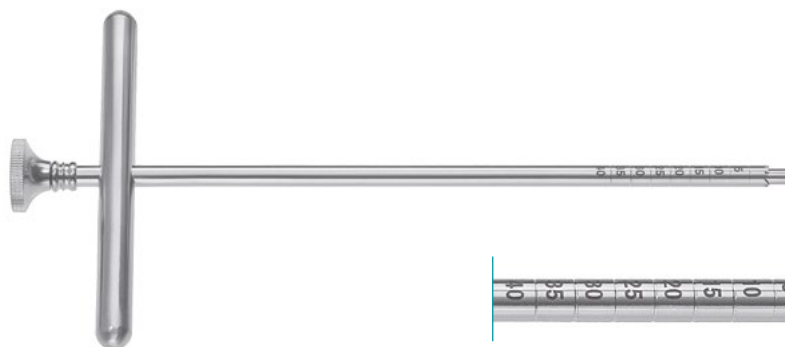

### MICHELE

Trephine, 180mm, 7"

Ø 3.0mm (inside)

210-405-180

Ø 5.0mm (outside)

Ø 5.0mm (inside)

210-406-180

Ø 6.0mm (outside)

Ø 6.5mm (inside)

210-408-180

Ø 8.0mm (outside)

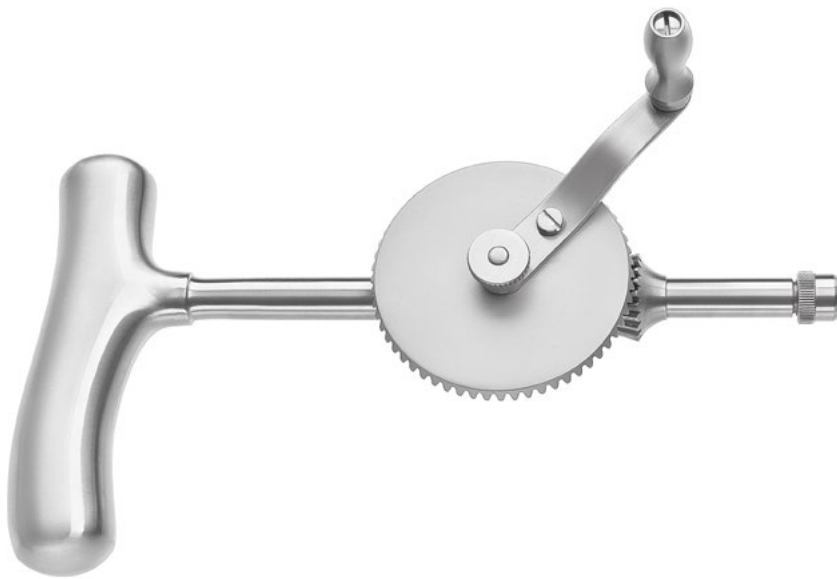

### STILLE

Hand Drill, complete with 4 drills & burrs  
 $\varnothing$  2.5 - 4.0mm

200-144-200

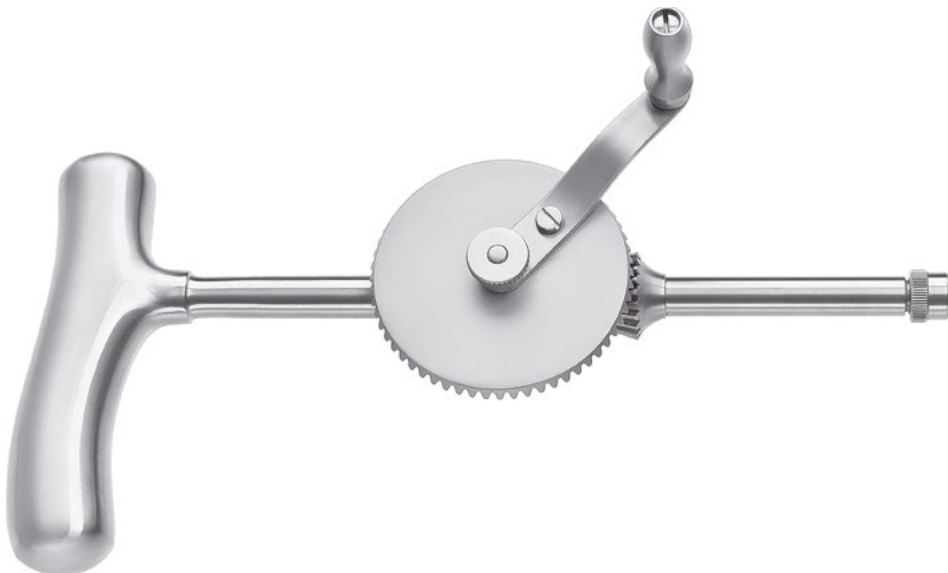

### STILLE SHERMAN

Hand Drill, complete with 3 drills  
 $\varnothing$  2.5 - 3.5mm

200-140-240

Brace only

200-140-200



#### A Burrs, 60mm length

$\varnothing$ 5.0mm	200-145-050
$\varnothing$ 8.0mm	200-145-080
$\varnothing$ 12.0mm	200-145-120
$\varnothing$ 16.0mm	200-145-160

#### B Trepphine

$\varnothing$ 10.0mm	200-145-100
----------------------	-------------

#### C Twist Drills

$\varnothing$ 1.0mm, 56mm	200-145-010
$\varnothing$ 1.5mm, 61mm	200-145-015
$\varnothing$ 2.0mm, 66mm	200-145-020
$\varnothing$ 2.5mm, 81mm	200-145-025
$\varnothing$ 3.0mm, 81mm	200-145-030
$\varnothing$ 3.5mm, 86mm	200-145-035
$\varnothing$ 4.0mm, 86mm	200-145-040





### **BUNNELL**

Hand Drill, max. shanks  $\varnothing$  4mm

160mm, 6<sup>1/4</sup>" 200-154-160



### **BUNNELL**

Key

200-154-162



### **RALK**

Hand Drill, Jacobs chuck and key  
up to  $\varnothing$  4mm

200-153-000

large 200-153-005



### HUDSON

Hand Drill (tightening screw),  
complete with 4 burrs and extension (A - E)

270mm, 10<sup>2</sup>/<sub>3</sub>" 200-152-000

Hand Drill only, with tightening screw

200-150-000



### HUDSON

Hand Drill (snap lock),  
complete with 4 burrs and extension (A - E)

270mm, 10<sup>2</sup>/<sub>3</sub>" 200-152-010

Hand Drill only, with tightening screw

200-151-000



Burrs, 60mm

A Ø 9.0mm 200-152-001

B Ø 14.0mm 200-152-002

C Ø 16.0mm 200-152-003

D Ø 22.0mm 200-152-004

E Extension Piece 200-152-009



### A CUSHING

Flat Drill, Hudson connection

Ø 14mm, 95mm 200-152-005

### D CUSHING

Round Drill, Hudson connection

Ø 15mm, 95mm 200-152-021

### B ADSON

Twist Drill, Hudson connection

Ø 2.0mm, 90mm 200-152-006

### E MCKENZIE

Twist Drill, Hudson connection

Ø 13mm, 95mm 200-152-007

### C D'ERRICO

Twist Drill, Hudson connection

Ø 16mm, 95mm 200-152-008

### F ADSON

Burr, Hudson connection

Ø 15mm, 95mm 200-152-012

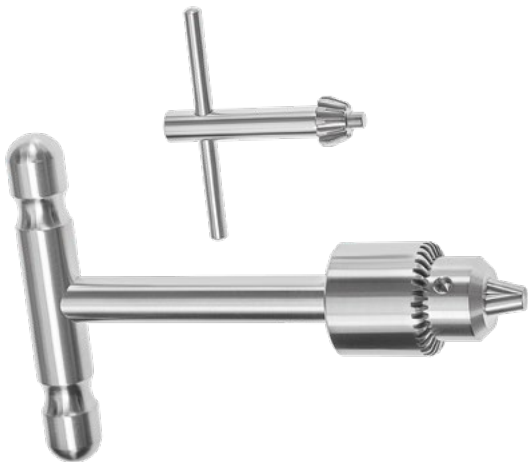

T-Handle, incl. key

Jacob Chuck

200-157-001



T-Handle Drill, 1.0 - 6.0mm, cannulated,  
Ø 5.2mm

Universal Chuck

200-157-100



T-Handle, 0.5 - 7.0mm, cannulated,  
Ø 5.2mm, incl. key

Roehm Chuck

200-157-200



T-Handle, 0.5 - 4.0mm, cannulated,  
 Ø 5.2mm, incl. key

Jacobs Chuck 200-157-210



T-Handle, 1.0 - 6.0mm, cannulated,  
 Ø 6.1mm, reverse lock

Universal Chuck 200-157-250

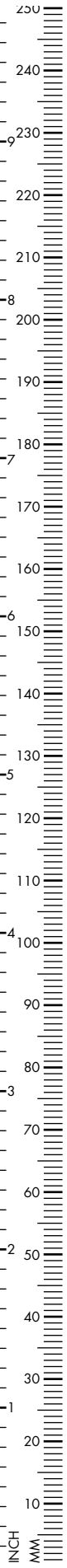

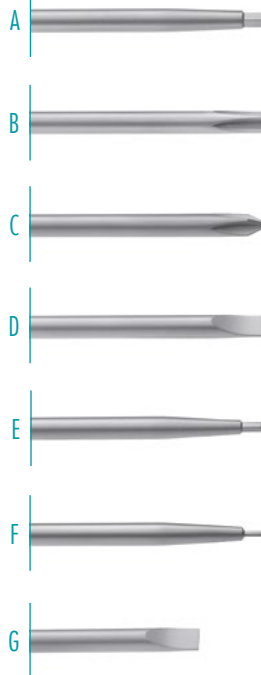

**A**  
Screw Driver, synthetic handle,  
hexagonal,  
for 2.7 - 3.5 - 4.0mm screws

250mm, 9 <sup>7/8</sup> "	200-604-235
200mm, 8"	200-604-275

**B**  
cross-slot, 6mm

250mm, 9 <sup>7/8</sup> "	200-601-250
---------------------------	-------------

**C**  
cross-slot, 6mm, for small Philips screws

250mm, 9 <sup>7/8</sup> "	200-600-200
---------------------------	-------------

**D**  
**LANE**  
flat, 6mm, for 2.7 - 3.5 - 4.0mm screws

250mm, 9 <sup>7/8</sup> "	200-604-250
---------------------------	-------------

**E**  
hexagonal, sw 2.5mm  
for 2.7 - 3.5 - 4.0mm screws

250mm, 9 <sup>7/8</sup> "	200-604-200
200mm, 8"	200-604-220

**F**  
hexagonal, sw 1.5mm  
for screw 1.5 - 2.0 - 2.4

250mm, 9 <sup>7/8</sup> "	200-608-200
---------------------------	-------------

**G**  
flat, 6mm, for 2.7 - 3.5 - 4.0mm screws

170mm, 6 <sup>2/3</sup> "	200-604-240
---------------------------	-------------



**Depth Gauge**

110mm, 4 <sup>1/3</sup> "	30mm screw	200-200-014
160mm, 6 <sup>1/4</sup> "	50mm screw	200-200-016
200mm, 8"	70mm screw	200-200-018
200mm, 8"	80mm screw	200-200-080
280mm, 11"	120mm screw	200-200-120



### Ruler, mm and inch markings

150mm, 6"	100-418-150
200mm, 8"	100-418-200
300mm, 11 <sup>7</sup> / <sub>8</sub> "	100-418-300
500mm, 19 <sup>2</sup> / <sub>3</sub> "	100-418-500



### Ruler, with holes for wires and pins

150mm, 6"	100-422-150
-----------	-------------



### Tape Measure, cm/inch, oil cloth

1500mm, 59"	100-425-150
-------------	-------------



### CASTROVIEJO

Caliper, measuring range 0 - 20mm  
locking screw

80mm, 3<sup>1</sup>/<sub>8</sub>" 400-583-007

Caliper, measuring range 0 - 40mm

180mm, 7" 400-583-008



### CARROLL

Finger Goniometer

140mm, 5<sup>1</sup>/<sub>2</sub>" 100-150-000



### TOWNLEY

Caliper, 0 - 100mm

100mm, 4" 100-152-000

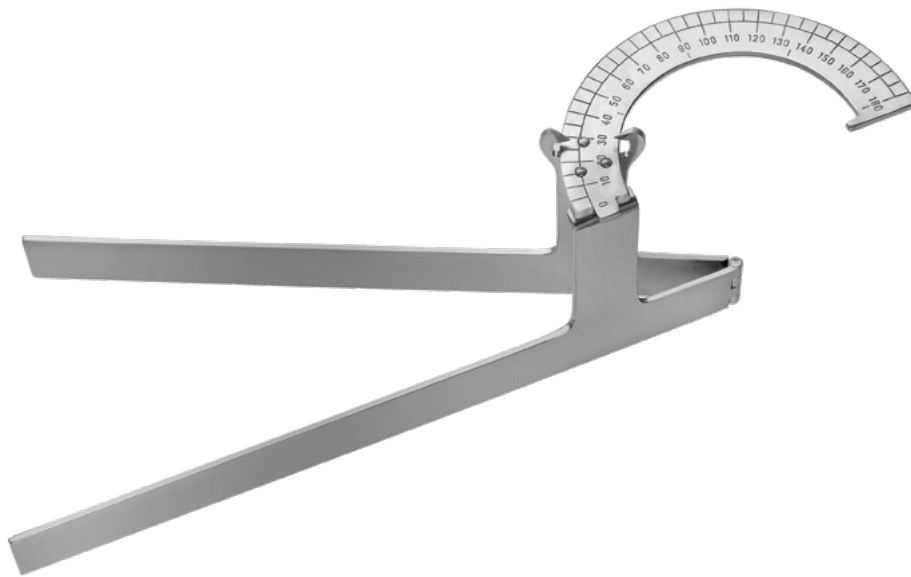

**MOELTGEN**  
Goniometer

100-412-000



Bone Caliper, angled, blunt, 140mm opening  
180mm, 7"

200-200-170



Bone Caliper, straight, pointed  
115mm opening

200-200-200

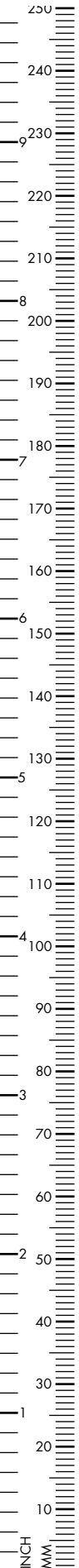



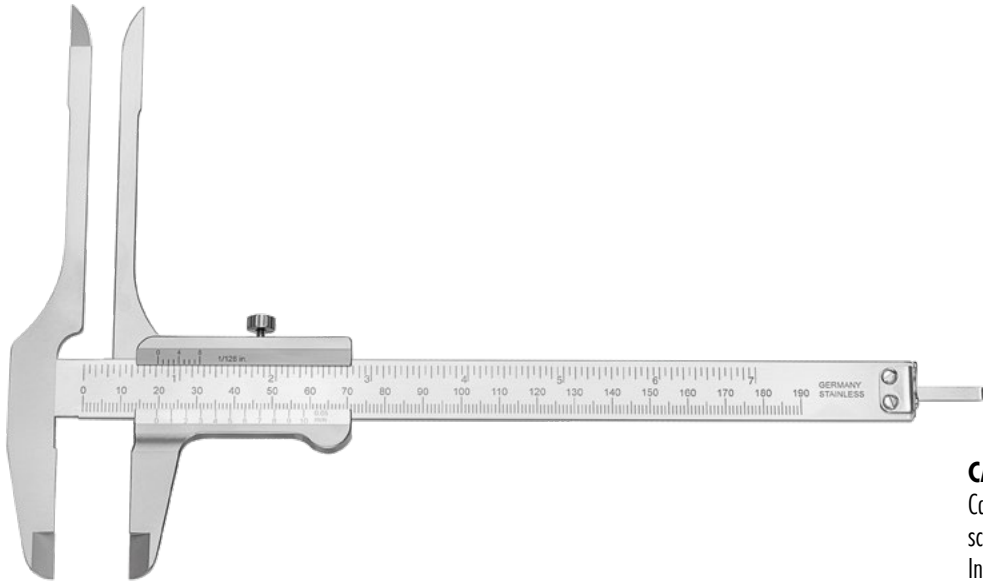

### CASPAR

Caliper for measuring bone craft

scale: mm, max. 180mm

Inside and outside measuring, faces & depth

259-185-885



Neuro-Caliper, 150mm range

211-550-235

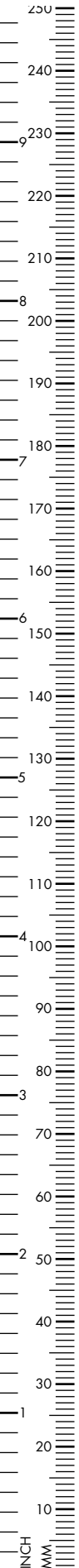

### COLLIN

Amputating Knife

130mm, 5 <sup>1</sup> / <sub>8</sub> "	110-014-013
160mm, 6 <sup>1</sup> / <sub>4</sub> "	110-014-016
190mm, 7 <sup>1</sup> / <sub>2</sub> "	110-014-019
220mm, 8 <sup>2</sup> / <sub>3</sub> "	110-014-022
280mm, 11"	110-014-028



### CATLIN

Amputating Knife, double cutting

160mm, 6 <sup>1</sup> / <sub>4</sub> "	110-018-016
190mm, 7 <sup>1</sup> / <sub>2</sub> "	110-018-019
220mm, 8 <sup>2</sup> / <sub>3</sub> "	110-018-022



### LANGENBECK

Resection Knife, 55mm blade

180mm, 7"	110-028-055
-----------	-------------

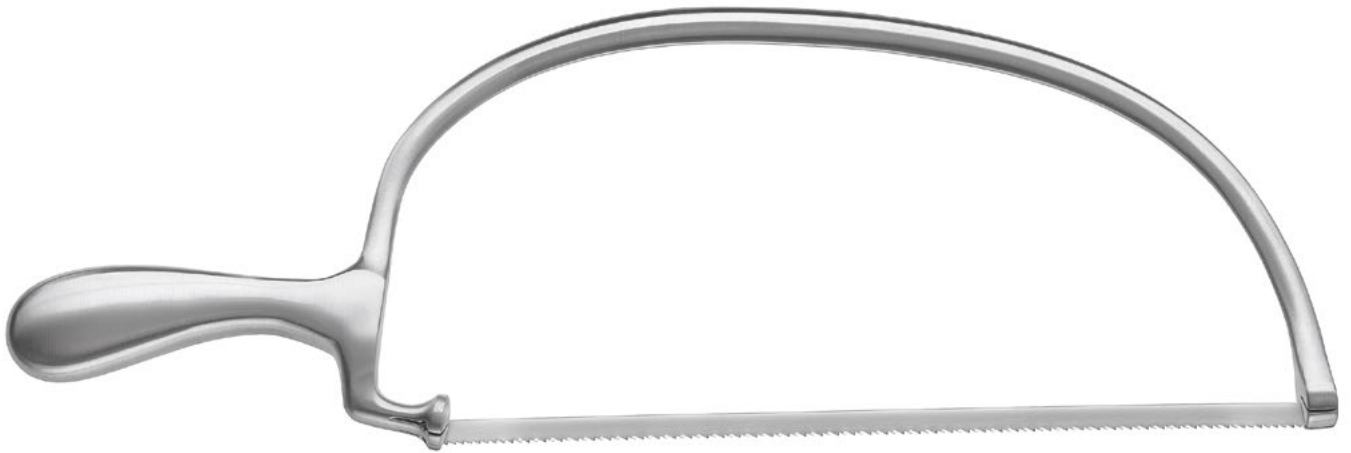

### HELFERICH BIER

Amputation Saw

390mm, 15 <sup>1</sup> / <sub>2</sub> "	200-103-390
---	-------------

Spare Blade

4mm	200-103-394
-----	-------------

6mm	200-103-396
-----	-------------

8mm	200-103-398
-----	-------------



### CHARRIÈRE

Amputation Saw

270mm, 10 <sup>2</sup> / <sub>3</sub> "	200-112-270
---	-------------

300mm, 11 <sup>7</sup> / <sub>8</sub> "	200-112-300
---	-------------



### LANGENBECK

Metacarpal Saw

230mm, 9"	200-110-230
-----------	-------------



**SATTERLEE**  
Amputation Saw

310mm, 12 <sup>1</sup> / <sub>4</sub> "	200-114-310
---	-------------



**CHARRIÈRE**  
Amputation Saw

350mm, 14"	200-101-350
------------	-------------



Spare Blade

12mm	200-101-012
------	-------------

15mm	200-101-015
------	-------------

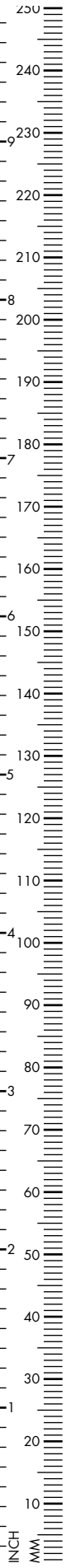

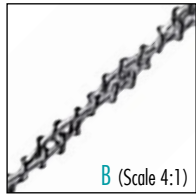
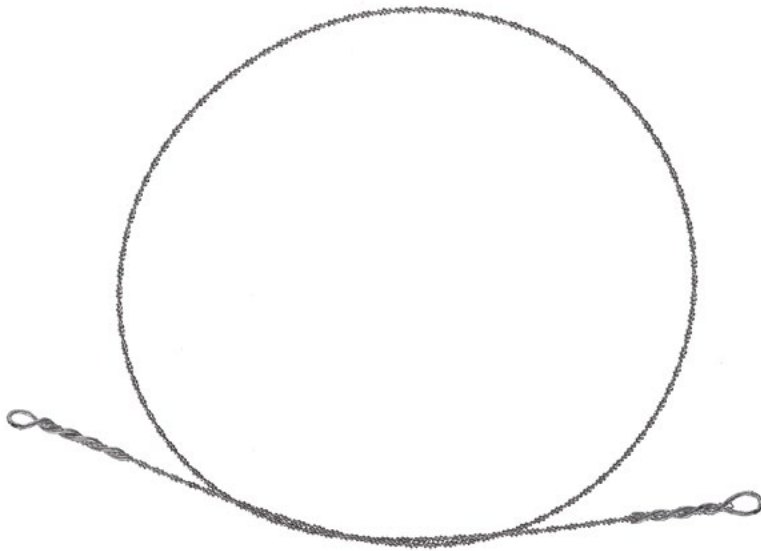

### OLIVECRONA

A Wire Saw,  $\varnothing$  1.2mm

250mm, 9 <sup>7</sup> / <sub>8</sub> "	290-100-250
300mm, 11 <sup>7</sup> / <sub>8</sub> "	290-100-300
400mm, 16"	290-100-400
500mm, 20"	290-100-500
600mm, 23 <sup>3</sup> / <sub>4</sub> "	290-100-600
700mm, 28"	290-100-700
760mm, 30"	290-100-760

### GIGLI

B Wire Saw,  $\varnothing$  1.4mm

300mm, 11 <sup>7</sup> / <sub>8</sub> "	290-101-300
400mm, 16"	290-101-400
500mm, 20"	290-101-500
600mm, 23 <sup>3</sup> / <sub>4</sub> "	290-101-600
700mm, 28"	290-101-700



### GIGLI

Handle for Wire Saw, 2 pcs.

290-102-000



### GIGLI

Handle, loop design, for Wire Saws

290-103-000



### DEMARTEL

Saw Conductor

305mm, 12"	290-118-305
330mm, 13"	290-118-330



### BAILEY

Saw Conductor, 305mm, 12"

curved	290-118-300
straight	290-118-301



**PERCY**  
Retractor for amputation,  
removable handles

200-100-000



**SWEET**  
Amputation Shield

200-100-002

