

ORTHOPAEDICS

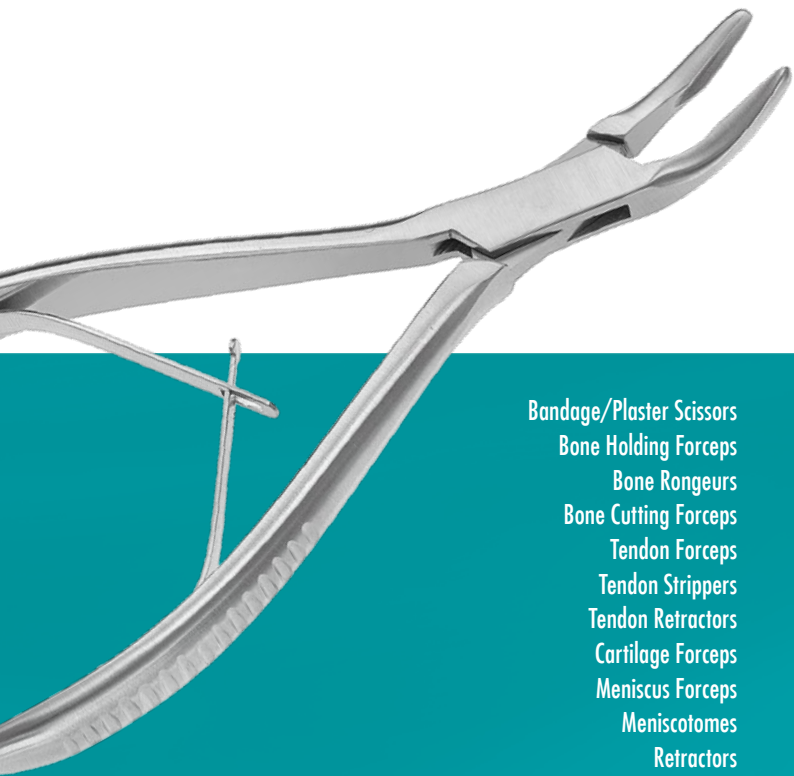

Bandage/Plaster Scissors
Bone Holding Forceps
Bone Rongeurs
Bone Cutting Forceps
Tendon Forceps
Tendon Strippers
Tendon Retractors
Cartilage Forceps
Meniscus Forceps
Meniscotomes
Retractors
Bone Levers
Elevators
Periosteal Elevators
Dissectors

Raspatories
Curettes
Osteotomes/Gouges/Chisels
Mallets
Bone Tampers
Rasps
Wire Instruments
Wire Cutters
Wire Guides
Wire Extension
Reamers, Trephines / Awls
Hand Drills
Screw Drivers
Rulers/Calipers
Amputation



LISTER

Plaster Cast / Bandage Scissors

90mm, 3 ¹ / ₂ "	190-165-090
110mm, 4 ¹ / ₃ "	190-165-110
140mm, 5 ¹ / ₂ "	190-165-140
180mm, 7"	190-165-180
200mm, 8"	190-165-200



TC LISTER

Bandage Scissors

180mm, 7"	190-291-180
-----------	-------------



LISTER EXCENTRIC

Plaster Cast / Bandage Scissors, serrated

160mm, 6 ¹ / ₄ "	190-177-160
190mm, 7 ¹ / ₂ "	190-177-190



BRUNS

Plaster Scissors, 240mm, 9¹/₂"

serrated blade	190-223-240
smooth blade	190-224-240

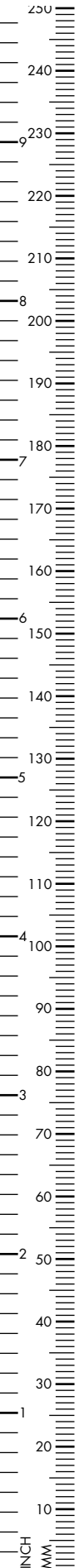



Cloth Scissors, serrated

200mm, 8"	190-211-200
-----------	-------------



BERGMANN
Plaster Scissors

230mm, 9"	190-195-230
-----------	-------------



ESMARCH
Plaster Scissors

200mm, 8"	190-205-200
220mm, 8 ^{2/3} "	190-205-220

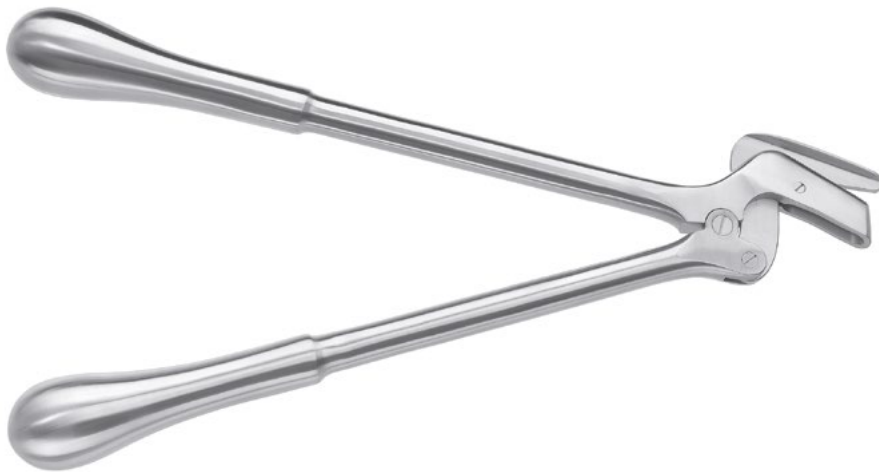

STILLE

Plaster Cast Scissors

260mm, 10¹/₄"

190-250-260

370mm, 14¹/₂"

190-250-370



WALTON

Plaster Cast Spreader, single hand model

230mm, 9"

190-522-230



HENNING

Plaster Spreader

280mm, 11"

190-516-280



WOLFF BOEHLER

Plaster Cast Breaker

180mm, 7"

190-530-180

240mm, 9¹/₂"

190-530-240

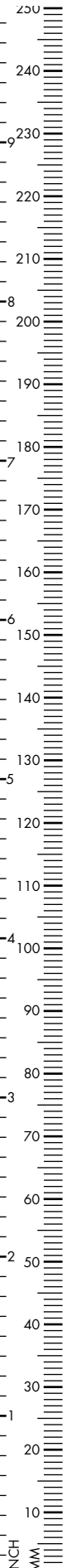



UNIVERSAL

Plaster and cloth scissors, small,
140mm, 5 1/2"

black	190-209-151
red	190-209-152
yellow	190-209-153
green	190-209-154



UNIVERSAL

Plaster and cloth scissors, big,
180mm, 7"

blue	190-209-180
black	190-209-181
red	190-209-182
yellow	190-209-183
green	190-209-184
orange	190-209-185





Plaster Saw, incl. round saw blade 65mm,
50mm, pair of wrenches, hexagonal key

230V (black) 200-115-100

110V (blue) 200-115-101



Carry Case with foam inlay

230V 200-115-500



Spare Blade, plaster

Ø 45mm 200-115-145

Ø 50mm 200-115-150

Ø 65mm 200-115-165

Synthetic Cast

Ø 45mm 200-116-145

Ø 50mm 200-116-150

Ø 65mm 200-116-165

PTFE coated (non-stick)

Ø 50mm 200-117-150

Ø 65mm 200-117-165



Vacuum Cleaner

230V 200-118-100



Bone Reposition Forceps

95mm, 3³/₄"

210-651-095



STAGBETLE

Bone Reposition Forceps, curved fine tip,
for small fragments

120mm, 4³/₄"

210-651-120



STEINHAUSER

Bone Reposition Forceps,
extra long ratchet

135mm, 5¹/₃"

210-651-135

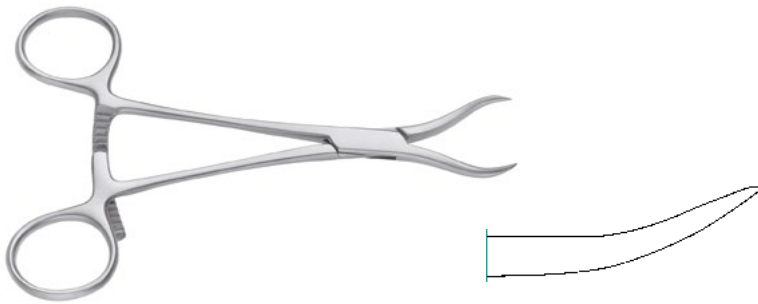

Bone Reposition Forceps
for maxillary reposition

135mm, 5¹/₃" 210-651-130

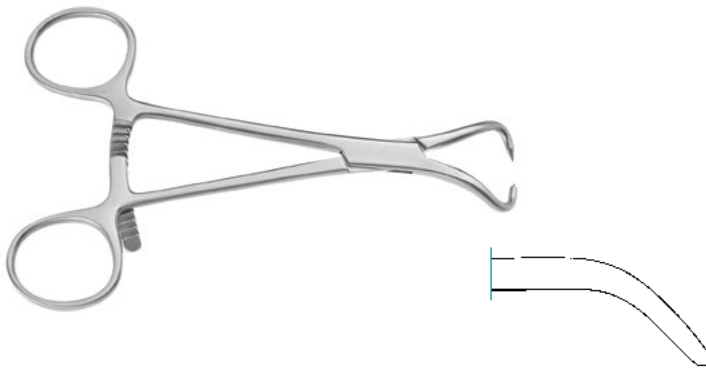

Bone Reduction Forceps, curved,
stepped point

135mm, 5¹/₃" 210-665-135

170mm, 6²/₃" 210-665-170



HAASE
Reposition Forceps

165mm, 6¹/₂" 210-251-165

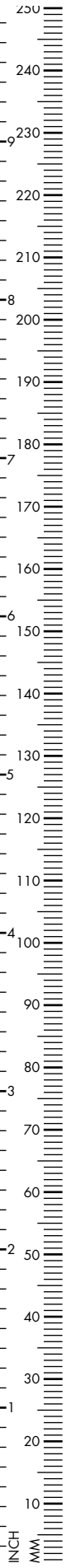



REILL

Reposition Forceps

170mm, 6²/₃"

210-649-170

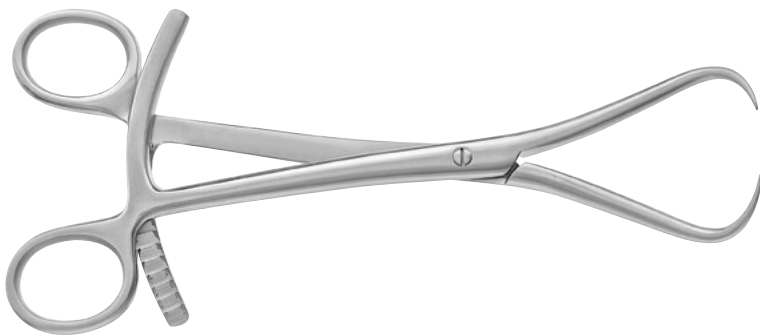

Reposition Forceps

200mm, 8"

210-651-200

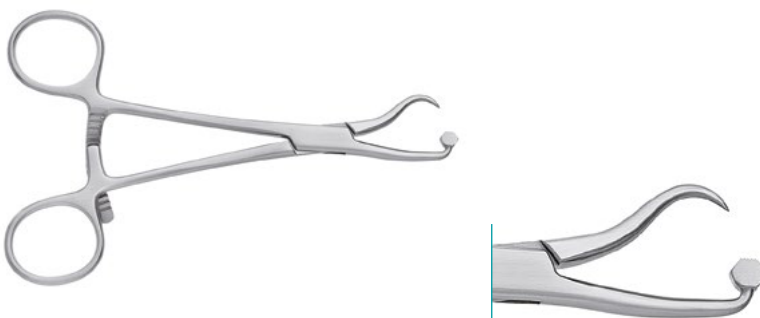

Bone Fragment Clamp

120mm, 4³/₄"

210-631-120

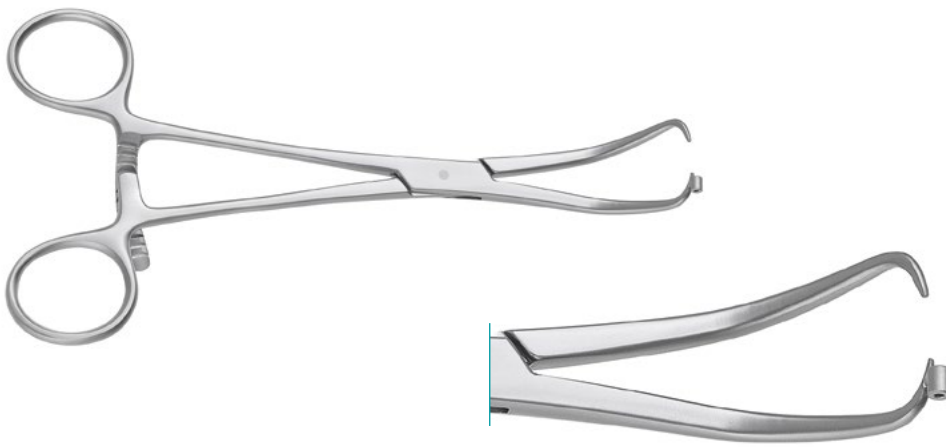

MEYER

Reposition Forceps for Finger,
with drill guide

170mm, 6 ² / ₃ "	210-650-170
200mm, 8"	210-650-200

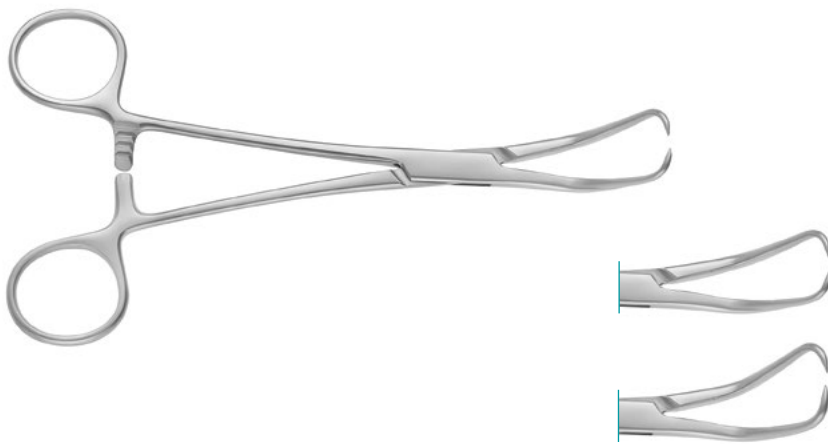

BANKART

Perforating Forceps, 170mm, 6²/₃"

slightly curved	259-900-000
strongly curved	259-900-001

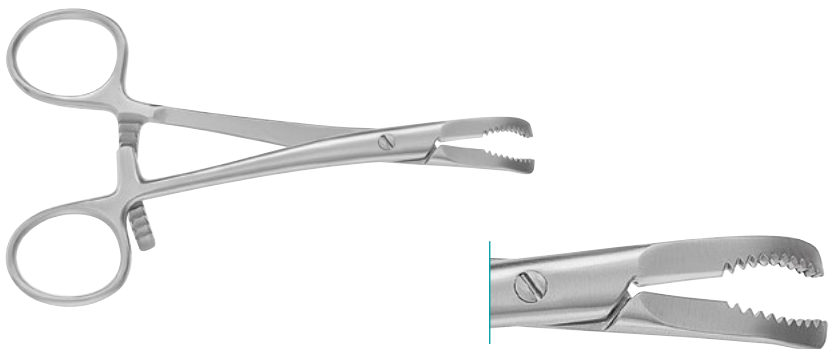

Reposition Forceps

140mm, 5 ¹ / ₂ "	210-718-140
--	-------------

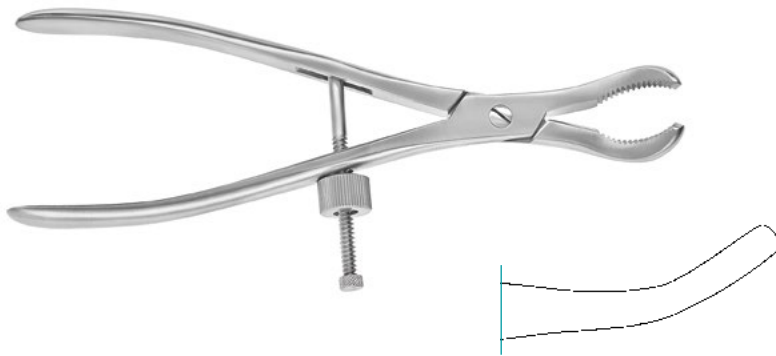

SETTER

Bone Holding Forceps, curved, speed lock

160mm, 6 ¹ / ₄ "	210-719-160
225mm, 8 ⁷ / ₈ "	210-719-220

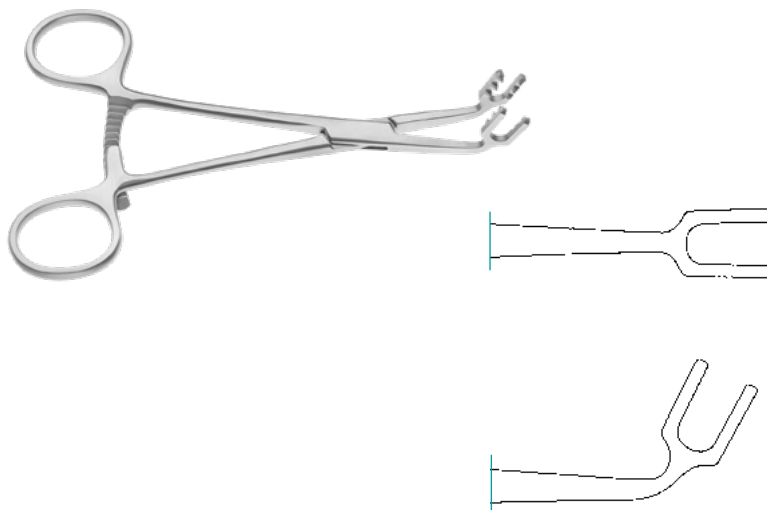

IKUTA

Bone Clamp, 8 pointed teeth jaw,
140mm, 5¹/₂", straight

5mm space opening	210-654-005
8mm space opening	210-654-008

160mm, 6¹/₄", straight

10mm space opening	210-654-010
--------------------	-------------

curved

5mm space opening	210-655-005
-------------------	-------------

8mm space opening	210-655-008
-------------------	-------------

160mm, 6¹/₄", curved

10mm space opening	210-655-010
--------------------	-------------



LEWIN

Bone Holding Forceps, serrated, slightly curved

180mm, 7"

210-618-175



Patella Holding Forceps, 2x2 sharp teeth

185mm, 7^{1/4}"

210-654-185

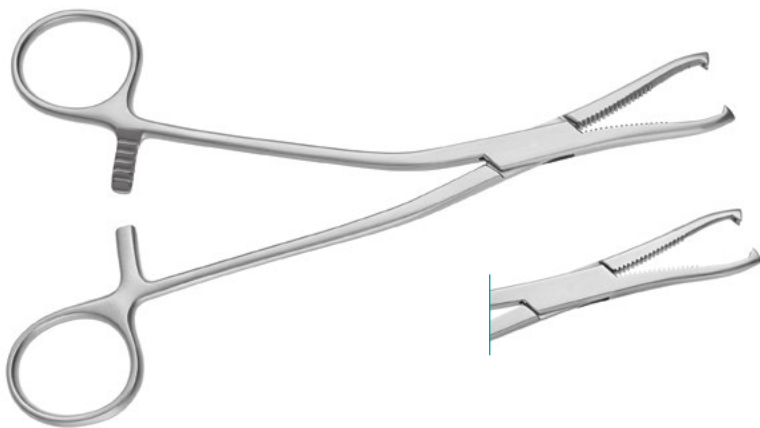
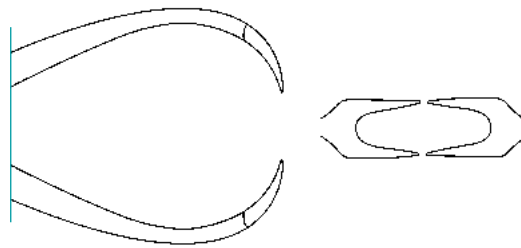

DINGMANN

Bone Holding Forceps, delicate pattern

190mm, 7^{1/2}"

210-625-190

heavy pattern

190mm, 7^{1/2}"

210-626-190

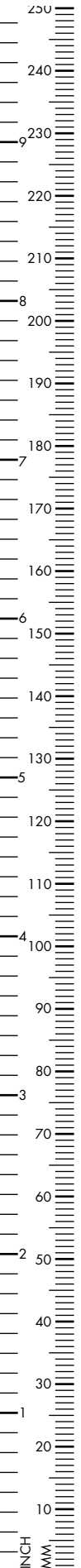

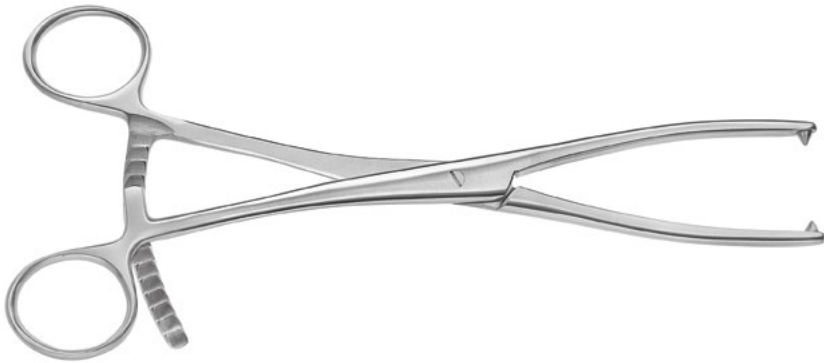

MEYER

Malleolar Reposition Forceps

210mm, 8^{1/4}"

210-656-210



Bone Holding Forceps

200mm, 8"

210-657-200



FROSCH

Bone Holding Forceps

180mm, 7"

210-726-180

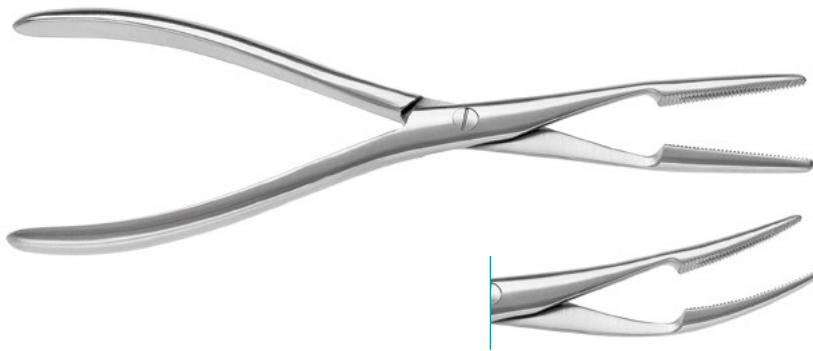

Sequestrum Forceps, 200mm, 8"

Straight 210-610-200

Curved 210-611-200



VAN BUREN

Sequestrum Forceps, curved

230mm, 9" 210-615-230



LANGENBECK

Bone Holding Forceps, 11mm wide

210mm, 8¹/₄" 210-722-210



FERGUSON

Bone Holding Forceps, 12mm wide

210mm, 8¹/₄" 210-724-210



SEM B

Bone Holding Forceps, laterally curved
with ratchet

190mm, 7 ¹ / ₂ "	210-624-190
--	-------------

without ratchet

190mm, 7 ¹ / ₂ "	210-623-190
--	-------------



FARABEU F

Bone Holding Forceps

230mm, 9"	210-630-230
-----------	-------------

260mm, 10 ¹ / ₄ "	210-630-260
---	-------------



FARABEU LAMBOTTE

Bone Holding Forceps, with ratchet

260mm, 10 ¹ / ₄ "	210-634-260
---	-------------

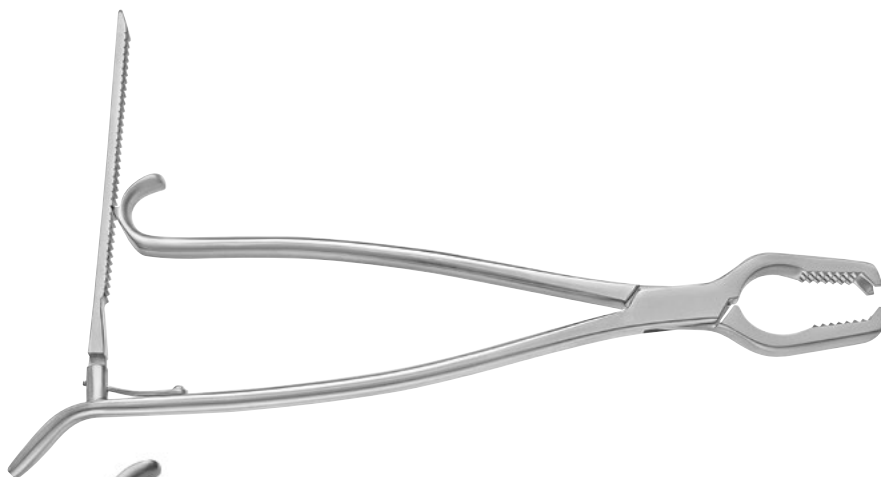
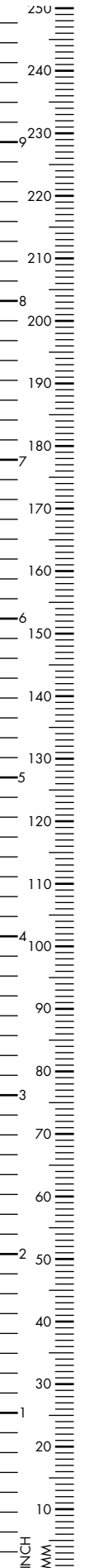

KERN

Bone Holding Forceps, with ratchet

170mm, 6²/₃" 210-621-170

240mm, 9¹/₂" 210-621-210

without ratchet

170mm, 6²/₃" 210-620-170

240mm, 9¹/₂" 210-620-210

LANE

Bone Holding Forceps, with ratchet

330mm, 13" 210-612-330

450mm, 17³/₄" 210-612-450

without ratchet

330mm, 13" 210-610-330

450mm, 17³/₄" 210-610-450



VERBRUGGE

Bone Holding Forceps

175mm, 6 ⁷ / ₈ "	210-605-170
250mm, 9 ⁷ / ₈ "	210-605-250
260mm, 10 ¹ / ₄ "	210-605-260
270mm, 10 ² / ₃ "	210-605-270



Bone Holding Forceps, self-centering

150mm, 6"	210-603-150
190mm, 7 ¹ / ₂ "	210-603-190
240mm, 9 ¹ / ₂ "	210-603-240
260mm, 10 ¹ / ₄ "	210-603-260
280mm, 11"	210-603-280



LAMBOTTE

Bone Holding Forceps, movable jaw

220mm, 8 ² / ₃ ", 10mm jaw width	210-640-220
260mm, 10 ¹ / ₄ " 13mm jaw width	210-640-270
330mm, 11 ⁷ / ₈ " 16mm jaw width	210-640-300



HEY GROVE

Bone Holding Forceps

210mm, 8 ¹ / ₄ "	210-600-230
245mm, 9 ² / ₃ "	210-600-250
270mm, 10 ² / ₃ "	210-600-270
300mm, 11 ⁷ / ₈ "	210-600-300



ULRICH

Bone Holding Forceps, straight

190mm, 7 ¹ / ₂ " Fig. 0	210-602-190
230mm, 9" Fig. 1	210-602-230
250mm, 9 ⁷ / ₈ " Fig. 2	210-602-250
280mm, 11" Fig. 3	210-602-280



ULRICH

Bone Holding Forceps, laterally angled

190mm, 7 ¹ / ₂ " Fig. 0	210-601-190
230mm, 9" Fig. 1	210-601-230
250mm, 9 ⁷ / ₈ " Fig. 2	210-601-250
280mm, 11" Fig. 3	210-601-280

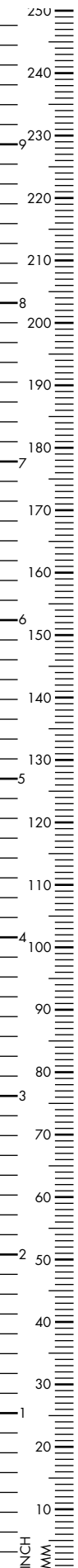



LOWMAN

Bone Holding Clamp, 1x2 teeth

130mm, 5 ¹ / ₈ "	210-980-130
185mm, 7 ¹ / ₄ "	210-980-185
200mm, 8"	210-980-200

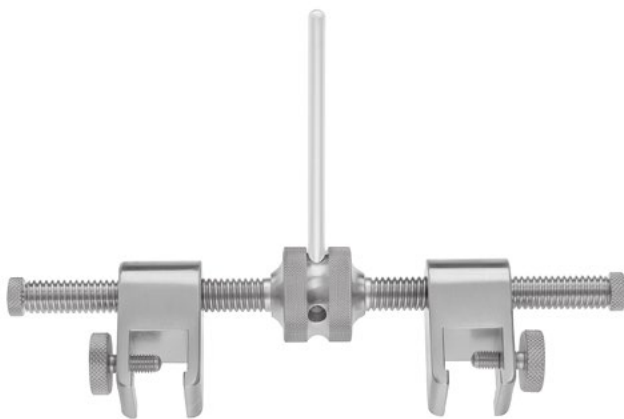

GERSTER

Traction Bar, max. Ø 25mm

160mm, 6 ¹ / ₄ "	210-981-150
--	-------------

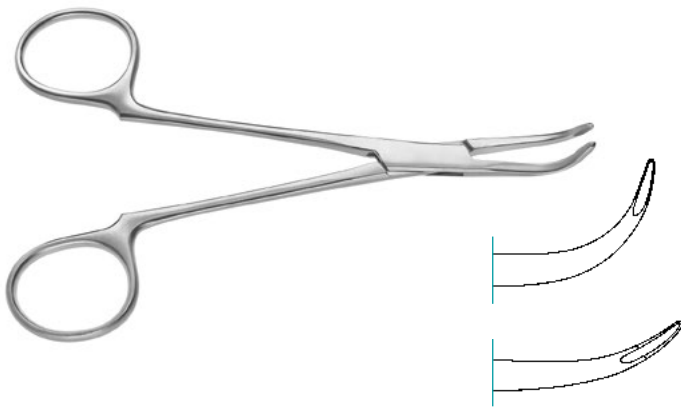
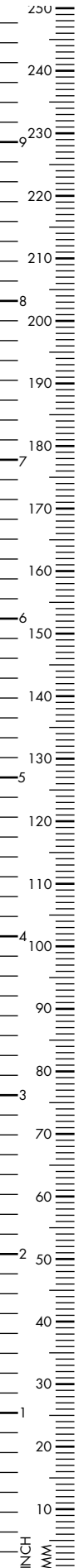

Synovectomy Rongeur, 1.2mm wide jaw
130mm, 5^{1/8}"

Strongly curved 210-773-130

Slightly curved 210-774-130

2.0mm wide jaw

Strongly curved 210-775-130

Slightly curved 210-776-130



FRIEDMANN

Bone Rongeur, 90°, curved

140mm, 5^{1/2}" 210-642-120

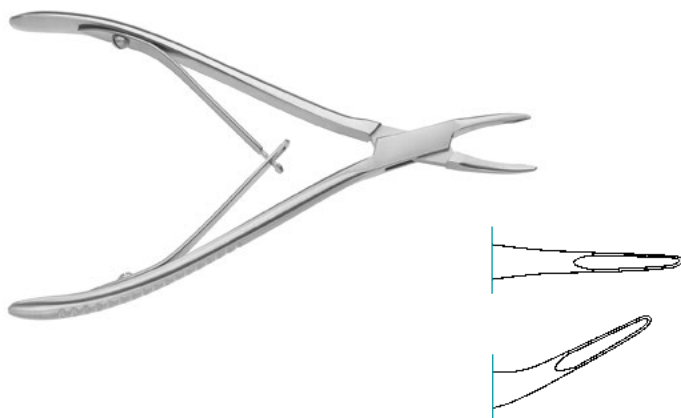

MINI FRIEDMANN

Bone Rongeur, 1.1mm delicate jaw
140mm, 5^{1/2}"

Straight 210-640-150

Curved 210-641-150

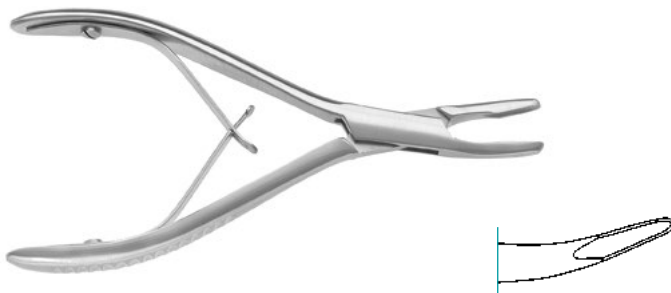

FRIEDMANN

Bone Rongeur, 140mm, 5¹/₂"

Curved	210-640-140
--------	-------------

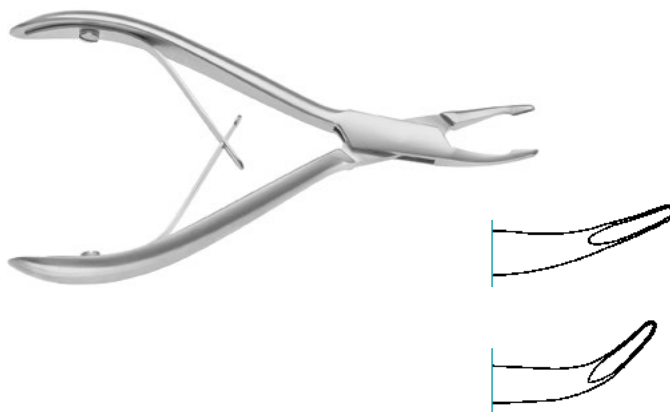

KLEINERT KUTZ

Bone Rongeur, 2mm jaw,
140mm, 5¹/₂"

Slightly curved	210-642-140
-----------------	-------------

Strongly curved	210-643-140
-----------------	-------------

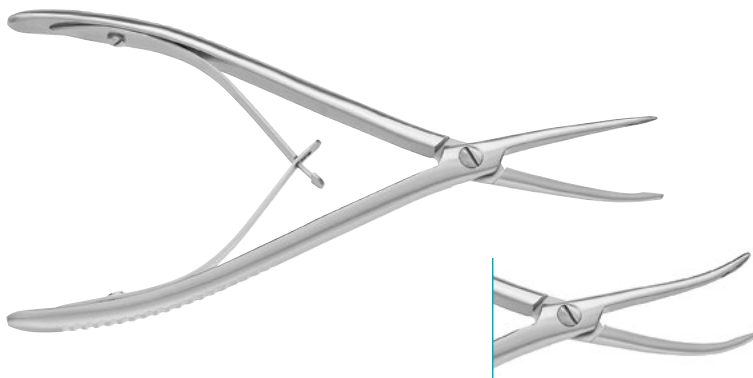

STELLBRINK

Synovectomy Rongeur, 2mm jaw,
170mm, 6²/₃"

Slightly curved	210-777-001
-----------------	-------------

Strongly curved	210-777-002
-----------------	-------------

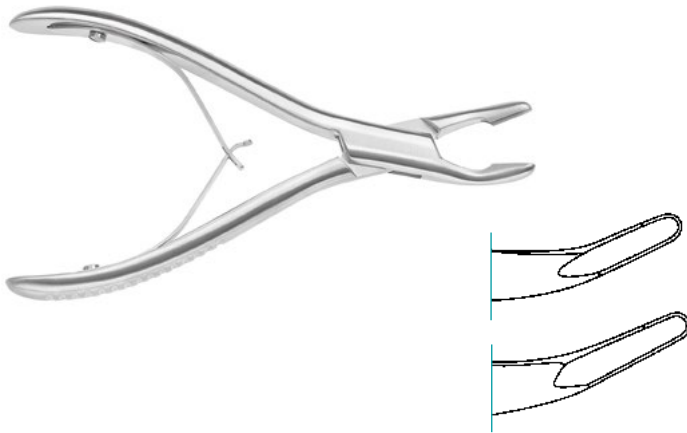
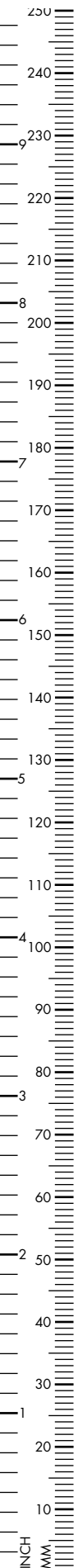

MEAD CLEVELAND

Bone Rongeur

#4 (Mead)	210-805-140
140mm, 5 ¹ / ₂ "	
#4A (Cleveland)	210-805-170
170mm, 6 ² / ₃ "	

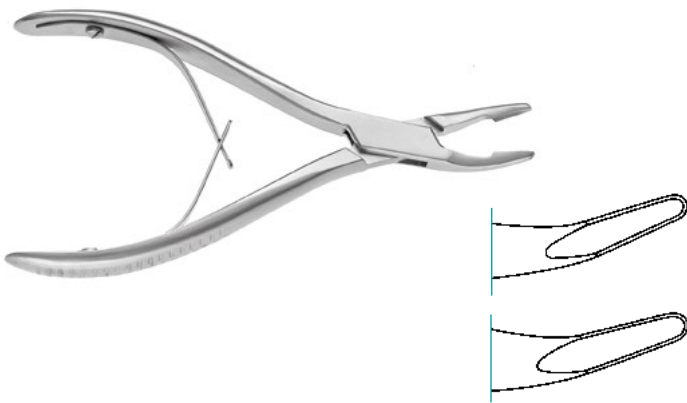

MEAD

Bone Rongeur

#1, 140mm, 5 ¹ / ₂ "	210-815-140
#1A, 170mm, 6 ² / ₃ "	210-815-165

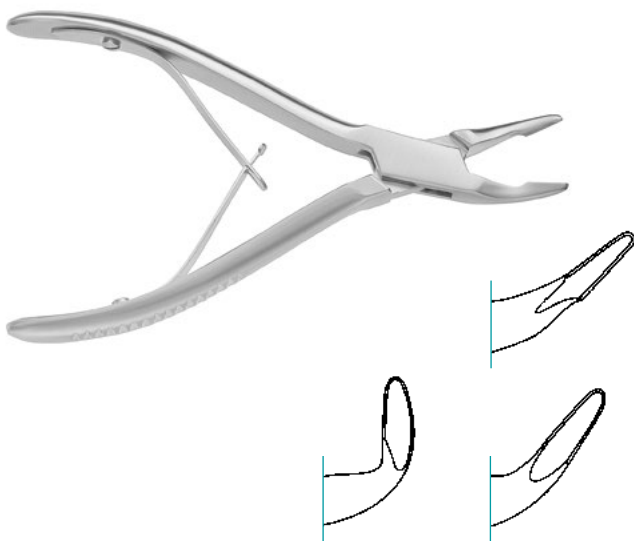

BLUMENTHAL

Bone Rongeur, 155mm, 6¹/₈"

30°	210-691-150
45°	210-693-150
90°	210-695-150



HARTMANN

Bone Rongeur

160mm, 6^{1/4}"

210-819-180

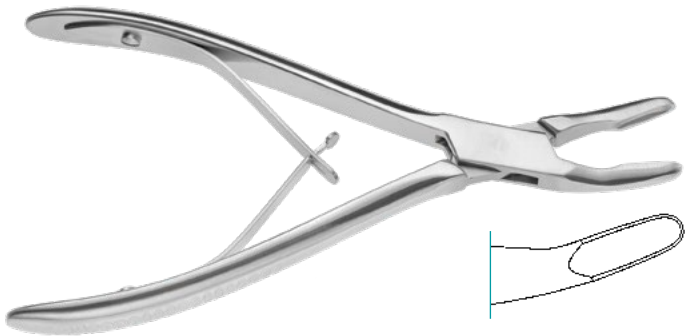

BANE

Bone Rongeur

180mm, 7"

210-787-180

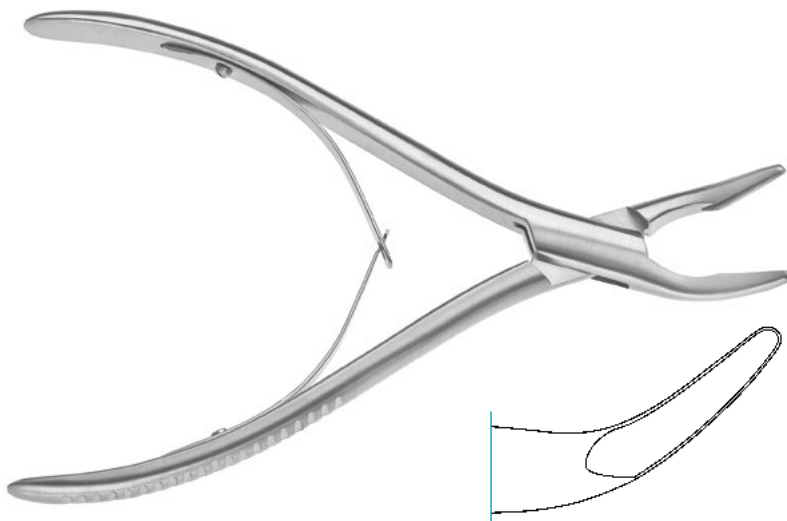

OLIVECRONA

Bone Rongeur

200mm, 8"

210-470-205

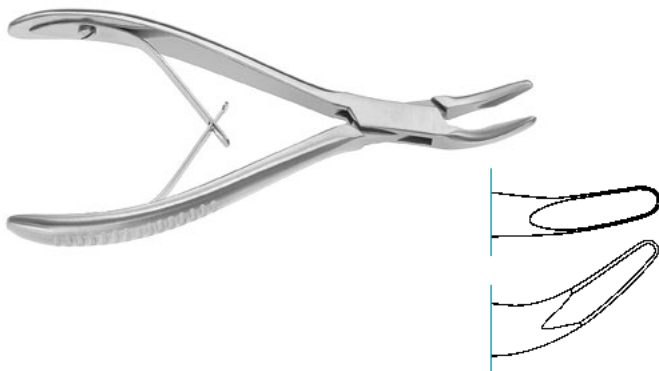
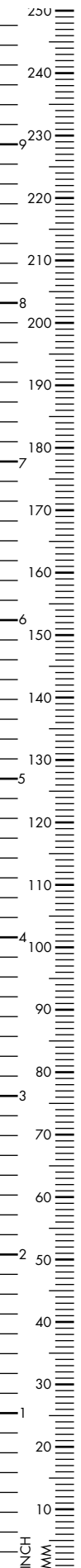

LUER

Bone Rongeur, 140mm, 5¹/₂"

Slightly curved 210-685-150

Strongly curved 210-687-150

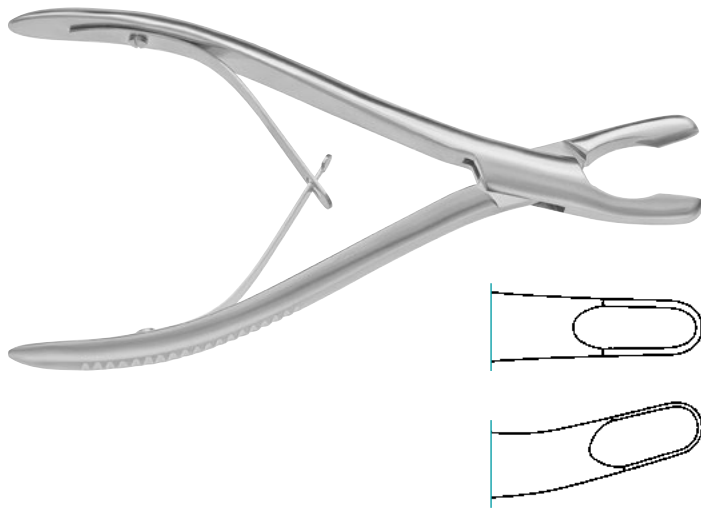

LUER

Bone Rongeur, 170mm, 6²/₃"

Straight 210-846-170

Curved 210-847-170

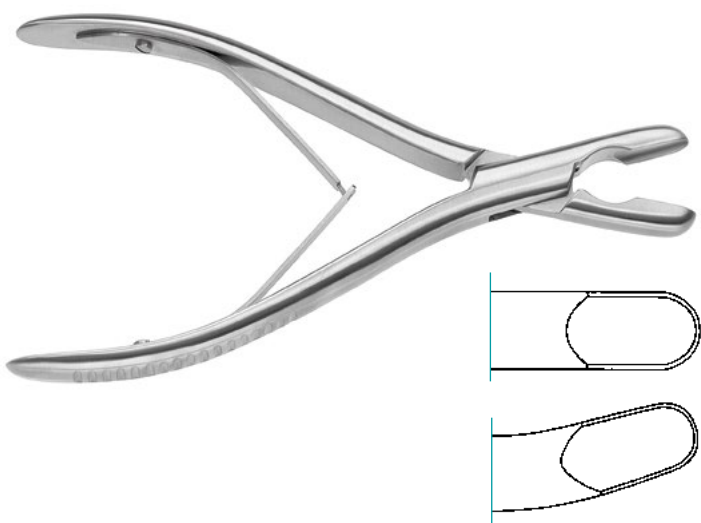

LUER

Bone Rongeur, 180mm, 7"

Straight 210-862-180

Curved 210-863-180

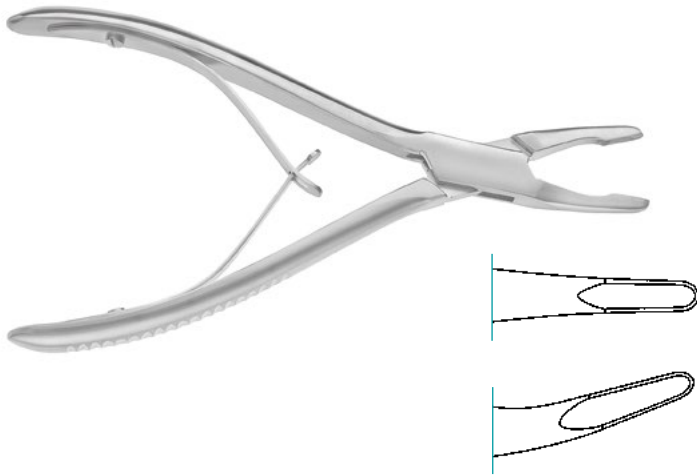

JANSEN

Bone Rongeur, 170mm, 6²/₃"

Straight 210-826-180

Curved 210-829-180

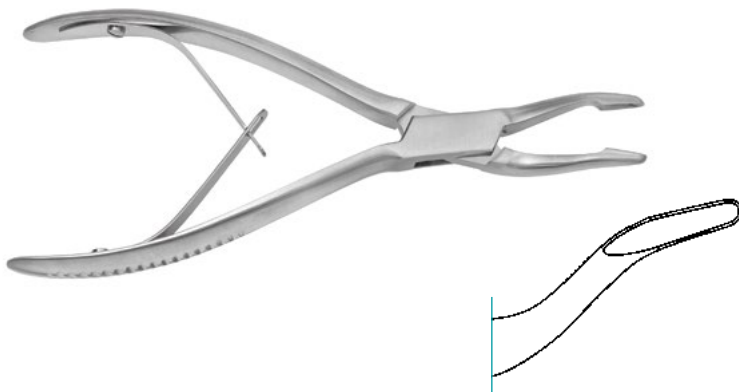

JANSEN

Bone Rongeur, s-shaped

170mm, 6²/₃" 210-829-170

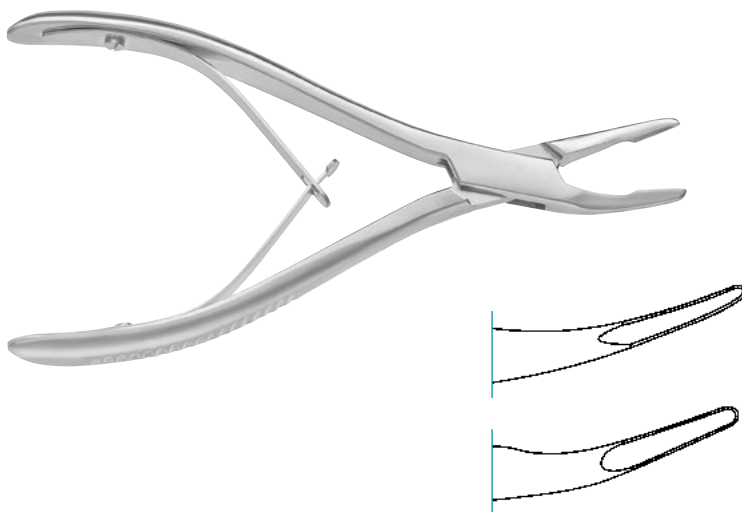

BEYER

Bone Rongeur, 3x16mm, 180mm, 7"

Curved 210-830-180

Strongly Curved 210-831-180

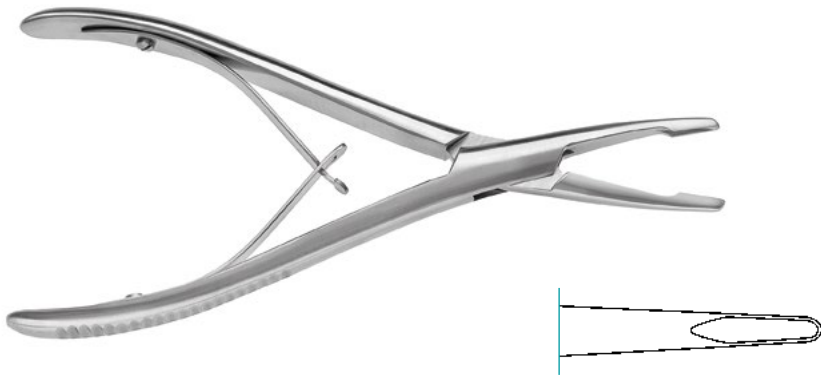

DEFOURMENTEL

Bone Rongeur, 3mm jaw

190mm, 7¹/₂"

210-772-190

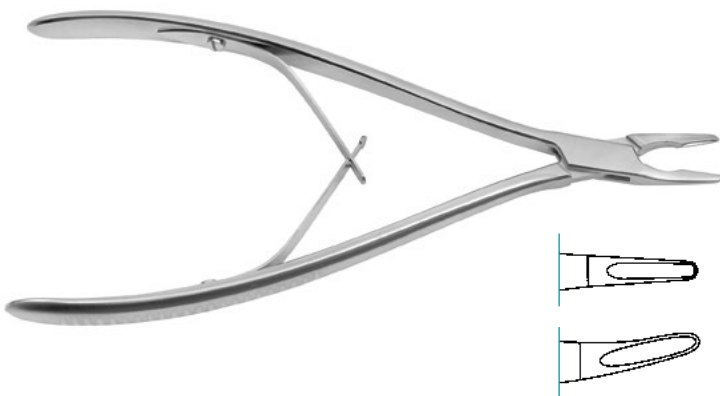

LEMPERT

Bone Rongeur, 190mm, 7¹/₂"

Straight

210-832-185

Curved

210-833-185

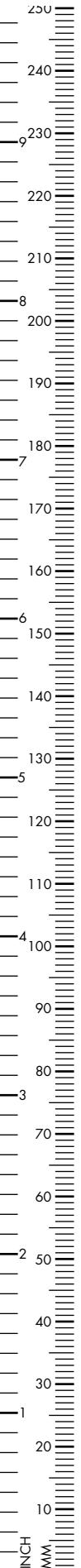

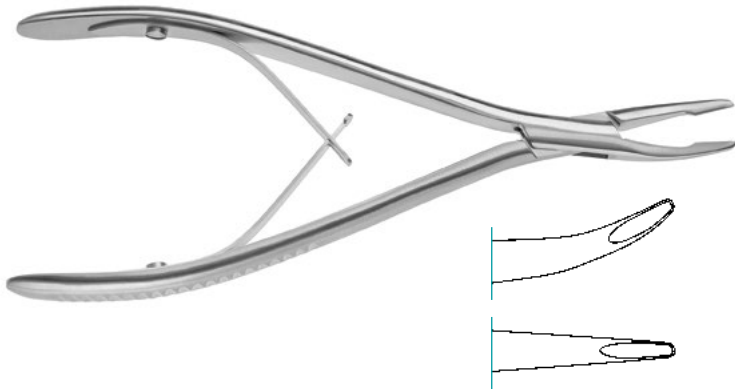

LEMPERT

Bone Rongeur, curved

160mm, 6¹/₄" 210-771-160

straight

160mm, 6¹/₄" 210-770-160



PENNYBACKER

Bone Rongeur, 4mm jaw

200mm, 8" 210-794-200

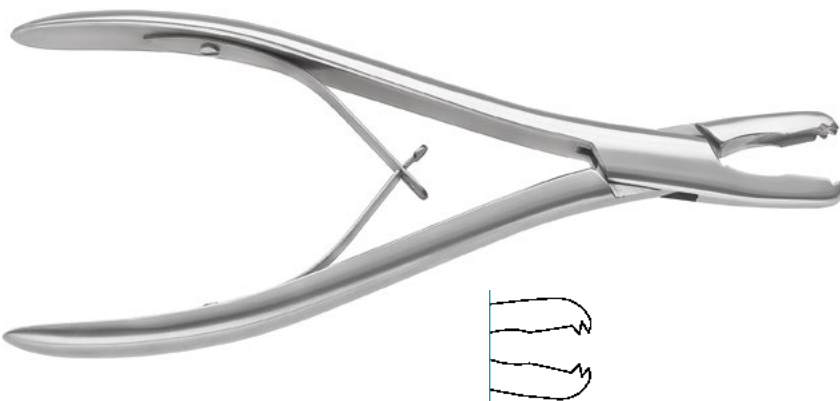

Bone Rongeur, Rat toothed, 3x3 teeth

210, 8¹/₄" 210-781-210

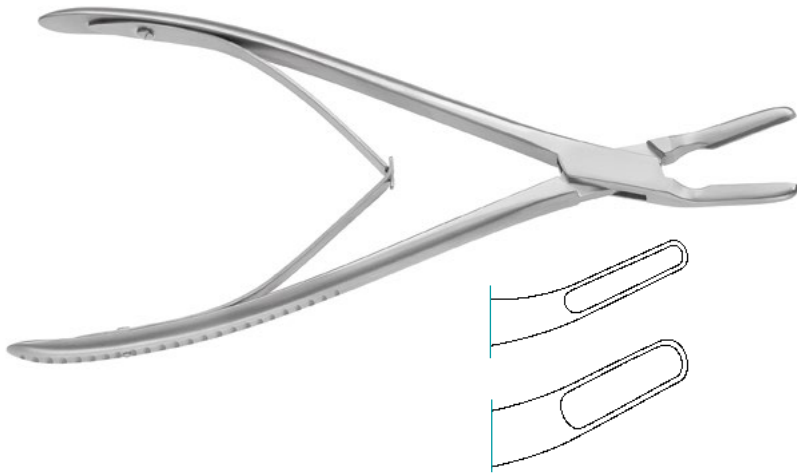

ZIELKE

Bone Rongeur, 210mm, 8¹/₄"

3mm jaw 210-730-003

5mm jaw 210-730-005

250mm, 9⁷/₈"

3mm jaw 210-731-003

5mm jaw 210-731-005

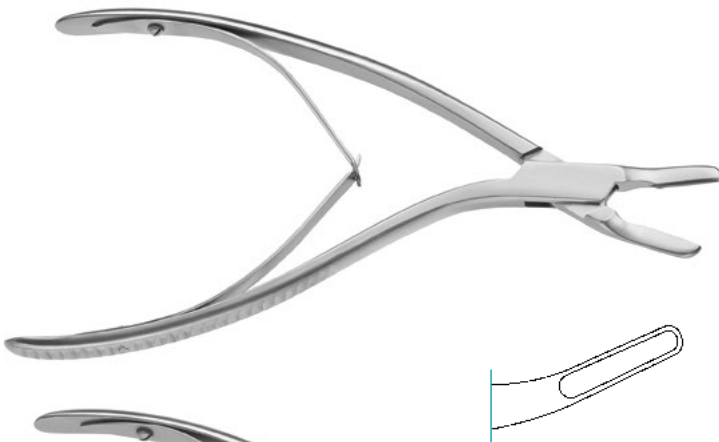

ZIELKE

Bone Rongeur, 3mm jaw,
shanks curved right

190mm, 7¹/₂" 210-732-002

shanks curved left

190mm, 7¹/₂" 210-733-003

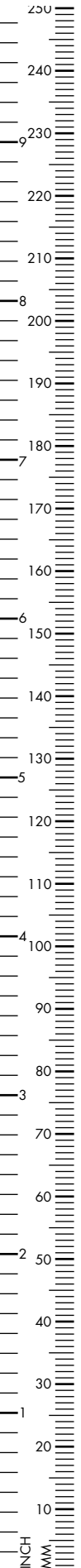
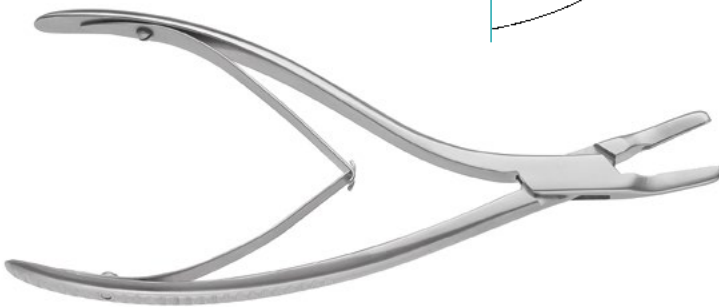

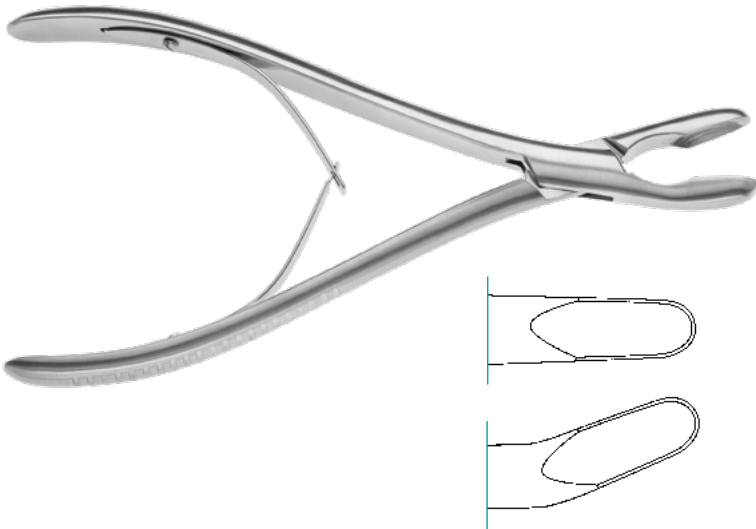

ADSON

Bone Rongeur, 200mm, 8"

Straight	210-845-200
Curved	210-846-200

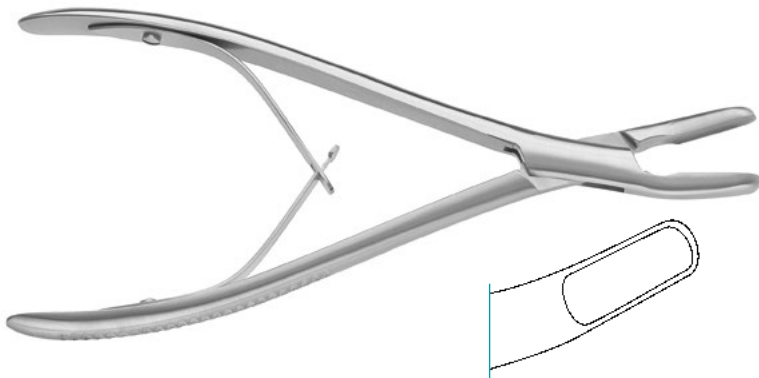

MATZEN

Intervertebral Bone Rongeur, 8mm jaw

200mm, 8"	210-732-200
-----------	-------------

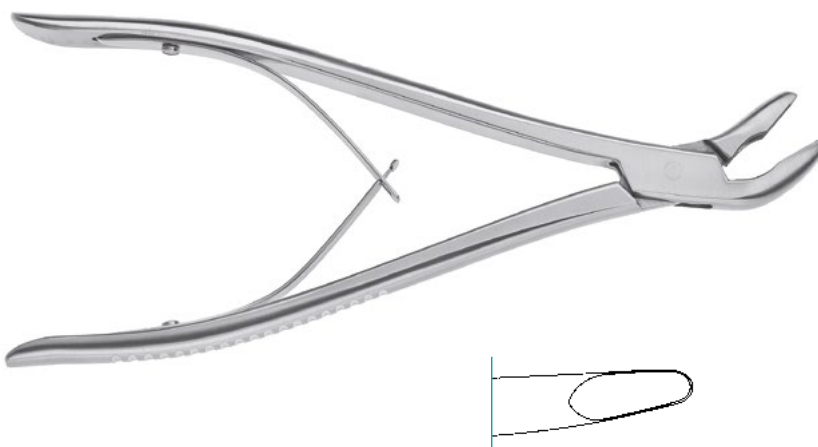

BACON

Bone Rongeur, angled jaw

200mm, 8"	210-795-195
-----------	-------------

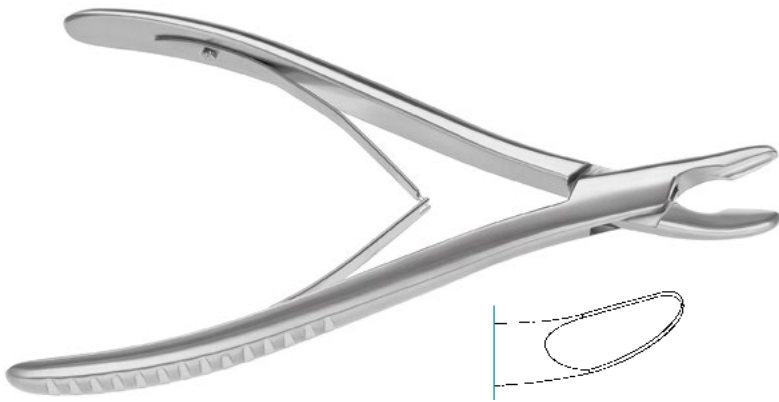
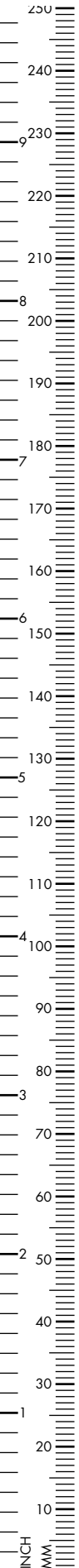

GULEKE

Bone Rongeur, curved

205mm, 8^{1/8}"

210-847-205



HAKANSSON

Bone Rongeur, curved laterally

160mm, 6^{1/4}"

210-825-160



TROTTER

Bone Rongeur, angled laterally

200mm, 8"

210-839-200

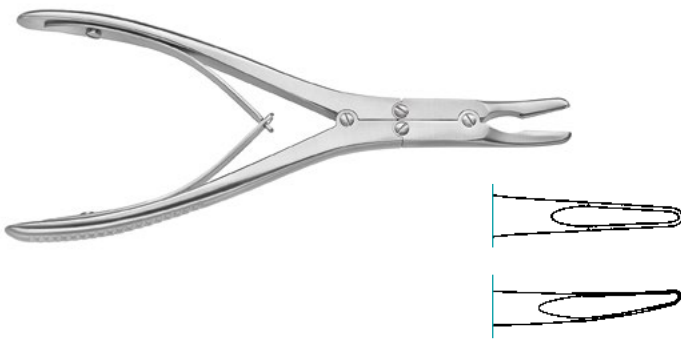

MINI RUSKIN

Bone Rongeur, 2mm, 150mm, 6"

Straight	210-802-150
Curved	210-812-150

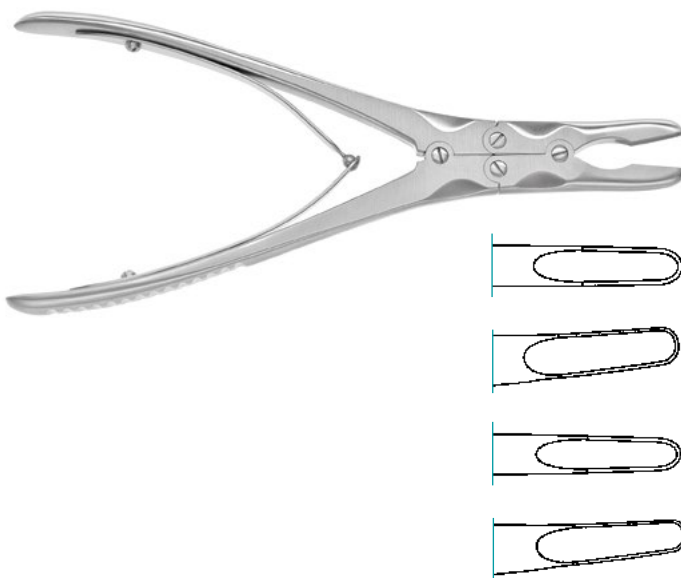

RUSKIN

Bone Rongeur, 5mm, 180mm, 7"

Straight	210-800-180
Curved	210-801-180

4mm

Straight	210-802-180
Curved	210-803-180

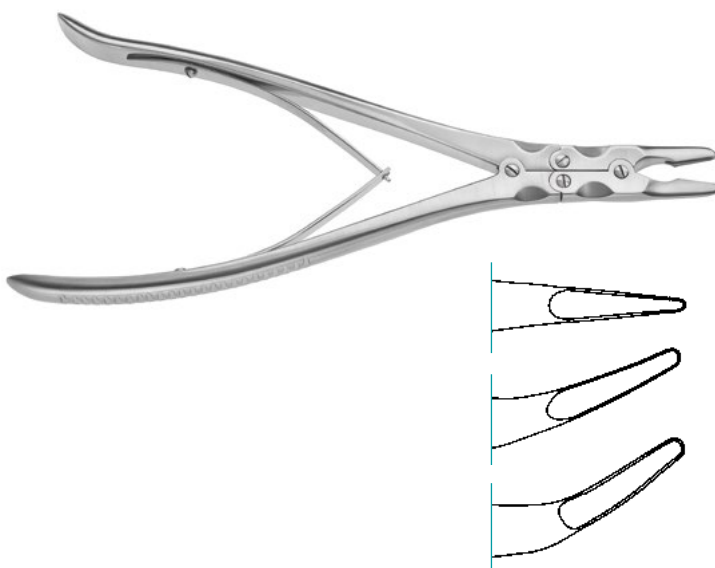

SMITH PETERSEN

Bone Rongeur, 3mm jaw, 190mm, 7¹/₂"

Straight	210-832-190
Slightly Curved	210-834-190
Strongly Curved	210-836-190

4mm jaw

Straight	210-832-194
Slightly Curved	210-834-194
Strongly Curved	210-836-194

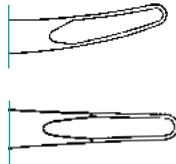
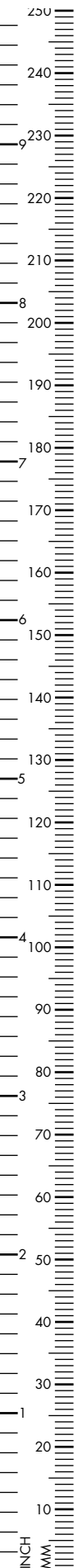

BOEHLER

Bone Rongeur, curved, 150mm, 6"

3mm jaw 210-789-150

straight

3mm jaw 210-788-150

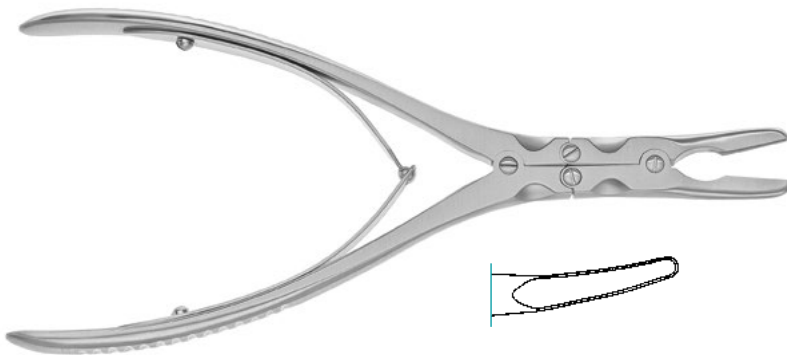

MARQUARDT

Bone Rongeur, curved, 3mm

200mm, 8" 210-780-200



BEYER

Bone Rongeur, curved,
180mm, 7"

3mm 210-789-180

4mm 210-790-180



ZAUFAL JANSEN

Bone Rongeur, curved, 5mm jaw

180mm, 7" 210-791-180

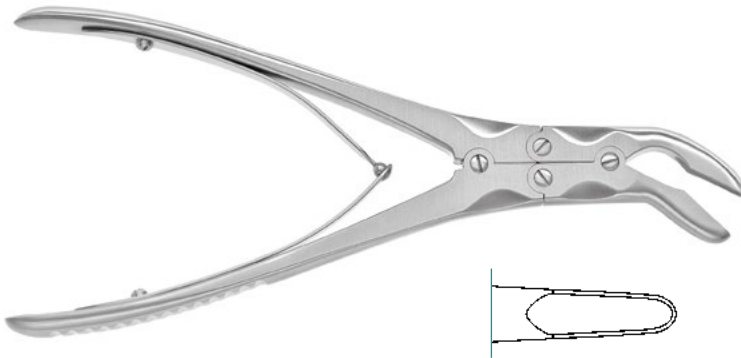

RUSKIN

Bone Rongeur, angled laterally

180mm, 7"

210-805-180

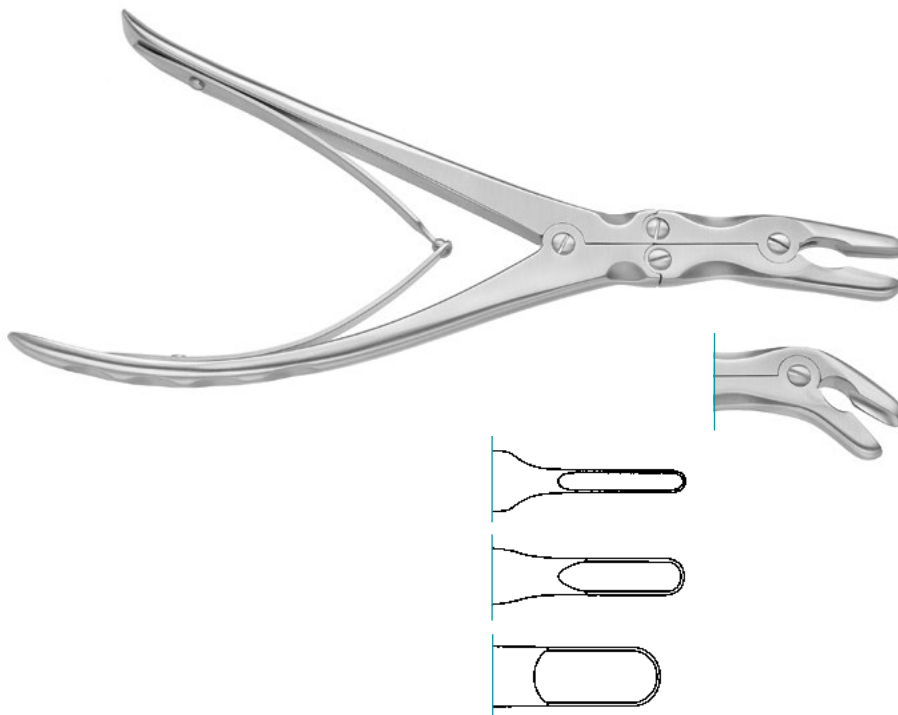

LEKSELL STILLE

Bone Rongeur, curved laterally, 240mm, 9¹/₂"

3mm

210-843-240

5mm

210-851-240

8mm

210-850-240

curved strongly laterally

5mm

210-852-240

8mm

210-858-240

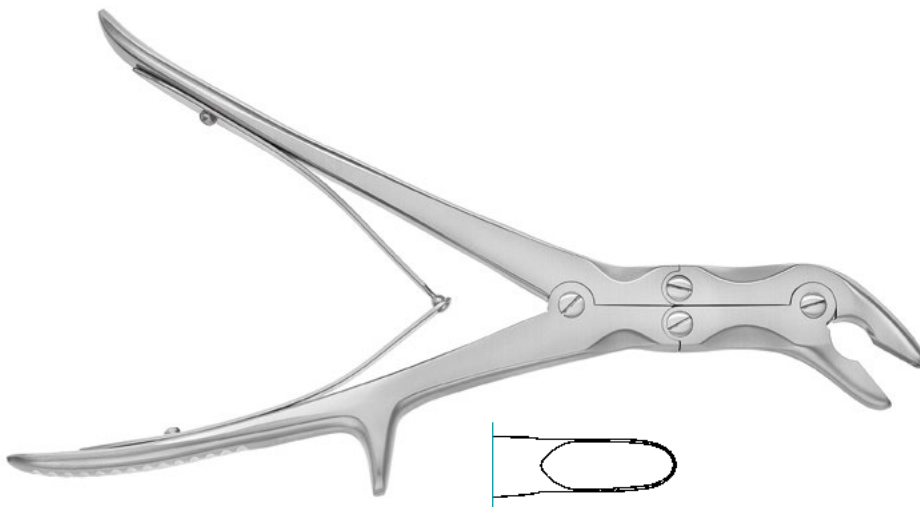

STILLE

Bone Rongeur, sideways curved, 230mm, 9"

6mm	210-907-230
8mm	210-908-230

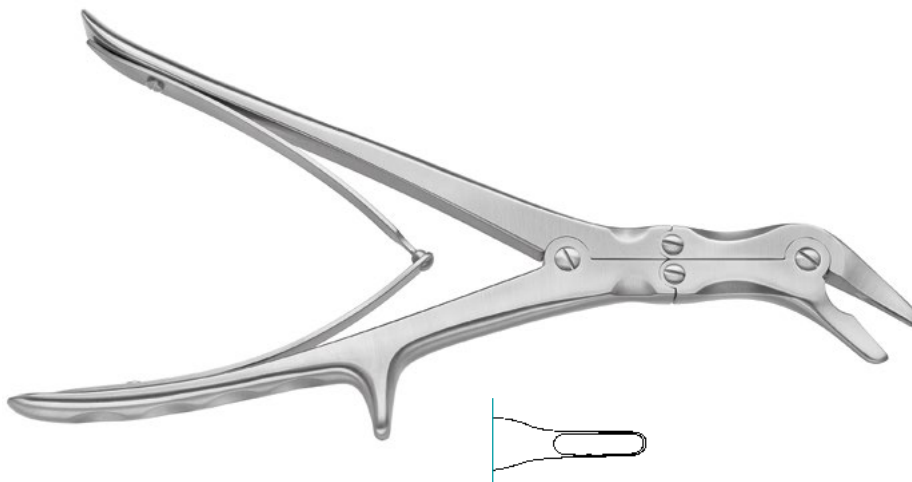

ECHLIN

Bone Rongeur, 230mm, 9"

2x10mm	210-798-230
3x10mm	210-799-230
4x10mm	210-797-230

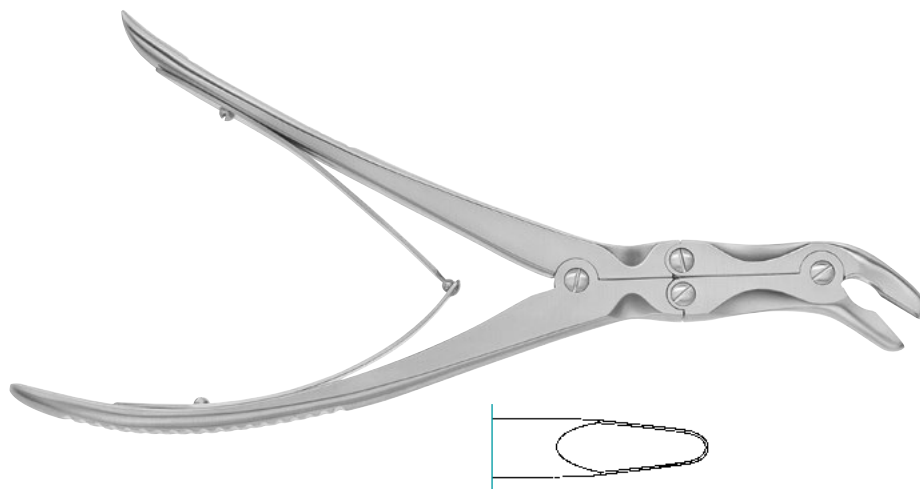

FRYKHOLM

Bone Rongeur, s-curved, 5mm jaw

240mm, 9 ¹ / ₂ "	210-855-240
--	-------------

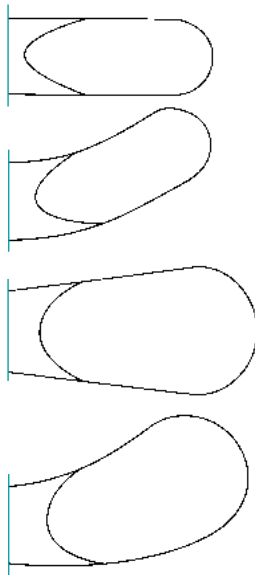
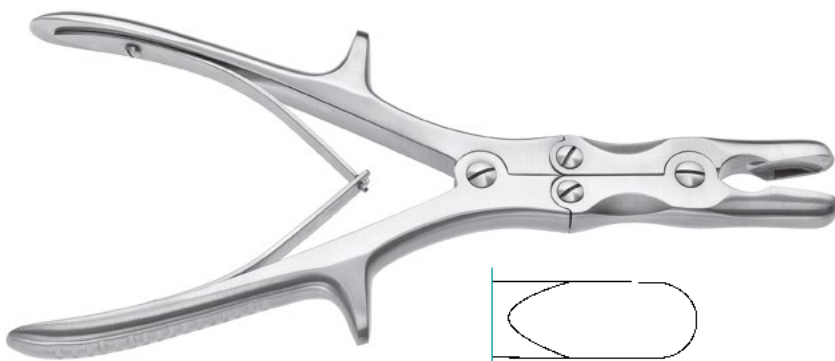

STILLE LUER

Bone Rongeur, straight, 220mm, 8²/₃"

10mm	210-907-220
------	-------------

17mm	210-910-220
------	-------------

curved

10mm	210-911-220
------	-------------

17mm	210-909-220
------	-------------

straight, 270mm, 10²/₃"

17mm	210-910-260
------	-------------

curved

17mm	210-911-260
------	-------------

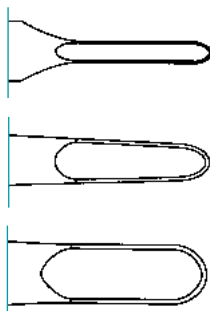

DALE LEKSELL

Bone Rongeur, XL Handle

3mm	210-843-360
-----	-------------

5mm	210-845-360
-----	-------------

8mm	210-848-360
-----	-------------

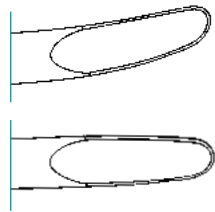
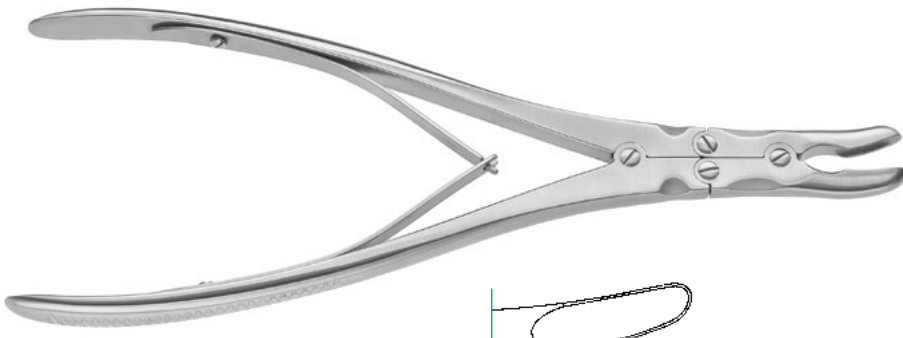
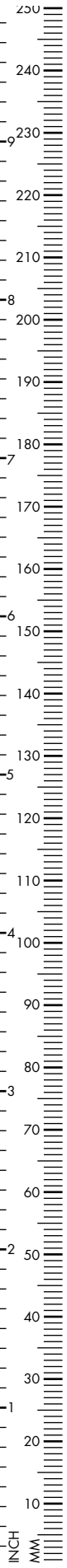

ROETTGEN RUSKIN

Bone Rongeur, 240mm, 9¹/₂"

5mm, curved	210-792-230
5mm, straight	210-793-230
6mm, curved	210-796-230

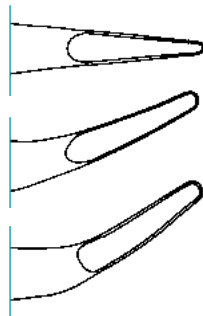
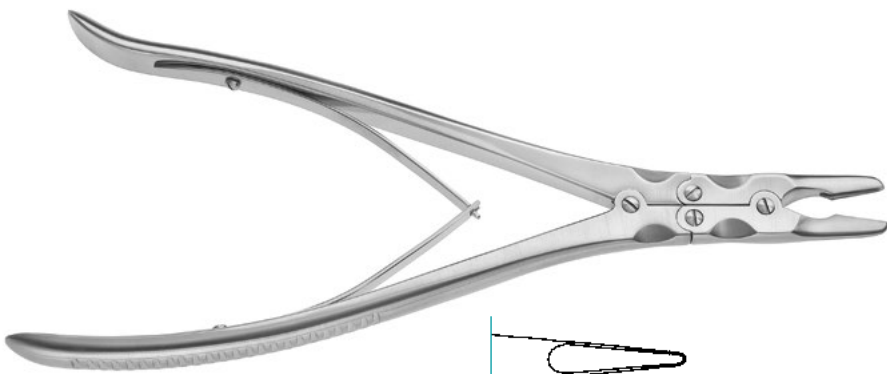

SMITH PETERSEN

Bone Rongeur, 3mm jaw, 240mm, 9¹/₂"

Straight	210-832-240
Slightly Curved	210-834-240
Strongly Curved	210-836-240

4mm jaw

Straight	210-832-244
Slightly Curved	210-834-244
Strongly Curved	210-836-244



STILLE RUSKIN

Bone Rongeur, 6mm jaw, 230mm, 9"

Straight	210-898-230
Curved	210-899-230

8mm jaw

Straight	210-900-230
Curved	210-901-230



SYPERT

Bone Rongeur, straight, 350mm, 14"

3mm	210-813-350
5mm	210-815-350
8mm	210-818-350
curved	
3mm	210-803-350
5mm	210-805-350
8mm	210-808-350

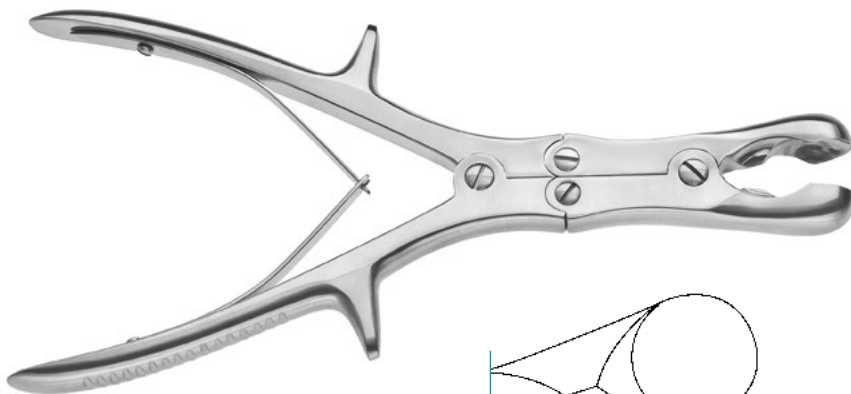

SEMB

Bone Rongeur, curved

225mm, 8 ^{7/8} "	210-905-225
---------------------------	-------------

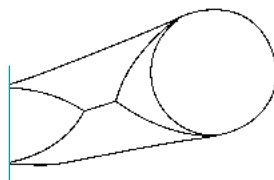

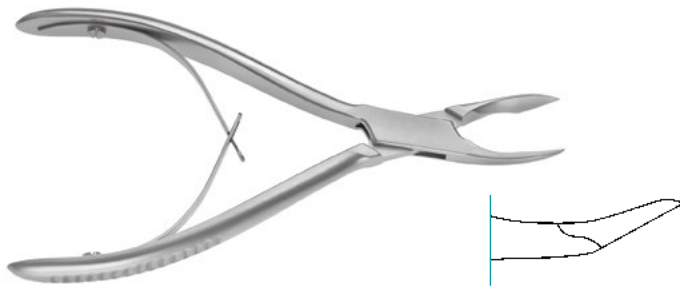
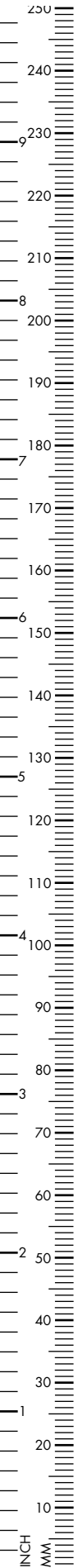

NIRO

Bone Cutting Forceps, angled

140mm, 5 ¹ / ₂ "	210-845-130
--	-------------

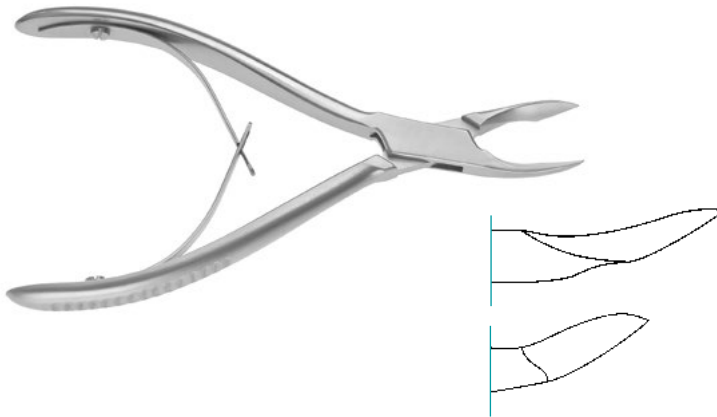

CLEVELAND

Bone Cutting Forceps, angled on flat

145mm, 5 ³ / ₄ "	210-845-145
170mm, 6 ² / ₃ "	210-845-170



LITTAUER

Bone Cutting Forceps with spring

150mm, 6"	210-397-150
-----------	-------------

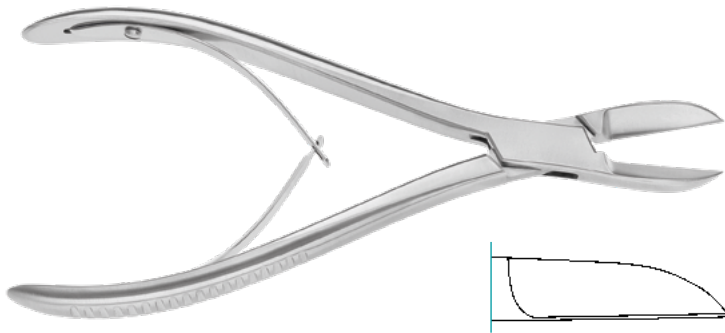

COTTLE KAZANJIAN

Bone Cutting Forceps, straight

180mm, 7"	210-845-185
-----------	-------------

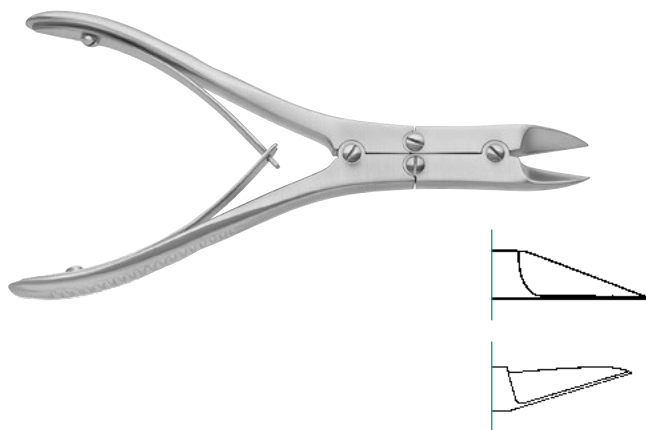

BOEHLER

Bone Cutting Forceps, double action,
straight

150mm, 6"	210-892-150
-----------	-------------

curved on flat

150mm, 6"	210-890-150
-----------	-------------

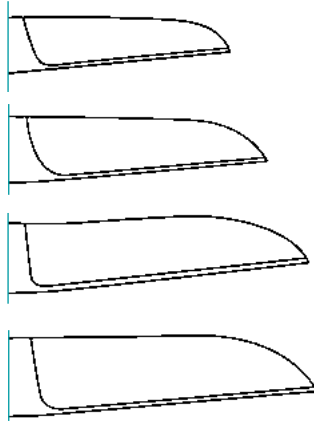

LISTON

Bone Cutting Forceps, straight

140mm, 5 ¹ / ₂ "	210-934-140
170mm, 6 ² / ₃ "	210-934-170
190mm, 7 ¹ / ₂ "	210-934-190
220mm, 8 ² / ₃ "	210-934-220

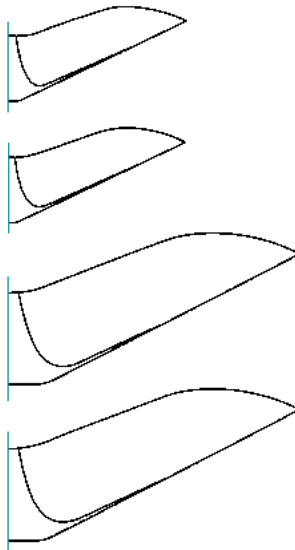

LISTON

Bone Cutting Forceps, angled

140mm, 5 ¹ / ₂ "	210-935-140
170mm, 6 ² / ₃ "	210-935-170
190mm, 7 ¹ / ₂ "	210-935-190
220mm, 8 ² / ₃ "	210-935-220

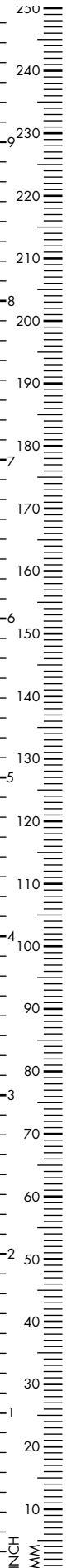

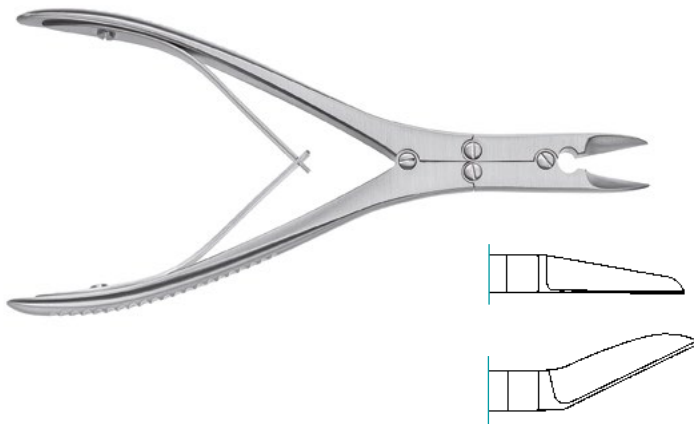

RUSKIN LISTON

Bone Cutting Forceps, double action,
170mm, 6²/₃"

Straight	210-844-170
Angled	210-843-170

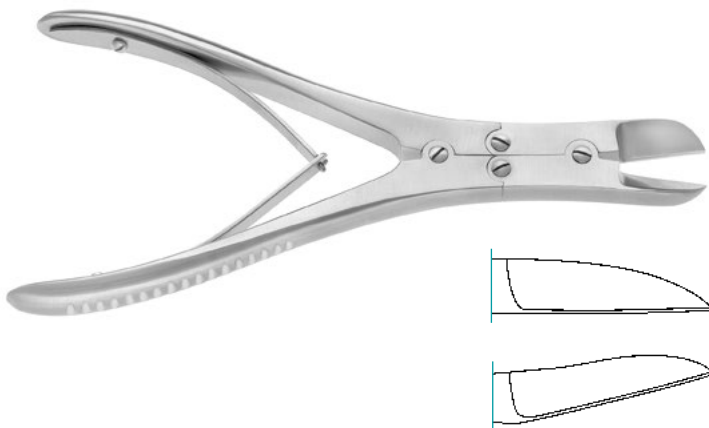

RUSKIN LISTON

Bone Cutting Forceps, double action,
185mm, 7¹/₄"

Straight	210-900-185
Angled	210-901-185



MCINDOE

Bone Cutting Forceps, double action

175mm, 6⁷/₈"

210-880-175

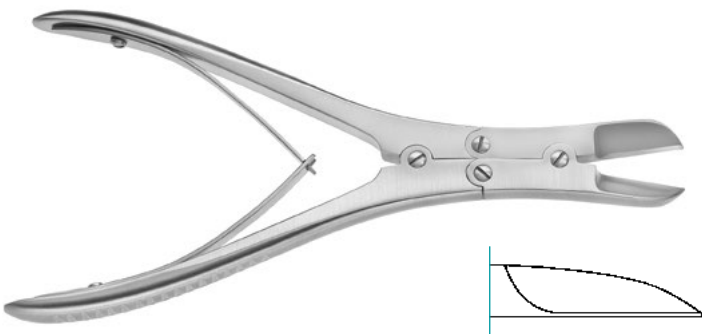

RUSKIN ROWLAND

Bone Cutting Forceps, double action, straight

180mm, 7"

210-855-180

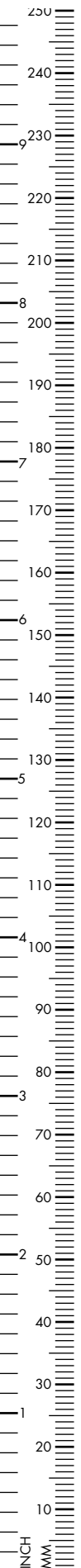

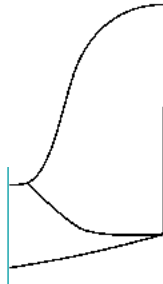
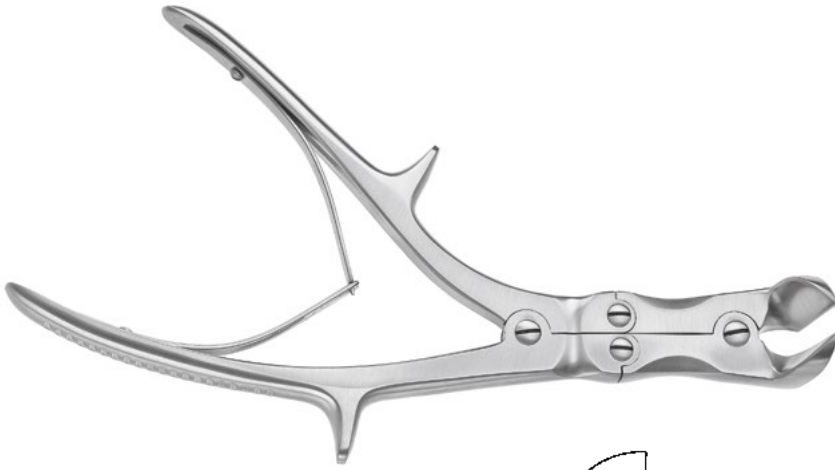

SEMB

Bone Cutting Forceps, double action,
shanks lateral angled

245mm, 9²/₃"

210-911-245

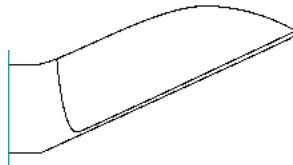
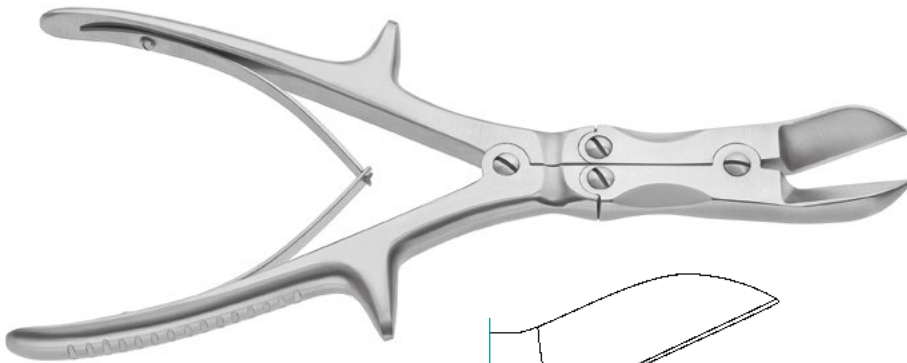

LISTON

Bone Cutting Forceps, double action,
angled

240mm, 9¹/₂"

210-905-240

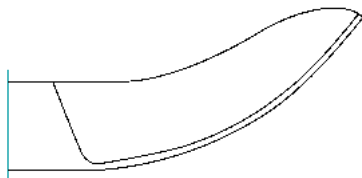
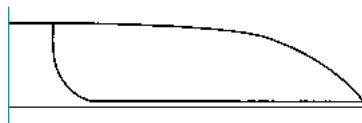
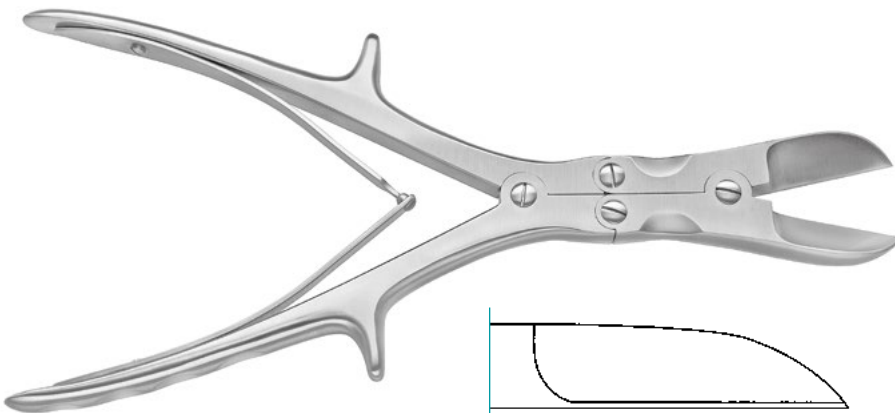

STILLE LISTON

Bone Cutting Forceps, double action
270mm, 10²/₃"

Straight

210-904-270

Angled

210-902-270

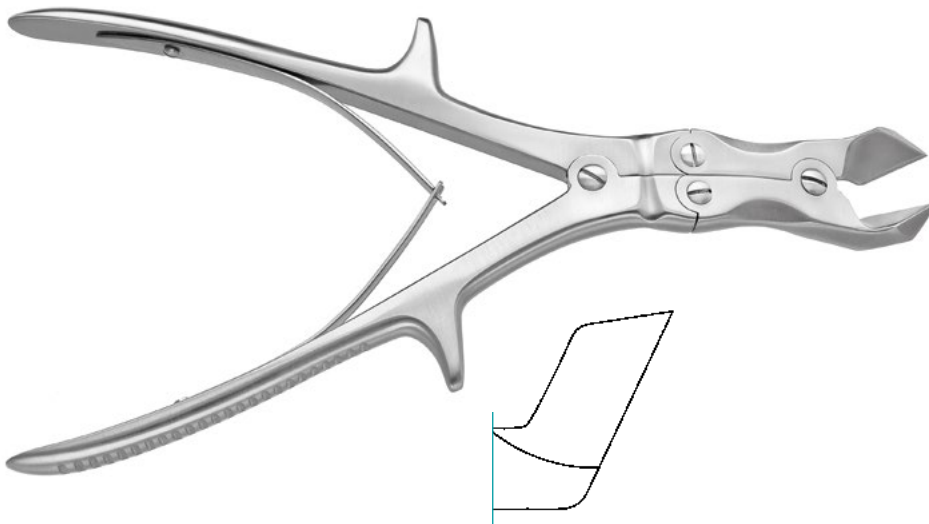

LISTON KEY HORSLEY
Bone Cutting Forceps, double action,
s-shaped

255mm, 10" 210-910-255

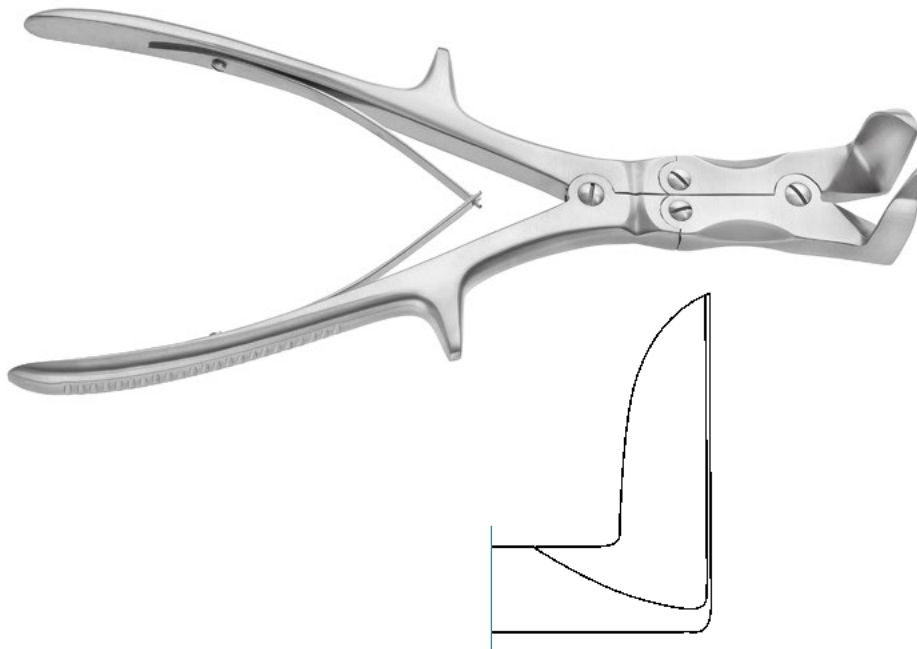

STILLE LISTON
Bone Cutting Forceps, double action,
90° angled

270mm, 10^{2/3}" 210-908-270

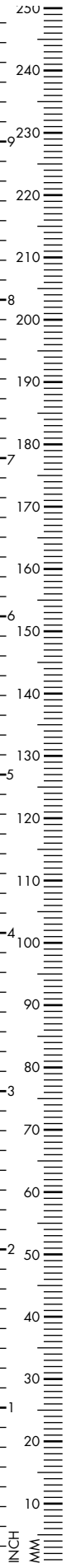



Tendon Grasping Forceps,
100mm, 4"

2.0mm jaw	210-675-002
3.0mm jaw	210-675-003
4.0mm jaw	210-675-004
5.0mm jaw	210-675-005

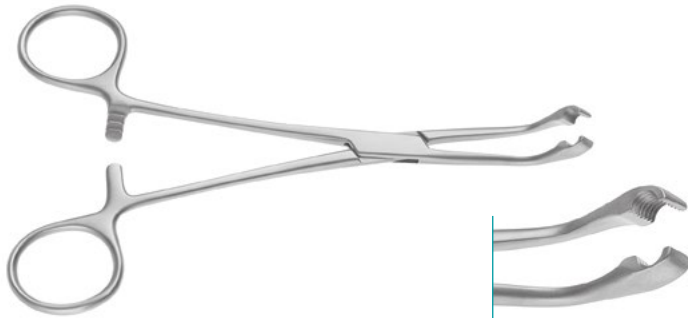

Tendon Grasping Forceps

155mm, 6 ^{1/8} "	140-584-155
---------------------------	-------------

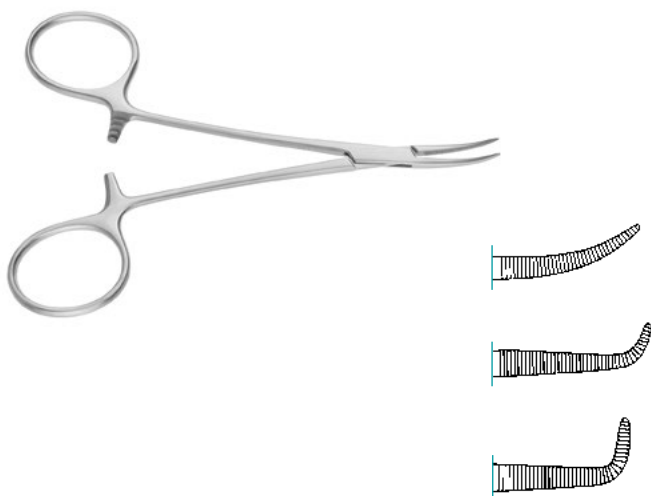

HALSTED MOSQUITO

Tendon Grasping Forceps,
125mm, 5"

light curve	140-354-001
medium curve	140-354-002
strong curve	140-354-003

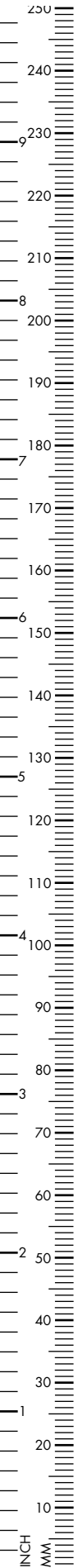

ENGLERT

Tendon Grasping Forceps,
4x5 traumatic teeth

145mm, 5^{3/4}"

140-355-145

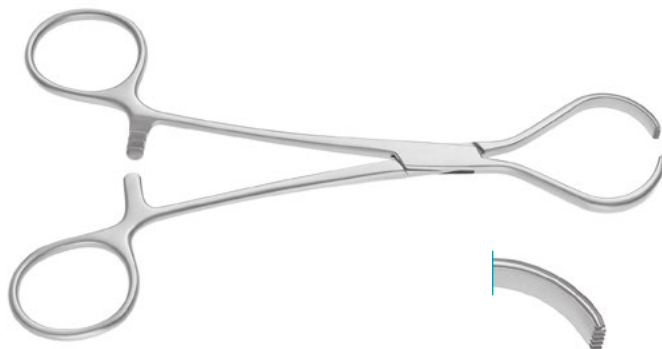

OMBREDANNE (ISELIN)

Tendon Holding Forceps,
4x5 teeth

160mm, 6^{1/4}"

140-583-160

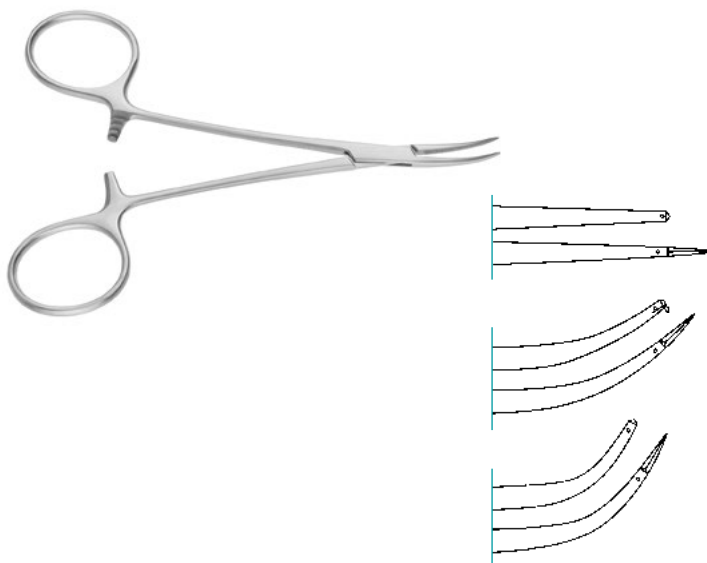

Tendon Interlacing Forceps,
150mm, 6"

straight 210-682-150

curved 210-683-150

strongly curved 210-684-150

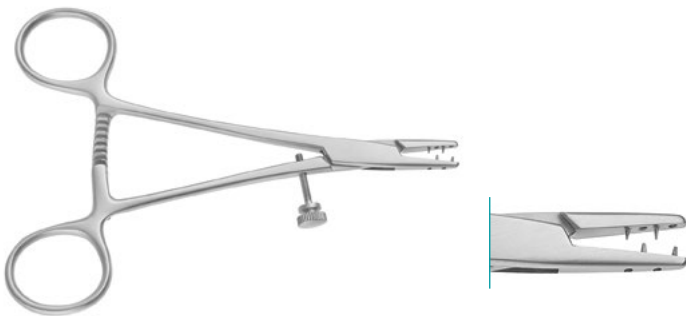

Tendon Seizing Forceps, 4 pins

120mm, 4^{3/4}"

210-650-120

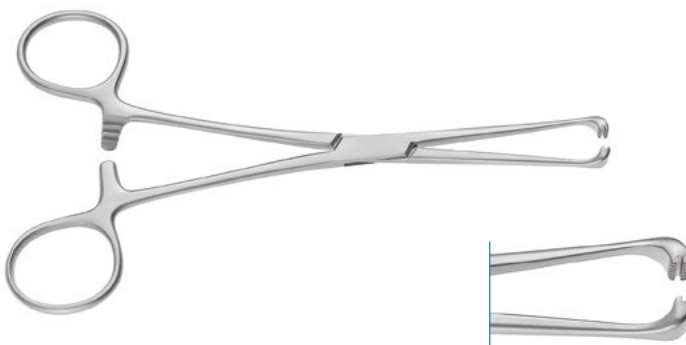

STEINMANN

Tendon Seizing Forceps

160mm, 6^{1/4}"

210-674-160

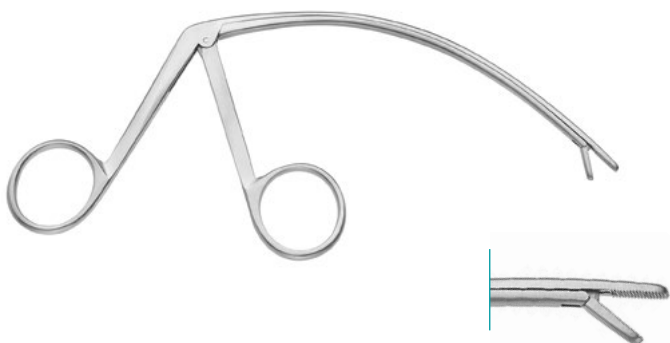

CARROLL

Tendon Forceps, curved

110mm, 4^{1/3}"

210-679-110

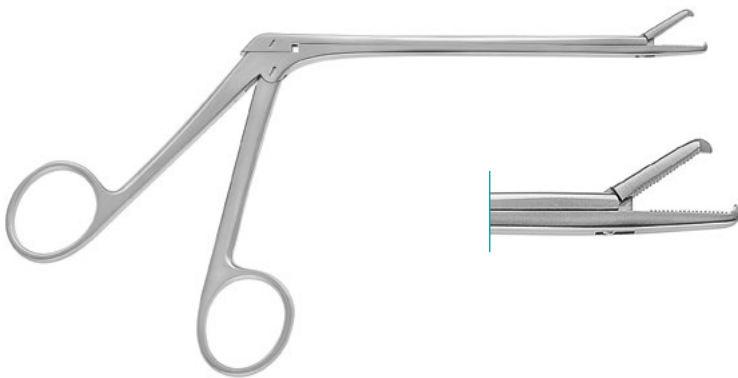

HOEN

Tendon Grasping Forceps, 1x2 teeth

120mm, 4 ³ / ₄ "	210-660-120
--	-------------

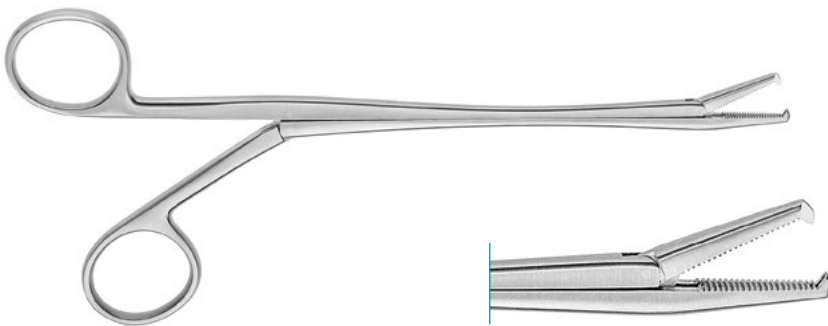

BRAND

Tendon Seizing Forceps, 1x2 teeth

150mm, 6"	210-665-150
-----------	-------------

190mm, 7 ¹ / ₂ "	210-665-190
--	-------------

245mm, 9 ² / ₃ "	210-665-240
--	-------------



BRAND

Tendon Seizing Forceps, curved, 1x2 teeth

150mm, 6"	210-663-150
-----------	-------------

190mm, 7 ¹ / ₂ "	210-663-190
--	-------------

250mm, 9 ⁷ / ₈ "	210-663-250
--	-------------

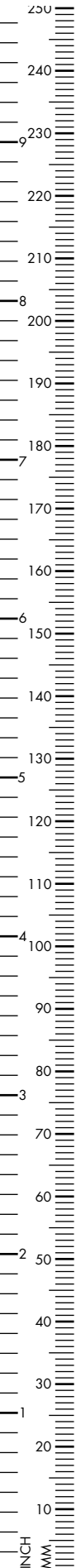

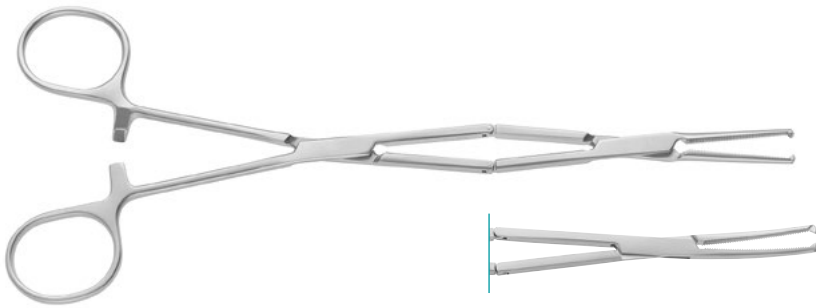

Tendon Seizing Forceps, 1x2 teeth,
210mm, 8¹/₄"

straight	210-668-210
curved	210-669-210

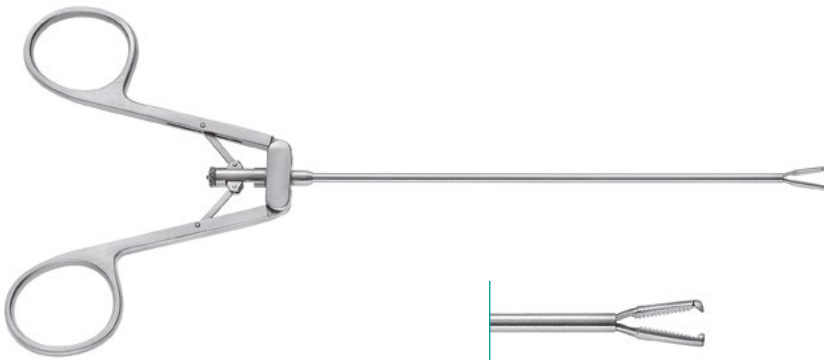

KLEINERT KUTZ

Tendon Seizing Forceps, 1x2 teeth, flexible,
1x8mm serrated jaw

210mm, 8 ¹ / ₄ "	210-681-200
--	-------------



Tenolysis Knife, for tenolysis superficial
and deep to the tendon



A	210-681-001
---	-------------

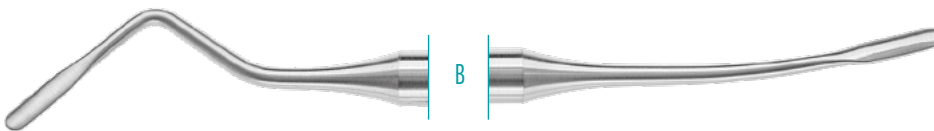

B	210-681-002
---	-------------

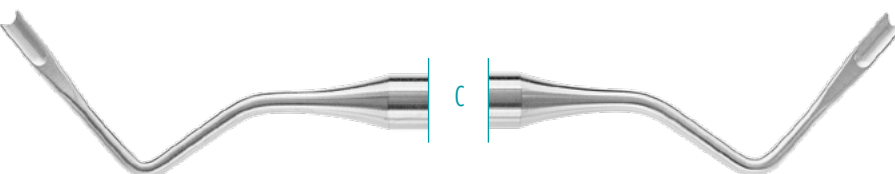

C	210-681-003
---	-------------

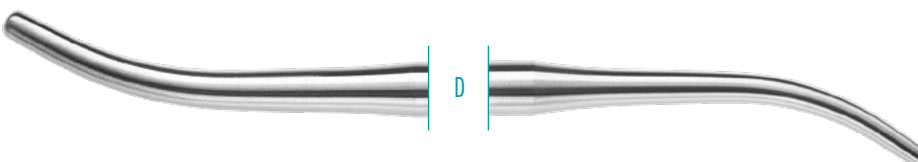

D	210-681-004
---	-------------



FISCHER

Tendon Stripper, blunt,
synthetic handle

310mm, 12^{1/4}" 210-855-310



Tendon Stripper, synthetic handle,
inner-Ø 3mm

285mm, 11^{1/4}" 210-663-280

350mm, 14" 210-663-350

600mm, 24" 210-663-600

with slot

285mm, 11^{1/4}" 210-663-281

350mm, 14" 210-663-351

Inner-Ø 4mm

285mm, 11^{1/4}" 210-664-280

350mm, 14" 210-664-350

600mm, 24" 210-664-600

with slot

285mm, 11^{1/4}" 210-664-281

350mm, 14" 210-664-351

Inner-Ø 5mm

285mm, 11^{1/4}" 210-665-280

350mm, 14" 210-665-350

600mm, 24" 210-665-600

with slot

285mm, 11^{1/4}" 210-665-281

350mm, 14" 210-665-351

Inner-Ø 6mm

285mm, 11^{1/4}" 210-666-280

350mm, 14" 210-666-350

600mm, 24" 210-666-600

with slot

285mm, 11^{1/4}" 210-666-281

350mm, 14" 210-666-351



BUNNELL

Tendon Stripper, 150mm, 6"

Ø 2.5mm 210-652-001

Ø 3.0mm 210-652-002

Ø 4.0mm 210-652-003

Ø 5.0mm 210-652-004

Ø 6.5mm 210-652-005

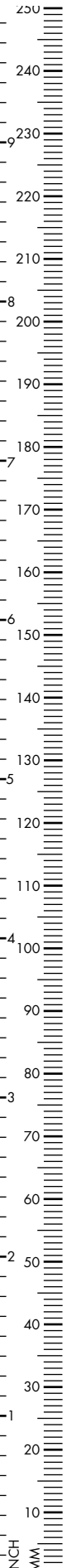



PAUL

Tendon Retractor, blunt, 3 prongs

125mm, 5"

170-177-125



KLAPP

Tendon Retractor, blunt, 175mm, 6⁷/₈"

2 prongs

170-181-002

3 prongs

170-181-003

4 prongs

170-181-004

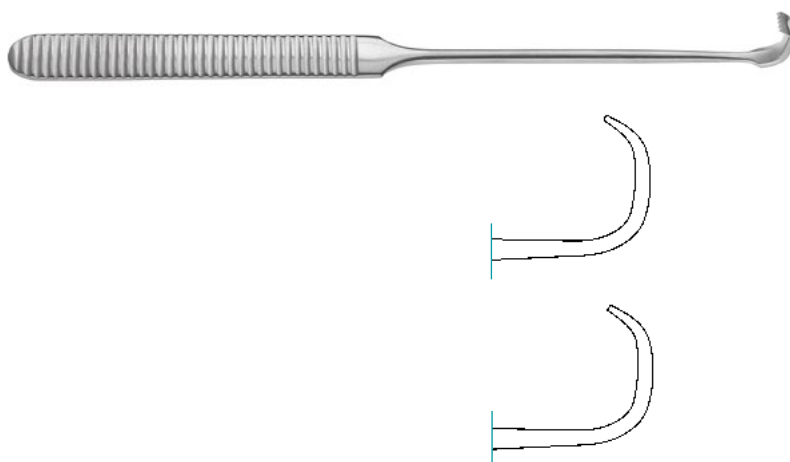

STRANDELL STILLE

Tendon Retractor, 15x6mm, 190mm, 7¹/₂"

blunt

170-237-001

toothed

170-237-002

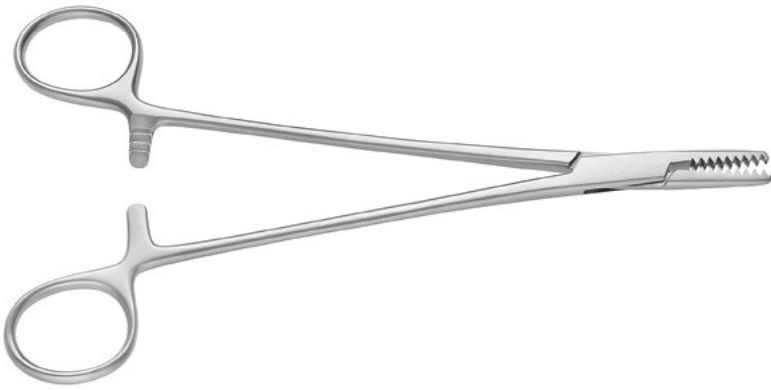
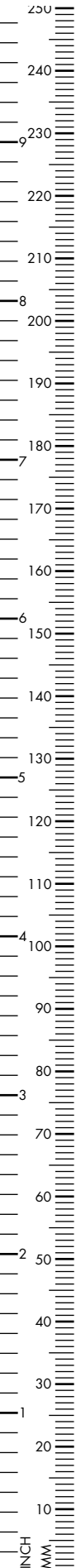

MARTIN

Cartilage Holding Forceps, straight

190mm, 7^{1/2}"

210-652-190

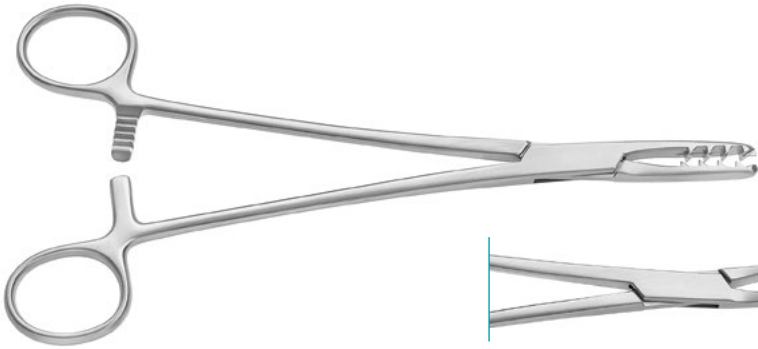

BIRCHER GANSKE

Cartilage Holding Forceps, 200mm, 8"

straight

210-620-200

angled

210-621-200

laterally curved

210-623-200



WALTON

Cartilage Forceps, slightly curved, with pins

185mm, 7^{1/4}"

210-626-185

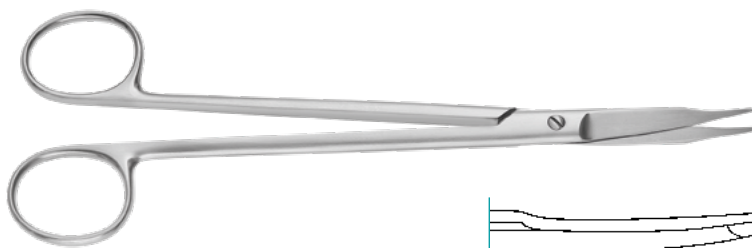

MARTIN

Cartilage Scissors

200mm, 8"

120-206-200



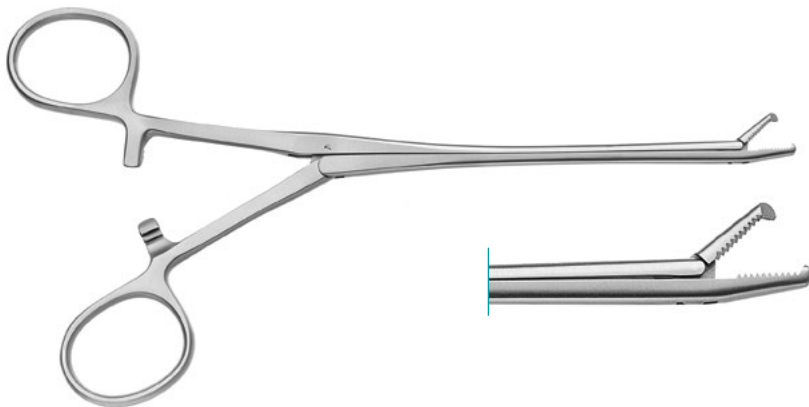

Meniscus Grasping Forceps with ratchet
1x2 teeth, straight

200mm, 8" 225-360-000

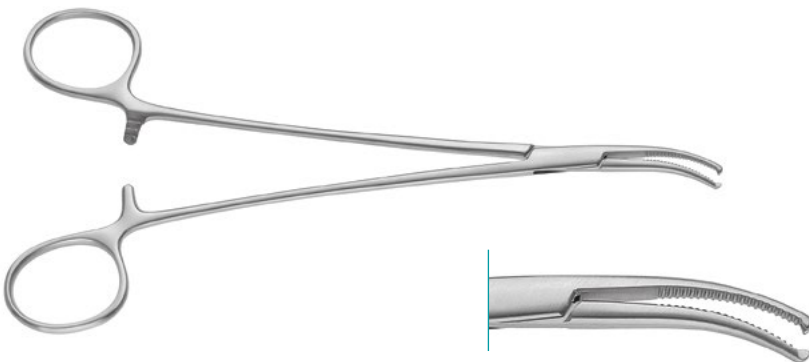

PRESTON

Meniscus Ligament Flavum Forceps,
1x2 teeth, serrated jaw

190mm, 7¹/₂" 210-660-190

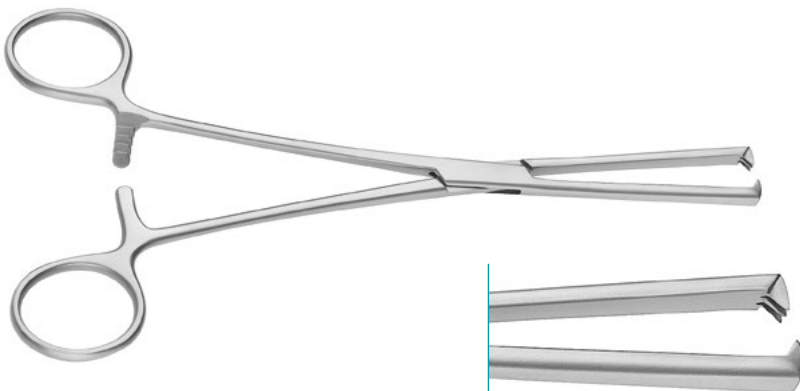

BIRCHER

Meniscus Grasping Forceps, 200mm, 8"

straight 210-624-200

curved 210-625-200

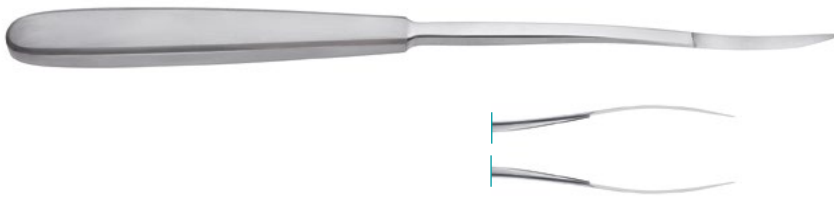
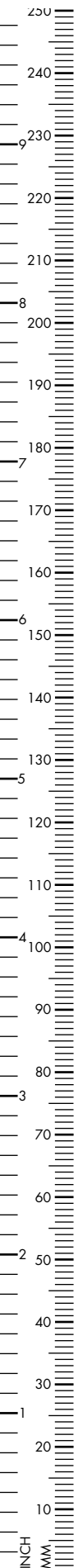

Meniscotome, 220mm, 8²/₃"

Left side 210-650-220

Right side 210-651-220

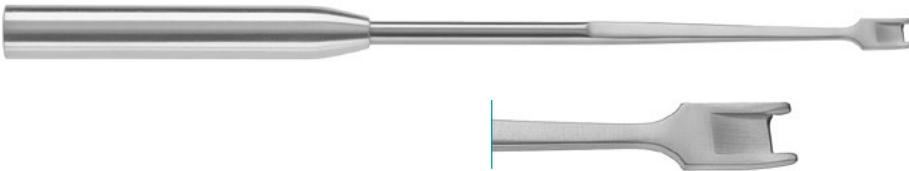

LOWE BRECK

Meniscotome

250mm, 9⁷/₈" 210-637-250

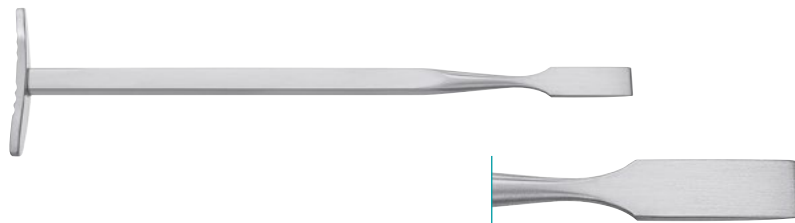

SMILIE

Meniscotome, straight

170mm, 6²/₃" 210-630-170

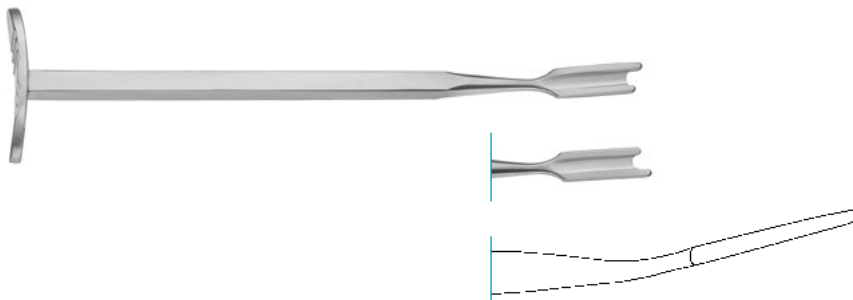

SMILLIE

Meniscotome with guards, 170mm, 6²/₃"

Left 210-631-170

Right 210-633-170



Meniscotome, double edge, 180mm, 7"
Slightly curved 210-641-180



Meniscotome, 220mm, 8²/₃"
Curved right 210-645-220
Curved left 210-643-220



Meniscotome, curved
190mm, 7¹/₂" 210-613-190

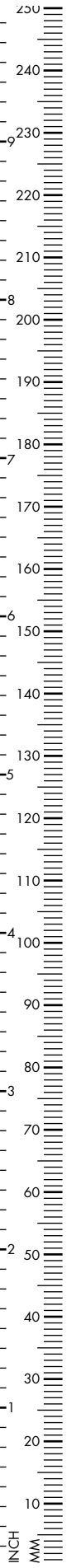

DOANE

Knee Retractor

57 x 70mm blade	210-700-150
64 x 76mm blade	210-700-190



SMILLIE

Knee wound retractor, 140mm, 5 1/2"

A 32 x 19mm	210-628-001
B 45 x 19mm	210-628-002
C 60 x 19mm	210-628-003
D 52 x 13mm	210-628-004
E 21 x 13mm	210-628-005
F 13 x 15mm	210-628-006

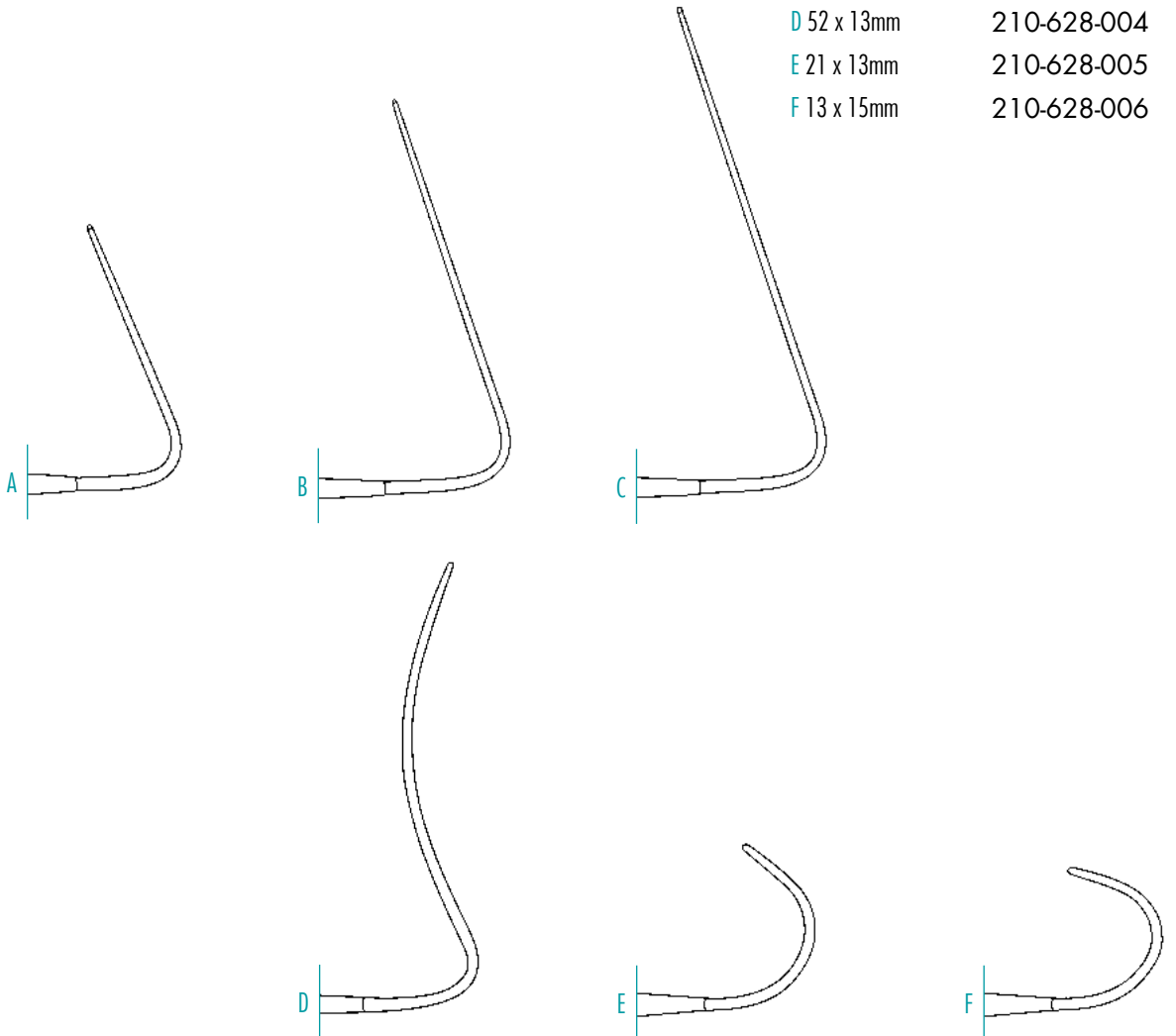

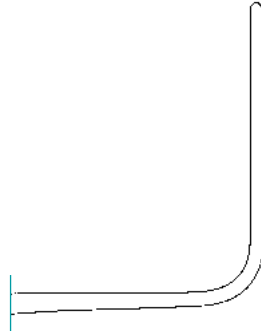

Knee Retractor, 38 x 9mm

210mm, 8¹/₄"

210-568-210

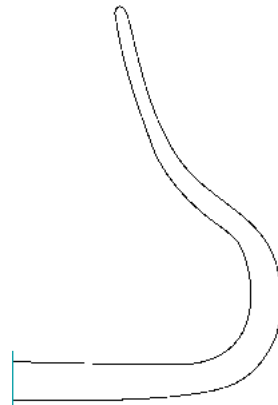

BLOUNT

Knee Retractor

175mm, 6⁷/₈"

210-567-170



Knee and Meniscus Retractor

175mm, 6⁷/₈"

210-569-170

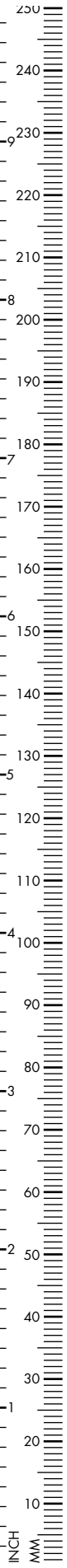

Bone Hook, sharp, hollow handle,
230mm, 9"

9.5mm	210-230-101
19mm	210-230-102
25mm	210-230-103



Bone Hook, 1 tooth, sharp

245mm, 9 ² / ₃ "	170-292-245
--	-------------

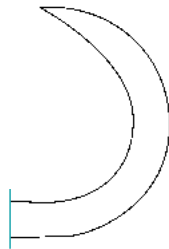

Bone Hook, 1 tooth, 200mm, 8"

Blunt	170-280-200
Sharp	170-282-200

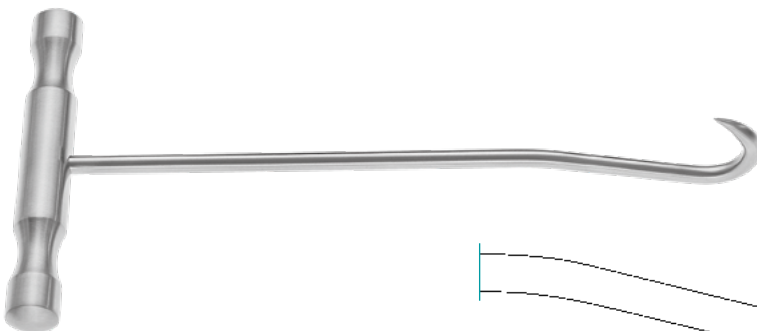

Bone Hook with T-Handle, sharp, 21mm

200mm, 8"	200-410-200
-----------	-------------

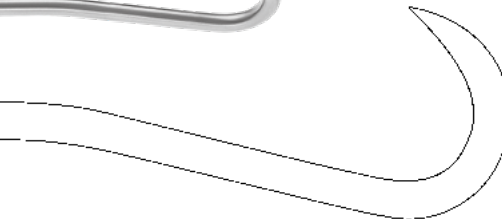

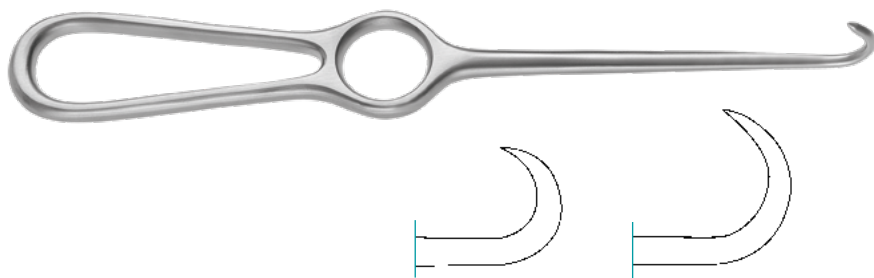

Bone Hook, 1 tooth, sharp, 230mm, 9"

Medium	200-410-001
Small	200-410-002

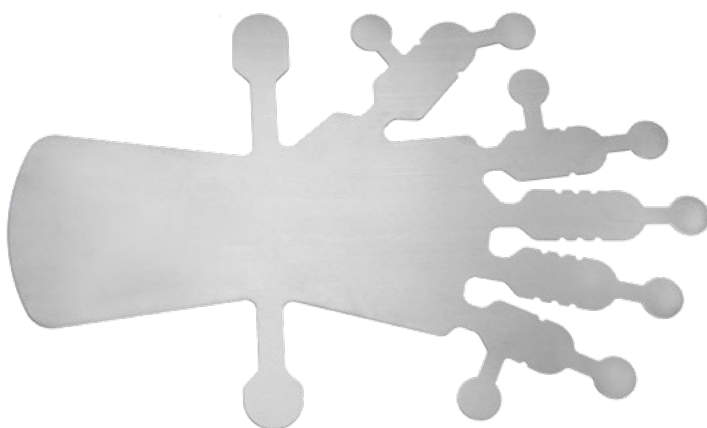

Lead Hand

Children	260-988-002
Adolescents	260-988-003
Adults	260-988-001

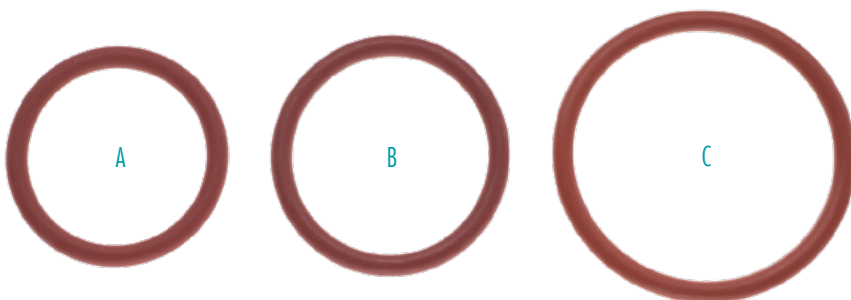

Fixation Rings (Scale 1:1)

A Children	260-988-004
B Adolescent	260-988-005
C Adults	260-988-006



Silicone Hand, malleable, black
with fixation rings

260-988-000



CHARNLEY

Charnley Initial Incision Retractor
frame and blade small 25 x 38mm
big blade 25 x 44mm
with weight and chain

Complete set	170-300-001
Frame	170-300-123
Weight and Chain	170-300-122



Blades, small (width x depth)

25 x 25mm	170-300-025
25 x 38mm	170-300-038
25 x 50mm	170-300-050
25 x 57mm	170-300-057
25 x 63mm	170-300-010
25 x 75mm	170-300-013
25 x 101mm	170-300-017
25 x 114mm	170-300-114
25 x 127mm	170-300-016



Blades, large (width x depth)

25 x 25mm	170-301-025
25 x 44mm	170-301-044
25 x 50mm	170-301-050
25 x 57mm	170-301-057
25 x 63mm	170-301-012
25 x 75mm	170-301-014
25 x 101mm	170-301-101
25 x 114mm	170-301-114
25 x 127mm	170-301-015

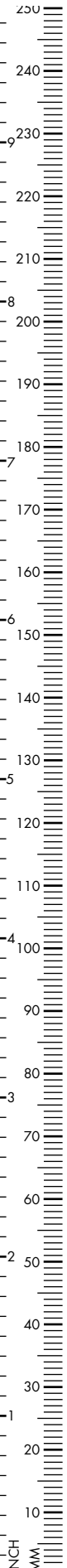

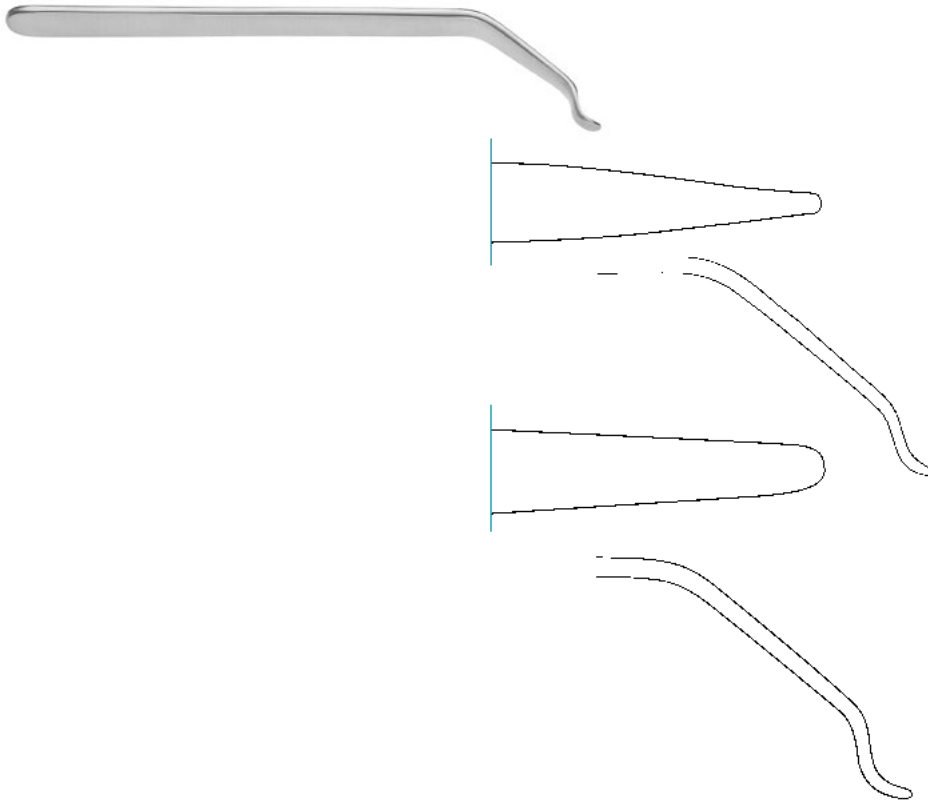

HAYES

Phalangeal Elevator, shaft angled 40°

130mm, 5 ¹ / ₈ "	210-471-003
--	-------------

150mm, 6"	210-471-006
-----------	-------------

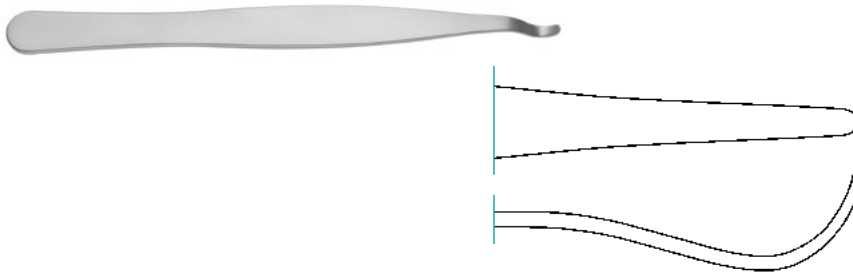

HAYES

Phalangeal Elevator, 3mm wide blade

150mm, 6"	210-473-150
-----------	-------------

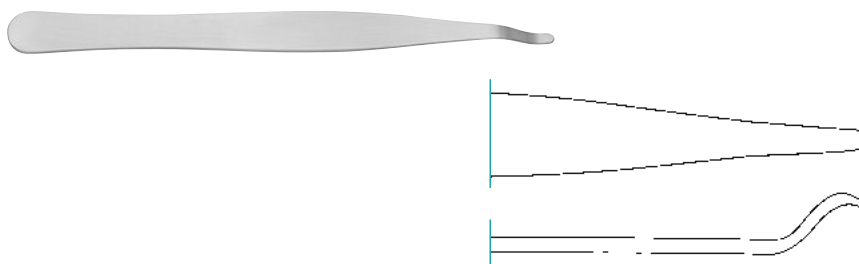

Bone Lever, 2.8mm

140mm, 5 ¹ / ₂ "	210-539-110
--	-------------

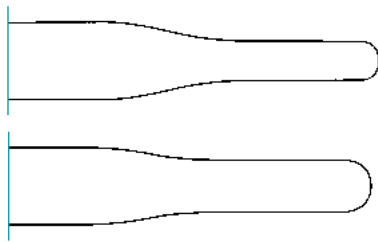
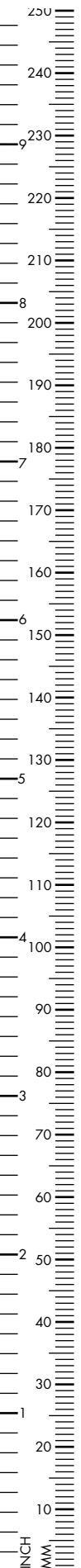

Phalangeal Elevator, 150mm, 6"

5mm	210-475-150
7mm	210-477-150

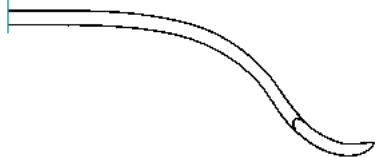
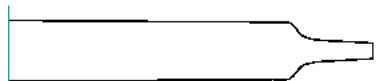

BUCK GRAMCKO

Bone Lever, 7.5mm wide, 2mm tip

150mm, 6"	210-541-075
-----------	-------------

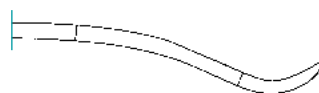

MINI HOHMANN

Bone Lever, 6mm wide, 2mm tip

160mm, 6 ^{1/4} "	210-539-060
---------------------------	-------------

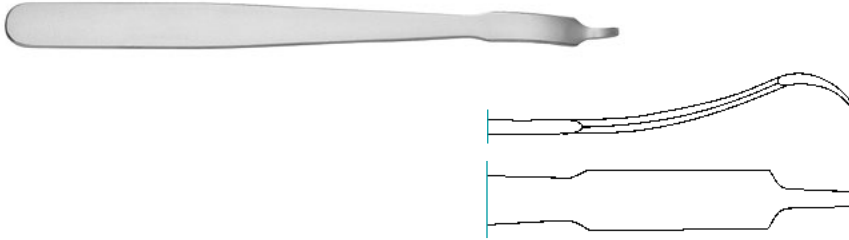

HOHMANN

Bone Lever, 2mm tip, 8mm wide

160mm, 6^{1/4}" 210-541-080

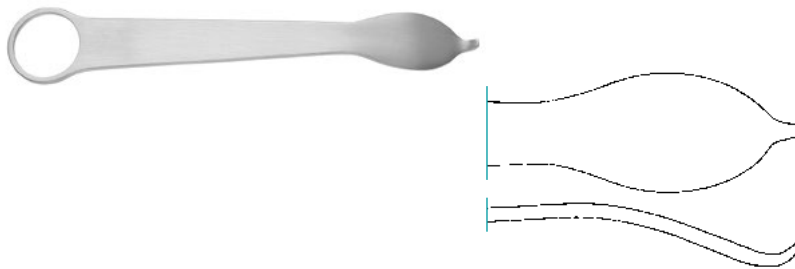

HOHMANN

Bone Lever, 15mm wide tip, with finger ring

120mm, 4^{3/4}" 210-541-150

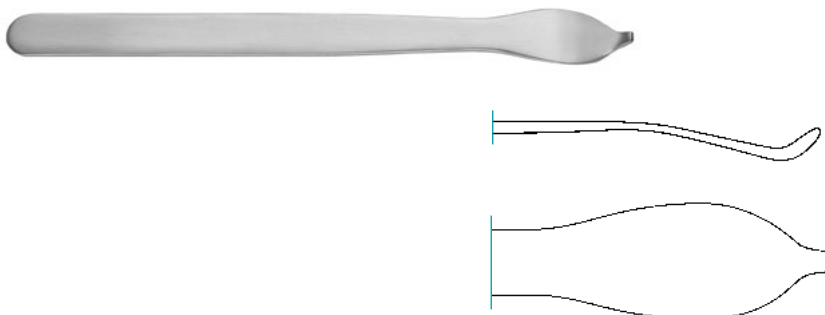

Mini Bone Lever, 15mm wide tip

160mm, 6^{1/4}" 210-539-150



LANGE BABY

Bone Lever, 17mm wide

170mm, 6²/₃"

210-534-170

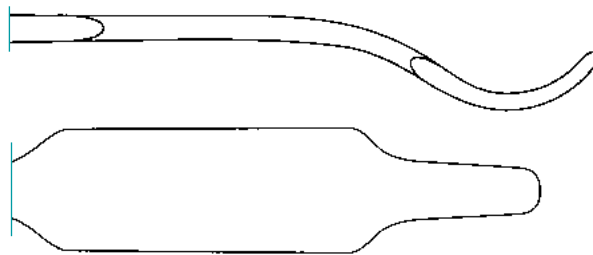

HOHMANN

Bone Lever, 240mm, 9¹/₂"

8mm 210-541-108

10mm 210-541-100

18mm 210-541-180

24mm 210-541-240

43mm 210-541-430

70mm 210-541-700

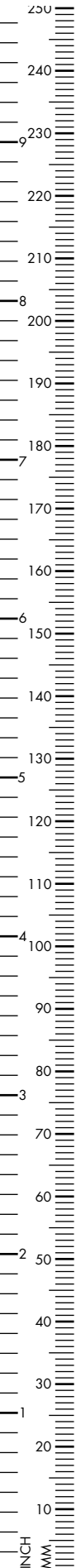
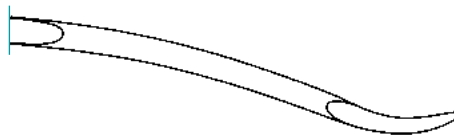



HOHMANN

Bone Lever, 17mm, sharp

240mm, 9¹/₂"

210-542-180

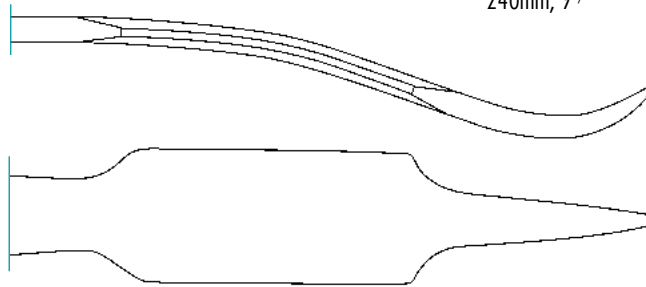

HOHMANN

Bone Lever, 25mm wide, 13mm tip

270mm, 10²/₃"

210-541-250

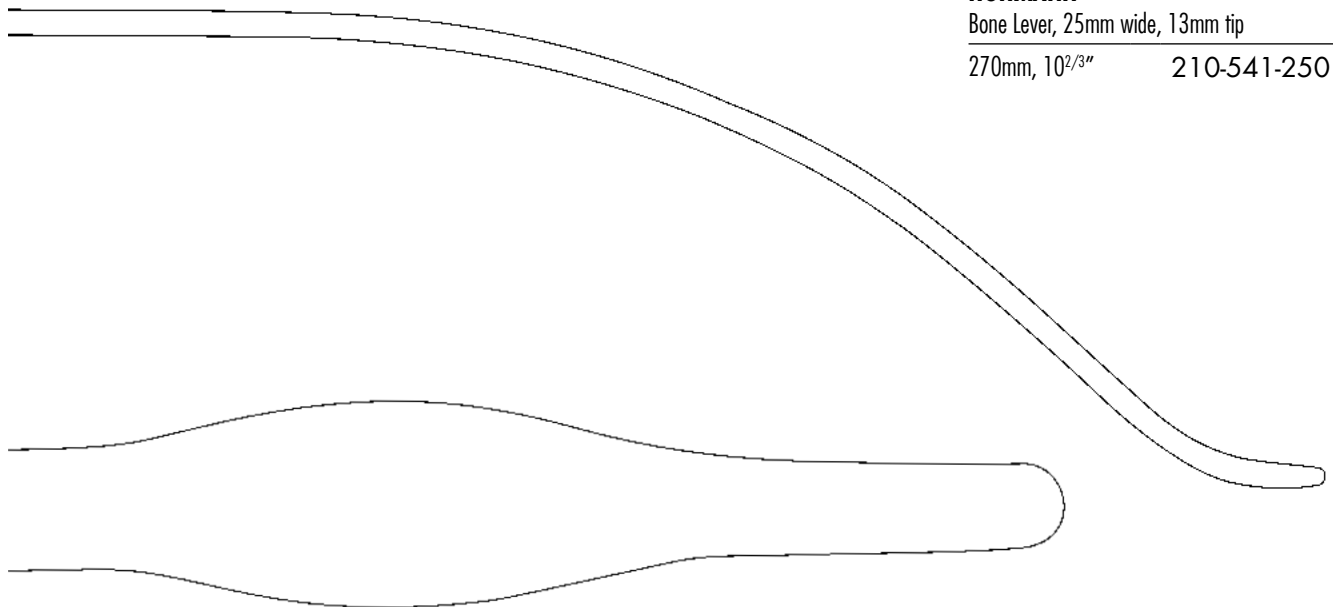



WAGNER

Bone Lever, 17mm

220mm, 8²/₃"

210-540-220

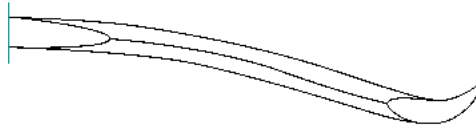

HOHMANN

Bone Lever, 24mm

260mm, 10¹/₄"

210-545-220

35mm

285mm, 11¹/₄"

210-545-350

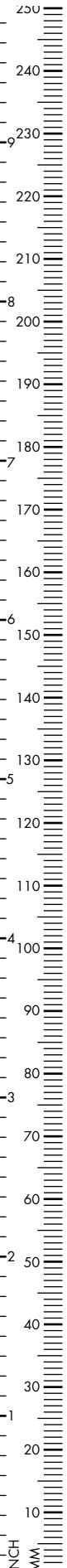
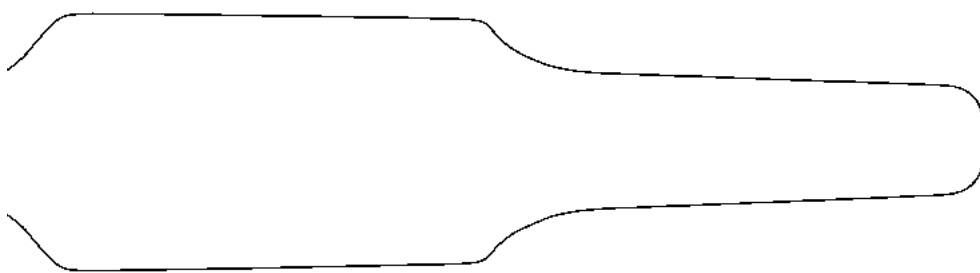
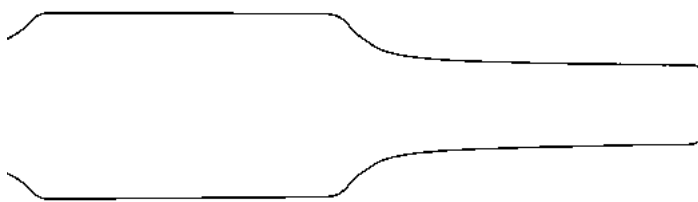
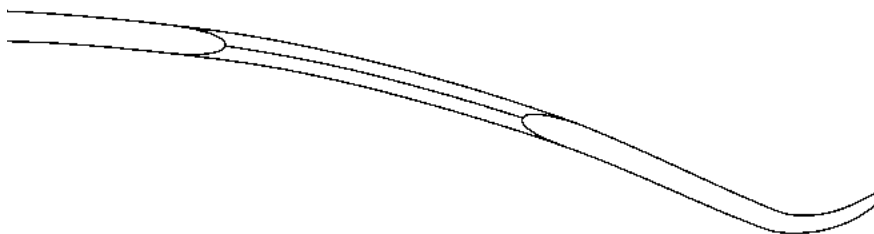

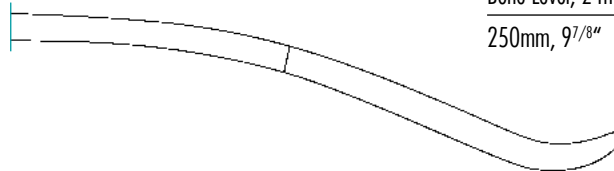

LANGE HOHMANN

Bone Lever, 24mm wide

250mm, 9⁷/₈"

210-557-250

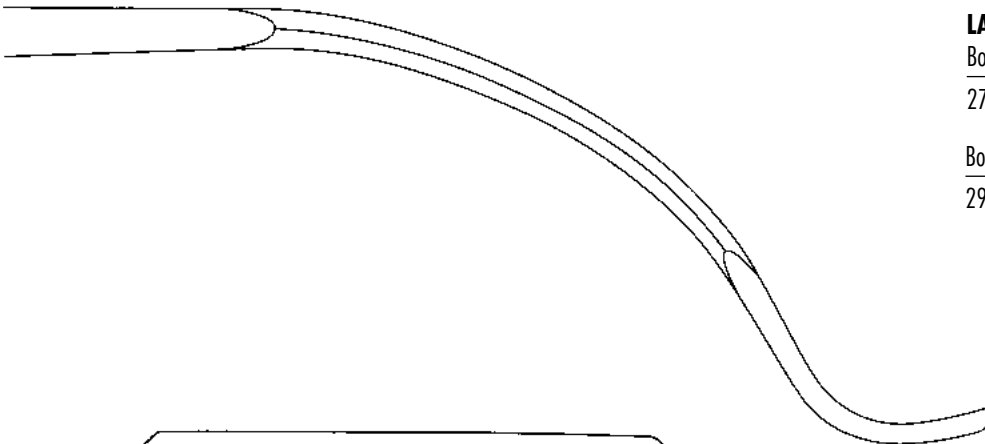

LANGE HOHMANN

Bone Lever, 30mm

270mm, 10²/₃"

210-557-270

Bone Lever, 33mm

290mm, 11¹/₂"

210-557-290

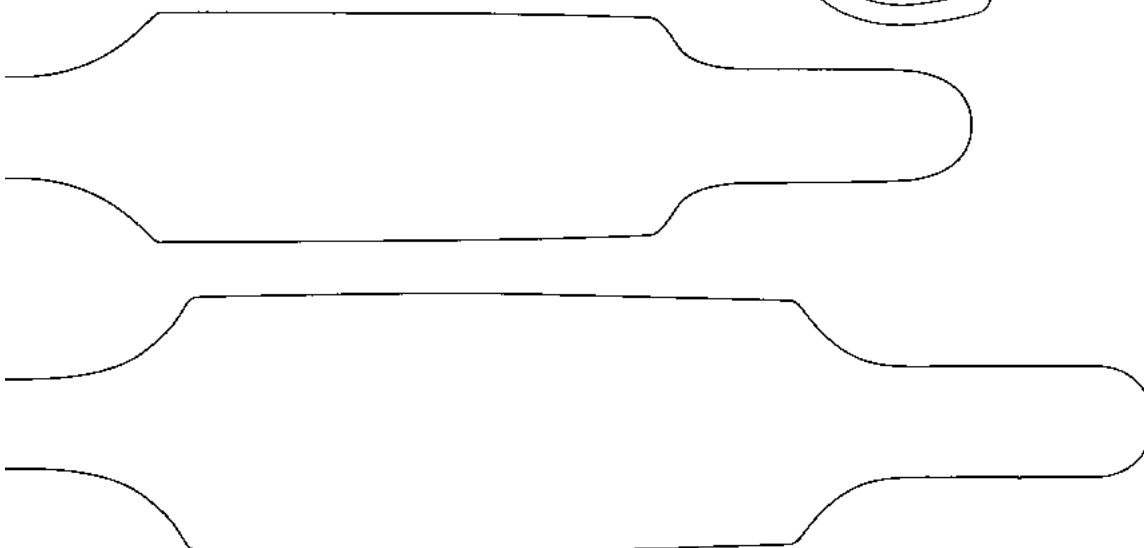

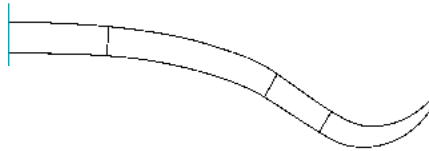

VERBRUGGE

Bone Lever, 25mm

200mm, 8" 210-542-025

45mm

230mm, 9" 210-542-045

70mm

250mm, 9⁷/₈" 210-542-070

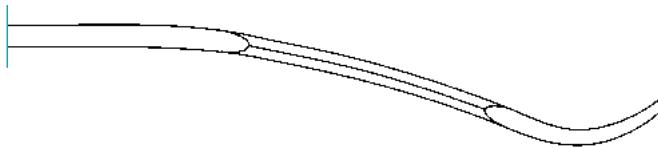

VERBRUGGE HOHMANN

Bone Lever, 44mm

240mm, 9¹/₂" 210-541-043

65mm

250mm, 9⁷/₈" 210-541-065

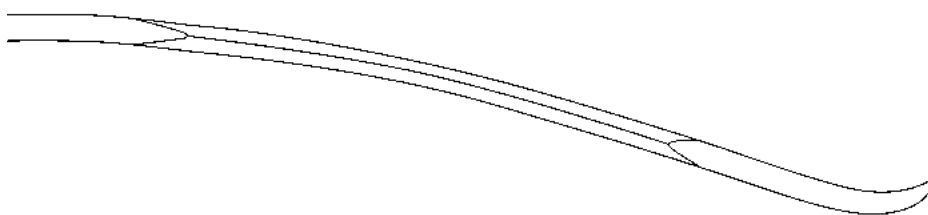

HOHMANN

Bone Lever, 43mm

235mm, 9¹/₄" 210-543-430

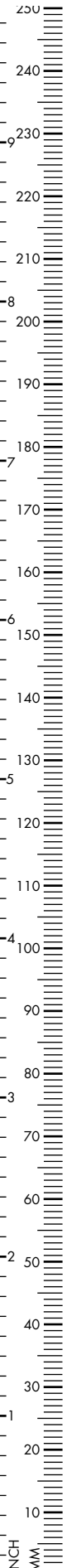

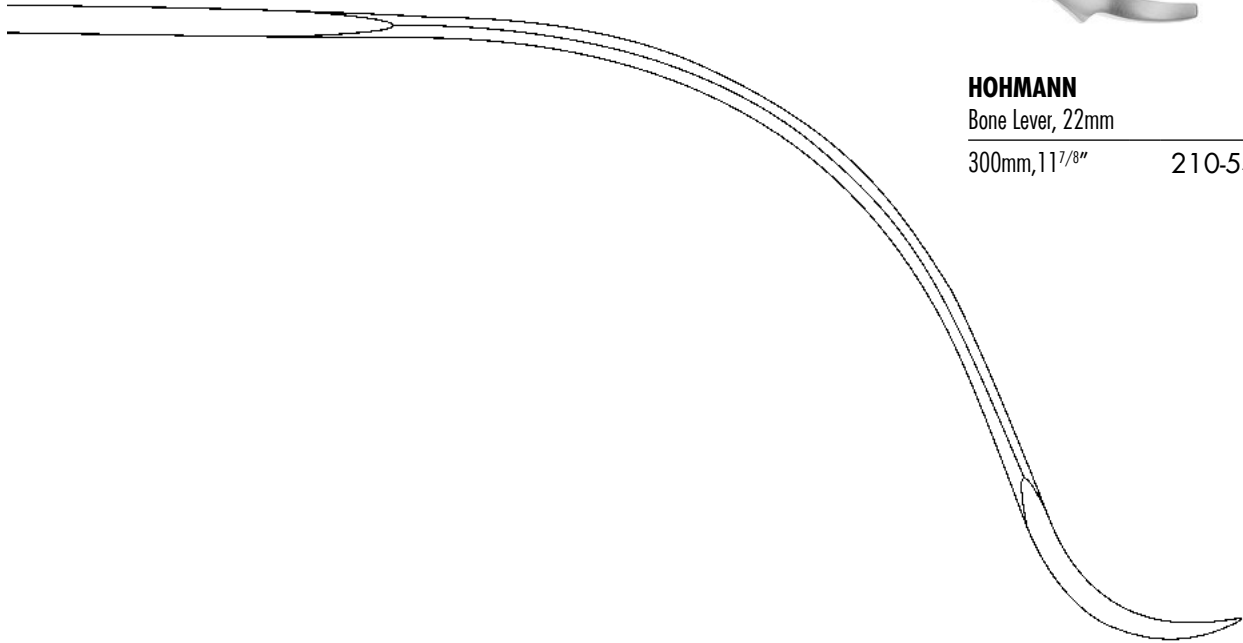

HOHMANN

Bone Lever, 22mm

300mm, 11⁷/₈"

210-545-221

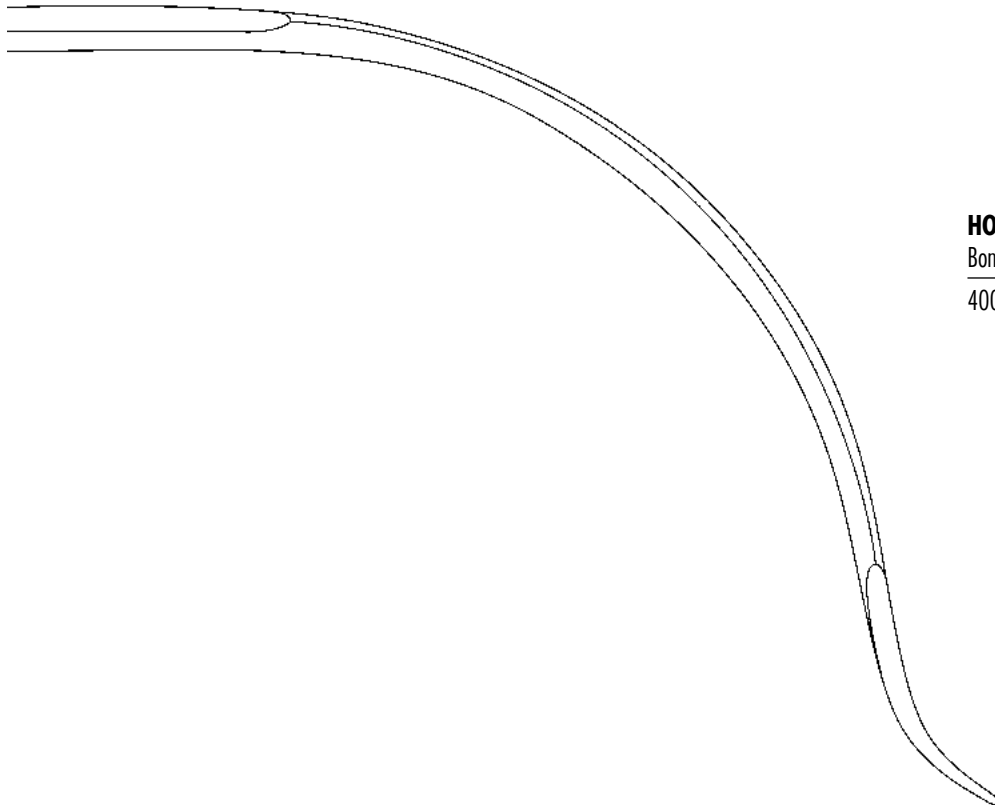
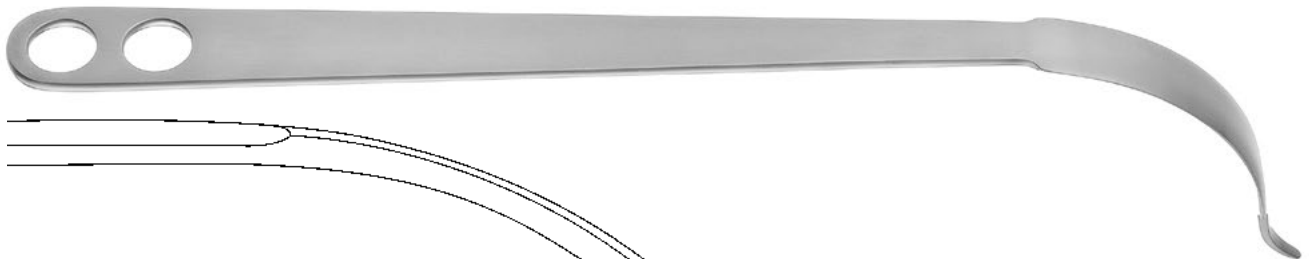

HOHMANN

Bone Lever, 120° curved, 22mm

400mm, 16"

210-541-400

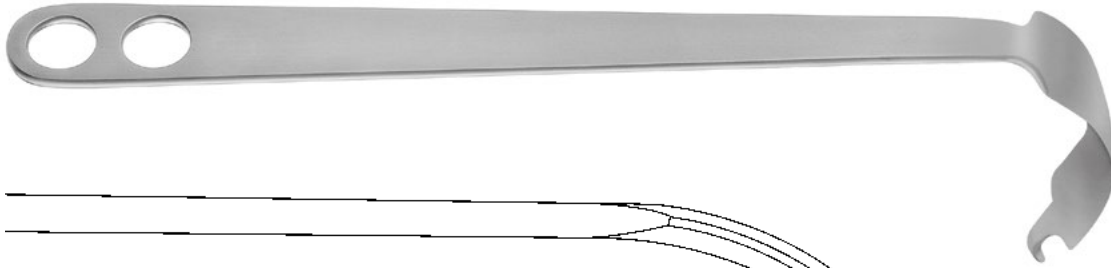

HOHMANN

Bone Lever, 90° curved, 43mm

330mm, 13"

210-541-330

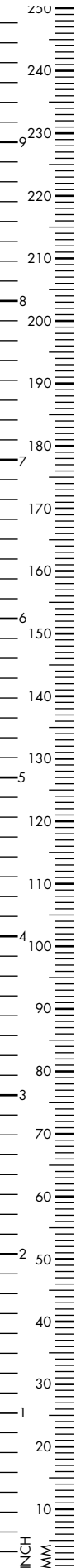

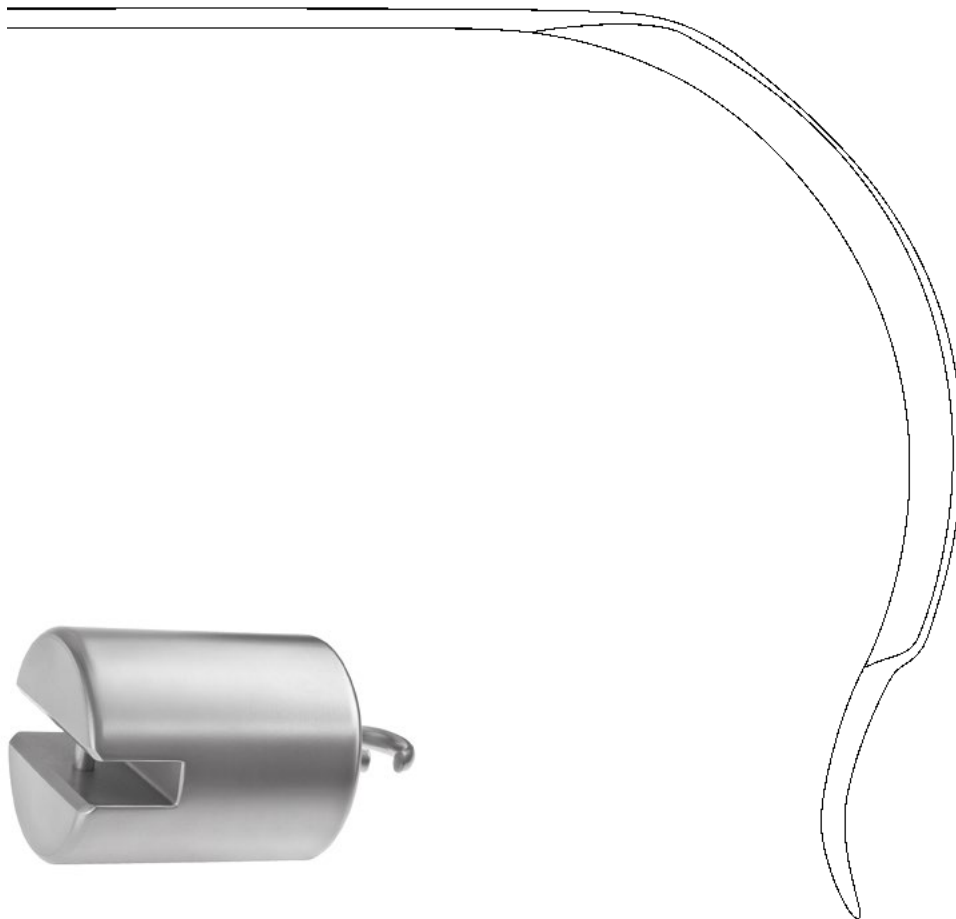
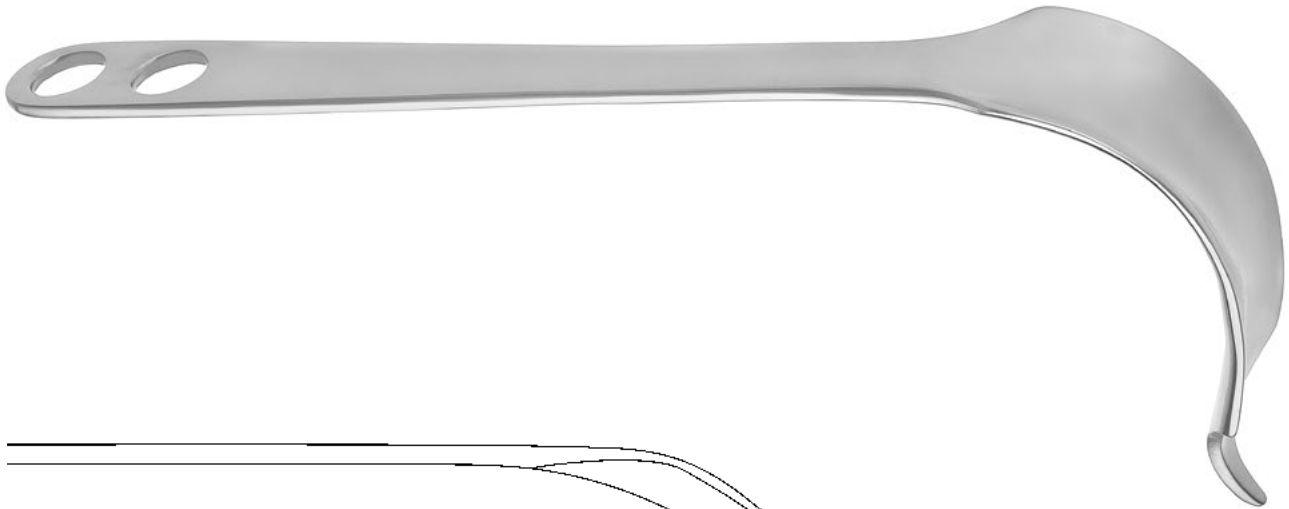

HOHMANN

Bone Lever, 40mm

300mm, 11⁷/₈"

210-545-400



Weight for Hohmann Bone Levers,
combinable

1200gr

210-541-000



HOHMANN
Bone Lever, 22mm,
with opening for impactor

250mm, 9⁷/₈" 210-544-250

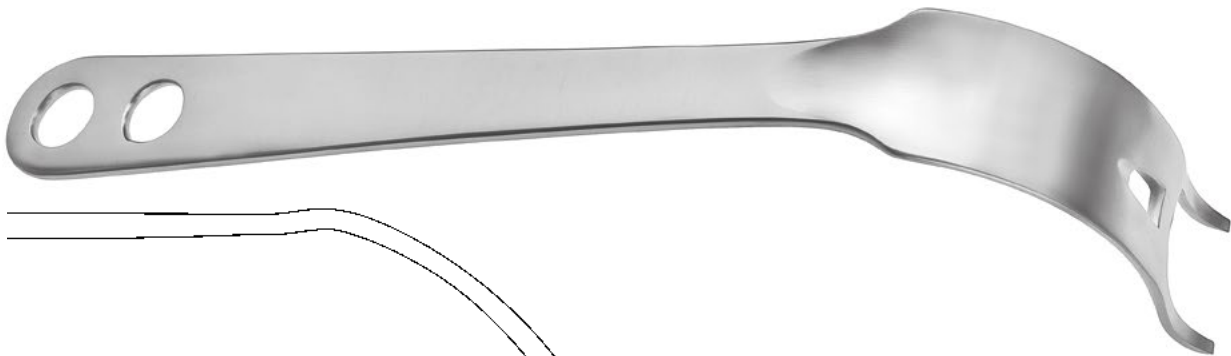
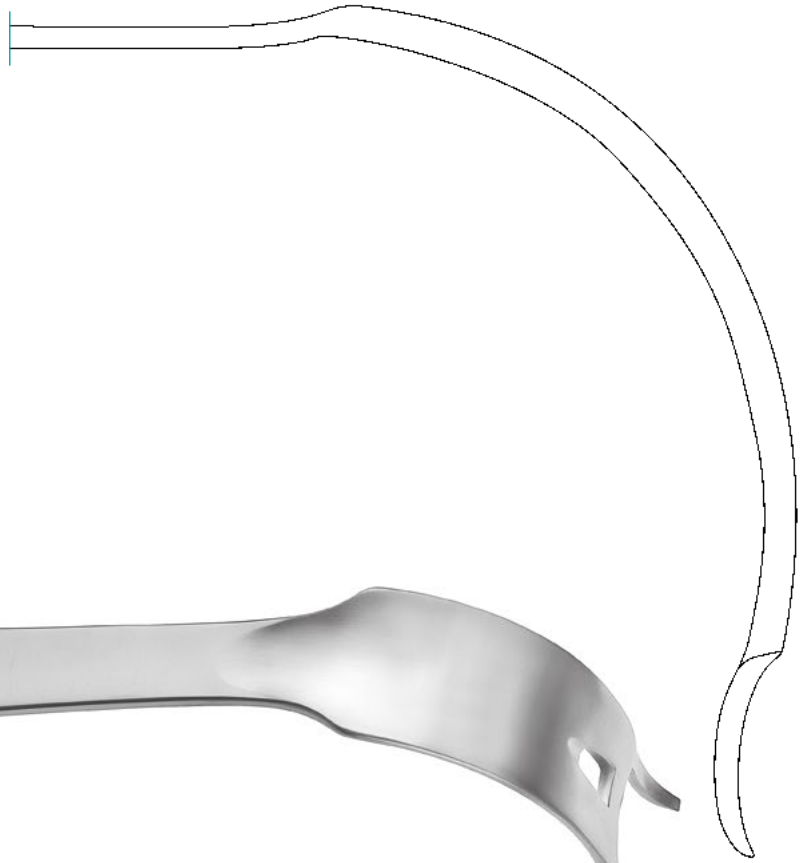

HOHMANN
Bone Lever, 40mm,
with opening for impactor

320mm, 12¹/₂" 210-544-320

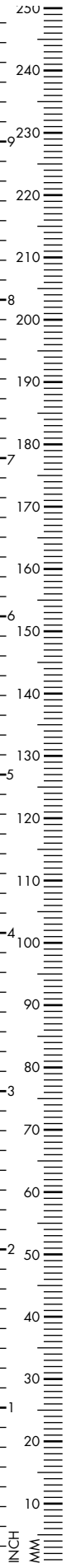
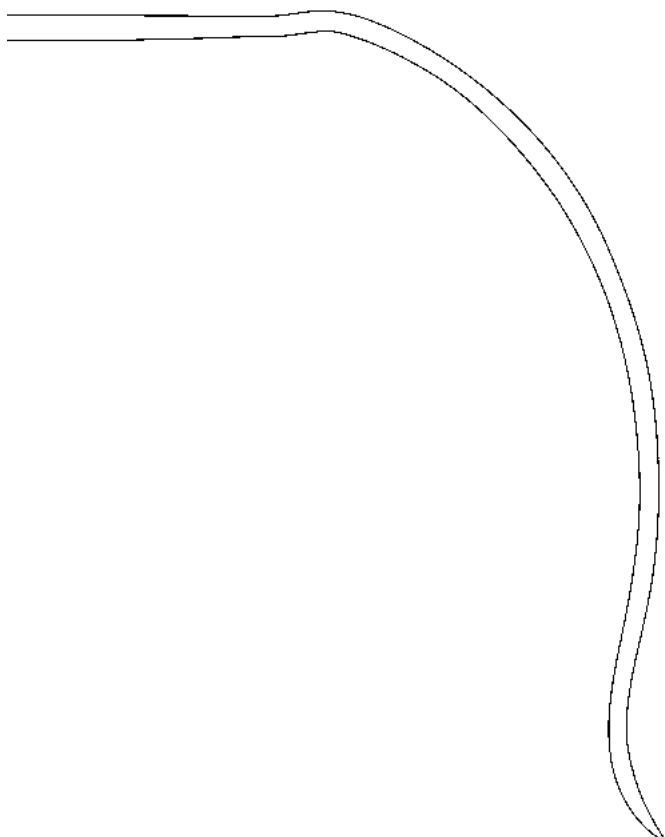



HOHMANN
Bone Lever, 25mm,
with opening for impactor

270mm, 10²/₃" 210-544-270

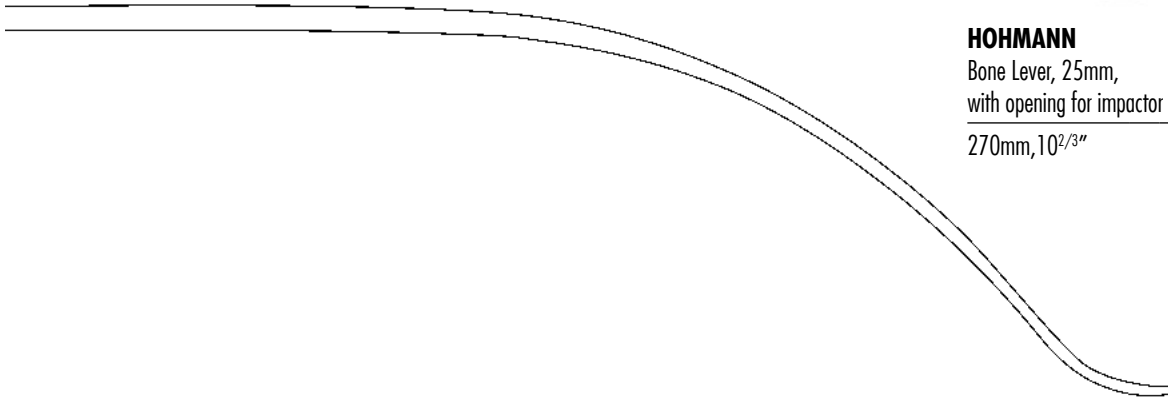

HOHMANN ALDINGER
Bone Lever, 24mm

270mm, 10²/₃" 210-543-270

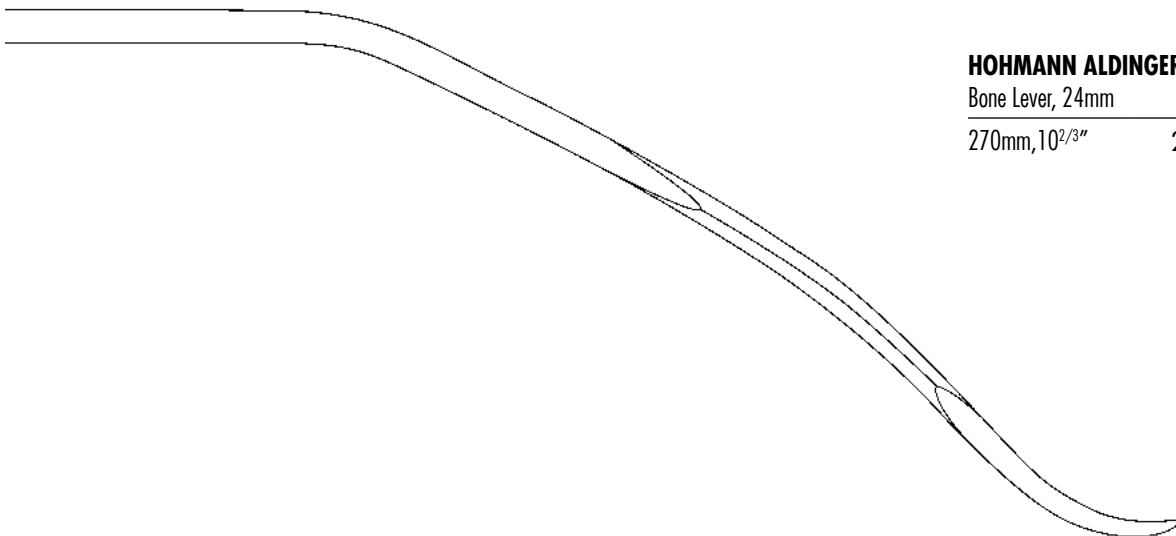

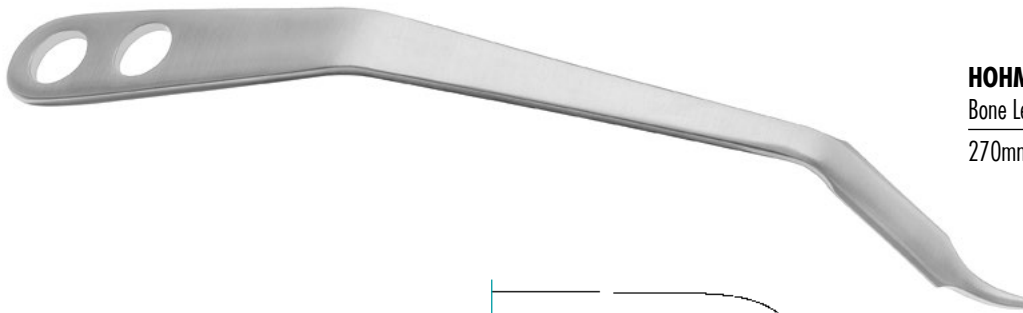

HOHMANN

Bone Lever, 15mm, double-angled handle

270mm, 10²/₃"

210-541-270

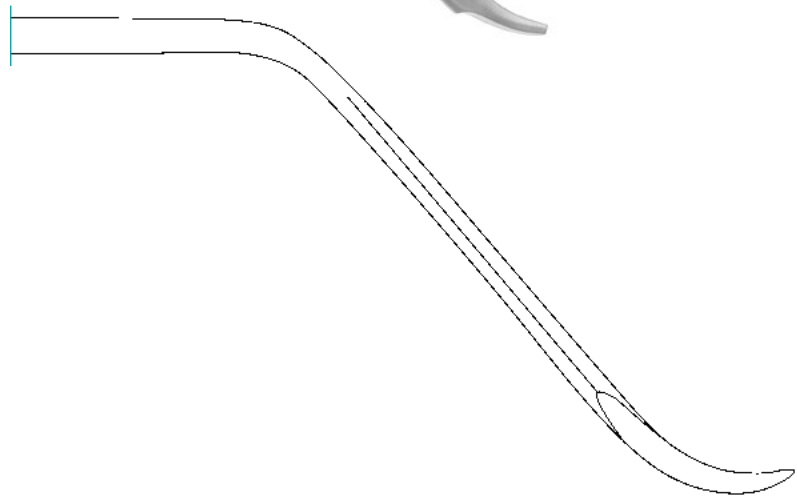

HOHMANN

Bone Lever, 18mm, angled handle

225mm, 8⁷/₈"

210-541-225

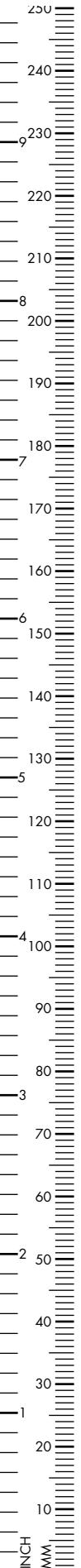
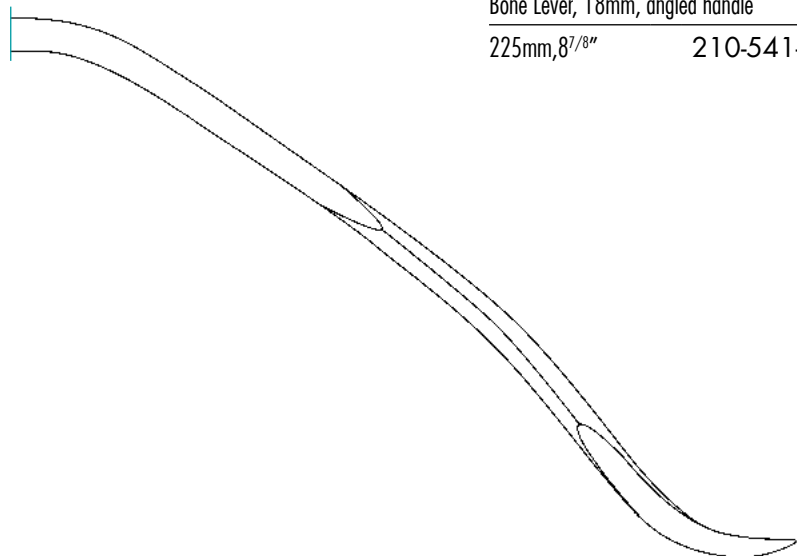

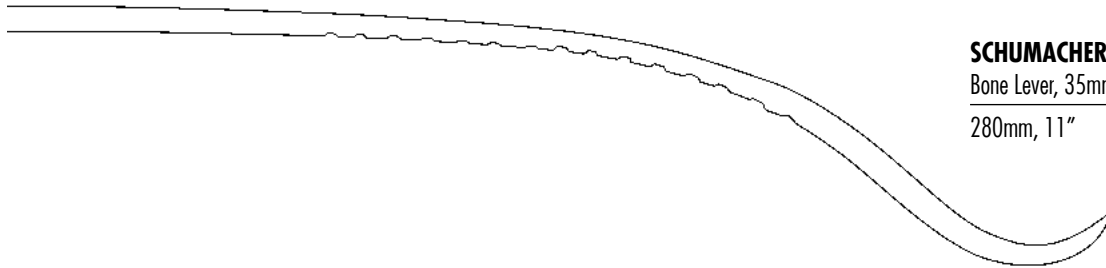

SCHUMACHER

Bone Lever, 35mm

280mm, 11"

210-550-280

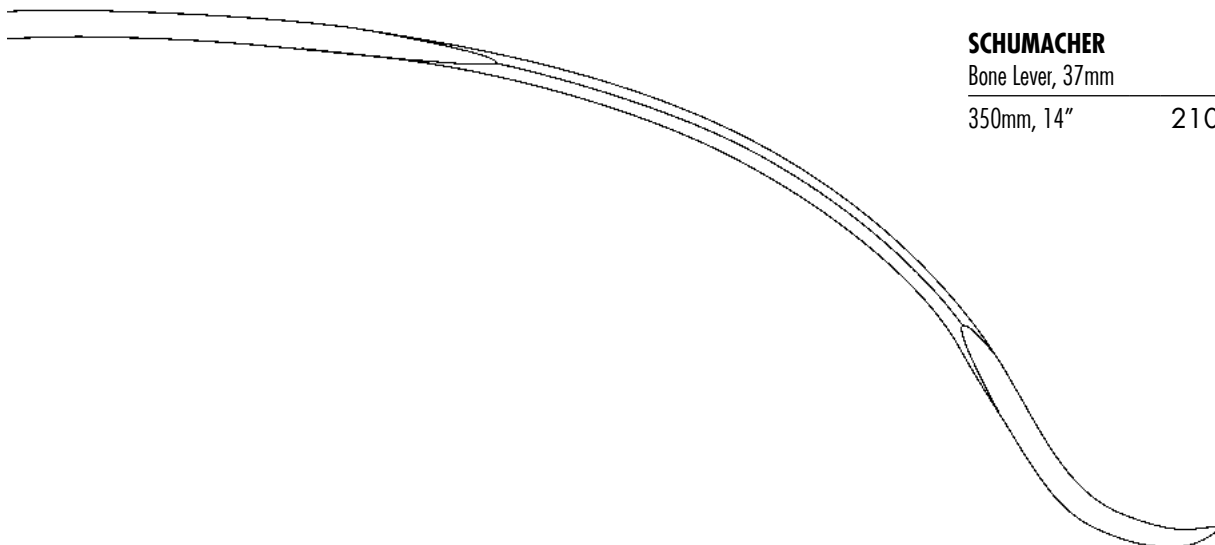
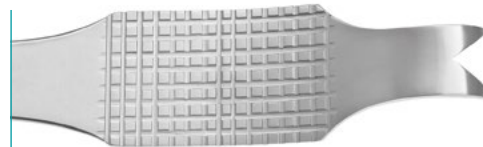

SCHUMACHER

Bone Lever, 37mm

350mm, 14"

210-550-350



WAGNER

Bone Lever, 8mm, synthetic handle

330mm, 13" 210-540-330

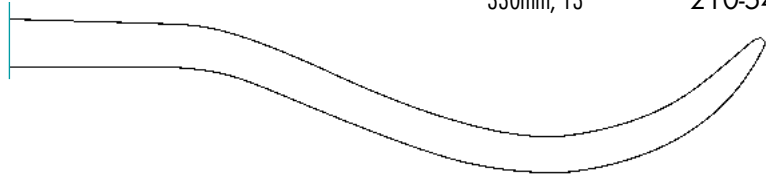

WATSON JONES

Bone Lever

280mm, 11" 210-545-280

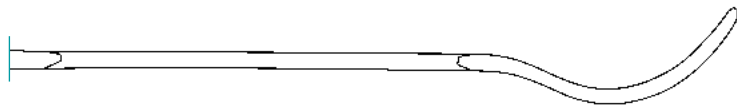

BENNET

Bone Lever, 240mm, 9^{1/2}"

45mm 210-561-045

65mm 210-561-065

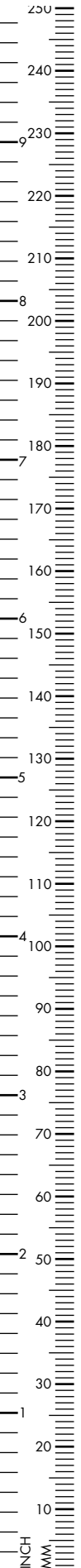

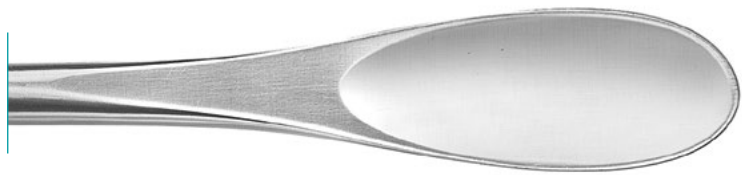

Luxation Lever, synthetic handle, 25mm
280mm, 11" 210-151-280



Luxation Lever, synthetic handle, 25mm
310mm, 12¹/₄" 210-151-310

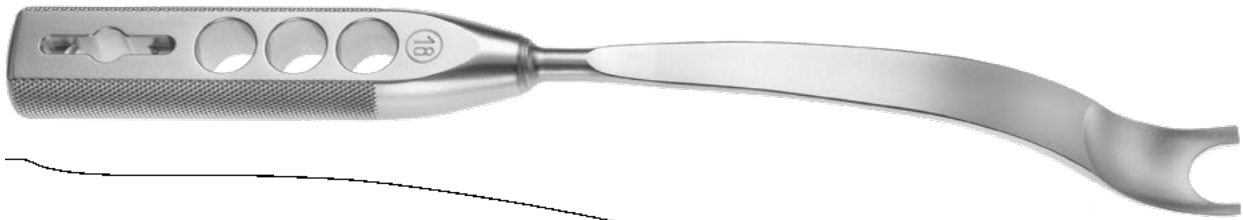

MÜLLER

Femoral Retractor Lever, 26mm wide

330mm, 13"

210-580-330

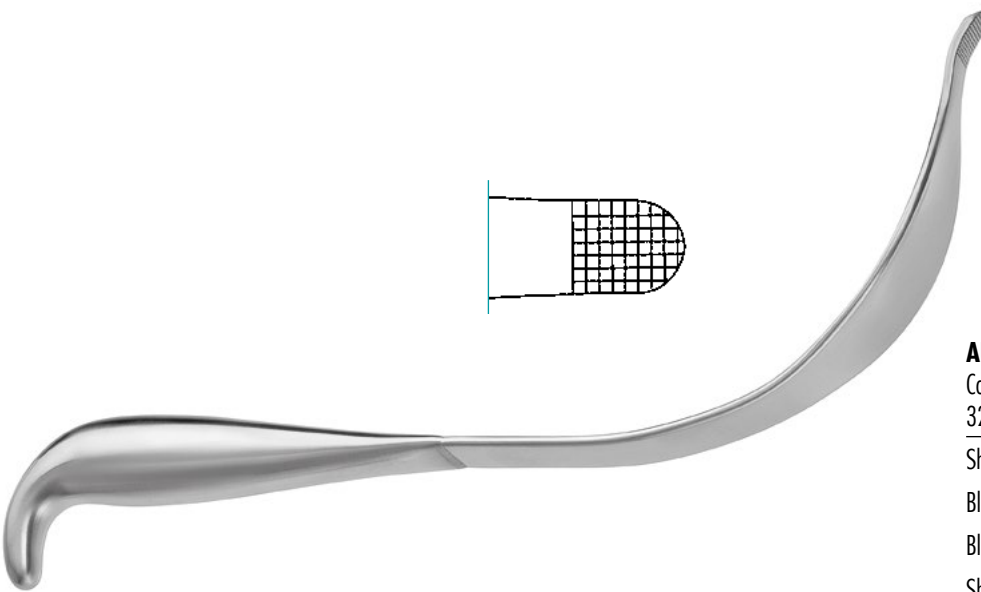

AUFRANC

Cobra Elevator, 260mm, 10¹/₄"

32mm

Sharp, serrated 210-568-260

Blunt, serrated 210-569-260

Blunt, smooth 210-570-260

Sharp, smooth 210-571-260

44mm

Blunt, serrated 210-572-260

Sharp, serrated 210-573-260

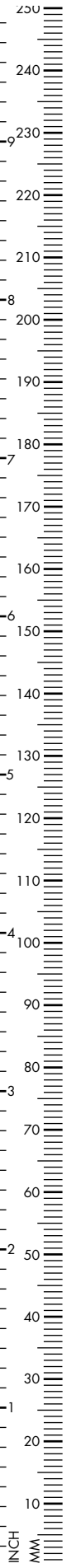



MURPHY LANE

Luxation Lever, 30mm

280mm, 11"

210-575-340



BLOUNT

Shoulder Retractor, 2 prongs

260mm, 10¹/₄"

210-565-260

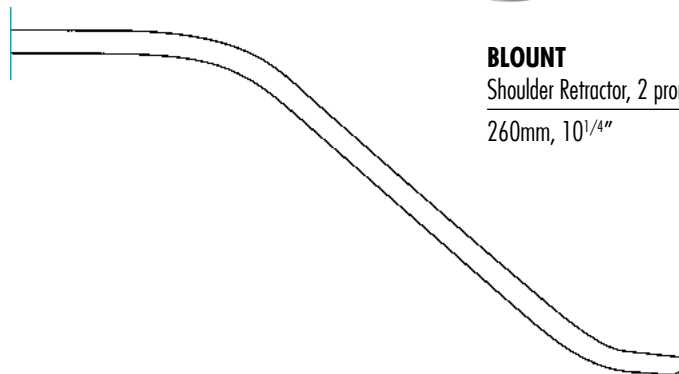



BLOUNT
Bone Lever

260mm, 10¹/₄" 210-563-260

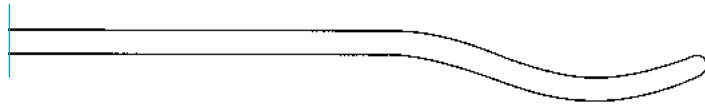

Humeral Head Retractor, strongly curved,
18mm wide, 1 blunt prong

210mm, 8¹/₄" 210-536-180

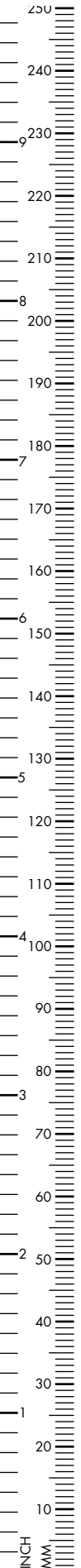

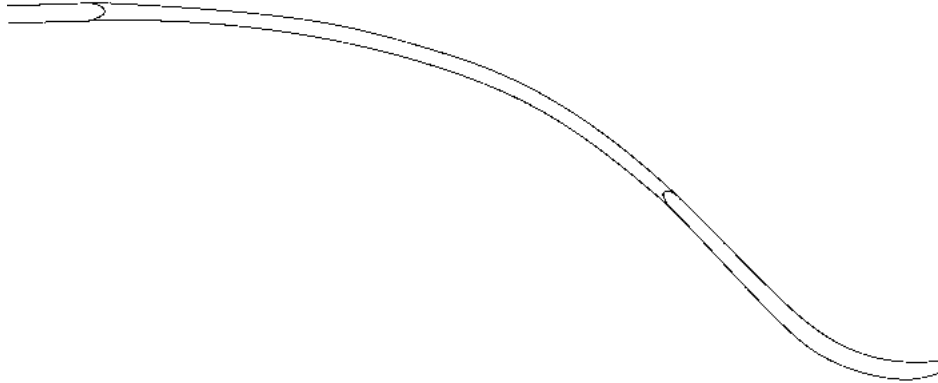

MIOS

Hip Retractor, 90°, femoral neck tip, 22mm

300mm, 11⁷/₈" 210-590-240

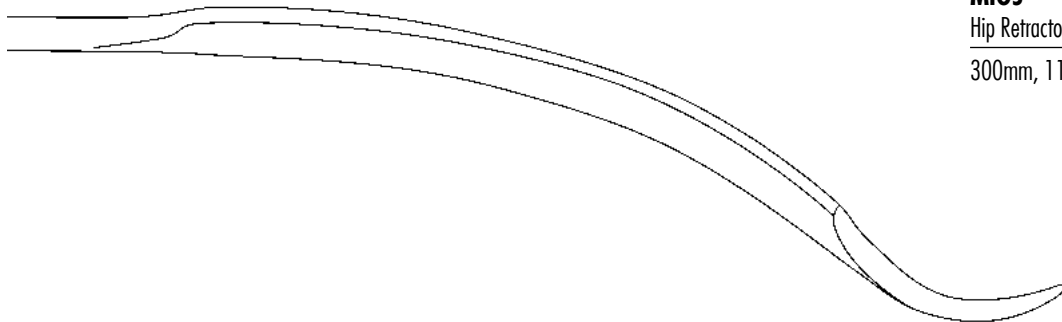

MIOS

Hip Retractor, 45°, blunt tip, 28mm

300mm, 11⁷/₈" 210-545-302

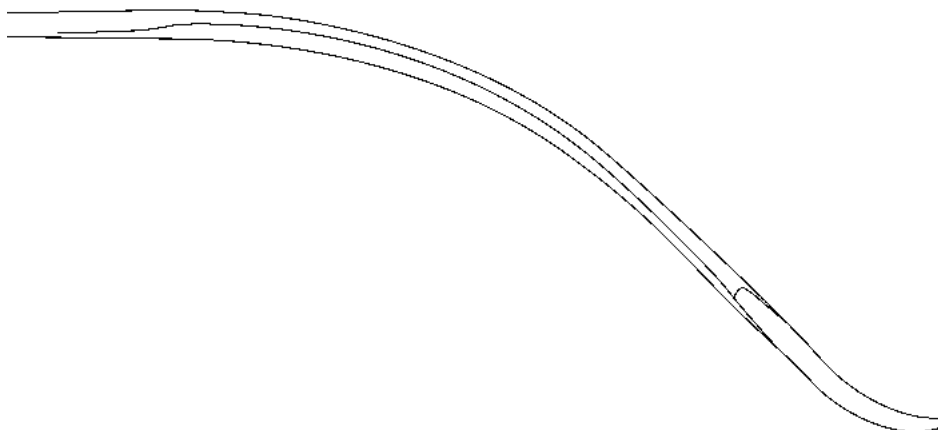

MIOS

Hip Retractor, 45°, V-tip, 28mm

300mm, 11⁷/₈" 210-545-300



MIOS

Hip Retractor, 30°, V-tip, 28mm

315mm, 12¹/₂"

210-530-315

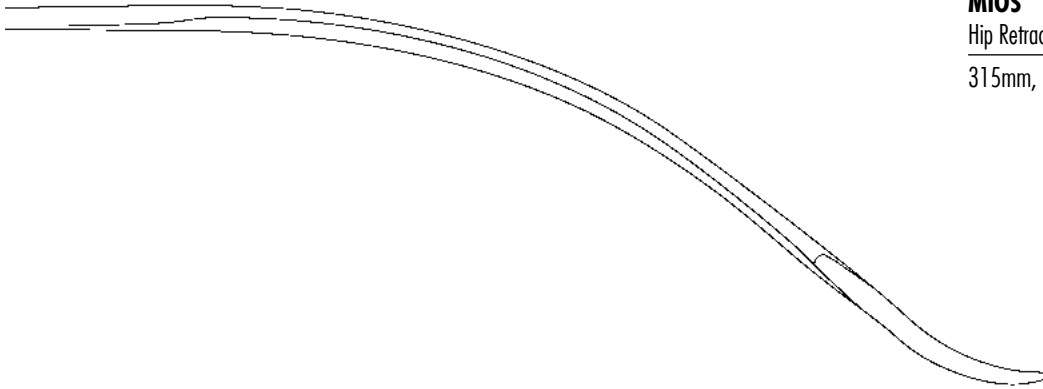

MIOS

Hip Retractor, 30°, U-tip, 28mm

315mm, 12¹/₂"

210-520-315

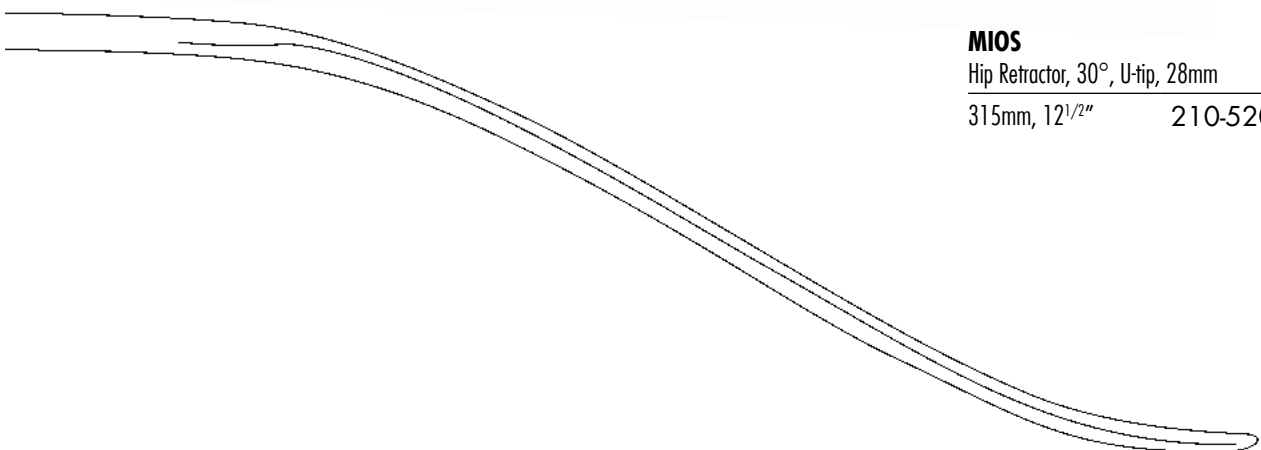

250
240
230
220
210
200
190
180
170
160
150
140
130
120
110
100
90
80
70
60
50
40
30
20
10
INCH
MM

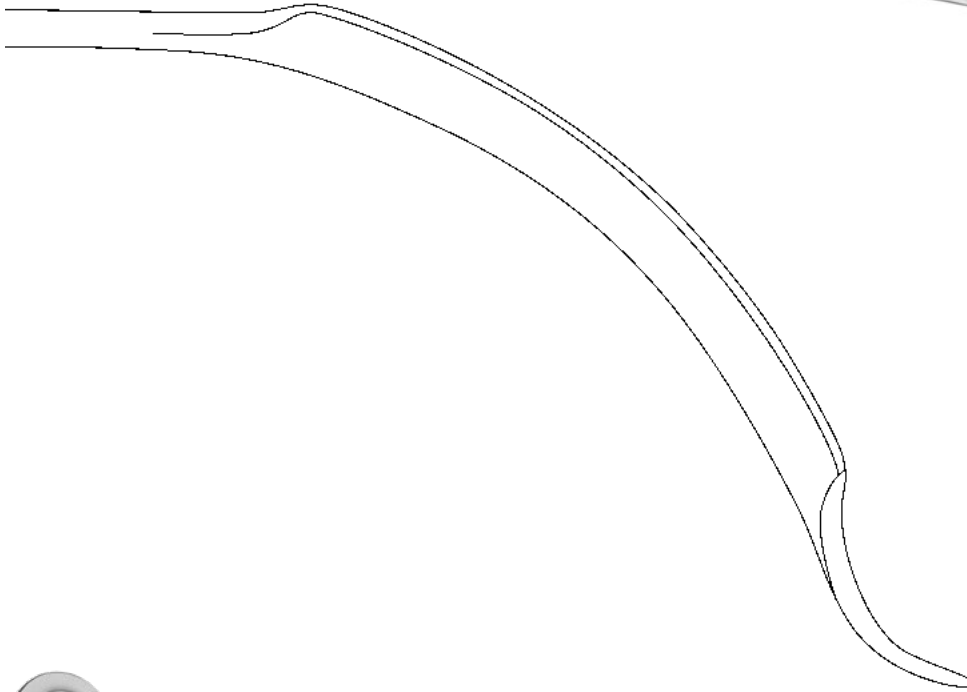

MIOS

Hip Retractor, 90°, blunt tip, 40mm

300mm, 11^{7/8}"

210-590-241



(210-590-001)

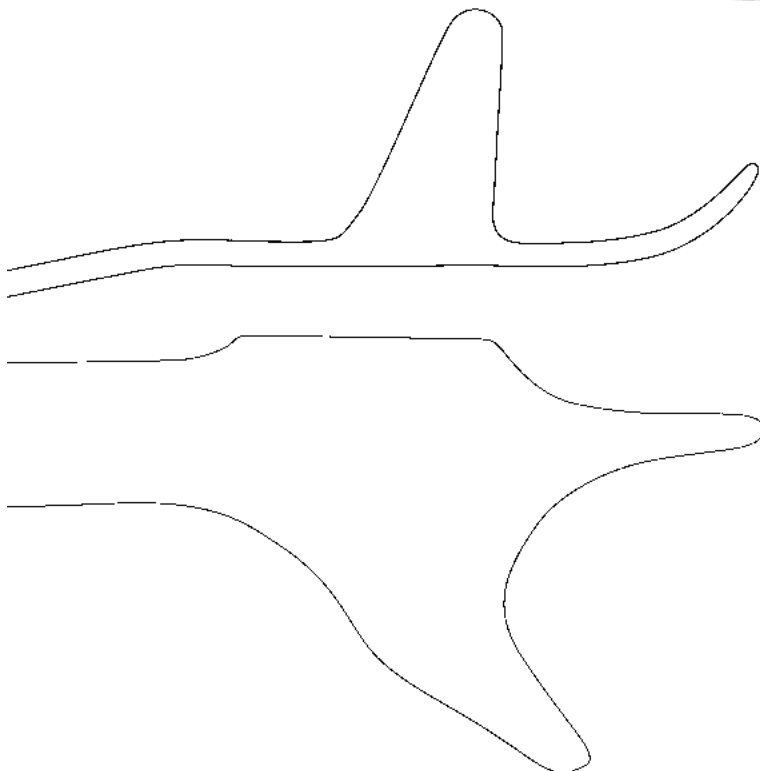

Infero - Posterior Acetabular
Capsule Retractor

left 210-590-001

right 210-590-002



FUKUDA

Retractor, 180mm, 7"

small, 32mm blade 259-901-180

large, 38mm blade 259-902-180



FUKUDA KUJAT

Retractor, 225mm, 8^{7/8}"

small, 30mm blade 259-900-225

large, 35mm blade 259-903-225



FUKUDA

Retractor, 170mm, 6^{2/3}"

small, 32mm blade 259-904-032

large, 40mm blade 259-904-040

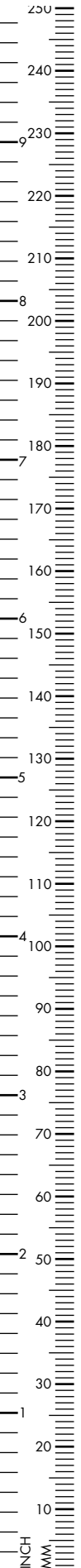



DARRACH

Shoulder Elevator, 260mm, 10^{1/4}"

9mm wide tip	259-260-009
12mm wide tip	259-260-012
16mm wide tip	259-260-016
20mm wide tip	259-260-020
<hr/>	
360mm, 14 ^{1/8} "	
25mm wide tip	259-260-025



KÖLBEL

Shoulder Elevator, 2 sharp prongs



15mm wide tip	210-537-281
20mm wide tip	210-537-282
15mm wide tip, hook end	210-537-283
20mm wide tip, hook end	210-537-284
<hr/>	
slightly curved, smooth end	
18mm wide tip	210-537-285

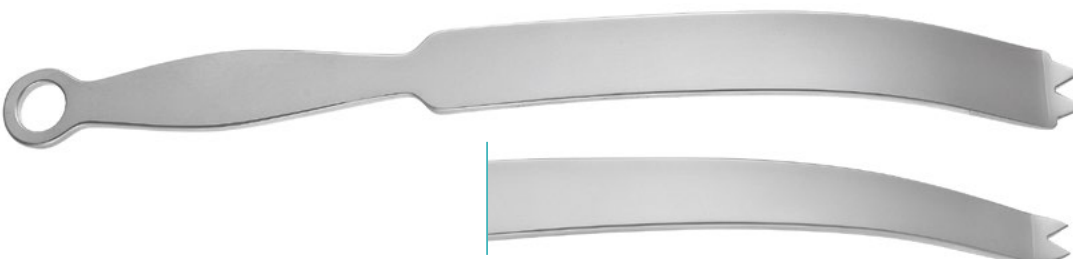

Thin Glenoid Neck Retractor
280mm, 11"

wide, 22mm	259-258-422
narrow, 14mm	259-258-414

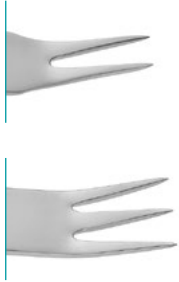
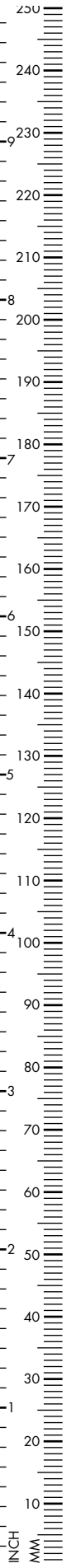

Capsule Retractor for use in Bankhart surgery
250mm, 9⁷/₈"

1 prong	259-258-251
2 prongs	259-258-252
3 prongs	259-258-253



BRISTOW BANKHART

Capsule Retractor, 20mm wide

250mm, 9 ⁷ / ₈ "	259-254-020
--	-------------



BRISTOW BANKHART

Soft Tissue Retractor, 3 blunt prongs
21mm blade width

190mm, 7 ¹ / ₂ "	259-253-180
--	-------------



Anterior Glenoid Neck Retractor
 25mm wide tip
 280mm, 11" 259-258-100



Agrawal Talon Retractor, 40mm wide tip
 200mm, 8" 259-258-150



Posterior Glenoid Neck Retractor,
 30mm wide blade
 250mm, 9⁷/₈" 259-258-200



GOLDSTEIN

Glenoid Neck Retractor, 18mm wide tip at teeth

215mm, 8¹/₂"

259-258-400



BHATTMAN

Humeral Head Retractor,

36mm wide blade

255mm, 10"

259-258-600



SKID

Bone Elevator, double ended

280mm, 11"

259-258-700

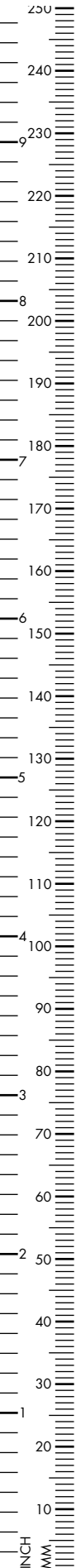



Humeral Head Retractor

180mm, 7"

259-258-500



Humeral Head Retractor

190mm, 7^{1/2}"

259-258-550



Deltoid Retractor, 30mm wide head

200mm, 8"

259-258-300



BROWNE

Deltoid Retractor, 60x65mm blade

270mm, 10²/₃" 259-258-270



BRISTOW BANKART

Humerus Retractor,
2 blunt prongs, hollow handle

25 x 102mm 259-252-180



CHANDLER

Tissue Retractor, 230mm, 9"

16mm wide tip 259-258-316

19mm wide tip 259-258-319

25mm wide tip 259-258-325

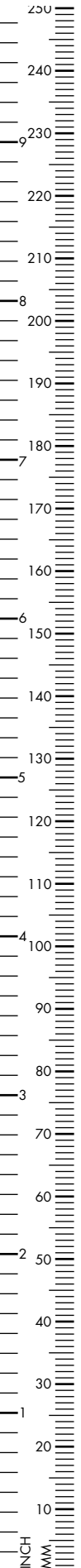

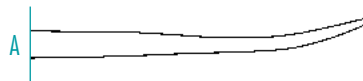

KOENIG

Elevator, 4.5mm wide, 155mm, 6¹/₈"

A Slightly curved	210-551-150
B Strongly curved	210-552-150

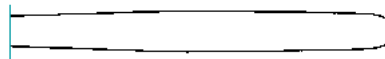

Phalangeal Elevator, 5.5mm wide,
bayonet strongly curved

165mm, 6 ¹ / ₂ "	210-523-175
--	-------------

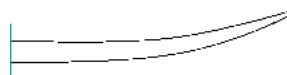

WILLIGER

Elevator, 160mm, 6¹/₄"

5.5mm	210-395-160
7.0mm	210-396-170

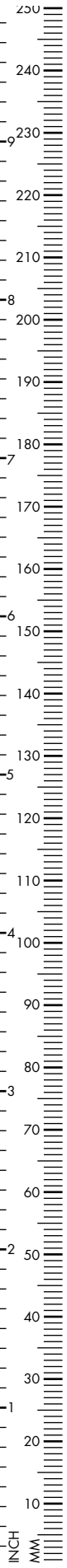

CAIRNS
Skull Flap Elevator

175mm, 6⁷/₈" 250-066-141

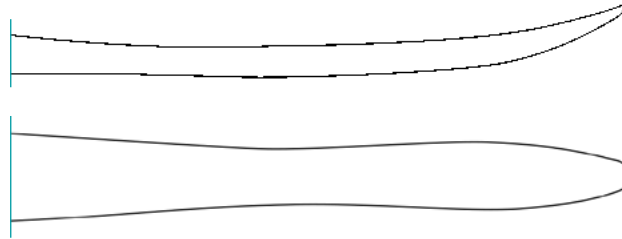

QUERVAIN
Elevator, 6mm

200mm, 8" 210-386-200

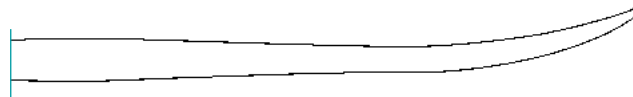

SEBILEAU
Elevator, 5mm

175mm, 6⁷/₈" 210-395-175

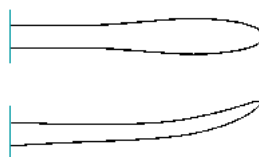



LANGENBECK

Elevator, 200mm, 8"

7mm 210-395-200

10mm 210-397-200

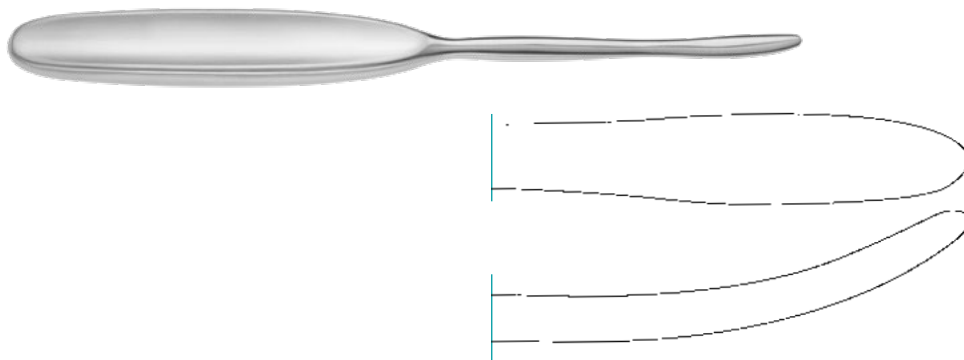

LANGENBECK

Elevator, 6.5mm

210mm, 8^{1/4}" 210-396-210

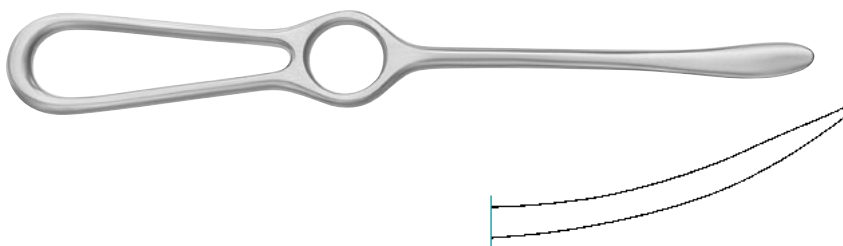

LANGENBECK

Elevator, 11mm

230mm, 9" 210-398-230

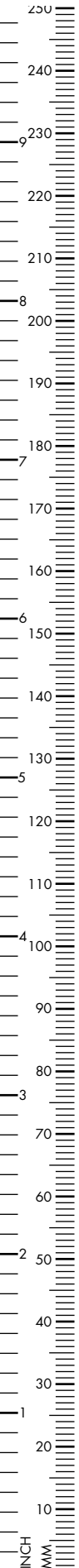

HOWARTH

Elevator, double-ended, sharp/blunt

215mm, 8^{1/2}"

420-552-215

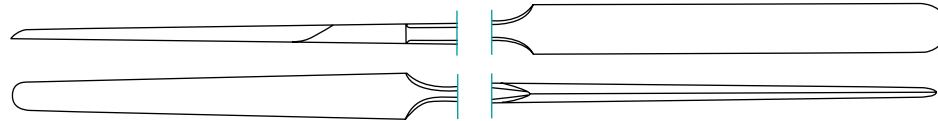

KILLIAN

Elevator, double-ended, sharp/blunt

185mm, 7^{1/4}"

420-541-180



COTTLE

Elevator, double-ended, graduated,
sharp/sharp

200mm, 8"

420-550-230

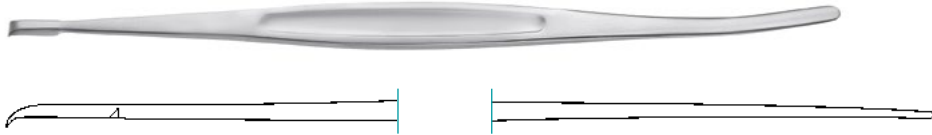

HILL

Elevator, double-ended, blunt/sharp

220mm, 8^{2/3}"

420-554-220

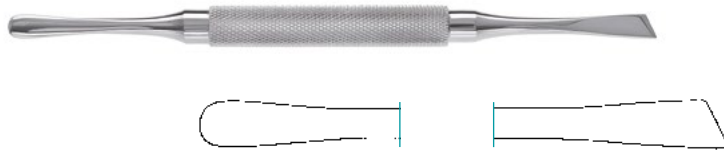

MEAD

Elevator, double-ended, oblique/rounded

165mm, 6^{1/2}"

500-446-165

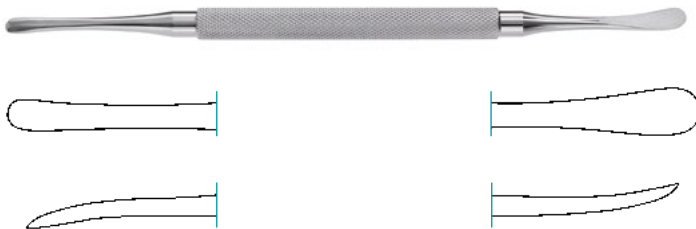

MOLT

Elevator, double-ended, sharp/sharp

165mm, 6^{1/2}"

500-440-180

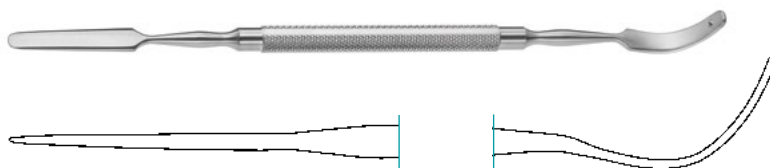

MCDONALD

Elevator, double-ended, straight / curved

190mm, 7^{1/2}"

210-527-190

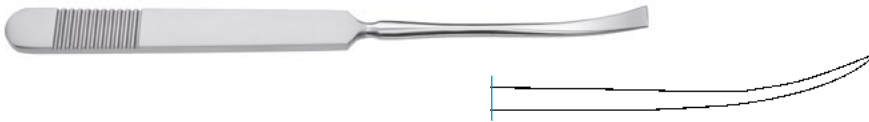

PENNYBAKER

Elevator, sharp, 6mm

150mm, 6"

210-488-170



JANSEN

Periosteal Elevator, curved

165mm, 6 1/2"

210-303-165



LANGENBECK

Periosteal Elevator, 14mm, hollow handle

180mm, 7"

210-301-180

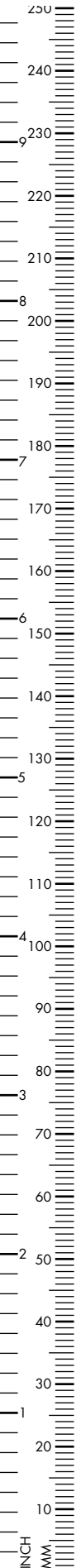



KEY

Elevator, 180mm, 7"

3mm	210-489-003
-----	-------------

6mm	210-489-006
-----	-------------

190mm, 7^{1/2}"

10mm	210-489-010
------	-------------

12mm	210-489-012
------	-------------

13mm	210-489-013
------	-------------

16mm	210-489-016
------	-------------

200mm, 8"

19mm	210-489-019
------	-------------

210mm, 8^{1/4}"

25mm	210-489-025
------	-------------



CREGO

Elevator, 200mm, 8"

7mm	170-492-001
-----	-------------

14mm	170-492-004
------	-------------

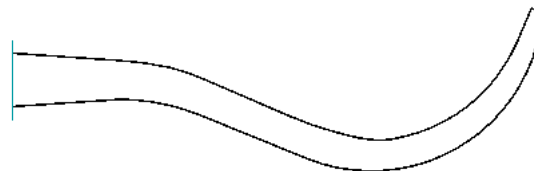

COBB

Elevator, 240mm, 9^{1/2}"

9mm	210-401-095
-----	-------------

13mm	210-401-127
------	-------------

19mm	210-401-019
------	-------------

25mm	210-401-025
------	-------------

32mm	210-401-032
------	-------------



COBB

Spinal Elevator, 240mm, 9¹/₂"

9mm	210-400-001
13mm	210-400-002
19mm	210-400-003
25mm	210-400-004
32mm	210-400-005

290mm, 11¹/₂"

9mm	210-402-009
13mm	210-402-013
19mm	210-402-019
25mm	210-402-025
32mm	210-402-032



COBB

Elevator, semi-sharp, slightly curved, synthetic handle, 250mm, 9⁷/₈"

10mm	210-420-010
13mm	210-420-013
19mm	210-420-019
25mm	210-420-025



COBB

Elevator, synthetic handle, 340mm, 13¹/₂"

10mm	210-405-010
15mm	210-405-015
20mm	210-405-020
25mm	210-405-025
30mm	210-405-030
35mm	210-405-035

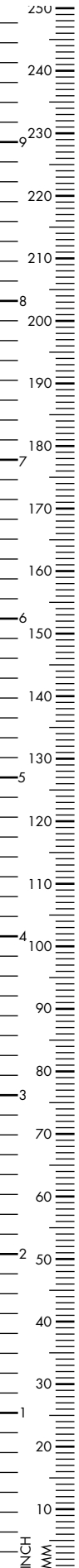

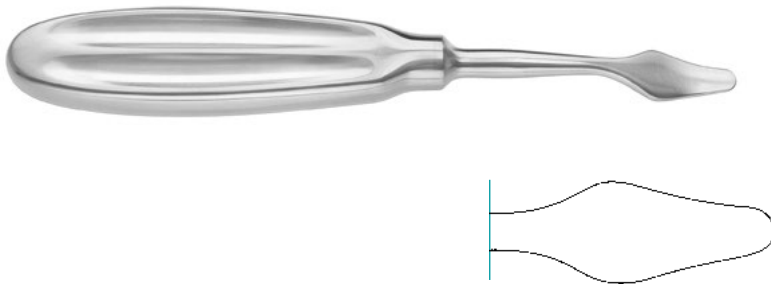

CHANDLER

Elevator, 180mm, 7"

13mm	210-490-013
------	-------------

200mm, 8"	
-----------	--

19mm	210-490-019
------	-------------

25mm	210-490-025
------	-------------

250mm, 9 ⁷ / ₈ "	
--	--

31mm	210-491-030
------	-------------



LANE

Periosteal Elevator, 190mm, 7¹/₂"

7mm	210-483-190
-----	-------------

10mm	210-484-190
------	-------------



SAYRE

Periosteal Elevator, double-ended, 9.5mm,
170mm, 6²/₃"

sharp	210-397-170
-------	-------------

blunt	210-340-170
-------	-------------

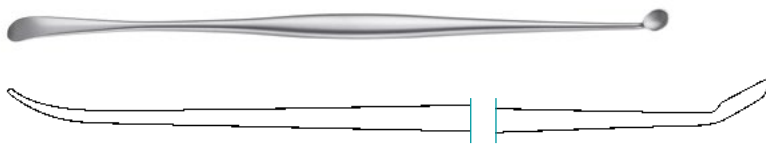
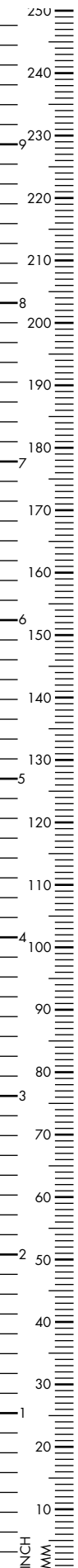

PENFIELD

Dissector, Fig. 1

175mm, 6^{7/8}"

250-691-175

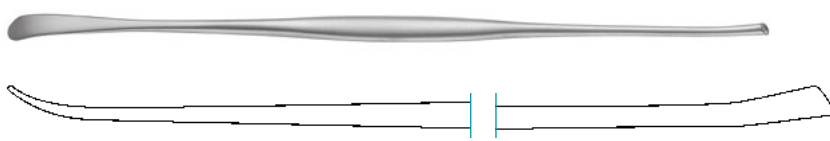

PENFIELD

Dissector, Fig. 2

195mm, 7^{3/4}"

250-692-195

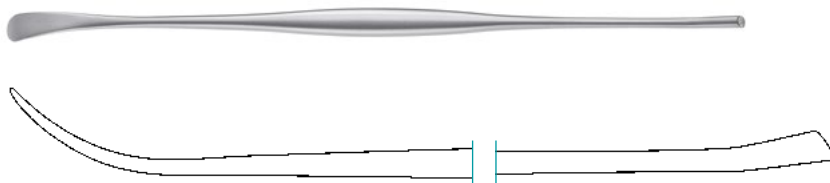

PENFIELD

Dissector, Fig. 3

195mm, 7^{3/4}"

250-693-195



PENFIELD

Dissector, Fig. 4

205mm, 8¹/₈"

250-694-215

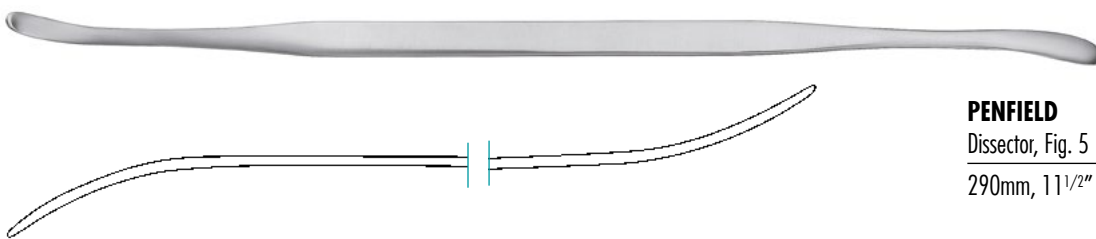

PENFIELD

Dissector, Fig. 5

290mm, 11¹/₂"

250-695-290

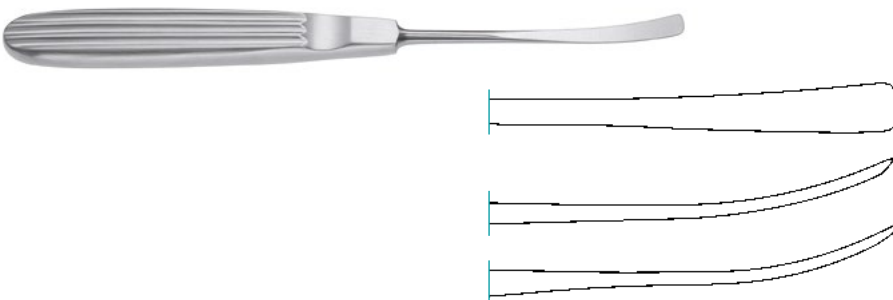

CASPAR

Dissector, 6.2mm, 180mm, 7"

sharp 259-185-328

blunt 259-185-329



MCKENTY

Raspatory, 150mm, 6"

4mm	420-547-004
5mm	420-547-005



KOENIG

Raspatory, 5mm

150mm, 6"	210-553-150
-----------	-------------



FREER

Raspatory, 4mm, 190mm, 7 1/2"

blunt	420-547-190
sharp	420-548-190

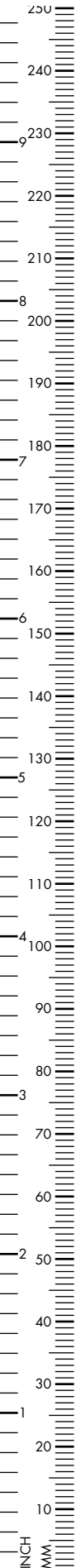



SEWALL

Raspatory, 6mm, blunt

200mm, 8"

420-549-200



KILLIAN

Raspatory, 6mm, sharp/blunt

180mm, 7"

420-540-180

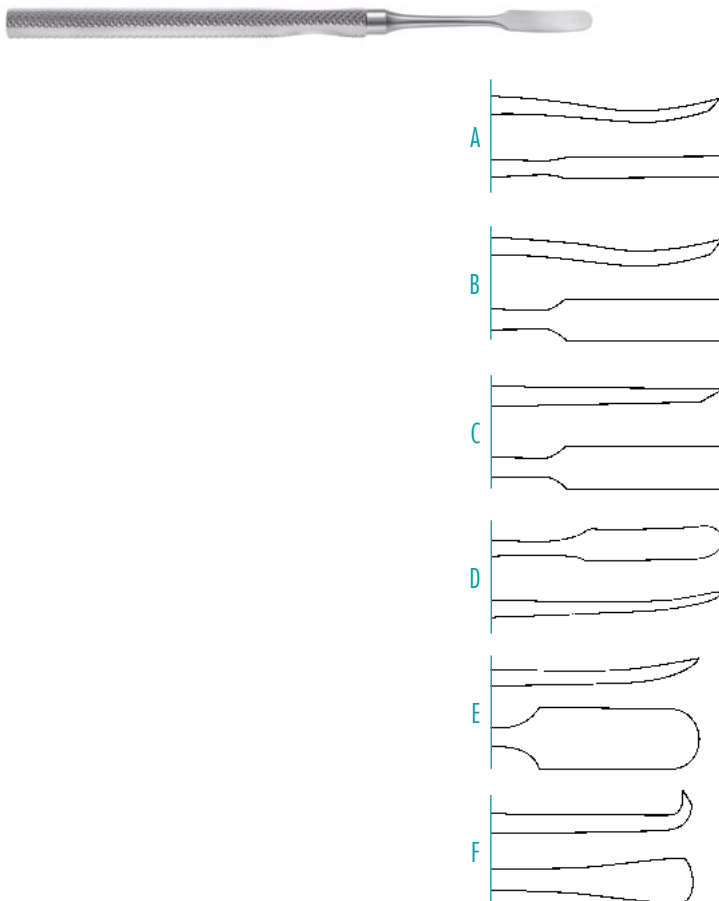

MANNERFELT

Raspatory, 155mm, 6¹/₈"

A 3mm 420-557-001

B 6mm 420-557-002

C 6mm 420-557-003

D 6mm 420-556-004

E 8mm 420-556-005

F 6mm 420-557-008

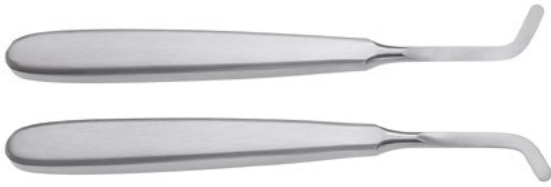
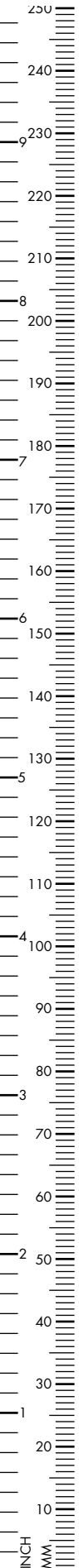

Raspatory, 4mm, 140mm, 5¹/₂"

Curved left 210-552-140

Curved right 210-551-140

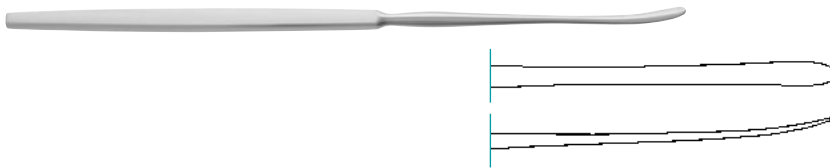

HALLE

Raspatory, 4mm, blunt

180mm, 7" 420-544-165



WILLIGER

Raspatory, 4mm

130mm, 5¹/₈" 210-434-130

160mm, 6¹/₄"

5mm 210-436-160

7mm 210-438-160



JOSEPH

Raspatory, 4mm

160mm, 6¹/₄"

210-396-160



LEMPERT

Raspatory, 4mm

185mm, 7¹/₄"

210-397-185



COTTLE

Raspatory, 8mm, sharp

190mm, 7¹/₂"

210-438-195



LANDOLT

Raspatory, 4.5mm

175mm, 6⁷/₈"

210-439-175

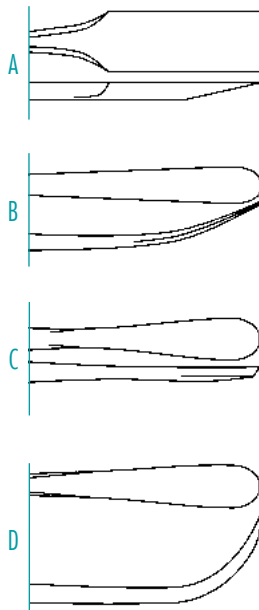

ADSON

Raspatory, 170mm, 6²/₃"

A 8mm, sharp 210-484-170

B 8mm, blunt 210-485-170

C 7mm, semi-sharp 210-486-170

D 7mm, semi-sharp 210-487-170

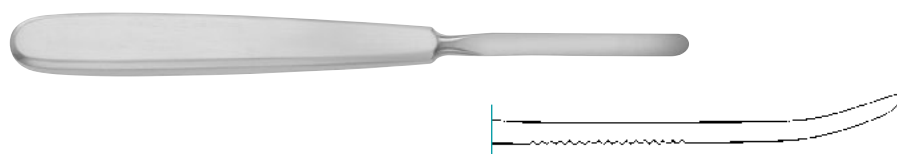

Raspatory, 170mm, 6²/₃"

6mm 210-439-006

8mm 210-439-008

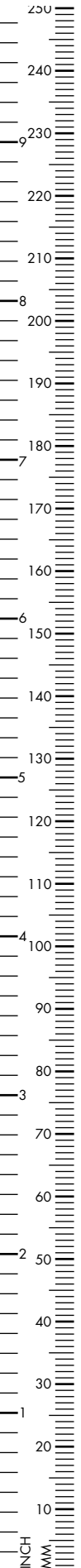

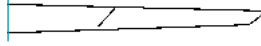

Raspatory, synthetic handle,
6mm

190mm, 7¹/₂" 210-434-180

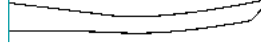

3mm

185mm, 7¹/₄" 210-432-185



6mm

185mm, 7¹/₄" 210-433-180



6mm

185mm, 7¹/₄" 210-432-180

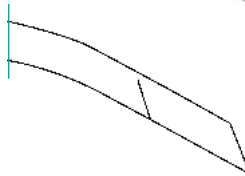

Raspatory, synthetic handle,
13mm

185mm, 7¹/₄" 210-433-185

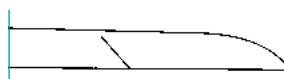

14mm

200mm, 8" 210-430-200

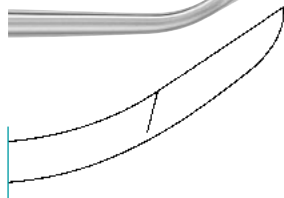

14mm

200mm, 8" 210-431-000

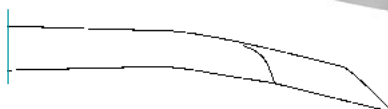

Raspatory, 13mm, synthetic handle

230mm, 9" 210-433-230

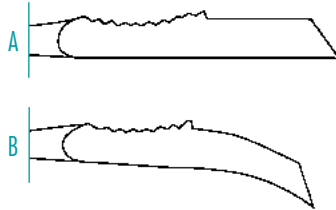

FARABEU

Raspatory, 12.5mm, 150mm, 6"

A straight 210-310-150

B curved 210-311-150

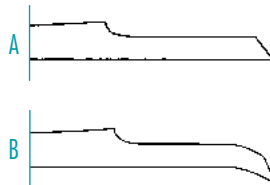

FARABEU COLLIN

Raspatory, 11mm, 155mm, 6¹/₈"

A straight 210-312-155

B curved 210-313-155

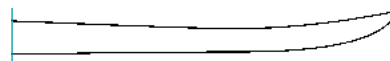

SEDILLOT

Raspatory, 18mm, hollow handle

190mm, 7¹/₂" 210-316-190

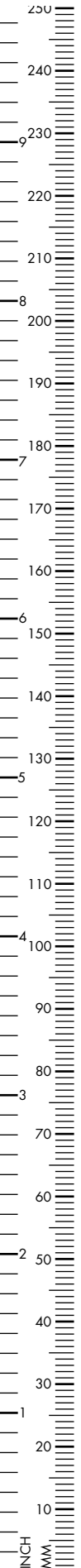



KRAEMER

Raspatory, 10mm, round blade

185mm, 7¹/₄"

210-313-185



KRAEMER

Raspatory, 10mm, straight blade

185mm, 7¹/₄"

210-313-185

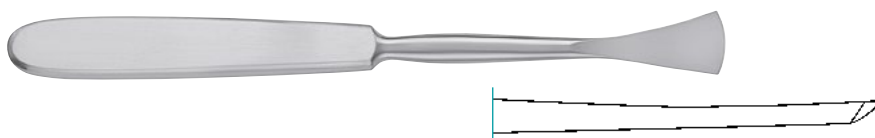

LANGENBECK

Raspatory, 16mm, hollow handle

190mm, 7¹/₂"

210-303-190

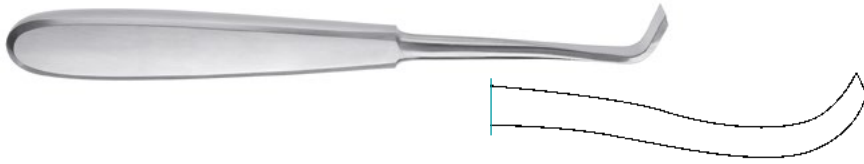

SCHNEIDER

Raspatory, 13mm

175mm, 6⁷/₈"

210-315-175

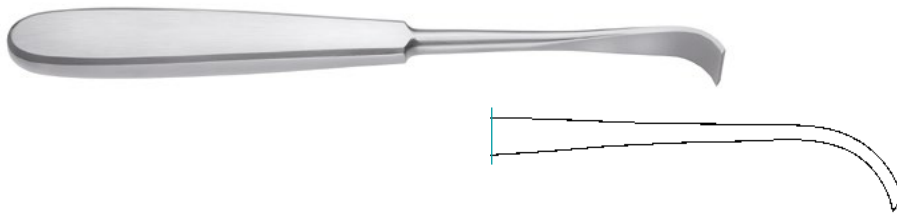

SCHNEIDER SAUERBRUCH

Raspatory, 13mm

190mm, 7¹/₂"

210-315-190

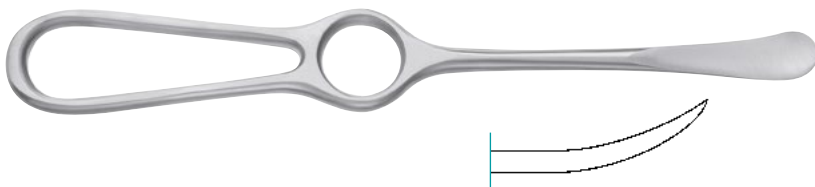

SEDILLOT

Raspatory, 15mm

210mm, 8¹/₄"

210-315-210

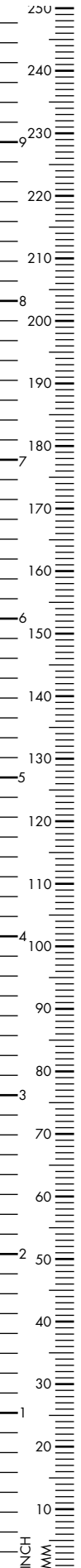



LAMBOTTE

Raspatory, 210mm, 8¹/₄"

5mm	210-461-005
10mm	210-461-210
15mm	210-462-210
20mm	210-463-210
25mm	210-464-210



ALEXANDER

Periosteotome, 12mm

210mm, 8 ¹ / ₄ "	210-440-200
--	-------------



MCGLAMRY

Raspatory, 210mm, 8¹/₄"

9mm	170-160-010
11mm	170-160-012
15mm	170-160-015
17mm	170-160-017



Trapeziectomy screw with handle

190mm, 7 ¹ / ₂ "	225-810-500
--	-------------

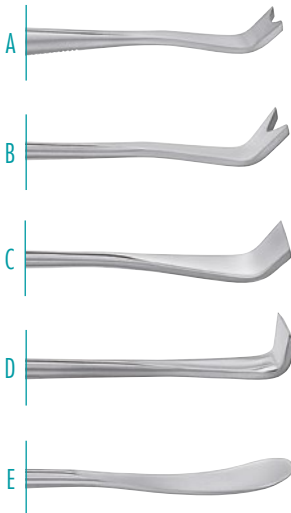
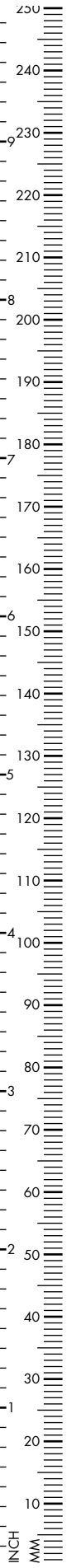

SEMB

Raspatory, hollow handle, 190mm, 7¹/₂"

A 12mm	210-450-001
230mm, 9"	
B 12mm	210-450-002
C 13mm	210-450-003
D 13mm	210-450-004
E 15mm	210-450-005

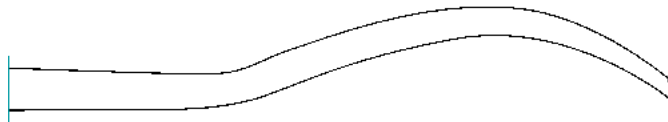

Hip Raspatory, synthetic handle, 20mm

275mm, 10 ⁷ / ₈ "	210-420-275
---	-------------



WAGNER

Raspatory, synthetic handle, 330mm, 13"

8mm	210-428-330
17mm	210-417-330

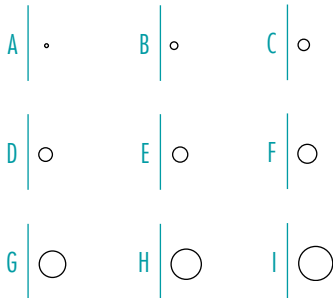

MEYERHOFER

Chalazion Curette, 130mm, 5¹/₈"

A Size 000, Ø 0.5mm	400-402-005
B Size 00, Ø 1.0mm	400-402-010
C Size 0, Ø 1.5mm	400-402-015
D Size 1, Ø 1.8mm	400-402-018
E Size 2, Ø 2.0mm	400-402-020
F Size 3, Ø 2.5mm	400-402-025
G Size 4, Ø 3.5mm	400-402-035
H Size 5, Ø 4.0mm	400-402-040
I Size 6, Ø 4.5mm	400-402-045



MARTINI

Double Curette, round/round, 140mm, 5¹/₂"

A #00/0 (Ø 3.0 / 3.2mm)	210-218-140
B #0/1 (Ø 3.2 / 4.0mm)	210-219-140
C #1/2 (Ø 4.0 / 4.8mm)	210-218-012



WILLIGER

Double Curette, oval/oval, 140mm, 5¹/₂"

A #00/0 (Ø 2.5 / 3.0mm)	210-216-000
B #0/1 (Ø 3.0 / 3.5mm)	210-216-001
C #1/2 (Ø 3.5 / 4.2mm)	210-216-002

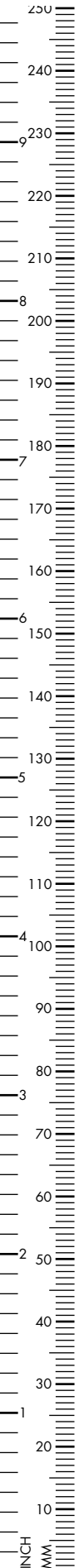

JACOBSON
Double Curette

140mm, 5^{1/2}"

210-213-140



JANSEN

Double Curette, 4.0/3.0mm

160mm, 6^{1/4}"

210-218-160



JANSEN

Double Curette, 4.0/3.0mm

210mm, 8^{1/4}"

210-214-210

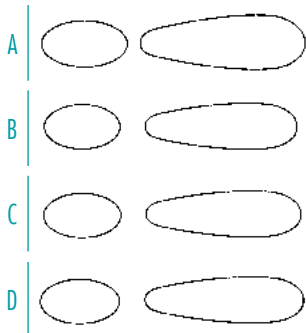

VOLKMANN

Double Curette, 130mm, 5¹/₈"

A 6.5 / 7.7mm 210-210-130

140mm, 5¹/₂"

B 6.2 / 6.8mm 210-210-140

170mm, 6²/₃"

C 6.8 / 6.8mm 210-210-170

200mm, 8"

D 6.2 / 7.5mm 210-210-200

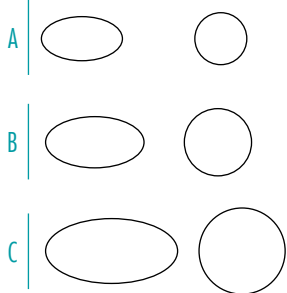

VOLKMANN

Double Curette, 130mm, 5¹/₈"

A 6.8 / 6.3mm 210-211-130

160mm, 6¹/₄"

B 9.0 / 7.0mm 210-211-160

200mm, 8"

C 11.0 / 9.0mm 210-211-200

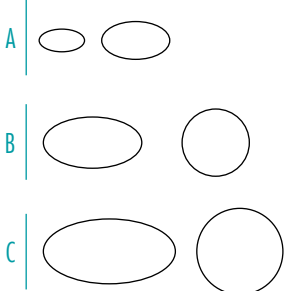

VOLKMANN

Double Curette, 220mm, 8²/₃"

A #1 3.0/5.0mm 410-746-001

B #2 4.0/6.0mm 410-746-002

C #3 5.0/7.0mm 410-746-003

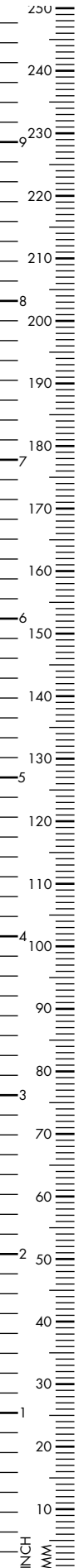

WILLIGER

Double Curette, 160mm, 6¹/₄"

A #00/00

210-216-020



JANSEN

Double Curette, 3.0/4.0mm

150mm, 6"

210-216-150



HEMINGWAY

Double Curette, #4

180mm, 7"

210-215-004

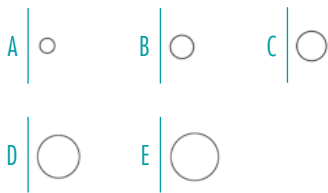

BUCK

Bone Curette, 145mm, 5³/₄"

A Fig. 1	210-201-145
B Fig. 2	210-202-145
C Fig. 3	210-203-145
D Fig. 4	210-204-145
E Fig. 5	210-205-145

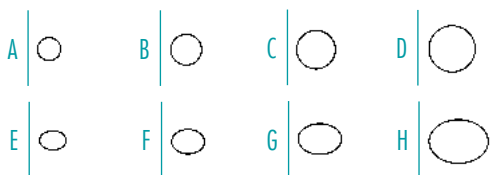

BUCK

Bone Curette, round, 170mm, 6²/₃"

A Fig. 00, 3.0mm	210-213-175
B Fig. 0, 4.0mm	210-214-175
C Fig. 1, 5.0mm	210-215-175
D Fig. 2, 6.0mm	210-216-175

oval

E Fig. 00, 2.5mm	210-294-010
F Fig. 0, 3.2mm	210-294-020
G Fig. 1, 4.0mm	210-294-040
H Fig. 2, 5.7mm	210-294-050

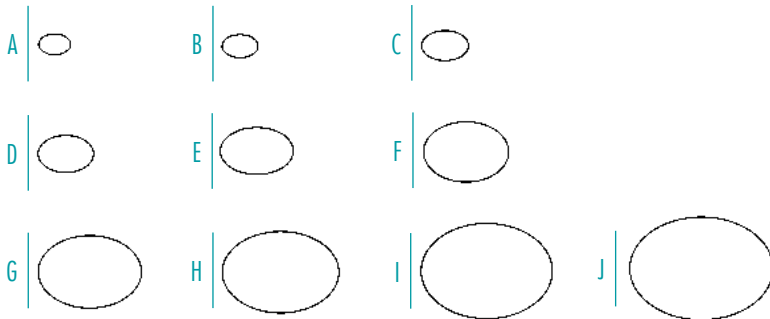

VOLKMANN

Bone Curette, 170mm, 6²/₃"

A #0000	210-304-400
B #000	210-304-300
C #00	210-304-200
D #0	210-304-100
E #1	210-304-010
F #2	210-304-020
G #3	210-304-030
H #4	210-304-040
I #5	210-304-050
J #6	210-304-060

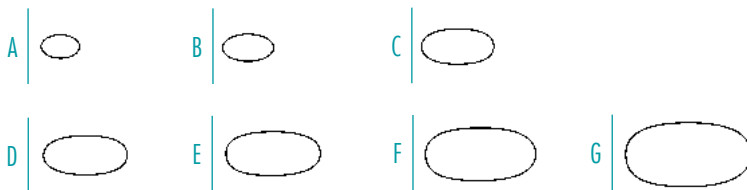

SCHEDE

Bone Curette, 170mm, 6²/₃"

A #000	210-300-300
B #00	210-300-200
C #0	210-300-100
D #1	210-300-010
E #2	210-300-020
F #3	210-300-030
G #4	210-300-040

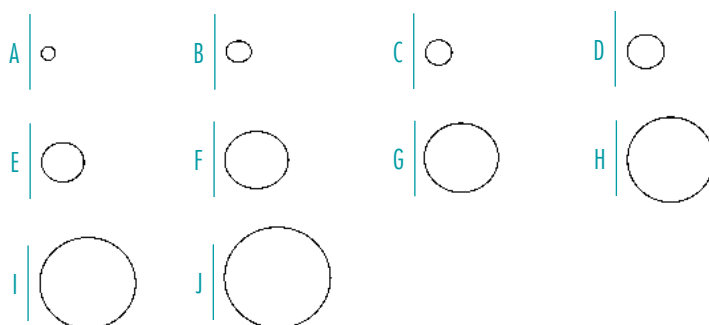

BRUNS

Bone Curette, round, 170mm, 6²/₃"

A #0000	210-306-400
B #000	210-306-300
C #00	210-306-200
D #0	210-306-100
E #1	210-306-010
F #2	210-306-020
G #3	210-306-030
H #4	210-306-040
I #5	210-306-050
J #6	210-306-060

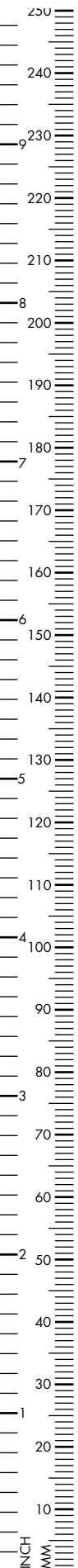

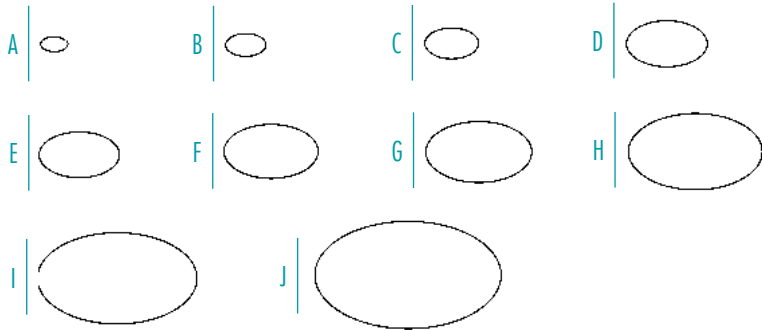

STILLE

Bone Curette, oval, 170mm, 6²/₃"

A	Ø 2mm	210-249-002
B	Ø 3mm	210-249-003
C	Ø 4mm	210-249-004

195mm, 7³/₄"

D	Ø 5mm	210-249-005
E	Ø 6mm	210-249-006
F	Ø 7mm	210-249-007

200mm, 8"

G	Ø 8mm	210-249-008
---	-------	-------------

205mm, 8¹/₈"

H	Ø 10mm	210-249-010
I	Ø 12mm	210-249-012
J	Ø 14mm	210-249-014

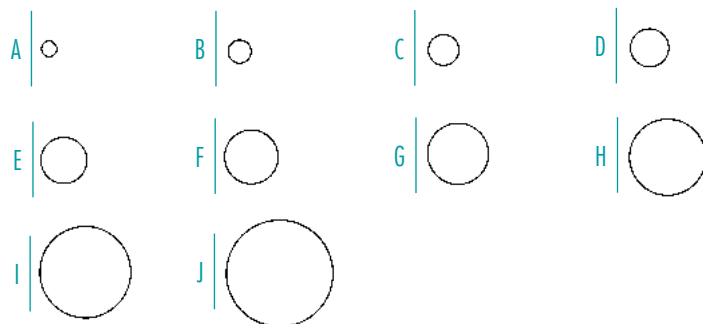

STILLE

Bone Curette, round, 170mm, 6²/₃"

A	Ø 2mm	210-248-002
B	Ø 3mm	210-248-003
C	Ø 4mm	210-248-004

195mm, 7³/₄"

D	Ø 5mm	210-248-005
E	Ø 6mm	210-248-006
F	Ø 7mm	210-248-007

200mm, 8"

G	Ø 8mm	210-248-008
---	-------	-------------

205mm, 8¹/₈"

H	Ø 10mm	210-248-010
I	Ø 12mm	210-248-012
J	Ø 14mm	210-248-014

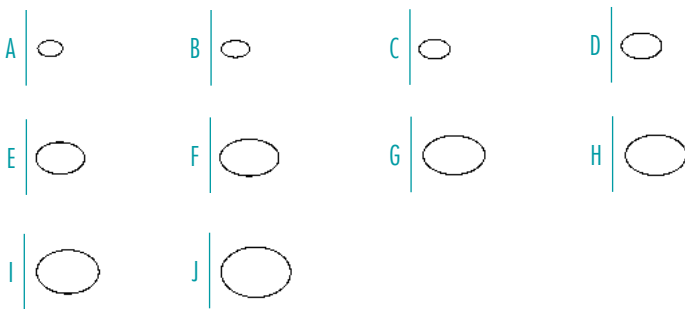

SPRATT

Bone Curette, oval, 170mm, 6²/₃"

A #0000, 2.5mm	210-308-008
B #000, 3.0mm	210-308-000
C #00, 4.0mm	210-308-001
D #0, 4.5mm	210-308-002
E #1, 5.0mm	210-308-003
F #2, 6.0mm	210-308-004
G #3, 7.0mm	210-308-005
H #4, 8.0mm	210-308-006
I #5, 9.6mm	210-308-007
J #6 11.5mm	210-308-009

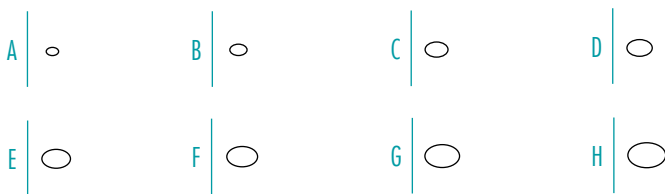

LEMPERT

Bone Curette, 200mm, 8"

A #000000, 1mm	210-348-600
B #00000, 1.5mm	210-348-500
C #0000, 2.0mm	210-348-400
D #000, 2.2mm	210-348-300
E #00, 2.5mm	210-348-200
F #0, 2.7mm	210-348-100
G #1, 3.0mm	210-348-010
H #2, 3.3mm	210-348-002

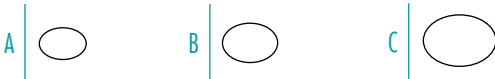

HALLÉ

Bone Curette, malleable, 210mm, 8¹/₄"

A #1, 4.8mm	210-350-200
B #2, 5.8mm	210-350-100
C #3, 6.8mm	210-350-010

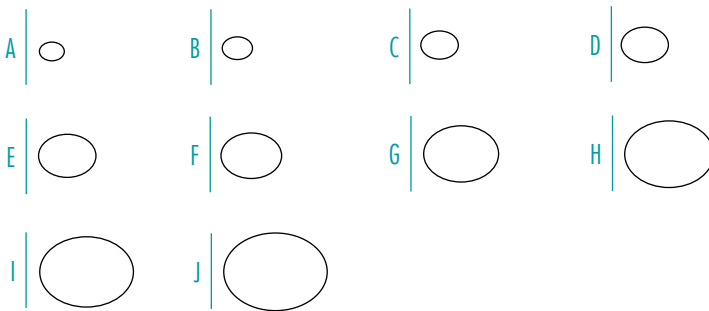

BRUNS

Bone Curette, synthetic handle, 170mm, 6²/₃"

A #0000, 2.5mm	210-302-100
B #000, 3.0mm	210-302-101
C #00, 3.7mm	210-302-102
D #0, 4.7mm	210-302-103
E #1, 5.7mm	210-302-104
F #2, 6.0mm	210-302-105
G #3, 7.4mm	210-302-106
H #4, 8.8mm	210-302-107
I #5, 9.2mm	210-302-108
J #6, 10.3mm	210-302-109



DAUBENSPECK

Bone Curette, 200mm, 8"

A Fig. 00, 2.8mm	210-217-200
B Fig.0, 3.6mm	210-217-100
C Fig. 1, 4.4mm	210-217-010
D Fig. 2, 5.2mm	210-217-020

SPINAL

Bone Curette

A straight

B forward angled

C reverse angled

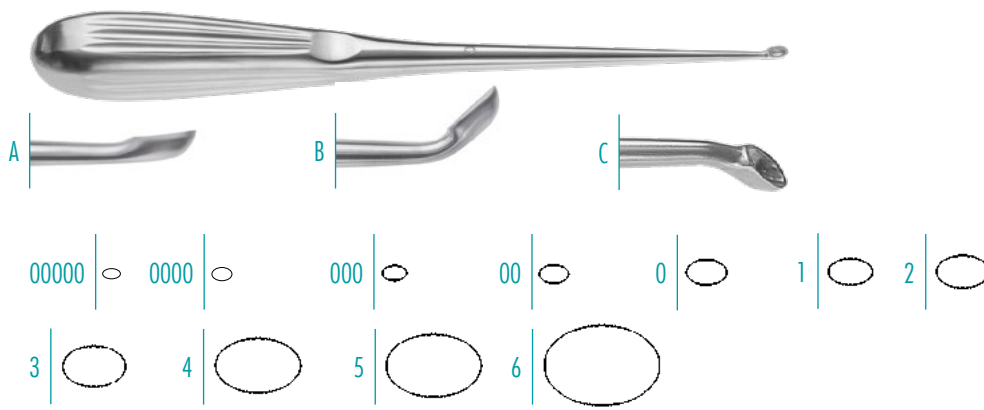

tip shape	size	200mm, 8"	230mm, 9"	300mm, 11 ⁷ / ₈ "
straight	00000	210-299-500	210-326-500	210-330-500
straight	0000	210-299-400	210-326-400	210-330-400
straight	000	210-299-300	210-326-300	210-330-300
straight	00	210-299-200	210-326-200	210-330-200
straight	0	210-299-100	210-326-100	210-330-100
straight	1	210-299-001	210-326-001	210-330-001
straight	2	210-299-002	210-326-002	210-330-002
straight	3	210-299-003	210-326-003	210-330-003
straight	4	210-299-004	210-326-004	210-330-004
straight	5	210-299-005	210-326-005	210-330-005
straight	6	210-299-006	210-326-006	210-330-006
forward angled	00000	210-301-500	210-328-500	210-331-500
forward angled	0000	210-301-400	210-328-400	210-331-400
forward angled	000	210-301-300	210-328-300	210-331-300
forward angled	00	210-301-200	210-328-200	210-331-200
forward angled	0	210-301-100	210-328-100	210-331-100
forward angled	1	210-301-001	210-328-001	210-331-001
forward angled	2	210-301-002	210-328-002	210-331-002
forward angled	3	210-301-003	210-328-003	210-331-003
forward angled	4	210-301-004	210-328-004	210-331-004
forward angled	5	210-301-005	210-328-005	210-331-005
forward angled	6	210-301-006	210-328-006	210-331-006
reverse angled	00000	210-327-500	210-329-500	210-333-500
reverse angled	0000	210-327-400	210-329-400	210-333-400
reverse angled	000	210-327-300	210-329-300	210-333-300
reverse angled	00	210-327-200	210-329-200	210-333-200
reverse angled	0	210-327-100	210-329-100	210-333-100
reverse angled	1	210-327-001	210-329-001	210-333-001
reverse angled	2	210-327-002	210-329-002	210-333-002
reverse angled	3	210-327-003	210-329-003	210-333-003
reverse angled	4	210-327-004	210-329-004	210-333-004
reverse angled	5	210-327-005	210-329-005	210-333-005
reverse angled	6	210-327-006	210-329-006	210-333-006

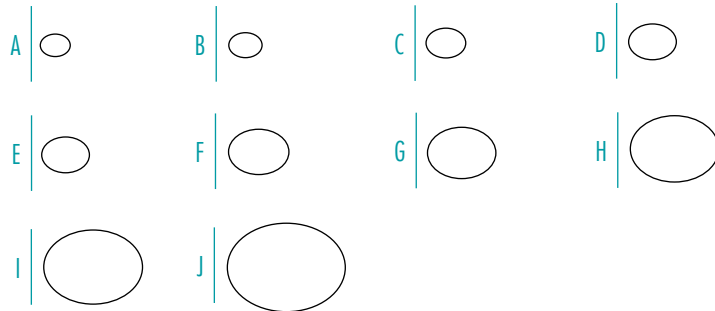

VOLKMANN BRUNS

Bone Curette, 230mm, 9"
straight jaw

A #0000	210-314-400
B #000	210-314-300
C #00	210-314-200
D #0	210-314-100
E #1	210-314-001
F #2	210-314-002
G #3	210-314-003
H #4	210-314-004
I #5	210-314-005
J #6	210-314-006

angled

A #0000	210-315-400
B #000	210-315-300
C #00	210-315-200
D #0	210-315-100
E #1	210-315-001
F #2	210-315-002
G #3	210-315-003
H #4	210-315-004
I #5	210-315-005
J #6	210-315-006

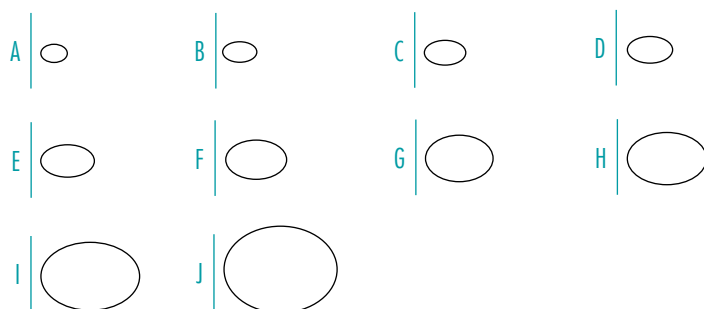

BRUNS

Bone Curette, 230mm, 9"

A #0000	210-296-400
B #000	210-296-300
C #00	210-296-200
D #0	210-296-100
E #1	210-296-001
F #2	210-296-002
G #3	210-296-003
H #4	210-296-004
I #5	210-296-005
J #6	210-296-006

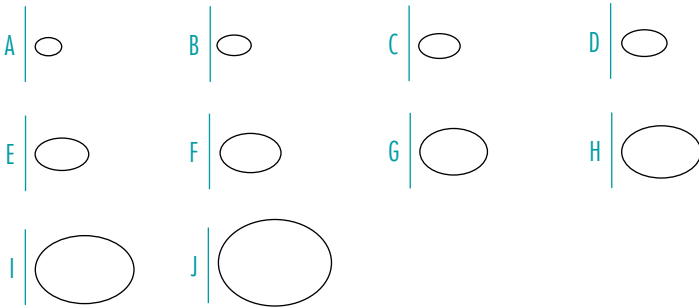
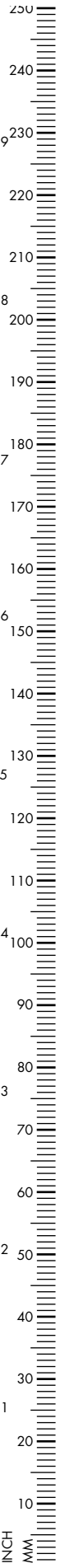

BRUNS

Bone Curette, synthetic handle,
270mm, 10²/₃"

A #0000	210-302-000
B #000	210-302-001
C #00	210-302-002
D #0	210-302-003
E #1	210-302-004
F #2	210-302-005
G #3	210-302-006
H #4	210-302-007
I #5	210-302-008
J #6	210-302-009

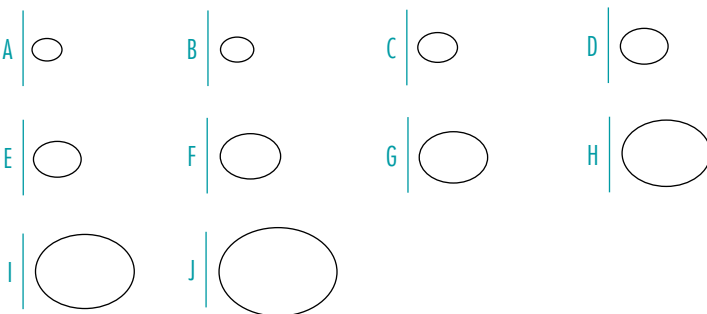

VOLKMANN SCOVILLE

Bone Curette, 250mm, 9⁷/₈"
straight jaw

A #0000	210-215-250
B #000	210-214-250
C #00	210-213-250
D #0	210-212-250
E #1	210-211-250
F #2	210-202-250
G #3	210-203-250
H #4	210-204-250
I #5	210-205-250
J #6	210-206-250

angled jaw

A #0000	210-315-250
B #000	210-314-250
C #00	210-313-250
D #0	210-312-250
E #1	210-311-250
F #2	210-302-250
G #3	210-303-250
H #4	210-304-250
I #5	210-305-250
J #6	210-306-250



CASPAR

Bone Curette, synthetic handle, 220mm, 8²/₃" straight

A #000	259-185-912
B #00	259-185-913
C #0	259-185-914

angled

A #000	259-185-921
B #00	259-185-922
C #0	259-185-919

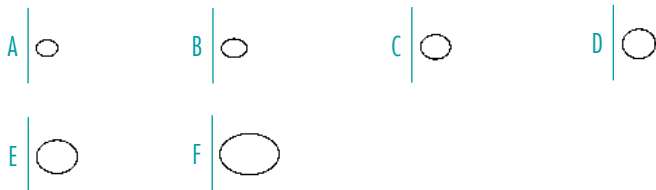

SIMON

Bone Curette, 230mm, 9¹/₂"

A #1	210-298-001
B #2	210-298-002
C #3	210-298-003
D #4	210-298-004
E #5	210-298-005
F #6	210-298-006

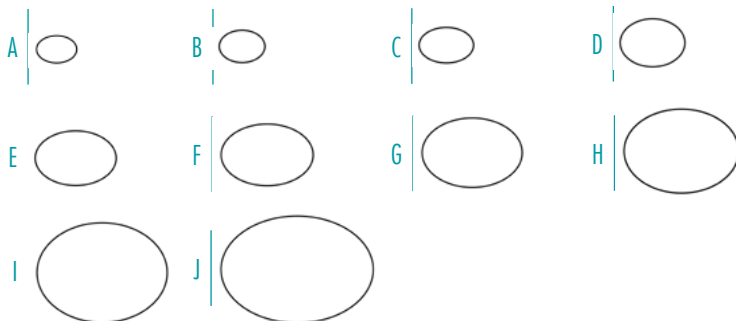

Bone Curette, synthetic handle, 190mm, 7¹/₂"

A #0000	210-166-030
B #000	210-166-020
C #00	210-166-010
D #0	210-166-000
E #1	210-166-001
F #2	210-166-002
G #3	210-166-003
H #4	210-166-004
I #5	210-166-005
J #6	210-166-006



EPSTEIN

Bone Curette, hollow handle, 200mm, 8"

A #000	210-309-003
B #00	210-309-002
C #0	210-309-001



BUSHE

Bone Curette, upwards cutting, 250mm, 9⁷/₈"

A 3mm	210-338-250
B 4mm	210-339-250
C 5mm	210-340-250
D 6mm	210-341-250

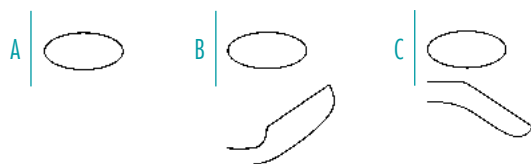

SCOVILLE

Bone Curette, hollow handle, 250mm, 9⁷/₈"

A straight	210-316-250
B forward angled	210-318-250
C backward angled	210-317-250

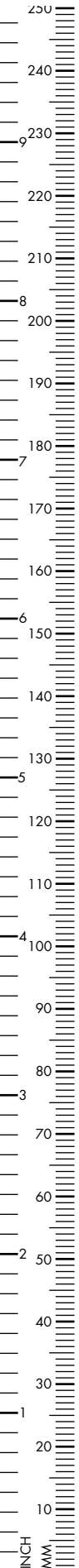

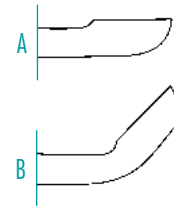

SPINAL

Bone Curette, oval, 280mm, 11"

A straight, massive aluminium handle

#000, 2.5mm	210-320-011
#00, 3.0mm	210-320-012
#0, 3.5mm	210-320-013
#1, 4.0mm	210-320-014
#2, 4.5mm	210-320-015
#3, 5.0mm	210-320-016
#4, 5.5mm	210-320-017
#5, 6.5mm	210-320-018
#6, 8.0mm	210-320-019

A straight, hollow, stainless steel handle

#000, 2.5mm	210-320-111
#00, 3.0mm	210-320-112
#0, 3.5mm	210-320-113
#1, 4.0mm	210-320-114
#2, 4.5mm	210-320-115
#3, 5.0mm	210-320-116
#4, 5.5mm	210-320-117
#5, 6.5mm	210-320-118
#6, 8.0mm	210-320-119

B curved, massive aluminium handle

#000, 2.5mm	210-321-011
#00, 3.0mm	210-321-012
#0, 3.5mm	210-321-013
#1, 4.0mm	210-321-014
#2, 4.5mm	210-321-015
#3, 5.0mm	210-321-016
#4, 5.5mm	210-321-017
#5, 6.5mm	210-321-018
#6, 8.0mm	210-321-019

B curved, hollow, stainless steel handle

#000, 2.5mm	210-321-111
#00, 3.0mm	210-321-112
#0, 3.5mm	210-321-113
#1, 4.0mm	210-321-114
#2, 4.5mm	210-321-115
#3, 5.0mm	210-321-116
#4, 5.5mm	210-321-117
#5, 6.5mm	210-321-118
#6, 8.0mm	210-321-119

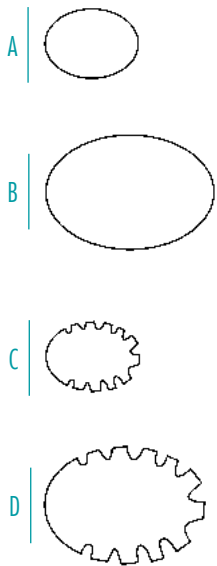
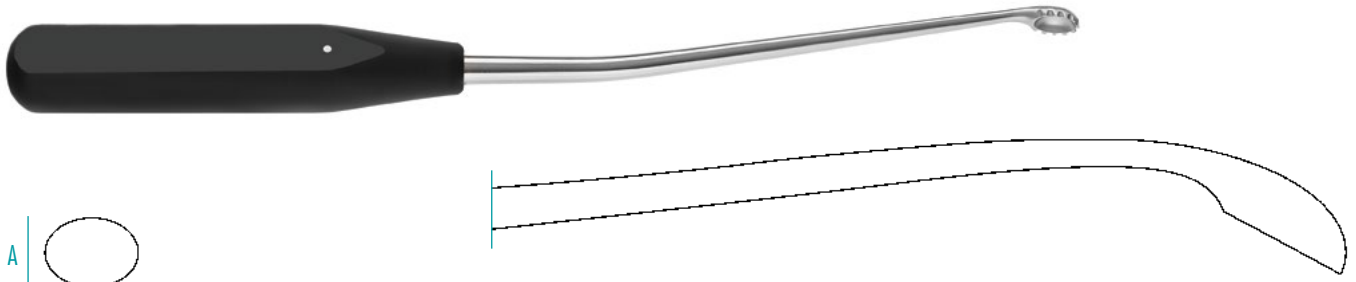
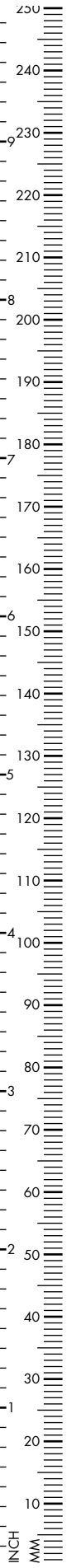

Bone Curette, synthetic handle
270mm, 10²/₃"

A 9.0mm	210-163-009
B 15.0mm	210-163-015

toothed

C 9.0mm	210-164-009
D 15.0mm	210-164-015



Bone Curette, synthetic handle,
toothed, double angled, 9mm

270mm, 10 ² / ₃ "	210-164-109
---	-------------



Bone Curette, synthetic handle, 27mm
small

240mm, 9 ¹ / ₂ "	210-184-503
--	-------------

medium

270mm, 10 ² / ₃ "	210-184-504
---	-------------

large

320mm, 12 ² / ₃ "	210-184-505
---	-------------

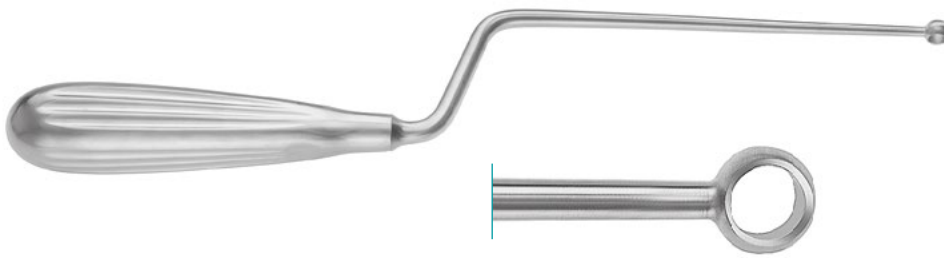

KRAEMER

Ring Curette, sharpened double-sided,
250mm, 9^{7/8}"

4.0mm	210-321-004
5.0mm	210-321-005
6.0mm	210-321-006

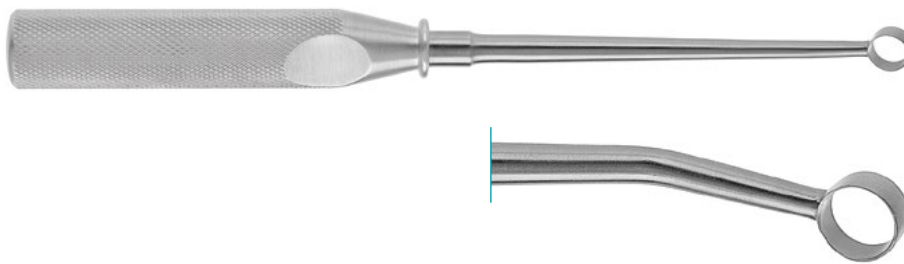

CONE

Ring Curette, 230mm, 9"
straight

#3 3mm	210-320-003
#2 6mm	210-320-002
#1 8mm	210-320-001

angled

#3 3mm	210-319-003
#2 6mm	210-319-002
#1 8mm	210-319-001

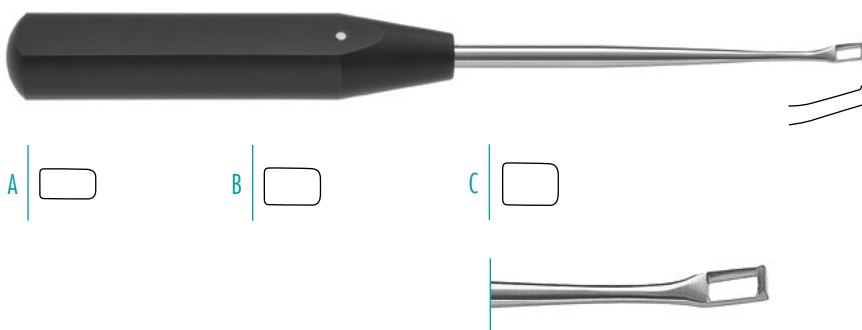

CASPAR

Bone Scoop, curved, toothed, synthetic handle
220mm, 8^{2/3}"

A 4.0mm	259-185-915
B 5.0mm	259-185-916
C 6.0mm	259-185-910



SEMMEs

Spinal Curette, 4x7mm, 230mm, 9"

A straight	210-294-001
B slightly curved	210-294-002
C fully curved	210-294-003

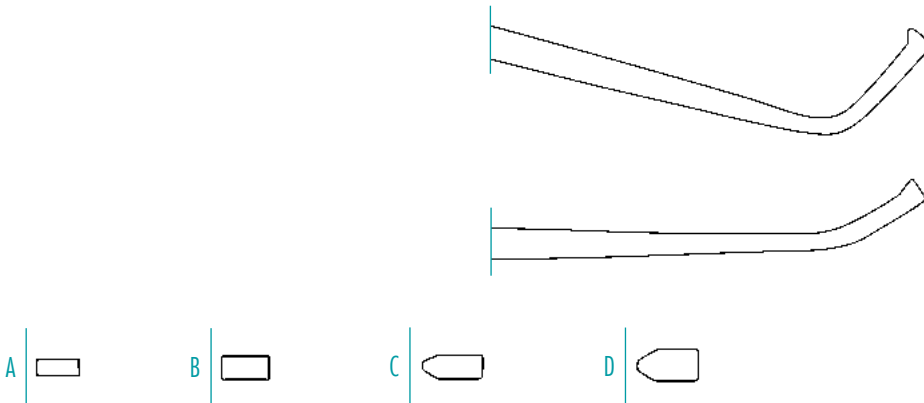

CASPAR

Curette, serrated, 270mm, 10^{2/3}"
knee bent shaft

A 3.0mm	210-340-003
B 4.0mm	210-340-004

250mm, 9^{7/8}", curved shaft

C 4.0mm	210-342-004
D 5.0mm	210-342-005

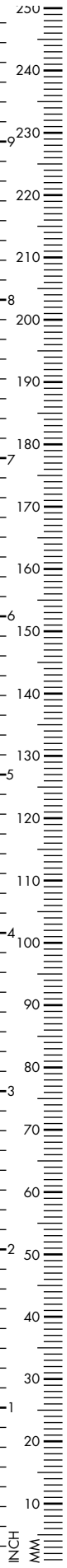

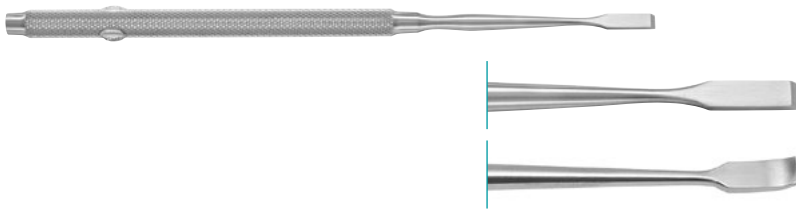

FREER

Septum Chisel, 4mm, 160mm, 6¹/₄"

straight	420-590-004
curved	420-591-004



THIES

Gouge, straight, 160mm, 6¹/₄"

2mm	210-100-162
3mm	210-100-163
4mm	210-100-164

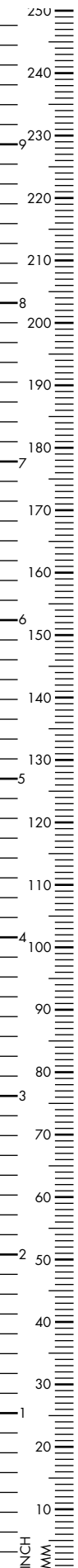

PARTSCH

Osteotome, 140mm, 5¹/₂"

4mm	210-100-004
6mm	210-100-006
8mm	210-100-008
10mm	210-100-010
12mm	210-100-012

PARTSCH

Chisel, 135mm, 5¹/₃"

2mm	210-302-135
3mm	210-303-135
5mm	210-305-135
6mm	210-306-135
7mm	210-307-135
8mm	210-308-135

170mm, 6²/₃"

2mm	210-302-170
3mm	210-303-170
5mm	210-305-170
6mm	210-306-170
7mm	210-307-170
8mm	210-308-170

PARTSCH

Gouge, 140mm, 5¹/₂"

2mm	210-109-002
3mm	210-109-003
4mm	210-109-004
5mm	210-109-005
6mm	210-109-006
7mm	210-109-007
8mm	210-109-008

170mm, 6²/₃"

2mm	210-110-002
3mm	210-110-003
4mm	210-110-004
5mm	210-110-005
6mm	210-110-006
7mm	210-110-007
8mm	210-110-008



LUCAS

Chisel, 160mm, 6¹/₄"

4mm	210-204-160
-----	-------------



LUCAS

Gouge, 160mm, 6¹/₄"

3mm	210-103-160
-----	-------------

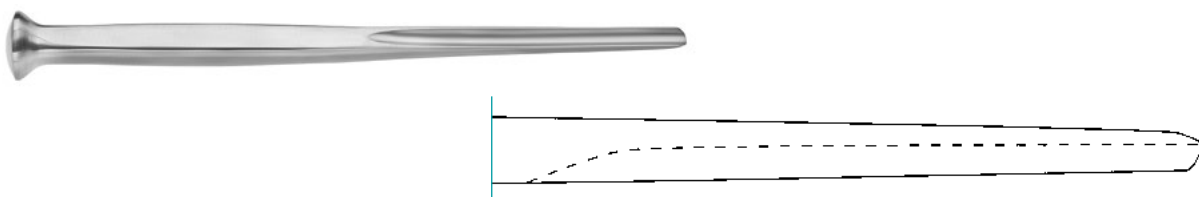

ALEXANDER

Gouge, 180mm, 7"

4mm	210-604-180
6mm	210-606-180
8mm	210-608-180
10mm	210-610-180
12mm	210-612-180
14mm	210-614-180

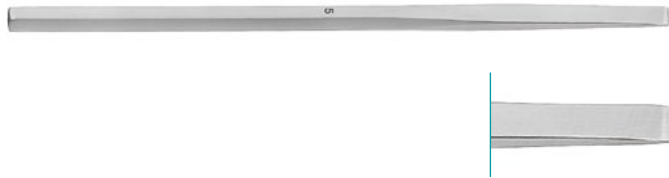
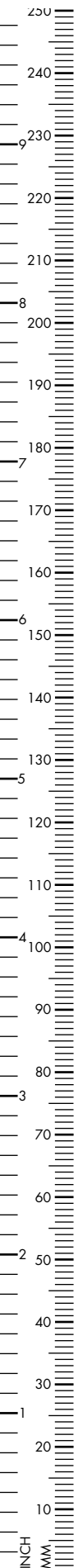

SHEEHAN

Osteotome, 160mm, 6¹/₄"

2mm	420-594-002
3mm	420-594-003
4mm	420-594-004
5mm	420-594-005
6mm	420-594-006
7mm	420-594-007
8mm	420-594-008
10mm	420-594-010
12mm	420-594-012
15mm	420-594-015



COTTLE

Osteotome with depth marking, 180mm, 7"

4mm	210-487-004
7mm	210-487-007
8mm	210-487-008
10mm	210-487-010
12mm	210-487-012



COTTLE

Chisel with depth marking, 180mm, 7"

4mm	210-488-004
7mm	210-488-007
9mm	210-488-009
12mm	210-488-012



COTTLE

Fishtail Osteotome, protecting ends, double guarded, 8mm

180mm, 7" 210-486-008



HARDT DELIMA

Osteotome, straight, 130mm, 5¹/₈"

2mm 210-134-102

4mm 210-134-104

6mm 210-134-106

8mm 210-134-108

10mm 210-134-110

12mm 210-134-112

15mm 210-134-115

170mm, 6²/₃"

2mm 210-134-202

4mm 210-134-204

6mm 210-134-206

8mm 210-134-208

10mm 210-134-210

12mm 210-134-212

15mm 210-134-215



CARROLL

Osteotome, 145mm, 5³/₄"

3mm 210-226-003

6mm 210-226-006

10mm 210-226-010

13mm 210-226-013

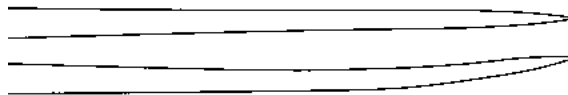
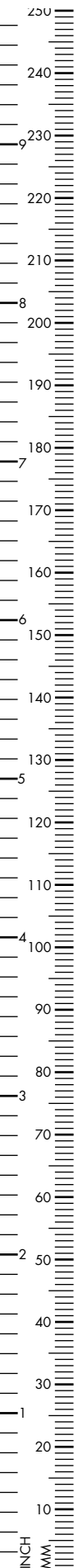

MINI LAMBOTTE

Osteotome, 125mm, 5"

2mm	210-136-002
3mm	210-136-003
4mm	210-136-004
5mm	210-136-005
6mm	210-136-006
7mm	210-136-007
8mm	210-136-008
9mm	210-136-009
10mm	210-136-010
12mm	210-136-012
14mm	210-136-014
15mm	210-136-015

MINI LAMBOTTE

Osteotome, curved, 125mm, 5"

2mm	210-137-002
4mm	210-137-005
6mm	210-137-007
8mm	210-137-009
10mm	210-137-011
12mm	210-137-013

LAMBOTTE

Osteotome, 240mm, 9 1/2"

straight		curved	
4mm	210-132-004	4mm	210-133-004
6mm	210-132-006	6mm	210-133-006
8mm	210-132-008	8mm	210-133-008
10mm	210-132-010	10mm	210-133-010
12mm	210-132-012	12mm	210-133-012
15mm	210-132-015	15mm	210-133-015
20mm	210-132-020	20mm	210-133-020
25mm	210-132-025	25mm	210-133-025
30mm	210-132-030	30mm	210-133-032
38mm	210-132-038	38mm	210-133-038
44mm	210-132-044	44mm	210-133-044
50mm	210-132-050	50mm	210-133-050

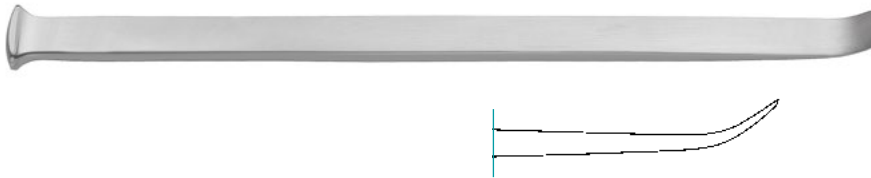

OBWEGESER

Osteotome, curved, 13mm

235mm, 9^{1/4}"

431-656-235

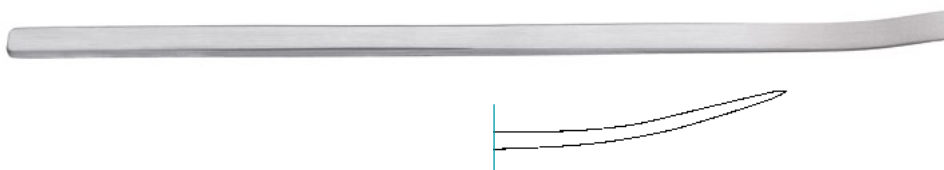

NIEDERDELLMANN

Osteotome, curved, 250mm, 9^{7/8}"

8mm

431-658-250

10mm

431-660-250

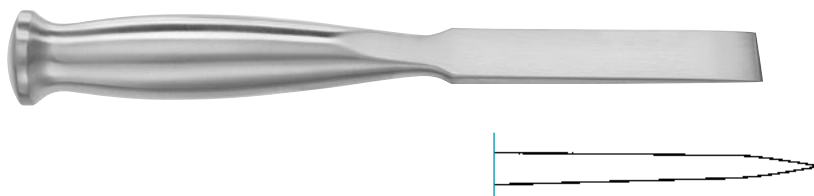

SMITH PETERSEN

Osteotome, straight, 200mm, 8"

6mm

210-106-200

9mm

210-109-200

13mm

210-113-200

16mm

210-116-200

19mm

210-119-200

25mm

210-125-200

32mm

210-132-200

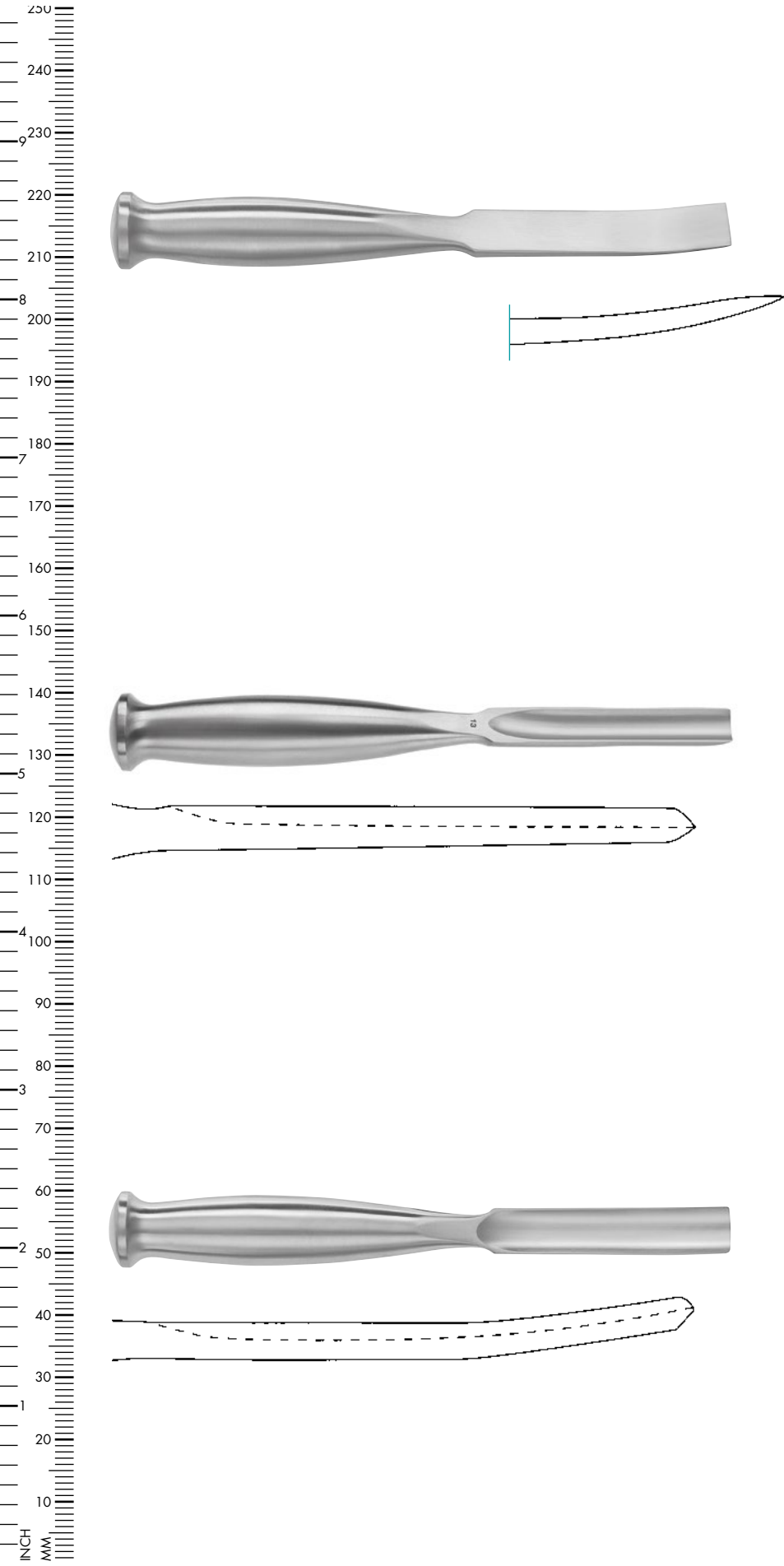

SMITH PETERSEN

Osteotome, curved, 200mm, 8"

6mm	210-206-200
9mm	210-209-200
13mm	210-213-200
16mm	210-216-200
19mm	210-219-200
25mm	210-225-200
32mm	210-232-200

SMITH PETERSEN

Gouge, straight, 200mm, 8"

6mm	210-305-200
9mm	210-309-200
13mm	210-313-200
16mm	210-316-200
19mm	210-319-200
25mm	210-325-200
32mm	210-332-200

SMITH PETERSEN

Gouge, curved, 200mm, 8"

6mm	210-406-200
9mm	210-409-200
13mm	210-413-200
16mm	210-416-200
19mm	210-419-200
25mm	210-425-200
32mm	210-432-200



STILLE

Chisel, 200mm, 8"

10mm	210-810-200
12mm	210-812-200
15mm	210-815-200
20mm	210-820-200
25mm	210-825-200

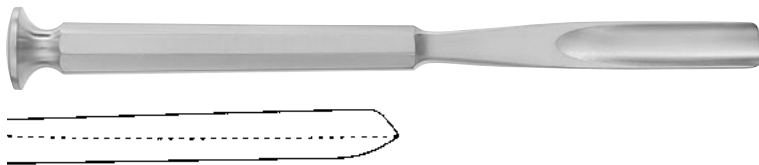

STILLE

Gouge, 200mm, 8"

8mm	210-508-200
10mm	210-510-200
12mm	210-512-200
15mm	210-515-200
20mm	210-520-200
25mm	210-525-200

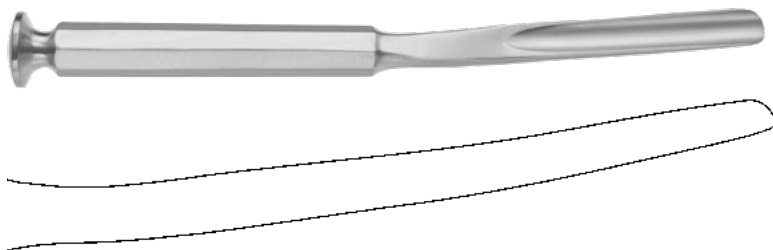

WALTER

Gouge, for rip graft, 200mm, 8"

10mm	210-701-010
15mm	210-701-015

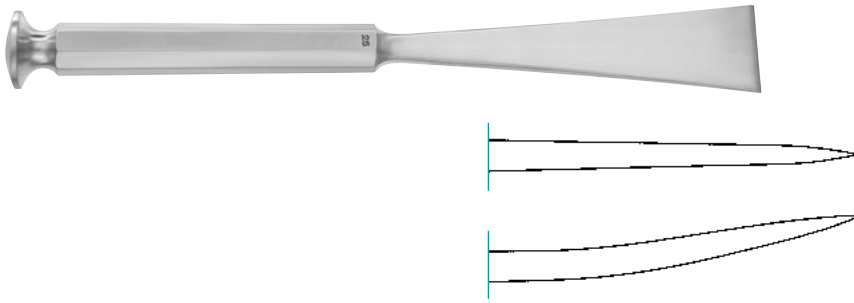
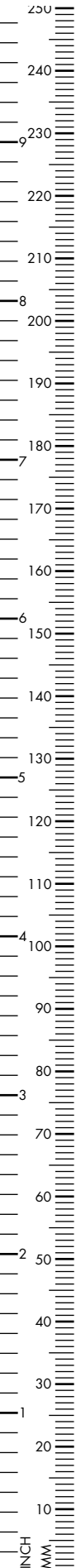

STILLE

Osteotome, 200mm, 8"
straight

8mm	210-708-200
10mm	210-710-200
12mm	210-712-200
15mm	210-715-200
20mm	210-720-200
25mm	210-725-200

curved

8mm	210-908-200
10mm	210-910-200
12mm	210-912-200
15mm	210-915-200
20mm	210-920-200
25mm	210-925-200



STILLE

Osteotome, fine model, 200mm, 8"

10mm	210-410-200
12mm	210-412-200
15mm	210-415-200
20mm	210-420-200

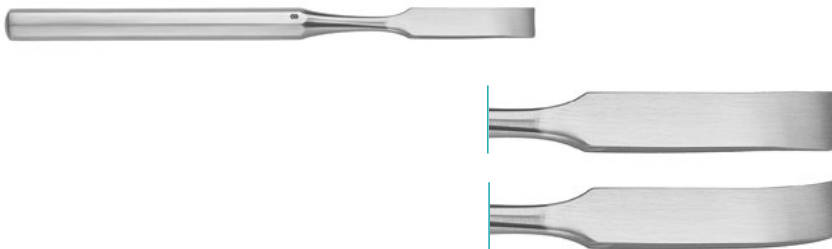

HOKE

Osteotome, 140mm, 5 1/2"
straight

3mm	210-219-003
5mm	210-219-005
6mm	210-219-006
8mm	210-219-008
9mm	210-219-009
12mm	210-219-012
16mm	210-219-016

curved

3mm	210-218-103
5mm	210-218-105
6mm	210-218-106
8mm	210-218-108
9mm	210-218-110
12mm	210-218-113
16mm	210-218-116



HIBBS

Osteotome, 240mm, 9^{1/2}"
straight

6mm	210-212-006
9mm	210-212-010
13mm	210-212-013
16mm	210-212-016
19mm	210-212-019
22mm	210-212-022
25mm	210-212-025
28mm	210-212-028
32mm	210-212-032
38mm	210-212-038



curved

6mm	210-213-006
9mm	210-213-010
13mm	210-213-013
16mm	210-213-016
19mm	210-213-019
22mm	210-213-022
25mm	210-213-025
28mm	210-213-028
32mm	210-213-032
38mm	210-213-038



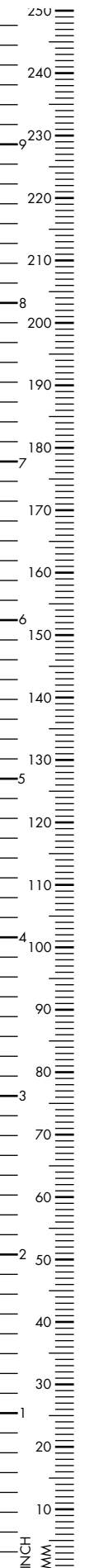

HIBBS

Chisel, 240mm, 9 1/2"
straight

6mm	210-206-006
9mm	210-206-010
13mm	210-206-013
16mm	210-206-016
19mm	210-206-019
22mm	210-206-022
25mm	210-206-025
28mm	210-206-028
32mm	210-206-032
38mm	210-206-038

curved

6mm	210-207-006
9mm	210-207-010
13mm	210-207-013
16mm	210-207-016
19mm	210-207-019
22mm	210-207-022
25mm	210-207-025
28mm	210-207-028
32mm	210-207-032
38mm	210-207-038

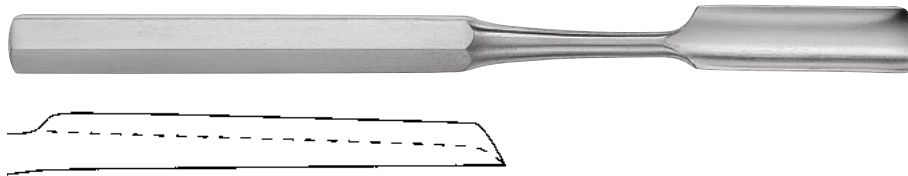

HIBBS

Gouge, 240mm, 9¹/₂"
straight

6mm	210-144-060
9mm	210-144-090
13mm	210-144-130
16mm	210-144-150
19mm	210-144-190
22mm	210-144-220
25mm	210-144-250
28mm	210-144-280
32mm	210-144-320
38mm	210-144-380

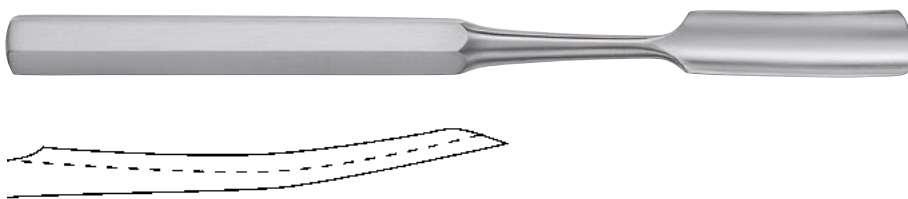

HIBBS

Gouge, 240mm, 9¹/₂"
curved

6mm	210-145-060
9mm	210-145-090
13mm	210-145-130
16mm	210-145-150
19mm	210-145-190
22mm	210-145-220
25mm	210-145-250
28mm	210-145-280
32mm	210-145-320
38mm	210-145-380

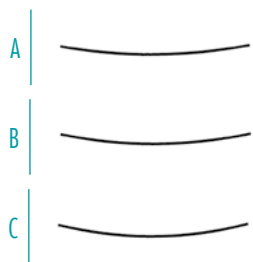
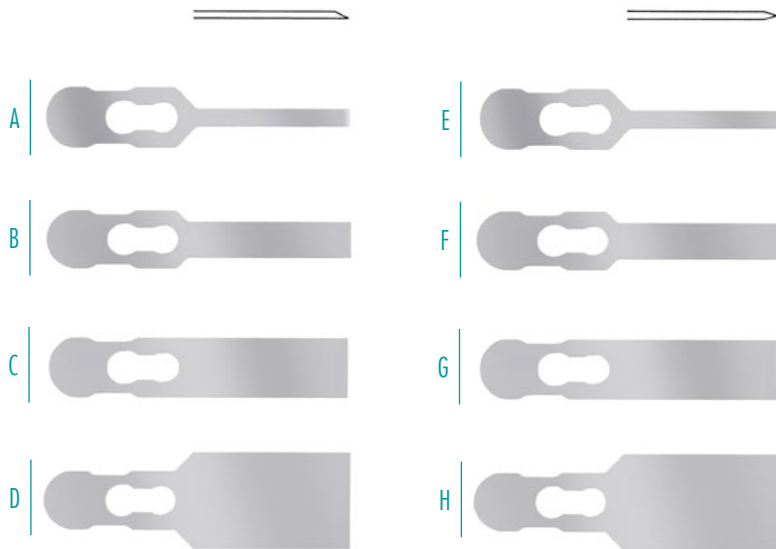
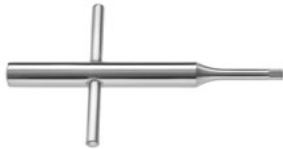
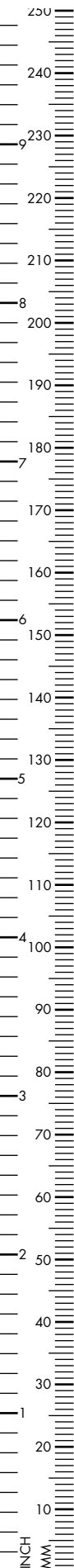

Handle for interchangeable blades,
synthetic handle

210-130-000

Spare Screw (not illustrated)

210-130-001

Wrench

90mm, 3 1/2" 210-130-500

Chisel Blade, 85mm, 3 1/4"

A 5mm 210-130-005

B 10mm 210-130-010

C 16mm 210-130-016

D 25mm 210-130-025

Osteotome Blade, 85mm, 3 1/4"

E 5mm 210-130-105

F 10mm 210-130-110

G 16mm 210-130-116

H 25mm 210-130-125

Gouge Blade, 85mm, 3 1/4"

A r = 50mm 210-130-050

B r = 60mm 210-130-060

C r = 70mm 210-130-070

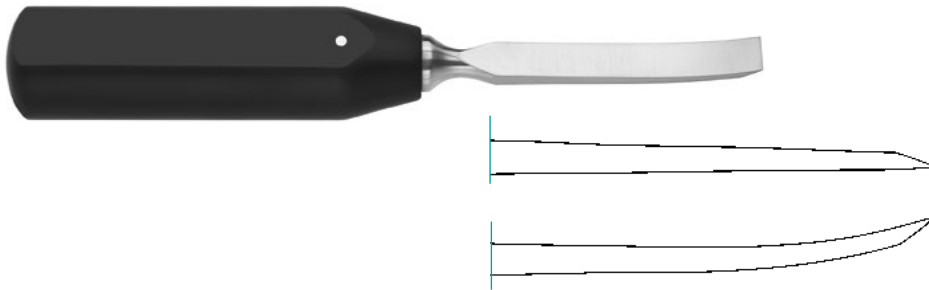

Osteotome, synthetic handle, 200mm, 8"
straight

10mm	210-435-010
15mm	210-435-015
20mm	210-435-020

curved	
10mm	210-437-010
15mm	210-437-015
20mm	210-437-020



LEXER MINI

Osteotome, synthetic handle, 180mm, 7"

4mm	210-137-004
6mm	210-137-006
8mm	210-137-008
10mm	210-137-010
12mm	210-137-012



LEXER MINI

Gouge, synthetic handle, 180mm, 7"

2mm	210-138-002
4mm	210-138-004
6mm	210-138-006
8mm	210-138-008
10mm	210-138-010
12mm	210-138-012
15mm	210-138-015

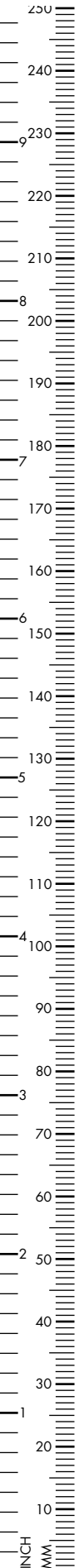

LEXER

Osteotome, synthetic handle, 220mm, 8²/₃"

5mm	210-134-005
7mm	210-134-007
10mm	210-134-010
12mm	210-134-012
15mm	210-134-015
20mm	210-134-020
25mm	210-134-025
30mm	210-134-030



LEXER

Gouge, synthetic handle, 220mm, 8²/₃"

5mm	210-135-005
7mm	210-135-007
10mm	210-135-010
12mm	210-135-012
15mm	210-135-015
20mm	210-135-020
25mm	210-135-025
30mm	210-135-030

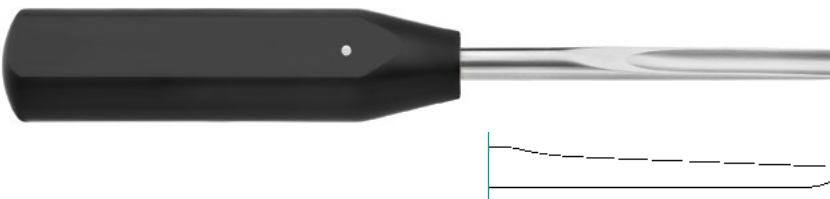

Gouge, for removing broken screws,
synthetic handle,
220mm, 8²/₃"

10mm	210-153-010
------	-------------



ZIELKE

Gouge, synthetic handle, 230mm, 9"

6mm 210-500-006

9mm 210-500-009

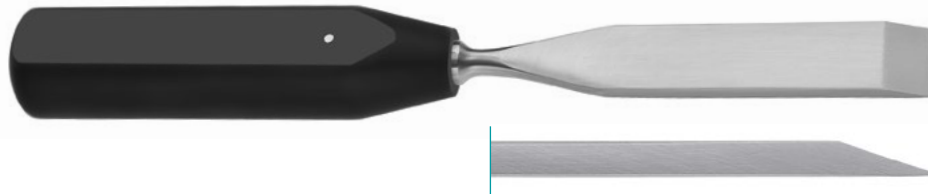

Chisel, synthetic handle, 20mm, straight

245mm, 9²/₃" 210-146-240



Chisel, synthetic handle, 16mm, curved

265mm, 10¹/₂" 210-149-260



LEXER

Osteotome, synthetic handle, angled,
275mm, 10^{7/8}"

10mm	210-251-010
15mm	210-251-015



LEXER

Gouge, synthetic handle, angled,
275mm, 10^{7/8}"

10mm	210-252-010
15mm	210-252-015



LEXER

Spongiosa Gouge, synthetic handle,
250mm, 9^{7/8}", straight

5mm	210-240-005
10mm	210-240-010
15mm	210-240-015

curved

5mm	210-240-105
10mm	210-240-110
15mm	210-240-115

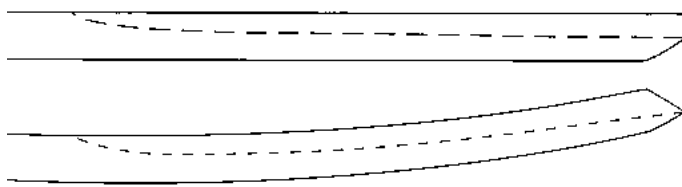

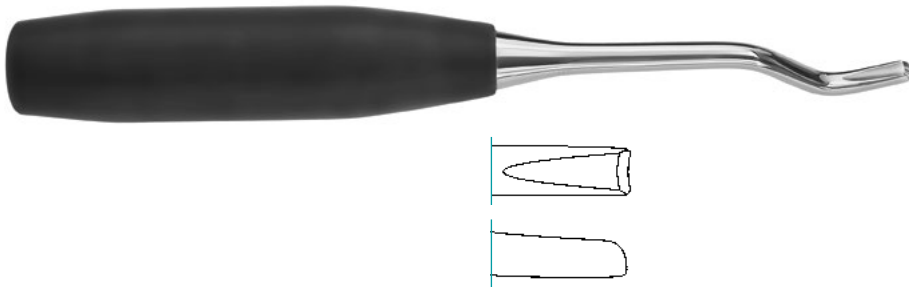

CAPENER

Lamina Gouge, synthetic handle,
240mm, 9¹/₂"

6mm	210-235-006
8mm	210-235-008
10mm	210-235-010
11mm	210-235-011
13mm	210-235-013
16mm	210-235-016
19mm	210-235-019

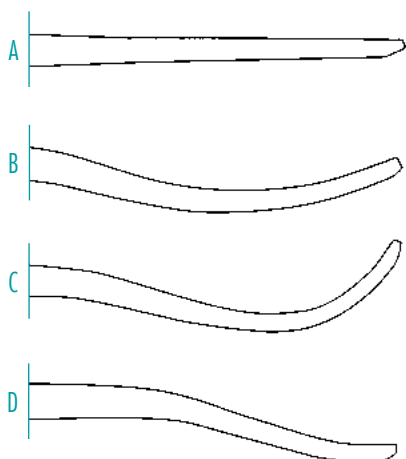

COBB

Gouge, synthetic handle, 4mm
280mm, 11"

A straight (8mm)	210-405-195
B slightly curved	210-405-295
C strongly curved	210-405-395
D backwards curved	210-405-495

Hexagonal Handle, 4mm
240mm, 9¹/₂"

A straight	210-405-100
B slightly curved	210-405-101
C strongly curved	210-405-102
D backwards curved	210-405-103

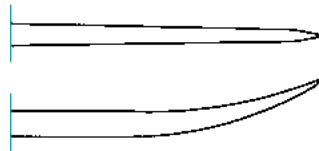

COBB

Osteotome, 280mm, 11"
straight

6mm	210-403-006
9mm	210-403-009
13mm	210-403-013
16mm	210-403-016
19mm	210-403-019
25mm	210-403-025
32mm	210-403-032

curved

6mm	210-406-006
9mm	210-406-009
13mm	210-406-013
16mm	210-406-016
19mm	210-406-019
25mm	210-406-025
32mm	210-406-032

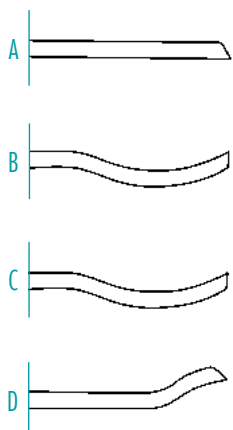

COBB

Gouge, 7.5mm, 280mm, 11"

A straight	210-405-300
B slightly curved	210-405-301
C strongly curved	210-405-302
D backwards curved	210-405-303

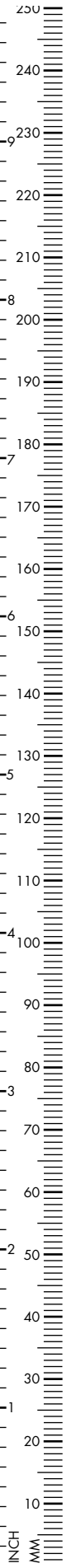

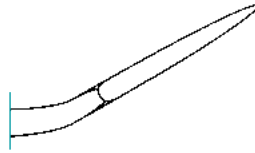
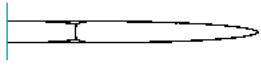

DAHMEN

Osteotome, synthetic handle, 300mm, 11^{7/8}"
straight

4mm	210-111-004
5mm	210-111-005
6mm	210-111-006
8mm	210-111-008
10mm	210-111-010
12mm	210-111-012
15mm	210-111-015
20mm	210-111-020
22mm	210-111-022
25mm	210-111-025

angled

4mm	210-118-004
5mm	210-118-005
6mm	210-118-006
8mm	210-118-008
10mm	210-118-010
12mm	210-118-012
15mm	210-118-015
20mm	210-118-020
22mm	210-118-022
25mm	210-118-025

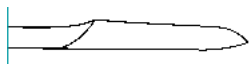

DAHMEN

Gouge, synthetic handle, 300mm, 11^{7/8}"
straight

4mm	210-112-004
5mm	210-112-005
6mm	210-112-006
8mm	210-112-008
10mm	210-112-010
12mm	210-112-012
15mm	210-112-015
20mm	210-112-020
22mm	210-112-022
25mm	210-112-025

angled backward

4mm	210-119-004
5mm	210-119-005
6mm	210-119-006
8mm	210-119-008
10mm	210-119-010
12mm	210-119-012
15mm	210-119-015
20mm	210-119-020
22mm	210-119-022
25mm	210-119-025

angled forward

4mm	210-113-004
5mm	210-113-005
6mm	210-113-006
8mm	210-113-008
10mm	210-113-010
12mm	210-113-012
15mm	210-113-015
20mm	210-113-020
22mm	210-113-022
25mm	210-113-025

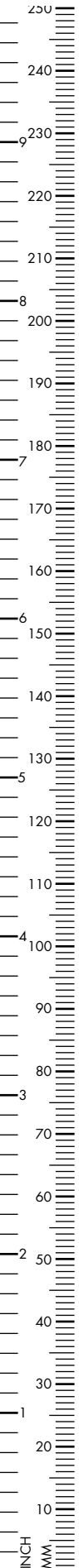

LEXER

Gouge, synthetic handle, 5mm

280mm, 11" 210-135-050

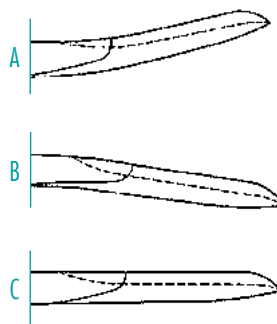

WAGNER

Gouge, synthetic handle, 340mm, 13^{1/2}"

A angled forward

9mm 210-409-341

15mm 210-415-341

B angled backward

9mm 210-409-342

15mm 210-415-342

C straight

9mm 210-409-340

15mm 210-415-340



Osteophyt Chisel, synthetic handle,
curved, 16mm

200mm, 8"	210-437-160
-----------	-------------



LEXER

Chisel, synthetic handle, 16mm
250mm, 9^{7/8}"

straight	210-148-250
----------	-------------

curved	210-149-250
--------	-------------

320mm, 12 ^{1/2} "	
----------------------------	--

straight	210-148-320
----------	-------------

curved	210-149-320
--------	-------------

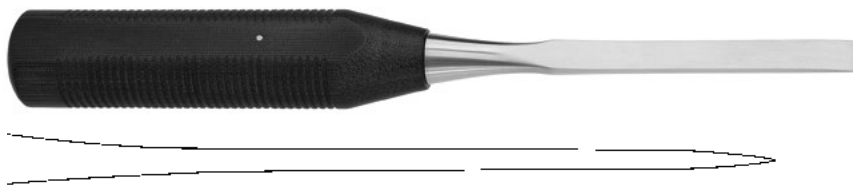

CAPENER

Osteotome, synthetic handle, 12.7mm
255mm, 10", straight

6mm	210-230-006
10mm	210-230-010
12mm	210-230-012
15mm	210-230-015
20mm	210-230-020
25mm	210-230-025
30mm	210-230-030

curved

6mm	210-231-006
10mm	210-231-010
12mm	210-231-012
15mm	210-231-015
20mm	210-231-020
25mm	210-231-025
30mm	210-231-030



Swan Neck Gouge, 25mm

A 285mm, 11¹/₄" 210-410-280

16mm

B 270mm, 10²/₃" 210-410-260

B 320mm, 12¹/₂" 210-410-320



Gouge for cement removal,
synthetic handle, 8mm

320mm, 12¹/₂" 210-154-320

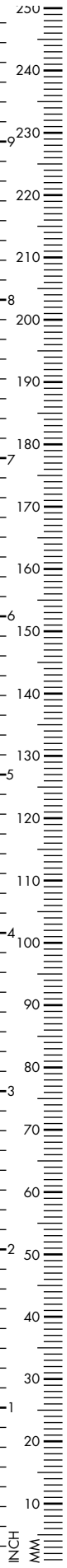



LEXER

Chisel, synthetic handle, 25mm

315mm, 12¹/₂"

210-251-025



LEXER

Chisel, synthetic handle, 8mm

280mm, 11"

210-251-280

330mm, 13"

210-251-330



Chisel for cement removal, synthetic handle,
5mm, 45° angled upwards

310mm, 12¹/₄"

210-153-310

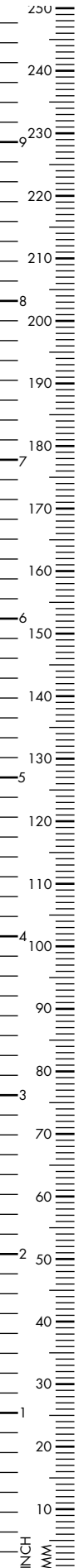

Gouge for cement removal, synthetic handle,
9mm, 340mm, 13^{1/3}"

A 210-159-009

B 210-156-009



Gouge, bayonet-shaped, synthetic handle, 8mm

320mm, 12^{3/4}" 210-154-300



Chisel, synthetic handle, 280mm, 11"

A For cement extraction, 9mm 210-157-009

B For cement splitting, 8.5mm 210-515-280



Mallet, lead filled head, Ø 20mm,
80g

165mm, 6^{1/2}" 210-220-080

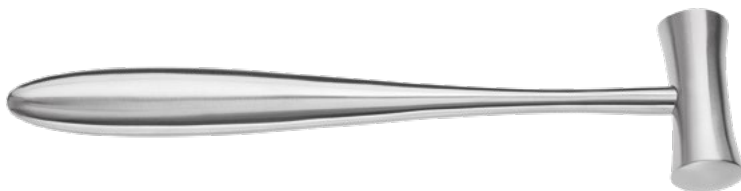

LUCAE
Mallet, Ø 19mm
80g

190mm, 7^{1/2}" 210-230-190



LUCAE
Mallet, Ø 25mm
140g

190mm, 7^{1/2}" 210-231-190



PARTSCH

Mallet, Ø 22mm

120g

180mm, 7"

210-225-180



DOYEN

Mallet, Ø 25mm

120g

210mm, 8^{1/4}"

210-250-210

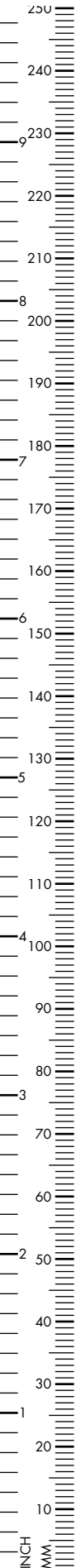



CLOWARD

Mallet, lead filled, Ø 19mm

215g

190mm, 7¹/₂"

210-215-190



COLLIN (LUCAE)

Mallet, Ø 30mm

220g

200mm, 8"

210-220-200



Mallet, 2 interchangeable plastic discs,

Ø 25mm

140g

185mm, 7¹/₄"

210-264-140

Spare Discs, pair

210-265-000



Mallet, anodized aluminium handle and head,
 Ø 32mm
 140g

225mm, 8 ^{7/8} "	210-264-220
Spare Discs, pair	210-264-221



WAGNER
 Mallet,
 complete with plastic discs 210-235-132,
 Ø 35mm
 130g

235mm, 9 ^{1/4} "	210-235-130
Plastic Discs, pair	210-235-132
Metal Discs, pair, 215g	210-235-131
Wrench	210-235-133

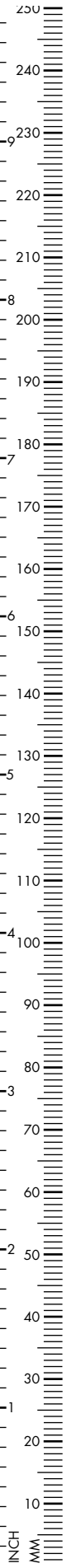



HAJEK

Mallet, Ø 27mm

140g

220mm, 8^{2/3}"

210-244-220



DOYEN

Mallet, Ø 30mm

180g

210mm, 8^{1/4}"

210-300-210



Mallet, exchangeable disc,
1 teflon insert / 1 metal insert

Ø 25mm

205g

190mm, 7^{1/2}"

210-261-191



Mallet, handle with recessed grip,
 Ø 35mm, 265mm, 10¹/₂"

450g	210-265-450
900g	210-265-900



USA MODEL

Mallet, Ø 35mm
 485g

180mm, 7"	210-300-180
-----------	-------------



USA MODEL

Mallet, Ø 38mm
 900g

190mm, 7 ¹ / ₂ "	210-300-190
--	-------------

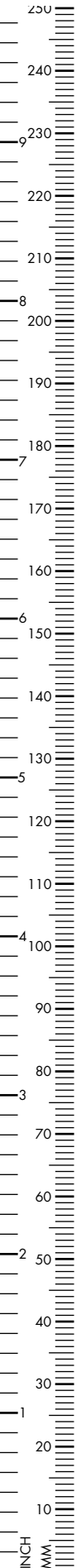



CLOWARD

Mallet, Ø 25mm
220g

230mm, 9" 210-220-230



BERGMANN (HIBBS)

Mallet, Ø 40mm
260g

230mm, 9" 210-500-230



MEAD

Mallet, with 2 interchangeable plastic discs,
Ø 27mm
180g

190mm, 7¹/₂" 210-262-170

Spare Discs, pair 210-263-000



WILLIGER

Mallet, Ø 26mm
300g

240mm, 9¹/₂" 210-240-300



Mallet, lead filled head, repercussion-free,
synthetic handle
Ø 30mm
290g

265mm, 10^{1/2}" 210-290-260

Spare Discs, pair 210-290-000



Mallet, Ø 30mm / 42mm, synthetic handle,
420g

260mm, 10^{1/4}" 210-242-240



Mallet, Ø 37mm, ferrozell handle and discs,
240g
250mm, 9⁷/₈" 210-240-250
Spare Discs, pair 210-240-000



Mallet, Ø 35mm, ferrozell
240mm, 9¹/₂" 210-260-150
Ø 42mm
260mm, 10¹/₄" 210-260-240
Ø 50mm
260mm, 10¹/₄" 210-260-330



Mallet, synthetic handle,
Ø 30mm, 350g
250mm, 9⁷/₈" 210-260-350
Ø 35mm, 500g
250mm, 9⁷/₈" 210-260-500
Ø 40mm, 700g
250mm, 9⁷/₈" 210-260-700



GERZOG

Mallet, lead filled head, Ø 30mm
300g

190mm, 7^{1/2}"

210-180-400



BERGMANN

Mallet, Ø 30mm
300g

230mm, 9"

210-218-230



WILLIGER

Mallet, Ø 28mm
300g

240mm, 9^{1/2}"

210-240-340

Ø 30mm, 400g

240mm, 9^{1/2}"

210-240-400

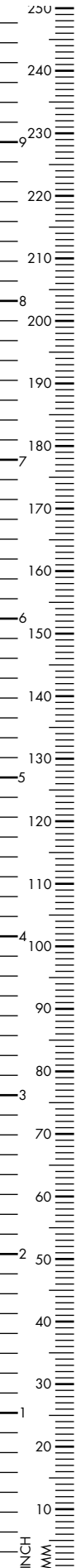



BERGMANN

Mallet, Ø 30mm
450g

230mm, 9"

210-329-230



Mallet, synthetic handle, Ø 35mm
450g

265mm, 10¹/₂"

210-240-450

Ø 50mm, 900g

265mm, 10¹/₂"

210-240-451



Mallet, Ø 40mm
520g

185mm, 7^{1/4}" 210-240-520



OMBREDANNE

Mallet, Ø 40mm
520g

265mm, 10^{1/2}" 210-271-240



KIRK

Mallet, Ø 40mm
690g

195mm, 7^{3/4}" 210-225-185



HEATH

Mallet, copper filled head, Ø 40mm
700g

185mm, 7¹/₄" 210-270-185



OMBREDANNE

Mallet, Ø 40mm
710g

240mm, 9¹/₂" 210-270-240

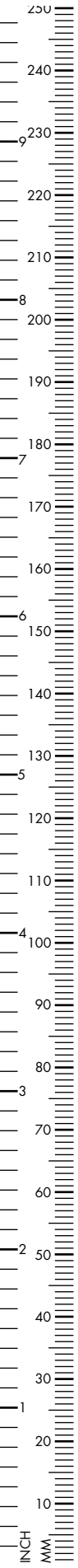

BRUENINGS

Bone Tamper,
160mm, 6^{1/4}"

A	Ø 3mm	210-115-003
B	Ø 5mm	210-115-005
C	Ø 7mm	210-115-007
D	Ø 9mm	210-115-009

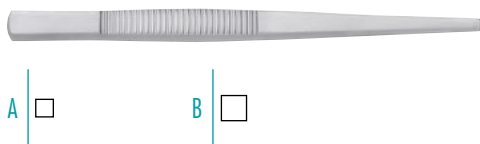

PASSOW

Bone Tamper,
120mm, 4^{3/4}"

A	Ø 2.5mm	210-325-120
B	Ø 3.5mm	210-335-120

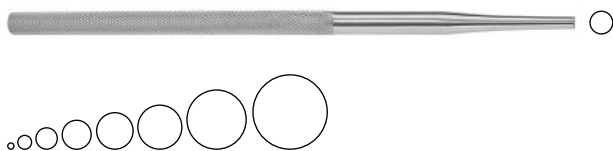

Bone Tamper, round handle, smooth
150mm, 6"

1mm	210-275-151
2mm	210-275-152
3mm	210-275-153
4mm	210-275-154
5mm	210-275-155
6mm	210-275-156
8mm	210-275-158
10mm	210-275-160

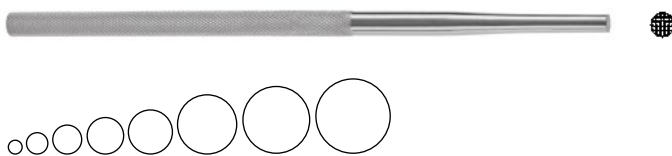

Bone Tamper, smooth round handle, serrated
155mm, 6^{1/8}"

2mm	210-090-002
3mm	210-090-003
4mm	210-090-004
5mm	210-090-005
6mm	210-090-006
8mm	210-090-008
9mm	210-090-009
10mm	210-090-010

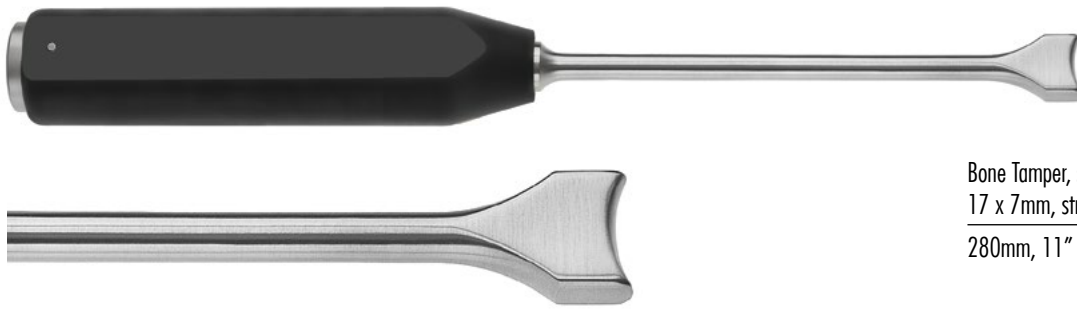

Bone Tamper, synthetic handle,
17 x 7mm, straight

280mm, 11" 210-090-020

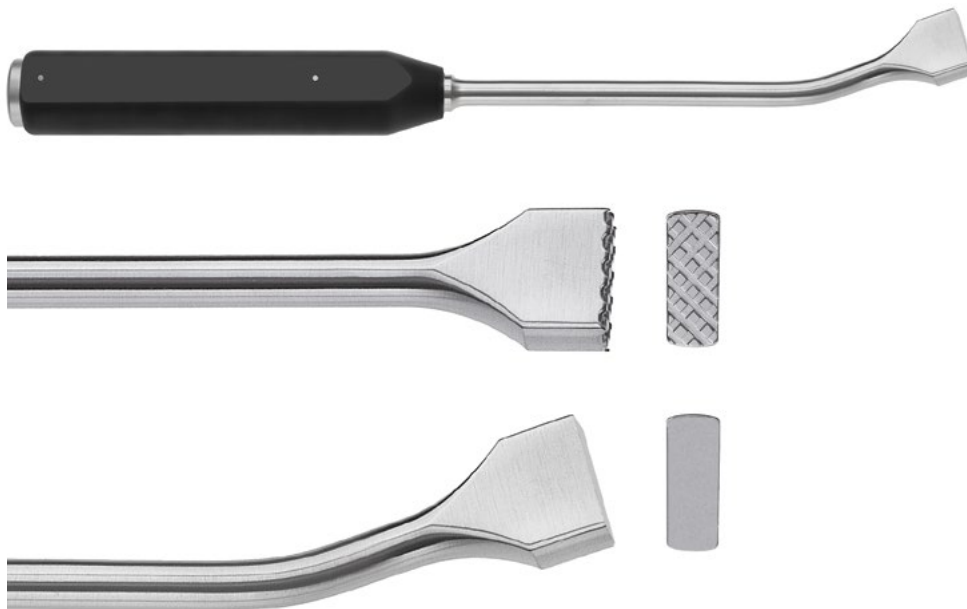

Bone Tamper, synthetic handle,
15 x 6mm, straight, serrated

255mm, 10" 210-090-021

280mm, 11" 210-090-030

315mm, 12^{1/3}" 210-090-033

straight, smooth

255mm, 10" 210-090-023

280mm, 11" 210-090-032

315mm, 12^{1/3}" 210-090-035

curved, smooth

255mm, 10" 210-090-022

280mm, 11" 210-090-031

315mm, 12^{1/3}" 210-090-034

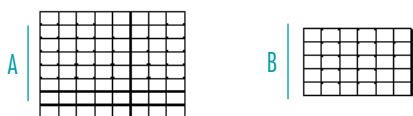

Bone Tamper, synthetic handle,
350mm, 14"

A 19 x 14mm 210-090-012

B 15 x 10mm 210-090-011



SYPERT

Bone Tamper, synthetic handle
190mm, 7^{1/2}"

A	3 x 8mm	210-091-100
B	4 x 10mm	210-091-101
C	5 x 15mm	210-091-102
D	6 x 20mm	210-091-103



CASPAR

Bone Tamper, synthetic handle, 200mm, 8"

3mm	210-273-200
5mm	210-274-200
8mm	210-275-200
12mm	210-212-200
14mm	210-214-200
16mm	210-215-200

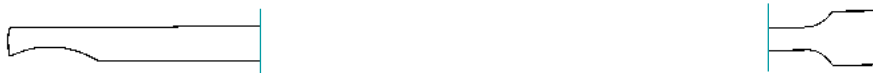

Cement Tamper, small, double-ended,
7mm / 3mm

230mm, 9"	210-093-230
-----------	-------------

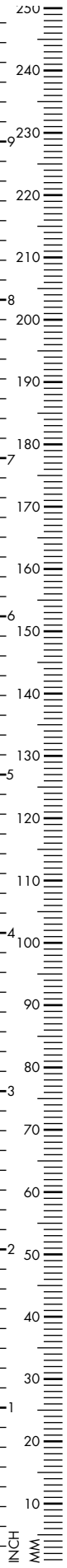

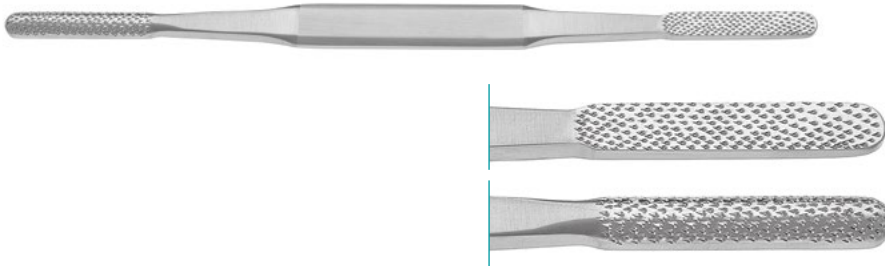

FOMON

Rasp, fine, double-ended, 7.5mm / 6.5mm

215mm, 8^{1/2}"

420-661-000

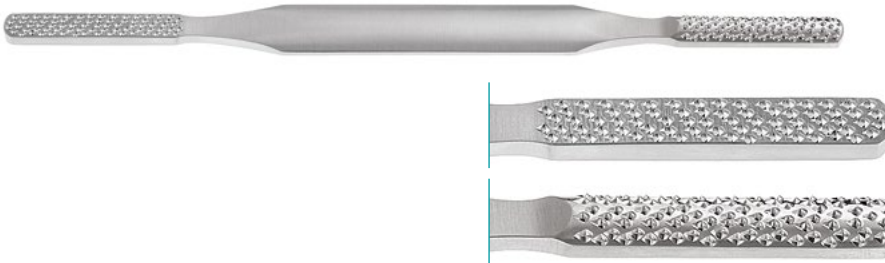

FOMON

Rasp, coarse, double-ended, 7.0mm / 8.0mm

215mm, 8^{1/2}"

420-660-000

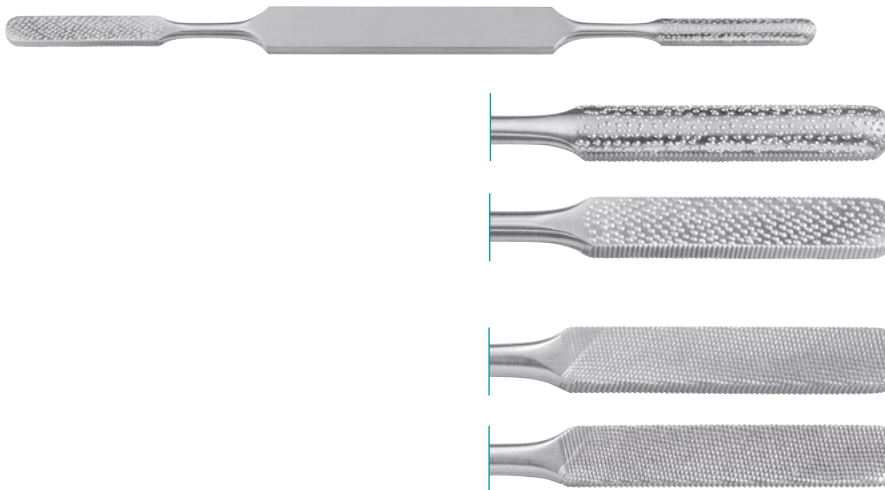

FOMON

Rasp, fine/coarse, double-ended, 4 sides

215mm, 8^{1/2}"

420-661-100

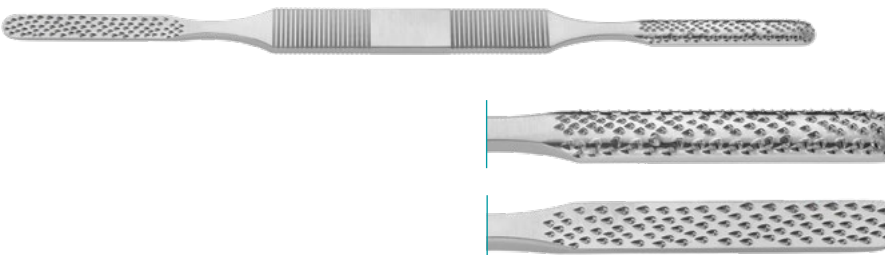

FOMON LIGHTWEIGHT

Rasp, double-ended, 7.0mm

215mm, 8^{1/2}"

Coarse

420-662-001

Fine

420-662-002

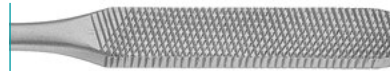
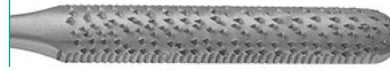
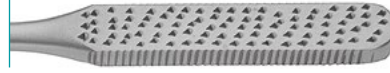

KLEINERT KUTZ

Rasp, double-ended, 4 sides

220mm, 8²/₃"

420-656-000



Fig. 1



Fig. 2

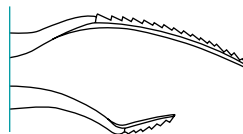
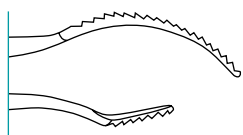

Fig. 3



MILLER

Rasp, 90° cross-serrated, backwards cutting, 180mm, 7"

Fig. 1 8mm / 5mm

500-387-000

Fig. 2 6mm / 4mm

500-384-010

Fig. 3 6mm / 5mm

500-386-045



MALTZ

Rasp, straight, backward cutting

180mm, 7"

420-654-180

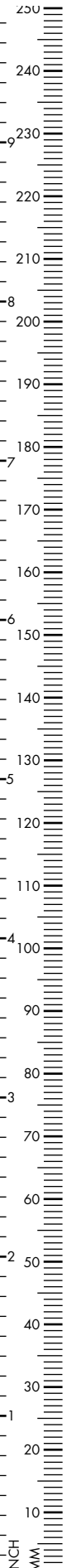



FOMON

TC Rasp, double-ended, 7 x 40mm
210mm, 8¹/₄"

Fig. 1 / Fig. 2	420-660-219
Fig. 3 / Fig. 4	420-660-214
Fig. 5 / Fig. 6	420-660-216
Fig. 7 / Fig. 8	420-660-218
Fig. 9 / Fig. 10	420-660-200



PARKES

TC Rasp, straight, 8 x 39mm
210mm, 8¹/₄"

Fig. 1	420-490-210
Fig. 2	420-491-210
Fig. 3	420-492-210
Fig. 4	420-493-210
Fig. 5	420-494-210
Fig. 6	420-495-210
Fig. 7	420-496-210
Fig. 8	420-497-210
Fig. 9	420-498-210
Fig. 10	420-499-210



MALTZ

TC Rasp,
165mm, 6¹/₂"

Fig. 2	420-492-165
Fig. 3	420-493-165
Fig. 4	420-494-165
Fig. 5	420-495-165
Fig. 6	420-496-165



Fig.1
0.8



Fig.2
1.1



Fig.3
1.3



Fig.4
1.6



Fig.5
1.8



Fig.6
2.0



Fig.7
2.4



Fig.8
2.6



Fig.9
2.8



Fig.10
3.0

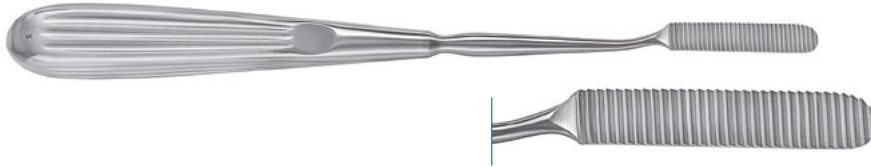

MALTZ (COTTLE)

Rasp, backward cutting

210mm, 8¹/₄"

420-670-210



GALLAHER

Rasp, with ring, coarse

170mm, 6²/₃"

420-678-190



PUTTI

Bone File

300mm, 11⁷/₈"

210-181-300



PUTTI

Bone File

270mm, 10²/₃"

210-183-270

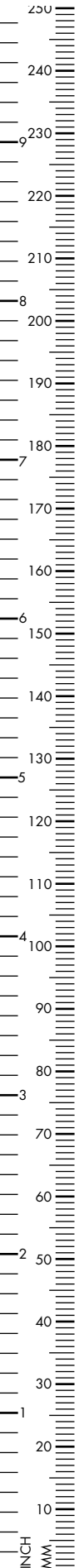



PUTTI

Rasp, angled shaft, silicone handle

310mm, 12¹/₄"

210-183-270



Bone File / Rasp

220mm, 8²/₃"

210-178-220



Bone File, hollow handle,

A semi-round

280mm, 11"

210-176-280

B bayonet-shaped

240mm, 9¹/₂"

210-177-245



TC Wire Twisting Forceps

150mm, 6"	180-501-150
-----------	-------------

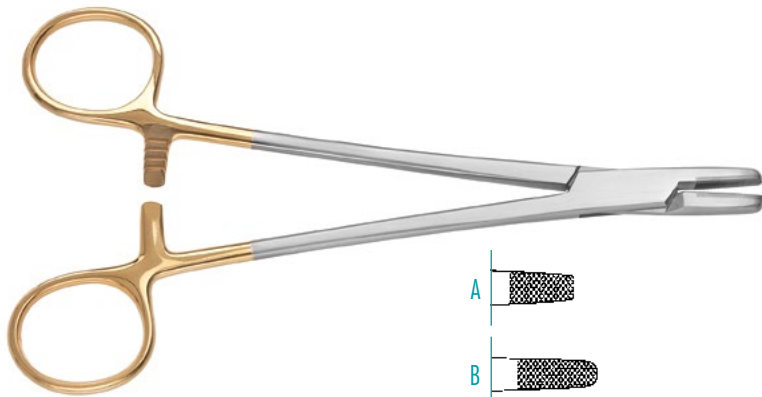

BERRY

TC Heavy Sternal Needle Holder

150mm, 6"

A	180-307-150
---	-------------

B	180-308-150
---	-------------

180mm, 7"

C	180-307-180
---	-------------

D	180-308-180
---	-------------

200mm, 8"

E	180-307-200
---	-------------

F	180-308-200
---	-------------

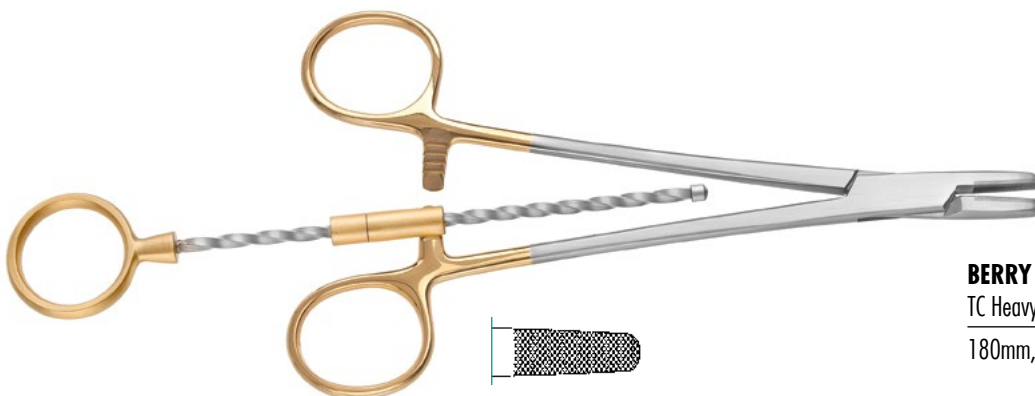
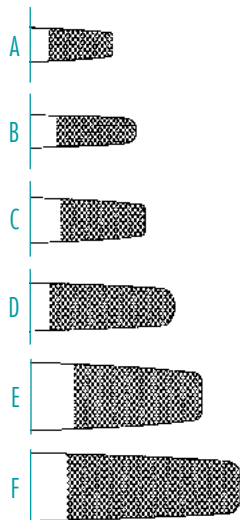

BERRY

TC Heavy Sternal Needle Holder

180mm, 7"	180-309-180
-----------	-------------

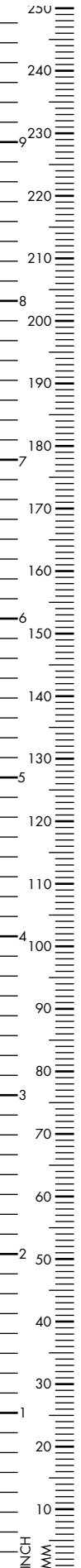



TC Wire Holding Clamp, round jaw

130mm, 5¹/₈"

180-569-130

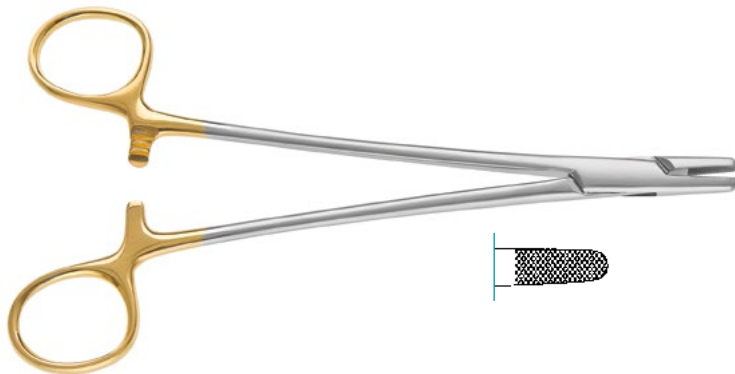

TC Wire Holding Clamp / Sternum

180mm, 7"

180-569-180

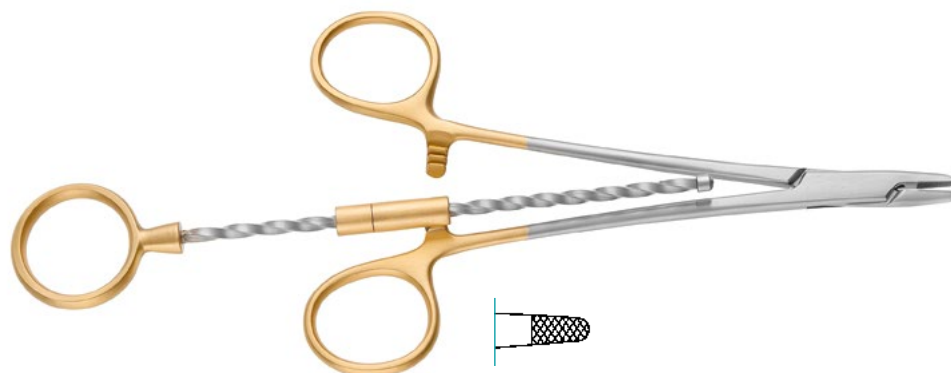

CORWIN

TC Wire Twister with drill

130mm, 5¹/₈"

180-811-130

185mm, 7¹/₄"

180-810-185



Wire Extraction Plier, lateral support
to hold wire in place, 170mm, 6²/₃"

without drill 200-514-170

with drill 200-515-170

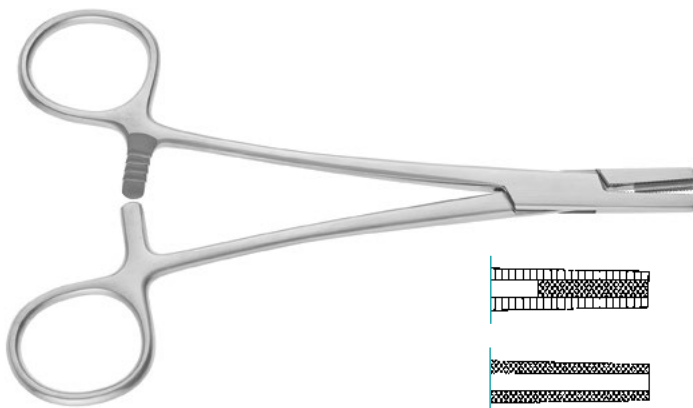

Wire Pulling Forceps

165mm, 6¹/₂" 200-503-165

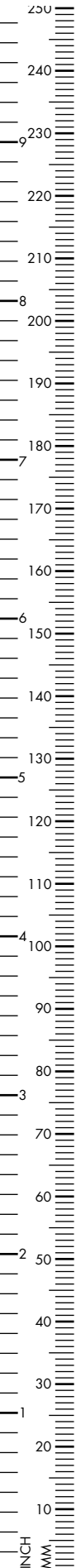



Wire Holding Forceps

140mm, 5¹/₂" 200-515-140



Flat Nose Plier, distal jaw, smooth

140mm, 5¹/₂" 180-507-140



Flat Nose Plier, serrated jaw

140mm, 5¹/₂" 180-511-140

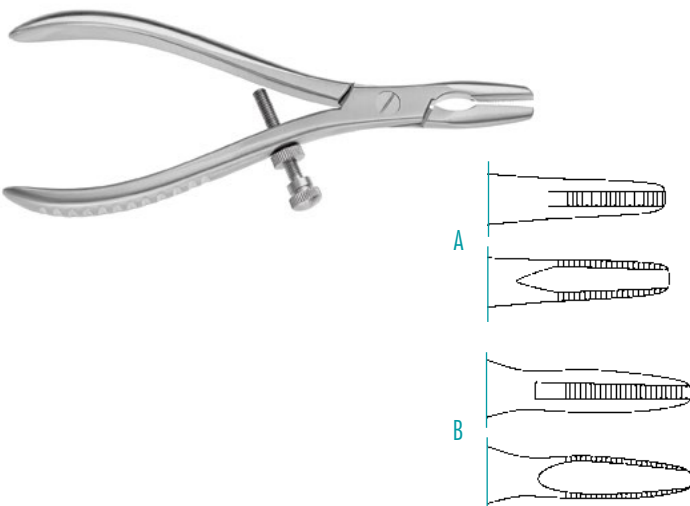

Wire Extraction Forceps

A 130mm, 5¹/₈" 200-507-130

B 180mm, 7" 200-507-180

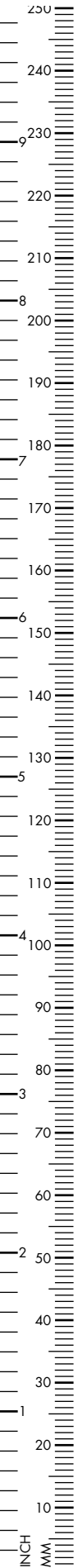

Wire Twister / Tightener

160mm, 6¹/₄"

180-512-160

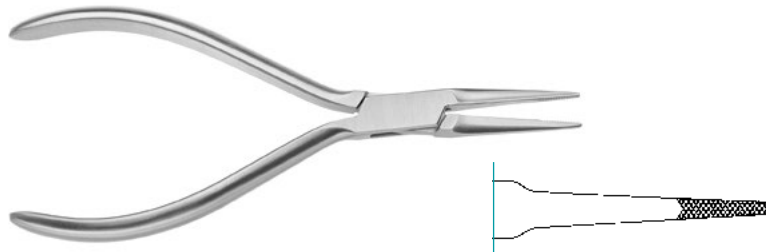

Flat Nose Plier, delicate long jaw,
2mm wide tip

160mm, 6¹/₄"

180-515-160



Flat Nose Plier, sharp

195mm, 7³/₄"

180-500-180

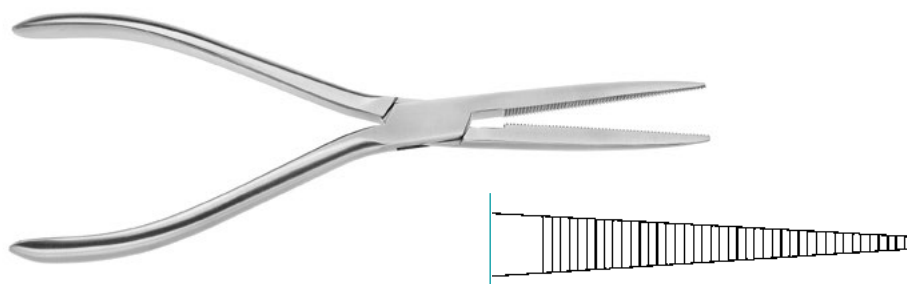

Long Jaw Needle Nose Plier,
parallel serrated jaw

178mm, 7"

180-513-170

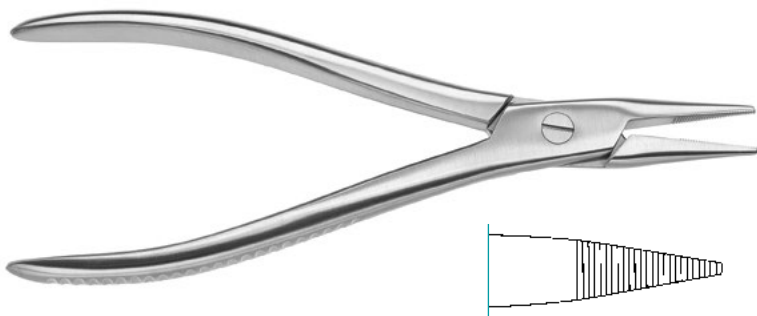

Narrow Nose Wire Pulling Forceps,
3mm jaw

190mm, 7¹/₂" 180-513-190

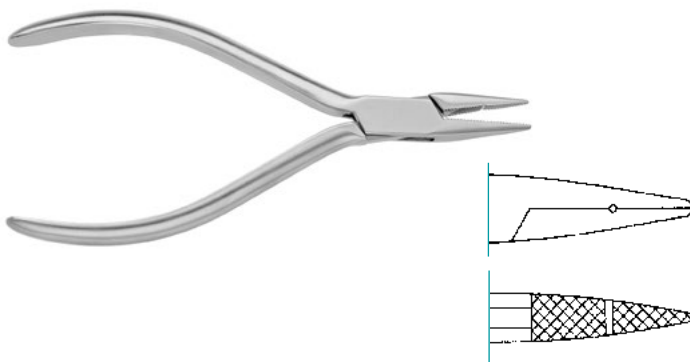

Needle Nose Plier,
wire with groove, for 1mm cerclage

140mm, 5¹/₂" 200-518-140



Flat Nose Plier, with groove

160mm, 6¹/₄" 200-518-160

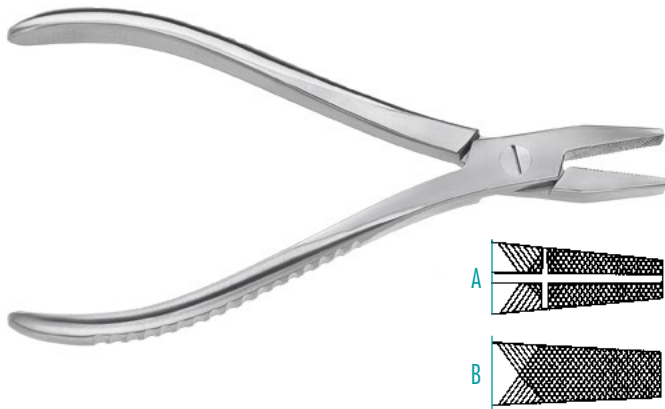
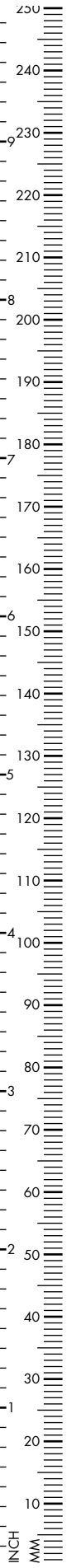

Wire Holding Pliers,
with longitudinal and transversal grooves,
170mm, 6²/₃"

A	180-500-170
B	180-501-170

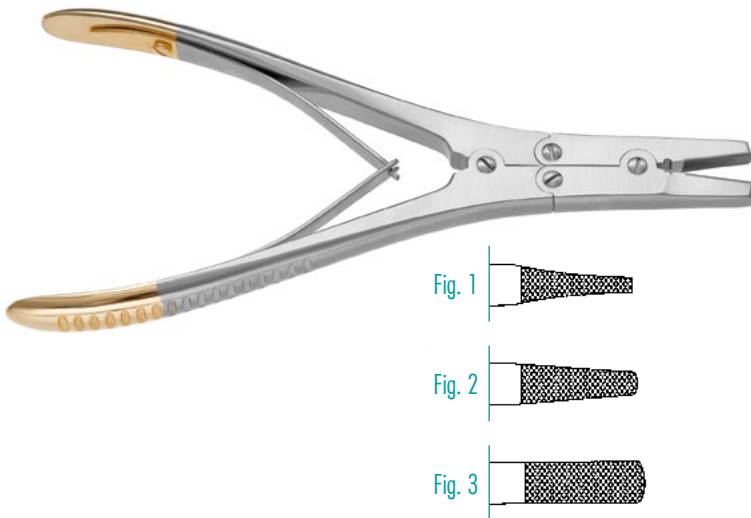

TC Flat Nose Plier, double action
180mm, 7"

Fig. 1	200-511-001
Fig. 2	200-511-002
Fig. 3	200-511-003

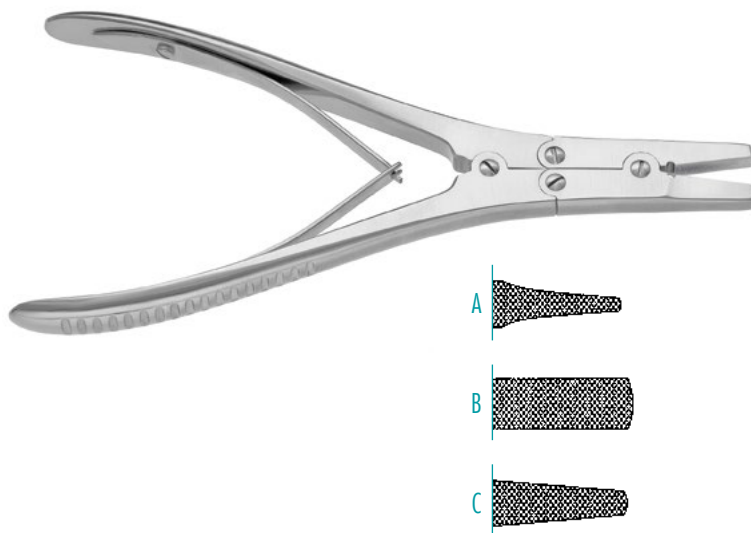

Wire Extraction Plier, double action
145mm, 5³/₄"

A	200-514-145
180mm, 7"	
B	200-507-180
C	200-514-180



Flat Nose Plier, 2mm tapered tip

140mm, 5^{1/2}" 180-510-140

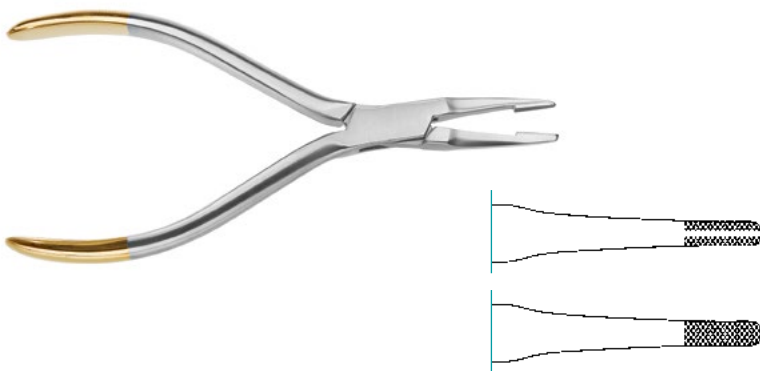

Pin Pulling Forceps, 1 TC Insert

140mm, 5^{1/2}" 180-512-140



LANGENBECK

Round Plier, smooth, round jaw

140mm, 5^{1/2}" 180-634-140

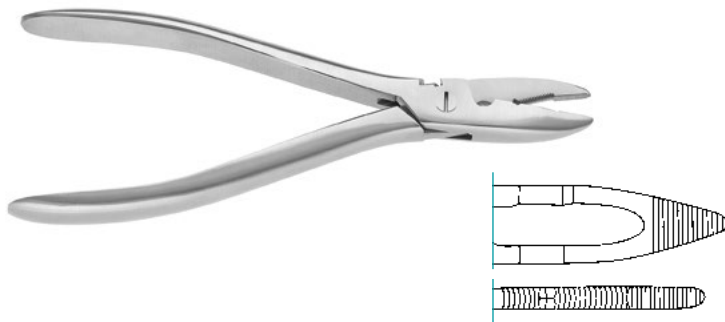

WALDSACHS

Universal Plier

155mm, 6^{1/8}"

180-790-150

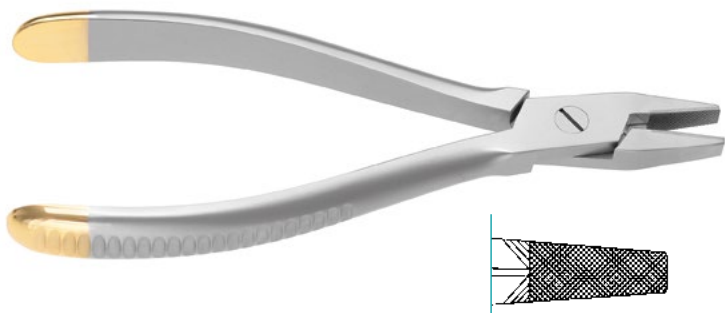

TC Multi-Purpose Plier

190mm, 7^{1/2}"

180-501-190



PEESO

Wire Bending Plier

135mm, 5^{1/3}"

180-843-135

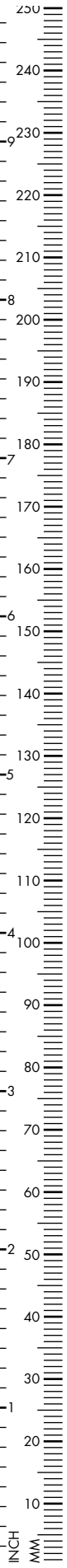



Wire and Pin Bender / up to 3.2mm

150mm, 6"

200-204-150



LOUTE

Wire Tightener

210mm, 8¹/₄"

200-513-210

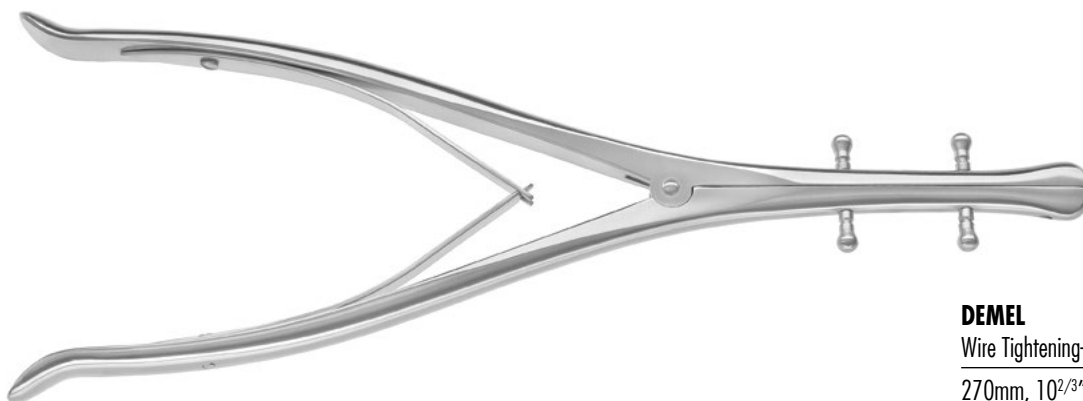

DEMEL

Wire Tightening- and Twisting Forceps

270mm, 10²/₃"

200-755-270



Needle Nose Locking Plier

A 220mm, 8²/₃" / small

Regular model 200-515-220

For Extraction Mallet 200-515-221

B 250mm, 9⁷/₈" / medium

Regular model 200-515-250

For Extraction Mallet 200-515-251

C 300mm, 11⁷/₈" / large

Regular model 200-515-300

For Extraction Mallet 200-515-301

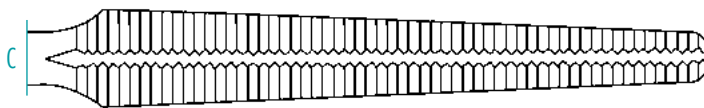
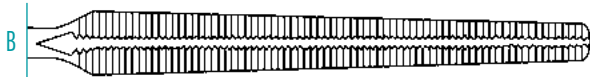

Extraction Mallet
for small and medium models

400g

350mm, 14" 210-400-350

for large models

700g

400mm, 15³/₄" 210-700-350

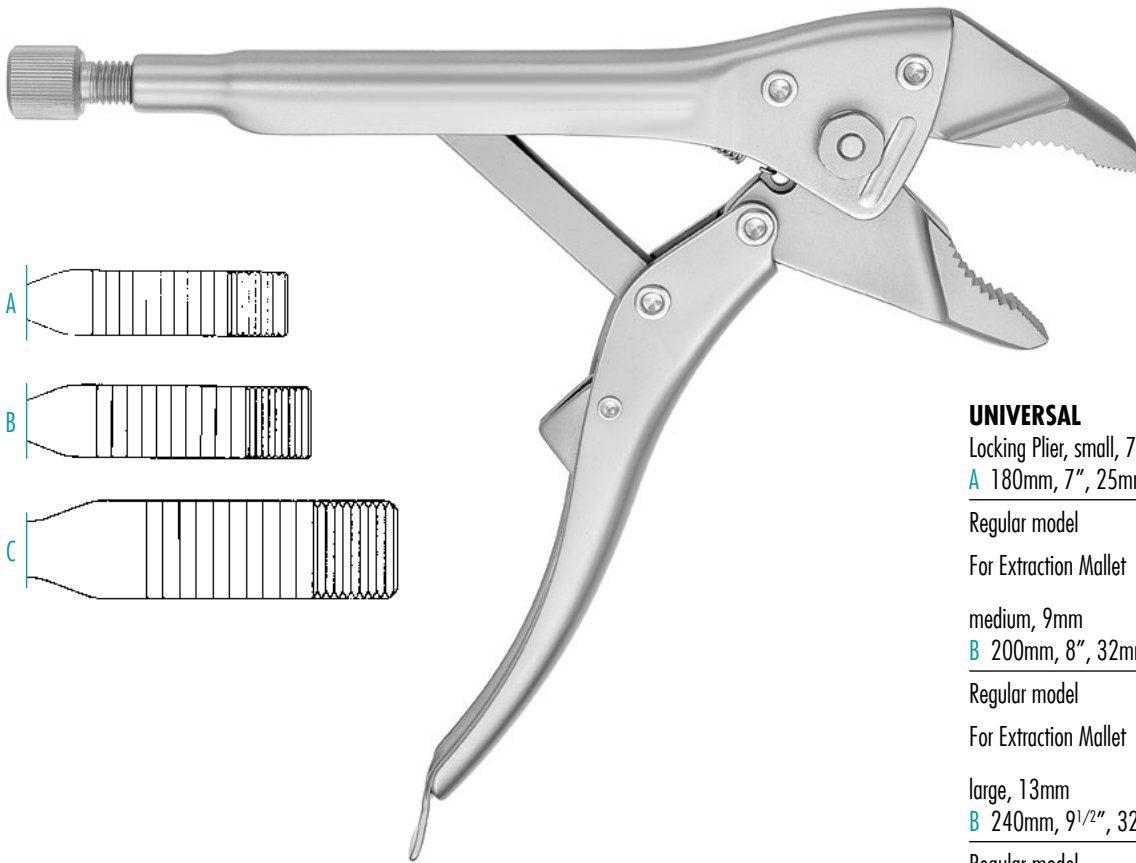

UNIVERSAL

Locking Plier, small, 7mm

A 180mm, 7", 25mm jaw spreading

Regular model 200-511-180

For Extraction Mallet 200-511-181

medium, 9mm

B 200mm, 8", 32mm jaw spreading

Regular model 200-511-200

For Extraction Mallet 200-511-201

large, 13mm

B 240mm, 9 1/2", 32mm jaw spreading

Regular model 200-511-240

For Extraction Mallet 200-511-241



UNIVERSAL

Wire sizing Forceps,
max. opening 50mm

200mm, 8" 180-502-200



Wire Gripper, parallel closure

185mm, 7 1/4" 200-513-185

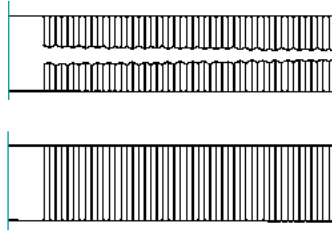
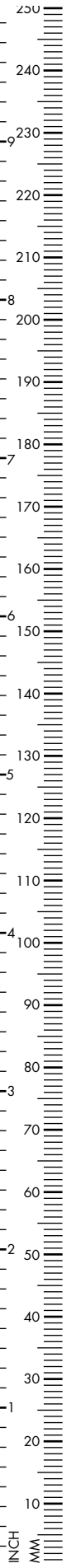

Combined Wire Cutter and Gripper

180mm, 7"

200-512-185



Flat Nose Plier, 3.5mm jaw

160mm, 6^{1/4}"

180-535-160

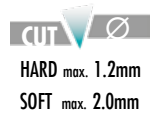
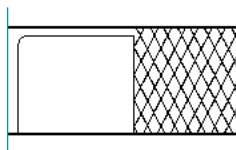
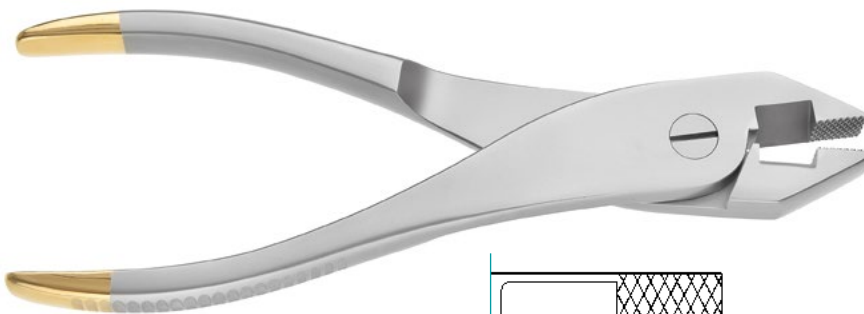



LINEMAN

Plier with cutting edge

220mm, 8^{2/3}"

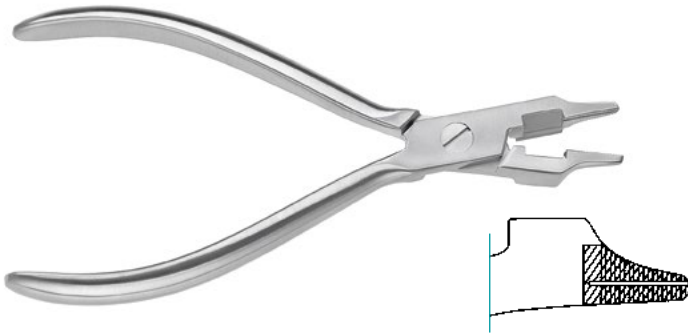
200-516-220



CUT 
HARD max. 1.0mm
SOFT max. 1.5mm

UNIVERSAL

Wire Cutting and Bending Forceps

150mm, 6" 200-513-150

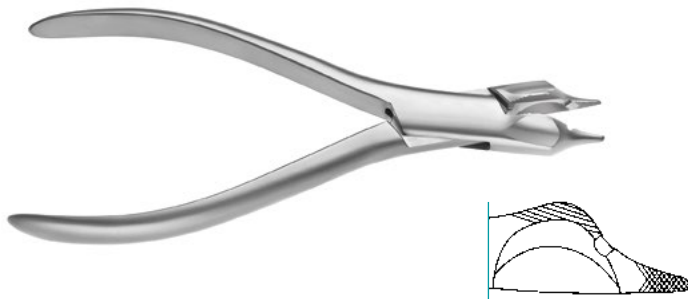

CUT 
HARD max. 0.7mm
SOFT max. 1.0mm

Wire Cutting / Bending Forceps

150mm, 6" 200-514-150

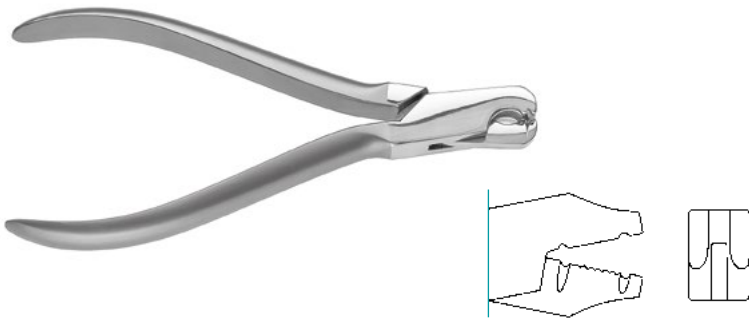

K-Wire and Plate Bending Forceps,
 for mini plates up to 1.6mm,
 90° - bending for K-Wires

140mm, 5¹/₂" 200-416-140

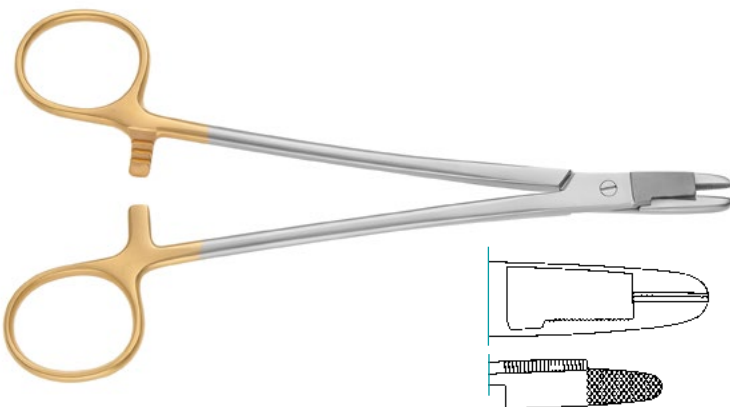

KOPPELMANN

Wire Twister and Scissors

185mm, 7¹/₄" 180-572-185

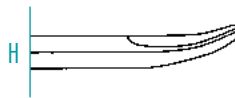
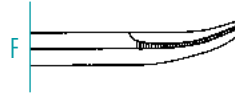
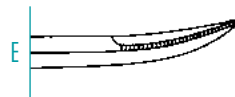
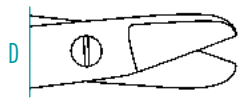
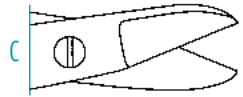
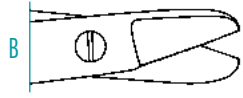
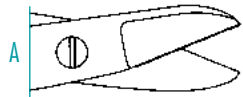

Crown & Collar Scissors, 100mm, 4"

A	Straight, sharp, serrated	120-296-100
B	Straight, blunt, serrated	120-300-100
C	Straight, sharp	120-294-100
D	Straight, blunt	120-298-100
E	Curved, sharp, serrated	120-297-100
F	Curved, blunt, serrated	120-301-100
G	Curved, sharp	120-295-100
H	Curved, blunt	120-299-100

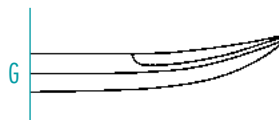
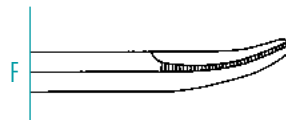
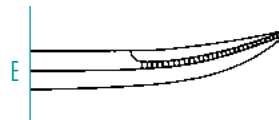
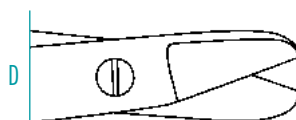
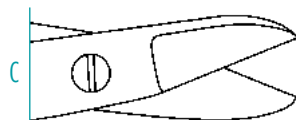
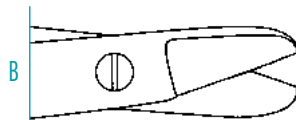
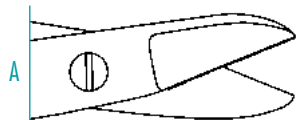

Crown & Collar Scissors, 120mm, 4³/₄"

A	Straight, sharp, serrated	120-296-120
B	Straight, blunt, serrated	120-300-120
C	Straight, sharp	120-294-120
D	Straight, blunt	120-298-120
E	Curved, sharp, serrated	120-297-120
F	Curved, blunt, serrated	120-301-120
G	Curved, sharp	120-295-120
H	Curved, blunt	120-299-120

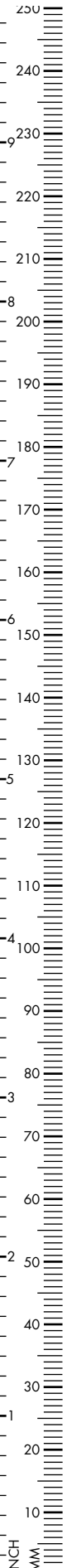

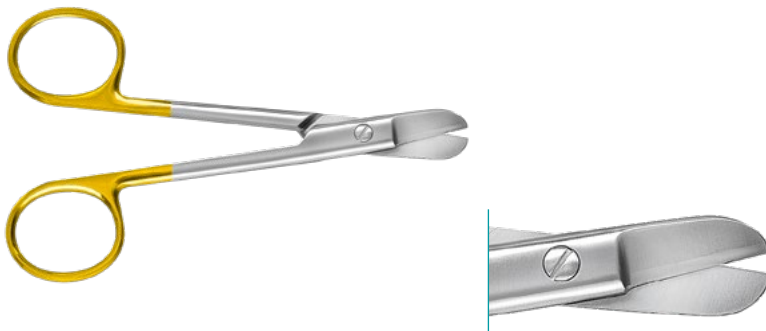

TC Wire Scissors
120mm, 4^{3/4}" 120-596-120

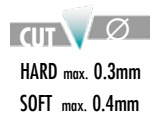
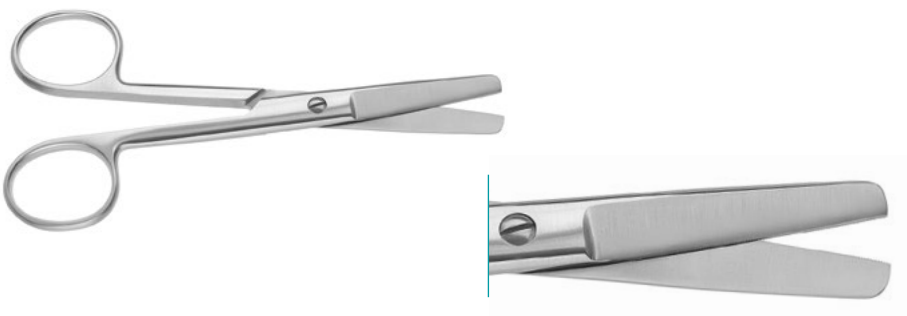

HARVEY
Wire Cutting Scissors, serrated
125mm, 5" 120-262-125

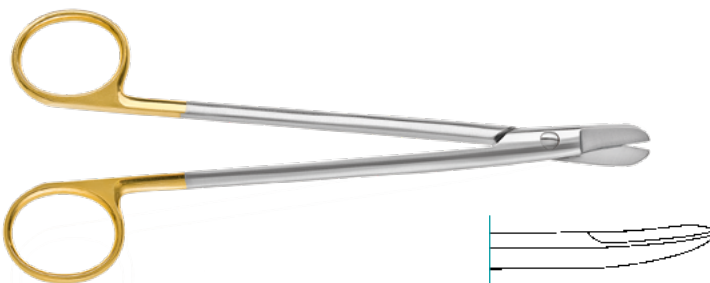

SMITH
TC Wire Scissors, serrated, 160mm, 6^{1/4}"
straight 120-570-160
curved 120-571-160

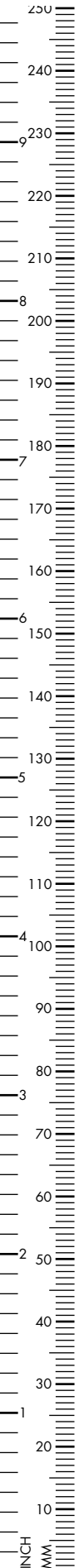

SCHUKNECHT

Wire Scissors, straight, short blade

100mm, 4"

120-120-100



HARD max. 0.8mm

SOFT max. 1.2mm

UNIVERSAL

Wire & Plate Scissors, serrated

120mm, 4³/₄"

120-265-120

With TC inserts

120mm, 4³/₄"

120-565-120

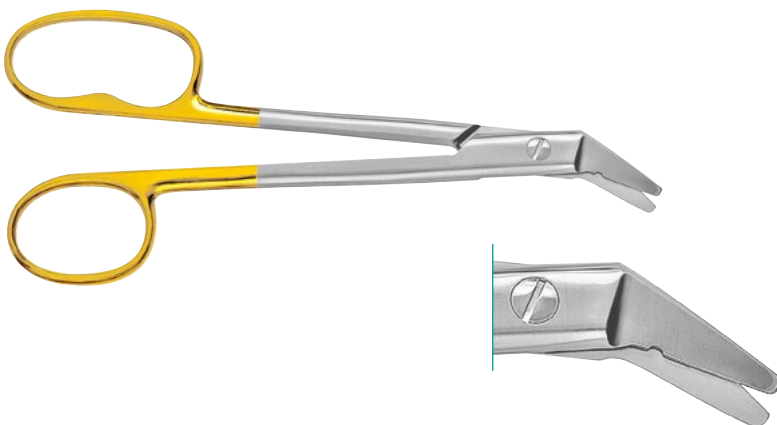

UNIVERSAL

TC Wire & Plate Scissors

170mm, 6²/₃"

120-565-170



TC Wire Cutter, up to 0.7mm
 110mm, 4^{1/3}" 200-500-110

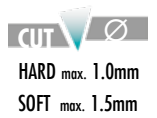

TC Wire Cutter
 150mm, 6" 180-513-530

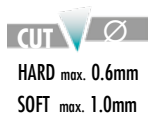
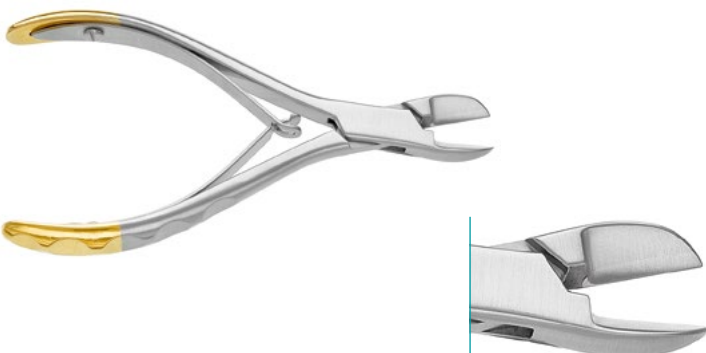

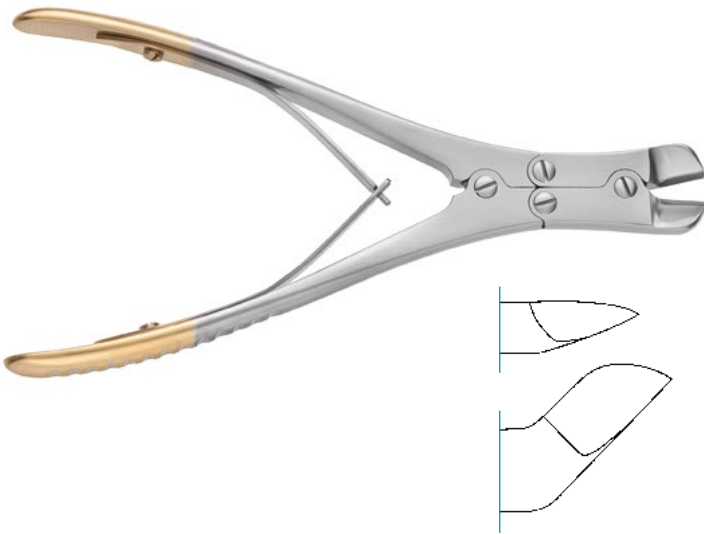
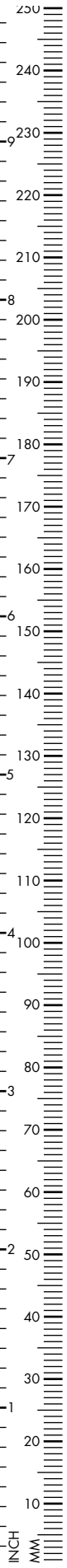

TC Wire Cutter
 120mm, 4^{3/4}" 200-500-120

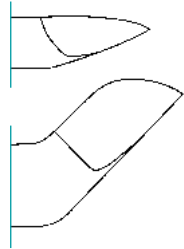

CUT 
 HARD max. 1.6mm
 SOFT max. 2.0mm

TC Wire Cutter, angled
 170mm, 6^{2/3}" 200-500-160



CUT 
 HARD max. 1.8mm
 SOFT max. 2.2mm

REILL
 TC Wire Cutter, angled
 220mm, 8^{2/3}" 200-500-220



CUT 
 HARD max. 2.2mm
 SOFT max. 3.0mm

TC Wire Cutter, 45° angled jaw
 235mm, 9^{1/4}" 200-504-235



CUT 
 HARD max. 2.2mm
 SOFT max. 3.0mm

TC Wire Cutter, 12° angled jaw
 235mm, 9^{1/4}" 200-503-235

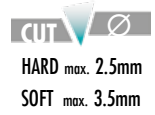

TC Front Wire Cutter
220mm, 8²/₃" 200-506-220

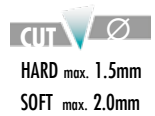

TC Front and Lateral Wire Cutter
150mm, 6" 200-510-150

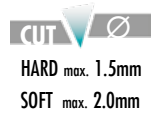

Wire Cutter, 180mm, 7"
200-502-180
TC Inserts 200-504-180

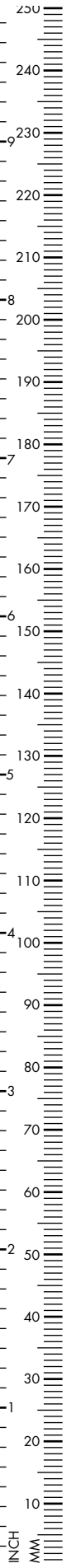



CUT 
HARD max. 0.7mm
SOFT max. 1.0mm

TC Wire Cutter

145mm, 5^{3/4}"

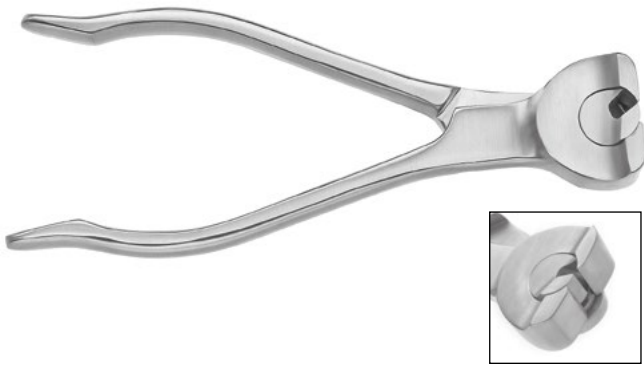
200-510-145



CUT 
HARD max. 1.6mm
SOFT max. 2.0mm

Diamond Head-Wire Cutter, front action

160mm, 6^{1/4}"

200-510-160





CUT 
HARD max. 1.6mm
SOFT max. 2.4mm

Head Cutter, cannulated

185mm, 7^{1/4}"

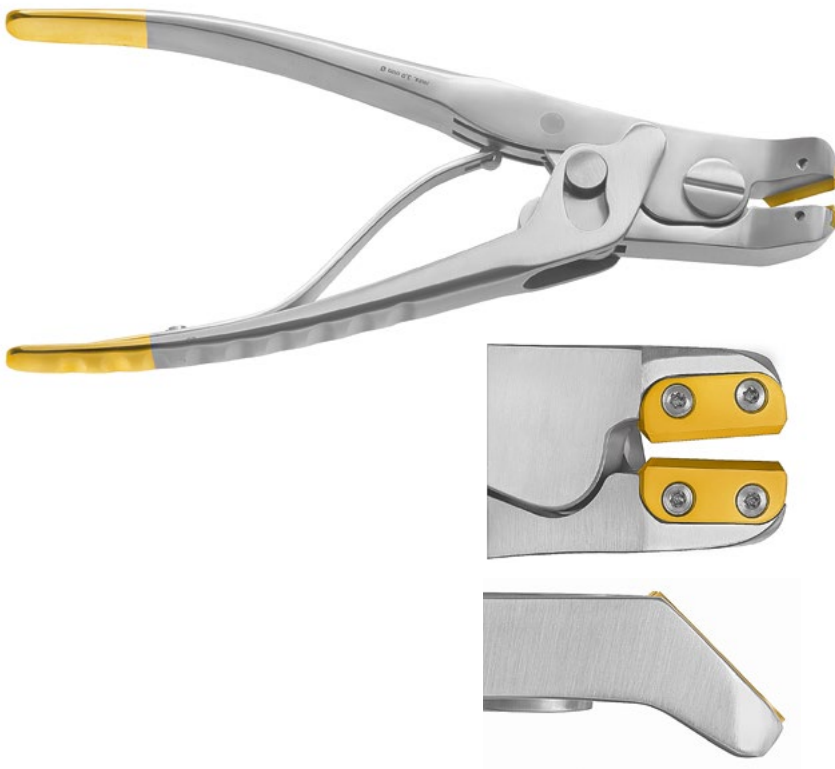
200-502-185



CUT 
 HARD max. 2.2mm
 SOFT max. 2.8mm

TC "Easy Cut" Wire Cutter

200mm, 8" 200-502-200



CUT 
 HARD max. 2.2mm
 SOFT max. 2.8mm

TC Wire Cutter,
 exchangeable TC Blades and rubber jaw
 up to \varnothing 3.0mm

230mm, 9" 200-500-230

up to \varnothing 4.0mm

280mm, 11" 200-502-280

TC Blades spare set

200-502-997

Rubber jaw spare set

200-502-998

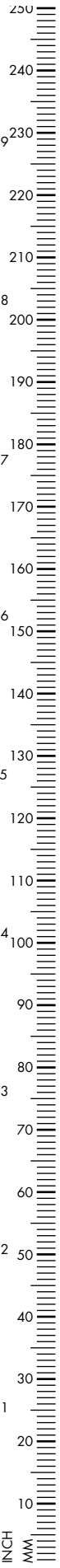

TC Wire Cutter for right-hander,
exchangeable TC blades and rubber jaw

180mm, 7" 200-505-180



TC Front and Side Cutter,
exchangeable TC blades and rubber jaw

180mm, 7" 200-509-180

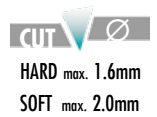

TC Flush Wire Cutter

180mm, 7" 200-508-180



UP TO 3.2mm

TC Wire Cutter, double action

240mm, 9¹/₂"

200-522-240



UP TO 6.35mm

Pin Cutter, detachable handles

575mm, 22¹/₂"

200-500-585



TC Pin Cutter

470mm, 18 1/2"

200-500-470



TC Front Cutter

380mm, 15"

200-500-380

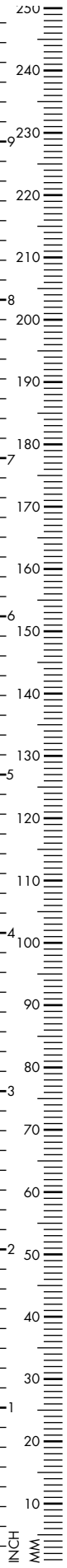

Wire Guide, synthetic handle, 210mm, 8¹/₄"

Size 1 180-751-018

Size 2 180-751-020

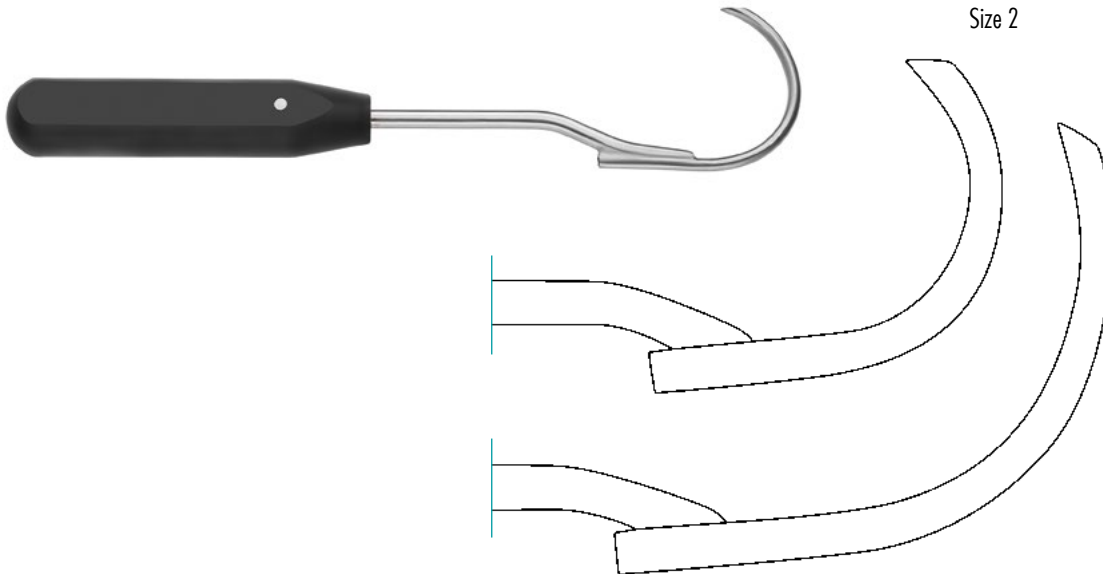

Bone Wire Guide, hollow, sharp

240mm, 9¹/₂" 180-751-014

270mm, 10²/₃" 180-751-016

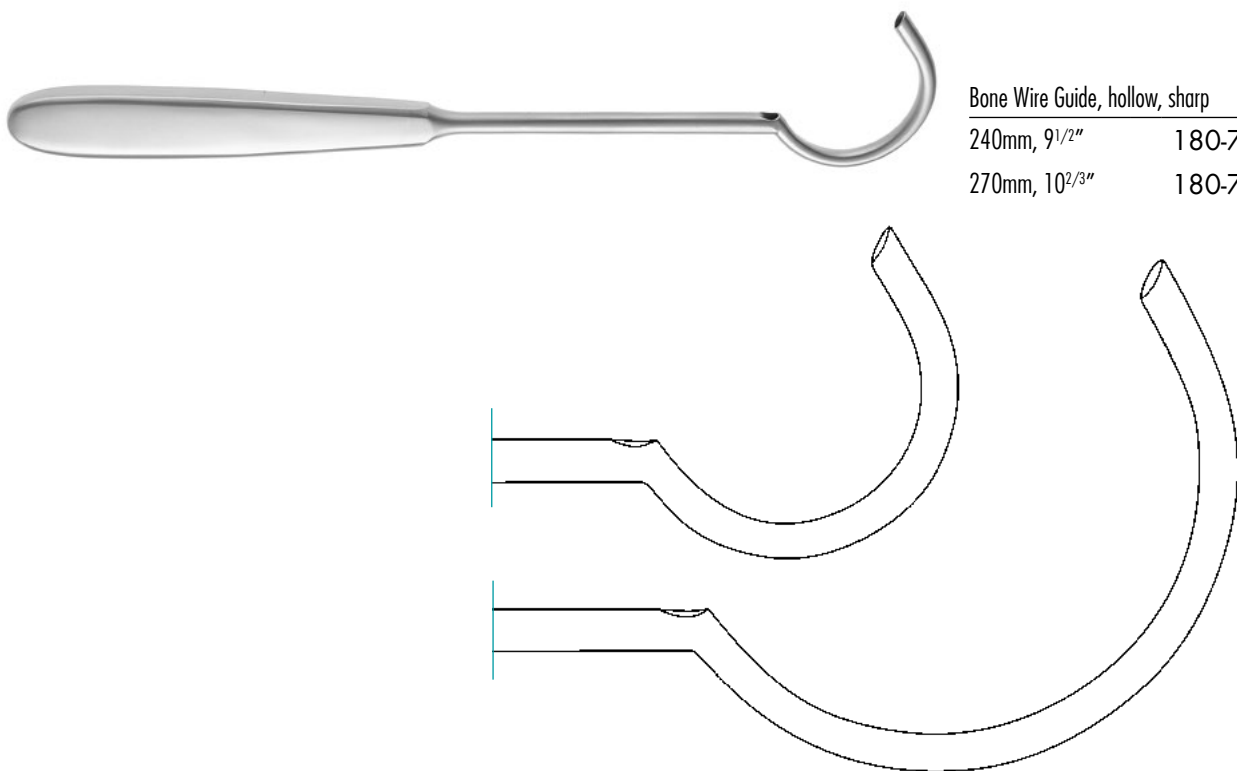

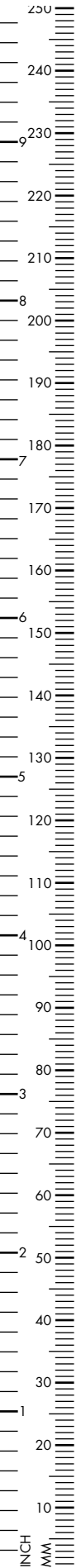

DEMEL

Bone Wire Guide, 280mm, 11"

#1 180-751-001

#2 180-751-002

305mm, 12"

#3 180-751-003

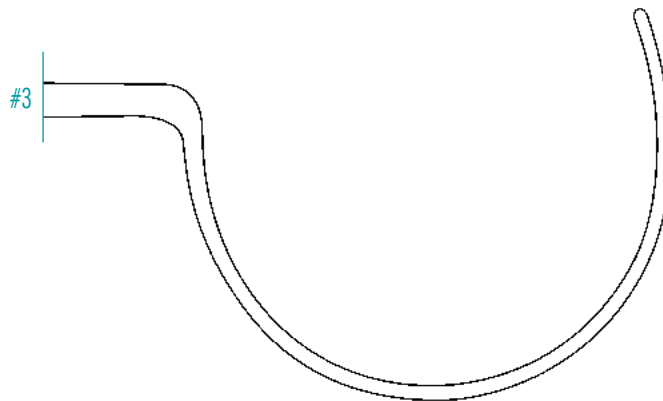
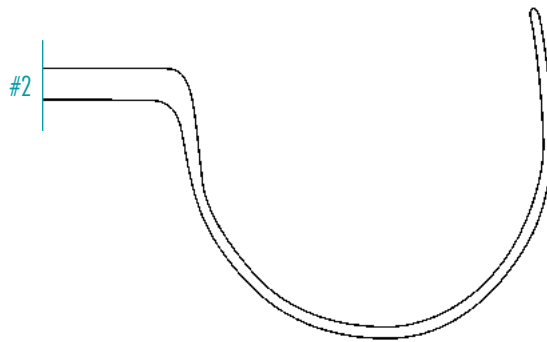
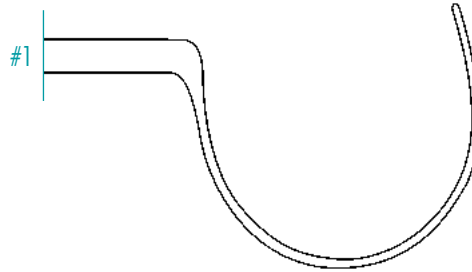

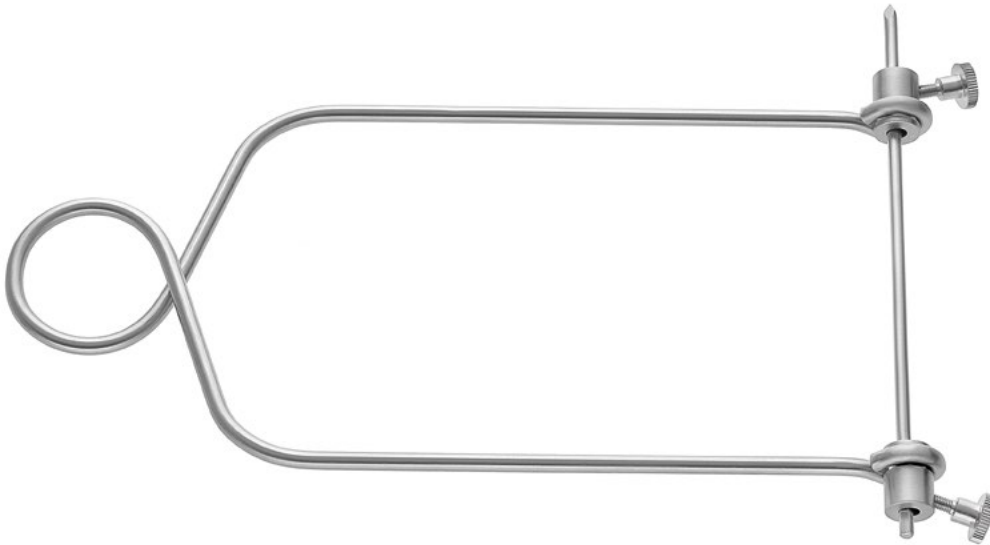

BOEHLER

Extension Bow, without pin
for 3.5 - 5.0mm Steinmann Pins
for arm

90 x 160mm	200-552-160
without pin	200-550-160

for knee and femur

110 x 210mm	200-552-210
without pin	200-550-210

for thigh and knee

150 x 210mm	200-552-250
without pin	200-550-250



KIRSCHNER

Extension Bow
Max. opening: medium

130mm, 5 ¹ / ₈ "	200-555-180
--	-------------

Max. opening: large

185mm, 7 ¹ / ₄ "	200-555-220
--	-------------

Max. opening: extra large

220mm, 8 ² / ₃ "	200-555-220
--	-------------



KIRSCHNER

Extension Bow,
complete with 3 traction hooks
180 x 100mm

small pattern	200-601-140
---------------	-------------

270 x 160mm

large pattern	200-601-220
---------------	-------------



Traction Hook for Kirschner Bows
(set of 3 hooks)

large	200-560-050
-------	-------------

small	200-560-030
-------	-------------



Wire Finger Grip

small	215-000-001
-------	-------------

medium	215-000-002
--------	-------------

large	215-000-003
-------	-------------



Bone Fragment Distractor,
2.5mm and 1.6mm pin holes,
outspread

150mm, 6"	210-974-300
-----------	-------------

210mm, 8 1/4"	210-974-310
---------------	-------------



Bone Fragment Distractor,
2.5mm and 1.6mm pin holes,
closed

150mm, 6"	210-974-301
-----------	-------------

210mm, 8 1/4"	210-974-311
---------------	-------------

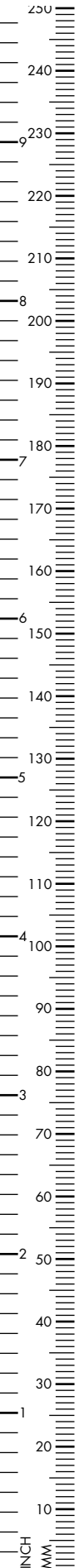



Wire Strainer for Kirschner Extension Bow
200-557-000



Traction Hook for Kirschner Bows
(set of 3 hooks)
large 200-560-050
small 200-560-030



Screw Nut Wrench
200-558-000

KIRSCHNER

Extension Bow,
complete with 3 traction hooks

B 155mm A 200mm	
for hip	200-560-200
B 120mm A 120mm	
for knee	200-560-120
B 95mm A 70mm	
for arm	200-560-070

B 155mm A 155mm	
for femur	200-560-155
B 105mm A 100mm	
for knee	200-560-105
B 60mm A 50mm	
for elbow	200-560-060

B 135mm A 130mm	
for knee	200-560-135
B 95mm A 110mm	
for heel	200-560-095

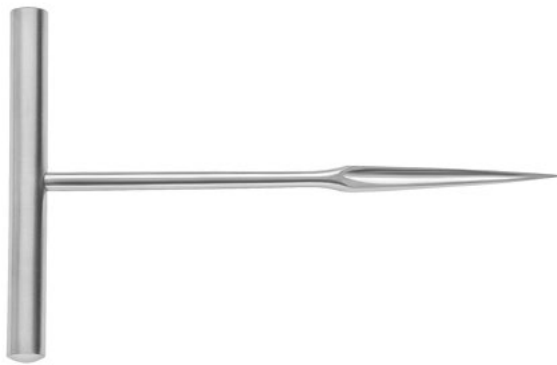
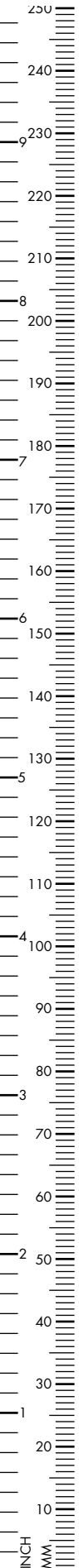

Awl with T-Handle

150mm, 6"

200-124-140

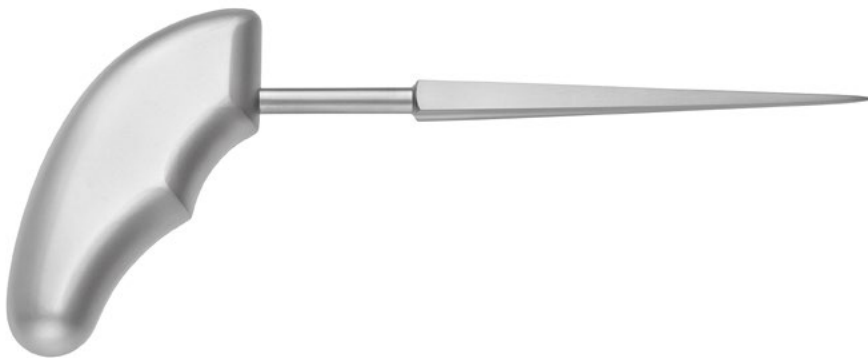

PERTHES

Reamer, square

220mm, 8^{2/3}"

200-122-210



Reamer, Ø 2.5 - 3.5mm

160mm, 6^{1/4}"

200-120-140



Percussion Awl with pyramidal tip

215mm, 8¹/₂"

259-258-148



Large Awl, 235mm, 9¹/₄", pyramidal tip

large 259-258-145

small 259-258-144



Crotched Hook Awl, 235mm, 9¹/₄"

large 259-258-146

small 259-258-147





PERTHES
Bone Drill

210mm, 8¹/₄"

200-160-210



OBWEGESER
Awl

230mm, 9"

430-500-230

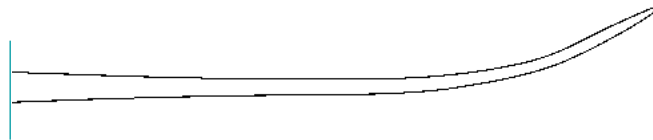

BRUNNER
Awl, malleable

230mm, 9"

200-124-230



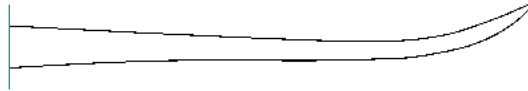

OBWEGESER

Awl

180mm, 7"

430-504-180

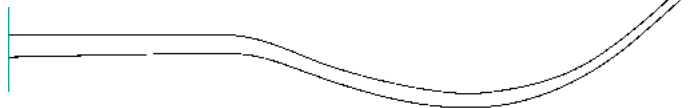

BRUNNER

Awl, curved

300mm, 11⁷/₈"

200-122-300

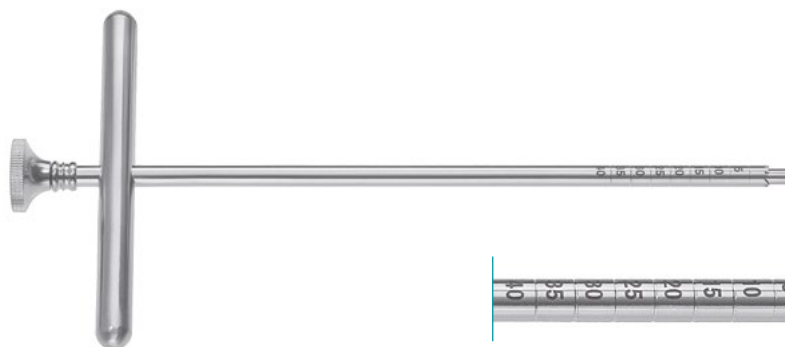

MICHELE

Trephine, 180mm, 7"

Ø 3.0mm (inside)

210-405-180

Ø 5.0mm (outside)

Ø 5.0mm (inside)

210-406-180

Ø 6.0mm (outside)

Ø 6.5mm (inside)

210-408-180

Ø 8.0mm (outside)

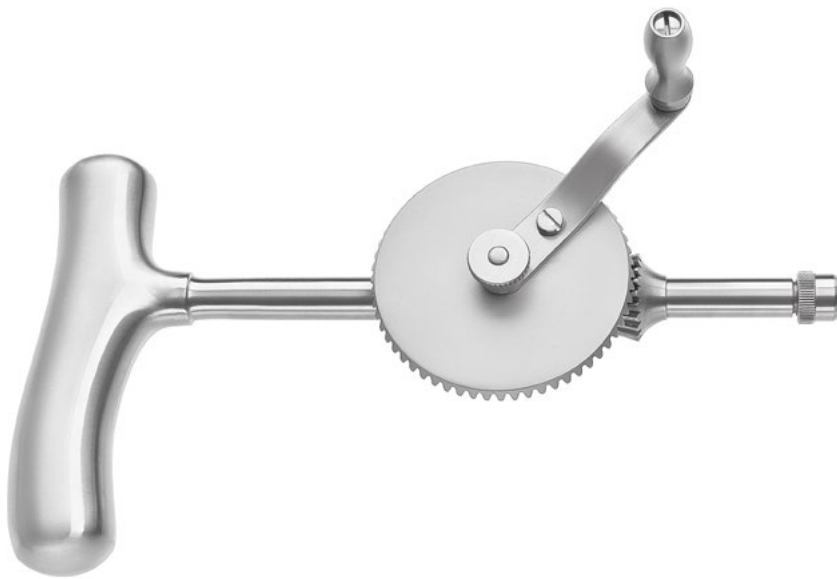

STILLE

Hand Drill, complete with 4 drills & burrs
 \varnothing 2.5 - 4.0mm

200-144-200

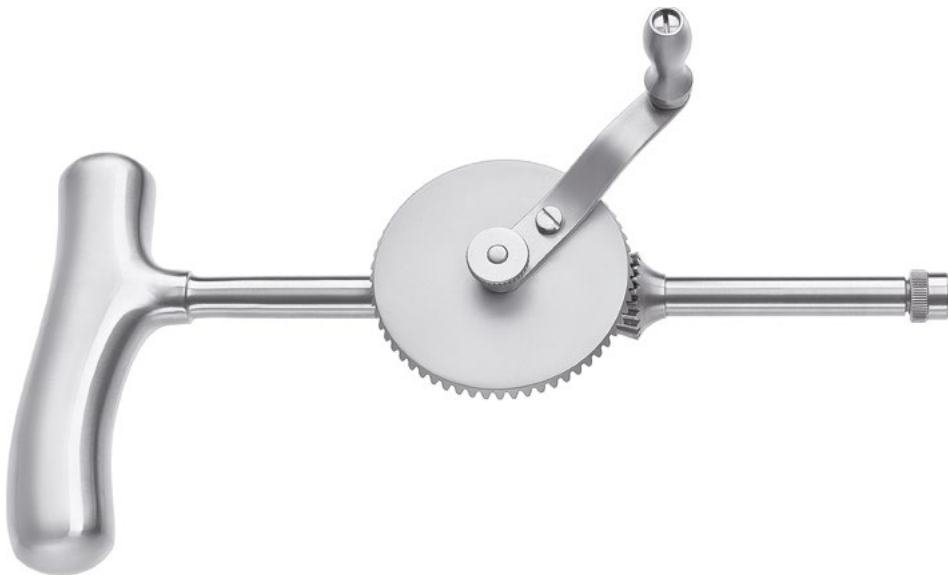

STILLE SHERMAN

Hand Drill, complete with 3 drills
 \varnothing 2.5 - 3.5mm

200-140-240

Brace only

200-140-200



A Burrs, 60mm length

\varnothing 5.0mm	200-145-050
\varnothing 8.0mm	200-145-080
\varnothing 12.0mm	200-145-120
\varnothing 16.0mm	200-145-160

B Trepphine

\varnothing 10.0mm	200-145-100
----------------------	-------------

C Twist Drills

\varnothing 1.0mm, 56mm	200-145-010
\varnothing 1.5mm, 61mm	200-145-015
\varnothing 2.0mm, 66mm	200-145-020
\varnothing 2.5mm, 81mm	200-145-025
\varnothing 3.0mm, 81mm	200-145-030
\varnothing 3.5mm, 86mm	200-145-035
\varnothing 4.0mm, 86mm	200-145-040



BUNNELL

Hand Drill, max. shanks \varnothing 4mm

160mm, 6^{1/4}" 200-154-160



BUNNELL

Key

200-154-162



RALK

Hand Drill, Jacobs chuck and key
up to \varnothing 4mm

200-153-000

large 200-153-005



HUDSON

Hand Drill (tightening screw),
complete with 4 burrs and extension (A - E)

270mm, 10²/₃" 200-152-000

Hand Drill only, with tightening screw

200-150-000



HUDSON

Hand Drill (snap lock),
complete with 4 burrs and extension (A - E)

270mm, 10²/₃" 200-152-010

Hand Drill only, with tightening screw

200-151-000



Burrs, 60mm

A Ø 9.0mm 200-152-001

B Ø 14.0mm 200-152-002

C Ø 16.0mm 200-152-003

D Ø 22.0mm 200-152-004

E Extension Piece 200-152-009



A CUSHING

Flat Drill, Hudson connection

Ø 14mm, 95mm 200-152-005

D CUSHING

Round Drill, Hudson connection

Ø 15mm, 95mm 200-152-021

B ADSON

Twist Drill, Hudson connection

Ø 2.0mm, 90mm 200-152-006

E MCKENZIE

Twist Drill, Hudson connection

Ø 13mm, 95mm 200-152-007

C D'ERRICO

Twist Drill, Hudson connection

Ø 16mm, 95mm 200-152-008

F ADSON

Burr, Hudson connection

Ø 15mm, 95mm 200-152-012

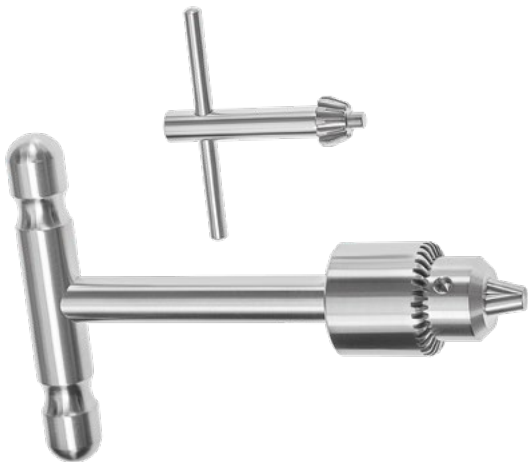

T-Handle, incl. key

Jacob Chuck

200-157-001



T-Handle Drill, 1.0 - 6.0mm, cannulated,
Ø 5.2mm

Universal Chuck

200-157-100



T-Handle, 0.5 - 7.0mm, cannulated,
Ø 5.2mm, incl. key

Roehm Chuck

200-157-200

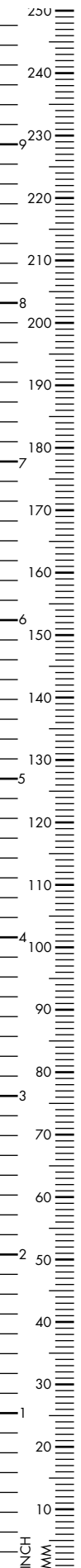

T-Handle, 0.5 - 4.0mm, cannulated,
 Ø 5.2mm, incl. key

Jacobs Chuck 200-157-210



T-Handle, 1.0 - 6.0mm, cannulated,
 Ø 6.1mm, reverse lock

Universal Chuck 200-157-250

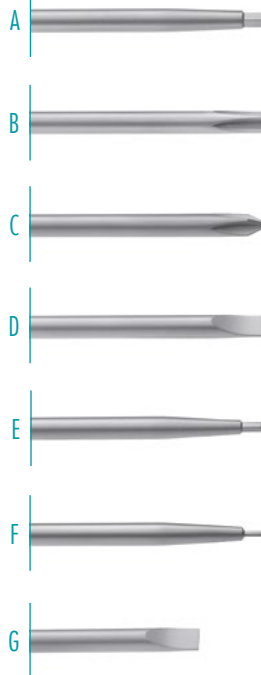

A
Screw Driver, synthetic handle,
hexagonal,
for 2.7 - 3.5 - 4.0mm screws

250mm, 9 ^{7/8} "	200-604-235
200mm, 8"	200-604-275

B
cross-slot, 6mm

250mm, 9 ^{7/8} "	200-601-250
---------------------------	-------------

C
cross-slot, 6mm, for small Philips screws

250mm, 9 ^{7/8} "	200-600-200
---------------------------	-------------

D
LANE
flat, 6mm, for 2.7 - 3.5 - 4.0mm screws

250mm, 9 ^{7/8} "	200-604-250
---------------------------	-------------

E
hexagonal, sw 2.5mm
for 2.7 - 3.5 - 4.0mm screws

250mm, 9 ^{7/8} "	200-604-200
200mm, 8"	200-604-220

F
hexagonal, sw 1.5mm
for screw 1.5 - 2.0 - 2.4

250mm, 9 ^{7/8} "	200-608-200
---------------------------	-------------

G
flat, 6mm, for 2.7 - 3.5 - 4.0mm screws

170mm, 6 ^{2/3} "	200-604-240
---------------------------	-------------



Depth Gauge

110mm, 4 ^{1/3} "	30mm screw	200-200-014
160mm, 6 ^{1/4} "	50mm screw	200-200-016
200mm, 8"	70mm screw	200-200-018
200mm, 8"	80mm screw	200-200-080
280mm, 11"	120mm screw	200-200-120



Ruler, mm and inch markings

150mm, 6"	100-418-150
200mm, 8"	100-418-200
300mm, 11 ⁷ / ₈ "	100-418-300
500mm, 19 ² / ₃ "	100-418-500



Ruler, with holes for wires and pins

150mm, 6"	100-422-150
-----------	-------------



Tape Measure, cm/inch, oil cloth

1500mm, 59"	100-425-150
-------------	-------------



CASTROVIEJO

Caliper, measuring range 0 - 20mm
locking screw

80mm, 3¹/₈" 400-583-007

Caliper, measuring range 0 - 40mm

180mm, 7" 400-583-008



CARROLL

Finger Goniometer

140mm, 5¹/₂" 100-150-000



TOWNLEY

Caliper, 0 - 100mm

100mm, 4" 100-152-000

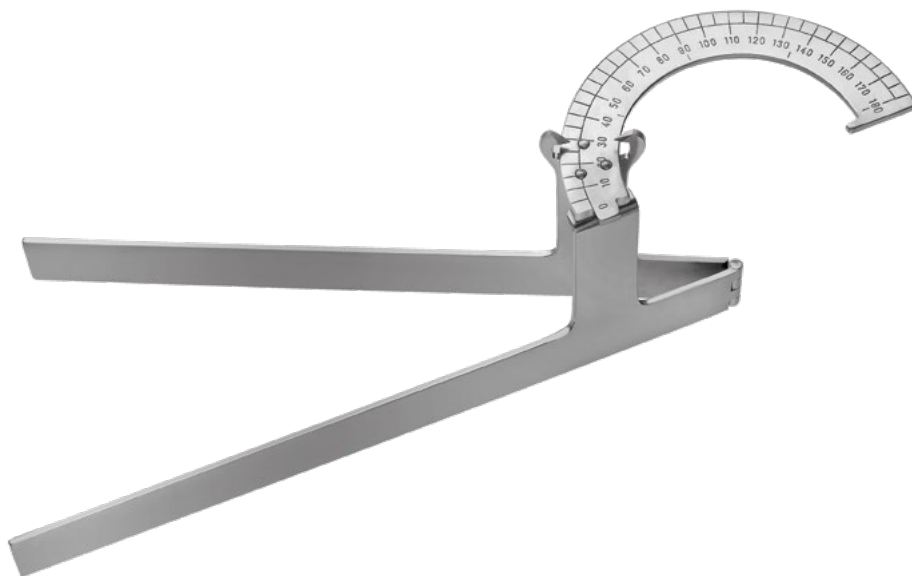

MOELTGEN
Goniometer

100-412-000



Bone Caliper, angled, blunt, 140mm opening
180mm, 7"

200-200-170



Bone Caliper, straight, pointed
115mm opening

200-200-200

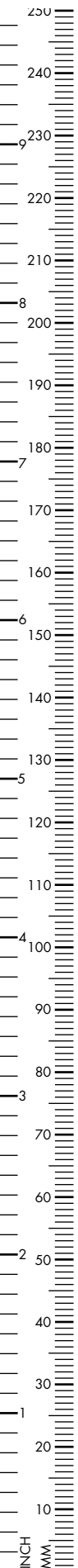

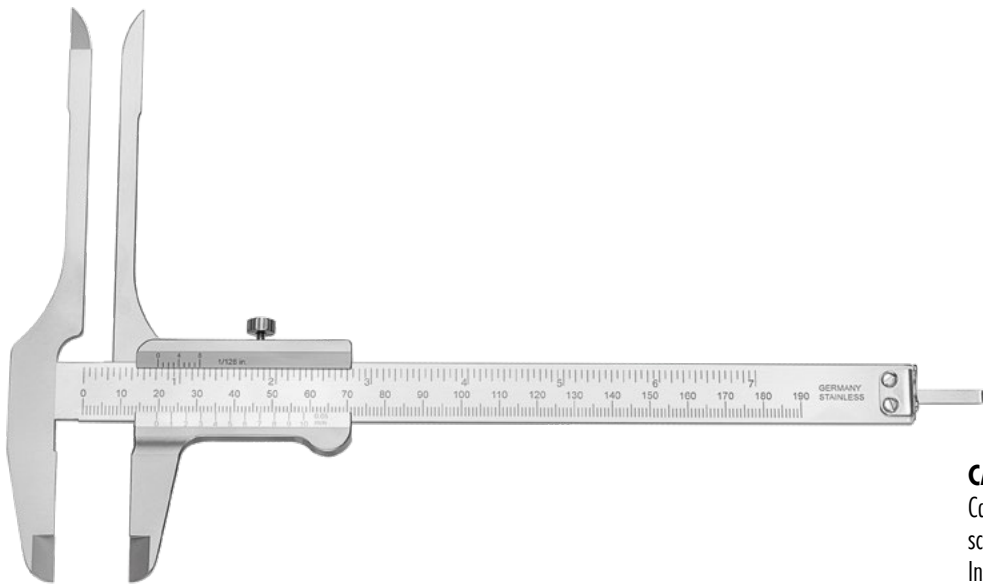

CASPAR

Caliper for measuring bone craft

scale: mm, max. 180mm

Inside and outside measuring, faces & depth

259-185-885



Neuro-Caliper, 150mm range

211-550-235

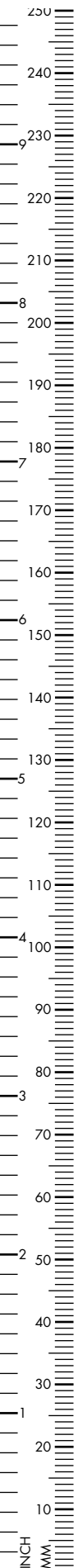

COLLIN

Amputating Knife

130mm, 5 ¹ / ₈ "	110-014-013
160mm, 6 ¹ / ₄ "	110-014-016
190mm, 7 ¹ / ₂ "	110-014-019
220mm, 8 ² / ₃ "	110-014-022
280mm, 11"	110-014-028



CATLIN

Amputating Knife, double cutting

160mm, 6 ¹ / ₄ "	110-018-016
190mm, 7 ¹ / ₂ "	110-018-019
220mm, 8 ² / ₃ "	110-018-022



LANGENBECK

Resection Knife, 55mm blade

180mm, 7"	110-028-055
-----------	-------------

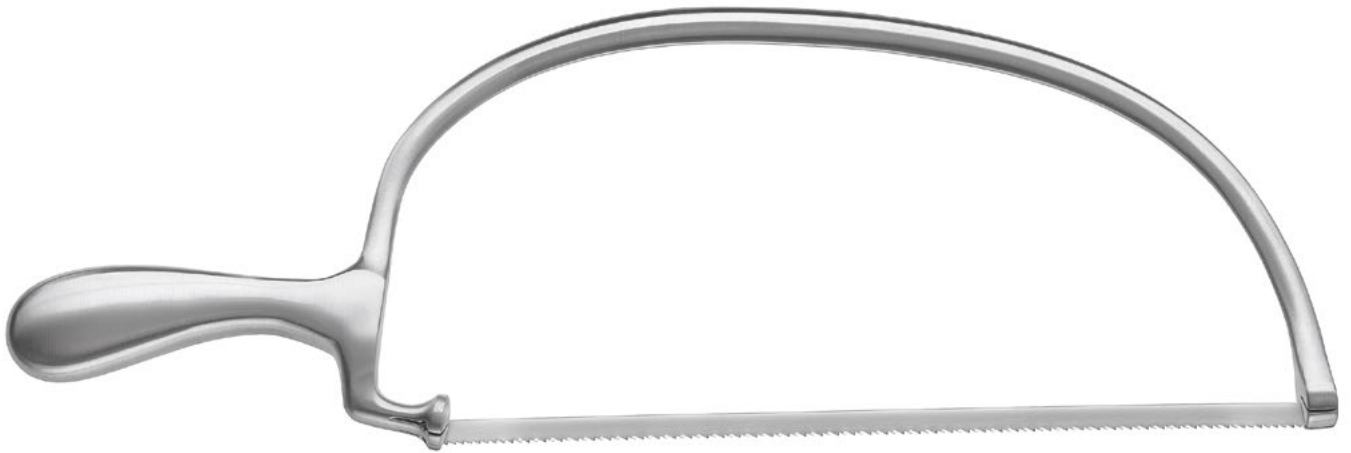

HELFERICH BIER

Amputation Saw

390mm, 15 ¹ / ₂ "	200-103-390
---	-------------

Spare Blade

4mm	200-103-394
-----	-------------

6mm	200-103-396
-----	-------------

8mm	200-103-398
-----	-------------



CHARRIÈRE

Amputation Saw

270mm, 10 ² / ₃ "	200-112-270
---	-------------

300mm, 11 ⁷ / ₈ "	200-112-300
---	-------------



LANGENBECK

Metacarpal Saw

230mm, 9"	200-110-230
-----------	-------------



SATTERLEE
Amputation Saw

310mm, 12 ¹ / ₄ "	200-114-310
---	-------------



CHARRIÈRE
Amputation Saw

350mm, 14"	200-101-350
------------	-------------



Spare Blade

12mm	200-101-012
------	-------------

15mm	200-101-015
------	-------------

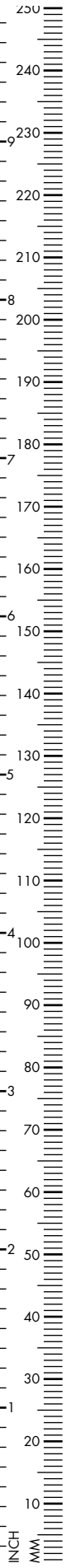

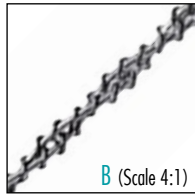
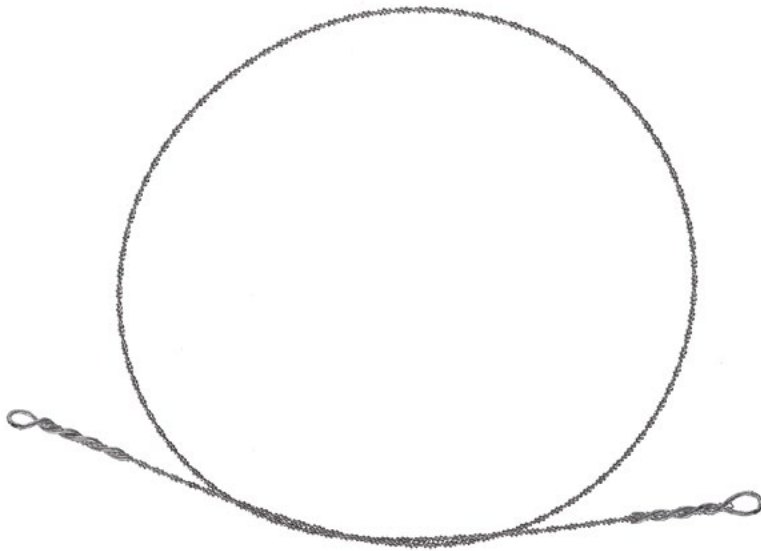

OLIVECRONA

A Wire Saw, \varnothing 1.2mm

250mm, 9 ⁷ / ₈ "	290-100-250
300mm, 11 ⁷ / ₈ "	290-100-300
400mm, 16"	290-100-400
500mm, 20"	290-100-500
600mm, 23 ³ / ₄ "	290-100-600
700mm, 28"	290-100-700
760mm, 30"	290-100-760

GIGLI

B Wire Saw, \varnothing 1.4mm

300mm, 11 ⁷ / ₈ "	290-101-300
400mm, 16"	290-101-400
500mm, 20"	290-101-500
600mm, 23 ³ / ₄ "	290-101-600
700mm, 28"	290-101-700



GIGLI

Handle for Wire Saw, 2 pcs.

290-102-000



GIGLI

Handle, loop design, for Wire Saws

290-103-000



DEMARTEL

Saw Conductor

305mm, 12"	290-118-305
330mm, 13"	290-118-330



BAILEY

Saw Conductor, 305mm, 12"

curved	290-118-300
straight	290-118-301



PERCY
Retractor for amputation,
removable handles

200-100-000



SWEET
Amputation Shield

200-100-002

