

# GENITO- URINARY



Retractors / Spatula  
Forceps  
Vasectomy  
Penis Clamps  
Catheters  
Bougies  
Urethrotomes



**YOUNG**

Prostatic Retractor

210mm, 8<sup>1</sup>/<sub>4</sub>"

320-204-210



**YOUNG**

Prostatic Retractor

220mm, 8<sup>2</sup>/<sub>3</sub>"

320-205-220



**YOUNG**

Prostatic Retractor

210mm, 8<sup>1</sup>/<sub>4</sub>"

320-206-210

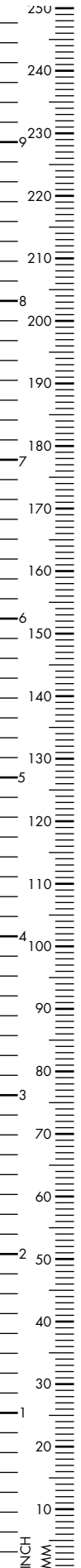

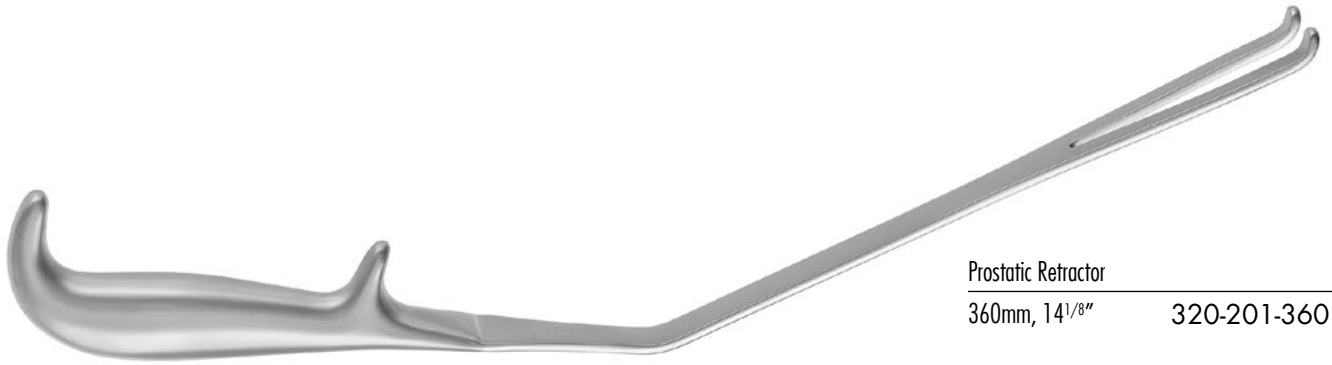

Prostatic Retractor

360mm, 14<sup>1</sup>/<sub>8</sub>"

320-201-360



**LEGUEU**

Bladder Spatula

260mm, 10<sup>1</sup>/<sub>4</sub>"

320-170-260



**KOCHER**

Bladder Spatula

235mm, 9<sup>1</sup>/<sub>4</sub>"

320-175-235

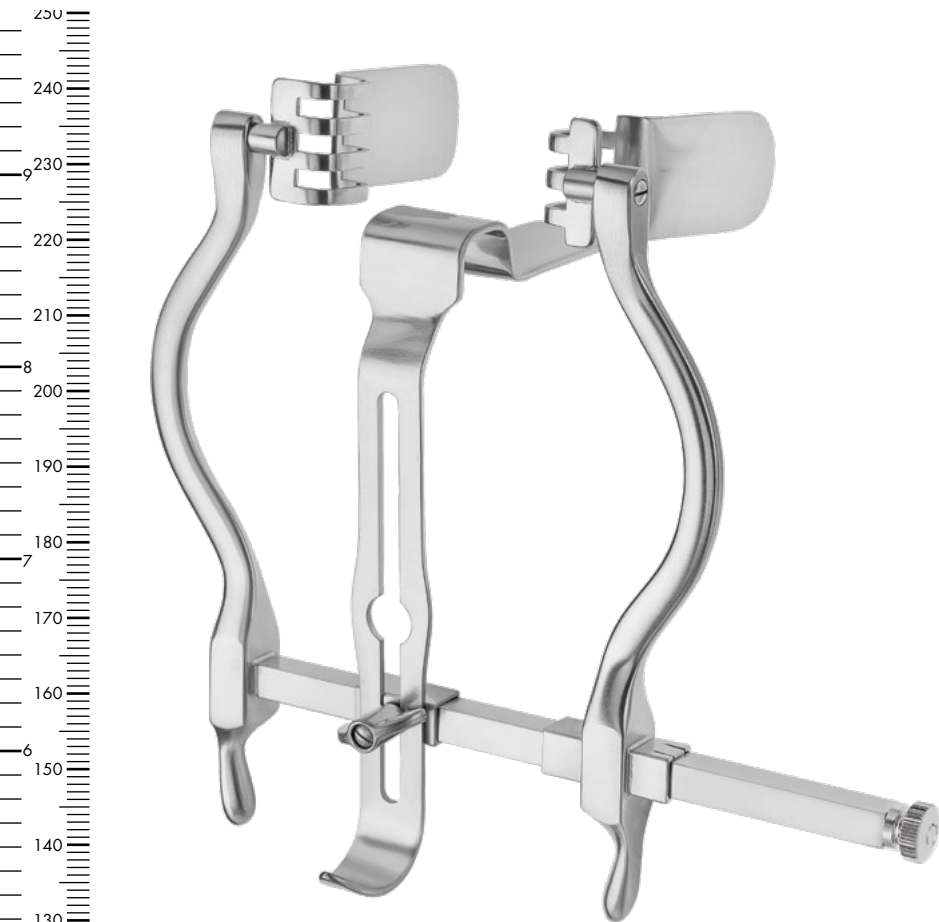

### MASSON

Bladder Retractor  
blade 73 x 28mm

110mm opening	320-195-000
---------------	-------------

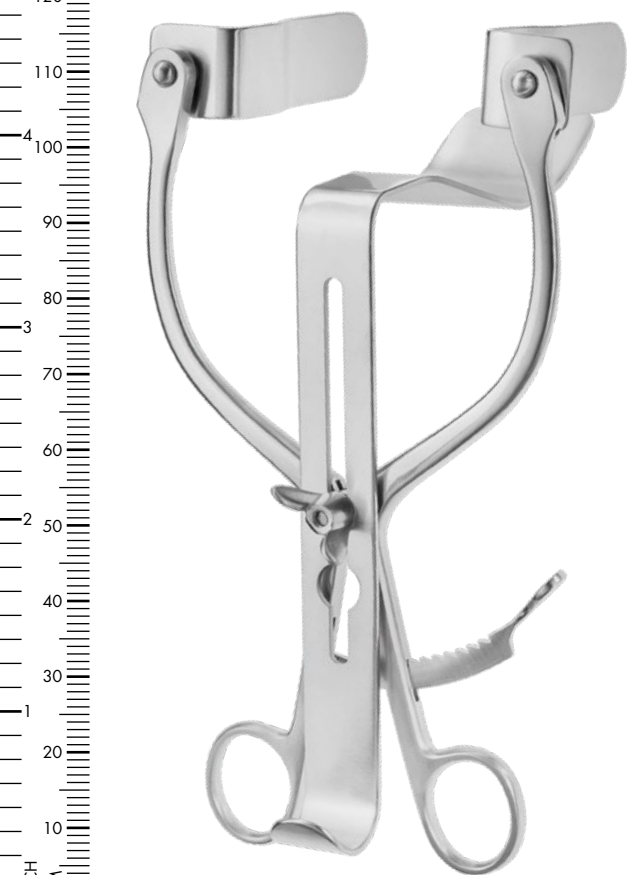

### MILLIN

Bladder Retractor, complete

	320-185-000
--	-------------

Central Valve

105 x 45mm	320-185-004
------------	-------------

Lateral Blades

82 x 25mm	320-185-003
-----------	-------------

87 x 25mm	320-185-002
-----------	-------------

Retractor only

	320-185-001
--	-------------

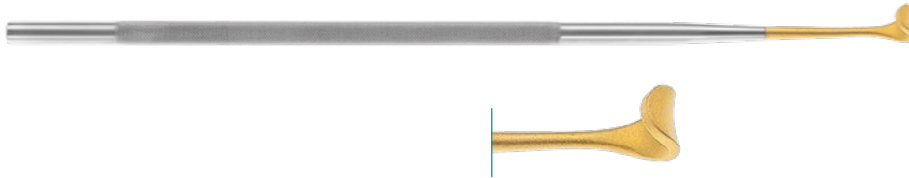

### GIL VERNET

Retractor, malleable, 240mm, 9<sup>1/2</sup>"

8mm	170-236-008
11mm	170-236-011
17mm	170-236-017
20mm	170-236-020
23mm	170-236-023

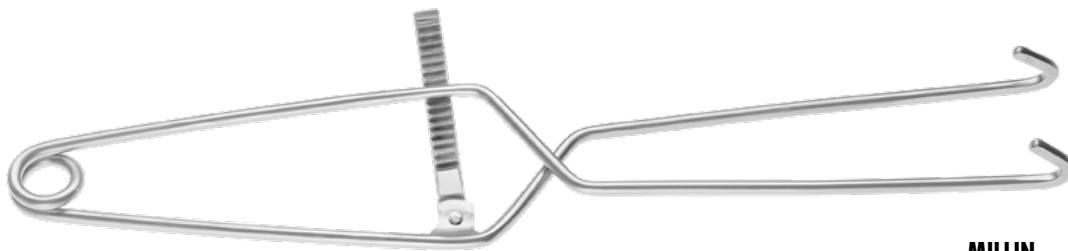

### MILLIN

Bladder Neck Spreader

285mm, 11 <sup>1/4</sup> "	320-165-285
----------------------------	-------------

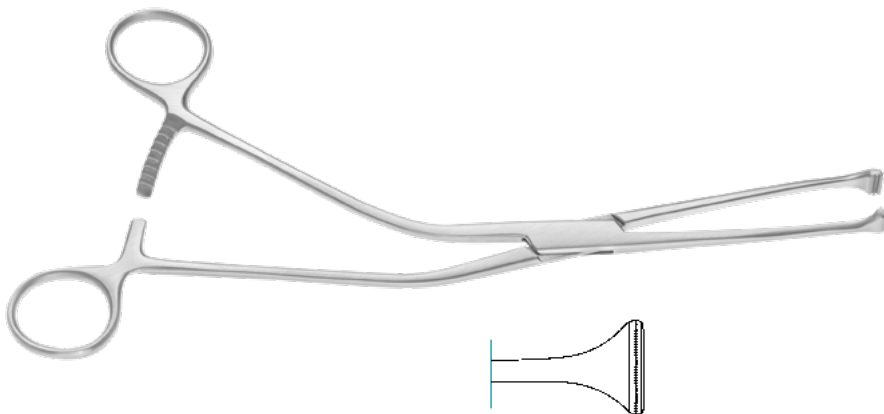

### MILLIN

Prostatic Grasping Forceps

230mm, 9"	320-150-230
-----------	-------------

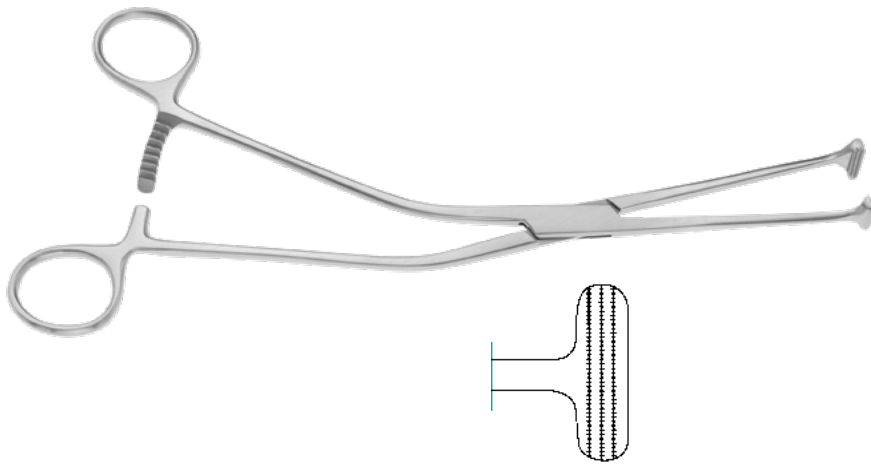

**MILLIN**

Atraumatic Grasping Forceps  
for the capsule

230mm, 9"

320-151-230

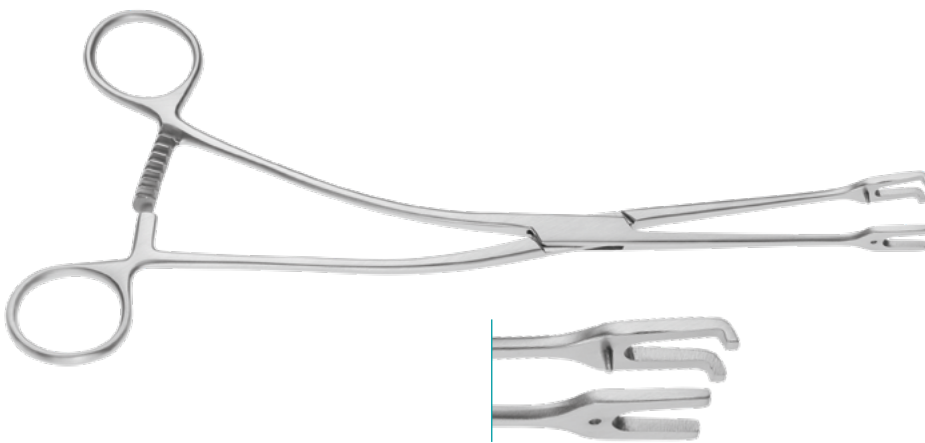

**MILLIN**

Ligature Carrying Forceps

245mm, 9<sup>2</sup>/<sub>3</sub>"

320-151-245

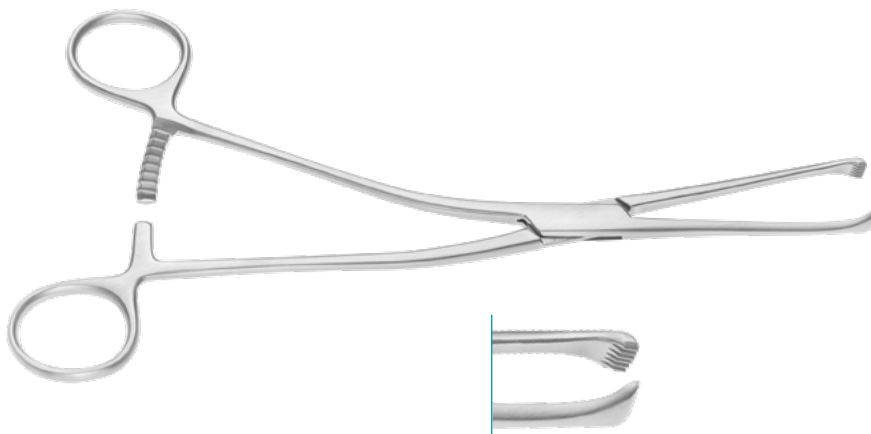

**MILLIN**

Grasping Forceps for the anterior lobe

230mm, 9"

320-152-230

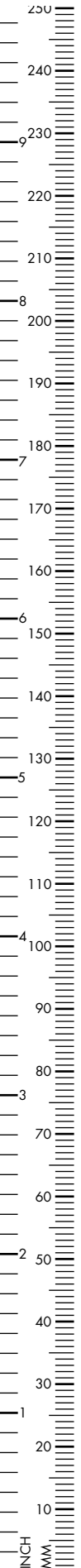

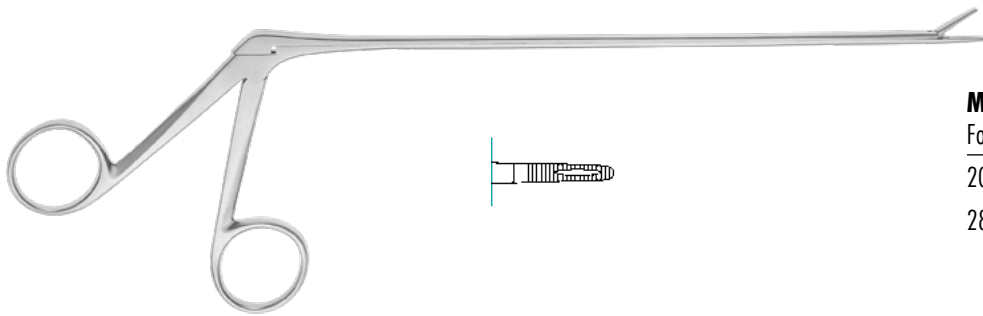

### MATHIEU

Foreign Body Forceps

200mm, 8"	320-350-190
280mm, 11"	320-350-280

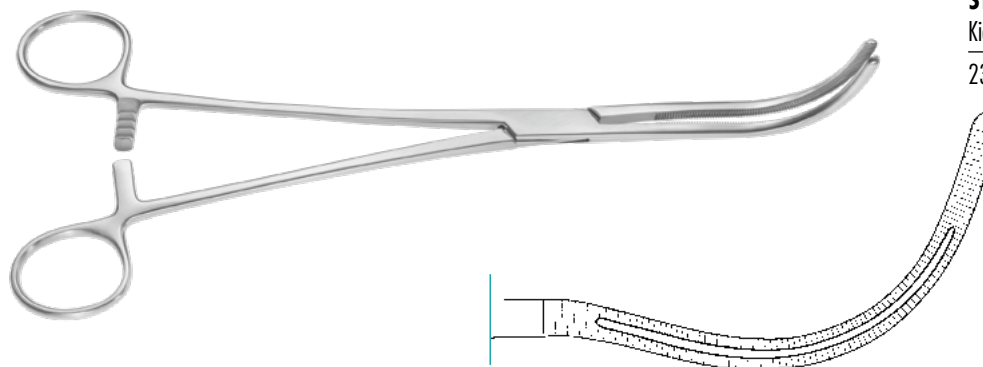

### STILLE

Kidney Pedicle Clamp

230mm, 9"	140-602-230
-----------	-------------

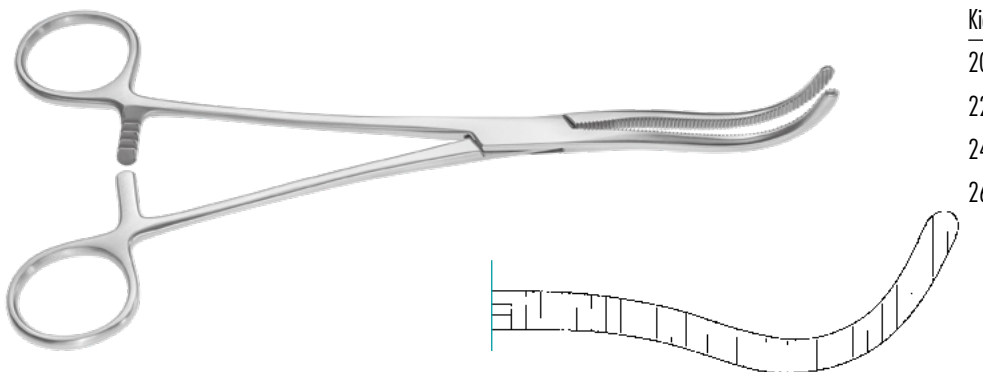

### GUYON

Kidney Pedicle Clamp, curved

200mm, 8"	140-600-200
220mm, 8 <sup>2</sup> / <sub>3</sub> "	140-600-220
240mm, 9 <sup>1</sup> / <sub>2</sub> "	140-600-240
265mm, 10 <sup>1</sup> / <sub>2</sub> "	140-600-265

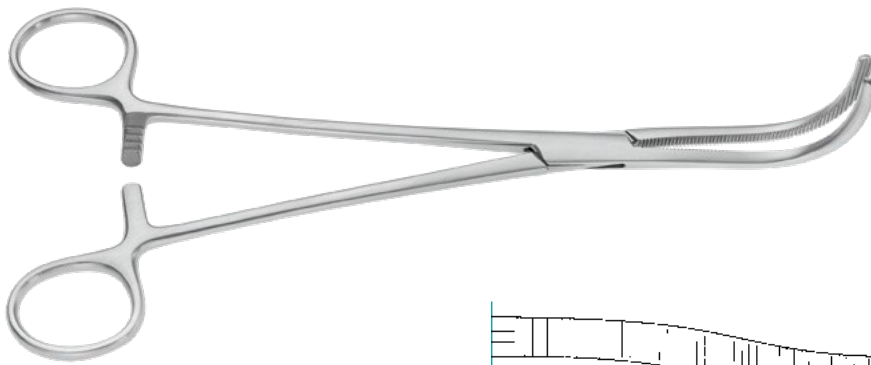
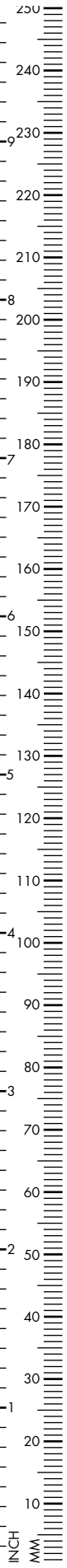

**GUYON**

Kidney Pedicle Clamp

230mm, 9"

140-603-230

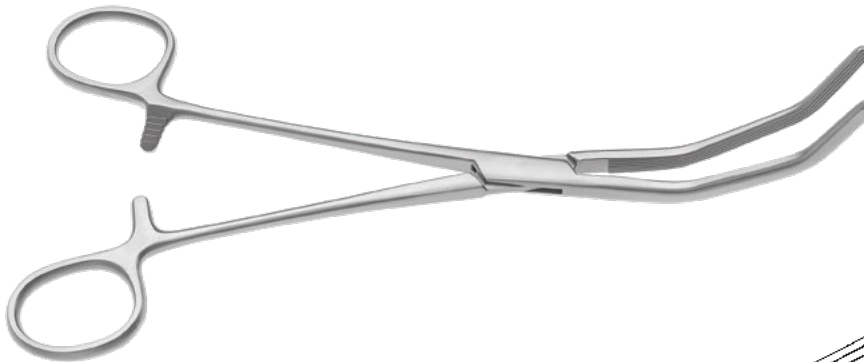
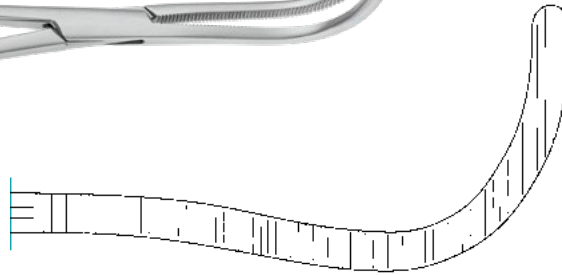

**HERRICK**

Pedicle Clamp, angled, longitudinal serrated

230mm, 9"

140-604-230

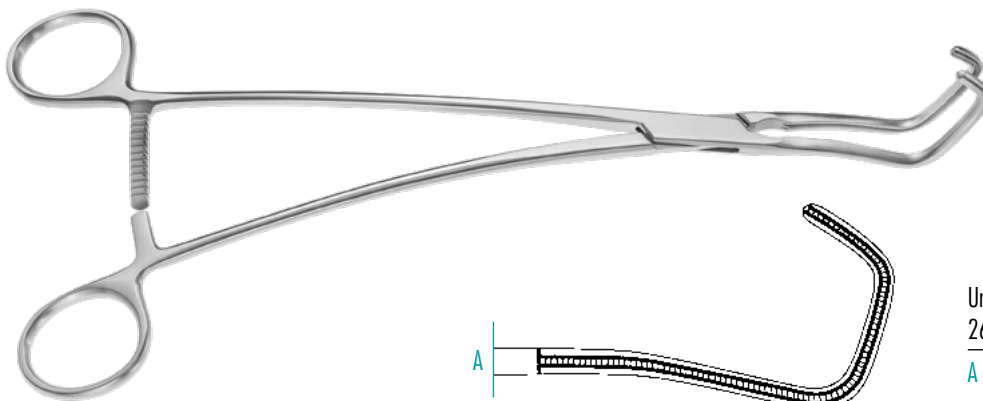
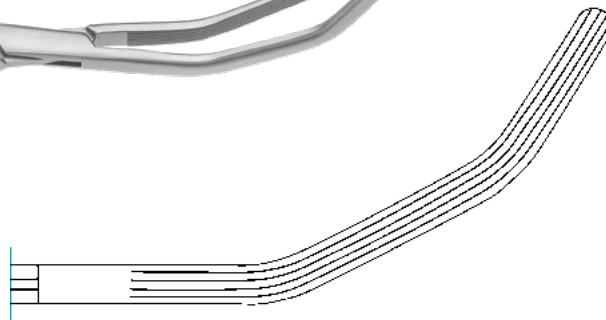

Uro-Tangential Kidney Pedicle Clamp, atraumatic  
260mm, 10<sup>1/4</sup>"

A Fig. 1

140-500-001

B Fig. 2

140-500-002

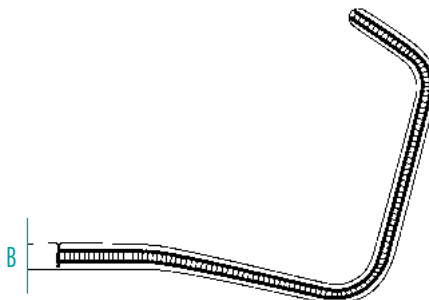
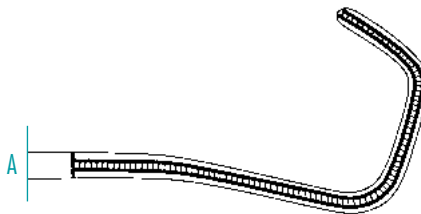



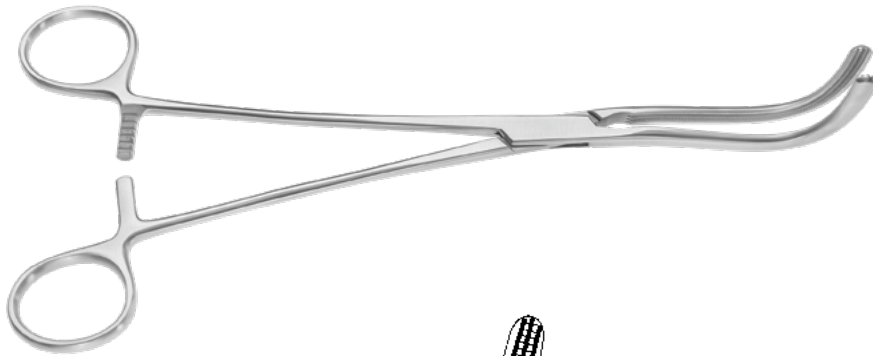

### GUYON

Kidney Pedicle Clamp, atraumatic

260mm, 10<sup>1</sup>/<sub>4</sub>"

A 230mm, 9" 140-498-230

B 240mm, 9<sup>1</sup>/<sub>2</sub>" 140-498-240

C 235mm, 9<sup>1</sup>/<sub>4</sub>" 140-498-235

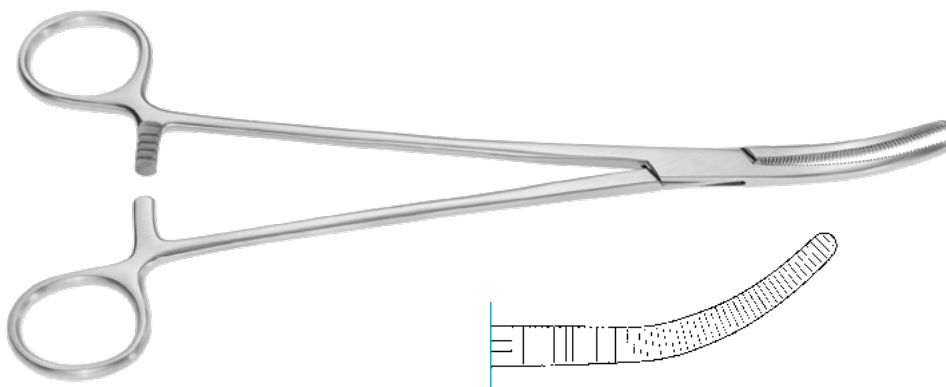
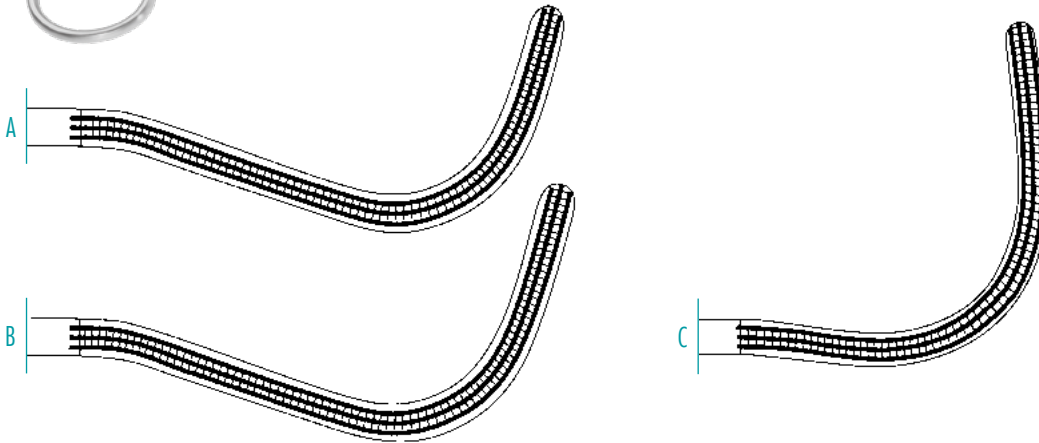

### WERTHEIM

Hysterectomy Forceps, serrated, curved

250mm, 9<sup>7</sup>/<sub>8</sub>"

140-697-250

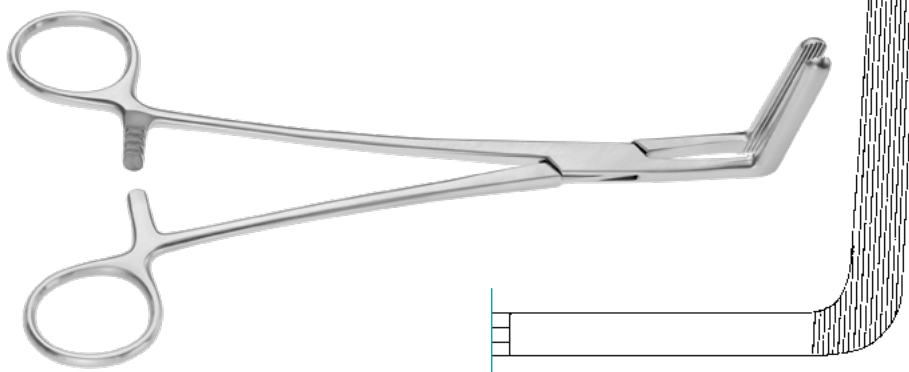
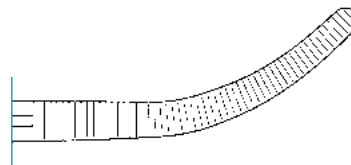

### WERTHEIM CULLEN

Hysterectomy Forceps, 90° angled

215mm, 8<sup>1</sup>/<sub>2</sub>"

140-641-215

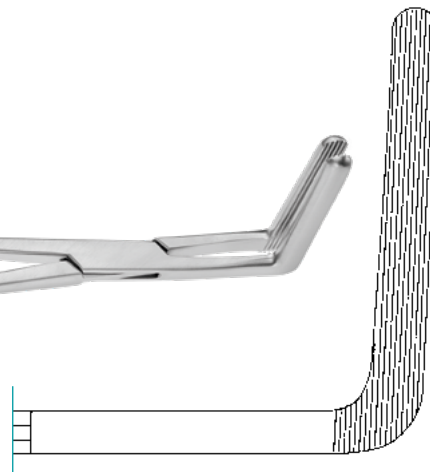

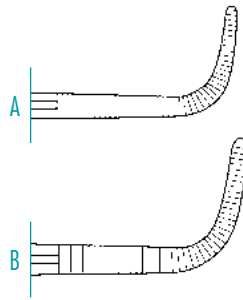
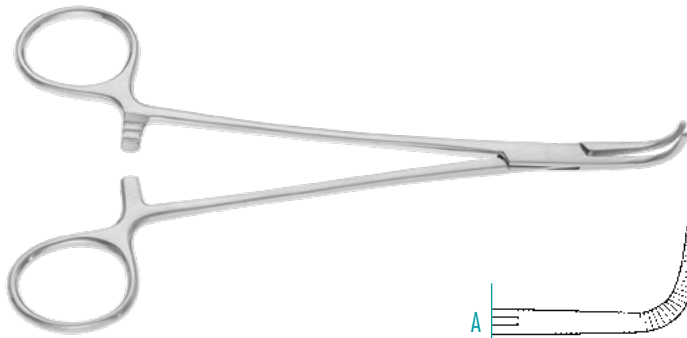
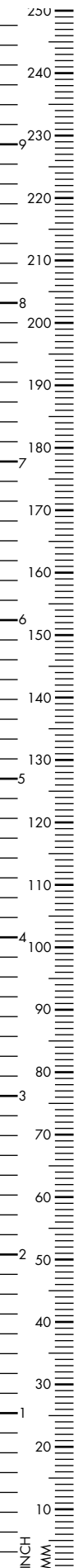

### MEEKER

Kidney Pedicle Clamp

Fig. 1

A 180mm, 7"

140-619-180

Fig. 2

B 280mm, 11"

140-619-275

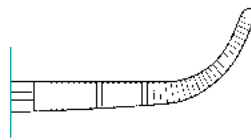
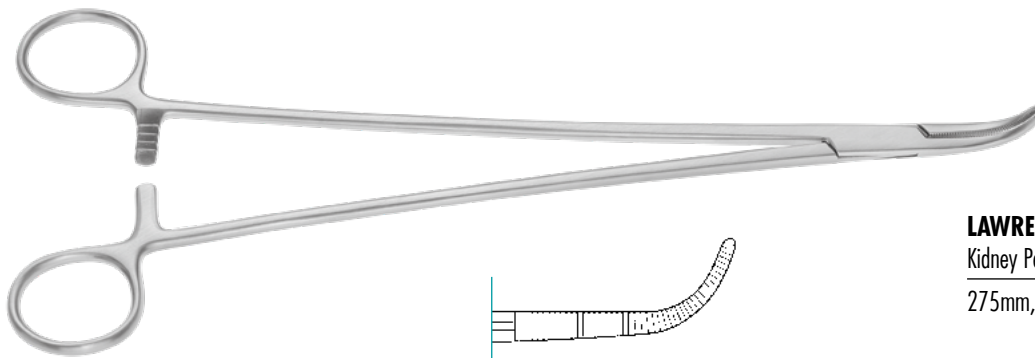

### LAWRENCE

Kidney Pedicle Clamp

275mm, 10<sup>7</sup>/<sub>8</sub>"

140-617-275

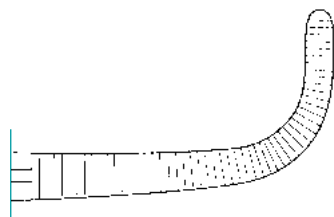
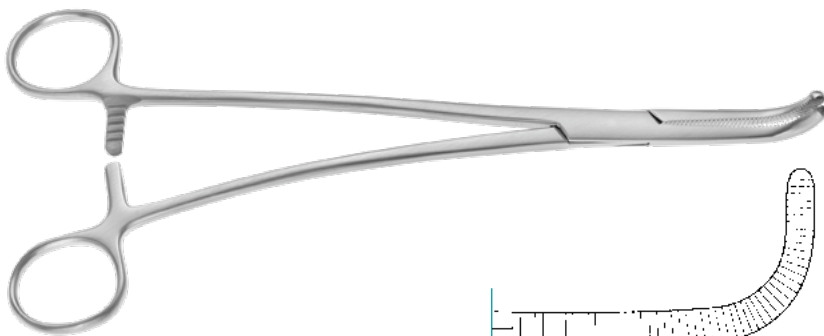

### GRAY

Gall Duct Clamp, s-curved

220mm, 8<sup>2</sup>/<sub>3</sub>"

140-607-220

230mm, 9"

140-607-230



No-Scalpel Vasectomy Forceps, sharp, pointed,  
smooth curved jaw

125mm, 5" 140-353-125

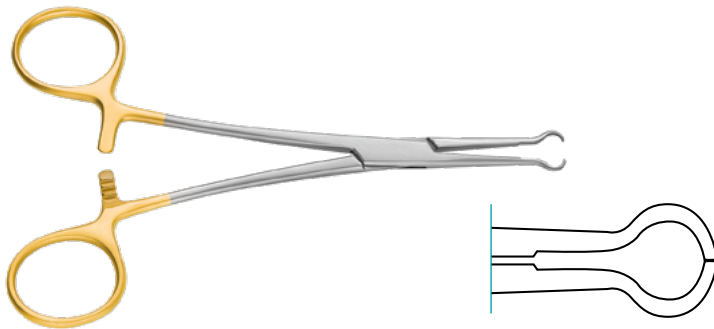

No-Scalpel Vasectomy Fixator Ring Forceps,  
blunt tip, Ø4.7mm ring size

140mm, 5 1/2" 140-352-140

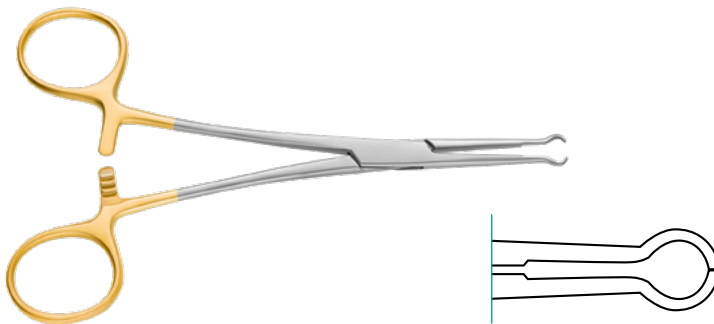

No-Scalpel Vasectomy Mini Fixator  
Ring Forceps,  
blunt tip, Ø3mm ring size

140mm, 5 1/2" 140-353-140



A

B



C

D

A Microspike Approximator Clamp  
for Vasovasostomy

Ø2mm 270-150-001

B for Vasovasostomy

Ø4mm / Ø2mm 270-150-002

C for Vasovasostomy, end-to-end,  
for Vasoepididymostomy

Ø6mm / Ø2mm 270-150-003

D for Vasovasostomy, end-to-side,  
for Vasoepididymostomy

Ø6mm / Ø2mm 270-150-200

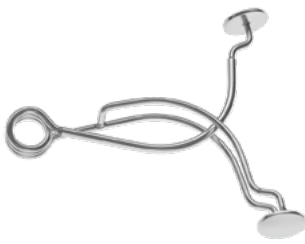

### STOCKMANN

Meatus Clamp

80mm, 3<sup>1</sup>/<sub>4</sub>"

320-998-000



### STRAUSS

Penis Seizing Forceps

130mm, 5<sup>1</sup>/<sub>8</sub>"

320-999-000



### FOLEY

Catheter Spanner/Introducer

455mm, 18"

320-603-455



### GUYON

Catheter, curved

390mm, 15<sup>1</sup>/<sub>2</sub>"

253-310-390

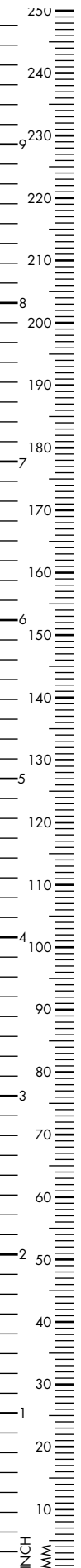



### Metal Catheter for women

8 Charr.	320-721-080
10 Charr.	320-721-100
11 Charr.	320-721-110
12 Charr.	320-721-120
14 Charr.	320-721-140
16 Charr.	320-721-160
18 Charr.	320-721-180
20 Charr.	320-721-200
22 Charr.	320-721-220
24 Charr.	320-721-240

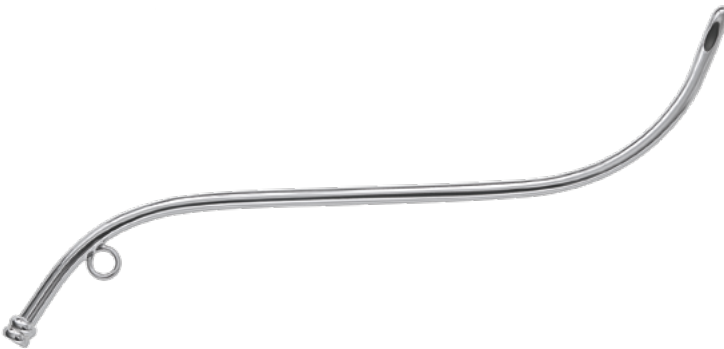

### Rotunda Catheter, s-curved

8 Charr.	320-723-080
10 Charr.	320-723-100
12 Charr.	320-723-120
14 Charr.	320-723-140
16 Charr.	320-723-160
18 Charr.	320-723-180
20 Charr.	320-723-200
22 Charr.	320-723-220
24 Charr.	320-723-240



### Metal Catheter for men working length: 290mm, 11<sup>1</sup>/<sub>2</sub>"

8 Charr.	320-720-080
10 Charr.	320-720-100
12 Charr.	320-720-120
14 Charr.	320-720-140
16 Charr.	320-720-160
18 Charr.	320-720-180
20 Charr.	320-720-200
22 Charr.	320-720-220
24 Charr.	320-720-240

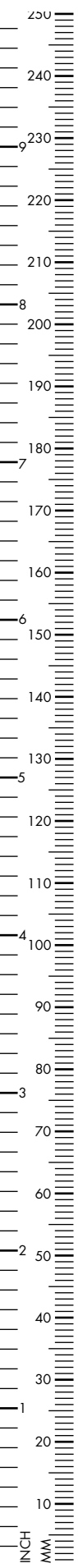

### DITTEL

Bougie, straight

8 Charr.	253-320-225	22 Charr.	253-329-225
9 Charr.	253-321-225	24 Charr.	253-330-225
10 Charr.	253-322-225	25 Charr.	253-331-225
11 Charr.	253-323-225	26 Charr.	253-332-225
12 Charr.	253-324-225	27 Charr.	253-333-225
14 Charr.	253-325-225	28 Charr.	253-334-225
16 Charr.	253-326-225	30 Charr.	253-335-225
18 Charr.	253-327-225	32 Charr.	253-336-225
20 Charr.	253-328-225	34 Charr.	253-337-225



### GUYON

Bougie, strongly curved

8 Charr.	253-340-335
9 Charr.	253-341-335
10 Charr.	253-342-335
11 Charr.	253-343-335
12 Charr.	253-344-335
14 Charr.	253-345-335
16 Charr.	253-346-335
18 Charr.	253-347-335
20 Charr.	253-348-335
22 Charr.	253-349-335
24 Charr.	253-350-335
25 Charr.	253-351-335
26 Charr.	253-352-335
27 Charr.	253-353-335
28 Charr.	253-354-335
30 Charr.	253-355-335
32 Charr.	253-356-335
34 Charr.	253-357-335



### VAN BUREN

Bougie, curved

10 Charr.	253-650-010
12 Charr.	253-650-012
14 Charr.	253-650-014
16 Charr.	253-650-016
18 Charr.	253-650-018
20 Charr.	253-650-020
22 Charr.	253-650-022
24 Charr.	253-650-024
26 Charr.	253-650-026
28 Charr.	253-650-028
30 Charr.	253-650-030
32 Charr.	253-650-032
34 Charr.	253-650-034
36 Charr.	253-650-036



### DITTEL

Bougie, slightly curved

8 Charr.	253-320-335	22 Charr.	253-329-335
9 Charr.	253-321-335	24 Charr.	253-330-335
10 Charr.	253-322-335	25 Charr.	253-331-335
11 Charr.	253-323-335	26 Charr.	253-332-335
12 Charr.	253-324-335	27 Charr.	253-333-335
14 Charr.	253-325-335	28 Charr.	253-334-335
16 Charr.	253-326-335	30 Charr.	253-335-335
18 Charr.	253-327-335	32 Charr.	253-336-335
20 Charr.	253-328-335	34 Charr.	253-337-335



A

### OTIS

A Dilation Urethrotome, complete with 3 atraumatic tip and 2 knives, wooden case

253-500-100

wooden case only 253-500-103

B Urethrotome only

253-500-101

C Knife only

253-500-102

D Set with 3 atraumatic tip only

253-500-108



B



C



D

