

# OBSTETRICS & GYNECOLOGY

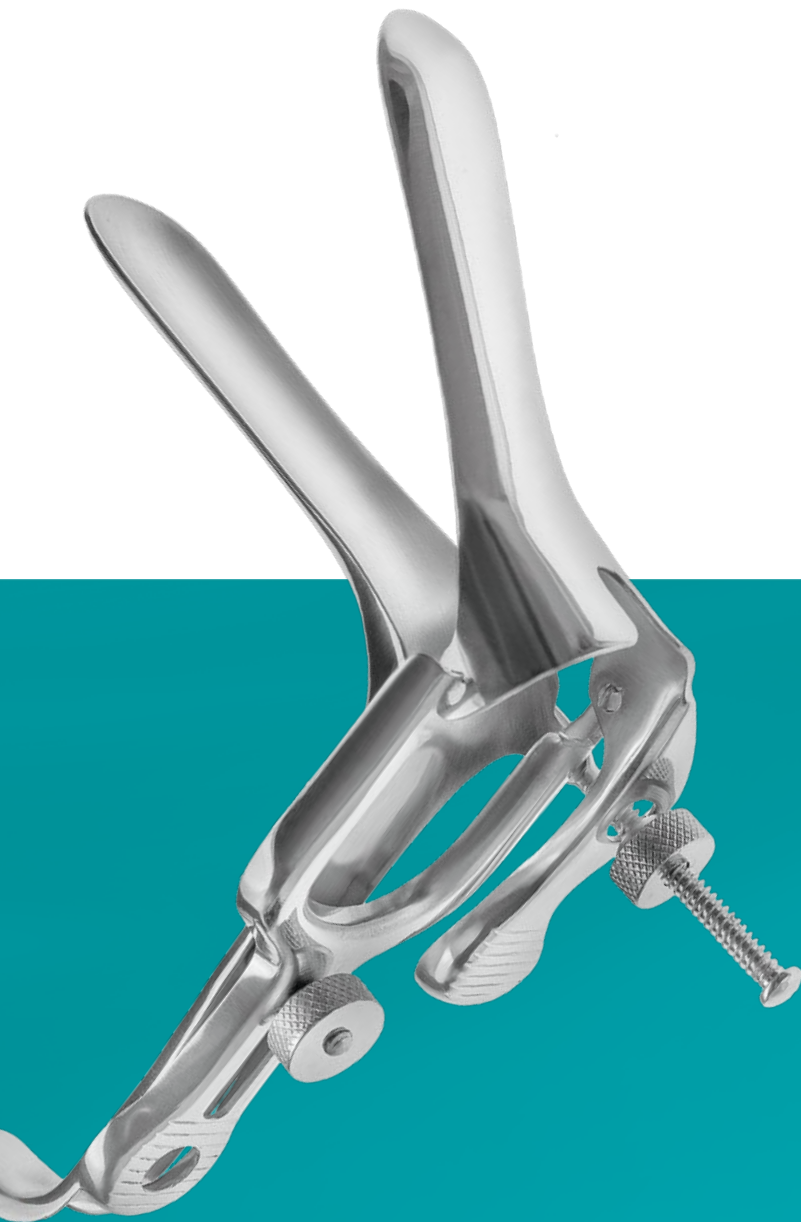

Scissors  
Clamps and Forceps  
Hysterectomy Forceps  
Uterus Forceps  
Tenaculum Forceps  
Uterine / Placenta Forceps  
Obstetrical Forceps  
Myoma Screws  
Curettes  
Amniotome  
Uterine Scoops/Curettes  
Biopsy Forceps  
Probes/Dilators  
Retractors/Specula  
Pelvimeter

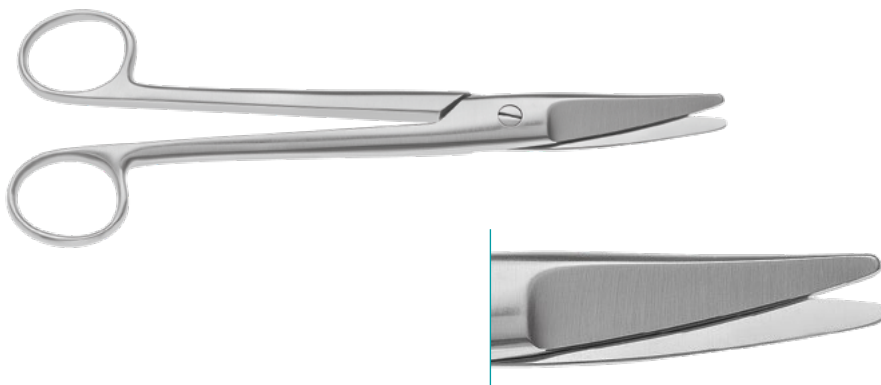

### MAYO NOBLE

Scissors, curved

170mm, 6<sup>2</sup>/<sub>3</sub>"

120-049-170

190mm, 7<sup>1</sup>/<sub>2</sub>"

120-049-190

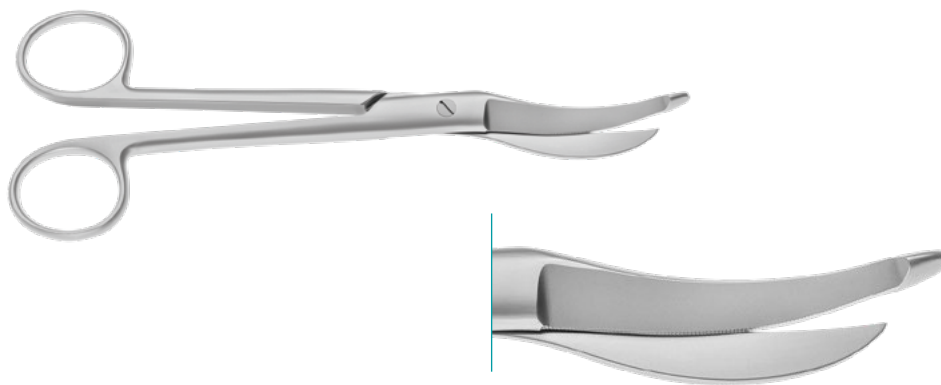

### WALDMANN

Episiotomy Scissors, curved, serrated

180mm, 7"

120-231-180

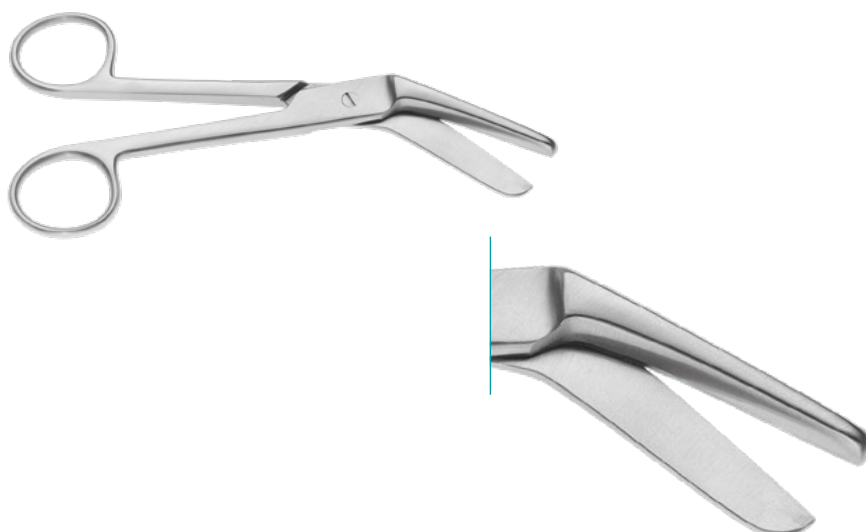

### BRAUN STADLER

Episiotomy Scissors

145mm, 5<sup>3</sup>/<sub>4</sub>"

120-225-145

200mm, 8"

120-225-200

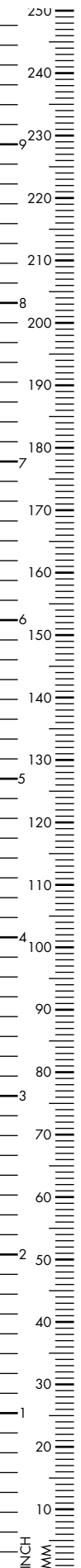

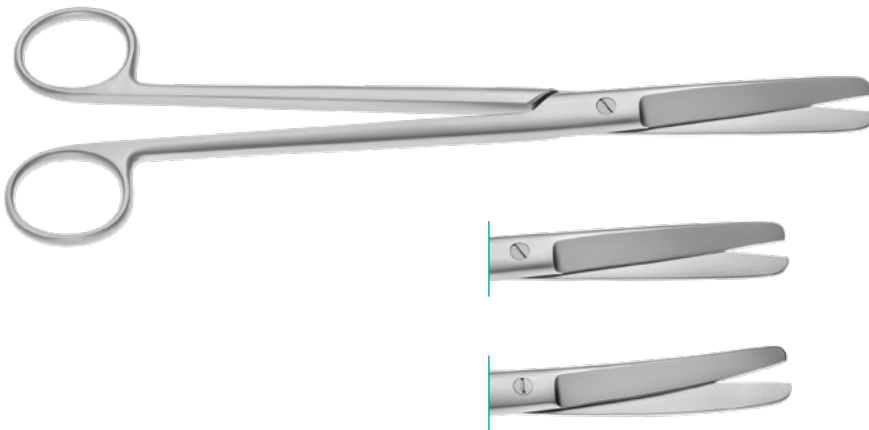

### SIMS

Gynecological Scissors, straight, blunt/blunt

200mm, 8" 120-062-200

230mm, 9" 120-062-230

curved

200mm, 8" 120-063-200

230mm, 9" 120-063-230

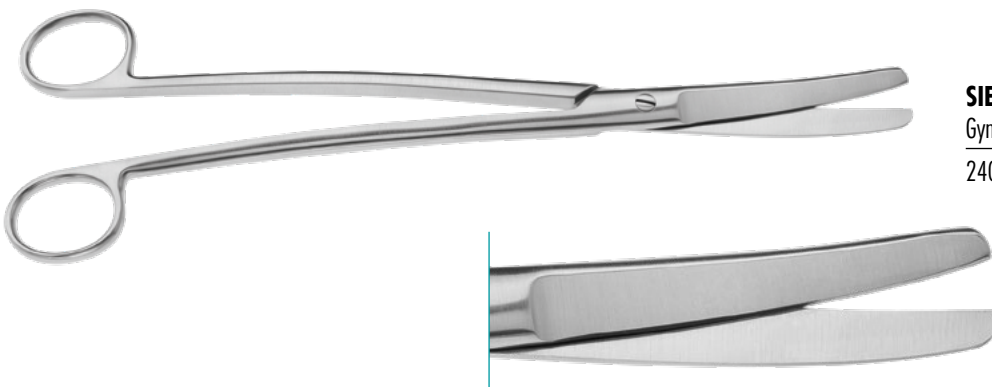

### SIEBOLD

Gynecological Scissors, s-curved

240mm, 9<sup>1/2</sup>" 120-061-240

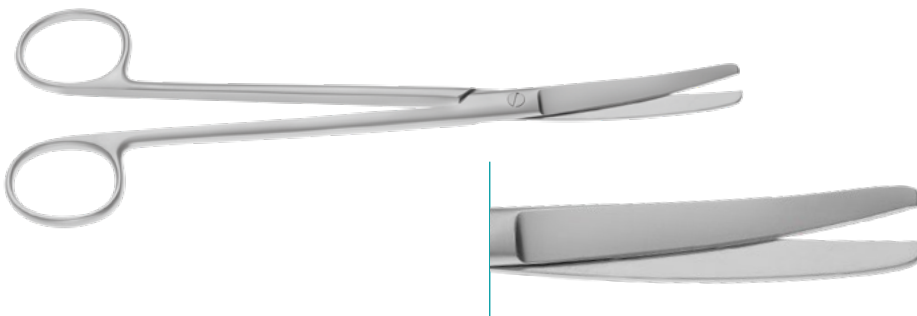

### WERTHEIM

Preparation Scissors, curved

195mm, 7<sup>3/4</sup>" 120-053-195

225mm, 8<sup>7/8</sup>" 120-053-225

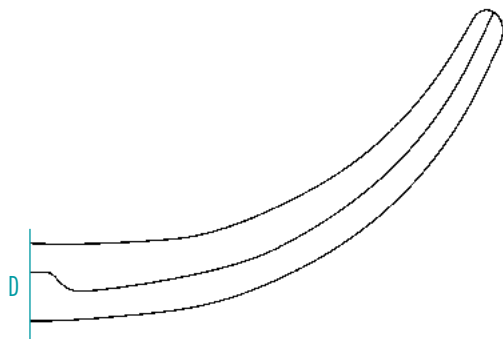
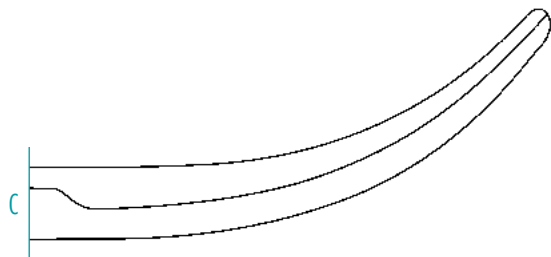
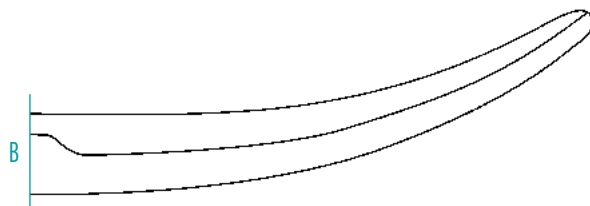
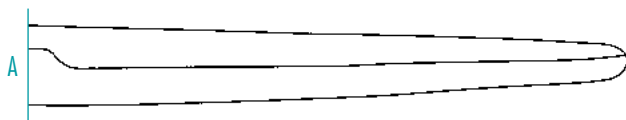
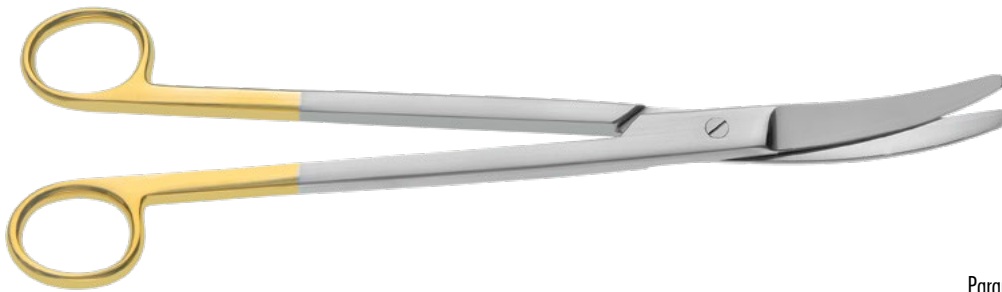

Parametrium Scissors, TC  
230mm, 9"

A straight	120-537-001
B slightly curved	120-537-002
C strongly curved	120-537-003
D angled	120-537-004

265mm, 10<sup>1/2</sup>"

A straight	120-536-001
B slightly curved	120-536-002
C strongly curved	120-536-003
D angled	120-536-004

Parametrium Scissors, TC  
305mm, 12"

A straight	120-538-001
B slightly curved	120-538-002
C strongly curved	120-538-003
D angled	120-538-004

Parametrium Scissors, TC  
350mm, 14"

A straight	120-539-001
B slightly curved	120-539-002
C strongly curved	120-539-003
D angled	120-539-004

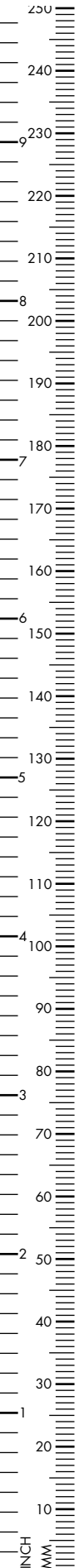



**MODEL USA**

Umbilical Cord Scissors

105mm, 4<sup>1</sup>/<sub>3</sub>"

120-233-105



**BUSCH**

Umbilical Cord Scissors, lateral curved

160mm, 6<sup>1</sup>/<sub>4</sub>"

120-229-160



**SCHUMACHER**

Umbilical Cord Scissors

160mm, 6<sup>1</sup>/<sub>4</sub>"

120-227-160

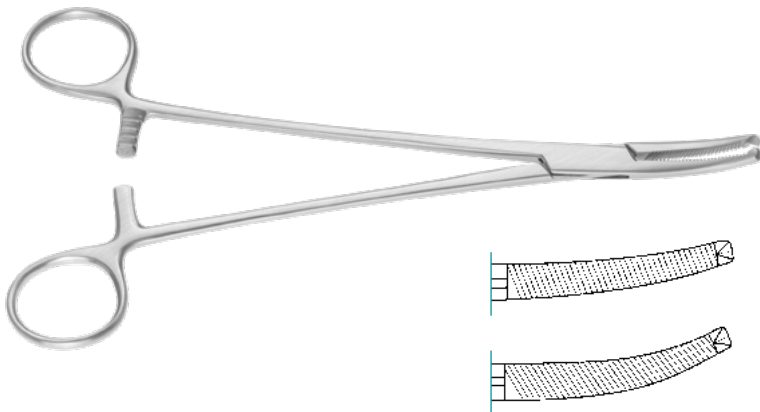

### FAURE

Peritoneal Forceps, 200mm, 8"

Fig. 1 140-551-200

slightly curved

Fig. 2 140-553-200

strongly curved

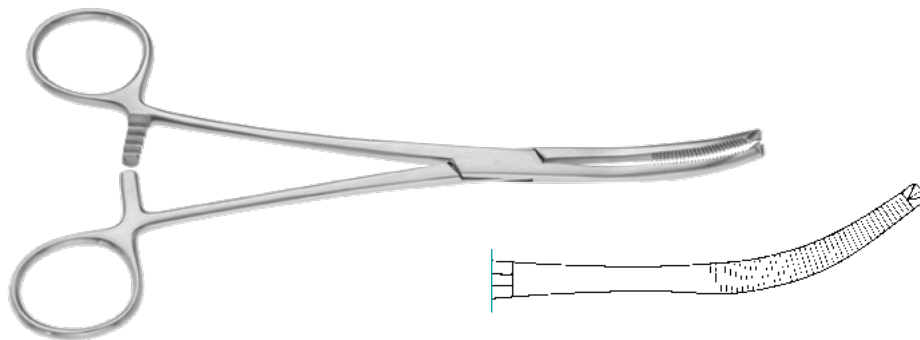

### MIKULICZ

Peritoneal Forceps, strongly curved, 1x2 teeth

180mm, 7" 140-549-185

200mm, 8" 140-549-200

laterally curved, 1x2 teeth

180mm, 7" 140-549-180

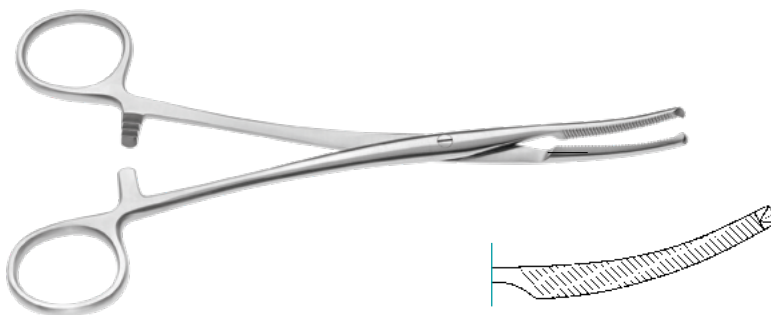

### MIKULICZ

Peritoneal Forceps, curved, 1x2 teeth

180mm, 7" 140-548-180

200mm, 8" 140-548-200

245mm, 9<sup>2</sup>/<sub>3</sub>" 140-548-245

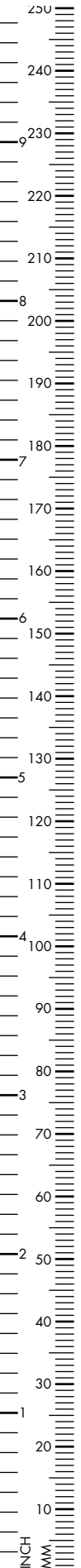

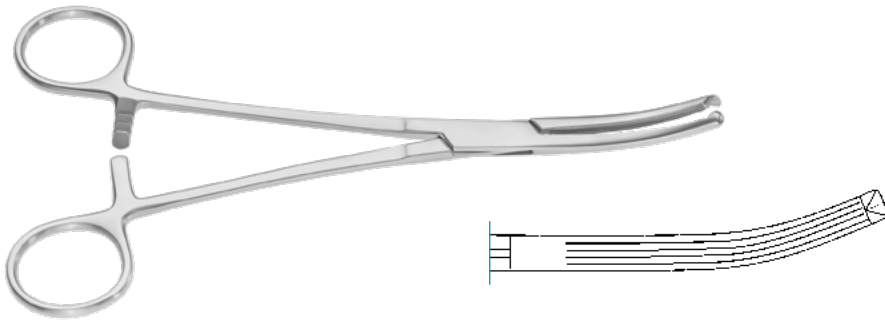

**LONG**

Hysterectomy Forceps, 1x2 teeth

190mm, 7<sup>1</sup>/<sub>2</sub>"

140-652-190

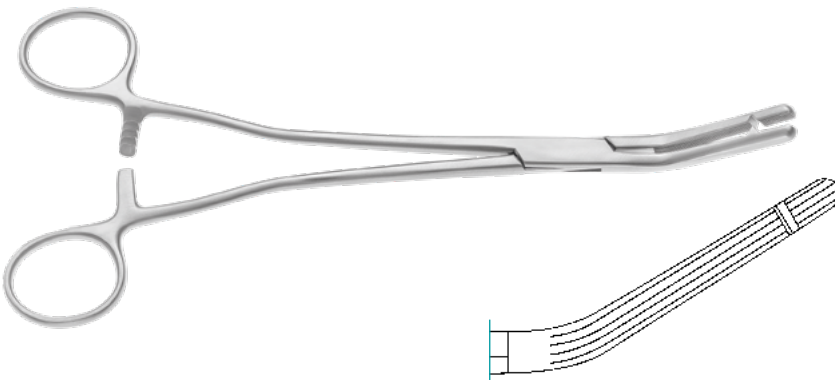

**GARLAND**

Hysterectomy Forceps, 1x2 teeth

210mm, 8<sup>1</sup>/<sub>4</sub>"

140-639-210

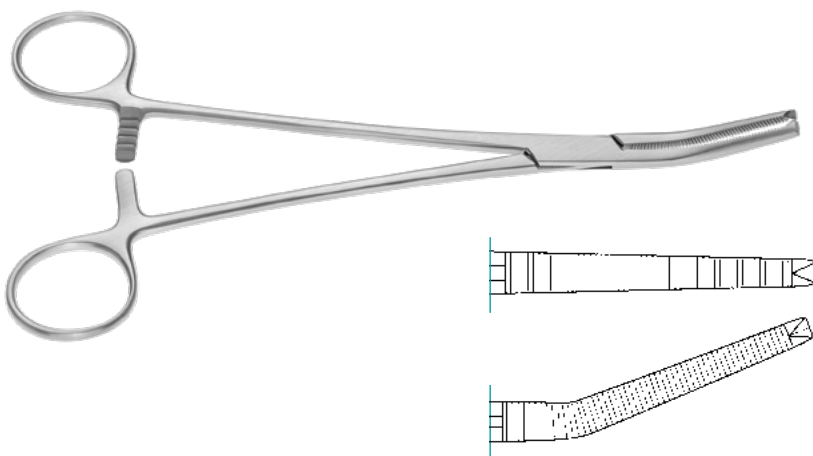

**PHANEUF**

Peritoneal Forceps, 1x2 teeth,  
straight

215mm, 8<sup>1</sup>/<sub>2</sub>"

140-520-210

curved

210mm, 8<sup>1</sup>/<sub>4</sub>"

140-521-210

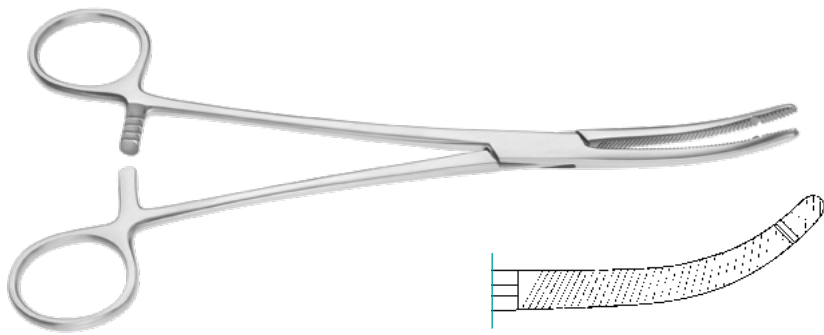

**HEANEY**

Hysterectomy Forceps, delicate, single tooth, curved

210mm, 8<sup>1</sup>/<sub>4</sub>"

140-612-210

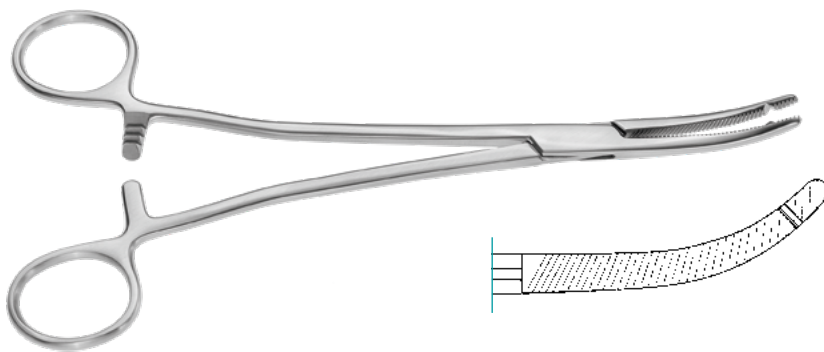

**HEANEY**

Hysterectomy Forceps, single tooth, curved

210mm, 8<sup>1</sup>/<sub>4</sub>"

140-613-210

230mm, 9"

140-613-230

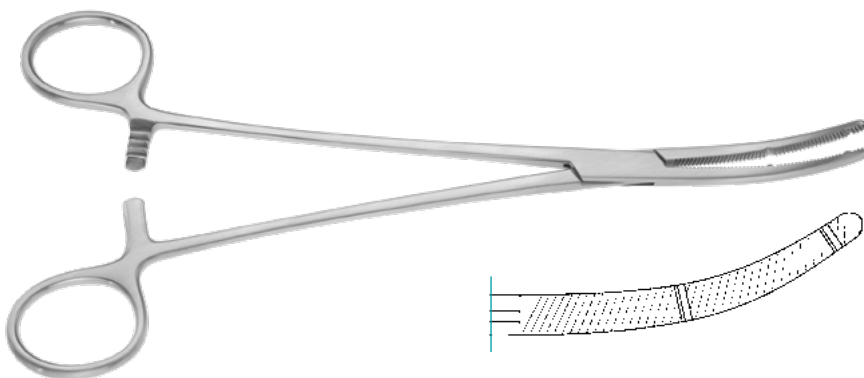

**HEANEY**

Hysterectomy Forceps, double tooth, curved

210mm, 8<sup>1</sup>/<sub>4</sub>"

140-615-210

230mm, 9"

140-615-230

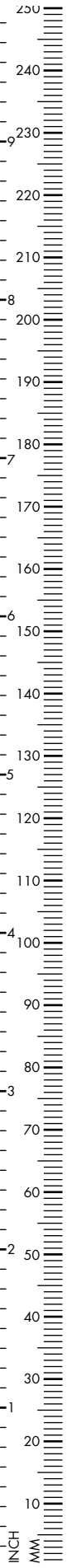



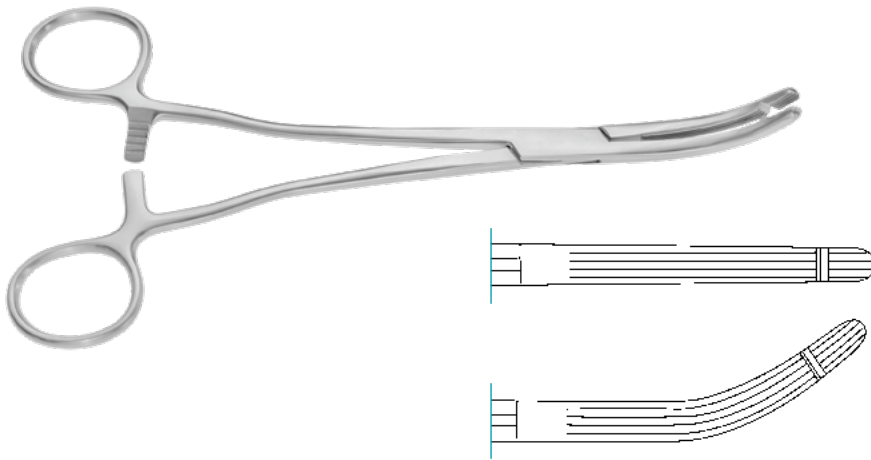

### **BALLANTINE**

Hysterectomy Forceps, straight, single tooth

210mm, 8<sup>1</sup>/<sub>4</sub>" 140-617-210

300mm, 11<sup>7</sup>/<sub>8</sub>" 140-617-300

curved

210mm, 8<sup>1</sup>/<sub>4</sub>" 140-618-210

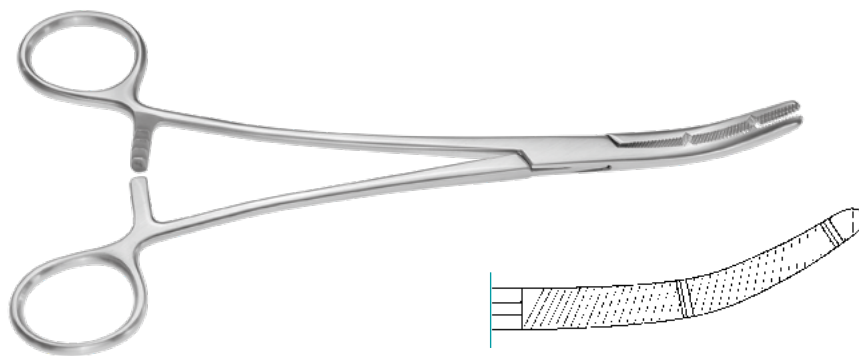

### **HEANEY KANTER**

Hysterectomy Forceps, curved, single tooth

210mm, 8<sup>1</sup>/<sub>4</sub>" 140-619-210

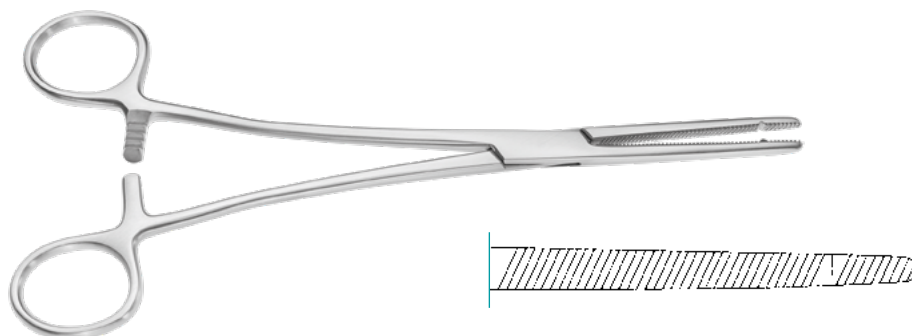

### **HEANEY REZEK**

Hysterectomy Forceps, straight, single tooth

210mm, 8<sup>1</sup>/<sub>4</sub>" 140-627-210

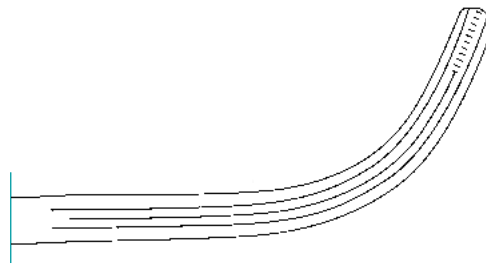

### GUPTA FRANK

Forceps, s-curved, 80mm jaw length

240mm, 9<sup>1</sup>/<sub>2</sub>" 140-707-240

270mm, 10<sup>2</sup>/<sub>3</sub>" 140-707-270

320mm, 12<sup>1</sup>/<sub>2</sub>" 140-707-320

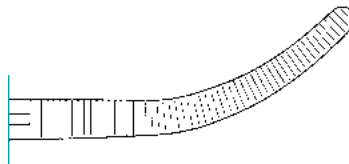
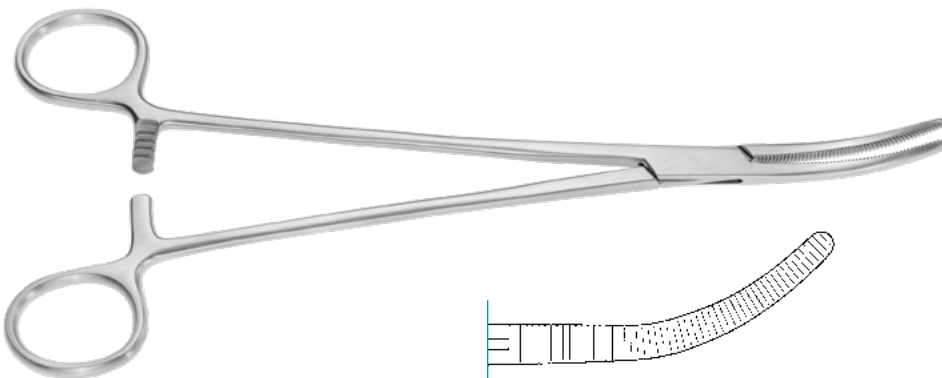

### WERTHEIM

Hysterectomy Forceps, serrated, curved

250mm, 9<sup>7</sup>/<sub>8</sub>" 140-697-250

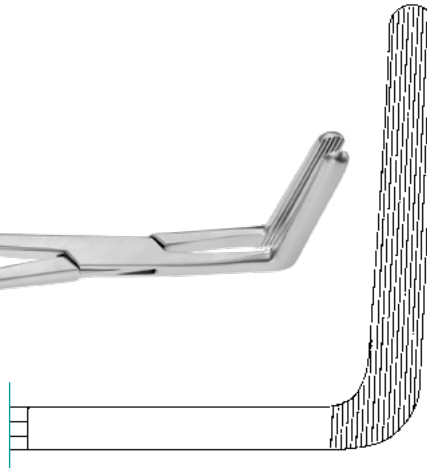
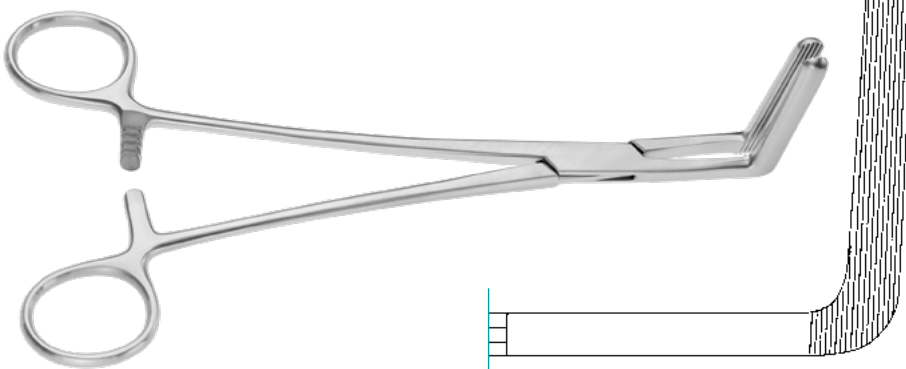

### WERTHEIM CULLEN

Hysterectomy Forceps, 90° angled

215mm, 8<sup>1</sup>/<sub>2</sub>" 140-641-215

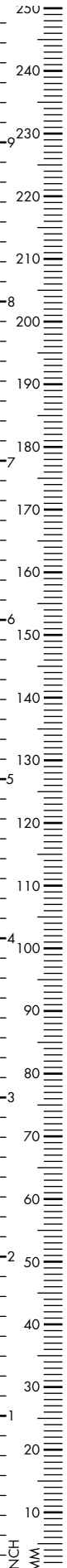

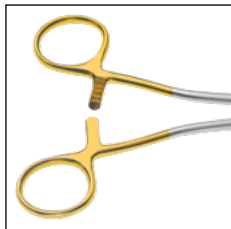
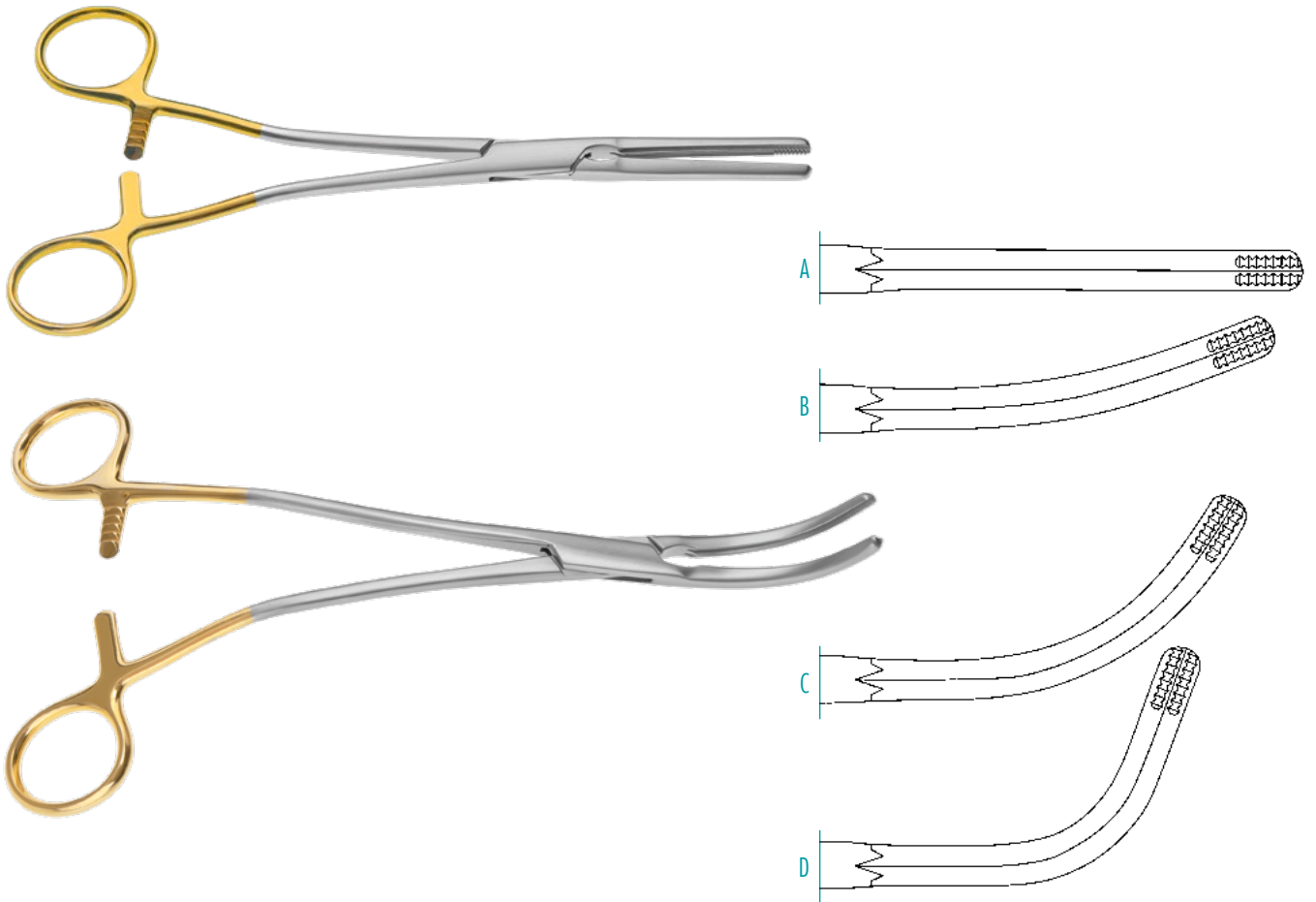

**A** Parametrium Forceps, straight

210mm, 8 <sup>1</sup> / <sub>4</sub> "	140-700-220
250mm, 9 <sup>7</sup> / <sub>8</sub> "	140-700-250
305mm, 12"	140-700-305
355mm, 14"	140-700-350

**B** slightly curved

210mm, 8 <sup>1</sup> / <sub>4</sub> "	140-701-215
240mm, 9 <sup>1</sup> / <sub>2</sub> "	140-701-245
305mm, 12"	140-701-305
355mm, 14"	140-701-350

**C** strongly curved

210mm, 8 <sup>1</sup> / <sub>4</sub> "	140-702-210
240mm, 9 <sup>1</sup> / <sub>2</sub> "	140-702-245
305mm, 12"	140-702-305
355mm, 14"	140-702-350

**D** angled

210mm, 8 <sup>1</sup> / <sub>4</sub> "	140-703-205
240mm, 9 <sup>1</sup> / <sub>2</sub> "	140-703-245
305mm, 12"	140-703-305
355mm, 14"	140-703-350



**A** straight, angled shanks

210mm, 8 <sup>1</sup> / <sub>4</sub> "	141-700-220
240mm, 9 <sup>1</sup> / <sub>2</sub> "	141-700-250

**B** slightly curved, angled shanks

210mm, 8 <sup>1</sup> / <sub>4</sub> "	141-701-215
240mm, 9 <sup>1</sup> / <sub>2</sub> "	141-701-245

**C** strongly curved, angled shanks

210mm, 8 <sup>1</sup> / <sub>4</sub> "	141-702-210
240mm, 9 <sup>1</sup> / <sub>2</sub> "	141-702-245

**D** angled, angled shanks

210mm, 8 <sup>1</sup> / <sub>4</sub> "	141-703-210
245mm, 9 <sup>2</sup> / <sub>3</sub> "	141-703-245

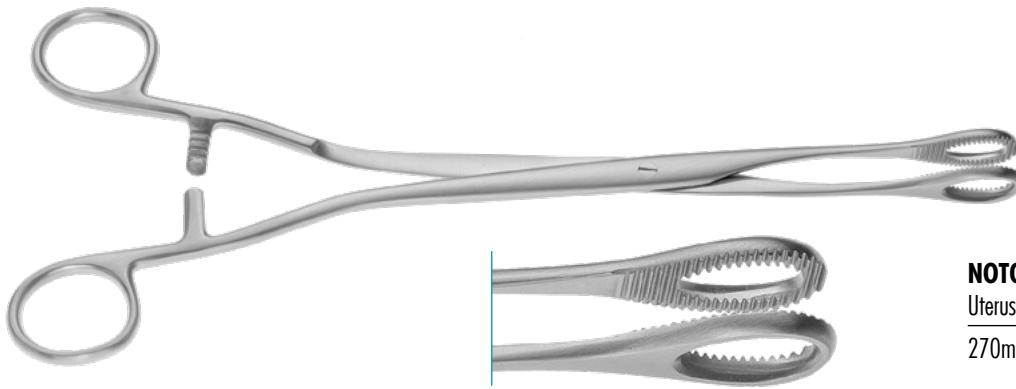

**NOTO**

Uterus Polypus Forceps

270mm, 10<sup>2</sup>/<sub>3</sub>"

350-492-270

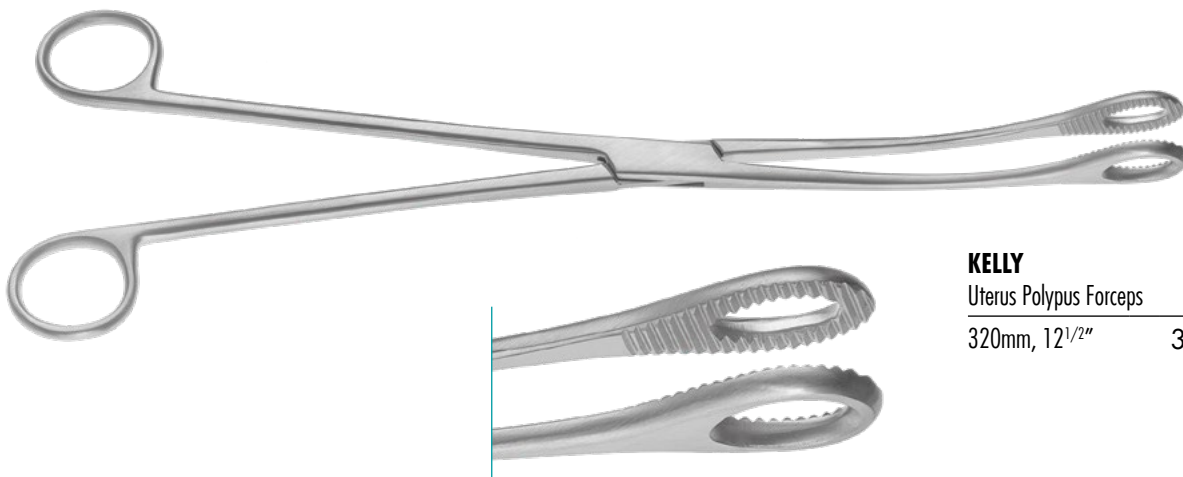

**KELLY**

Uterus Polypus Forceps

320mm, 12<sup>1</sup>/<sub>2</sub>"

350-490-320

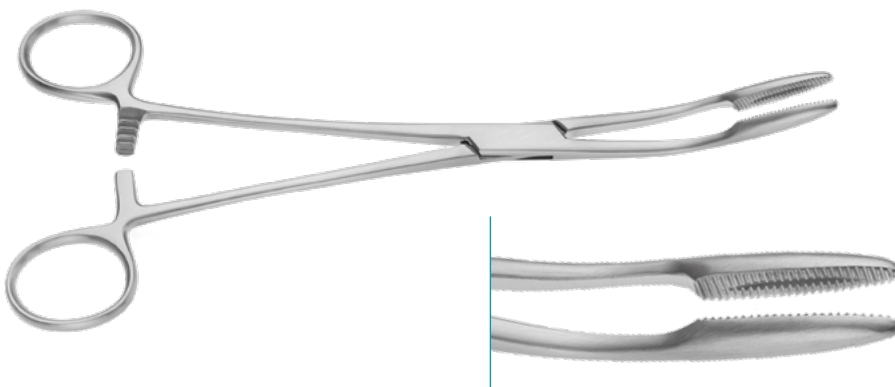

**GROSS MAIER**

Swab Forceps, curved

220mm, 8<sup>2</sup>/<sub>3</sub>"

150-031-220

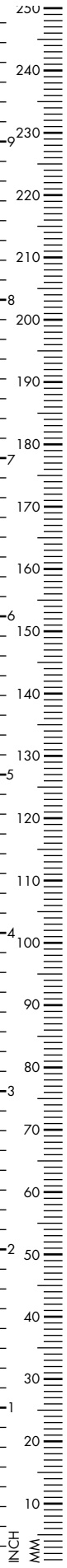

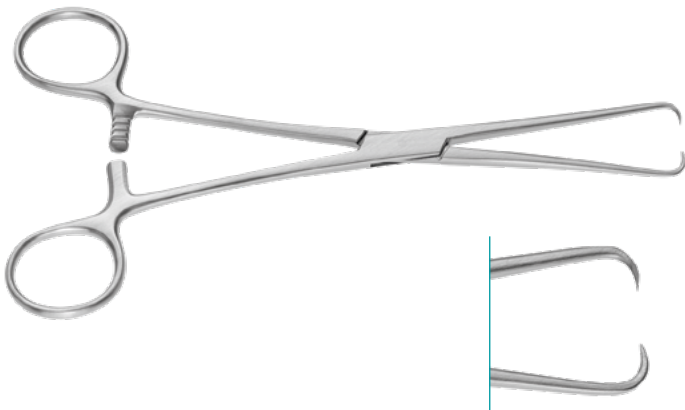

**BARRETT**

Tenaculum Forceps

180mm, 7"

350-426-180

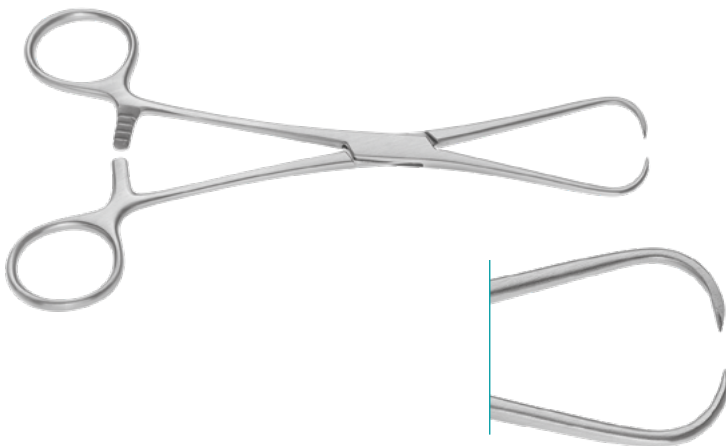

**STAUDE MOORE**

Tenaculum Forceps

170mm, 6<sup>2</sup>/<sub>3</sub>"

350-422-170

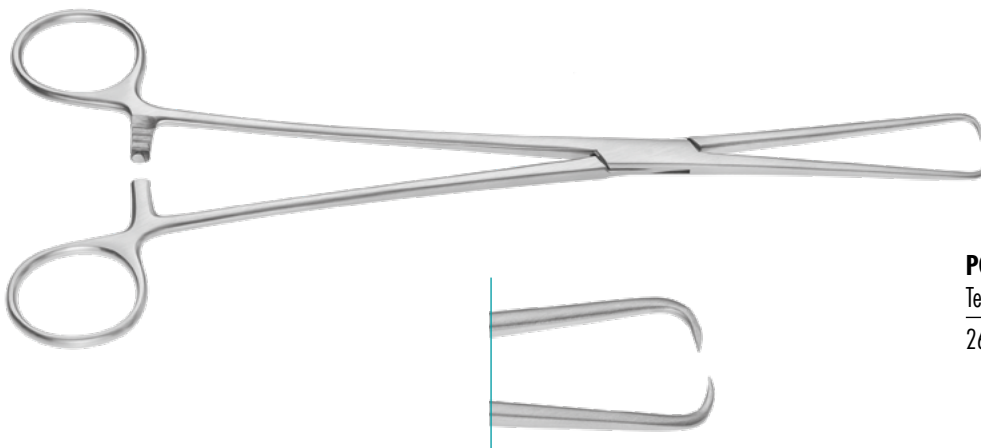

**POZZI**

Tenaculum Forceps

260mm, 10<sup>1</sup>/<sub>4</sub>"

350-420-260

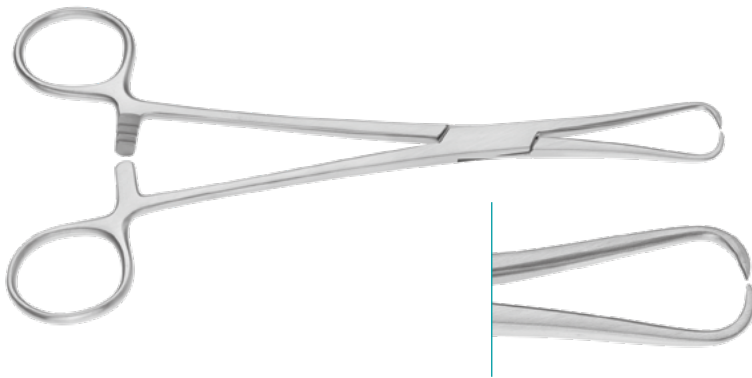

**ADAIR**

Tenaculum Forceps

190mm, 7<sup>1</sup>/<sub>2</sub>"

350-426-190

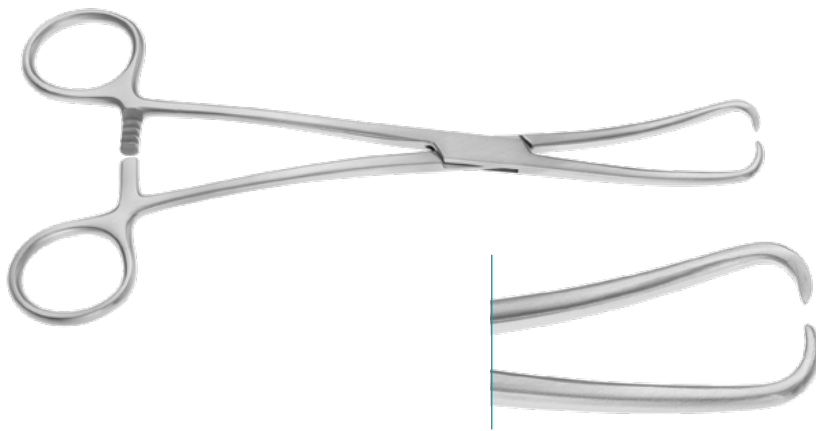

**JARCHO**

Tenaculum Forceps

200mm, 8"

350-427-200



**CZERNY**

Tenaculum Forceps, straight

205mm, 8<sup>1</sup>/<sub>8</sub>"

350-480-205

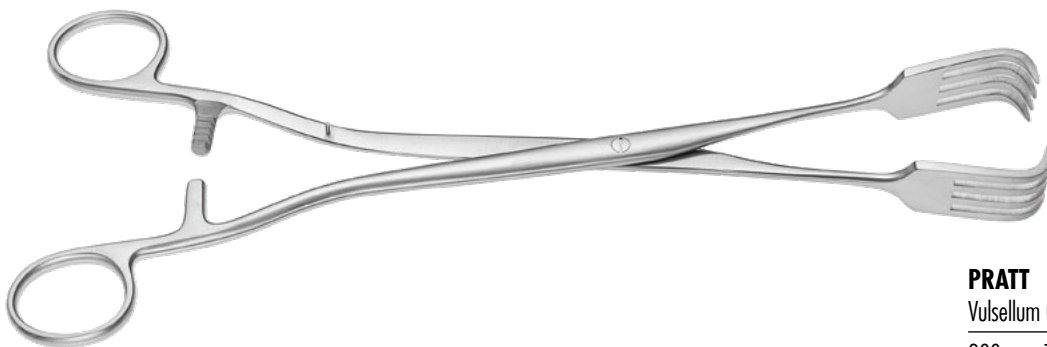

**PRATT**

Vulsellum Grasper and Depressor

280mm, 11"

350-342-280

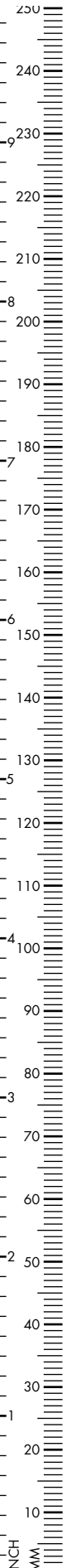

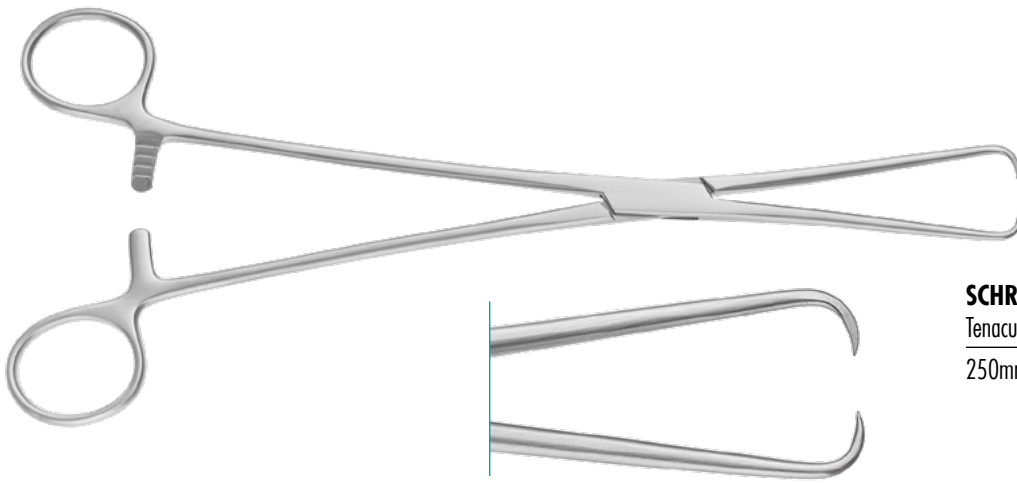

**SCHROEDER**

Tenaculum Forceps

250mm, 9<sup>7</sup>/<sub>8</sub>"

350-400-250

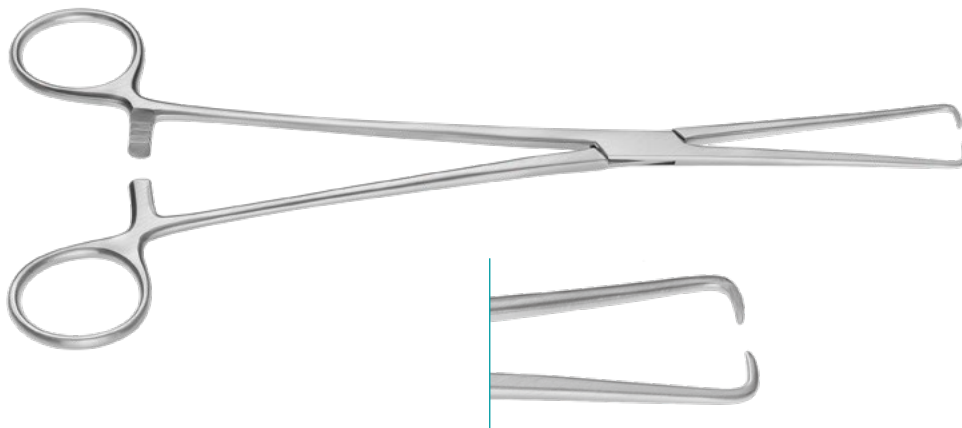

**BRAUN**

Tenaculum Forceps

250mm, 9<sup>7</sup>/<sub>8</sub>"

350-410-250

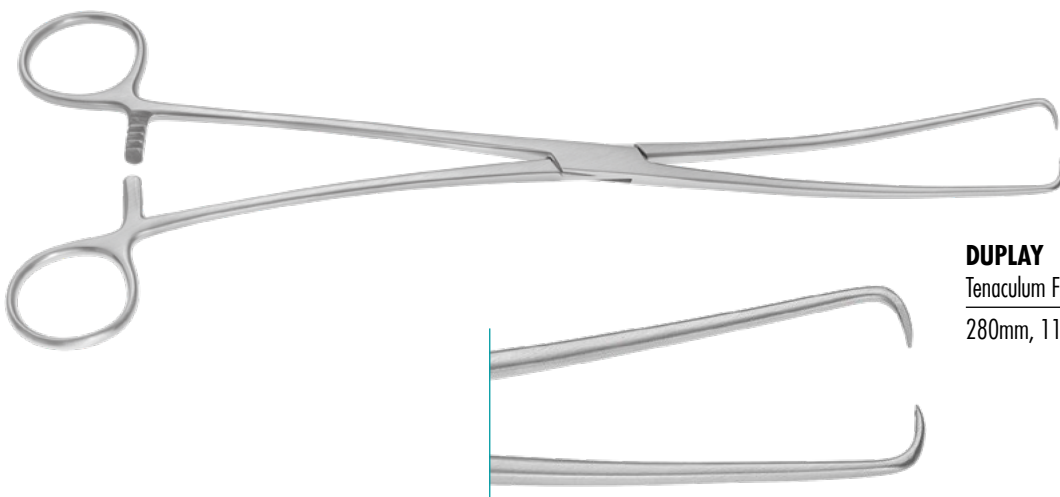

**DUPLAY**

Tenaculum Forceps

280mm, 11"

350-428-280



**HULKA**

Uterine Manipulator Tenaculum Forceps

290mm, 11<sup>1</sup>/<sub>2</sub>" 350-302-290

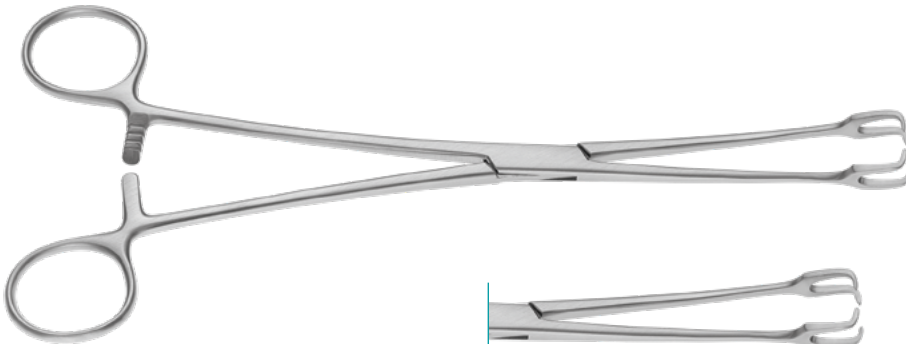

**SCHROEDER**

Tenaculum Forceps, 2 teeth, 240mm, 9<sup>1</sup>/<sub>2</sub>"

straight 350-440-240

curved 350-441-240

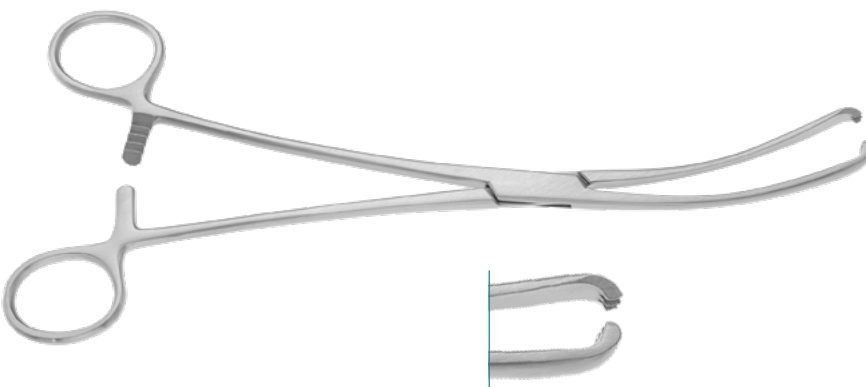

**TEALE**

Tenaculum Forceps, laterally curved, 3x4 teeth

230mm, 9" 350-443-230

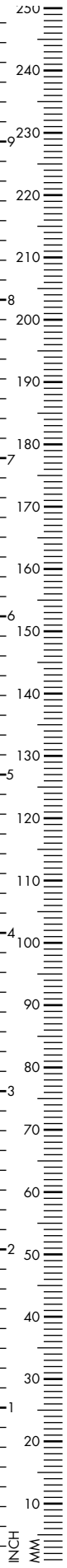
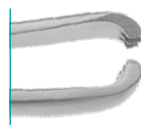



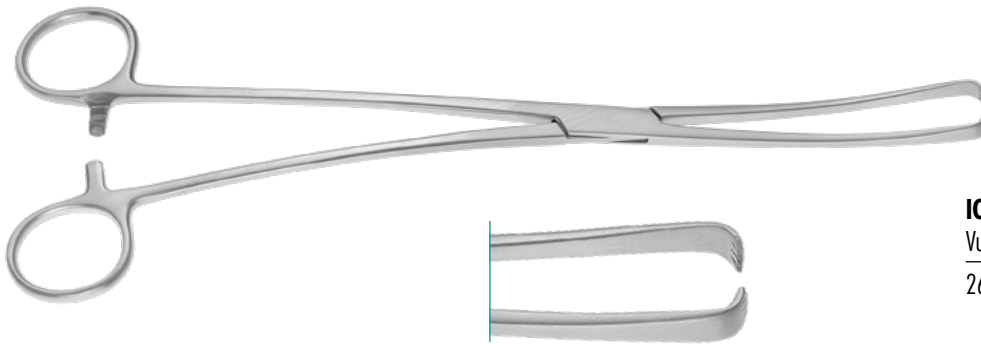

### IOWA

Vulsellum Forceps

260mm, 10<sup>1</sup>/<sub>4</sub>"

350-445-260

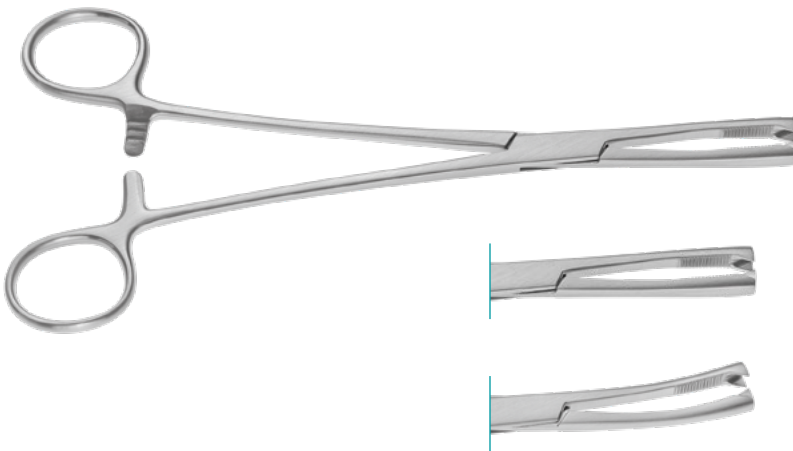

### JACOBS

Tenaculum Forceps, 2x2 teeth, 210mm, 8<sup>1</sup>/<sub>4</sub>"

straight

350-470-210

curved

350-471-210

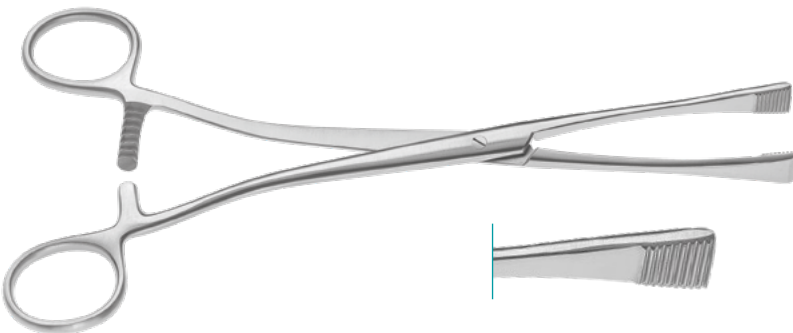

### GREEN ARMYTAGE

Caesarean Forceps, straight,  
15mm wide serrated jaw

210mm, 8<sup>1</sup>/<sub>4</sub>"

340-150-210

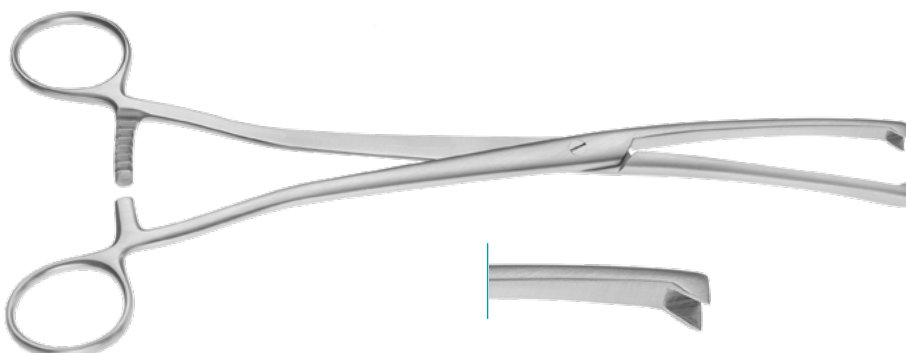

### MUSEUX

Forceps, 2x2 teeth, 8mm jaw  
240mm, 9<sup>1</sup>/<sub>2</sub>" working length

straight

350-452-240

curved

350-453-240

10mm jaw

straight

350-454-240

curved

350-455-240

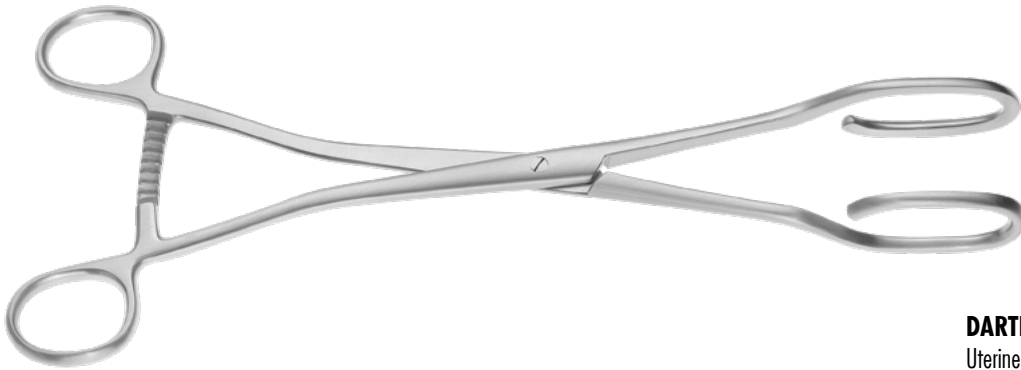

**DARTIGUES**

Uterine Elevating Forceps

270mm, 10<sup>2</sup>/<sub>3</sub>" 350-493-270

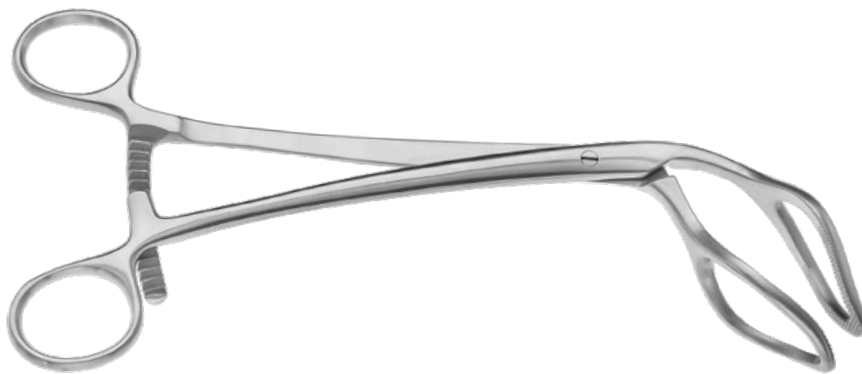

**SOMER**

Uterine Elevating Forceps

230mm, 9" 350-493-230

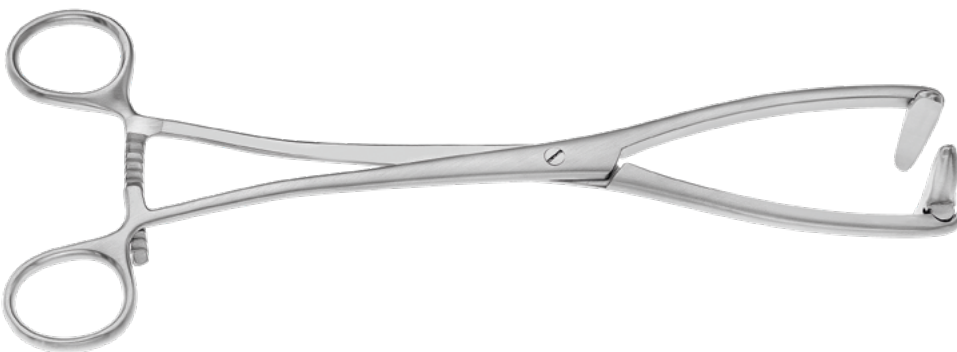

**COLLIN**

Uterine Forceps

250mm, 9<sup>7</sup>/<sub>8</sub>" 350-493-250

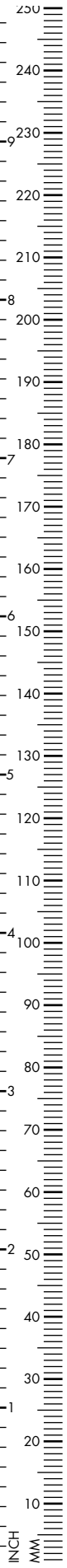

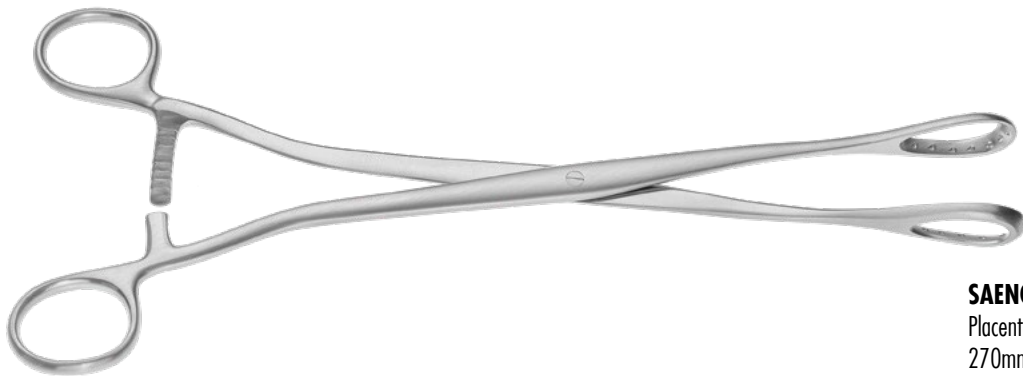

### SAENGER

Placenta and Ovum Forceps,  
270mm, 10<sup>2</sup>/<sub>3</sub>"

straight	340-798-270
curved	340-799-270

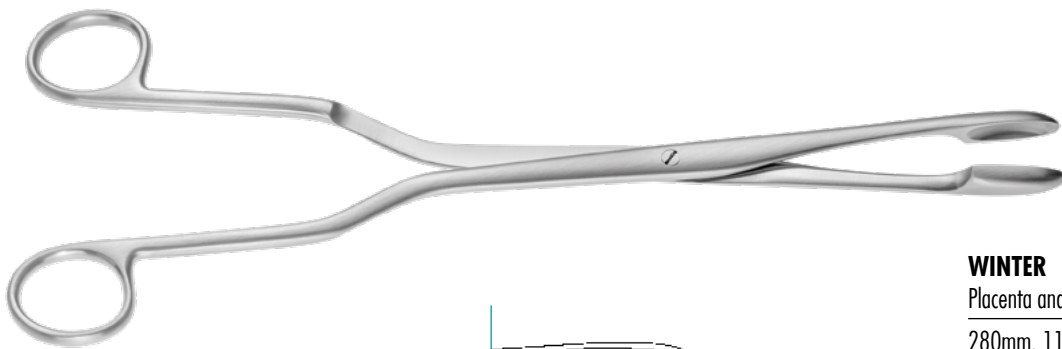

Fig. 1

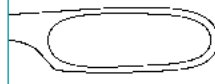

Fig. 2



### WINTER

Placenta and Ovum Forceps, Fig. 2

280mm, 11"	340-799-280
------------	-------------

Placenta and Ovum Forceps, 280mm, 11"

Fig. 1	340-800-280
--------	-------------

Fig. 2	340-802-280
--------	-------------

Fig. 1 curved	
---------------	--

280mm, 11"	340-801-280
------------	-------------

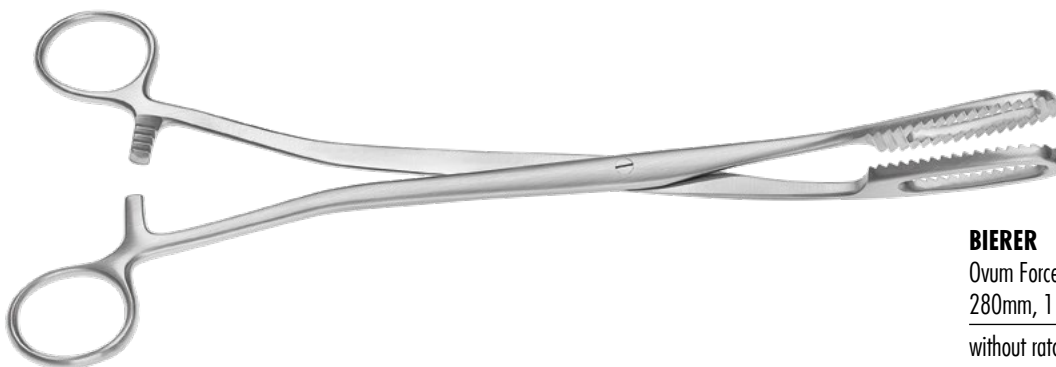

### BIERER

Ovum Forceps, curved, 16mm jaw,  
280mm, 11"

without ratchet	350-496-330
-----------------	-------------

with ratchet	350-497-330
--------------	-------------



**WRIGLEY**

Obstetrical Forceps

280mm, 11"

340-011-280

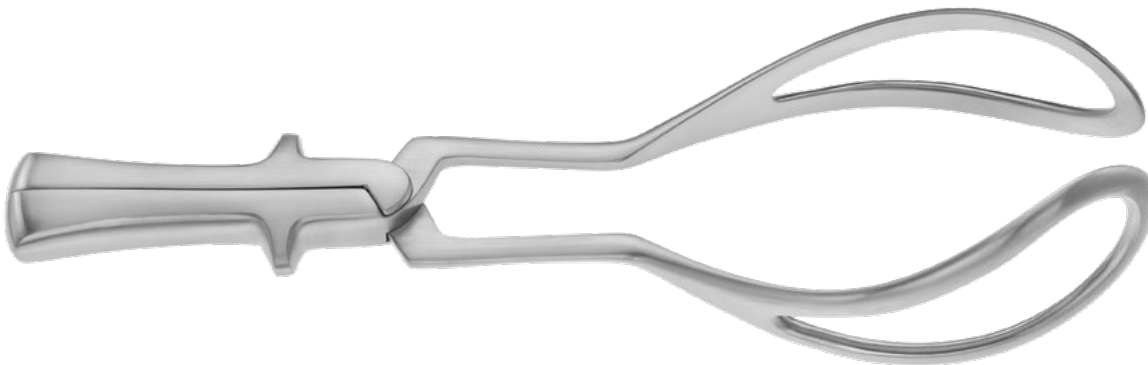

**SIMPSON**

Obstetrical Forceps

300mm, 11<sup>7/8</sup>"

340-013-300



**SIMPSON BRAUN**

Obstetrical Forceps

330mm, 13"

340-012-330

360mm, 14"

340-012-360

250  
240  
230  
220  
210  
200  
190  
180  
170  
160  
150  
140  
130  
120  
110  
100  
90  
80  
70  
60  
50  
40  
30  
20  
10  
0  
INCH  
MM

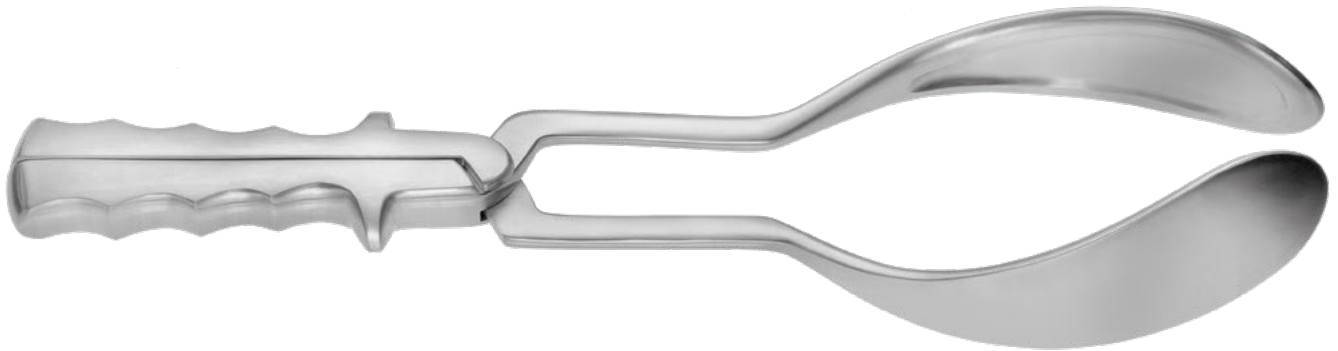
**SIMPSON LUIKART**

Obstetrical Forceps

---

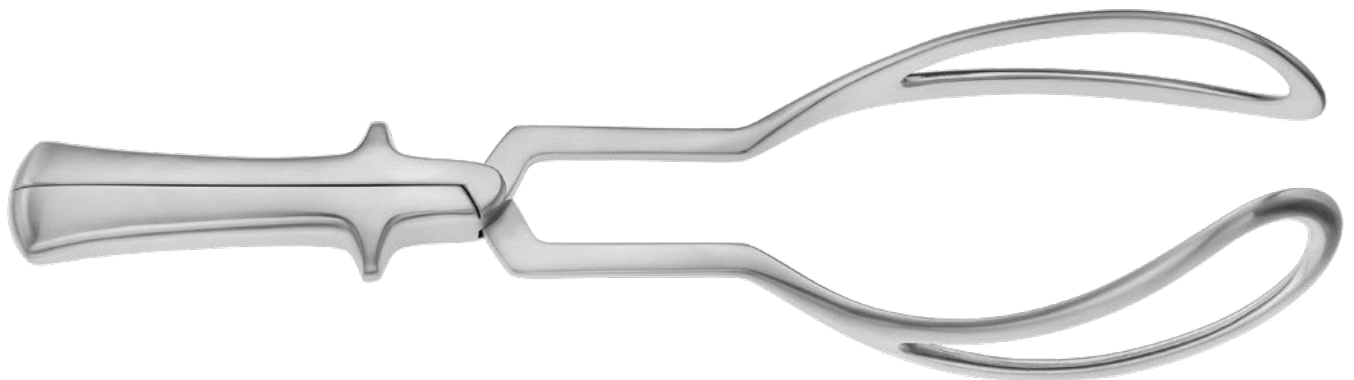
360mm, 14" 340-029-360**DE LEE**

Obstetrical Forceps

---

300mm, 11<sup>7</sup>/<sub>8</sub>" 340-018-300  
360mm, 14" 340-018-360



**ELLIOT**  
Obstetrical Forceps  
380mm, 15"      340-025-380

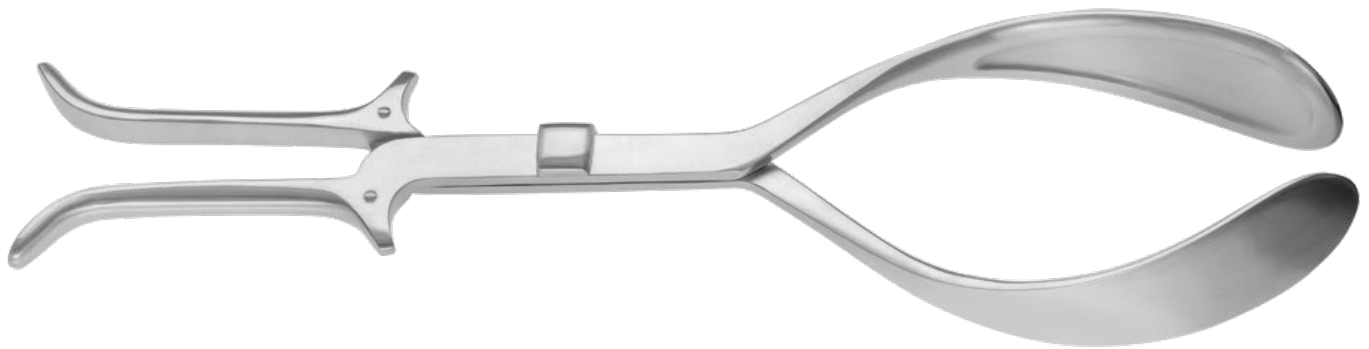

**KIELLAND LUIKART**  
Obstetrical Forceps  
400mm, 15<sup>3/4</sup>"      340-016-400

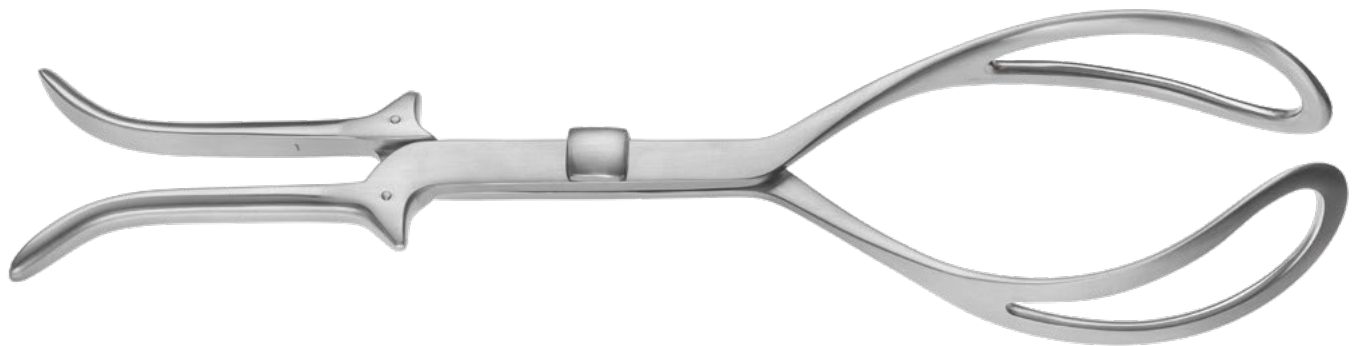

**KIELLAND**  
Obstetrical Forceps  
410mm, 16<sup>1/8</sup>"      340-014-410

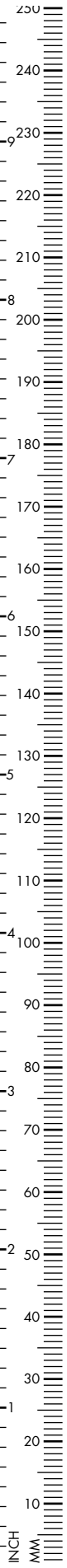

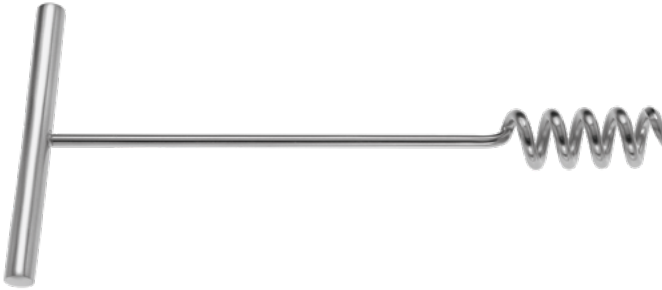

**DOYEN**

Myoma screw

170mm

working length

350-757-190

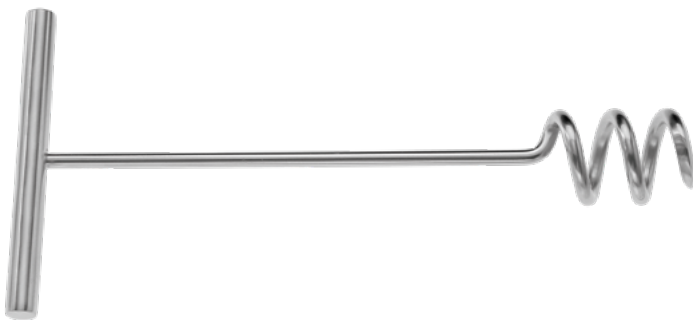

**DOYEN**

Myoma screw

170mm working  
length

350-759-170

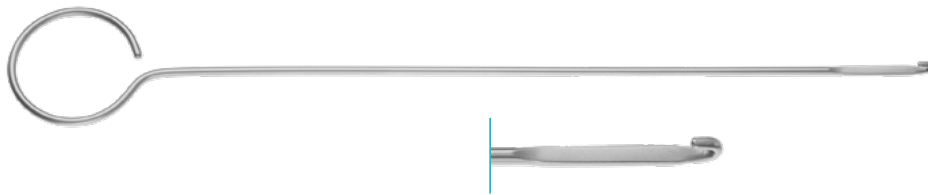

Simple IUD hook with ring handle, malleable  
250mm, 9<sup>7/8</sup>" 350-766-001

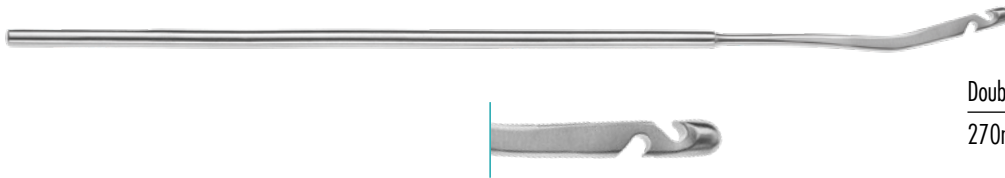

Double IUD Extractor  
270mm, 10<sup>2/3</sup>" 350-766-010



**SAUNDERS**  
IUD Removing Hook  
250mm, 9<sup>7/8</sup>" 350-766-100



**EMMET**  
Fistula Hook, 220mm, 8<sup>2/3</sup>"  
Fig. 1 350-765-001  
Fig. 2 350-765-002  
Fig. 3 350-765-003  
Fig. 4 350-765-004  
Fig. 5 350-765-005

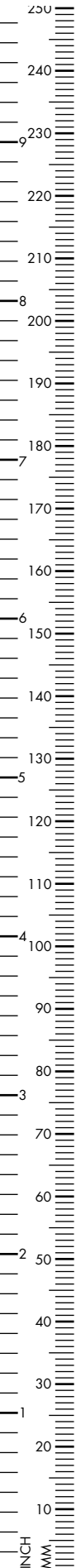
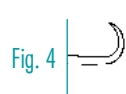



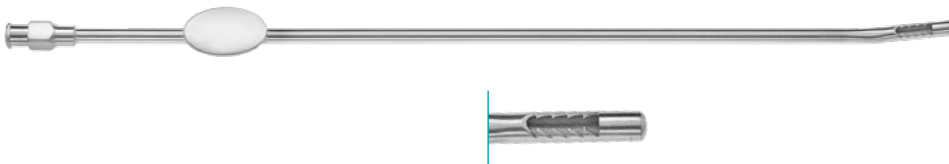

### NOVAK

Biopsy Curette, 250mm, 9<sup>7</sup>/<sub>8</sub>"

Ø 1mm	350-601-230
Ø 2mm	350-602-230
Ø 3mm	350-603-230
Ø 4mm	350-604-230

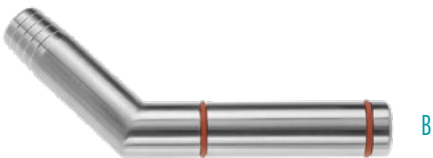

A Aspirating Curette, 290mm, 11<sup>1</sup>/<sub>2</sub>"

3.0mm	350-650-030
4.5mm	350-650-045
6.0mm	350-650-060
8.0mm	350-650-080
10.0mm	350-650-100
12.0mm	350-650-120
14.0mm	350-650-140

B Coupling Piece

350-650-000

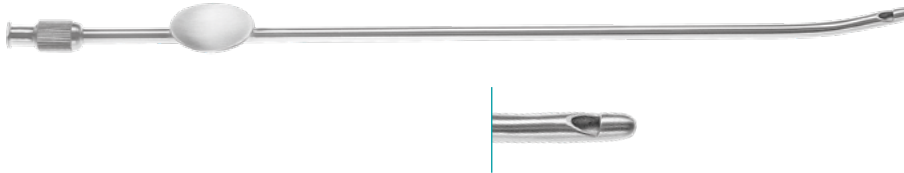

### RANDALL

Suction Biopsy Curette, 240mm, 9<sup>1</sup>/<sub>2</sub>"

Ø 4mm

350-602-240

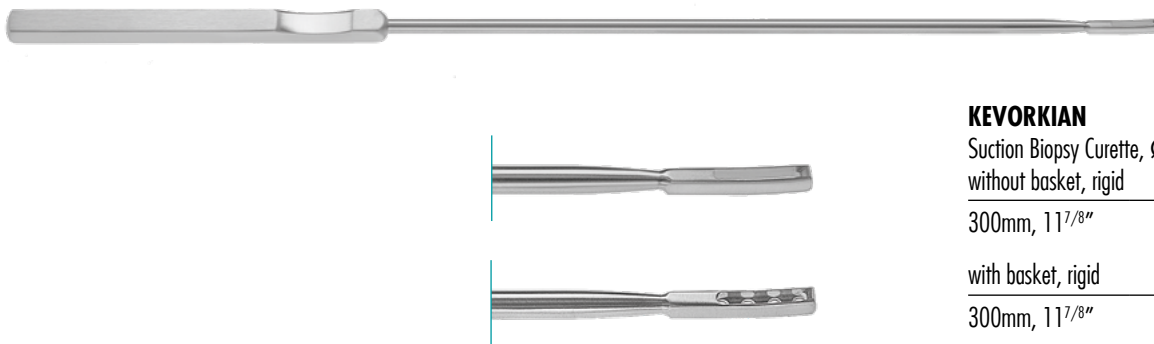

### KEVORKIAN

Suction Biopsy Curette, Ø 4mm,  
without basket, rigid

300mm, 11<sup>7</sup>/<sub>8</sub>"

350-599-300

with basket, rigid

300mm, 11<sup>7</sup>/<sub>8</sub>"

350-600-300

with basket, malleable

300mm, 11<sup>7</sup>/<sub>8</sub>"

350-601-300

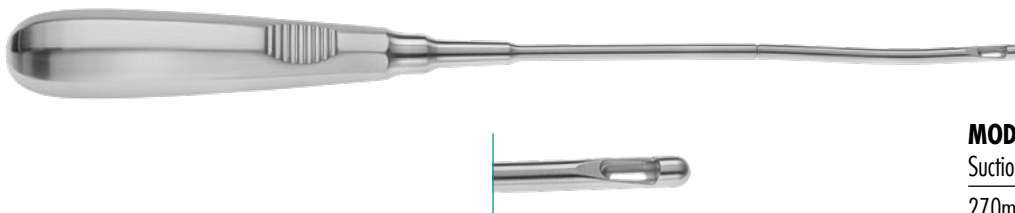

### MOD. MÜNCHEN

Suction Biopsy Curette, Ø 4mm

270mm, 10<sup>2</sup>/<sub>3</sub>"

350-605-270

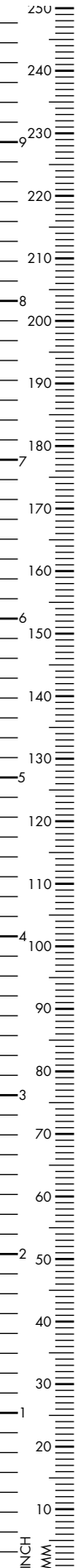



**BEACHAM**

Amniotome

260mm, 10<sup>1</sup>/<sub>4</sub>" 350-429-260



**BRAUN**

Uterine Depressor

280mm, 11" 350-399-280

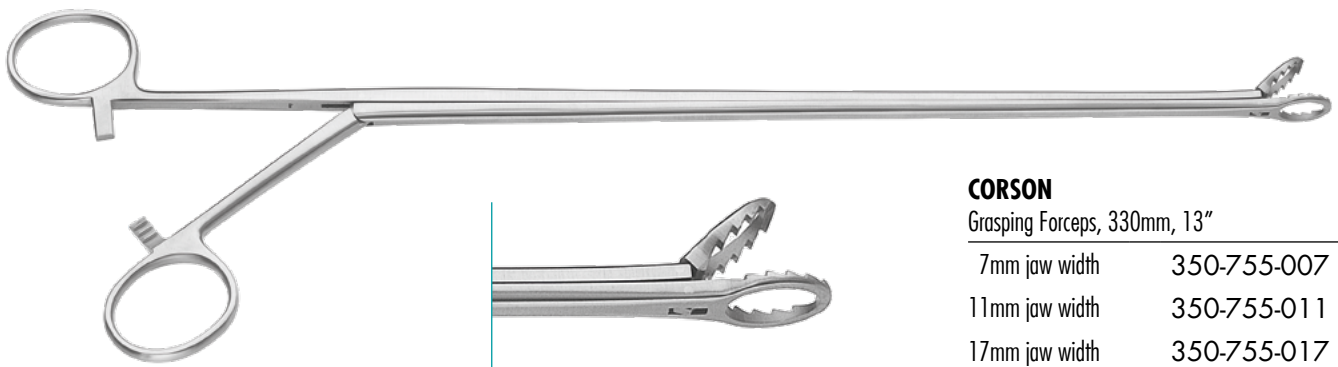

**CORSON**

Grasping Forceps, 330mm, 13"

7mm jaw width 350-755-007

11mm jaw width 350-755-011

17mm jaw width 350-755-017



Fig. 1



Fig. 2



Fig. 3



Fig. 4



Fig. 5

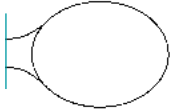

Fig. 6



### SIMON

Uterine Scoop, sharp, 240mm, 9<sup>1</sup>/<sub>2</sub>"

Fig. 1, 7.0mm	350-610-001
Fig. 2, 8.5mm	350-610-002
Fig. 3, 9.5mm	350-610-003
Fig. 4, 11.5mm	350-610-004
Fig. 5, 13.0mm	350-610-005
Fig. 6, 14.5mm	350-610-006



Fig. 1

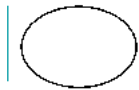

Fig. 2



Fig. 3

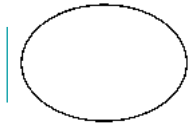

Fig. 4



Fig. 5

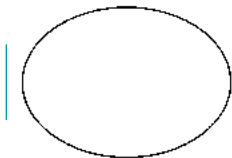

Fig. 6



### SCHROEDER

Uterine Scoop, sharp, 300mm, 11<sup>7</sup>/<sub>8</sub>"

Fig. 1, 6.8mm	350-612-001
Fig. 2, 8.5mm	350-612-002
Fig. 3, 10.0mm	350-612-003
Fig. 4, 11.5mm	350-612-004
Fig. 5, 13.0mm	350-612-005
Fig. 6, 14.5mm	350-612-006

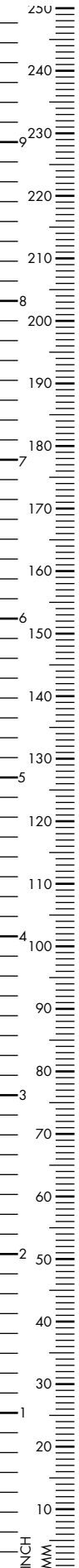

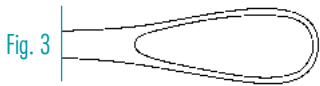
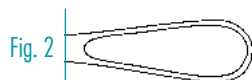
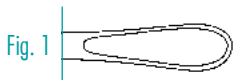

### GOURDET

Uterine Scoop, blunt, 280mm, 11"

Fig. 1, 6mm	350-613-006
Fig. 2, 8mm	350-613-008
Fig. 3, 10mm	350-613-010
Fig. 4, 12mm	350-613-012
Fig. 5, 14mm	350-613-014



### THOMAS

Uterus Curette, malleable, blunt, 280mm, 11"

Fig. 1, Ø 10mm	350-919-001
Fig. 2, Ø 11mm	350-919-002
Fig. 3, Ø 12mm	350-919-003
Fig. 4, Ø 13mm	350-919-004
Fig. 5, Ø 14mm	350-919-005
Fig. 6, Ø 15mm	350-919-006



### SIMS

Uterus Curette, 285mm, 11<sup>1/4</sup>"

rigid, sharp

rigid, blunt

malleable, sharp

malleable, blunt



Fig. 00, 5mm



Fig. 0, 6mm



Fig. 1, 7mm



Fig. 2, 8mm

350-630-005

350-630-006

350-630-007

350-630-008

350-926-050

350-926-060

350-926-070

350-926-080

350-631-005

350-631-006

350-631-007

350-631-008

350-927-050

350-927-060

350-927-070

350-927-080



Fig. 3, 9mm



Fig. 4, 11mm



Fig. 5, 12mm

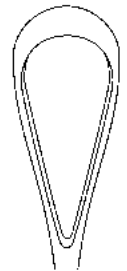

Fig. 6, 14mm

rigid, sharp

rigid, blunt

malleable, sharp

malleable, blunt

350-630-009

350-630-011

350-630-012

350-630-014

350-926-090

350-926-110

350-926-120

350-926-140

350-631-009

350-631-011

350-631-012

350-631-014

350-927-090

350-927-110

350-927-120

350-927-140



Fig. 7, 15mm



Fig. 8, 16mm

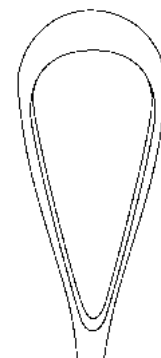

Fig. 9, 19mm

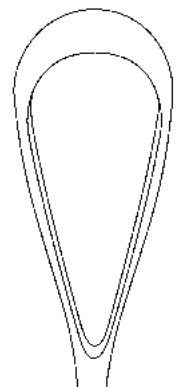

Fig. 10, 20mm

rigid, sharp

rigid, blunt

malleable, sharp

malleable, blunt

350-630-015

350-630-016

350-630-019

350-630-020

350-926-150

350-926-160

350-926-190

350-926-200

350-631-015

350-631-016

350-631-019

350-631-020

350-927-150

350-927-160

350-927-190

350-927-200

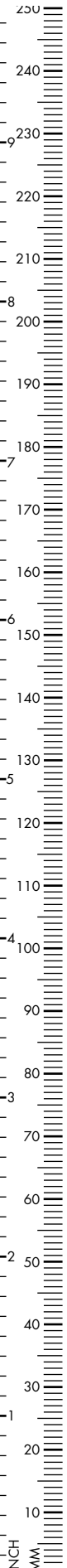



### RECAMIER

Uterus Curette, 310mm, 12<sup>1/4</sup>"

	Fig. 00, 5mm	Fig. 0, 6mm	Fig. 1, 7mm	Fig. 2, 8mm
rigid, sharp	350-620-005	350-620-006	350-620-007	350-620-008
rigid, blunt	350-619-005	350-619-006	350-619-007	350-619-008
malleable, sharp	350-621-005	350-621-006	350-621-007	350-621-008
malleable, blunt	350-622-005	350-622-006	350-622-007	350-622-008



Fig. 00, 5mm



Fig. 0, 6mm



Fig. 1, 7mm



Fig. 2, 8mm



Fig. 3, 9mm



Fig. 4, 11mm



Fig. 5, 12mm

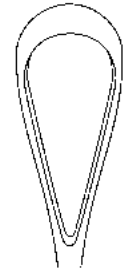

Fig. 6, 14mm

	Fig. 3, 9mm	Fig. 4, 11mm	Fig. 5, 12mm	Fig. 6, 14mm
rigid, sharp	350-620-009	350-620-011	350-620-012	350-620-014
rigid, blunt	350-619-009	350-619-011	350-619-012	350-619-014
malleable, sharp	350-621-009	350-621-011	350-621-012	350-621-014
malleable, blunt	350-622-009	350-622-011	350-622-012	350-622-014

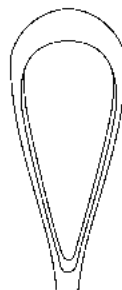

Fig. 7, 15mm



Fig. 8, 16mm

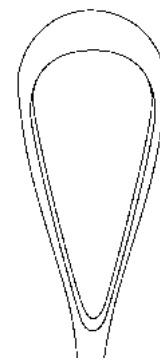

Fig. 9, 19mm

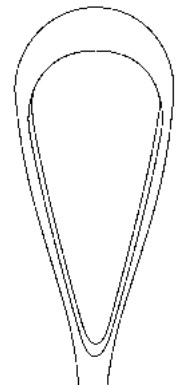
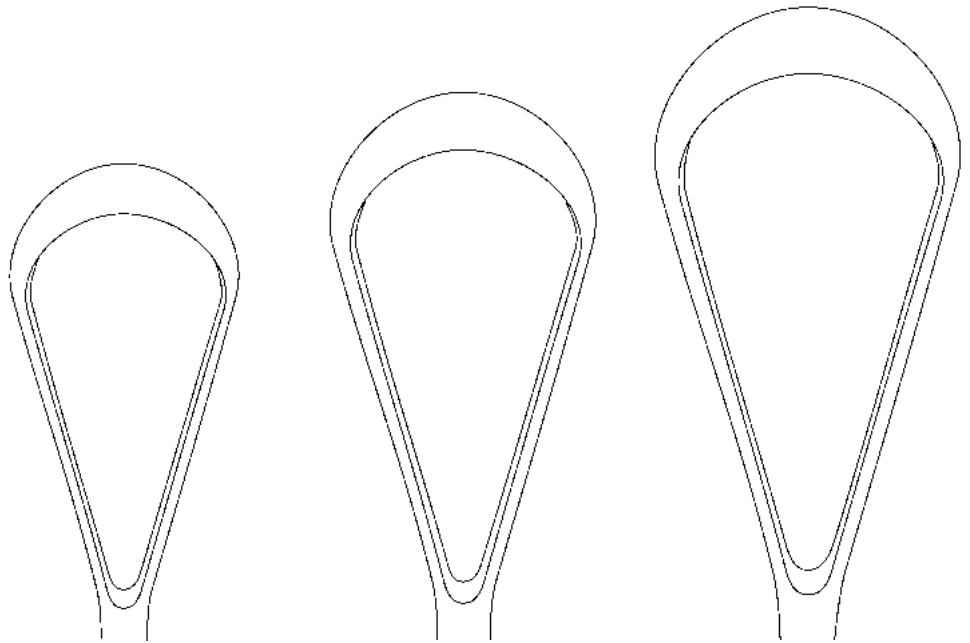

Fig. 10, 20mm

	Fig. 7, 15mm	Fig. 8, 16mm	Fig. 9, 19mm	Fig. 10, 20mm
rigid, sharp	350-620-015	350-620-016	350-620-019	350-620-020
rigid, blunt	350-619-015	350-619-016	350-619-019	350-619-020
malleable, sharp	350-621-015	350-621-016	350-621-019	350-621-020
malleable, blunt	350-622-015	350-622-016	350-622-019	350-622-020



### BUMM

Uterus Curette, 300mm, 11<sup>7/8</sup>"

Fig. 1, 30mm

Fig. 2, 35mm

Fig. 3, 40mm

rigid, sharp

350-920-300

350-920-350

350-920-400

rigid, blunt

350-926-300

350-926-350

350-926-400

malleable, sharp

350-928-300

350-928-350

350-928-400

malleable, blunt

350-929-300

350-929-350

350-929-400

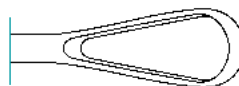
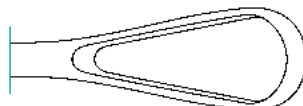

### BLAKE

Biopsy Curette, sharp/blunt

270mm, 10<sup>2/3</sup>"

350-614-270

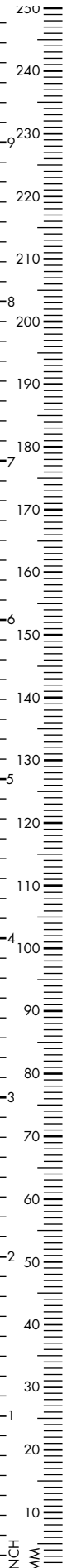



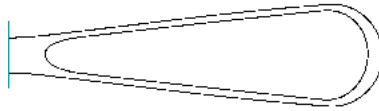

**WALLICH**

Placenta / Ovum Scoop

420mm, 16<sup>1</sup>/<sub>2</sub>"

340-510-420

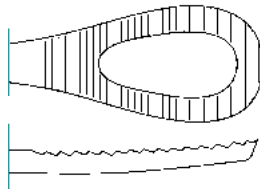

**PESTALOZZA**

Uterus Curette

300mm, 11<sup>7</sup>/<sub>8</sub>"

340-500-300



**GREENE**

Uterus Curette, 280mm, 11"

10mm

350-365-010

12mm

350-365-012

14mm

350-365-014



**MILAN**

Curette

290mm, 11<sup>1</sup>/<sub>2</sub>"

350-605-007



**FAURE**

Biopsy Forceps

210mm, 8<sup>1</sup>/<sub>4</sub>"

350-843-210



**SCHUBERT**

Biopsy Forceps

210mm, 8<sup>1</sup>/<sub>4</sub>"

350-844-210

290mm, 11<sup>1</sup>/<sub>2</sub>"

350-844-290

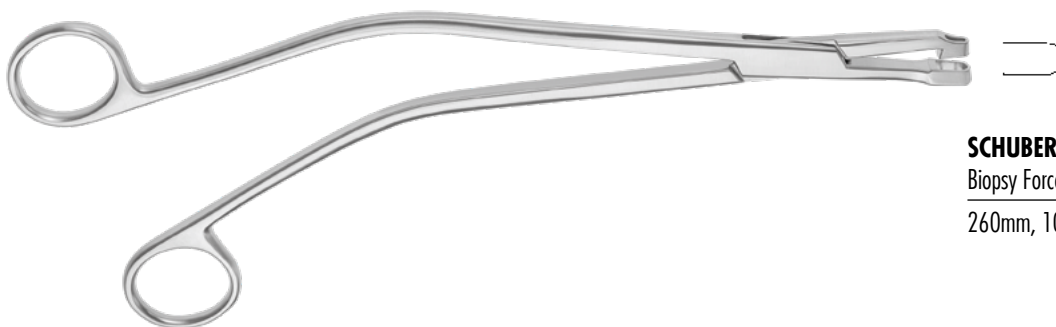

**SCHUBERT**

Biopsy Forceps

260mm, 10<sup>1</sup>/<sub>4</sub>"

350-847-260

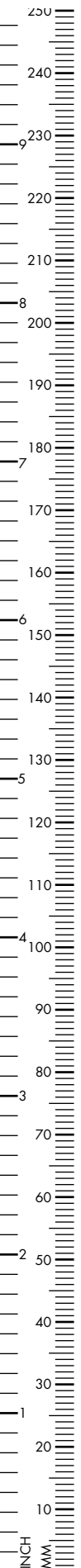

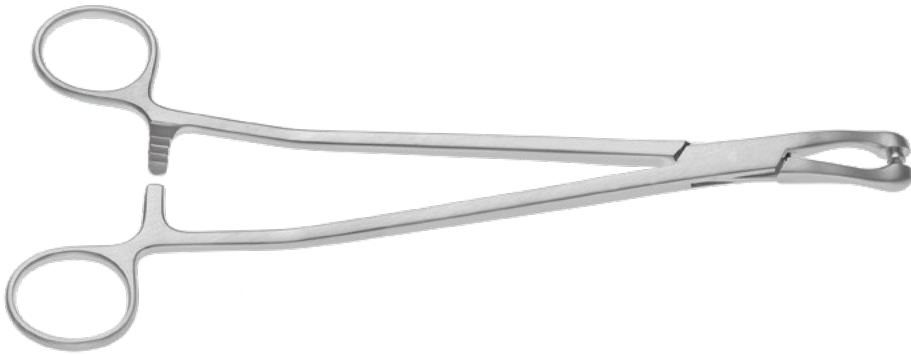

**THOMS GAYLOR**

Biopsy Forceps, curved

220mm, 8<sup>2</sup>/<sub>3</sub>"

350-857-220

240mm, 9<sup>1</sup>/<sub>2</sub>"

350-857-240

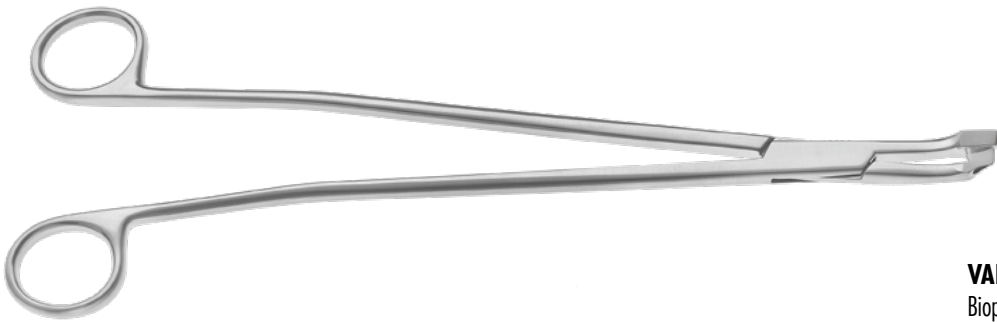

**VAN DOREN**

Biopsy Forceps

267mm, 10<sup>1</sup>/<sub>2</sub>"

350-855-267

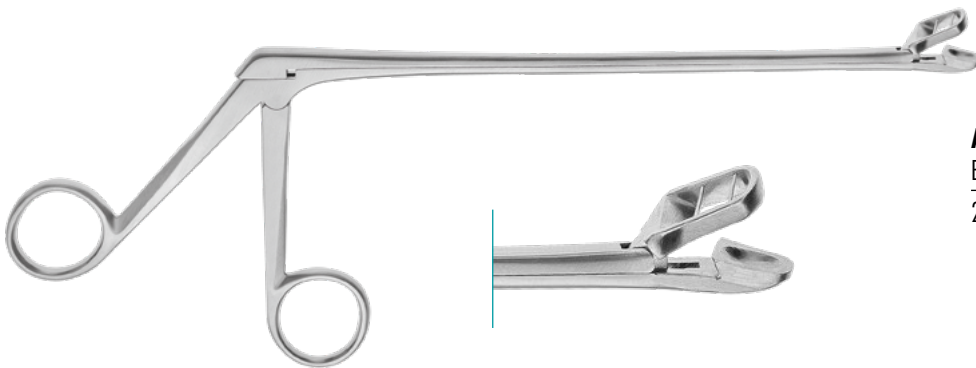

**ALEXANDER**

Biopsy Forceps

280mm, 11"

310-735-280

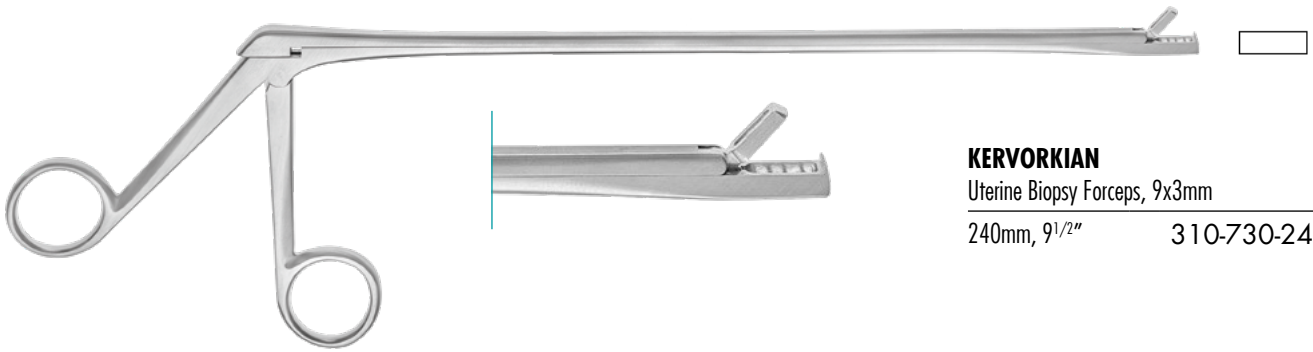

**KERVORKIAN**

Uterine Biopsy Forceps, 9x3mm

240mm, 9<sup>1</sup>/<sub>2</sub>" 310-730-240

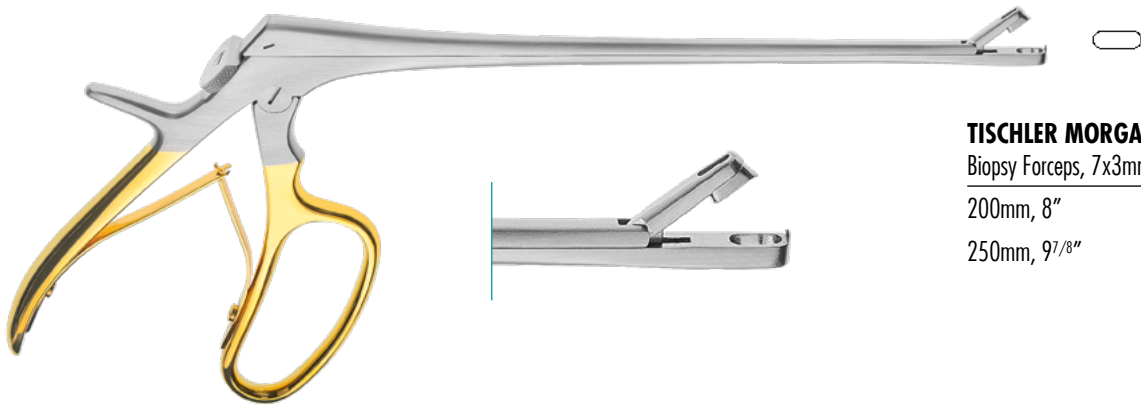

**TISCHLER MORGAN**

Biopsy Forceps, 7x3mm

200mm, 8" 310-733-001

250mm, 9<sup>7</sup>/<sub>8</sub>" 310-735-001

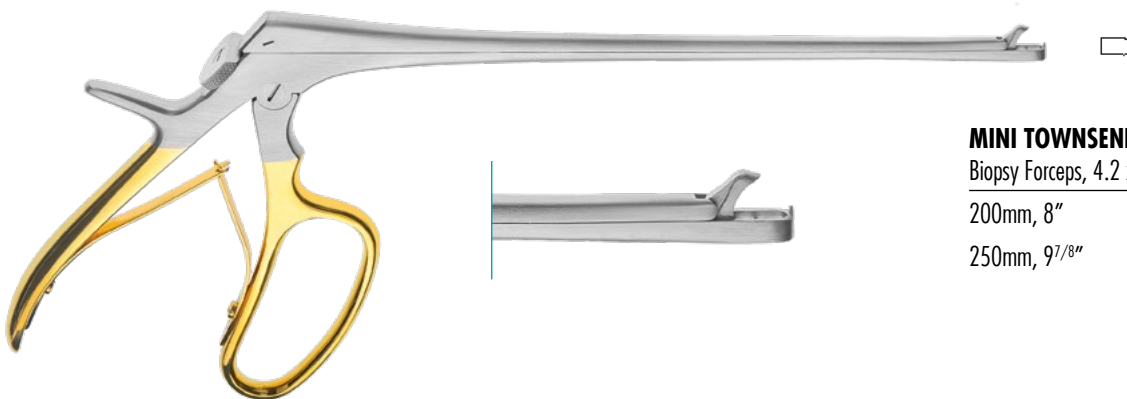

**MINI TOWNSEND**

Biopsy Forceps, 4.2 x 2.3mm jaw

200mm, 8" 310-733-002

250mm, 9<sup>7</sup>/<sub>8</sub>" 310-735-002

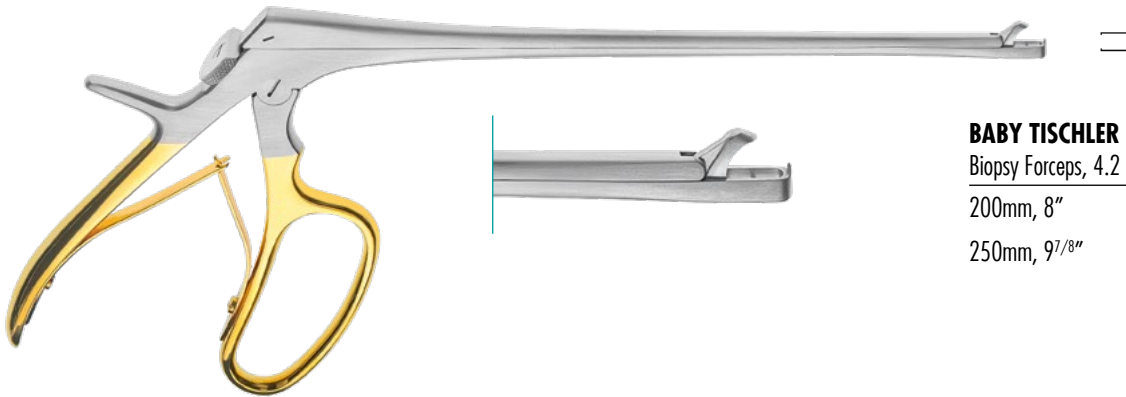

### BABY TISCHLER

Biopsy Forceps, 4.2 x 2.3mm jaw

200mm, 8" 310-733-003

250mm, 9<sup>7</sup>/<sub>8</sub>" 310-735-003

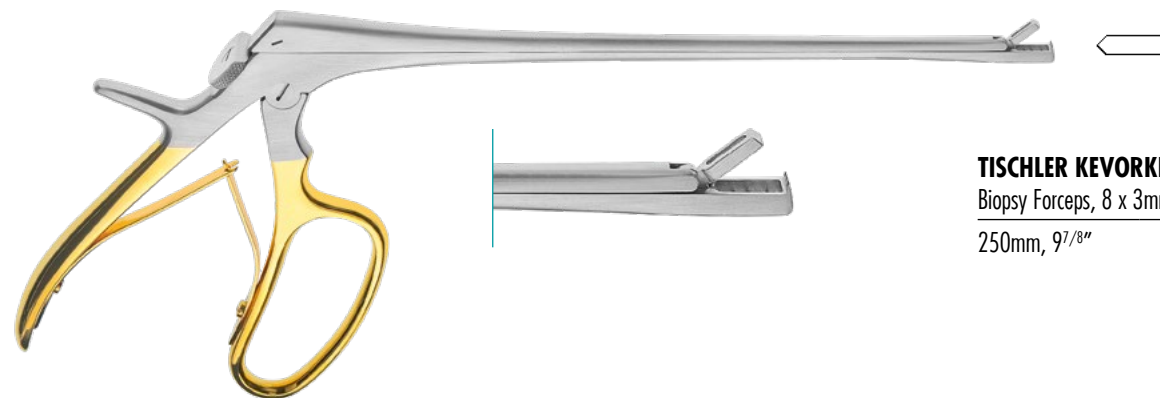

### TISCHLER KEVORKIAN

Biopsy Forceps, 8 x 3mm jaw

250mm, 9<sup>7</sup>/<sub>8</sub>" 310-731-250

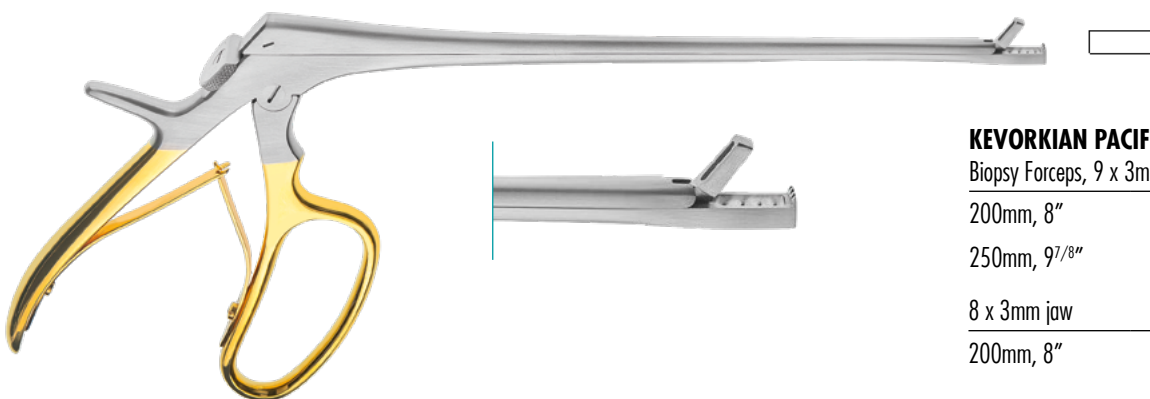

### KEVORKIAN PACIFIC

Biopsy Forceps, 9 x 3mm jaw

200mm, 8" 310-732-200

250mm, 9<sup>7</sup>/<sub>8</sub>" 310-732-250

8 x 3mm jaw

200mm, 8" 310-731-200



Detachable Biopsy Forceps "Roto Fit"



### UNI TISCHLER

Insert only, 3 x 7mm, 230mm, 9"

A straight	310-800-100
B angled up	310-801-100
C angled down	310-802-100

complete instrument with handle

A straight	310-800-000
B angled up	310-801-000
C angled down	310-802-000

### UNI TOWNSEND

Insert only, 2.3 x 7mm, 230mm, 9"

D straight	310-803-100
E angled up	310-804-100
F angled down	310-805-100

complete instrument with handle

D straight	310-803-000
E angled up	310-804-000
F angled down	310-805-000

### UNI KERVOKIAN

Insert only, 3 x 9mm, 230mm, 9"

G straight	310-806-100
------------	-------------

complete instrument with handle

G straight	310-806-000
------------	-------------

### UNI OVAL

Insert only, 3 x 5.5mm, 230mm, 9"

H straight	310-807-100
------------	-------------

complete instrument with handle

H straight	310-807-000
------------	-------------

I Handle only

310-800-600

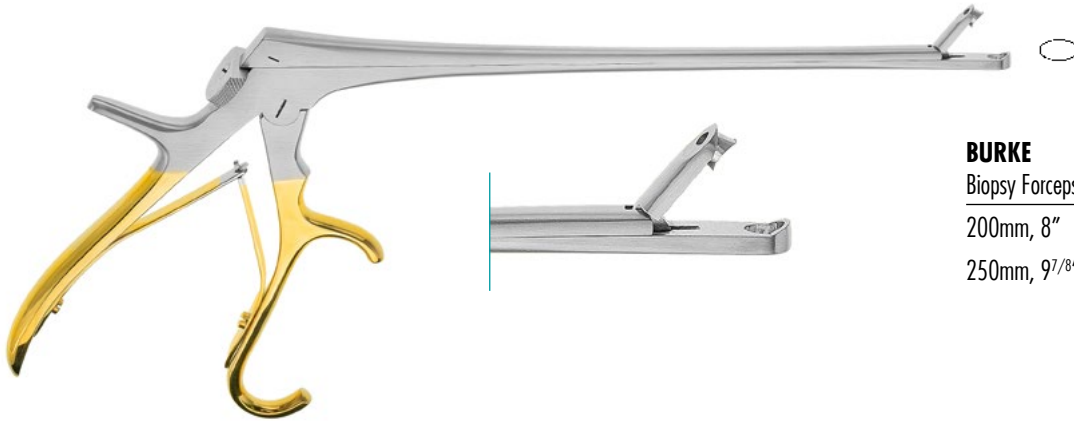

### BURKE

Biopsy Forceps, 5 x 3mm jaw

200mm, 8"	310-732-000
250mm, 9 <sup>7</sup> / <sub>8</sub> "	310-735-004

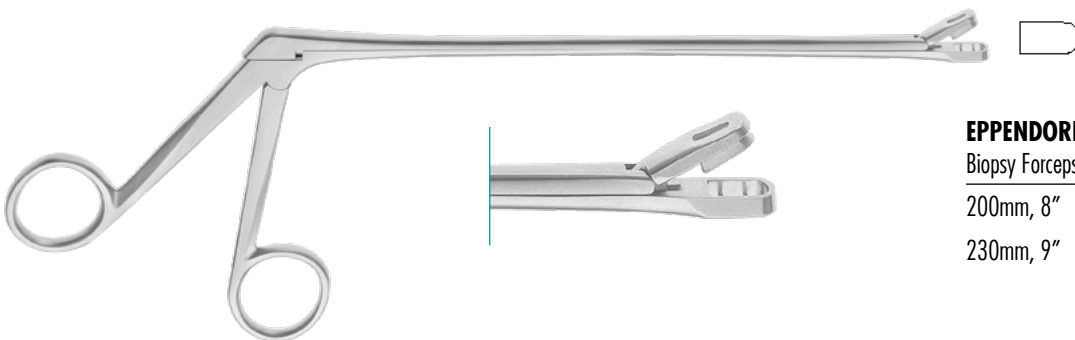

### EPPENDORFER

Biopsy Forceps, 4x8mm

200mm, 8"	310-760-200
230mm, 9"	310-760-230

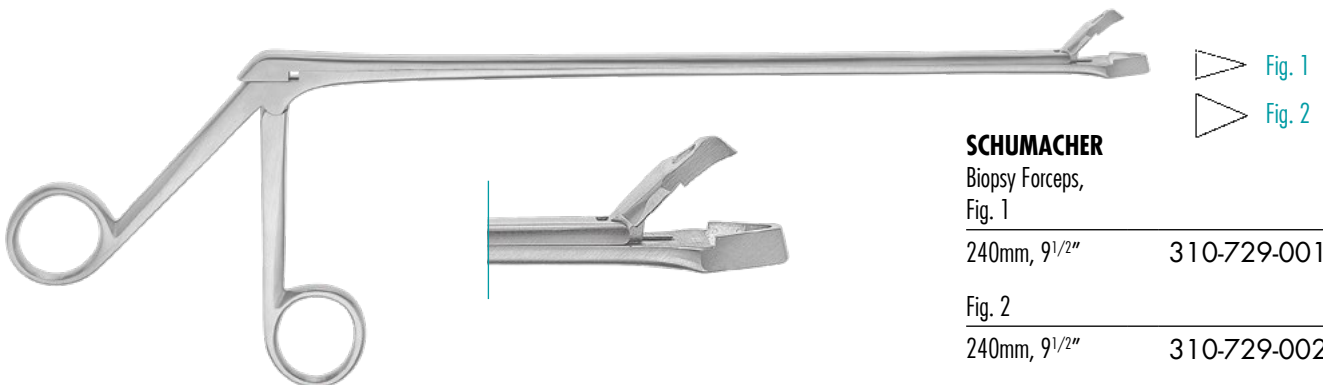

### SCHUMACHER

Biopsy Forceps,  
Fig. 1

240mm, 9 <sup>1</sup> / <sub>2</sub> "	310-729-001
--	-------------

Fig. 2

240mm, 9 <sup>1</sup> / <sub>2</sub> "	310-729-002
--	-------------

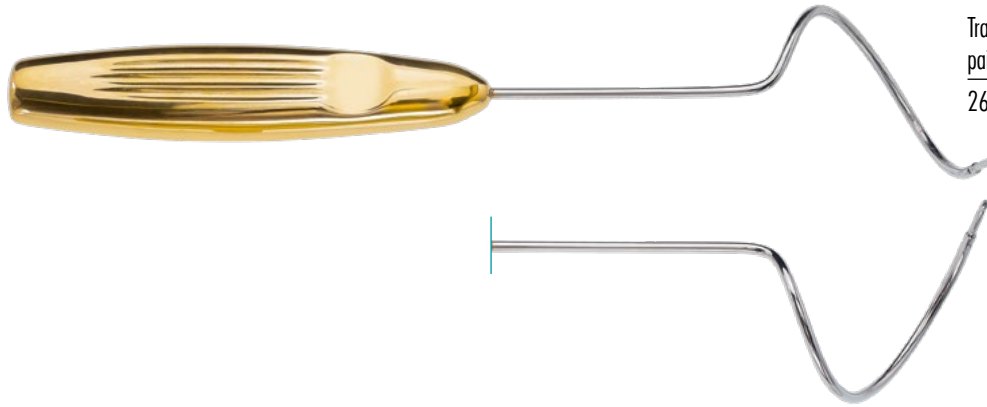

Transobturator Sling needle  
pair of right and left curved

260mm, 10<sup>1</sup>/<sub>4</sub>" 350-101-260



**MIYAZAKI**

Ligature Carrier, large hook 0.75"

200mm, 8" shaft 180-160-000



**MIYAZAKI**

Speculum with notch

180-160-010



**SIMS**

Uterine Probe, graduated, Ø 4mm,  
330mm, 13"

rigid 350-395-320

malleable 350-396-320



**SIMPSON**

Uterine Probe, malleable, Ø 4mm

290mm, 11<sup>1</sup>/<sub>2</sub>" 350-396-290

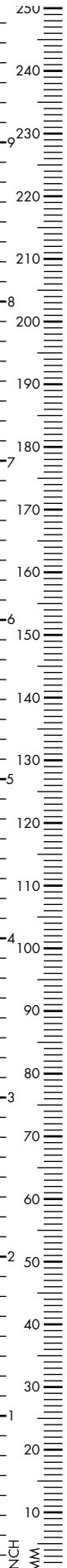





Uterine manipulator, complete set  
(350-660-111 - 350-660-116)

350-660-100



Adaptor Ø 8 x 80 mm

350-660-111



Adaptor Ø 10 x 100 mm

350-660-112



Adaptor Ø 3 x 45 mm

350-660-113



Adaptor Ø 3 x 55 mm

350-660-114



Adaptor Ø 3.2 x 35 mm

350-660-115



Adaptor Ø 3.2 x 45 mm

350-660-116



### COHEN

Uterus Cannula  
complete with 2 interchangeable acorns

350-750-000

#### Acorns

small 350-750-001

large 350-750-002

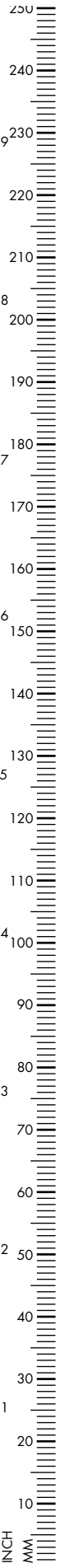

### HEGAR

Uterine Dilator, double-ended

1.0/2.0mm	350-382-020	15.0/16.0mm	350-382-160
3.0/4.0mm	350-382-040	17.0/18.0mm	350-382-180
5.0/6.0mm	350-382-060	19.0/20.0mm	350-382-200
7.0/8.0mm	350-382-080	21.0/22.0mm	350-382-220
9.0/10.0mm	350-382-100	23.0/24.0mm	350-382-240
11.0/12.0mm	350-382-120	25.0/26.0mm	350-382-260
13.0/14.0mm	350-382-140		

Set\*, 8 sizes from 3/4 to 17/18 mm  
in canvas roll

350-383-001



### HEGAR

Uterine Dilator with slope handle

1.0mm	350-380-010	12.5mm	350-380-125	24.0mm	350-380-240
1.5mm	350-380-015	13.0mm	350-380-130	25.0mm	350-380-250
2.0mm	350-380-020	13.5mm	350-380-135	26.0mm	350-380-260
2.5mm	350-380-025	14.0mm	350-380-140	27.0mm	350-380-270
3.0mm	350-380-030	14.5mm	350-380-145	28.0mm	350-380-280
3.5mm	350-380-035	15.0mm	350-380-150	29.0mm	350-380-290
4.0mm	350-380-040	15.5mm	350-380-155	30.0mm	350-380-300
4.5mm	350-380-045	16.0mm	350-380-160		
5.0mm	350-380-050	16.5mm	350-380-165		
5.5mm	350-380-055	17.0mm	350-380-170		
6.0mm	350-380-060	17.5mm	350-380-175		
6.5mm	350-380-065	18.0mm	350-380-180		
7.0mm	350-380-070	18.5mm	350-380-185		
7.5mm	350-380-075	19.0mm	350-380-190		
8.0mm	350-380-080	19.5mm	350-380-195		
8.5mm	350-380-085	20.0mm	350-380-200		
9.0mm	350-380-090	21.0mm	350-380-210		
9.5mm	350-380-095	22.0mm	350-380-220		
10.0mm	350-380-100	23.0mm	350-380-230		
10.5mm	350-380-105				
11.0mm	350-380-110				
11.5mm	350-380-115				
12.0mm	350-380-120				

\* illustration does not show the complete set



### PRATT

Uterine Dilators, French Scale 10<sup>3/8</sup>"

13 - 15	350-392-015
17 - 19	350-392-019
21 - 23	350-392-023
25 - 27	350-392-027
29 - 31	350-392-031
33 - 35	350-392-035
37 - 39	350-392-039
41 - 43	350-392-043

Set of 8 pieces in canvas roll\*

350-392-000



### HANK

Uterine Dilator

Fig. 9/10 4.5/5.0mm	350-390-010	Fig. 15/16 7.5/8.0mm	350-390-016
Fig. 11/12 5.5/6.0mm	350-390-012	Fig. 17/18 8.5/9.0mm	350-390-018
Fig. 13/14 6.5/7.0mm	350-390-014	Fig. 19/20 9.5/10.0mm	350-390-020

Set, 6 pieces in canvas roll\*

350-391-002

\* illustration does not show the complete set



### JACKSON

Vaginal Speculum

75 x 38mm	350-206-001
90 x 38mm	350-206-002
100 x 38mm	350-206-003



### EASTMAN

Vaginal Speculum

75 x 38mm	350-207-001
90 x 38mm	350-207-002
100 x 38mm	350-207-003



### DOYEN

Vaginal Speculum, slightly concave

55 x 35mm	350-290-001
85 x 35mm	350-290-002
115 x 35mm	350-290-003
55 x 45mm	350-290-004
85 x 45mm	350-290-005
115 x 45mm	350-290-006
160 x 45mm	350-290-007
55 x 60mm	350-290-008
85 x 60mm	350-290-009
115 x 60mm	350-290-010
160 x 60mm	350-290-011



**HEANEY**

Retractor, 270mm, 10<sup>2</sup>/<sub>3</sub>"

73 x 28mm	170-459-001
45 x 28mm	170-459-002
82 x 28mm	170-459-003

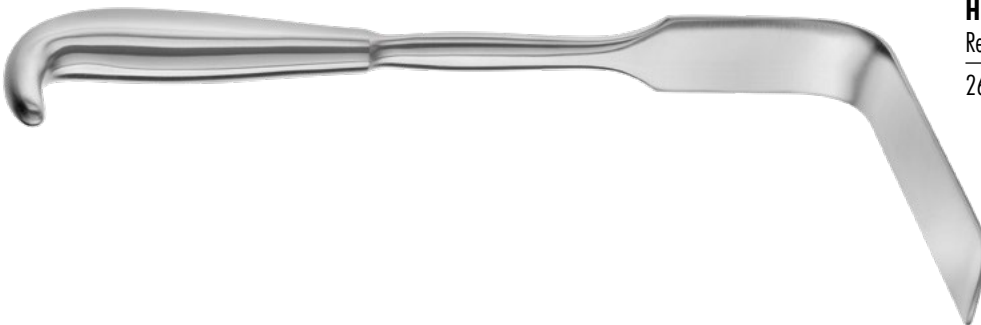

**HEANEY SIMON**

Retractor with horn handle

260mm, 10 <sup>1</sup> / <sub>4</sub> "	170-460-260
---	-------------



**BREISKY**

Vaginal Speculum

100 x 20mm	350-320-020	130 x 20mm	350-322-020
100 x 25mm	350-320-025	130 x 25mm	350-322-025
100 x 30mm	350-320-030	130 x 30mm	350-322-030
100 x 35mm	350-320-035	130 x 35mm	350-322-035
100 x 40mm	350-320-040	130 x 40mm	350-322-040
		155 x 40mm	350-324-040

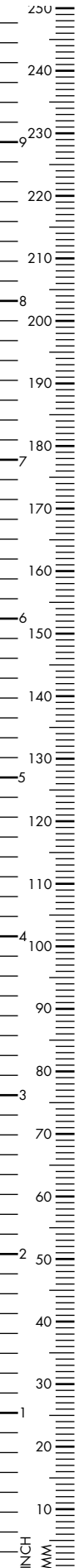

### SEIDL

Speculum for children  
170mm, 6<sup>2</sup>/<sub>3</sub>"

80 x 8mm	350-254-001
80 x 10mm	350-254-002
90 x 14mm	350-254-003



### KRISTELLER

Vaginal Speculum, for children

70 x 15mm	350-210-000
for adults	
70 x 27mm	350-210-001
80 x 30mm	350-210-002
90 x 36mm	350-210-003



### KRISTELLER

Retractor

Fig. 0	70 x 10mm	350-211-000
Fig. 1	75 x 23mm	350-211-001
Fig. 2	85 x 26mm	350-211-002
Fig. 3	100 x 32mm	350-211-003



### KRISTELLER

Vaginal Speculum Set

Fig. 0	350-212-000
Fig. 1	350-212-001
Fig. 2	350-212-002
Fig. 3	350-212-003

**KRISTELLER**

Vaginal Speculum

Fig. 1	110 x 27mm	350-230-001
Fig. 2	110 x 30mm	350-230-002
Fig. 3	110 x 36mm	350-230-003

**KRISTELLER**

Retractor

Fig. 1	115 x 18mm	350-231-001
Fig. 2	115 x 22mm	350-231-002
Fig. 3	115 x 28mm	350-231-003

**KRISTELLER**

Vaginal Speculum Set

Fig. 1	350-232-001
Fig. 2	350-232-002
Fig. 3	350-232-003



### SIMS

Vaginal Speculum, small

65 x 25mm	350-200-001
-----------	-------------

medium

70 x 30mm	350-200-002
-----------	-------------

large

85 x 35mm	350-200-003
-----------	-------------

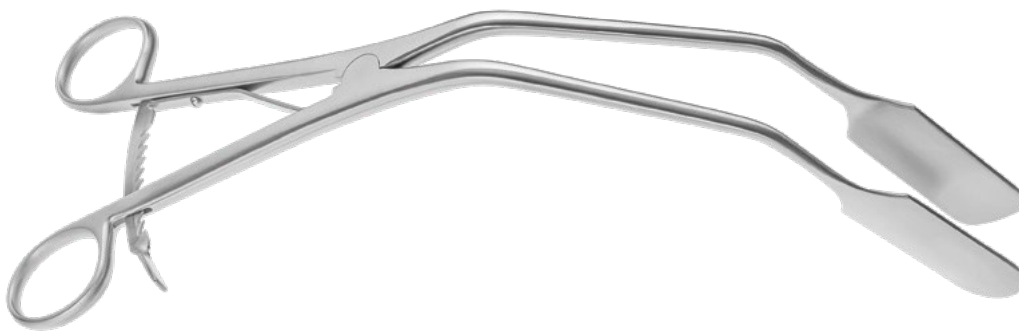

### RZ

Lateral Retractor

60 x 22mm	350-340-000
-----------	-------------



### KOGAN

Endospeculum, screw ratchet, 240mm, 9<sup>1/2</sup>"

5mm	350-361-001
-----	-------------

4mm	350-361-002
-----	-------------

3mm	350-361-003
-----	-------------

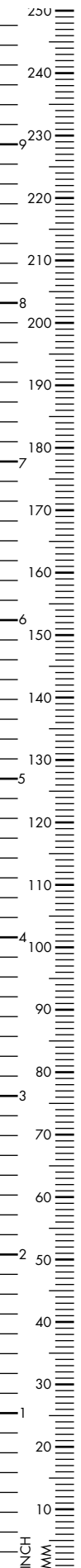





### GRAVE

Vaginal Speculum

75 x 20mm	350-130-001
95 x 35mm	350-130-002
115 x 35	350-130-003



### PEDERSON

Vaginal Speculum

75 x 13mm	350-140-001
100 x 22mm	350-140-002
120 x 25mm	350-140-003



### CUSCO

Vaginal Speculum

75 x 32mm	350-100-001
85 x 35mm	350-100-002
100 x 35mm	350-100-003



### CUSCO

Vaginal Speculum, Swiss pattern

80 x 22mm	350-102-001
100 x 25mm	350-102-002
105 x 27mm	350-102-003



### SEMN

Vaginal Speculum, 100mm blade

17-20mm wide blade	350-120-001
25-30mm wide blade	350-120-002



### COLLIN

Vaginal Speculum, detachable

65 x 20mm	350-110-001
85 x 30mm	350-110-002
100 x 35mm	350-110-003
100 x 40mm	350-110-004

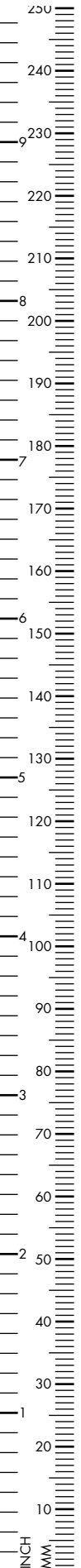



### AUVARD

Vaginal Speculum, fixed weight,  
1.14kg, 45° angled

70 x 42mm	350-309-000
83 x 38mm	350-310-000
102 x 45mm	350-311-000



### STEINER ANVARD

Vaginal Speculum, fixed weight, 1.14kg

150 x 34mm	350-311-140
------------	-------------



### SCHERBACK

Vaginal Speculum, complete set  
incl. weight 400g, handle, blades Fig. 1 - 5

350-300-000

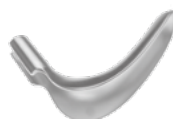

Blades

80x30mm	330-301-001
85x35mm	330-301-002
85x40mm	330-301-003
55x40mm	330-301-004
70x45mm	330-301-005



Weight

400g	350-302-001
800g	350-302-002

Handle

350-303-000



### GELPI

Perineal Retractor, pediatric size

90mm, 3<sup>1</sup>/<sub>2</sub>" 170-802-090

110mm, 4<sup>1</sup>/<sub>3</sub>" 170-802-110

135mm, 5<sup>1</sup>/<sub>3</sub>" 170-802-135



### GELPI

Perineal Retractor

180mm, 7" 170-802-180

with ball stops

190mm, 7<sup>1</sup>/<sub>2</sub>" 170-803-180



### RIGBY

Perineal Retractor, 21x70mm blades

180mm, 7" 170-806-180

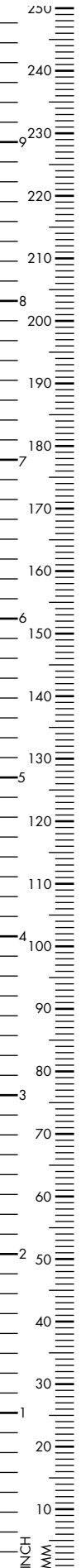



**O'SULLIVAN O'CONNOR**

Vaginal Retractor Set

350-336-000



**RIGBY**

Perineal Retractor, 21x70mm blades

180mm, 7"

170-806-180

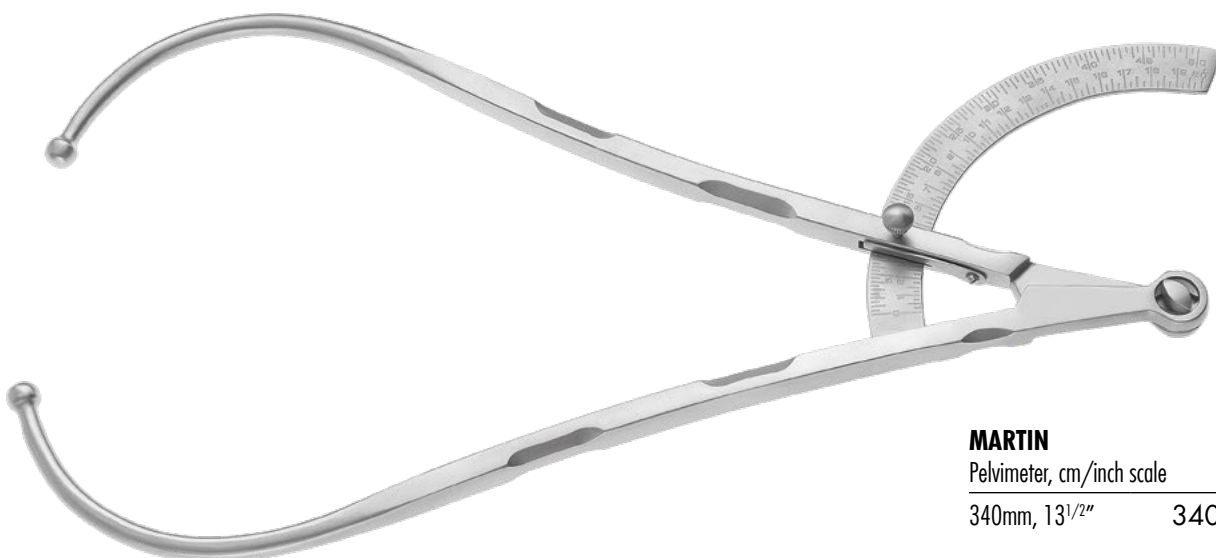

**MARTIN**

Pelvimeter, cm/inch scale

340mm, 13<sup>1</sup>/<sub>2</sub>"

340-103-340



### GRAVE

Vaginal Speculum, with suction tube,  
A coated

Fig. 1 75 x 20mm 350-131-001

Fig. 2 95 x 35mm 350-131-002

Fig. 3 115 x 35mm 350-131-003

B blackened

Fig. 1 75 x 20mm 350-137-001

Fig. 2 95 x 35mm 350-137-002

Fig. 3 115 x 35mm 350-137-003

### PEDERSON

Vaginal Speculum, with suction tube,  
coated

Fig. 1 75 x 13mm 350-141-001

Fig. 2 100 x 22mm 350-141-002

Fig. 3 120 x 25mm 350-141-003

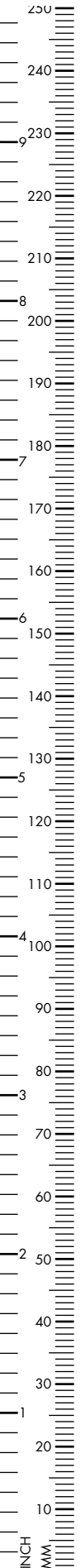



## VUMAR

Vaginal Speculum, with evacuation tube,  
blue coated

medium	350-510-070
large	350-512-070



## COLLIN

Vaginal Speculum, with evacuation tube,  
blue coated

100 x 40mm	350-111-003
110 x 45mm	350-511-004

