

# THORACIC & VASCULAR SURGERY

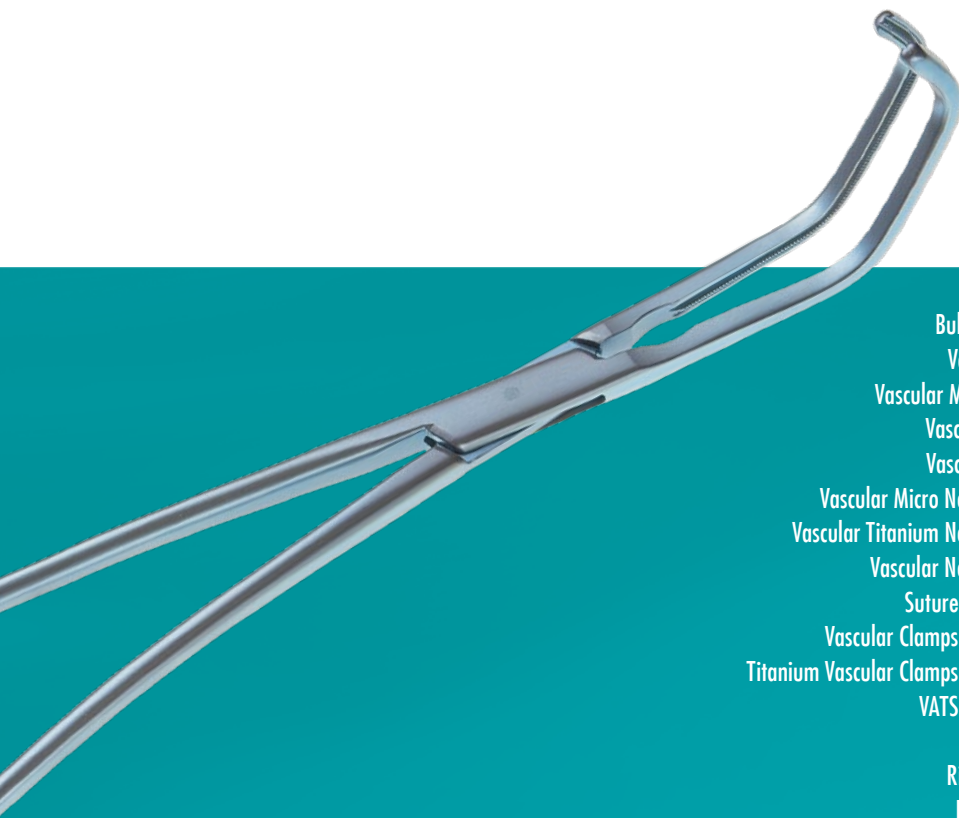

Bulldog Clamps  
Vessel Clamps  
Vascular Micro Scissors  
Vascular Scissors  
Vascular Forceps  
Vascular Micro Needle Holder  
Vascular Titanium Needle Holder  
Vascular Needle Holder  
Suture Instruments  
Vascular Clamps and Forceps  
Titanium Vascular Clamps and Forceps  
VATS Instruments  
Rib Shears  
Rib Raspatory  
Rib Spreader  
Phlebectomy Instruments  
Vessel Probes  
Dilators  
Intima Instruments  
Tourniquets  
Punches  
Probes and Retractors

Ss



### DIEFFENBACH

Bulldog Clamp, stainless steel,  
extra delicate serrations, straight

35mm	140-114-035
40mm	140-114-040
50mm	140-114-050
60mm	140-114-060
curved	
35mm	140-115-035
40mm	140-115-050
50mm	140-115-055
60mm	140-115-060

Ss



### JOHNS HOPKINS

Bulldog Clamp, stainless steel, straight

38mm	140-050-038
48mm	140-050-050
56mm	140-050-057
63mm	140-050-063
70mm	140-050-070
80mm	140-050-076
90mm	140-050-090
curved	
38mm	140-051-038
48mm	140-051-050
56mm	140-051-057
63mm	140-051-063
70mm	140-051-070
80mm	140-051-076
90mm	140-051-090

Suitable for Applying Forceps: 140-152-230

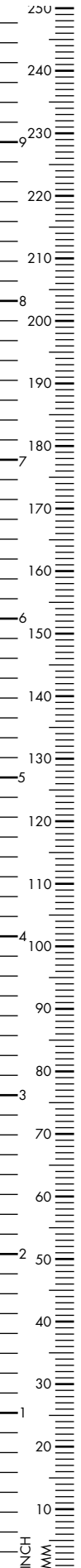





### CLOSING PRESSURE

V (Vein): 110g (±10g)  
A (Artery): 220g (±10g)

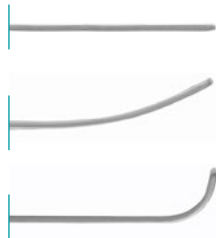

## Ti

### MINI GLOVER

Bulldog Clamp, Titanium

very delicate serrations, straight

(V) 30mm/9mm	140-116-030
(A) 30mm/9mm	140-116-130
(V) 35mm/13mm	140-116-035
(A) 35mm/13mm	140-116-135
(V) 40mm/14mm	140-116-040
(A) 40mm/14mm	140-116-140
(V) 50mm/23mm	140-116-050
(A) 50mm/23mm	140-116-150

slightly curved

(V) 30mm/9mm	140-117-030
(A) 30mm/9mm	140-117-130
(V) 35mm/13mm	140-117-035
(A) 35mm/13mm	140-117-135
(V) 40mm/14mm	140-117-040
(A) 40mm/14mm	140-117-140
(V) 50mm/23mm	140-117-050
(A) 50mm/23mm	140-117-150

strongly curved

(V) 30mm/9mm	140-118-030
(A) 30mm/9mm	140-118-130
(V) 35mm/13mm	140-118-035
(A) 35mm/13mm	140-118-135
(V) 40mm/14mm	140-118-040
(A) 40mm/14mm	140-118-140
(V) 50mm/23mm	140-118-050
(A) 50mm/23mm	140-118-150

## Ss

### MINI GLOVER

Bulldog Clamp, Stainless Steel

very delicate serrations, straight

(V) 30mm/9mm	140-130-030
(A) 30mm/9mm	140-130-130
(V) 35mm/13mm	140-130-035
(A) 35mm/13mm	140-130-135
(V) 40mm/14mm	140-130-040
(A) 40mm/14mm	140-130-140
(V) 50mm/23mm	140-130-050
(A) 50mm/23mm	140-130-150

slightly curved

(V) 30mm/9mm	140-131-030
(A) 30mm/9mm	140-131-130
(V) 35mm/13mm	140-131-035
(A) 35mm/13mm	140-131-135
(V) 40mm/14mm	140-131-040
(A) 40mm/14mm	140-131-140
(V) 50mm/23mm	140-131-050
(A) 50mm/23mm	140-131-150

strongly curved

(V) 30mm/9mm	140-132-030
(A) 30mm/9mm	140-132-130
(V) 35mm/13mm	140-132-035
(A) 35mm/13mm	140-132-135
(V) 40mm/14mm	140-132-040
(A) 40mm/14mm	140-132-140
(V) 50mm/23mm	140-132-050
(A) 50mm/23mm	140-132-150

Suitable for Applying Forceps: 140-130-240

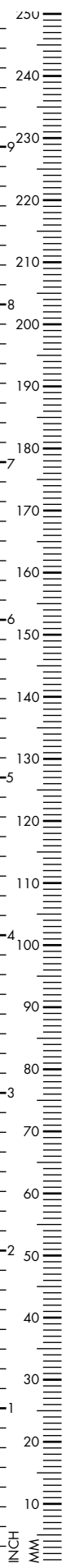

### DEBAKEY

Bulldog Clamp, stainless steel,  
delicate atraumatic serrations, straight

75mm	140-120-075
85mm	140-120-085
100mm	140-120-105
120mm	140-120-120
curved	
75mm	140-119-075
85mm	140-119-085
100mm	140-119-105
120mm	140-119-120

### COOLEY

Bulldog Clamp, stainless steel,  
Cooley serrations, straight

75mm	290-440-075
85mm	290-440-085
100mm	290-440-100
120mm	290-440-120
curved	
75mm	290-441-075
85mm	290-441-085
100mm	290-441-100
120mm	290-441-120

Suitable for Applying Forceps: 140-152-250



### DEBAKEY DIETHRICH

Micro Coronary Bulldog Clamp, stainless steel,  
atraumatic serrations, straight

10mm/45mm	290-120-010
14mm/50mm	290-120-014
20mm/60mm	290-120-020

### curved

10mm/45mm	290-122-010
14mm/50mm	290-122-014
20mm/60mm	290-122-020

### CLOSING PRESSURE

Debakey: 180g (±10g)  
Diethrich: 50g (±10g)

### angled

10mm/35mm	290-121-010
14mm/45mm	290-121-014
20mm/60mm	290-121-020



### DIETHRICH

Micro Coronary Bulldog Clamp, stainless steel,  
straight

8mm/45mm	140-125-080
12mm/50mm	140-125-120
20mm/60mm	140-125-200

### curved

8mm/45mm	140-122-080
12mm/50mm	140-122-120
20mm/60mm	140-122-200

### angled

8mm/35mm	140-121-080
12mm/45mm	140-121-120
20mm/60mm	140-121-200

Ss

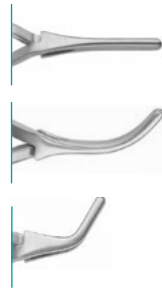

### DIETRICH

Micro Coronary Bulldog Clamp, stainless steel, without serrations, straight

8mm/45mm	140-008-045
12mm/50mm	140-012-050
20mm/60mm	140-020-060

curved

8mm/45mm	140-208-045
12mm/50mm	140-212-050
20mm/60mm	140-220-060

angled

8mm/35mm	140-108-045
12mm/45mm	140-112-050
20mm/60mm	140-120-060

Ss

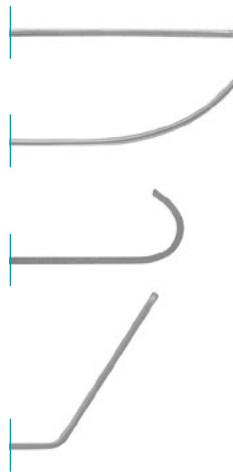

### WELDON

Bulldog Clamp, stainless steel, very delicate serrations, straight

35mm	140-013-035
45mm	140-022-045
slightly curved	
35mm	140-015-035
45mm	140-023-045

strongly curved

35mm	140-016-035
45mm	140-024-045

angled

35mm	140-017-035
45mm	140-025-045

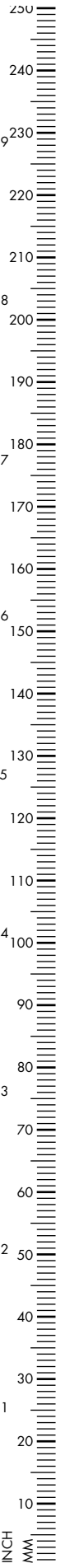

**Ss**



**CLOSING PRESSURE**  
adjustable



### DEBAKEY GLOVER

Bulldog Clamp, stainless steel,  
delicate atraumatic serrations, straight

20mm/60mm	140-130-060
30mm/75mm	140-130-070
43mm/90mm	140-130-090
56mm/110mm	140-130-110

curved

20mm/60mm	140-131-060
30mm/75mm	140-131-070
43mm/90mm	140-131-090
56mm/110mm	140-131-110

angled

27mm/55mm	140-132-060
-----------	-------------



### COOLEY GLOVER

Bulldog Clamp, stainless steel,  
Cooley serrations, straight

20mm/60mm	290-432-060
30mm/75mm	290-432-075
43mm/90mm	290-432-090
56mm/110mm	290-432-110

curved

20mm/60mm	290-433-060
30mm/75mm	290-433-075
43mm/90mm	290-433-090
56mm/110mm	290-433-110

**CLOSING PRESSURE**  
adjustable

**Ss**

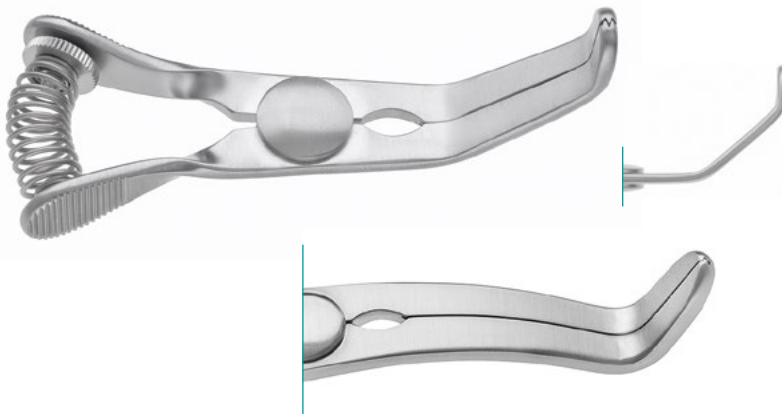

### DEBAKEY GLOVER SATINSKY

Bulldog Clamp, stainless steel,  
delicate atraumatic serrations,  
double angulation

38mm/70mm	140-133-060
63mm/100mm	140-133-100

Ss

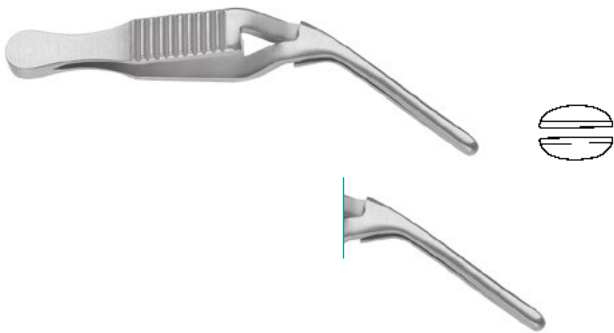

### HESS

Bulldog Clamp, stainless steel,  
delicate serrations, angled

20mm jaw	140-056-020
30mm jaw	140-056-030

Ss

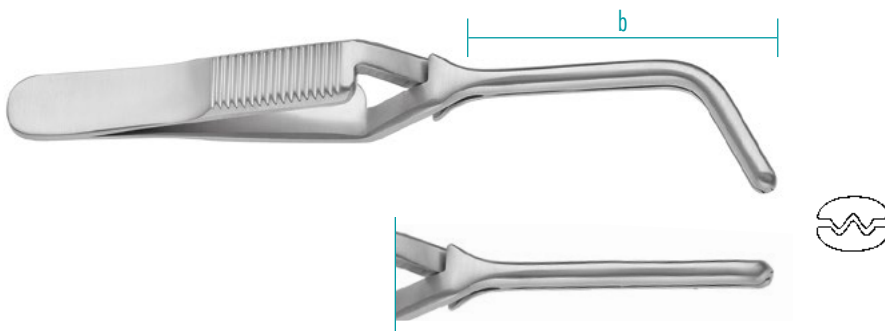

### DEBAKEY GREGORY SOFT

Bulldog Clamp, stainless steel,  
delicate atraumatic serrations, straight

Total length: 90mm b = 27mm	140-015-090
Total length: 110mm b = 44mm	140-015-110
angled	
Total length: 90mm b = 55mm	140-014-090
Total length: 110mm b = 60mm	140-014-110

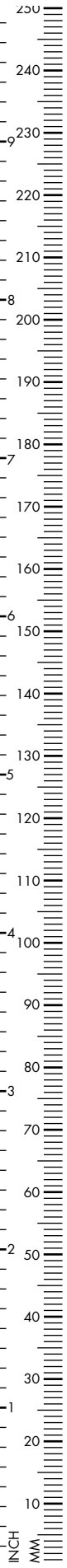

**Ss**

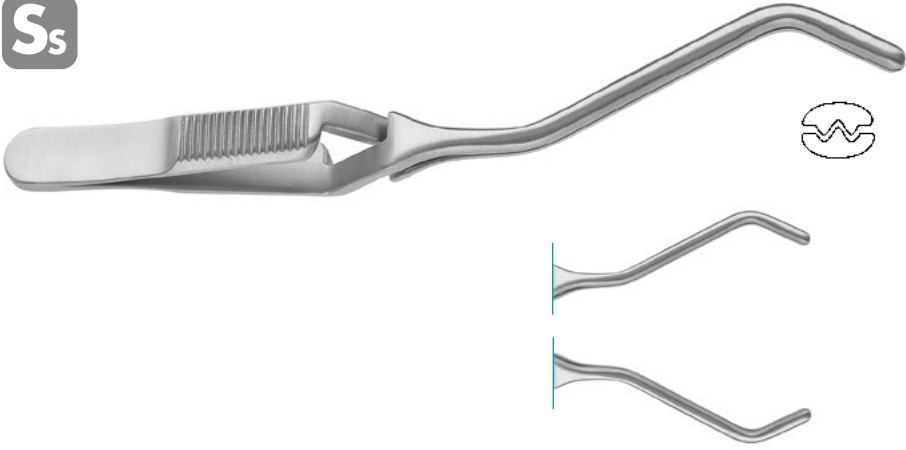

**DEBAKEY GREGORY**

Bulldog Clamp, stainless steel,  
delicate atraumatic serrations, left angled

Total length: 110mm    140-014-025

right angled

Total length: 110mm    140-114-025

**Ss**



**DEBAKEY SANTULLI**

Bulldog Clamp, stainless steel,  
delicate atraumatic serrations, curved

Total length: 70mm    140-135-070

Ss

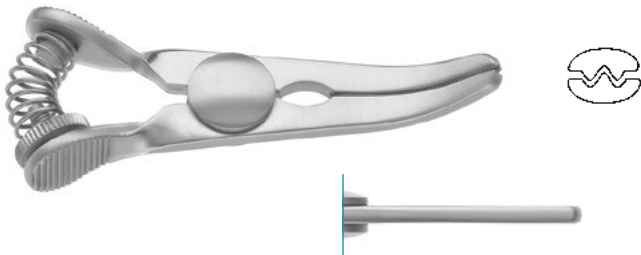

**CLOSING PRESSURE**

adjustable

### DEBAKEY GLOVER DELICATE

Bulldog Clamp, stainless steel,  
extra delicate atraumatic serrations, straight

20mm/50mm

290-410-050

Ss

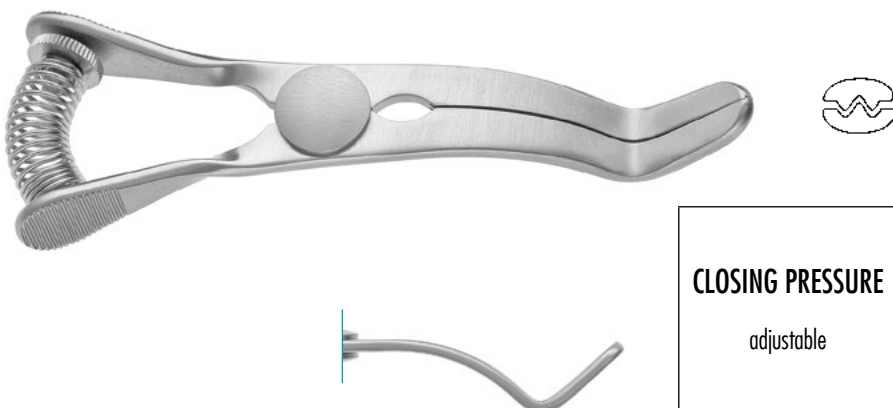

**CLOSING PRESSURE**

adjustable

### DEBAKEY CAROTID

Bulldog Clamp, stainless steel,  
delicate atraumatic serrations, special curved

90mm

140-133-095

Ti

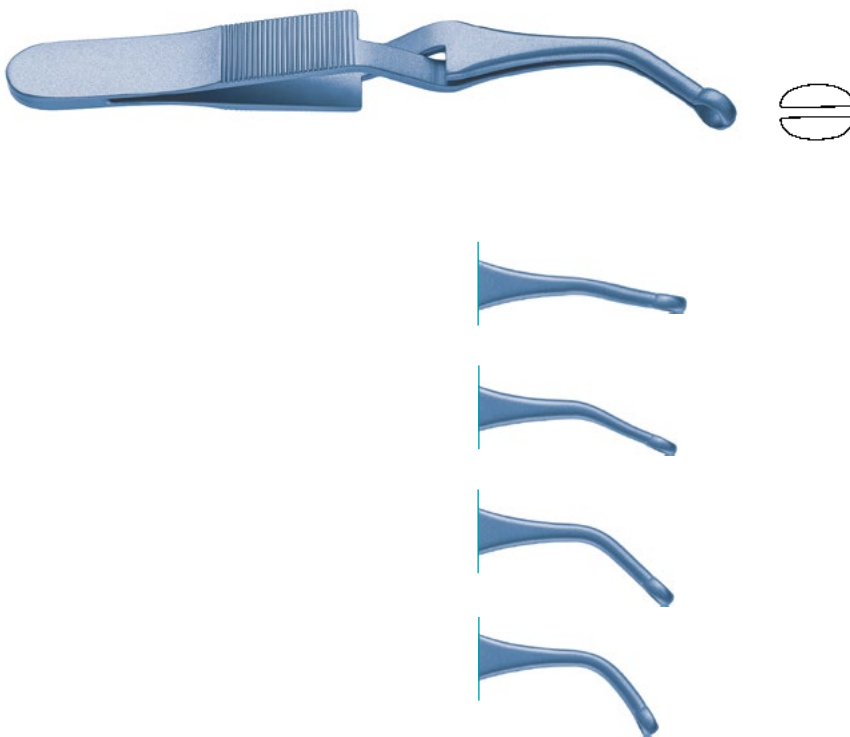

### TITANIUM SHUNT

Bulldog Clamp, titanium,  
smooth jaw without any serrations,  
95mm, 3<sup>3</sup>/<sub>4</sub>" , 10Fr

10°	290-795-010
25°	290-795-025
45°	290-795-045
60°	290-795-060
12Fr	
10°	290-795-210
25°	290-795-225
45°	290-795-245
60°	290-795-260
14Fr	
10°	290-795-410
25°	290-795-425
45°	290-795-445
60°	290-795-460

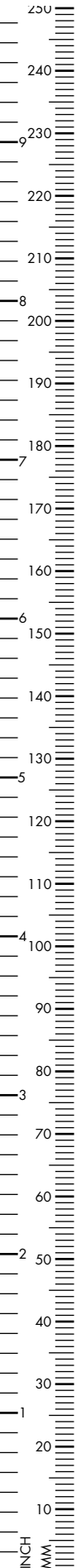



Ti

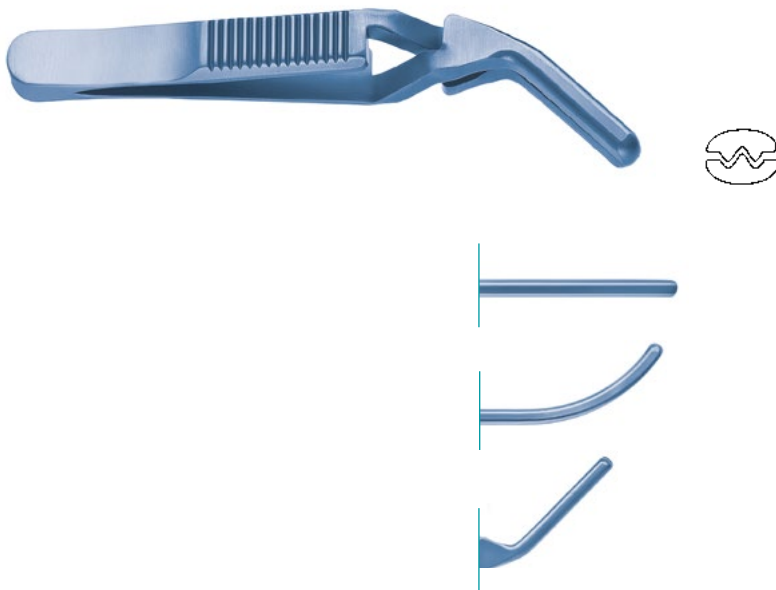

### DEBAKEY ATRAUMA TITANIUM

Bulldog Clamp, titanium,  
extra delicate atraumatic serrations,  
straight

70mm	290-740-070
80mm	290-740-080
90mm	290-740-090
100mm	290-740-100
110mm	290-740-110
120mm	290-740-120
130mm	290-740-130

curved

70mm	290-743-070
80mm	290-743-080
90mm	290-743-090
100mm	290-743-100
110mm	290-743-110
120mm	290-743-120
130mm	290-743-130

angled

70mm	290-745-070
80mm	290-745-080
90mm	290-745-090
100mm	290-745-100
110mm	290-745-110
120mm	290-745-120
130mm	290-745-130

**Ti**



### DEBAKEY DIETRICH

Bulldog Clamp, titanium,  
extra delicate atraumatic serrations, straight

10mm	290-760-010
14mm	290-760-014
20mm	290-760-020

curved

10mm	290-762-010
14mm	290-762-014
20mm	290-762-020

angled

10mm	290-761-010
14mm	290-761-014
20mm	290-761-020



### DIETRICH

Extra delicate serrations, straight

8mm	140-760-008
12mm	140-760-012
20mm	140-760-020

curved

8mm	140-762-008
12mm	140-762-012
20mm	140-762-020

angled

8mm	140-761-008
12mm	140-761-012
20mm	140-761-020

**Ss**



### WICKHAM

Bulldog Clamp, stainless steel,  
very delicate serrations, straight

13mm/49mm	140-108-013
18mm/54mm	140-108-018
25mm/61mm	140-108-025

curved

13mm/47mm	140-109-013
18mm/51mm	140-109-018
25mm/65mm	140-109-025

angled

13mm/48mm	140-110-013
18mm/52mm	140-110-018
25mm/49mm	140-110-026

**CLOSING PRESSURE**

150g (±10g)

Suitable for Applying Forceps: 140-108-230

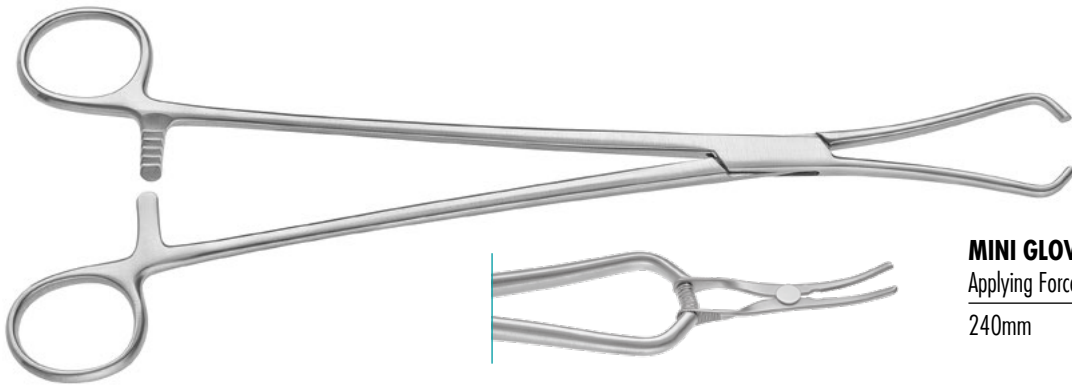

**MINI GLOVER**

Applying Forceps

240mm

140-130-240

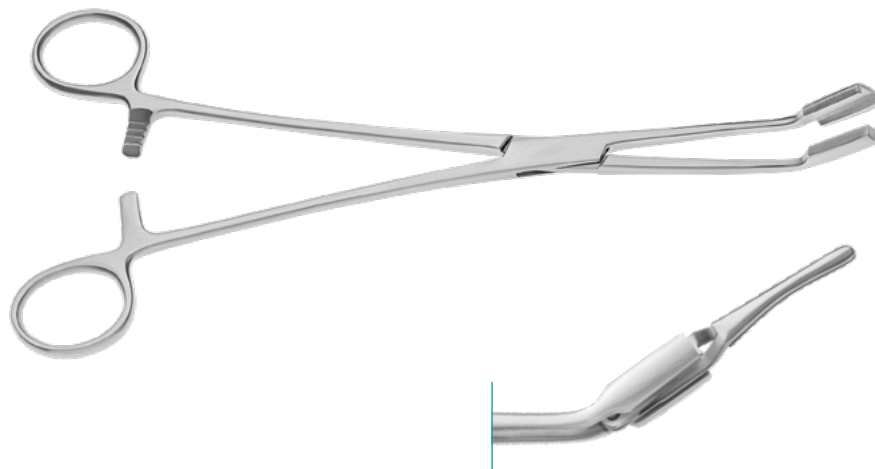

**JOHNS HOPKINS**

Applying Forceps

230mm

140-152-230

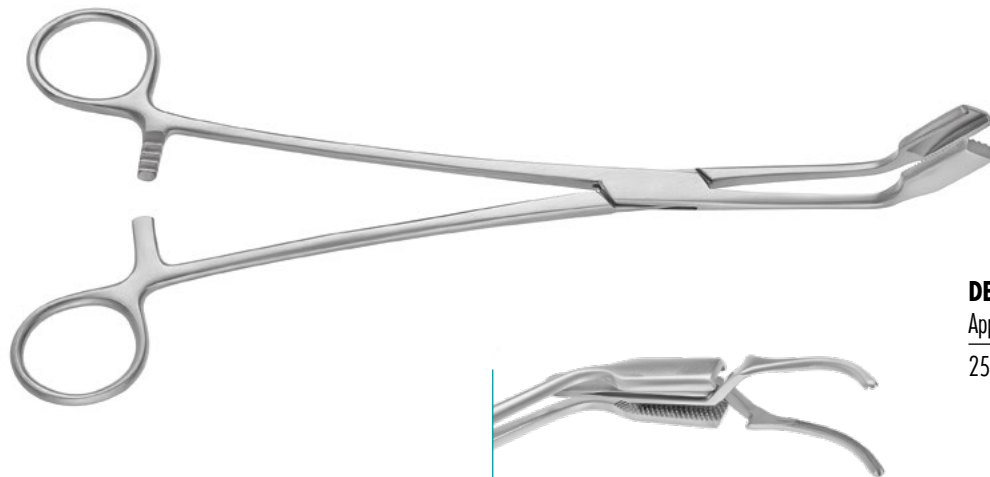

**DEBAKEY ATRAUMA**

Applying Forceps

250mm

140-152-250

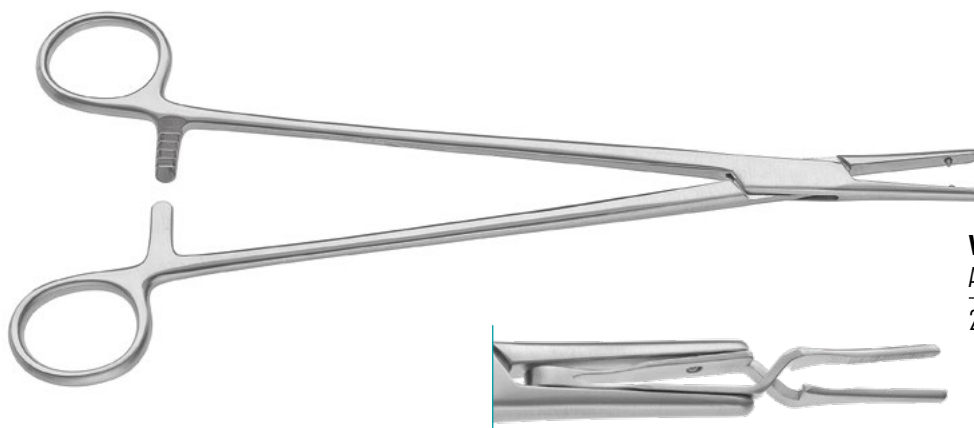

**WICKHAM**

Applying Forceps

230mm

140-108-230



**CLOSING  
PRESSURE**  
300 - 375g

Titanium Bulldog Clamp, straight,  
Code V (Vein), blue

17mm jaw	300-100-773TV
25mm jaw	300-100-774TV
45mm jaw	300-100-771TV
60mm jaw	300-100-772TV



**CLOSING  
PRESSURE**  
475 - 500g

Titanium Bulldog Clamp, straight,  
Code A (Artery), red

17mm jaw	300-100-773TA
25mm jaw	300-100-774TA
45mm jaw	300-100-771TA
60mm jaw	300-100-772TA



Vascular Bulldog Clamp, curved

17mm jaw	300-100-776
25mm jaw	300-100-777
45mm jaw	300-100-778
60mm jaw	300-100-779



**CLOSING  
PRESSURE**  
450 - 475g

Vascular Bulldog Clamp, straight

17mm jaw	300-100-773
25mm jaw	300-100-774
45mm jaw	300-100-771
60mm jaw	300-100-772



**CLOSING  
PRESSURE**  
450 - 475g

**SATINSKY**

Vascular Bulldog Clamp, upwards angled

60mm jaw	300-100-786
----------	-------------



**CLOSING  
PRESSURE**  
450 - 475g

**SATINSKY**

Vascular Bulldog Clamp

60mm jaw	300-100-789
----------	-------------



Endoscopic Bulldog Clamp Applier,  
detachable, 10mm, rotating

330mm, 13" 300-410-775



Endoscopic Bulldog Clamp Applier,  
detachable (insert only)

300-401-775

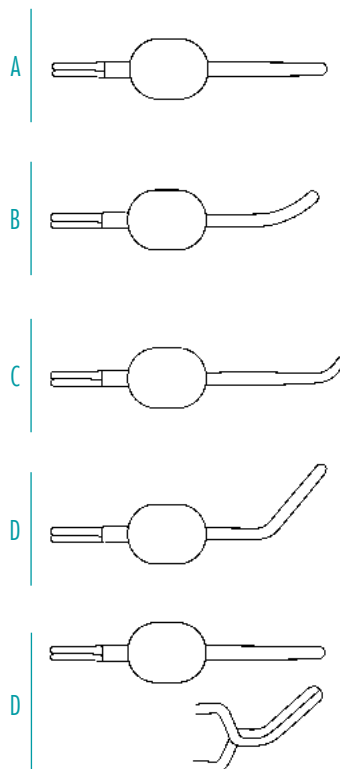

### MÜLLER

Vessel Clip, atraumatic,  
50g closing pressure

A straight	250-065-010
B curved	250-065-011
C curved tip	250-065-012
D angled to side	250-065-013
E knee-bent	250-065-014

80g closing pressure

A straight	250-065-020
B curved	250-065-021
D angled to side	250-065-023
E knee-bent	250-065-024



### MÜLLER

Vessel Clip, atraumatic, straight

250g closing pressure	250-065-030
-----------------------	-------------

350g closing pressure	250-065-040
-----------------------	-------------



### MÜLLER

Vessel Clip, atraumatic, angled

250g closing pressure	250-065-031
-----------------------	-------------

350g closing pressure	250-065-041
-----------------------	-------------



### MÜLLER

Vessel Clip, atraumatic, curved

250g closing pressure	250-065-032
-----------------------	-------------

350g closing pressure	250-065-042
-----------------------	-------------



### MÜLLER

Vessel Clip, atraumatic, knee bent

250g closing pressure	250-065-034
-----------------------	-------------

350g closing pressure	250-065-044
-----------------------	-------------

### SINGLE CLAMPS (PACKED IN PAIRS)

**FIG. 1** 8mm, Vessel  $\varnothing$  0.3-1.0mm

(A) matt	270-001-001
(A) black	270-001-101
(V) matt	270-101-001
(V) black	270-101-101



**FIG. 2** 11mm, Vessel  $\varnothing$  0.6-1.4mm

(A) matt	270-001-002
(A) black	270-001-102
(V) matt	270-101-002
(V) black	270-101-102



**FIG. 3** 16mm, Vessel  $\varnothing$  1.0-2.2mm

(A) matt	270-001-003
(A) black	270-001-103
(V) matt	270-101-003
(V) black	270-101-103



**FIG. 4** 24mm, Vessel  $\varnothing$  1.5-3.3mm

(A) matt	270-001-004
(A) black	270-001-104
(V) matt	270-101-004
(V) black	270-101-104



**FIG. 5** 35mm, Vessel  $\varnothing$  2.0-5.0mm

(A) matt	270-001-005
(A) black	270-001-105
(V) matt	270-101-005
(V) black	270-101-105



### DOUBLE CLAMPS APPROXIMATOR, ADJUSTABLE

**FIG. 1** 8mm, Vessel  $\varnothing$  0.3-1.0mm

(A) matt	270-002-001
(A) black	270-002-101
(V) matt	270-102-001
(V) black	270-102-101



**FIG. 2** 11mm, Vessel  $\varnothing$  0.6-1.4mm

(A) matt	270-002-002
(A) black	270-002-102
(V) matt	270-102-002
(V) black	270-102-102



**FIG. 3** 16mm, Vessel  $\varnothing$  1.0-2.2mm

(A) matt	270-002-003
(A) black	270-002-103
(V) matt	270-102-003
(V) black	270-102-103



**FIG. 4** 24mm, Vessel  $\varnothing$  1.5-3.3mm

(A) matt	270-002-004
(A) black	270-002-104
(V) matt	270-102-004
(V) black	270-102-104



**FIG. 5** 35mm, Vessel  $\varnothing$  2.0-5.0mm

(A) matt	270-002-005
(A) black	270-002-105
(V) matt	270-102-005
(V) black	270-102-105

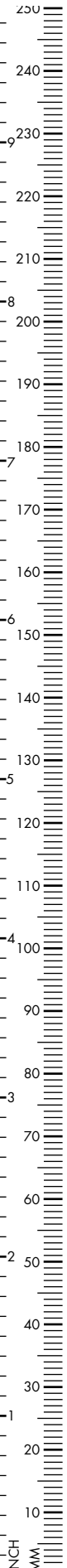



### DOUBLE CLAMPS APPROXIMATOR WITH FRAME, ADJUSTABLE



**FIG. 1** 8mm, Vessel  $\varnothing$  0.3-1.0mm

(A) matt	270-003-001
(A) black	270-003-101
(V) matt	270-103-001
(V) black	270-103-101



**FIG. 2** 11mm, Vessel  $\varnothing$  0.6-1.4mm

(A) matt	270-003-002
(A) black	270-003-102
(V) matt	270-103-002
(V) black	270-103-102



**FIG. 3** 16mm, Vessel  $\varnothing$  1.0-2.2mm

(A) matt	270-003-003
(A) black	270-003-103
(V) matt	270-103-003
(V) black	270-103-103



### CLAMP APPLYING FORCEPS

140mm, 5<sup>1</sup>/<sub>2</sub>" , without ratchet, straight

For Fig. 1+2	270-103-140
For Fig. 3	270-104-160

with ratchet, straight

For Fig. 1+2	270-108-140
For Fig. 3	270-105-160

without ratchet, 30° angled

For Fig. 1+2	270-104-140
For Fig. 3	270-106-140

with ratchet, 30° angled

For Fig. 1+2	270-105-140
For Fig. 3	270-107-140

### DOUBLE CLAMPS WITH FRAME



**FIG. 1** 8mm, Vessel  $\varnothing$  0.3-1.0mm

(A) matt	270-004-001
(A) black	270-004-101
(V) matt	270-104-001
(V) black	270-104-101



**FIG. 2** 11mm, Vessel  $\varnothing$  0.6-1.4mm

(A) matt	270-004-002
(A) black	270-004-102
(V) matt	270-104-002
(V) black	270-104-102



**FIG. 3** 16mm, Vessel  $\varnothing$  1.0-2.2mm

(A) matt	270-004-003
(A) black	270-004-103
(V) matt	270-104-003
(V) black	270-104-103

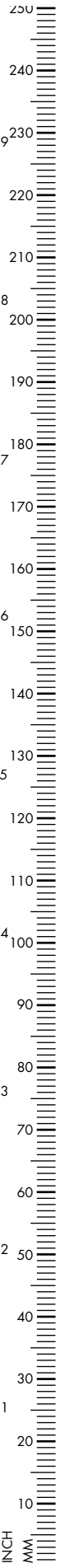

### RZ DC-SINGLE CLAMP, ARTERY (PACKED IN PAIRS)

8mm, Vessel  $\varnothing$  0.3-1.0mm



(A) matt	270-005-001
(A) black	270-005-101
(V) matt	270-105-001
(V) black	270-105-101

11mm, Vessel  $\varnothing$  0.6-1.4mm



(A) matt	270-005-002
(A) black	270-005-102
(V) matt	270-105-002
(V) black	270-105-102

16mm, Vessel  $\varnothing$  1.0-2.2mm



(A) matt	270-005-003
(A) black	270-005-103
(V) matt	270-105-003
(V) black	270-105-103

### RADIAL CLAMPS



<b>RZ-1</b>	8mm, Vessel $\varnothing$ 0.3-1.0mm
matt	270-010-001
black	270-110-001



<b>RZ-2</b>	11mm, Vessel $\varnothing$ 0.6-1.4mm
matt	270-010-002
black	270-110-002



<b>RZ-6</b>	16mm, Vessel $\varnothing$ 1.0-2.2mm
matt	270-010-003
black	270-110-003



<b>RZ-6</b>	8mm, Vessel $\varnothing$ 0.3-1.0mm, straight
(A) matt	270-010-004
(A) black	270-110-004



**BIEMER**

Micro Approximator  
 jaw length: 6mm, opening: 4mm

250-064-571



**BIEMER MÜLLER**

Approximator, 9mm jaw,  
 25-30g closing pressure

straight 250-064-611

angled 250-064-612



**BIEMER**

Vessel Clip, jaw opening 4.0mm  
 Length of jaw 6.0mm

30-40g closing pressure 250-064-560

Jaw opening 5.0mm

Length of jaw 9.0mm

30-40g closing pressure 250-064-561

Jaw opening 5.0mm

Length of jaw 9.0mm

20-25g closing pressure 250-064-562



**BIEMER**

Applying Forceps, 145mm, 5<sup>3</sup>/<sub>4</sub>"

without lock 250-064-568

with lock 250-064-569

### DOUBLE CLAMPS APPROXIMATOR WITH FRAME, ADJUSTABLE



Fig. 1, 8mm, Vessel  $\varnothing$  0.3 - 0.8mm

(A) matt 270-003-201

(V) matt 270-103-201

Fig. 2, 11mm, Vessel  $\varnothing$  0.6 - 1.4mm

(A) matt 270-003-202

(V) matt 270-103-202

Fig. 3, 16mm, Vessel  $\varnothing$  1.0 - 2.2mm

(A) matt 270-003-203

(V) matt 270-103-203

### DOUBLE CLAMPS WITH FRAME



Fig. 1, 8mm, Vessel  $\varnothing$  0.3 - 0.8mm

(A) matt 270-004-201

(V) matt 270-104-201

Fig. 2, 11mm, Vessel  $\varnothing$  0.6 - 1.4mm

(A) matt 270-004-202

(V) matt 270-104-202

Fig. 3, 16mm, Vessel  $\varnothing$  1.0 - 2.2mm

(A) matt 270-004-203

(V) matt 270-104-203

### MICRO VASCULAR SINGLE CLAMPS (PACKED IN PAIRS)



Fig. 1, 8mm, Vessel  $\varnothing$  0.3 - 0.8mm

(A) matt 270-001-201

(V) matt 270-101-201

Fig. 2, 11mm, Vessel  $\varnothing$  0.6 - 1.4mm

(A) matt 270-001-202

(V) matt 270-101-202

Fig. 3, 16mm, Vessel  $\varnothing$  1.0 - 2.2mm

(A) matt 270-001-203

(V) matt 270-101-203

Fig. 4, 24mm, Vessel  $\varnothing$  1.5 - 3.3mm

(A) matt 270-001-204

(V) matt 270-101-204

Fig. 5, 35mm, Vessel  $\varnothing$  2.0 - 4.0mm

(A) matt 270-001-205

(V) matt 270-101-205

### DOUBLE CLAMPS APPROXIMATOR, ADJUSTABLE



Fig. 1, 8mm, Vessel  $\varnothing$  0.3 - 0.8mm

(A) matt 270-002-201

(V) matt 270-102-201

Fig. 2, 11mm, Vessel  $\varnothing$  0.6 - 1.4mm

(A) matt 270-002-202

(V) matt 270-102-202

Fig. 3, 16mm, Vessel  $\varnothing$  1.0 - 2.2mm

(A) matt 270-002-203

(V) matt 270-102-203

Fig. 4, 24mm, Vessel  $\varnothing$  1.5 - 3.3mm

(A) matt 270-002-204

(V) matt 270-102-204

Fig. 5, 35mm, Vessel  $\varnothing$  2.0 - 5.0mm

(A) matt 270-002-205

(V) matt 270-102-205

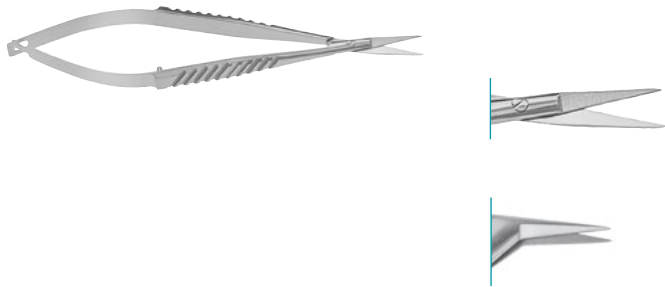

Adventitia Scissors, flat handle, straight  
110mm, 4<sup>1</sup>/<sub>3</sub>"

13mm jaw 251-550-100

19mm jaw 251-550-110

150mm, 6"

15mm jaw 251-554-150

19mm jaw 251-550-150

19mm jaw (nerve) 251-552-150

180mm, 7"

20mm jaw 251-550-180

20mm jaw (nerve) 251-552-180

Adventitia Scissors, flat handle,  
45° angled, 150mm, 6"

8mm jaw 251-563-150

45° angled, 180mm, 7"

12mm jaw 251-563-180

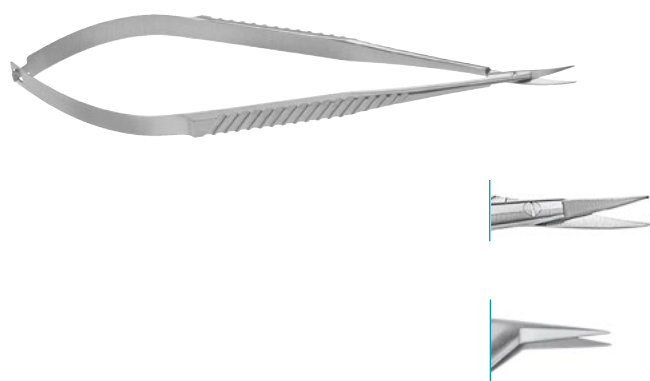

Dissecting Scissors, flat handle, curved  
110mm, 4<sup>1</sup>/<sub>3</sub>"

13mm jaw 251-551-100

19mm jaw 251-551-110

20mm jaw (Westcott) 251-551-111

150mm, 6"

15mm jaw 251-555-150

19mm jaw 251-551-150

19mm jaw (nerve) 251-553-150

22mm jaw (Westcott) 251-551-151

180mm, 7"

20mm jaw 251-551-180

20mm jaw (nerve) 251-553-181

20mm (Westcott) 251-551-181

Dissecting Scissors, flat handle,  
45° angled, 150mm, 6"

8mm jaw 251-556-150

45° angled, 180mm, 7"

12mm jaw 251-556-180

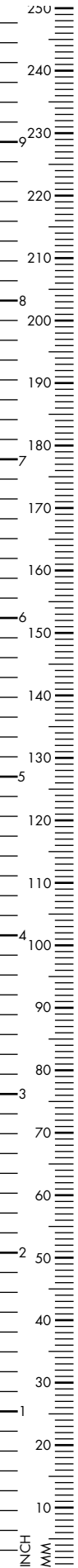

Ultra Fine Dissecting Scissors, flat handle,  
12mm very delicate blade, 8mm handle width,  
straight

150mm, 6" 251-566-150



Ultra Fine Adventitia Scissors, flat handle,  
14mm very delicate blade, 8mm handle width,  
straight

150mm, 6" 251-565-150



Dissecting Scissors, very delicate  
curved, 12mm blade, Ø 8mm round handle

150mm, 6" 251-546-150

180mm, 7" 251-546-180



Adventitia Scissors, very delicate  
straight, 14mm blade, Ø 8mm round handle

150mm, 6" 251-545-150

180mm, 7" 251-545-180

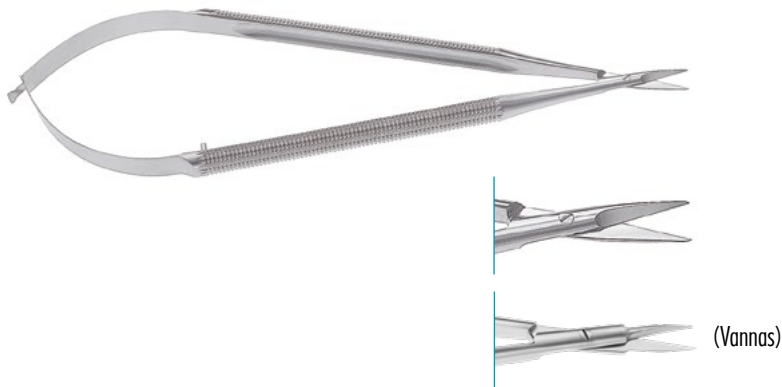

Adventitia Scissors, 7mm round handle, straight  
120mm, 4<sup>3/4</sup>"

11mm jaw 251-540-120

8mm round handle,  
150mm, 6"

12mm jaw 251-540-150

12mm jaw (nerve) 251-542-150

12mm (Vannas) 251-560-150

8mm round handle,  
170mm, 6<sup>2/3</sup>"

10mm jaw 251-580-170

8mm round handle,  
180mm, 7"

14mm jaw 120-178-180

14mm jaw (nerve) 251-542-180

10mm round handle,  
180mm, 7"

14mm jaw 251-558-180

8mm round handle,  
180mm, 7"

21mm jaw 251-540-210

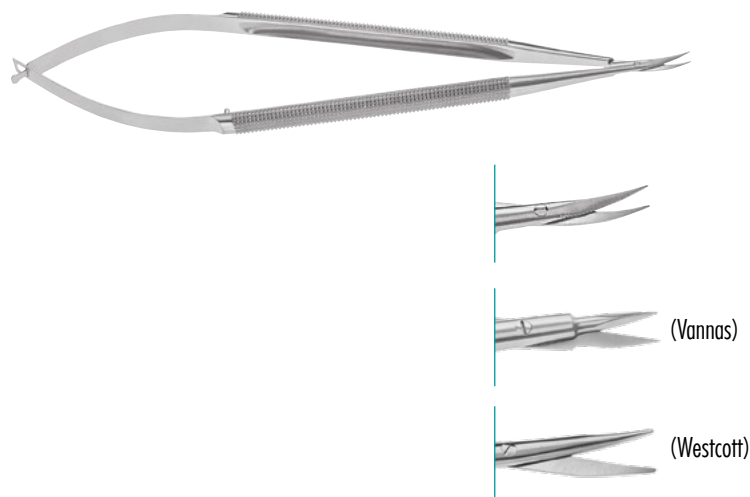

Dissecting Scissors, 7mm round handle, curved  
120mm, 4<sup>3/4</sup>"

11mm jaw 251-541-120

8mm round handle,  
150mm, 6"

12mm jaw 251-541-150

12mm jaw (nerve) 251-543-150

12mm (Vannas) 251-559-150

20mm (Westcott) 251-541-151

8mm round handle,  
180mm, 7"

14mm jaw 251-541-180

14mm jaw (nerve) 251-543-180

20mm (Westcott) 251-541-181

10mm round handle,  
180mm, 7"

14mm jaw 251-557-180

8mm round handle,  
210mm, 8<sup>1/4</sup>"

21mm jaw 251-541-210

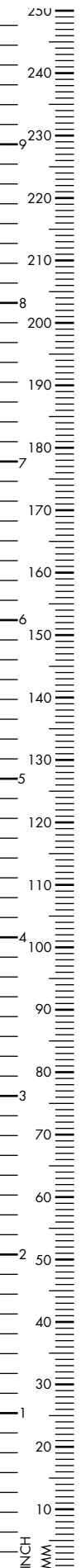

### JACOBSON

Micro Scissors, 160mm, 6<sup>1</sup>/<sub>4</sub>"  
sharp blades, 8mm round handle  
7mm micro blades, angled

25°	120-164-025
45°	120-164-045
60°	120-164-060
90°	120-164-090
125°	120-164-125

10mm micro blades, angled

25°	120-164-225
45°	120-164-245
60°	120-164-260
90°	120-164-290
125°	120-164-325



### JACOBSON

Micro Scissors, 180mm, 7"  
sharp blades, 8mm round handle  
14mm blades

25°	120-184-225
45°	120-184-245
60°	120-184-260
90°	120-184-290
125°	120-184-325

ball tip blades

25°	120-184-425
45°	120-184-445
60°	120-184-460
90°	120-184-490
125°	120-184-425





### POTTS

Ø 3.5mm, 45° angled, single action  
working length:

170mm, 6 <sup>2</sup> / <sub>3</sub> "	295-034-045
250mm, 9 <sup>7</sup> / <sub>8</sub> "	295-035-045
300mm, 11 <sup>7</sup> / <sub>8</sub> "	295-037-045



### POTTS

Ø 3.5mm, 90° angled, single action  
working length:

170mm, 6 <sup>2</sup> / <sub>3</sub> "	295-034-090
250mm, 9 <sup>7</sup> / <sub>8</sub> "	295-035-090
300mm, 11 <sup>7</sup> / <sub>8</sub> "	295-037-090



### POTTS

Ø 3.5mm, 125° angled, single action  
working length:

170mm, 6 <sup>2</sup> / <sub>3</sub> "	295-034-125
250mm, 9 <sup>7</sup> / <sub>8</sub> "	295-035-125
300mm, 11 <sup>7</sup> / <sub>8</sub> "	295-037-125



### POTTS

Ø 5.0mm, 125° angled, single action  
working length:

170mm, 6 <sup>2</sup> / <sub>3</sub> "	295-048-125
250mm, 9 <sup>7</sup> / <sub>8</sub> "	295-050-125
300mm, 11 <sup>7</sup> / <sub>8</sub> "	295-052-125



### METZENBAUM

Ø 5.0mm, straight, single action  
working length:

170mm, 6 <sup>2</sup> / <sub>3</sub> "	295-048-000
250mm, 9 <sup>7</sup> / <sub>8</sub> "	295-050-000
300mm, 11 <sup>7</sup> / <sub>8</sub> "	295-052-000



### METZENBAUM

Ø 5.0mm, straight, double action  
working length:

170mm, 6 <sup>2</sup> / <sub>3</sub> "	295-048-010
250mm, 9 <sup>7</sup> / <sub>8</sub> "	295-050-010
300mm, 11 <sup>7</sup> / <sub>8</sub> "	295-052-010



### METZENBAUM

Ø 5.0mm, 15° curved, double action  
working length:

170mm, 6 <sup>2</sup> / <sub>3</sub> "	295-048-015
250mm, 9 <sup>7</sup> / <sub>8</sub> "	295-050-015
300mm, 11 <sup>7</sup> / <sub>8</sub> "	295-052-015



### JAMESON

Ø 5.0mm, 15° curved, double action  
working length:

170mm, 6 <sup>2</sup> / <sub>3</sub> "	295-048-020
250mm, 9 <sup>7</sup> / <sub>8</sub> "	295-050-020
300mm, 11 <sup>7</sup> / <sub>8</sub> "	295-052-020



### METZENBAUM

Ø 5.0mm, 30° curved, double action  
working length:

170mm, 6 <sup>2</sup> / <sub>3</sub> "	295-048-030
250mm, 9 <sup>7</sup> / <sub>8</sub> "	295-050-030
300mm, 11 <sup>7</sup> / <sub>8</sub> "	295-052-030



### METZENBAUM

Ø 5.0mm, 70° curved, double action  
working length:

170mm, 6 <sup>2</sup> / <sub>3</sub> "	295-048-070
250mm, 9 <sup>7</sup> / <sub>8</sub> "	295-050-070
300mm, 11 <sup>7</sup> / <sub>8</sub> "	295-052-070



### METZENBAUM

Ø 7.0mm, 15° curved, double action  
working length:

170mm, 6 <sup>2</sup> / <sub>3</sub> "	295-069-015
250mm, 9 <sup>7</sup> / <sub>8</sub> "	295-070-015
300mm, 11 <sup>7</sup> / <sub>8</sub> "	295-071-015

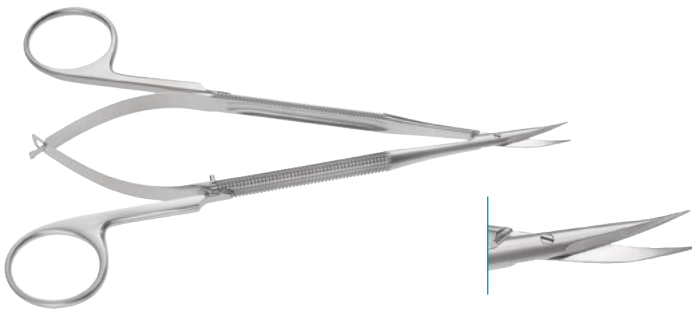

### WESTCOTT

Dissecting Scissors, 8mm handle, curved  
150mm, 6"

15mm jaw 251-570-150

20mm jaw 251-571-150

180mm, 7"

15mm jaw 251-570-180

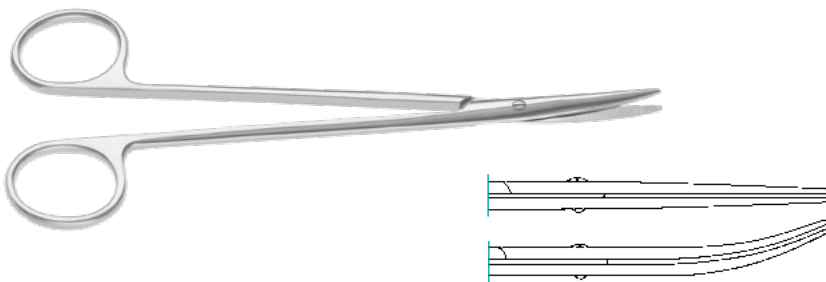

### LINCOLN

Vascular Scissors, straight

170mm, 6<sup>2</sup>/<sub>3</sub>" 120-260-170

curved

170mm, 6<sup>2</sup>/<sub>3</sub>" 120-261-170

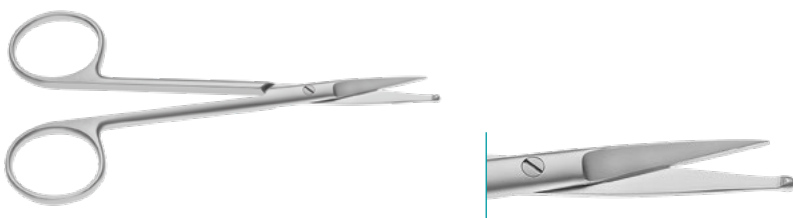

Coronary Scissors, probe-pointed tip

115mm, 4<sup>1</sup>/<sub>2</sub>" 120-420-115

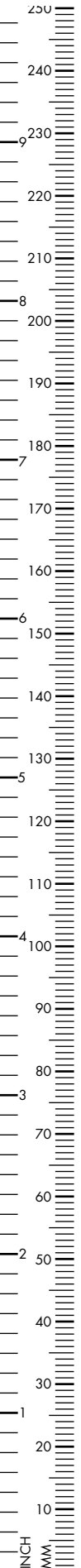



### DEBAKEY

Endarterectomy Scissors, 180mm, 7"

slightly curved	120-319-180
strongly curved	120-320-180

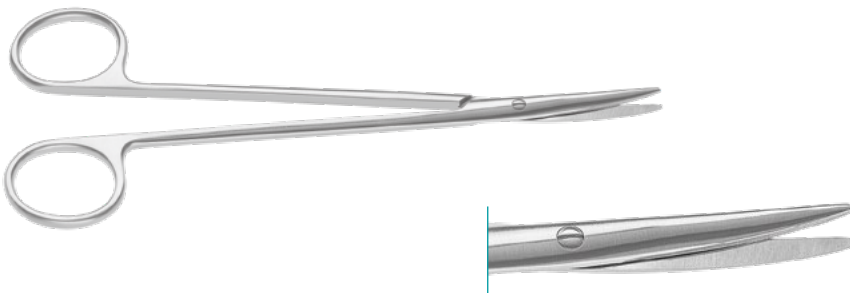

### DE MARTEL

Vascular Scissors, 175mm, 6<sup>7</sup>/<sub>8</sub>"

blunt	120-261-175
sharp	120-263-175

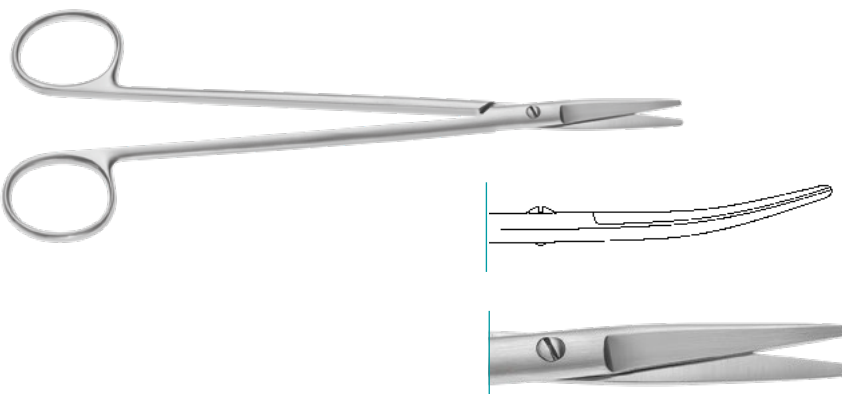

### CHURCH

Vascular Scissors, slightly curved

170mm, 6 <sup>2</sup> / <sub>3</sub> "	120-255-170
255mm, 10"	120-255-255



**THOMPSON**

Valve Scissors, strong curved

250mm, 9<sup>7</sup>/<sub>8</sub>"

120-205-250

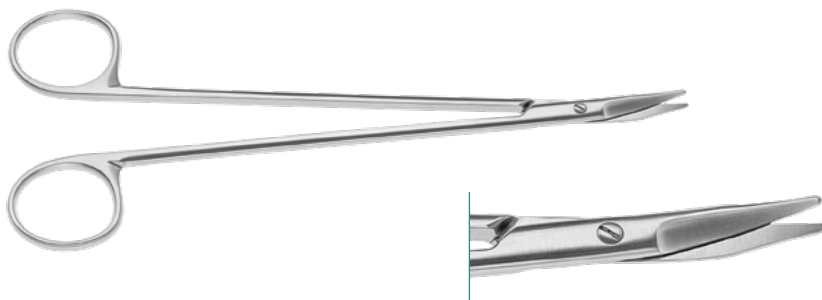

**LAINÉ KINDAL**

curved, tenotomy tip

180mm, 7"

125-282-778

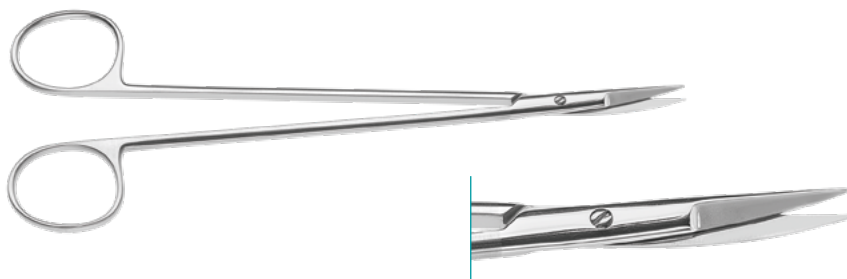

**LAINÉ KINDAL**

curved, sharp tip

180mm, 7"

125-282-776

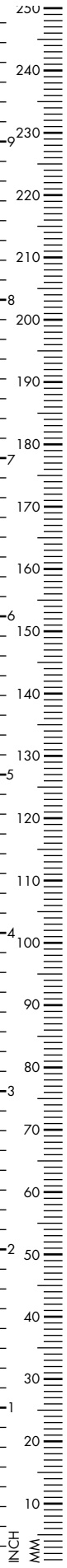



### HOHENFELLER

S-curved

180mm, 7"	120-060-180
210mm, 8 <sup>1/4</sup> "	120-060-210
240mm, 9 <sup>1/2</sup> "	120-060-240



### COOLEY

Vascular Scissors, curved

180mm, 7"	120-134-180
230mm, 9"	120-134-230



### SATINSKY

Vascular Scissors, curved

245mm, 9 <sup>2/3</sup> "	120-203-245
---------------------------	-------------



### DIETRICH

sharp, extra delicate, 14mm, 180mm, 7"

25° 125-170-025

45° 125-170-045

60° 125-170-060

90° 125-170-090

125° 125-170-125

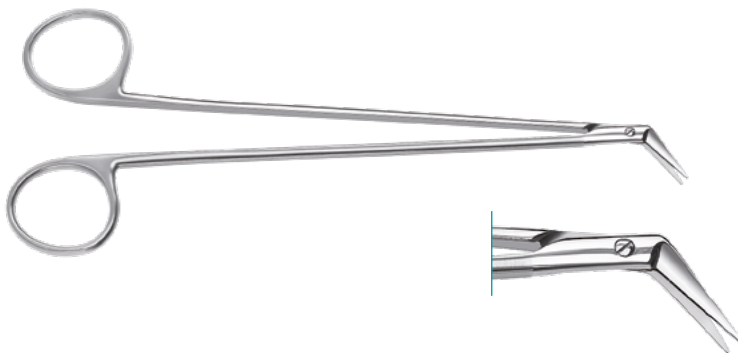

### DIETRICH

delicate, 14mm, 180mm, 7"

25° 125-175-025

45° 125-175-045

60° 125-175-060

90° 125-175-090

125° 125-175-125

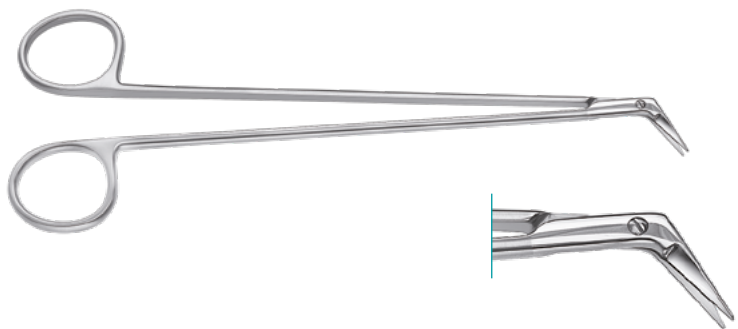

### DIETRICH HEGEMANN

13mm, 180mm, 7"

25° 125-180-025

45° 125-180-045

60° 125-180-060

90° 125-180-090

125° 125-180-125

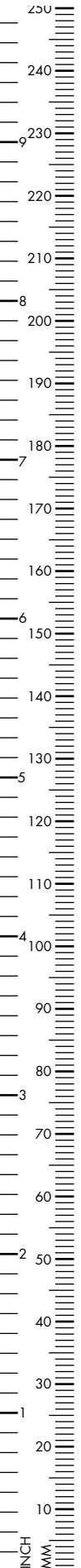



### DIETRICH

Peripheral, 130mm, 5 1/8"

25°	125-130-025
45°	125-130-045
60°	125-130-060
90°	125-130-090
125°	125-130-125

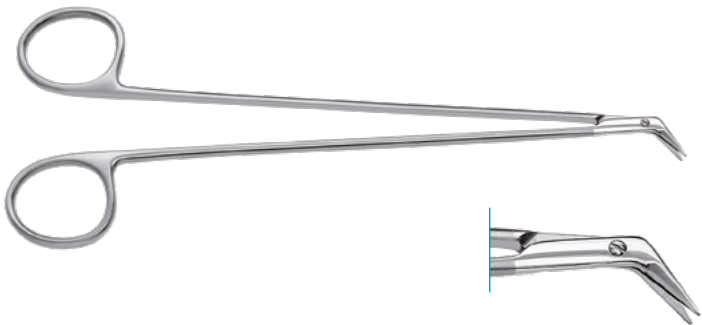

### DIETRICH

sharp blade, 9mm, 180mm, 7"

25°	125-178-025
45°	125-178-045
60°	125-178-060
90°	125-178-090
125°	125-178-125

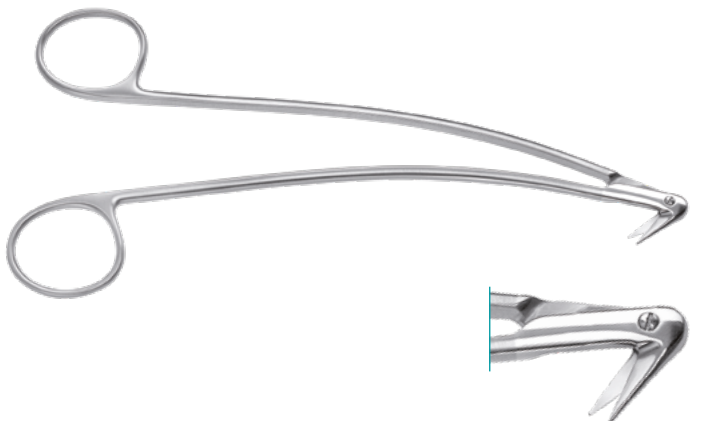

### DIETRICH FAVALORO

13mm, 180mm, 7"

125°	125-185-125
------	-------------

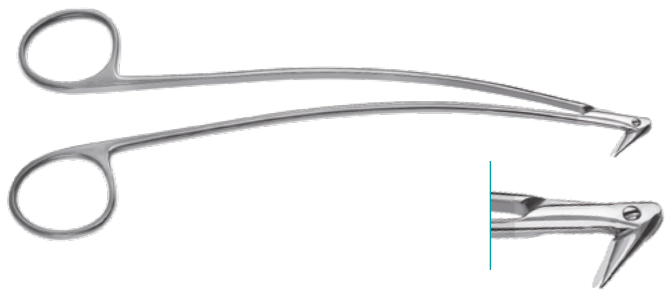

### DIETHRICH FAVALORO

9mm, 170mm, 6<sup>3</sup>/<sub>4</sub>"

125° 125-168-125

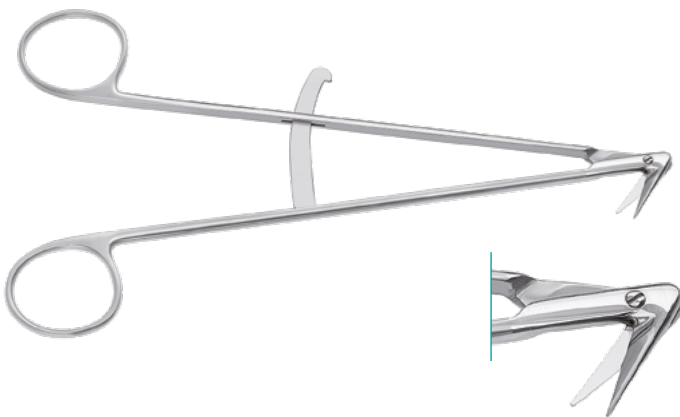

### DIETHRICH ARTERY

13mm, 180mm, 7"

125° 125-200-125



### BEALL

Circumflex, 150mm, 6"

115° 125-300-115

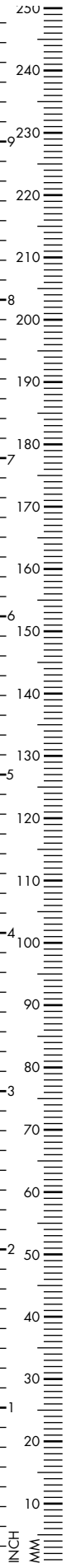



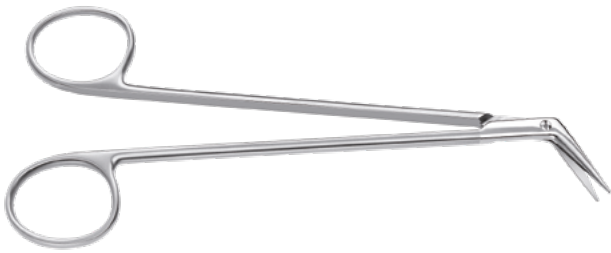

### DIETRICH

26mm, 160mm, 6<sup>1</sup>/<sub>4</sub>"

25°, blunt tip	125-216-025
25°, sharp tip	125-217-025
45°, blunt tip	125-216-045
45°, sharp tip	125-217-045

225mm, 8<sup>7</sup>/<sub>8</sub>"

25°, blunt tip	125-220-025
25°, sharp tip	125-221-025
45°, blunt tip	125-220-045
45°, sharp tip	125-221-045
60°, blunt tip	125-220-060
60°, sharp tip	125-221-060

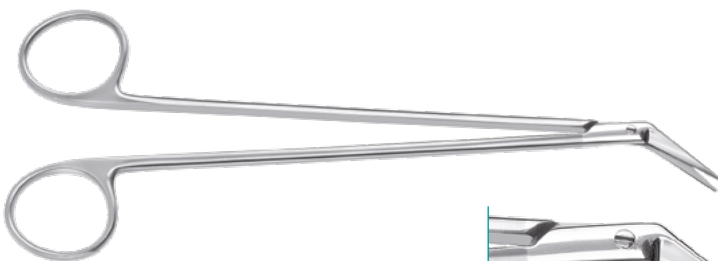

### POTTS SMITH

22mm, 190mm, 7<sup>1</sup>/<sub>2</sub>"

25°	125-490-025
45°	125-490-045
60°	125-490-060



### POTTS SMITH

22mm, 140mm, 5<sup>1</sup>/<sub>2</sub>"

25°	125-440-025
45°	125-440-045
60°	125-440-060

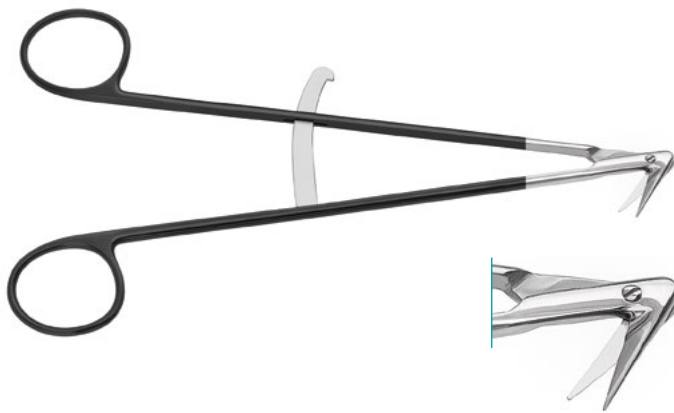

### DIETHRICH SC

13mm, with guide, 180mm, 7"

125° 126-200-125

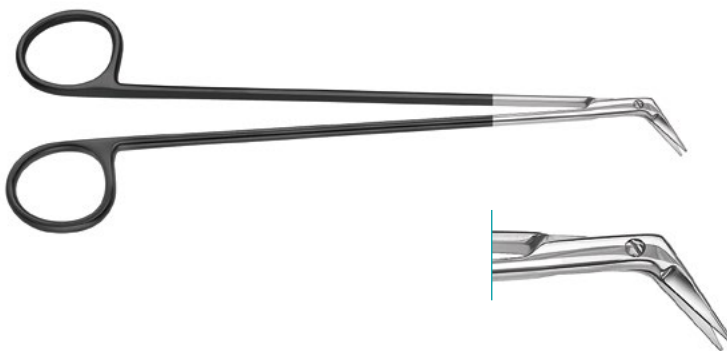

### DIETHRICH HEGEMANN SC

13mm, 180mm, 7"

25° 126-180-025

45° 126-180-045

60° 126-180-060

90° 126-180-090

125° 126-180-125



### DIETHRICH SC

Peripheral, 13mm, 130mm, 5 1/8"

25° 126-130-025

45° 126-130-045

60° 126-130-060

90° 126-130-090

125° 126-130-125

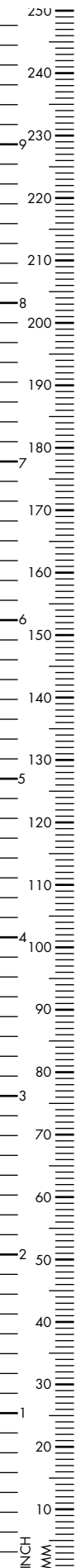

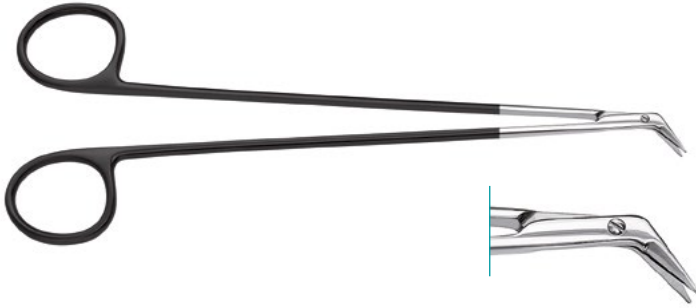

### DIETHRICH SC

9mm, 130mm, 5<sup>1</sup>/<sub>8</sub>"

25°	126-178-025
45°	126-178-045
60°	126-178-060
90°	126-178-090
125°	126-178-125

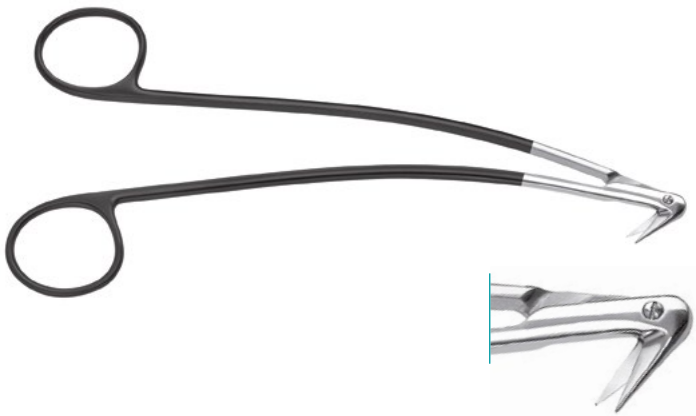

### DIETHRICH FAVALORO SC

13mm, 180mm, 7"

125°	126-185-125
------	-------------

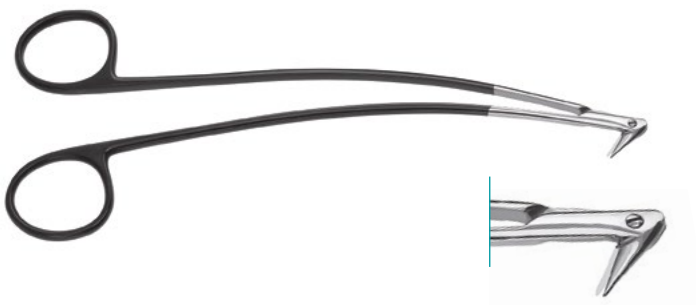

### DIETHRICH FAVALORO SC

9mm, 170mm, 6<sup>2</sup>/<sub>3</sub>"

125°	126-168-125
------	-------------

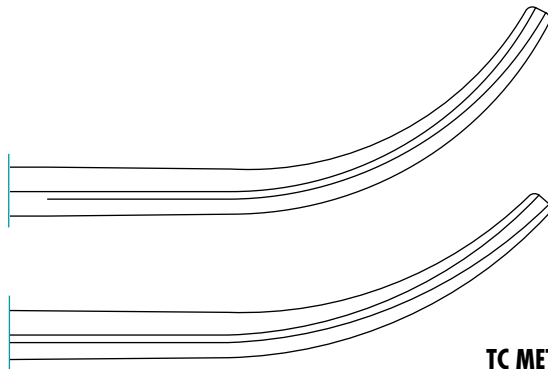

### TC METZENBAUM

70mm blade length, double action,  
slightly curved

325mm, 12<sup>3</sup>/<sub>4</sub>" 295-120-000

365mm, 14<sup>1</sup>/<sub>3</sub>" 295-120-002

strongly curved

325mm, 12<sup>3</sup>/<sub>4</sub>" 295-120-001

365mm, 14<sup>1</sup>/<sub>3</sub>" 295-120-003



Dissecting Scissors, slightly curved, single action  
180mm working length, Ø 5mm shaft

285mm, 11<sup>1</sup>/<sub>4</sub>" 295-123-180



Micro Forceps, flat handle, Ø 0.3mm tip,  
9mm handle width

A 110mm, 4<sup>1</sup>/<sub>3</sub>" 251-613-110

B 120mm, 4<sup>3</sup>/<sub>4</sub>" 251-611-120

B 7mm handle width, 135mm, 5<sup>1</sup>/<sub>3</sub>"  
251-612-130

with tying platform 251-617-130

B 9mm handle width, 135mm, 5<sup>1</sup>/<sub>3</sub>"  
251-611-130

with tying platform 251-621-135

A 9mm handle width  
150mm, 6" 251-613-150

B 9mm handle width, 180mm, 7"  
251-611-180

with tying platform 251-611-181



Micro Forceps, flat, smooth handle,  
9mm handle width, 110mm, 4<sup>1</sup>/<sub>3</sub>"

Ø 0.4mm tip 251-600-040

Ø 0.6mm tip 251-600-060

Ø 0.8mm tip 251-600-080



Micro Forceps, flat handle,  
Ø 0.4mm tip, 9mm handle width

120mm, 4<sup>3</sup>/<sub>4</sub>" 251-618-120

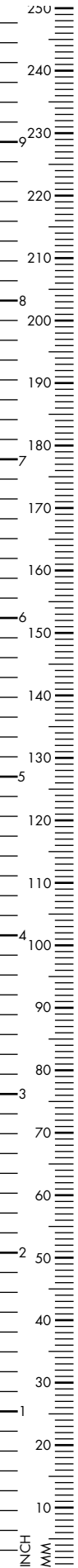

Fine Micro Forceps, flat handle,  
 Ø 0.1mm tip, 9mm handle width

A	110mm, 4 <sup>1</sup> / <sub>3</sub> "	251-609-110
B	135mm, 5 <sup>1</sup> / <sub>3</sub> "	251-613-130



Micro Forceps, flat handle, 45° angled  
 Ø 0.3mm tip, 9mm handle width

110mm, 4 <sup>1</sup> / <sub>3</sub> "	251-616-110
135mm, 5 <sup>1</sup> / <sub>3</sub> "	
7mm	251-615-130
9mm	251-603-135
150mm, 6"	
9mm	251-616-150
180mm, 7"	
9mm	251-613-180
with tying platform	251-613-181
90° angled Ø 0.3mm tip, 9mm handle width	
110mm, 4 <sup>1</sup> / <sub>3</sub> "	251-617-110



### PIERSE

Micro Forceps, flat handle, 9mm handle width  
120mm, 4<sup>3/4</sup>"

Ø 0.3mm tip 251-615-120

Ø 0.65mm tip 251-613-120

Ø 0.1mm tip 251-616-120

135mm, 5<sup>1/3</sup>"

Ø 0.3mm tip 251-610-135

180mm, 7"

Ø 0.65mm tip 251-612-180



### BANIS

Micro Forceps, flat handle, 9mm handle width  
Ø 0.3mm tip

135mm, 5<sup>1/3</sup>" 251-607-135

180mm, 7" 251-607-180



Tubing Introducer Forceps, 9mm handle width

120mm, 4<sup>3/4</sup>" 251-715-120



Micro Forceps, flat handle,  
 Ø 0.3mm diamond dusted tip,  
 9mm handle width, straight

110mm, 4<sup>1</sup>/<sub>3</sub>" 251-713-110

7mm handle width, 135mm, 5<sup>1</sup>/<sub>3</sub>"  
 251-712-130

with tying platform 251-717-130

9mm handle width, 135mm, 5<sup>1</sup>/<sub>3</sub>"  
 251-711-130

with tying platform 251-721-135

9mm handle width  
 180mm, 7" 251-711-180

Curved, Ø 0.4mm tip,  
 9mm handle width

120mm, 4<sup>3</sup>/<sub>4</sub>" 251-718-120

45° angled, Ø 0.3mm tip,  
 9mm handle width

110mm, 4<sup>1</sup>/<sub>3</sub>" 251-619-110

135mm, 5<sup>1</sup>/<sub>3</sub>" 251-703-135

180mm, 7" 251-713-180

7mm handle width

135mm, 5<sup>1</sup>/<sub>3</sub>" 251-619-130

### ADSON

Fixation Forceps, Ø 0.3mm tip,  
 120mm, 4<sup>3</sup>/<sub>4</sub>"

A 45° angled teeth 251-662-120

B 90° angled teeth 130-554-120



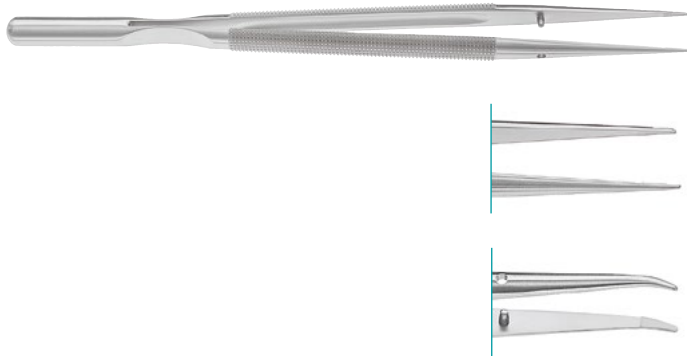

Balanced Micro Forceps, diamond dusted tip,  
with tying platform, straight  
Ø 0.7mm tip

150mm, 6" 251-657-150

210mm, 8<sup>1/4</sup>" 251-657-210

Ø 0.5mm tip

180mm, 7" 251-657-180

Ø 0.7mm tip

210mm, 8<sup>1/4</sup>" 251-660-210

curved, Ø 0.7mm tip

210mm, 8<sup>1/4</sup>" 251-661-210

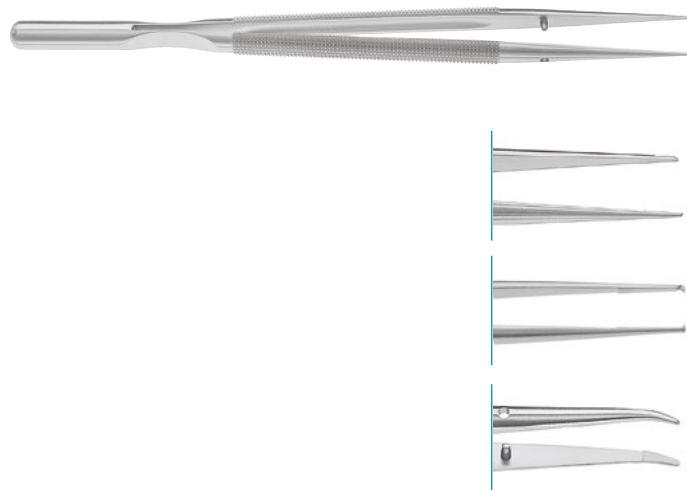

Balanced Micro Forceps, with tying platform,  
straight  
Ø 0.3mm tip

150mm, 6" 251-650-150

Ø 0.5mm tip

180mm, 7" 251-650-180

210mm, 8<sup>1/4</sup>" 251-650-210

straight, with 1x2 teeth, Ø 0.3mm tip

150mm, 6" 251-658-150

180mm, 7" 251-658-180

straight, with 1x2teeth, Ø 0.7mm tip

210mm, 8<sup>1/4</sup>" 251-658-210

curved, Ø 0.3mm tip

150mm, 6" 251-653-150

curved, Ø 0.5mm tip

180mm, 7" 251-653-180

210mm, 8<sup>1/4</sup>" 251-653-210



### DEBAKEY

Micro Forceps,  $\varnothing$  8mm handle,  
 $\varnothing$  1.2mm tip

150mm, 6"	250-653-150
-----------	-------------

$\varnothing$  1.0mm tip

180mm, 7"	250-653-180
-----------	-------------

210mm, 8 <sup>1</sup> / <sub>4</sub> "	250-653-210
--	-------------



### PIERSE

Micro Fixation Forceps,  $\varnothing$  8mm handle,  
 $\varnothing$  0.3mm tip

150mm, 6"	251-652-150
-----------	-------------

$\varnothing$  0.6mm tip

180mm, 6"	251-652-180
-----------	-------------

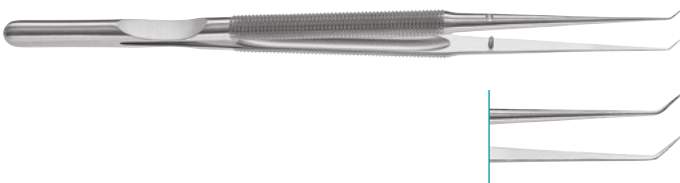

Micro Forceps, 45° angled,  $\varnothing$  8mm handle,  
 $\varnothing$  0.2mm tip

150mm, 6"	251-655-150
-----------	-------------

180mm, 7"	251-654-180
-----------	-------------

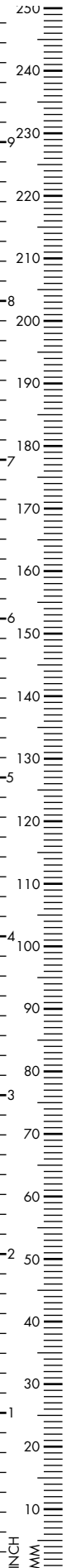



Micro Forceps, 45° angled, Ø 8mm handle,  
Ø 0.3mm tip



150mm, 6"	251-656-150
180mm, 7"	251-656-180



 Micro Ring Forceps with diamond dusted tip,  
straight, Ø 8mm handle,  
Ø 1 x 0.5mm ring

150mm, 6"	251-655-145
180mm, 7"	251-655-180
210mm, 8 <sup>1</sup> / <sub>4</sub> "	251-655-210



  Micro Ring Forceps, Titan,  
with diamond dusted tip,  
straight, Ø 8mm handle, without weight  
Ø 1 x 0.5mm ring

150mm, 6"	250-364-705
Ø 2 x 1mm ring	
180mm, 7"	250-364-706
210mm, 8 <sup>1</sup> / <sub>4</sub> "	250-364-707
with weight Ø 1 x 0.5mm ring	
150mm, 6"	250-764-715
180mm, 7"	250-764-718
210mm, 8 <sup>1</sup> / <sub>4</sub> "	250-764-721

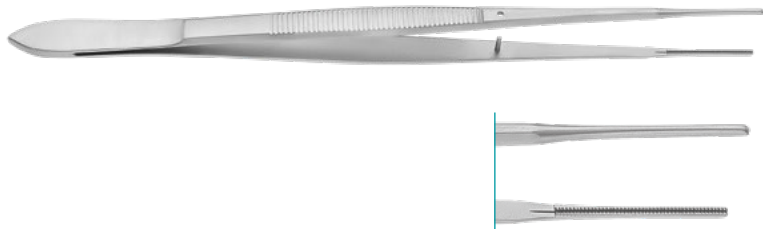
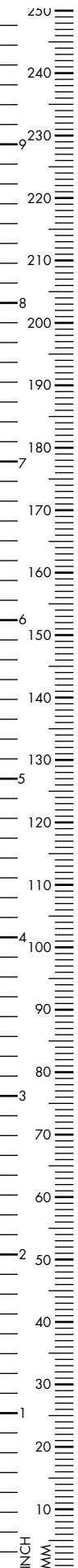

### GERALD DEBAKEY

Vascular Tissue Forceps, straight, extra delicate  
1.0mm tip, DeBakey serrations

175mm, 6 <sup>7</sup> / <sub>8</sub> "	130-520-175
200mm, 8"	130-520-200
240mm, 9 <sup>1</sup> / <sub>2</sub> "	130-520-240

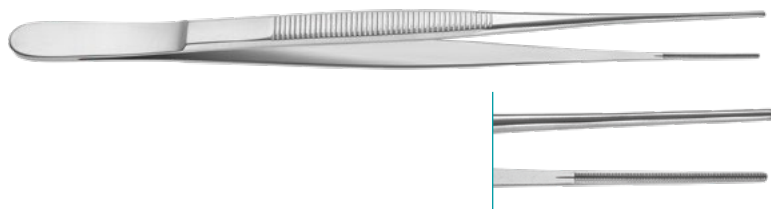

### DIETHRICH DEBAKEY

Vascular Tissue Forceps, straight, extra delicate  
1.5mm tip, DeBakey serrations

160mm, 6 <sup>1</sup> / <sub>4</sub> "	130-468-150
200mm, 8"	130-468-200
240mm, 9 <sup>1</sup> / <sub>2</sub> "	130-468-240

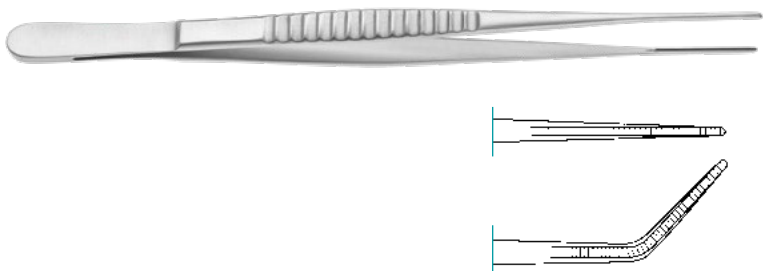

### DEBAKEY

Vascular Tissue Forceps, straight, 1.5mm tip,  
DeBakey serrations,  
straight

160mm, 6 <sup>1</sup> / <sub>4</sub> "	290-550-160
200mm, 8"	290-550-200
240mm, 9 <sup>1</sup> / <sub>2</sub> "	290-550-240
300mm, 11 <sup>7</sup> / <sub>8</sub> "	290-550-300

### angled

160mm, 6 <sup>1</sup> / <sub>4</sub> "	290-551-160
200mm, 8"	290-551-200
240mm, 9 <sup>1</sup> / <sub>2</sub> "	290-551-240
300mm, 11 <sup>7</sup> / <sub>8</sub> "	290-551-300

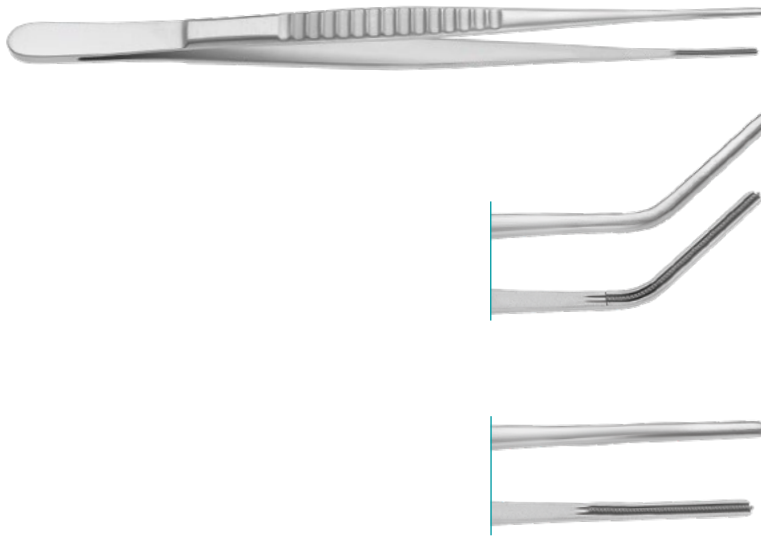

### DEBAKEY

Vascular Tissue Forceps, straight, 2.0mm tip, DeBaKEY serrations, straight

160mm, 6 <sup>1</sup> / <sub>4</sub> "	290-552-160
200mm, 8"	290-552-200
240mm, 9 <sup>1</sup> / <sub>2</sub> "	290-552-240
300mm, 11 <sup>7</sup> / <sub>8</sub> "	290-552-300

angled, 2.0mm

160mm, 6 <sup>1</sup> / <sub>4</sub> "	290-553-160
200mm, 8"	290-553-200
240mm, 9 <sup>1</sup> / <sub>2</sub> "	290-553-240
300mm, 11 <sup>7</sup> / <sub>8</sub> "	290-553-300

straight, 3.5mm

160mm, 6 <sup>1</sup> / <sub>4</sub> "	290-554-160
200mm, 8"	290-554-200
240mm, 9 <sup>1</sup> / <sub>2</sub> "	290-554-240
300mm, 11 <sup>7</sup> / <sub>8</sub> "	290-554-300

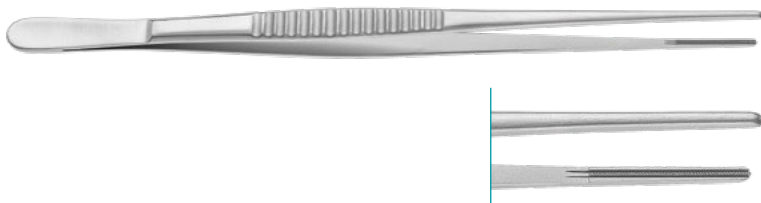

### DEBAKEY

Vascular Tissue Forceps, straight, 2.4mm tip, DeBaKEY serrations

160mm, 6 <sup>1</sup> / <sub>4</sub> "	290-557-160
200mm, 8"	290-557-200
240mm, 9 <sup>1</sup> / <sub>2</sub> "	290-557-240
300mm, 11 <sup>7</sup> / <sub>8</sub> "	290-557-300

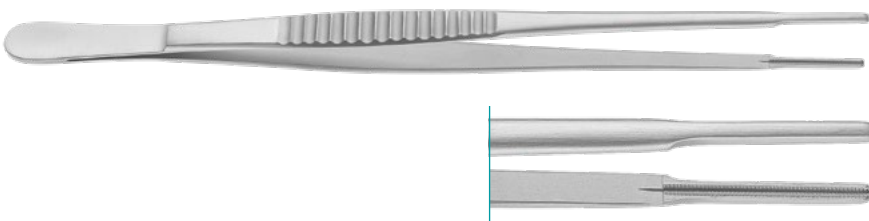

### DEBAKEY

Vascular Tissue Forceps, straight, 2.8mm step-down tip, DeBaKEY serrations

160mm, 6 <sup>1</sup> / <sub>4</sub> "	290-558-160
200mm, 8"	290-558-200
240mm, 9 <sup>1</sup> / <sub>2</sub> "	290-558-240
300mm, 11 <sup>7</sup> / <sub>8</sub> "	290-558-300

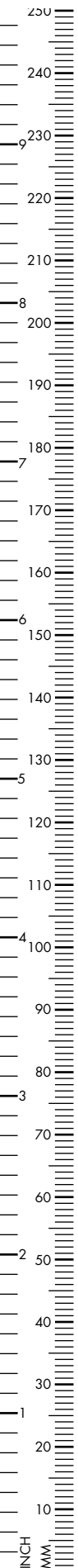

### COOLEY

Vascular Tissue Forceps, straight,  
delicate 1.5mm tip, DeBakey serrations

150mm, 6" 290-556-150

2.0mm tip

160mm, 6<sup>1</sup>/<sub>4</sub>" 290-556-160

200mm, 8" 290-556-200

240mm, 9<sup>1</sup>/<sub>2</sub>" 290-556-240



### ADSON DEBAKEY

Vascular Tissue Forceps, straight, 2.0mm tip

120mm, 4<sup>3</sup>/<sub>4</sub>" 130-527-120



### Micro Dialtor

10° angled, 110mm, 4<sup>1</sup>/<sub>3</sub>", 9mm handle

Ø 0.2mm tip 251-602-110

9mm tip

Ø 0.3mm tip, 251-601-110

4mm tip

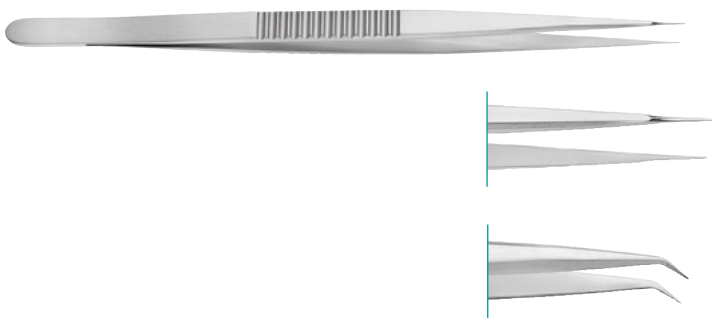

Micro Dilator, flat handle, straight,  
135mm, 5<sup>1/3</sup>", 6mm tip length

Ø 0.2mm tip      251-611-131  
7mm handle

Ø 0.2mm tip,      251-611-132  
9mm handle

4mm tip length

Ø 0.3mm tip,      251-611-133  
9mm handle

180mm, 7", 6mm tip length

Ø 0.1mm tip      251-611-187  
9mm handle

Ø 0.2mm tip,      251-611-186  
9mm handle

4mm tip length

Ø 0.3mm tip,      251-611-185  
9mm handle

45° angled, 135mm, 5<sup>1/3</sup>", 9mm handle

Ø 0.3mm tip      251-608-135  
4mm tip



Micro Dilator, round handle, straight,  
Ø 0.3mm tip, 4mm tip, 8mm handle

150mm, 6"      251-640-150

180mm, 7"      251-640-180



Micro Needle Holder, flat handle, Ø 0.4mm tip, 140mm, 5 <sup>1</sup> / <sub>2</sub> " , straight	
with ratchet	250-064-153
without ratchet	250-064-149
curved	
with ratchet	250-064-151
without ratchet	250-064-150



Micro Needle Holder, round handle, Ø 0.4mm tip, without ratchet, Ø 8mm handle, straight	
130mm, 5 <sup>1</sup> / <sub>8</sub> "	250-064-138
180mm, 7"	250-064-244
Ø 0.2mm tip, Ø 8mm handle, curved, 150mm, 6"	
without ratchet	250-064-144
Ø 8mm handle, curved, 130mm, 5 <sup>1</sup> / <sub>8</sub> "	
without ratchet	250-064-142
with ratchet	250-064-147
Ø 0.5mm tip Ø 10mm handle, curved, 130mm, 5 <sup>1</sup> / <sub>8</sub> "	
without ratchet	250-064-146
with ratchet	250-064-145



Ø 0.4mm tip Ø 8mm handle, curved, 150mm, 6"	
without ratchet	250-064-148
Ø 0.4mm tip Ø 8mm handle, curved, 180mm, 7"	
without ratchet	250-064-245
Ø 0.5mm tip Ø 10mm handle, curved, 180mm, 7"	
without ratchet	250-064-248
Balanced Micro Needle Holder, Ø 8mm handle, curved, with tying platform Ø 0.4mm tip	
150mm, 6"	251-660-150
Ø 0.6mm tip	
180mm, 7"	251-660-180

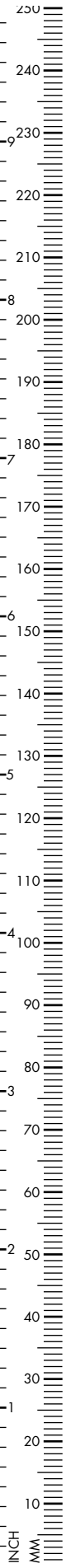



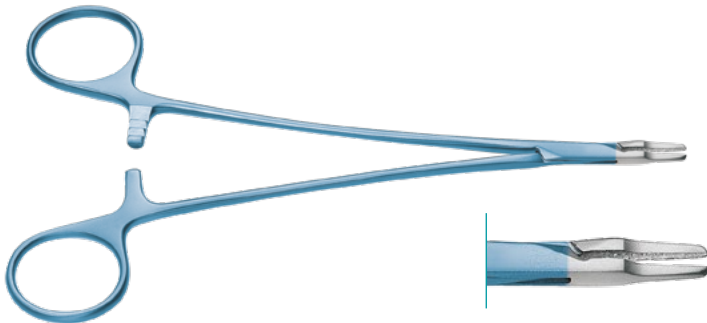

**RYDER**  
Needle Holder

150mm, 6"	180-660-150
170mm, 6 <sup>2</sup> / <sub>3</sub> "	180-660-170
190mm, 7 <sup>1</sup> / <sub>2</sub> "	180-660-190

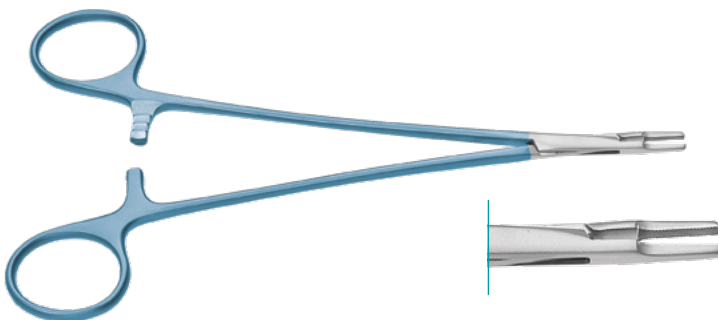

**RYDER**  
Needle Holder, TC jaw, delicate

150mm, 6"	180-661-150
170mm, 6 <sup>2</sup> / <sub>3</sub> "	180-661-170
190mm, 7 <sup>1</sup> / <sub>2</sub> "	180-661-190

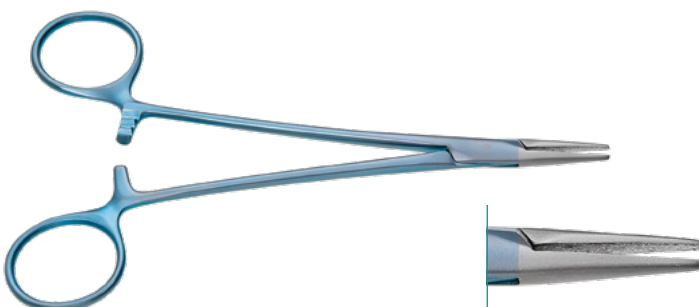

**Ryder**  
Vascular Needle Holder, TC jaw

160mm, 6 <sup>1</sup> / <sub>4</sub> "	180-674-160
180mm, 7"	180-674-180
200mm, 8"	180-674-200
220mm, 8 <sup>2</sup> / <sub>3</sub> "	180-674-220
250mm, 9 <sup>7</sup> / <sub>8</sub> "	180-674-250

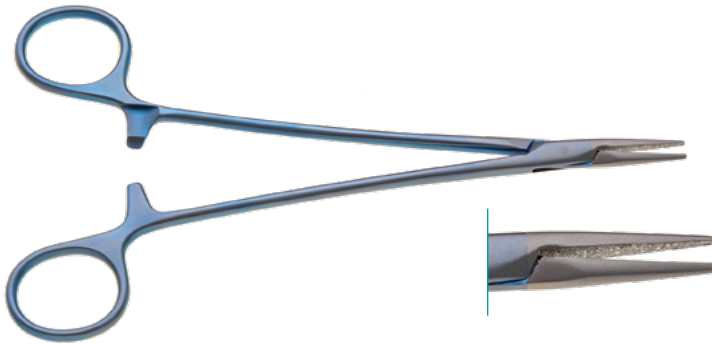

**DEBAKEY**  
Needle Holder

160mm, 6 <sup>1</sup> / <sub>4</sub> "	180-675-160
180mm, 7"	180-675-180
200mm, 8"	180-675-200
220mm, 8 <sup>2</sup> / <sub>3</sub> "	180-675-220
250mm, 9 <sup>7</sup> / <sub>8</sub> "	180-675-250

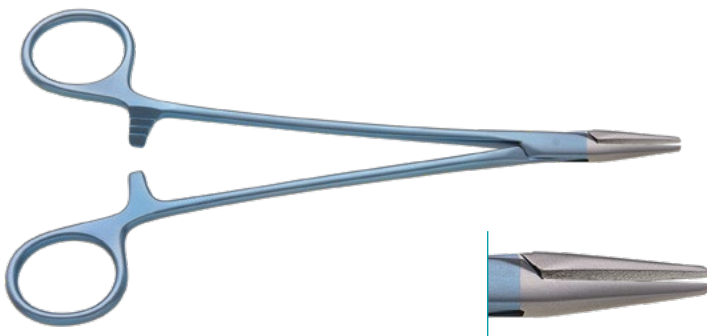

**MAYO-HEGAR**  
Needle Holder  
1.8mm fine jaw

160mm, 6 <sup>1</sup> / <sub>4</sub> "	180-680-160
180mm, 7"	180-680-180
200mm, 8"	180-680-200
220mm, 8 <sup>2</sup> / <sub>3</sub> "	180-680-220
250mm, 9 <sup>7</sup> / <sub>8</sub> "	180-680-250

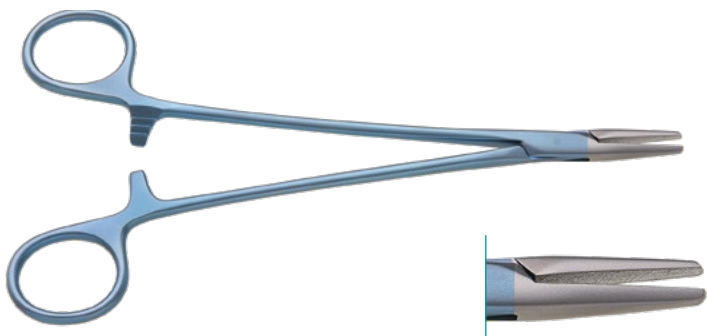

**MAYO-HEGAR**  
Needle Holder  
2.8mm broad jaw

160mm, 6 <sup>1</sup> / <sub>4</sub> "	180-690-160
180mm, 7"	180-690-180
200mm, 8"	180-690-200
220mm, 8 <sup>2</sup> / <sub>3</sub> "	180-690-220
250mm, 9 <sup>7</sup> / <sub>8</sub> "	180-690-250

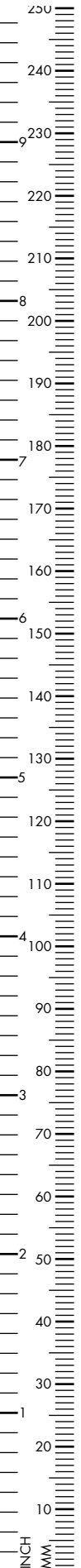

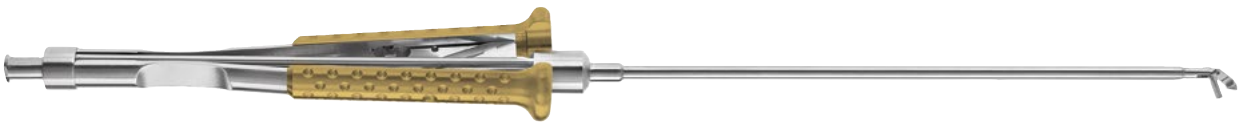

Ø 3.5mm shaft, 2x6mm, with ratchet, TC straight

170mm, 6 <sup>2</sup> / <sub>3</sub> "	295-034-200
250mm, 9 <sup>7</sup> / <sub>8</sub> "	295-035-200
300mm, 11 <sup>7</sup> / <sub>8</sub> "	295-037-200



Ø 3.5mm shaft, 2x6mm, with ratchet, TC curved

170mm, 6 <sup>2</sup> / <sub>3</sub> "	295-034-201
250mm, 9 <sup>7</sup> / <sub>8</sub> "	295-035-201
300mm, 11 <sup>7</sup> / <sub>8</sub> "	295-037-201



Ø 5.0mm shaft, 3x10mm, with ratchet, TC straight

170mm, 6 <sup>2</sup> / <sub>3</sub> "	295-048-200
250mm, 9 <sup>7</sup> / <sub>8</sub> "	295-050-200
300mm, 11 <sup>7</sup> / <sub>8</sub> "	295-052-200



Ø 5.0mm shaft, 3x10mm, with ratchet, TC curved left

170mm, 6 <sup>2</sup> / <sub>3</sub> "	295-048-201
250mm, 9 <sup>7</sup> / <sub>8</sub> "	295-050-201
300mm, 11 <sup>7</sup> / <sub>8</sub> "	295-052-201



Ø 5.0mm shaft, 3x10mm, with ratchet, TC curved right

170mm, 6 <sup>2</sup> / <sub>3</sub> "	295-048-202
250mm, 9 <sup>7</sup> / <sub>8</sub> "	295-050-202
300mm, 11 <sup>7</sup> / <sub>8</sub> "	295-052-202



**RYDER**  
Ø 5.0mm shaft, 1x8mm, with ratchet, TC straight

170mm, 6 <sup>2</sup> / <sub>3</sub> "	295-048-210
250mm, 9 <sup>7</sup> / <sub>8</sub> "	295-050-210
300mm, 11 <sup>7</sup> / <sub>8</sub> "	295-052-210



**RYDER**  
Ø 5.0mm shaft, 1x10mm, with ratchet, TC straight

170mm, 6 <sup>2</sup> / <sub>3</sub> "	295-048-212
250mm, 9 <sup>7</sup> / <sub>8</sub> "	295-050-212
300mm, 11 <sup>7</sup> / <sub>8</sub> "	295-052-212



Ø 5.0mm shaft, 2x8mm, with ratchet, TC straight

170mm, 6 <sup>2</sup> / <sub>3</sub> "	295-048-214
250mm, 9 <sup>7</sup> / <sub>8</sub> "	295-050-214
300mm, 11 <sup>7</sup> / <sub>8</sub> "	295-052-214



 Ø 5.0mm shaft, 3x10mm, with ratchet, diamond dusted, straight

170mm, 6 <sup>2</sup> / <sub>3</sub> "	295-048-216
250mm, 9 <sup>7</sup> / <sub>8</sub> "	295-050-216
300mm, 11 <sup>7</sup> / <sub>8</sub> "	295-052-216



 Ø 5.0mm shaft, 3x10mm, with ratchet, diamond dusted, curved left

170mm, 6 <sup>2</sup> / <sub>3</sub> "	295-048-217
250mm, 9 <sup>7</sup> / <sub>8</sub> "	295-050-217
300mm, 11 <sup>7</sup> / <sub>8</sub> "	295-052-217



**CRILE WOOD**  
Ø 5.0mm shaft, 3x10mm, with ratchet, TC curved left

170mm, 6 <sup>2</sup> / <sub>3</sub> "	295-048-219
250mm, 9 <sup>7</sup> / <sub>8</sub> "	295-050-219
300mm, 11 <sup>7</sup> / <sub>8</sub> "	295-052-219

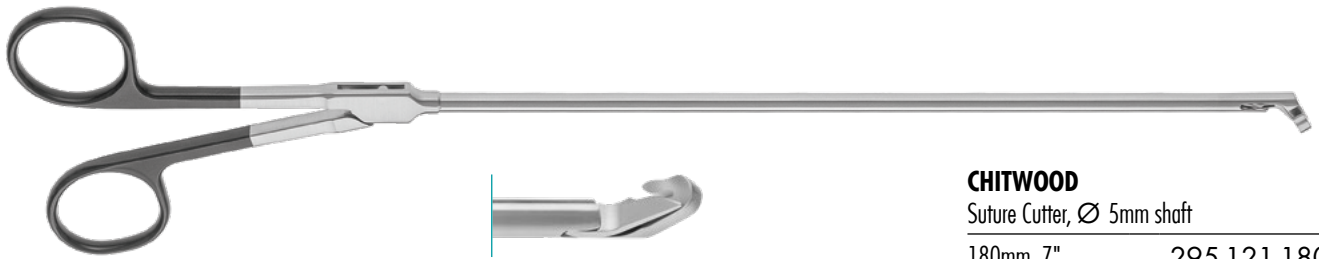

### CHITWOOD

Suture Cutter, Ø 5mm shaft

180mm, 7" 295-121-180

230mm, 9" 295-121-230

280mm, 11" 295-121-280



### SLIDER

Needle Holder, straight, max. 4-0 suture,  
210mm working length, Ø 7mm shaft  
345mm, 12<sup>3/4</sup>"

straight 295-180-000

curved 295-180-001

Ø 10mm shaft

straight 295-180-002

curved 295-180-003



Knot Pusher for valve surgery  
Ø 8.0mm tip

345mm, 12<sup>3/4</sup>" 295-000-020

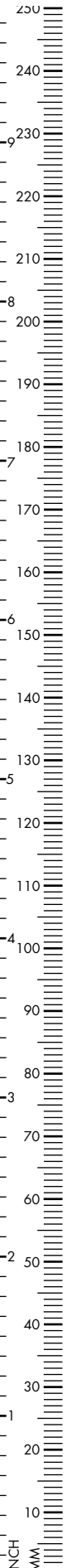



Cardioplegia Needle  
310mm, 12<sup>1/4</sup>"

Ø 2.0mm	295-165-002
---------	-------------

Ø 3.0mm	295-165-003
---------	-------------



Magnetic Retriever

370mm, 14 <sup>1/2</sup> "	295-300-000
----------------------------	-------------



Suture Ruler, 0 - 60mm measuring range

430mm, 17"	295-100-350
------------	-------------



Suture Catcher for valve surgery  
2mm tip width

350mm, 14" 295-000-010



Suture Catcher  
2mm tip width

320mm, 12½" 295-000-110



Ø 4.0mm shaft, Valve Rongeur, oval, 4mm,  
single action, straight

170mm, 6<sup>2</sup>/<sub>3</sub>" 295-039-300  
250mm, 9<sup>7</sup>/<sub>8</sub>" 295-040-300  
300mm, 11<sup>7</sup>/<sub>8</sub>" 295-041-300



Ø 4.0mm shaft, Valve Rongeur, oval, 4mm,  
single action, 30° angled

170mm, 6<sup>2</sup>/<sub>3</sub>" 295-039-301  
250mm, 9<sup>7</sup>/<sub>8</sub>" 295-040-301  
300mm, 11<sup>7</sup>/<sub>8</sub>" 295-041-301

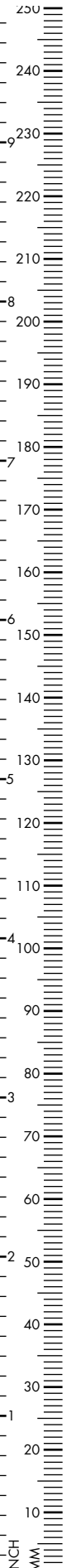



**DEBAKEY**

Ø 3.5mm shaft, 2x1 teeth, 2.8 x 14mm,  
double action, 45° lateral angled  
without ratchet

170mm, 6 <sup>2</sup> / <sub>3</sub> "	295-034-253
250mm, 9 <sup>7</sup> / <sub>8</sub> "	295-035-253
300mm, 11 <sup>7</sup> / <sub>8</sub> "	295-037-253

with ratchet

170mm, 6 <sup>2</sup> / <sub>3</sub> "	295-033-253
250mm, 9 <sup>7</sup> / <sub>8</sub> "	295-036-253
300mm, 11 <sup>7</sup> / <sub>8</sub> "	295-038-253



**DEBAKEY**

Ø 5.0mm shaft, 2x1 teeth, 1.5 x 10mm,  
double action, straight  
without ratchet

170mm, 6 <sup>2</sup> / <sub>3</sub> "	295-048-250
250mm, 9 <sup>7</sup> / <sub>8</sub> "	295-050-250
300mm, 11 <sup>7</sup> / <sub>8</sub> "	295-052-250

with ratchet

170mm, 6 <sup>2</sup> / <sub>3</sub> "	295-049-250
250mm, 9 <sup>7</sup> / <sub>8</sub> "	295-051-250
300mm, 11 <sup>7</sup> / <sub>8</sub> "	295-053-250



**DEBAKEY**

Ø 5.0mm shaft, 2x1 teeth, 2.8 x 10mm,  
double action, straight  
without ratchet

170mm, 6 <sup>2</sup> / <sub>3</sub> "	295-048-251
250mm, 9 <sup>7</sup> / <sub>8</sub> "	295-050-251
300mm, 11 <sup>7</sup> / <sub>8</sub> "	295-052-251

with ratchet

170mm, 6 <sup>2</sup> / <sub>3</sub> "	295-049-251
250mm, 9 <sup>7</sup> / <sub>8</sub> "	295-051-251
300mm, 11 <sup>7</sup> / <sub>8</sub> "	295-053-251



**DEBAKEY**

Ø 5.0mm shaft, 2x1 teeth, 1.5 x 14mm,  
single action, straight  
without ratchet

170mm, 6 <sup>2</sup> / <sub>3</sub> "	295-048-252
250mm, 9 <sup>7</sup> / <sub>8</sub> "	295-050-252
300mm, 11 <sup>7</sup> / <sub>8</sub> "	295-052-252

with ratchet

170mm, 6 <sup>2</sup> / <sub>3</sub> "	295-049-252
250mm, 9 <sup>7</sup> / <sub>8</sub> "	295-051-252
300mm, 11 <sup>7</sup> / <sub>8</sub> "	295-053-252



**DEBAKEY**

Ø 5.0mm shaft, 2x1 teeth, 1.5 x 14mm,  
single action, 45° angled  
without ratchet

170mm, 6 <sup>2</sup> / <sub>3</sub> "	295-048-253
250mm, 9 <sup>7</sup> / <sub>8</sub> "	295-050-253
300mm, 11 <sup>7</sup> / <sub>8</sub> "	295-052-253

with ratchet

170mm, 6 <sup>2</sup> / <sub>3</sub> "	295-049-253
250mm, 9 <sup>7</sup> / <sub>8</sub> "	295-051-253
300mm, 11 <sup>7</sup> / <sub>8</sub> "	295-053-253



**DEBAKEY**

Ø 5.0mm shaft, 3x2 teeth, 4.8 x 10mm,  
double action, straight  
without ratchet

170mm, 6 <sup>2</sup> / <sub>3</sub> "	295-048-254
250mm, 9 <sup>7</sup> / <sub>8</sub> "	295-050-254
300mm, 11 <sup>7</sup> / <sub>8</sub> "	295-052-254

with ratchet

170mm, 6 <sup>2</sup> / <sub>3</sub> "	295-049-254
250mm, 9 <sup>7</sup> / <sub>8</sub> "	295-051-254
300mm, 11 <sup>7</sup> / <sub>8</sub> "	295-053-254



### DEBAKEY

Ø 5.0mm shaft, 2x1 teeth, 2.8 x 28mm, single action, 45° lateral angled without ratchet

170mm, 6 <sup>2</sup> / <sub>3</sub> "	295-048-255
250mm, 9 <sup>7</sup> / <sub>8</sub> "	295-050-255
300mm, 11 <sup>7</sup> / <sub>8</sub> "	295-052-255

with ratchet

170mm, 6 <sup>2</sup> / <sub>3</sub> "	295-049-255
250mm, 9 <sup>7</sup> / <sub>8</sub> "	295-051-255
300mm, 11 <sup>7</sup> / <sub>8</sub> "	295-053-255



Ø 5.0mm shaft, Knot Pusher single action, 45° angled without ratchet

170mm, 6 <sup>2</sup> / <sub>3</sub> "	295-048-260
250mm, 9 <sup>7</sup> / <sub>8</sub> "	295-050-260
300mm, 11 <sup>7</sup> / <sub>8</sub> "	295-052-260

with ratchet

170mm, 6 <sup>2</sup> / <sub>3</sub> "	295-049-260
250mm, 9 <sup>7</sup> / <sub>8</sub> "	295-051-260
300mm, 11 <sup>7</sup> / <sub>8</sub> "	295-053-260



### RESANO

Ø 5.0mm shaft, Grasping Forceps single action, straight without ratchet

170mm, 6 <sup>2</sup> / <sub>3</sub> "	295-048-265
250mm, 9 <sup>7</sup> / <sub>8</sub> "	295-050-265
300mm, 11 <sup>7</sup> / <sub>8</sub> "	295-052-265

with ratchet

170mm, 6 <sup>2</sup> / <sub>3</sub> "	295-049-265
250mm, 9 <sup>7</sup> / <sub>8</sub> "	295-051-265
300mm, 11 <sup>7</sup> / <sub>8</sub> "	295-053-265



### RESANO

Ø 5.0mm shaft, Grasping Forceps double action, conical shape without ratchet

170mm, 6 <sup>2</sup> / <sub>3</sub> "	295-048-270
250mm, 9 <sup>7</sup> / <sub>8</sub> "	295-050-270
300mm, 11 <sup>7</sup> / <sub>8</sub> "	295-052-270

with ratchet

170mm, 6 <sup>2</sup> / <sub>3</sub> "	295-049-270
250mm, 9 <sup>7</sup> / <sub>8</sub> "	295-051-270
300mm, 11 <sup>7</sup> / <sub>8</sub> "	295-053-270



### GEMINI

Ø 5.0mm shaft, smooth double action, curved without ratchet

170mm, 6 <sup>2</sup> / <sub>3</sub> "	295-048-280
250mm, 9 <sup>7</sup> / <sub>8</sub> "	295-050-280
300mm, 11 <sup>7</sup> / <sub>8</sub> "	295-052-280

with ratchet

170mm, 6 <sup>2</sup> / <sub>3</sub> "	295-049-280
250mm, 9 <sup>7</sup> / <sub>8</sub> "	295-051-280
300mm, 11 <sup>7</sup> / <sub>8</sub> "	295-053-280

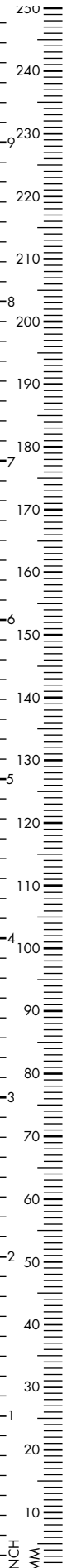



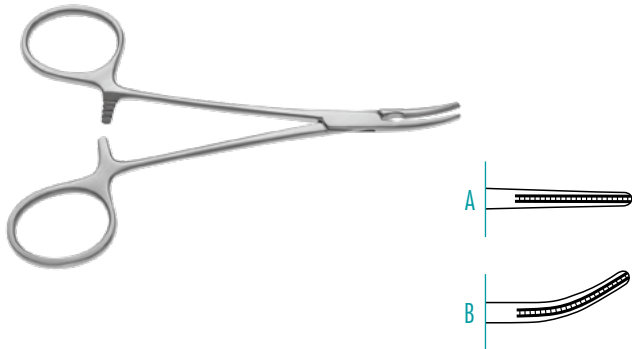

### DEBAKEY MOSQUITO

Hemostatic Forceps, 120mm, 4<sup>3</sup>/<sub>4</sub>"

A straight	290-438-120
B curved	290-439-120

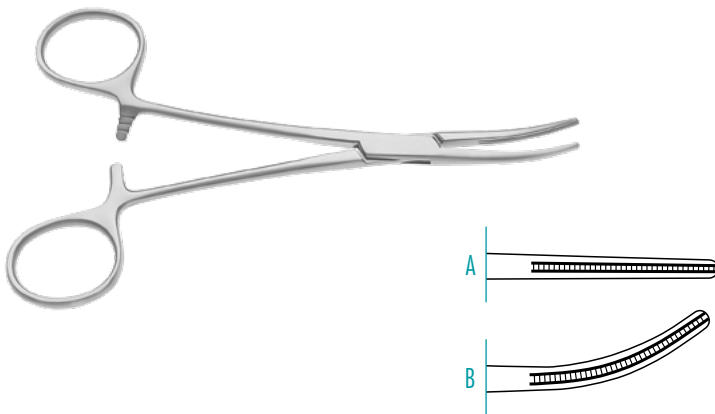

### DEBAKEY KELLY

Atraumatic Forceps, 140mm, 5<sup>1</sup>/<sub>2</sub>"

A straight	290-410-140
B curved	290-411-140

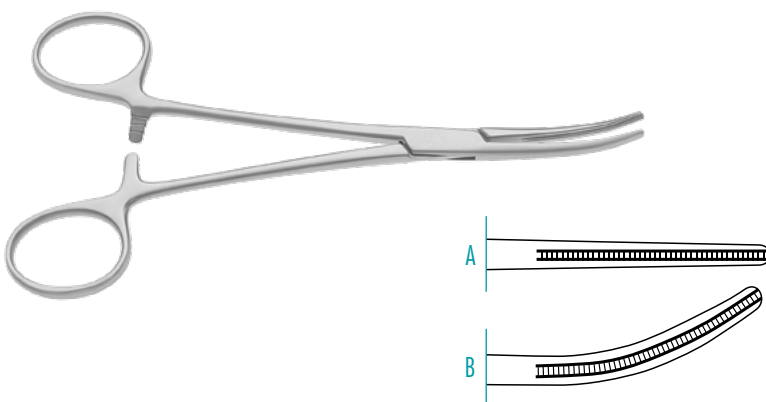

### DEBAKEY RANKIN

Hemostatic Forceps, 160mm, 6<sup>1</sup>/<sub>4</sub>"

A straight	290-300-160
B curved	290-301-160

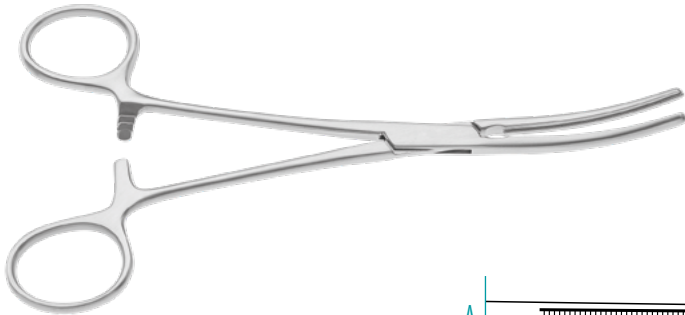

### DEBAKEY PEAN

Hemostatic Forceps, straight

A	140mm, 5 <sup>1</sup> / <sub>2</sub> "	290-438-140
B	160mm, 6 <sup>1</sup> / <sub>4</sub> "	290-438-160
C	180mm, 7"	290-438-180
D	200mm, 8"	290-438-200
E	260mm, 10 <sup>1</sup> / <sub>4</sub> "	290-438-260
F	280mm, 11"	290-438-280

curved

G	140mm, 5 <sup>1</sup> / <sub>2</sub> "	290-439-140
H	160mm, 6 <sup>1</sup> / <sub>4</sub> "	290-439-160
I	180mm, 7"	290-439-180
J	200mm, 8"	290-439-200
K	260mm, 10 <sup>1</sup> / <sub>4</sub> "	290-439-260
L	280mm, 11"	290-439-280

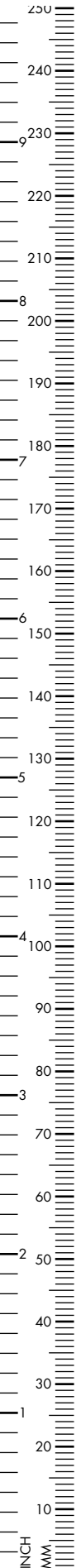
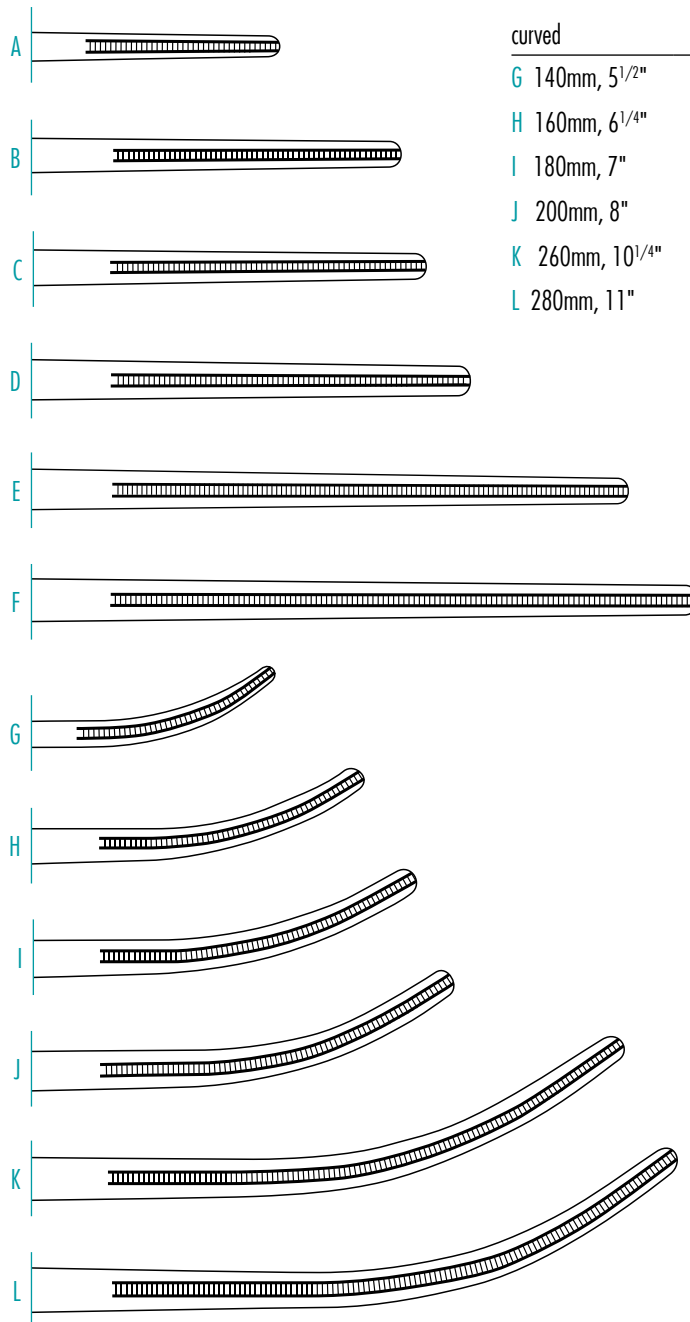

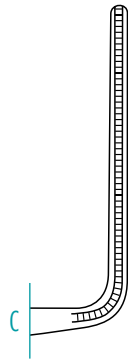
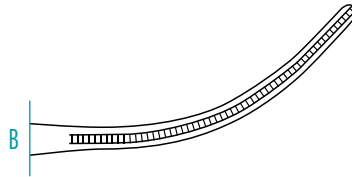
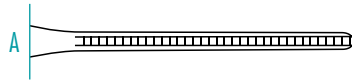

### DEBAKEY

Clamp, straight shanks,

A straight jaw	290-458-120
120mm, 4 <sup>3</sup> / <sub>4</sub> "	
B curved jaw	290-458-110
110mm, 4 <sup>1</sup> / <sub>3</sub> "	
C angled jaw	290-458-100
100mm, 4"	

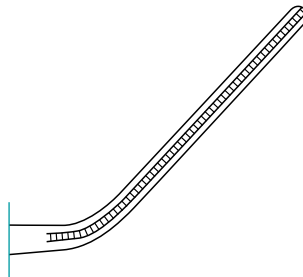

Shanks curved backwards

130mm, 5 <sup>1</sup> / <sub>8</sub> "	290-459-130
--	-------------

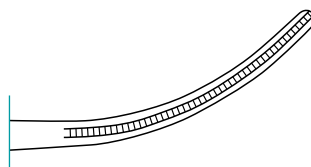
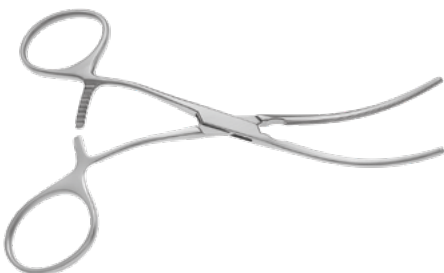

S-curved shanks

125mm, 5"	290-459-120
-----------	-------------

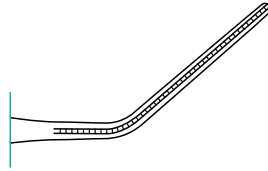
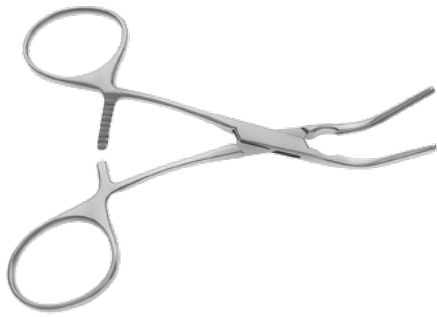
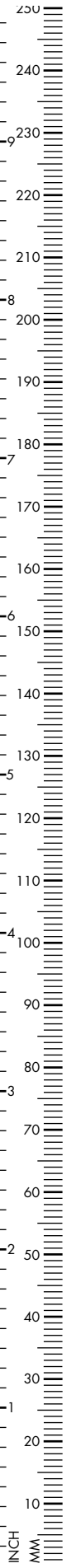

### NOON

A.V. Fistula Clamp, 1x2 draft, 50° angled

110mm, 4<sup>1</sup>/<sub>3</sub>" 290-460-110

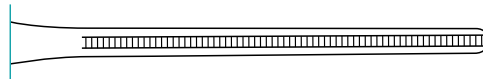

### DEMOS

Tibial Artery Clamp, 60° angled shanks

200mm, 8" 290-407-200

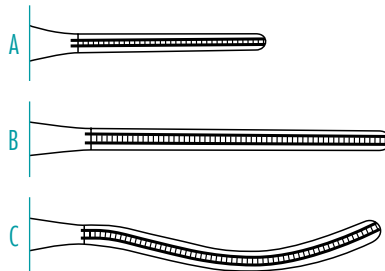
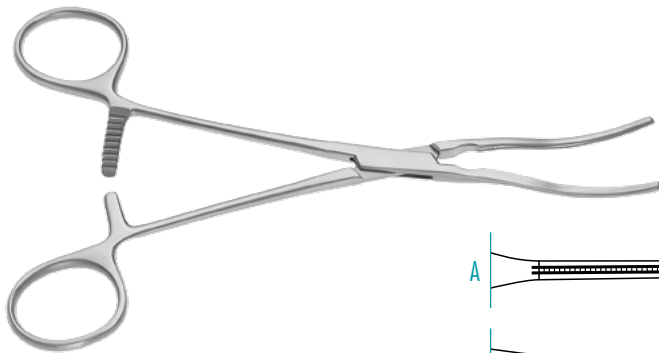

### DEBAKEY

Pediatric Forceps, straight shanks

A 160mm, 6<sup>1</sup>/<sub>4</sub>" 290-440-160

B 170mm, 6<sup>2</sup>/<sub>3</sub>" 290-440-170

C 165mm, 6<sup>1</sup>/<sub>2</sub>" 290-451-170

D 155mm, 6<sup>1</sup>/<sub>8</sub>" 290-442-150

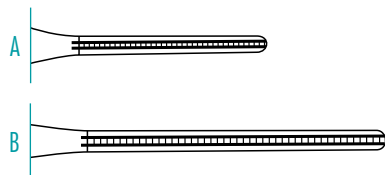

shanks angled forward

A 155mm, 6<sup>1</sup>/<sub>8</sub>" 290-447-155

B 170mm, 6<sup>2</sup>/<sub>3</sub>" 290-447-170

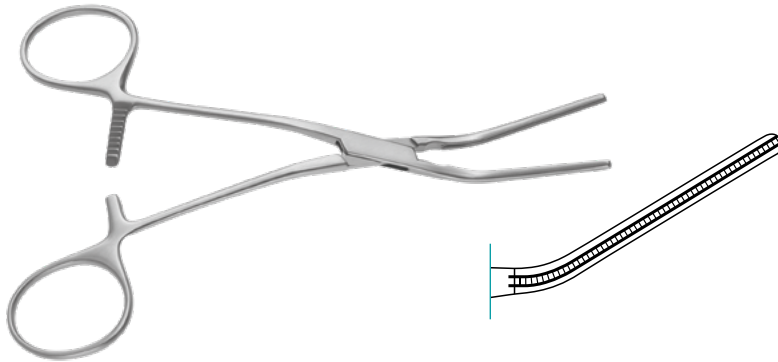

**DEBAKEY**

Pediatric Forceps,  
shanks curved backwards, 30° angled

160mm, 6<sup>1</sup>/<sub>4</sub>"

290-441-160

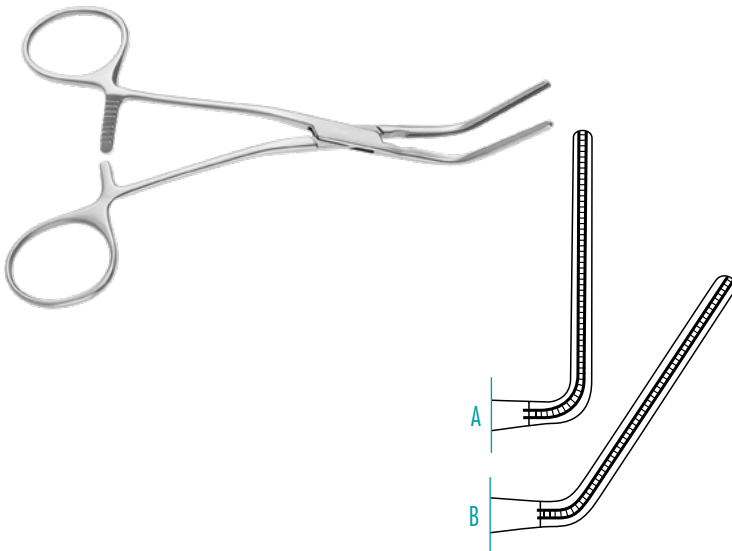

**DEBAKEY**

Pediatric Forceps, 150mm, 6"

A 90°

290-445-150

B 60°

290-443-150



### SAROT

Bronchus Clamp with pins, 230mm, 9"

Teeth left 290-237-230

Teeth right 290-238-230



### LEES

Bronchus Clamp

A 230mm, 9" 290-427-230

Bronchus Clamp

B 250mm, 9<sup>7</sup>/<sub>8</sub>" 290-429-250

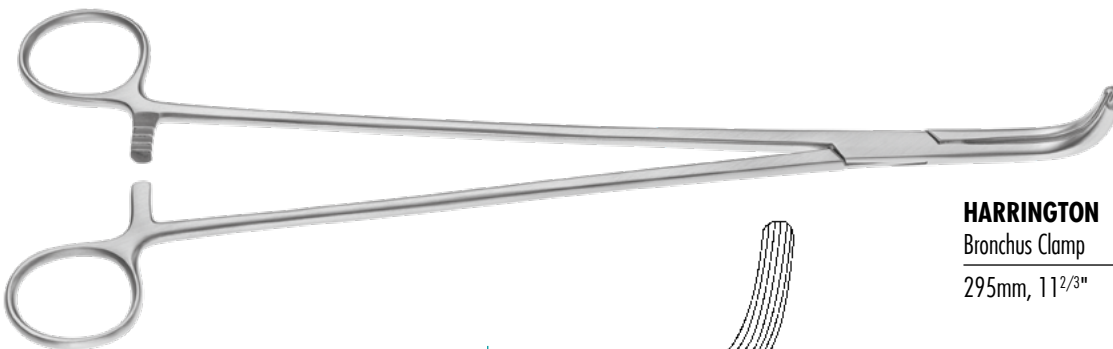
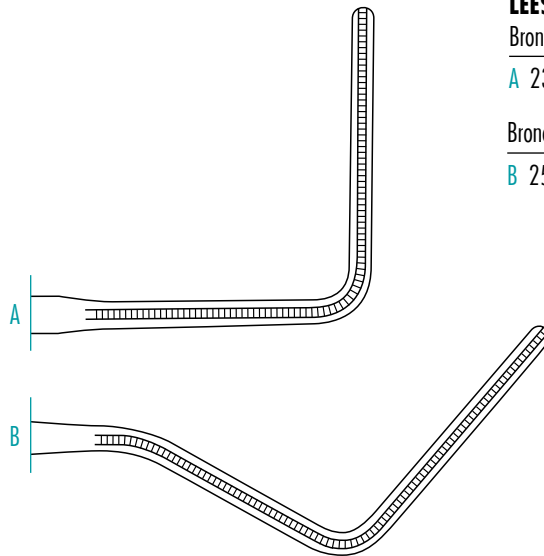

### HARRINGTON

Bronchus Clamp

295mm, 11<sup>2</sup>/<sub>3</sub>" 290-271-295

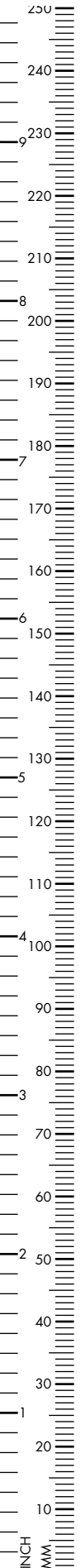
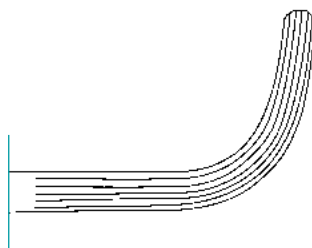

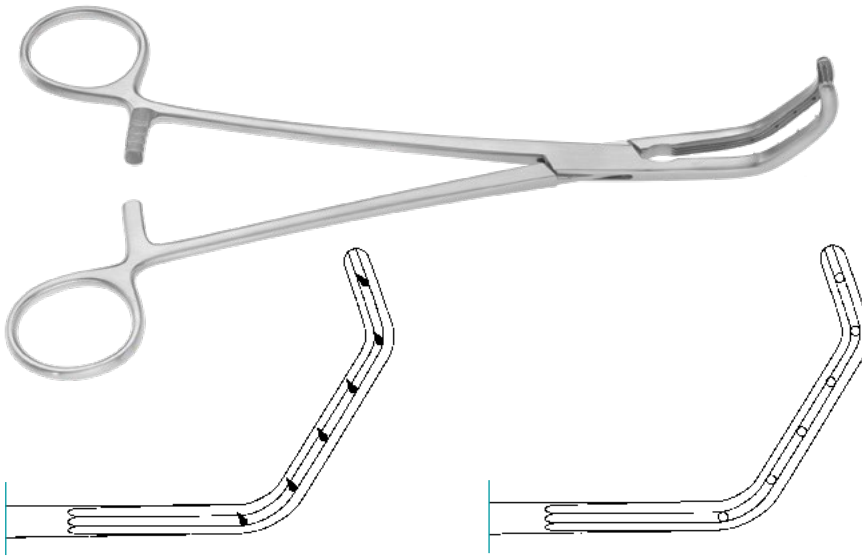

**PRICE THOMAS**

Bronchus Forceps, 220mm, 8<sup>2</sup>/<sub>3</sub>"

Fig. 1, teeth left      290-245-220

Fig. 2, teeth right      290-247-220

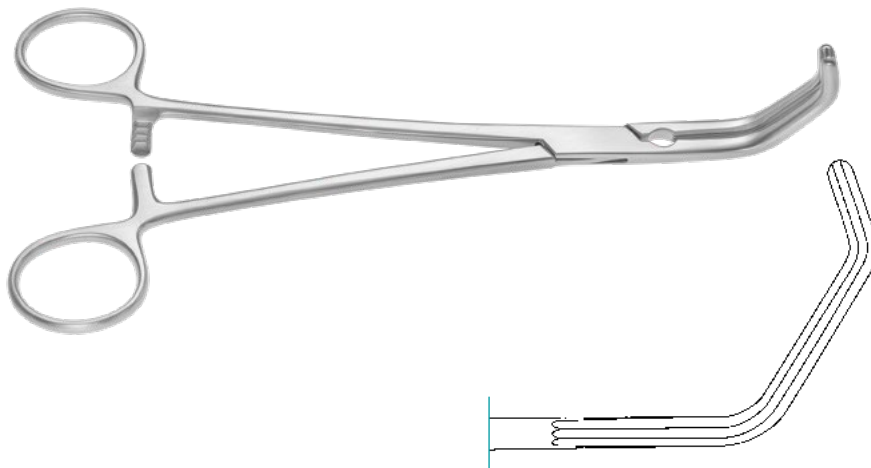

**PRICE THOMAS**

Bronchus Forceps

220mm, 8<sup>2</sup>/<sub>3</sub>"      290-241-220

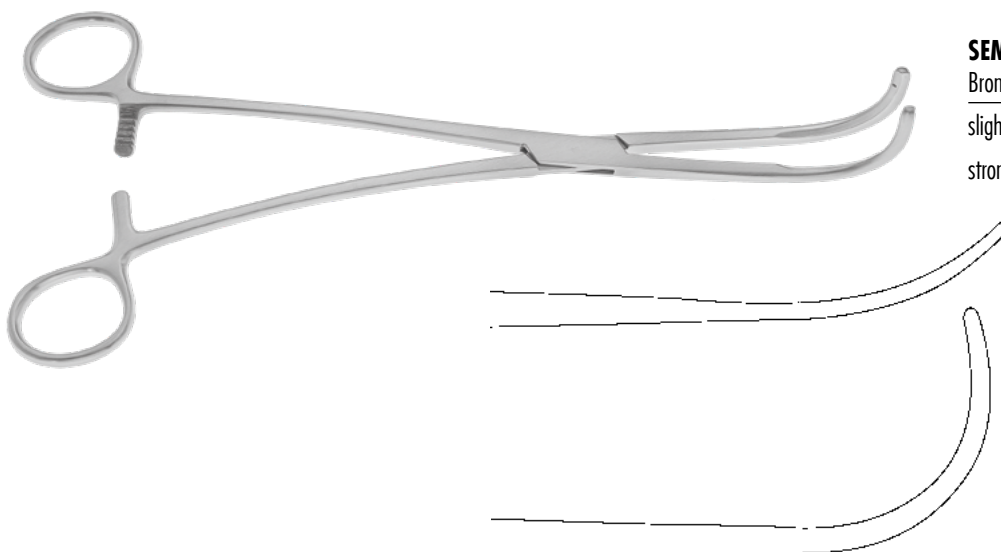

**SEMB**

Bronchus Forceps, 250mm, 9<sup>7</sup>/<sub>8</sub>"

slightly curved      290-265-240

strongly curved      290-267-240

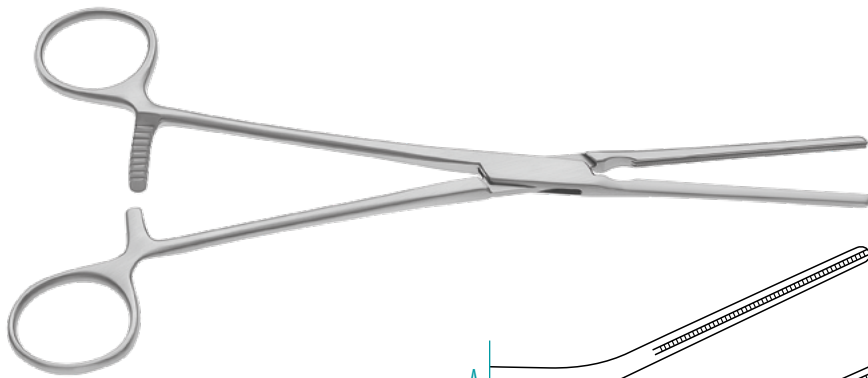

### POTTS

Clamp/Forceps,  
straight, angled jaw

A	205mm, 8 <sup>1</sup> / <sub>8</sub> "	290-401-210
B	220mm, 8 <sup>2</sup> / <sub>3</sub> "	290-401-220

straight jaw

C	205mm, 8 <sup>1</sup> / <sub>8</sub> "	290-400-210
D	220mm, 8 <sup>2</sup> / <sub>3</sub> "	290-400-220
E	260mm, 10 <sup>1</sup> / <sub>4</sub> "	290-400-260

### DEBAKEY POTTS

Clamp, straight shanks

F	220mm, 8 <sup>2</sup> / <sub>3</sub> "	290-400-225
G	195mm, 7 <sup>3</sup> / <sub>4</sub> "	290-400-195

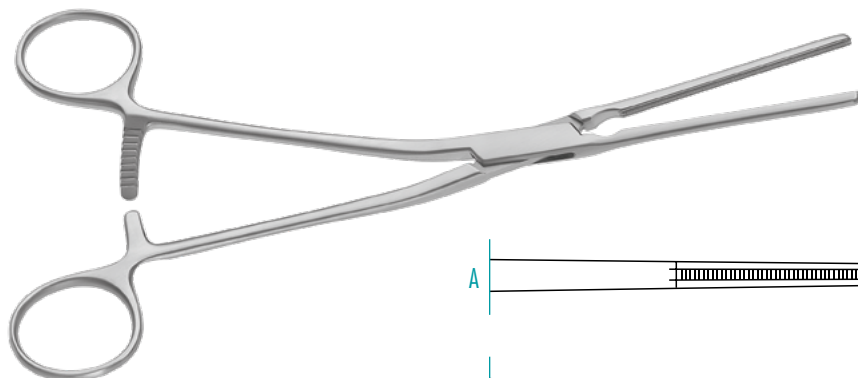
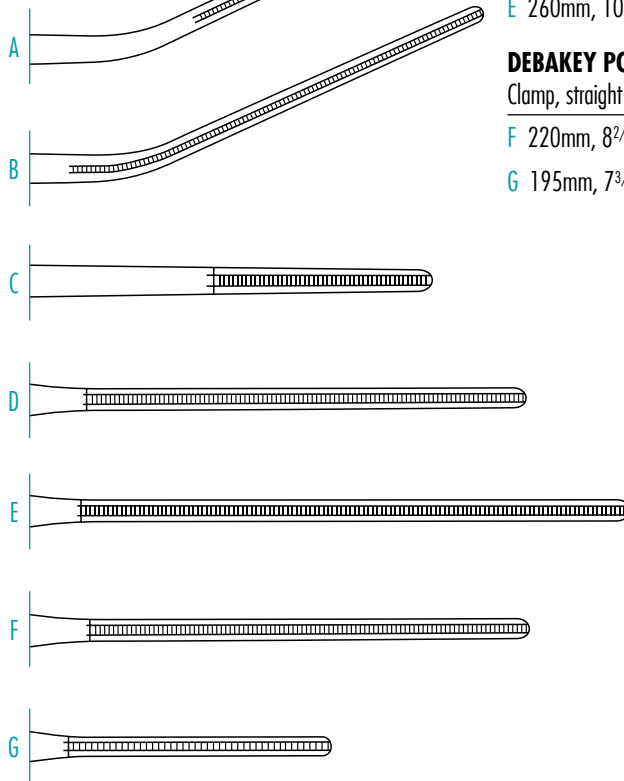

### POTTS

Clamp/Forceps, angled, straight jaw

A	210mm, 8 <sup>1</sup> / <sub>4</sub> "	290-403-210
B	220mm, 8 <sup>2</sup> / <sub>3</sub> "	290-403-220
C	260mm, 10 <sup>1</sup> / <sub>4</sub> "	290-403-260

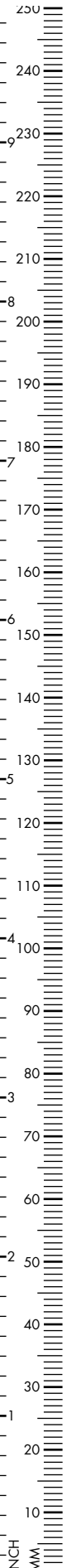
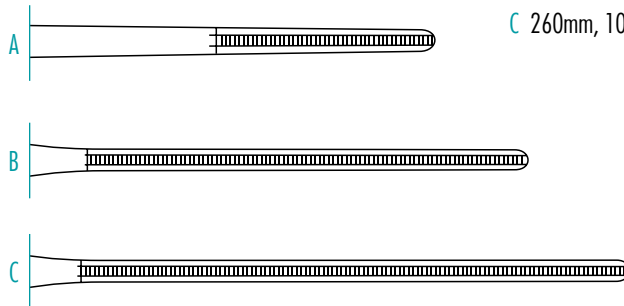





### DEBAKEY

Clamp, straight jaw

A	215mm, 8 <sup>1</sup> / <sub>2</sub> "	290-434-210
B	230mm, 9"	290-434-230
C	270mm, 10 <sup>2</sup> / <sub>3</sub> "	290-434-270
D	315mm, 12 <sup>1</sup> / <sub>2</sub> "	290-434-310

curved jaw

E	215mm, 8 <sup>1</sup> / <sub>2</sub> "	290-435-210
F	230mm, 9"	290-435-230
G	270mm, 10 <sup>2</sup> / <sub>3</sub> "	290-435-270
H	315mm, 12 <sup>1</sup> / <sub>2</sub> "	290-435-310

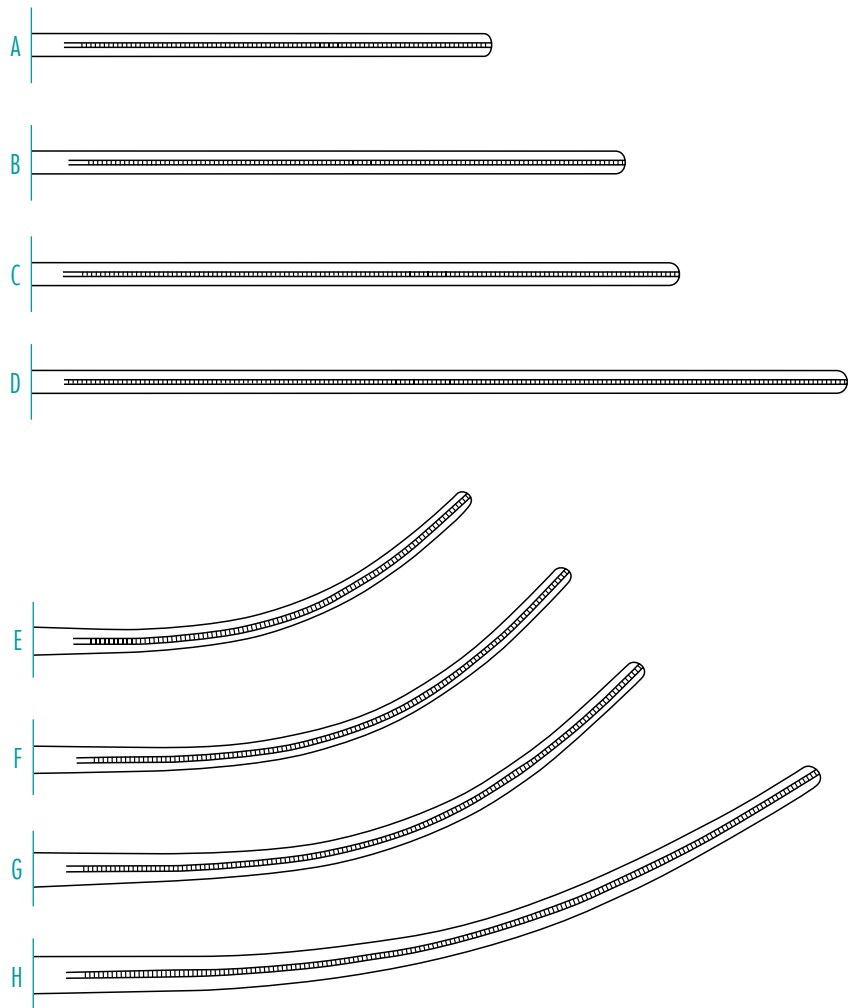

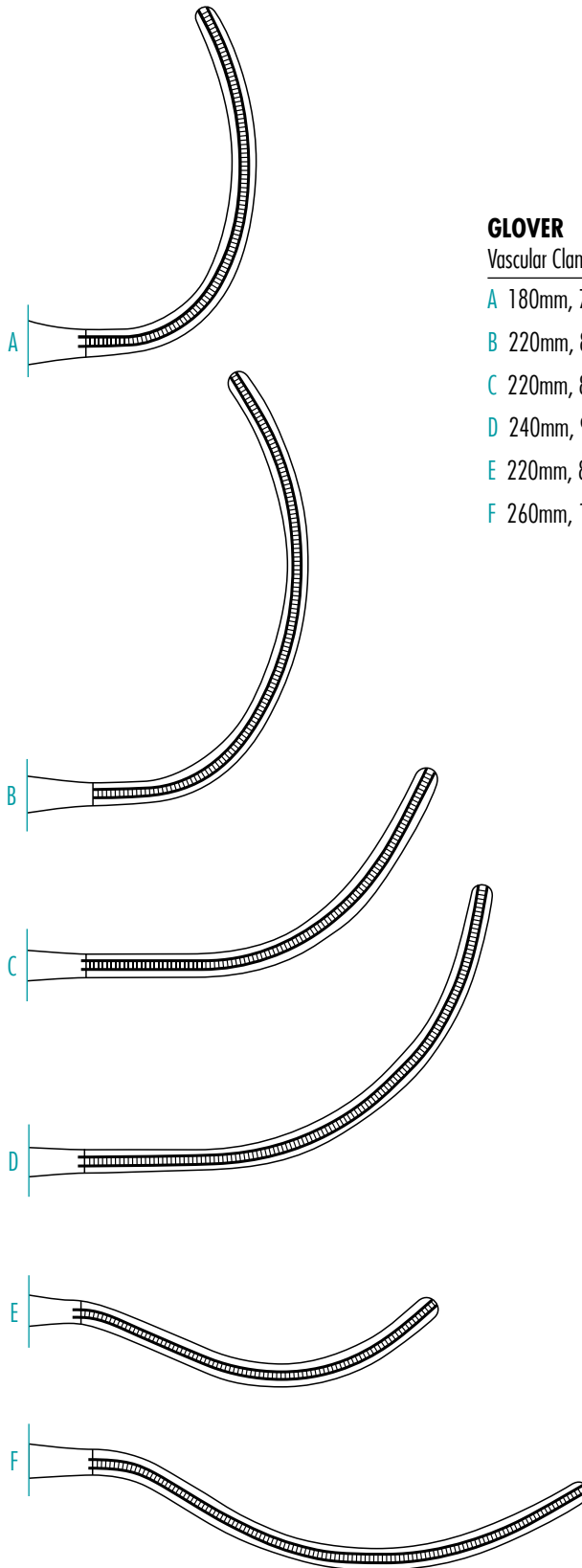
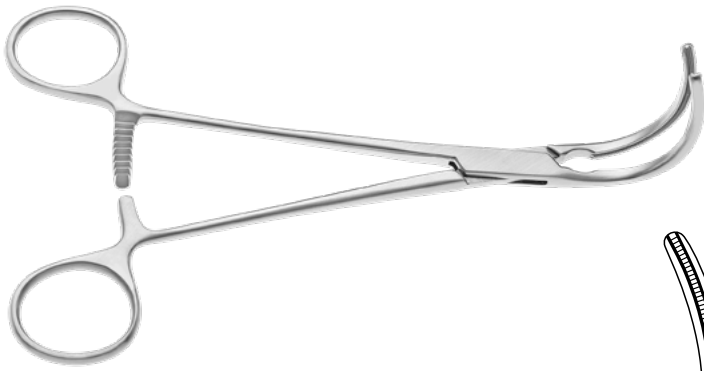

### GLOVER

#### Vascular Clamp

A	180mm, 7"	290-405-195
B	220mm, 8 <sup>2</sup> / <sub>3</sub> "	290-405-210
C	220mm, 8 <sup>2</sup> / <sub>3</sub> "	290-451-215
D	240mm, 9 <sup>1</sup> / <sub>2</sub> "	290-451-240
E	220mm, 8 <sup>2</sup> / <sub>3</sub> "	290-412-220
F	260mm, 10 <sup>1</sup> / <sub>4</sub> "	290-412-260

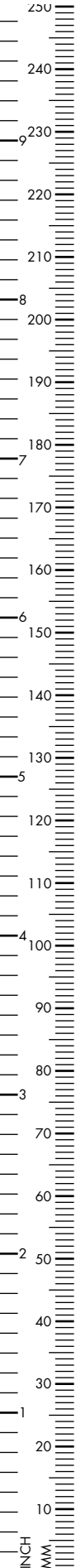

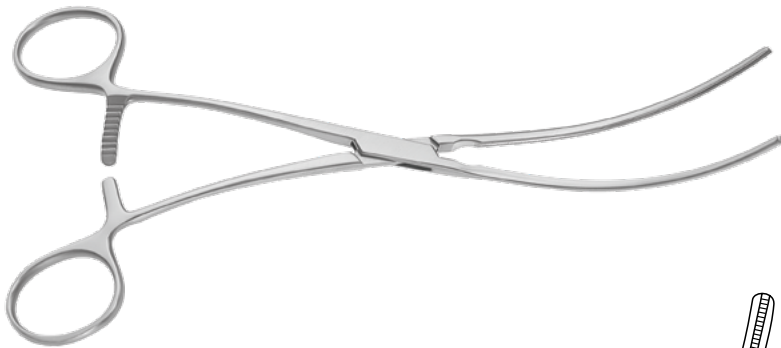

### DEBAKEY

Peripheral Vascular Clamp

A	160mm, 6 <sup>1</sup> / <sub>4</sub> "	290-409-160
B	190mm, 7 <sup>1</sup> / <sub>2</sub> "	290-411-190
C	200mm, 8"	290-411-200

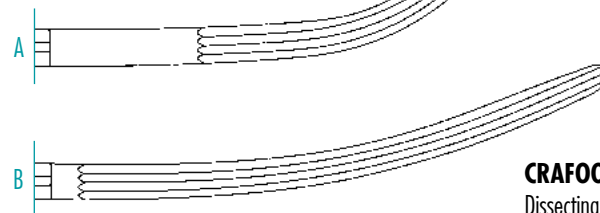
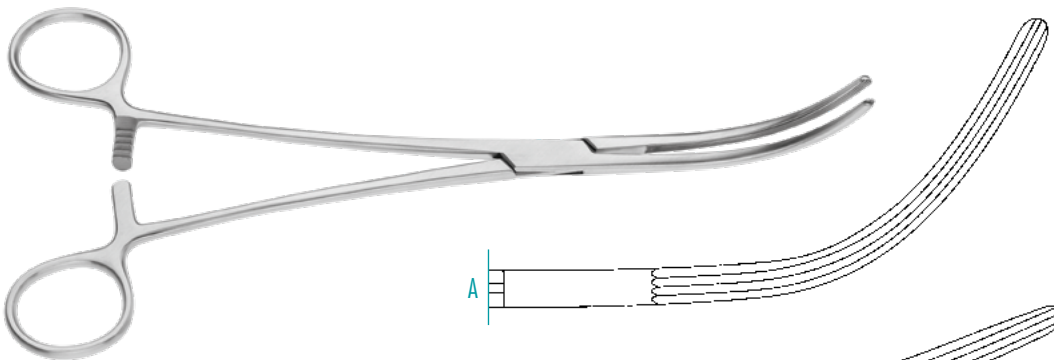
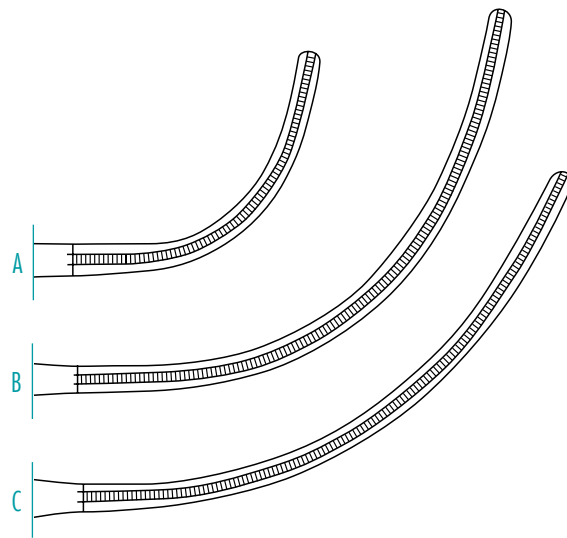

### CRAFOORD SELLORS

Dissecting Forceps

A	230mm, 9"	140-383-230
B	240mm, 9 <sup>1</sup> / <sub>2</sub> "	140-385-240

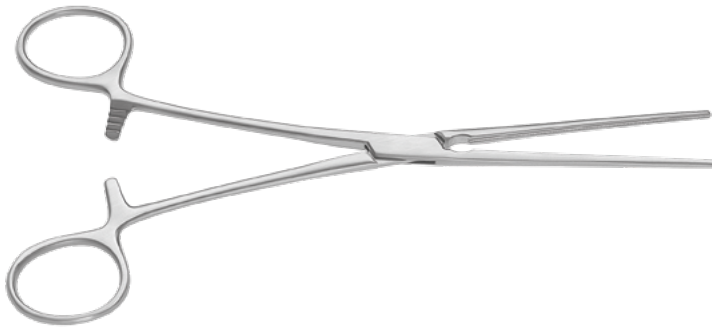

### DEBAKEY BAINBRIDGE

Vascular Forceps

A	150mm, 6"	290-414-150
B	180mm, 7"	290-414-180
C	150mm, 6"	290-415-150
D	180mm, 7"	290-415-180

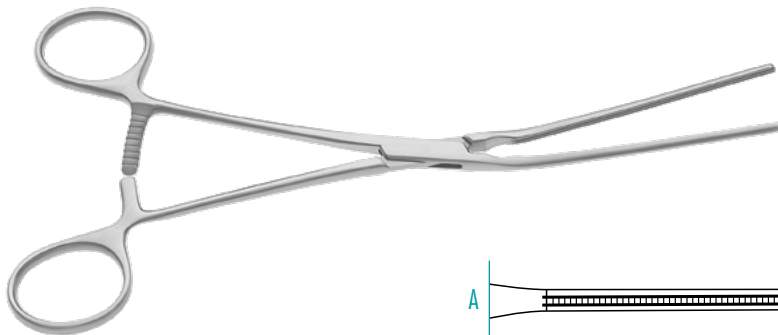
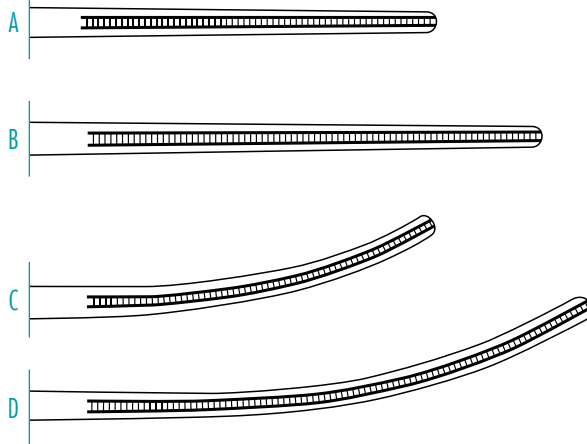

### LELAND JONES

Peripheral Vascular Forceps, straight

A	200mm, 8"	290-413-195
15° angled		
B	200mm, 8"	290-413-200
30° angled		
C	190mm, 7 <sup>1</sup> / <sub>2</sub> "	290-413-190

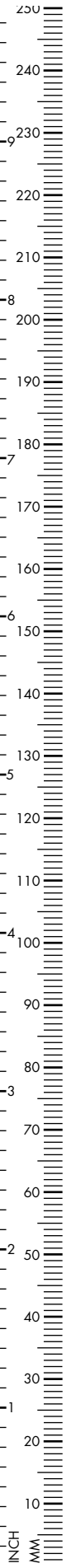
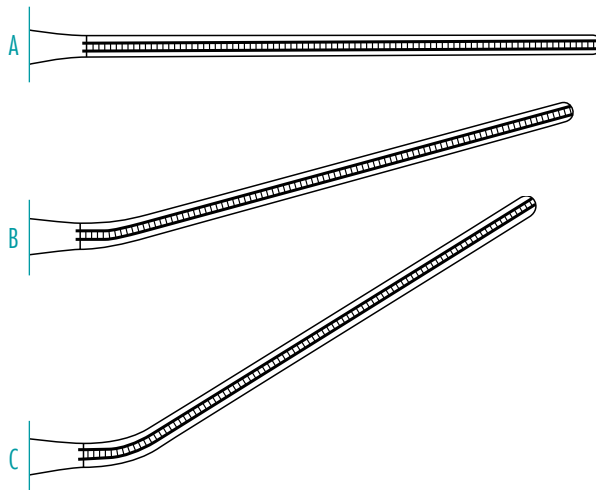

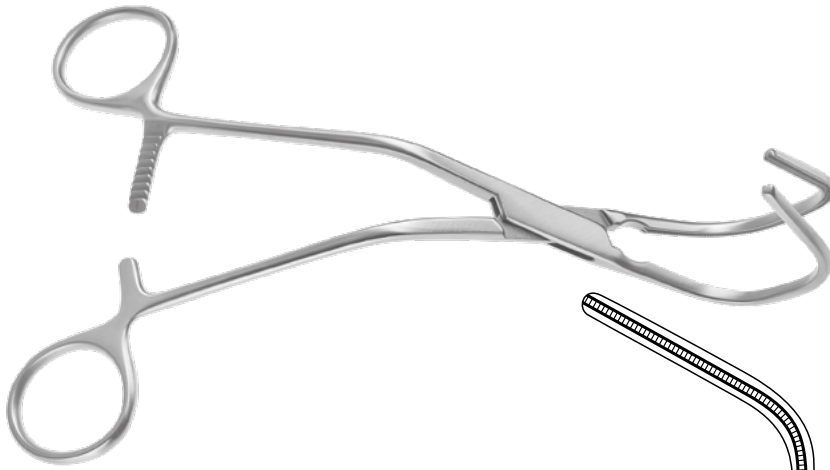

### KAY LAMBERT

Clamp

A	220mm, 8 <sup>2</sup> / <sub>3</sub> "	290-430-220
B	210mm, 8 <sup>1</sup> / <sub>4</sub> "	290-430-210

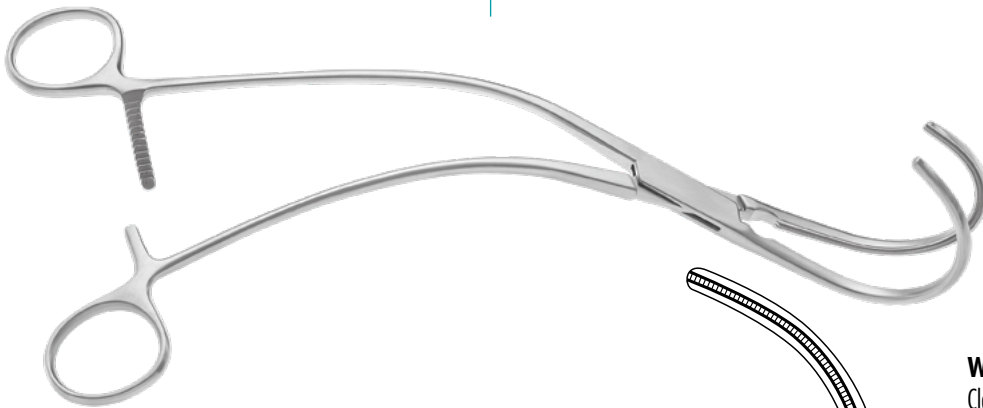
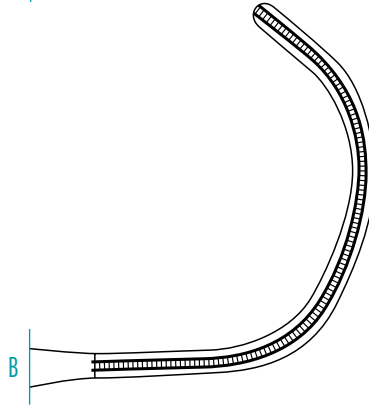
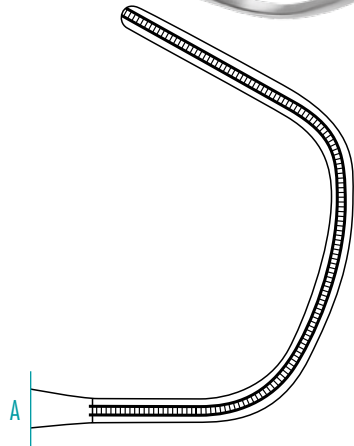

### WEBER

Clamp, 260mm, 10<sup>1</sup>/<sub>4</sub>"

curved left	290-424-001
curved right	290-424-002

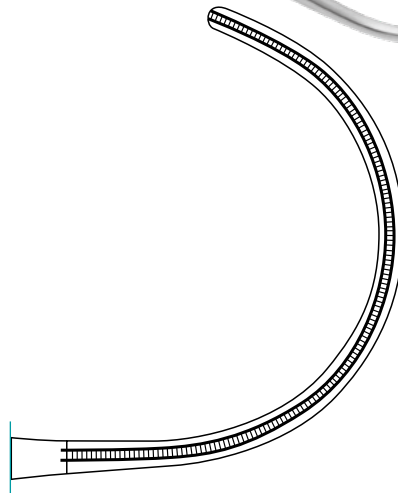

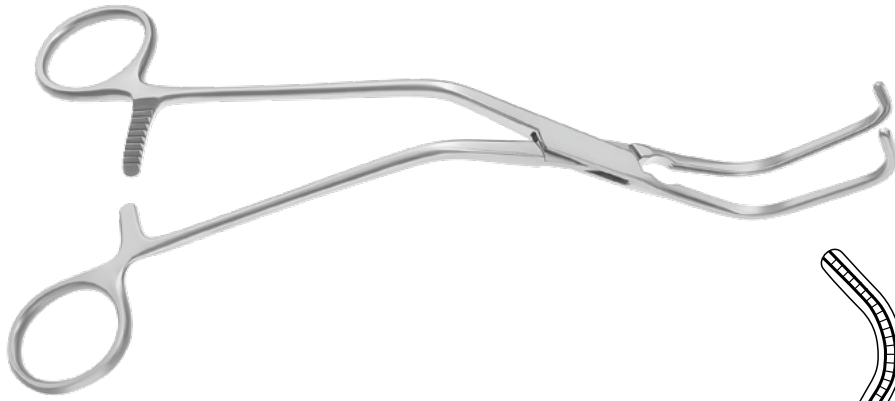

**OCHSNER**

Clamp

235mm, 9<sup>1</sup>/<sub>4</sub>"

290-317-230

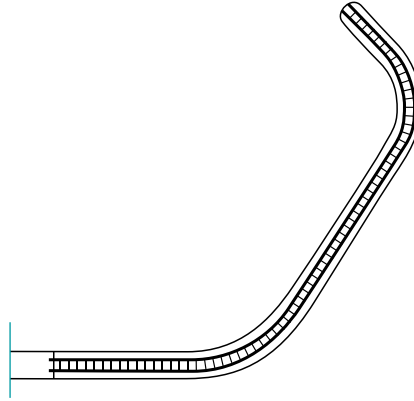

**LIDDLE**

Clamp

270mm, 10<sup>2</sup>/<sub>3</sub>"

290-318-270

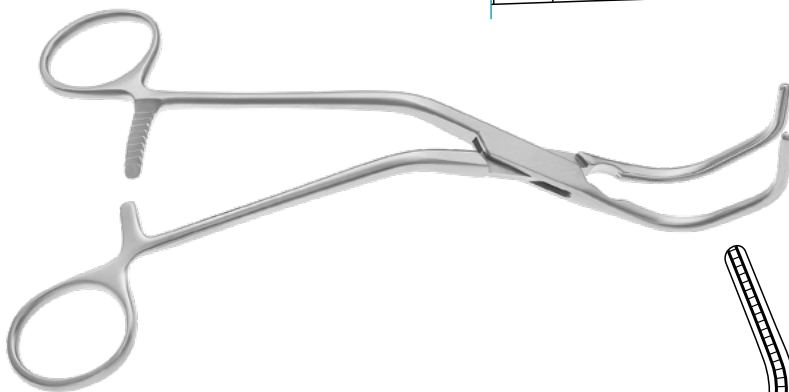
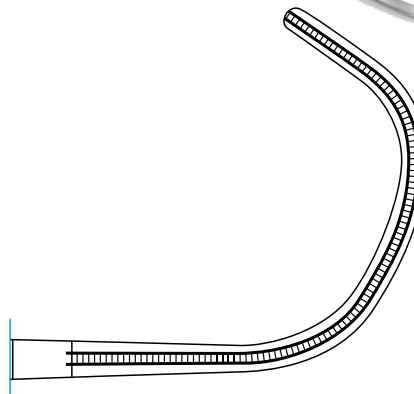

**DIETHRICH**

Clamp

210mm, 8<sup>1</sup>/<sub>4</sub>"

290-319-210

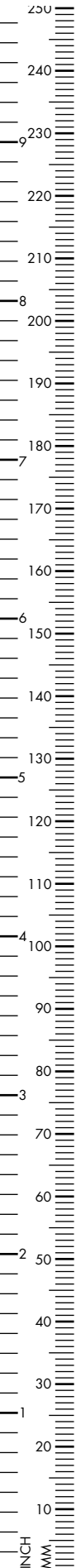
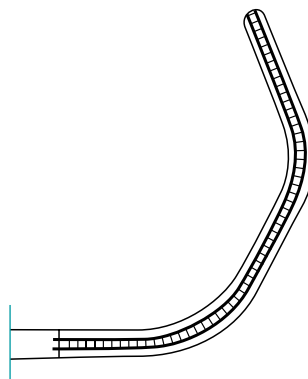

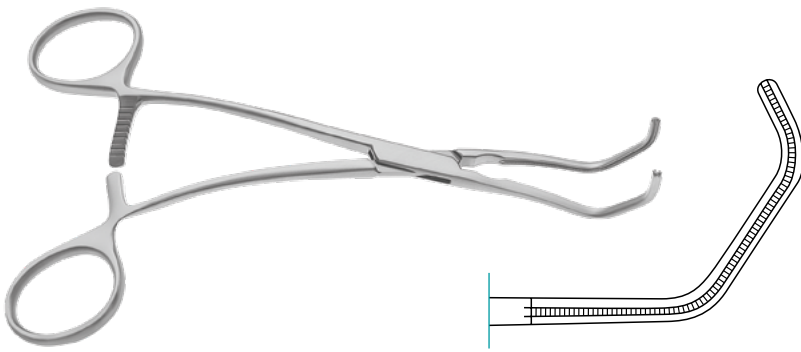

**HONGKONG DERRA**

Vascular Clamp

170mm, 6<sup>2</sup>/<sub>3</sub>"

290-432-170



**BEIJING SATINSKY**

Vascular Clamp

225mm, 8<sup>7</sup>/<sub>8</sub>"

290-425-220

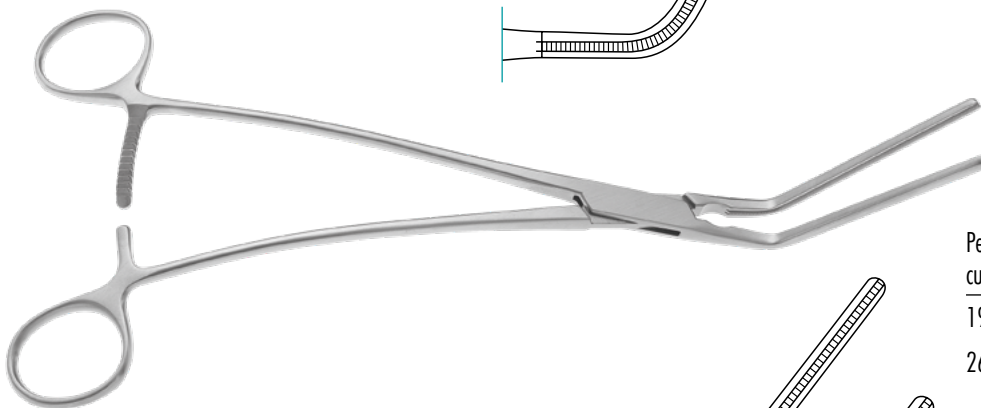

Peripheral Vascular Clamp  
curved shanks, angled jaw

190mm, 7<sup>1</sup>/<sub>2</sub>"

290-402-190

265mm, 10<sup>1</sup>/<sub>2</sub>"

290-402-260

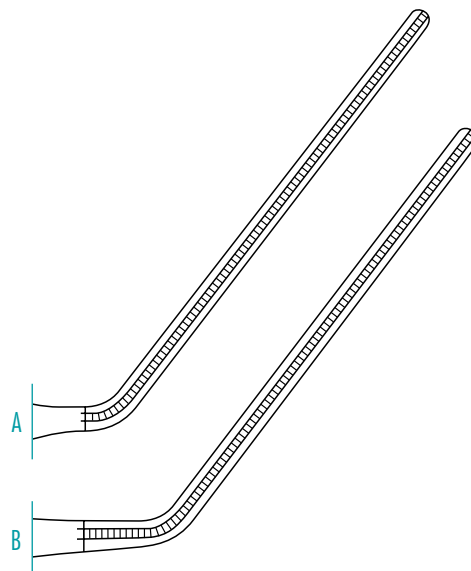

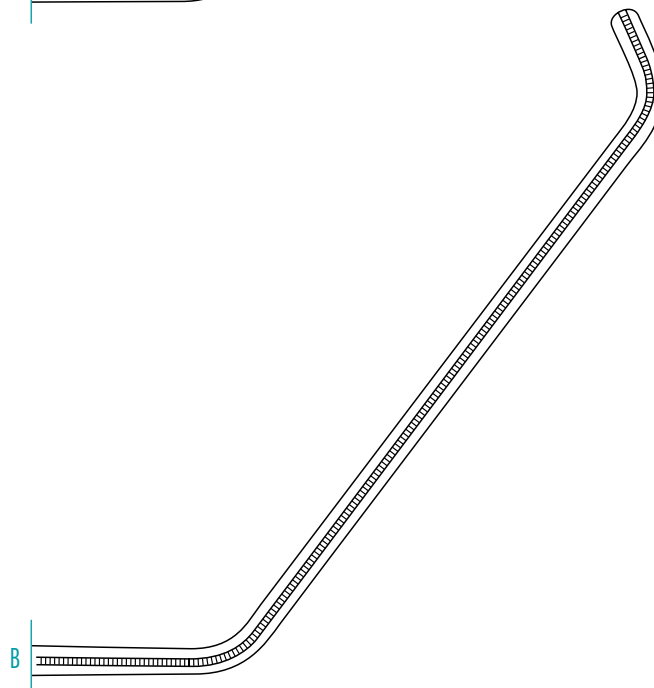
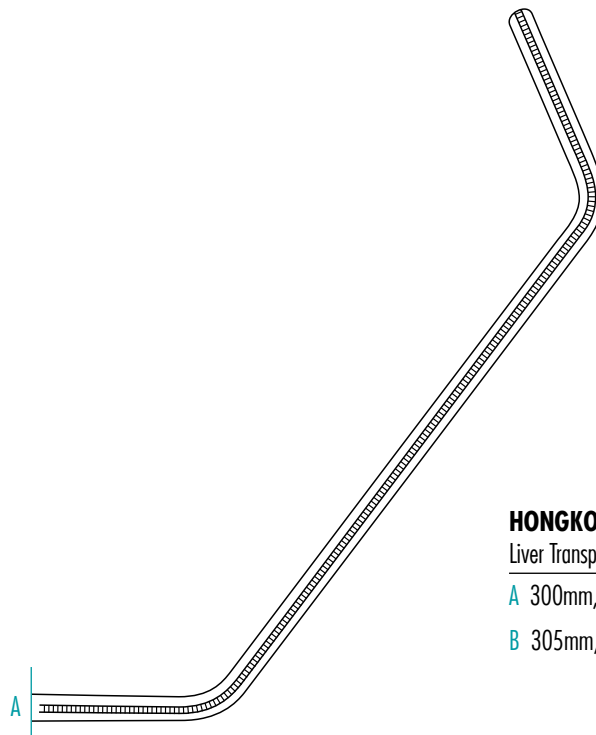

### HONGKONG SATINSKY

Liver Transplant Clamp

A 300mm, 11<sup>7/8</sup>" 290-426-300

B 305mm, 12" 290-426-305

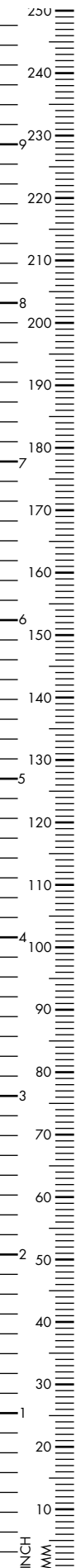



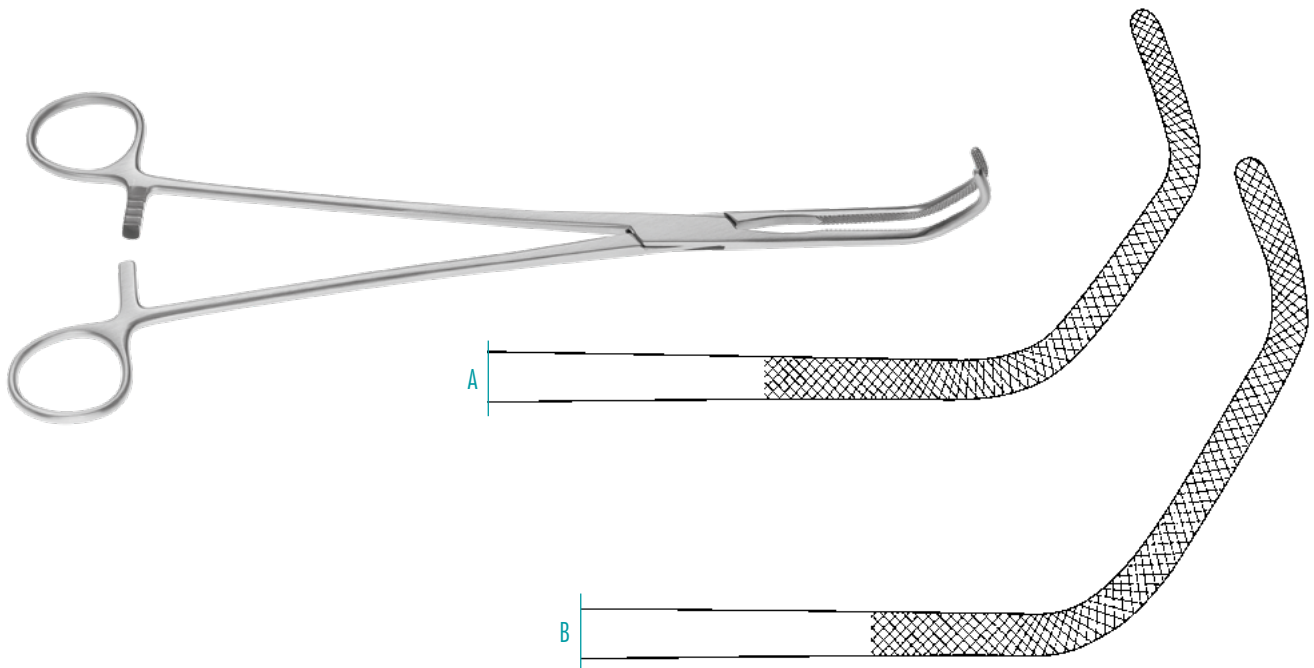

**SATINSKY**

Anastomosis Clamp, 260mm, 10<sup>1</sup>/<sub>4</sub>"

A Fig. 1 290-321-260

B Fig. 2 290-323-260

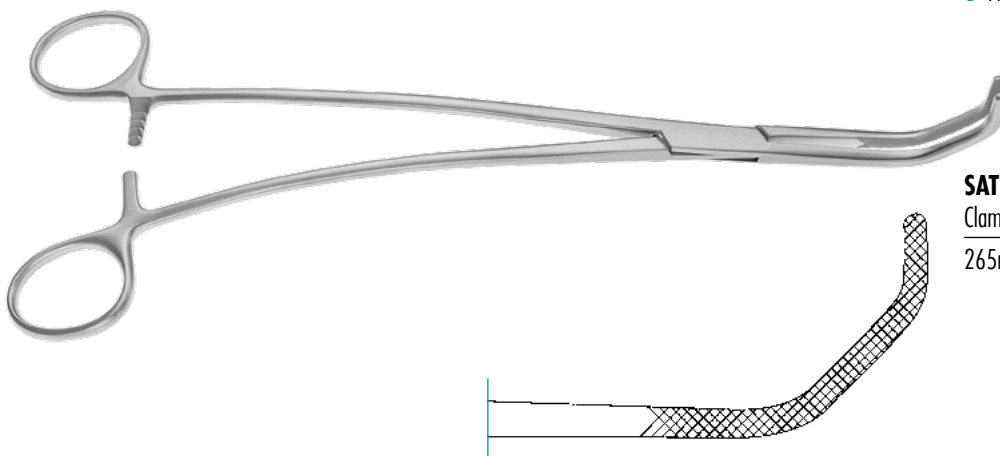

**SATINSKY**

Clamp S, Fig. 1

265mm, 10<sup>1</sup>/<sub>2</sub>" 290-325-260

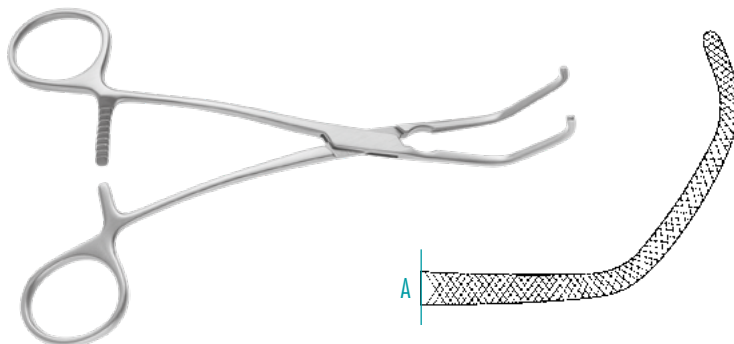

**SATINSKY**

Anastomosis Clamps, curved

150mm, 6" 290-331-150

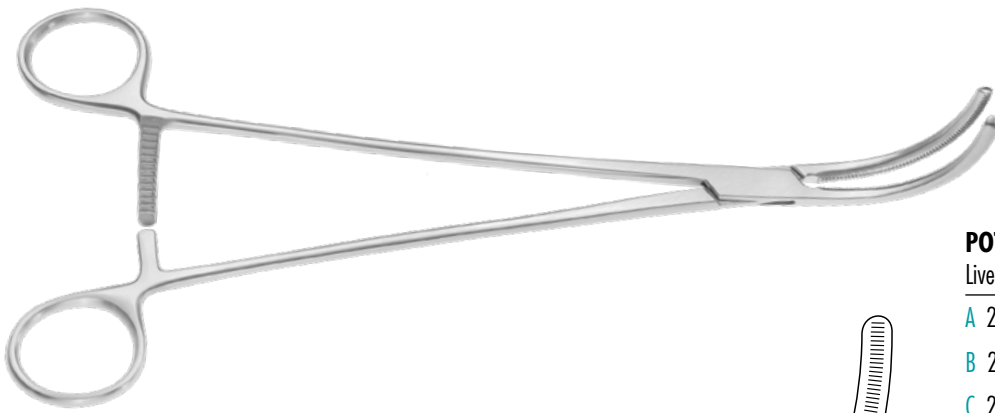

### POTTS

Liver Transplant Clamp

A	255mm, 10"	290-755-255
B	255mm, 10"	290-756-255
C	270mm, 10 <sup>2</sup> / <sub>3</sub> "	290-757-270
D	280mm, 11"	290-758-280

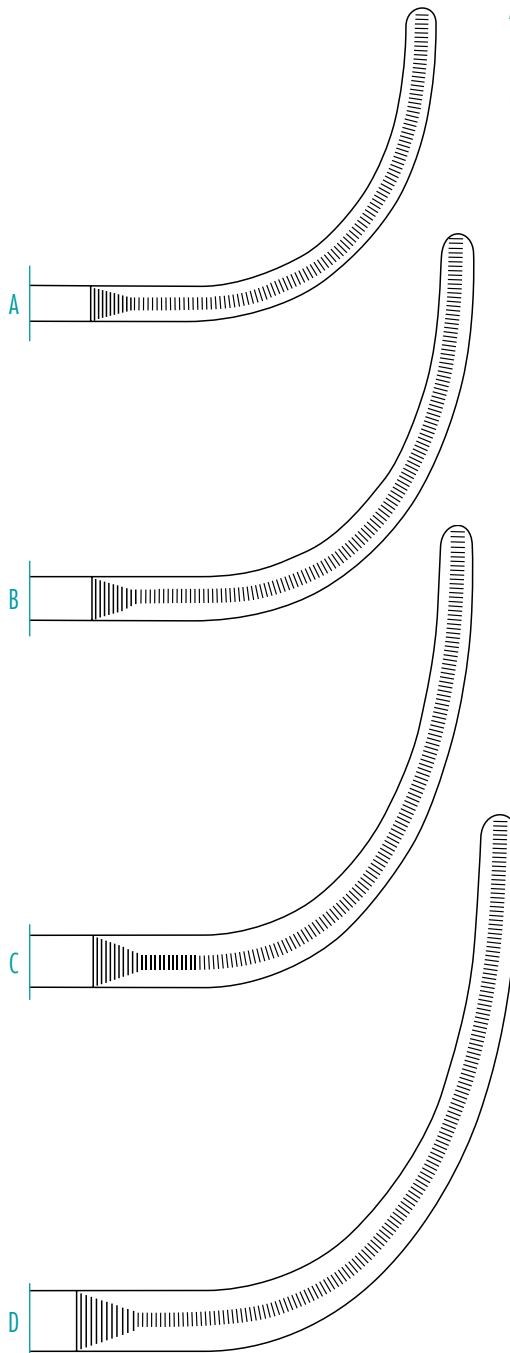

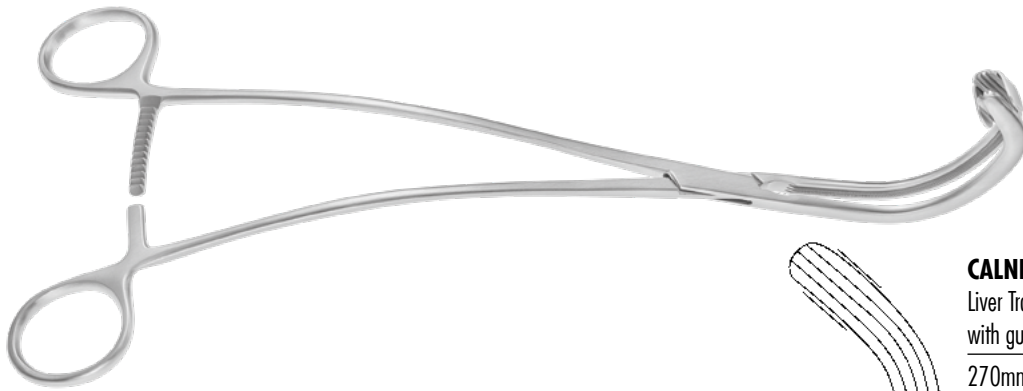

**CALNE**

Liver Transplant Clamp  
with guide lock, DeBakey jaws

270mm, 10<sup>2</sup>/<sub>3</sub>"

290-418-270

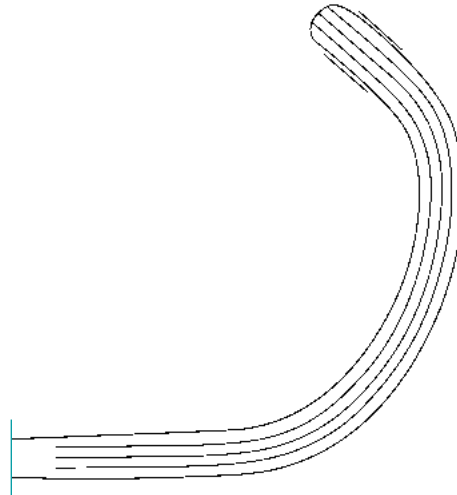

**KLINTMALM**

Liver Transplant Clamp  
medium

215mm, 8<sup>1</sup>/<sub>2</sub>"

290-680-215

large

255mm, 10"

290-695-255

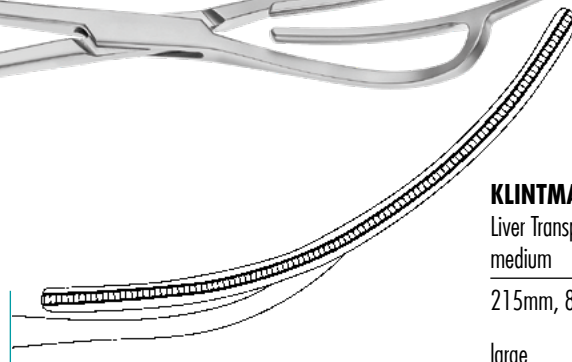

**BAHNSON**

Clamp

270mm, 10<sup>2</sup>/<sub>3</sub>"

290-418-280

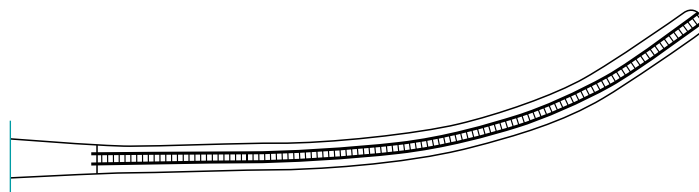



### DEBAKEY BAHNSON

Clamp

A	255mm, 10"	290-433-230
B	265mm, 10 <sup>1</sup> / <sub>2</sub> "	290-433-250
C	280mm, 11"	290-433-270

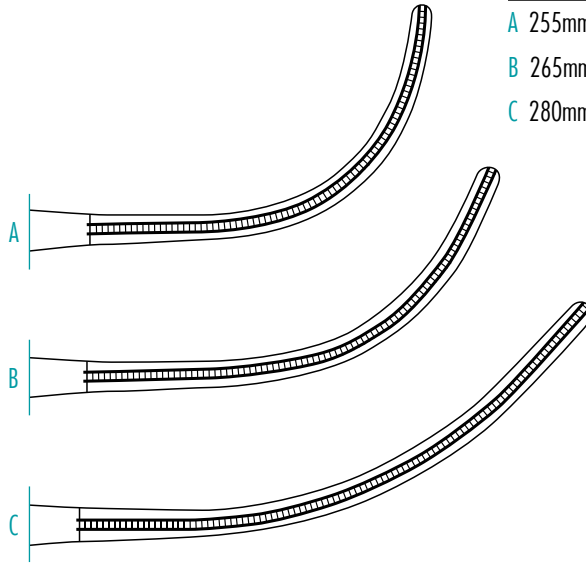

### DEBAKEY

Clamp

	260mm, 10 <sup>1</sup> / <sub>4</sub> "	290-423-260
--	---	-------------

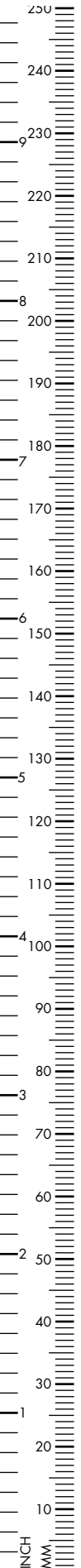
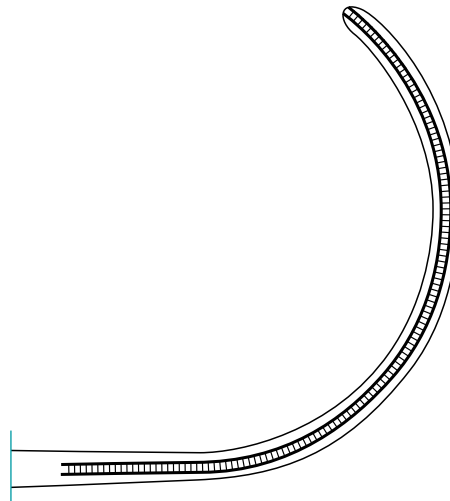

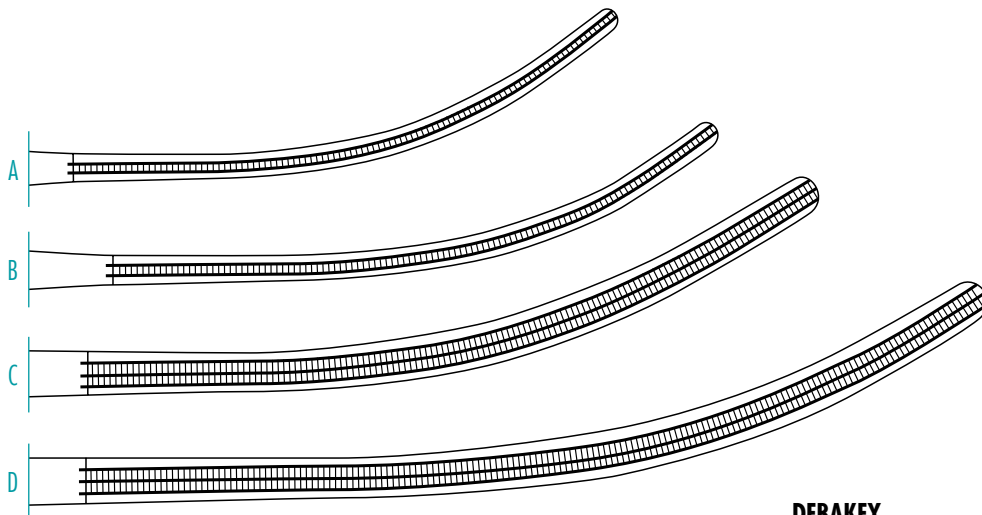
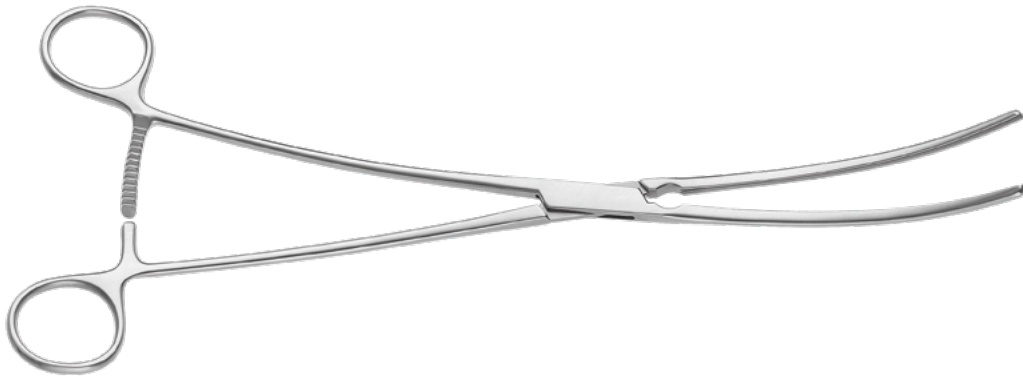

### DEBAKEY

Clamp, c-curved,  
1x2 teeth

A 260mm, 10<sup>1/4</sup>" 290-417-260

B 270mm, 10<sup>2/3</sup>" 290-417-300

2x3 teeth

C 310mm, 12<sup>1/4</sup>" 290-418-310

D 335mm, 13" 290-418-330

s-curved, 2x3 teeth

B 270mm, 10<sup>2/3</sup>" 290-420-300

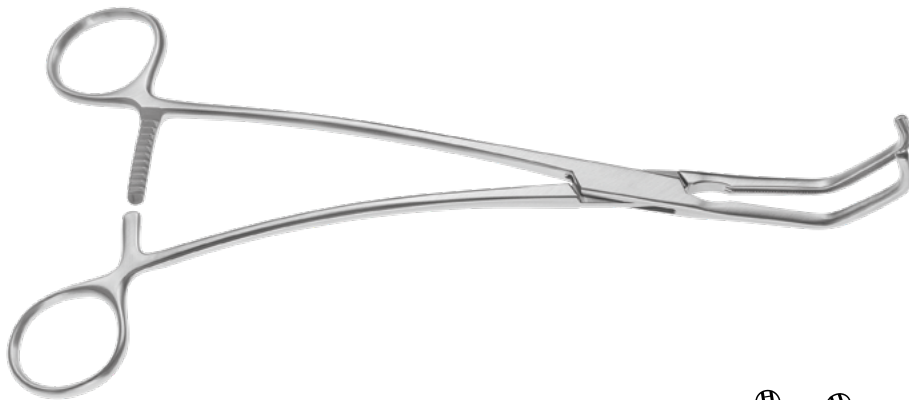

### SATINSKY

Tangential Clamp

A	200mm, 8"	290-425-200
B	240mm, 9 <sup>1</sup> / <sub>2</sub> "	290-425-240
C	250mm, 9 <sup>7</sup> / <sub>8</sub> "	290-425-250
D	265mm, 10 <sup>1</sup> / <sub>2</sub> "	290-425-260
E	285mm, 11 <sup>1</sup> / <sub>4</sub> "	290-425-275

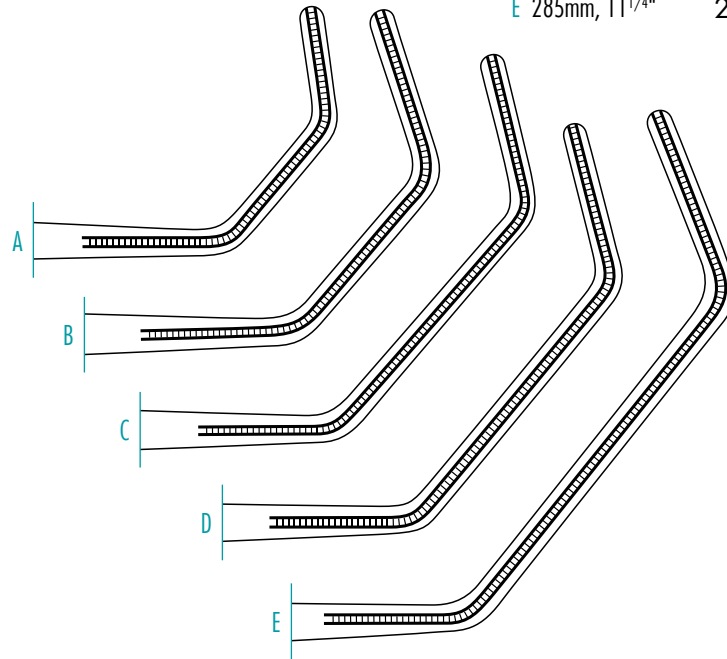

### SATINSKY

Tangential Occlusion Clamp

A	235mm, 9 <sup>1</sup> / <sub>4</sub> "	290-511-235
B	240mm, 9 <sup>1</sup> / <sub>2</sub> "	290-511-240
C	245mm, 9 <sup>2</sup> / <sub>3</sub> "	290-511-245

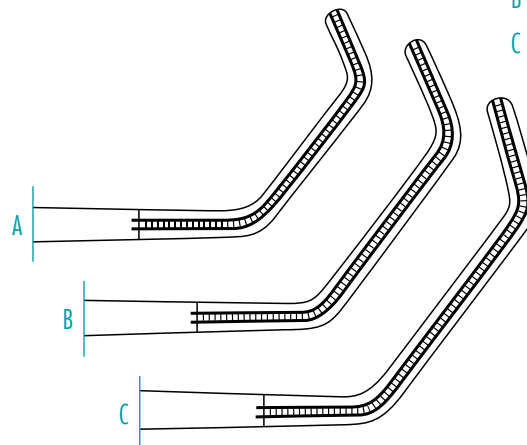

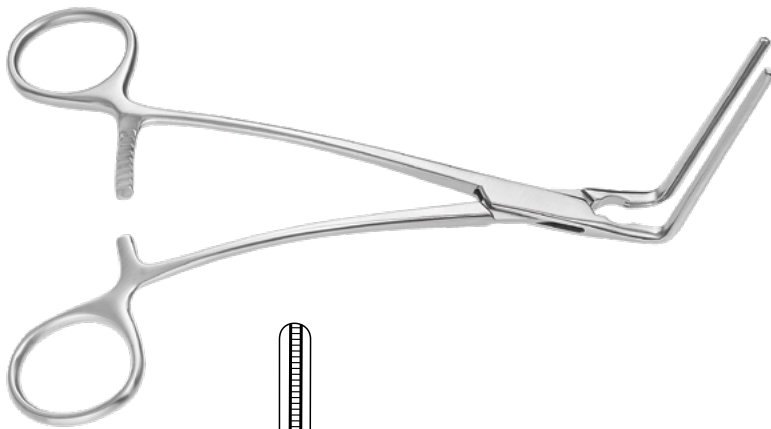

### DEBAKEY

#### Multi-Purpose Clamps

A	180mm, 7"	290-436-180
B	190mm, 7 <sup>1</sup> / <sub>2</sub> "	290-436-190
C	225mm, 8 <sup>7</sup> / <sub>8</sub> "	290-436-230
D	270mm, 10 <sup>2</sup> / <sub>3</sub> "	290-436-270
E	200mm, 8"	290-437-200
F	210mm, 8 <sup>1</sup> / <sub>4</sub> "	290-437-210
G	290mm, 11 <sup>1</sup> / <sub>2</sub> "	290-437-290
H	250mm, 9 <sup>7</sup> / <sub>8</sub> "	290-437-250
I	180mm, 7"	290-442-180
J	190mm, 7 <sup>1</sup> / <sub>2</sub> "	290-442-190
K	210mm, 8 <sup>1</sup> / <sub>4</sub> "	290-442-210

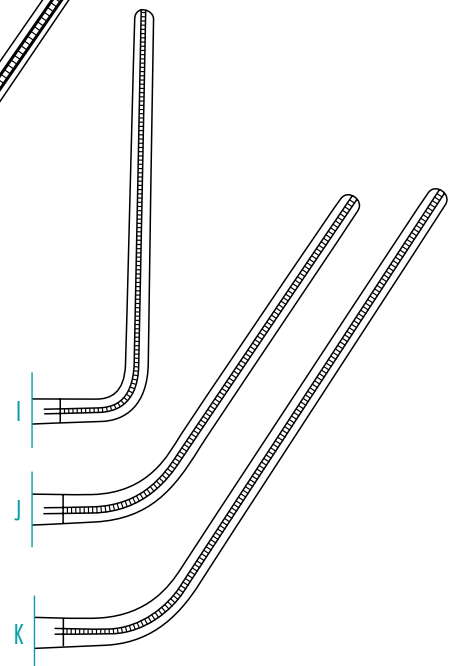
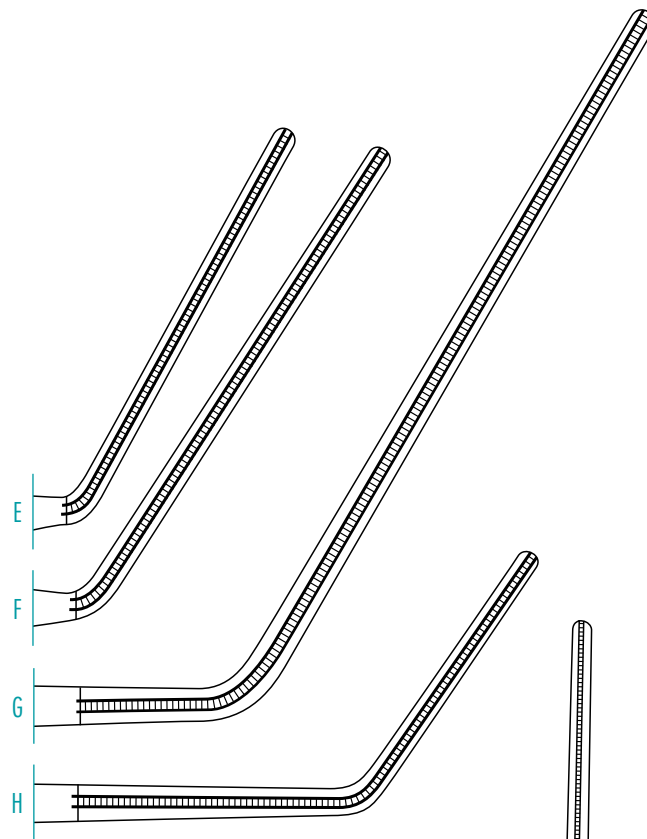
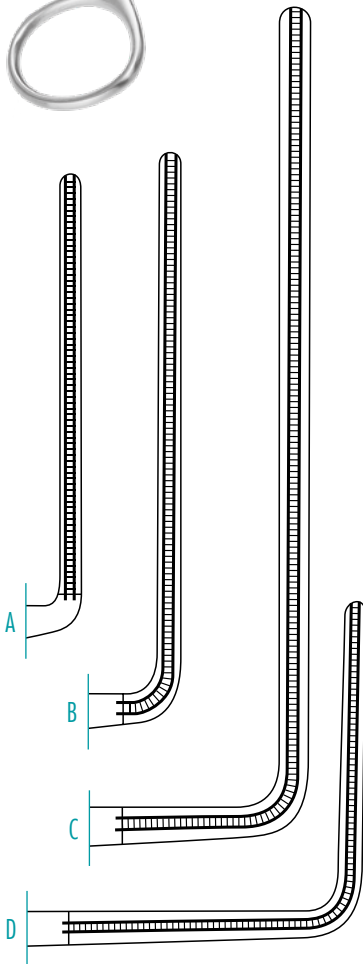

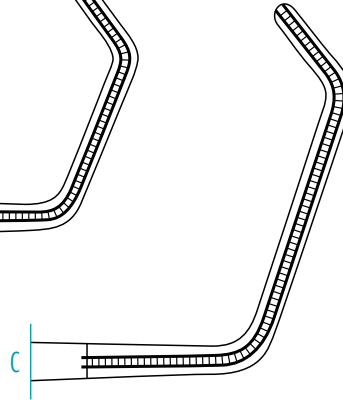
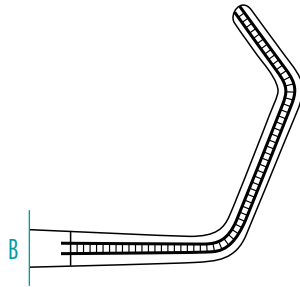
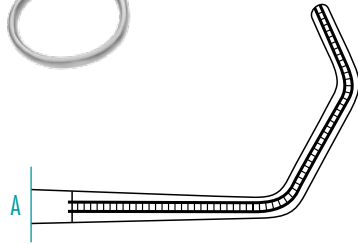
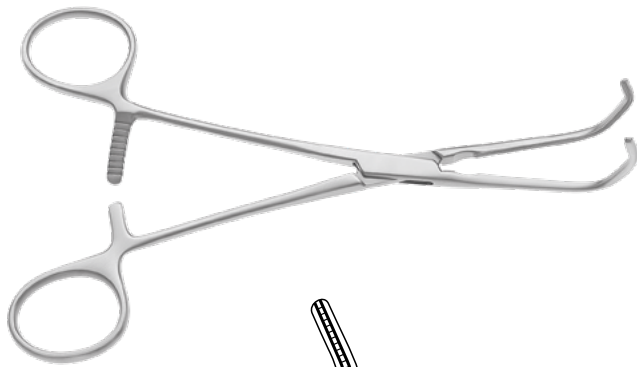

**DEBAKEY BECK**  
Clamp

A 170mm, 6 <sup>2</sup> / <sub>3</sub> "	290-457-170
B 195mm, 7 <sup>3</sup> / <sub>4</sub> "	290-457-190
C 210mm, 8 <sup>1</sup> / <sub>4</sub> "	290-457-210

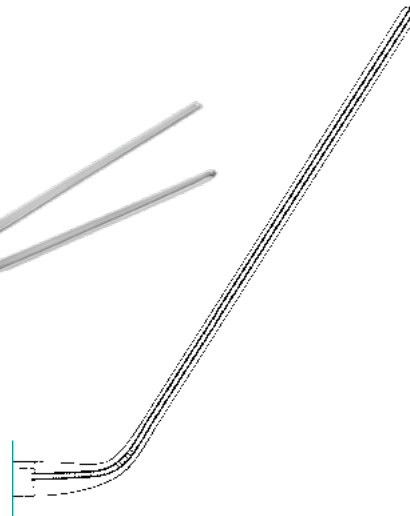
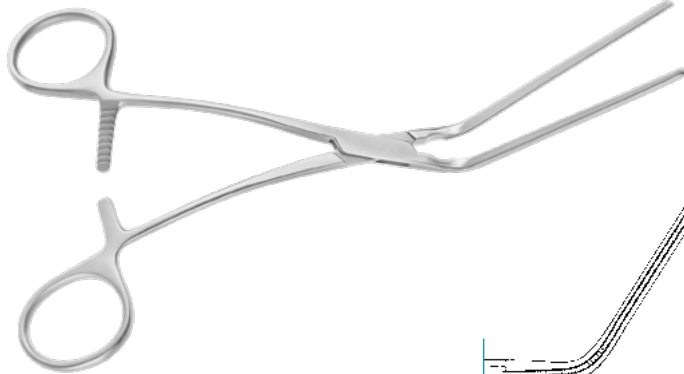

**LELAND JONES**

Peripheral Vascular Clamps,  
shanks curved backwards,  
60° angled backwards

180mm, 7"	290-413-180
-----------	-------------

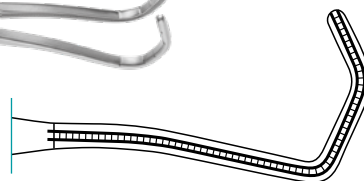
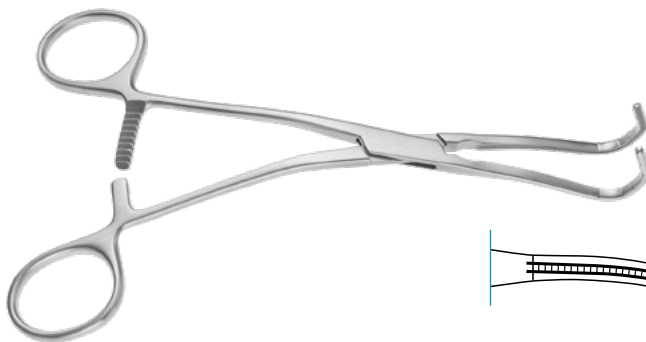

**DEBAKEY**

Anastomosis Clamp

170mm, 6 <sup>2</sup> / <sub>3</sub> "	290-431-170
--	-------------

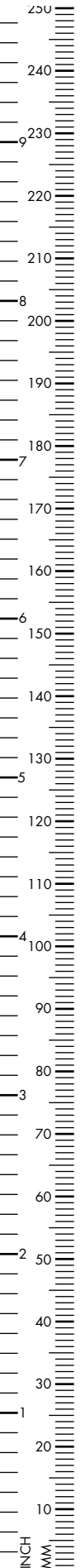



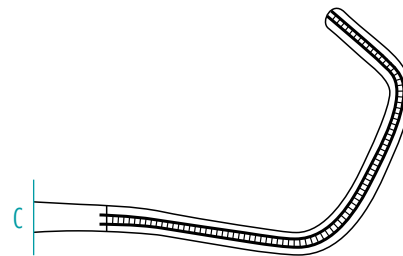
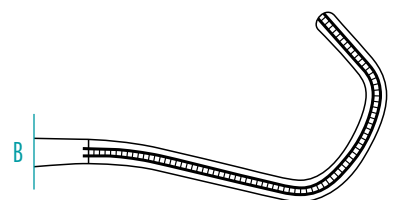
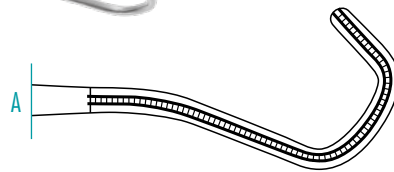
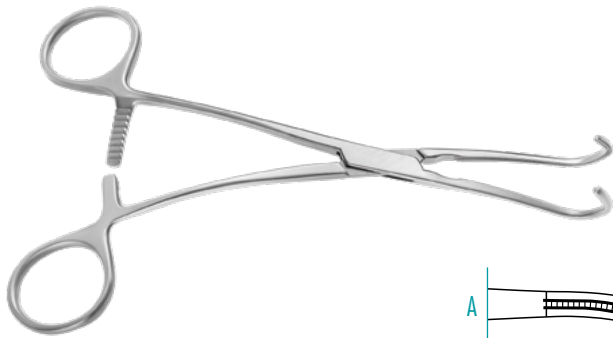

### DEBAKEY DERRA

Anastomosis Clamp

A	160mm, 6 <sup>1</sup> / <sub>4</sub> "	290-456-160
B	170mm, 6 <sup>2</sup> / <sub>3</sub> "	290-456-170
C	180mm, 7"	290-456-180

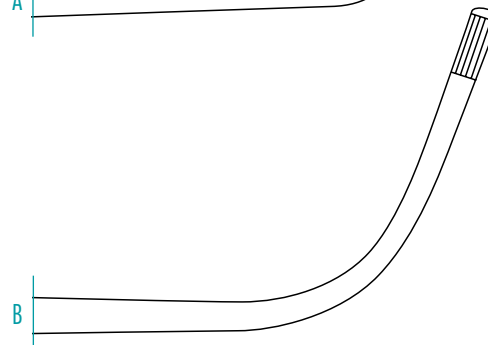
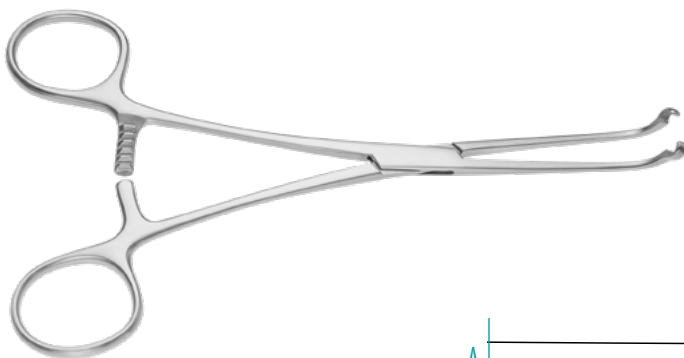

### JAVID

Clamp, 180mm, 7"

A		290-343-180
B		290-343-190

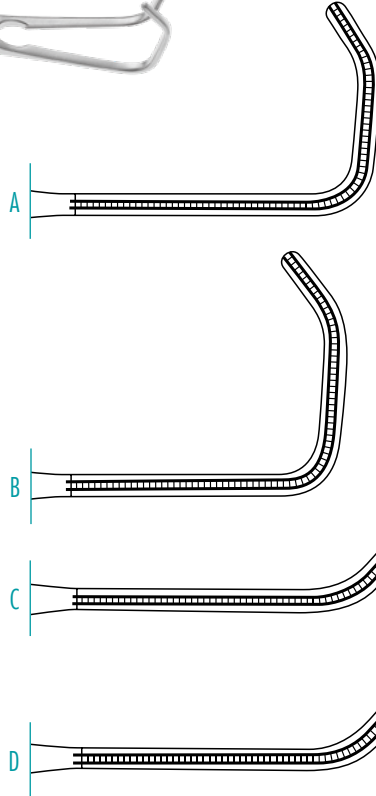
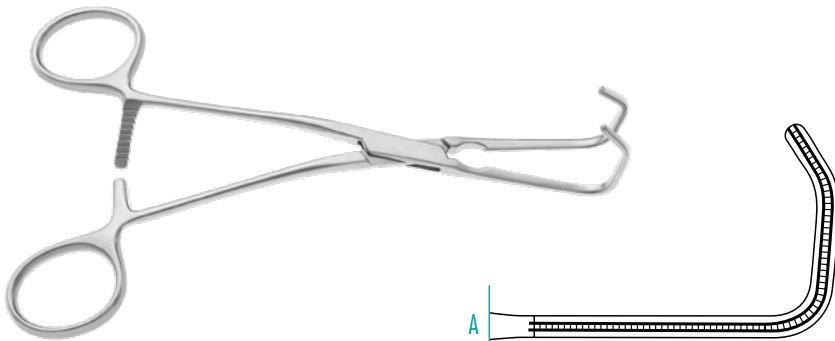

### DEBAKEY REYNOLDS

#### Anastomosis Clamp

A	165mm, 6 <sup>1</sup> / <sub>2</sub> ", small	290-429-001
B	165mm, 6 <sup>1</sup> / <sub>2</sub> ", large	290-429-002
C	180mm, 7", small	290-429-003
D	180mm, 7", large	290-429-004

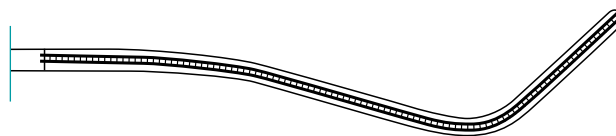
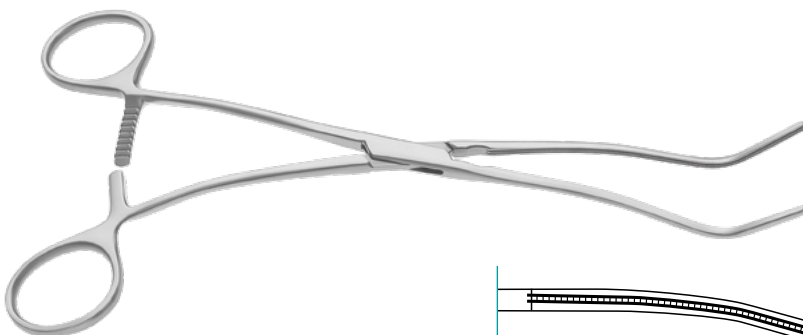

### DEBAKEY

#### Renal Artery Clamp

200mm, 8"	290-416-200
-----------	-------------

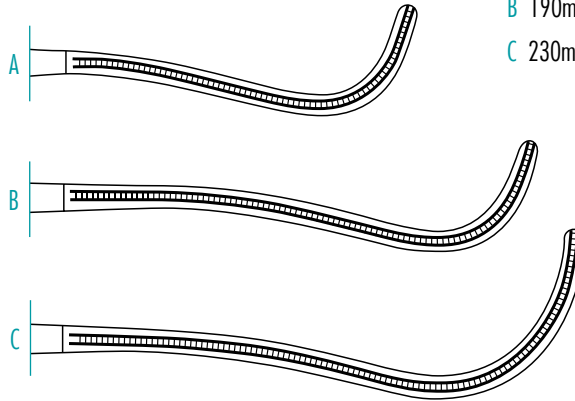
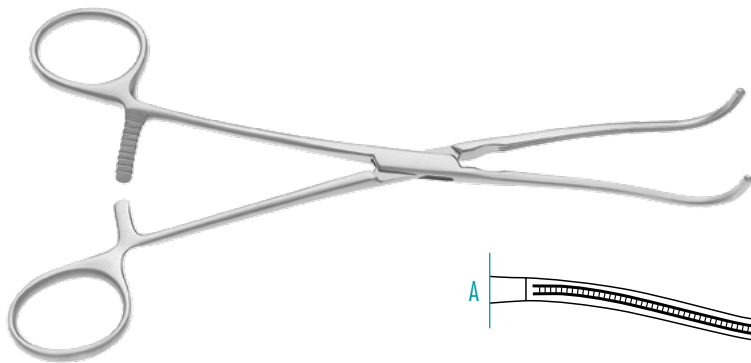

### DEBAKEY

Dissecting and Ligature Forceps

A	230mm, 9"	290-409-230
B	190mm, 7 <sup>1</sup> / <sub>2</sub> "	290-408-190
C	230mm, 9"	290-408-230

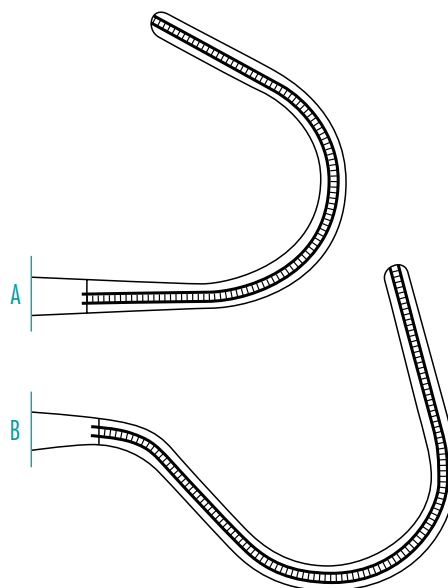

### WYLIE

Vascular Clamp

A	210mm, 8 <sup>1</sup> / <sub>4</sub> "	290-453-210
B	220mm, 8 <sup>2</sup> / <sub>3</sub> "	290-453-220

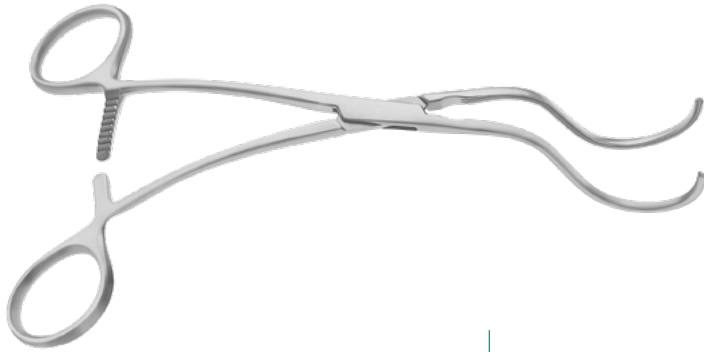

### DALE

#### Peripheral Vascular Clamp

A	170mm, 6 <sup>2</sup> / <sub>3</sub> "	290-341-170
B	180mm, 7"	290-341-180
C	185mm, 7 <sup>1</sup> / <sub>4</sub> "	290-341-190
D	180mm, 7"	290-340-180

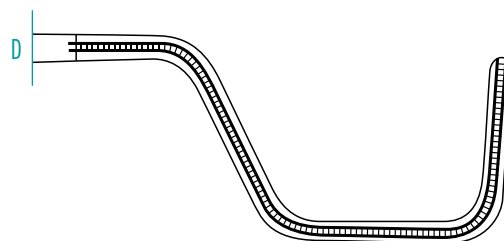
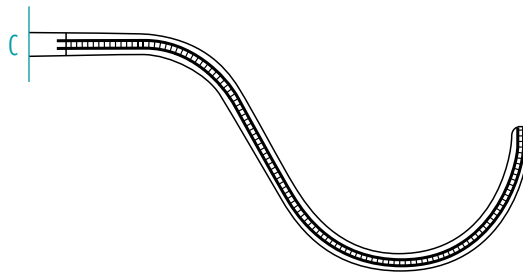
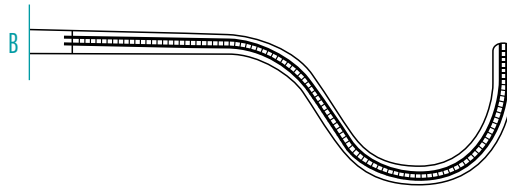
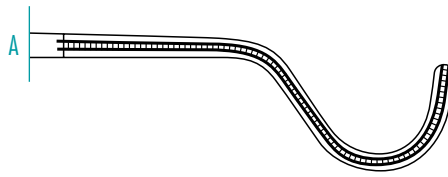

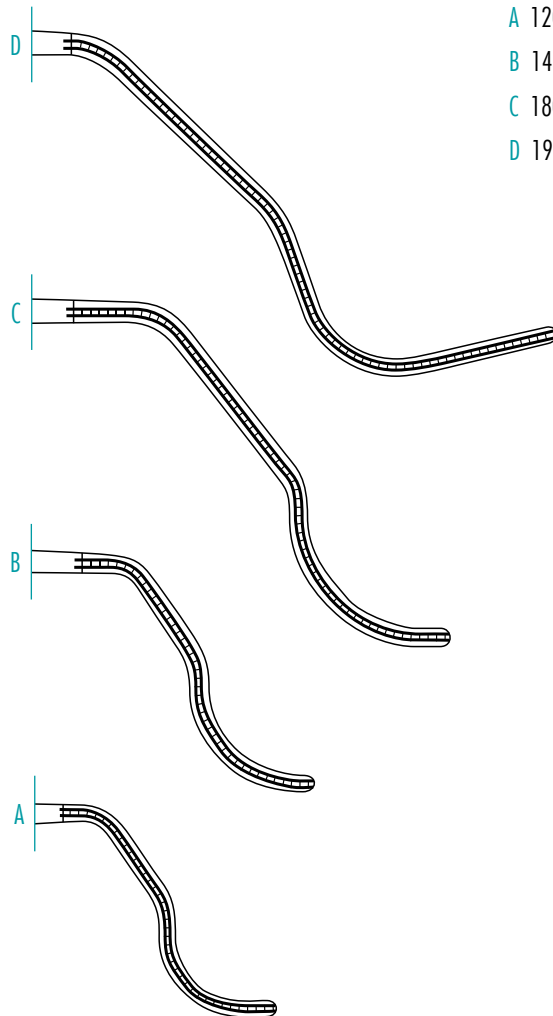

### GREGORY

Profunda Clamp

A	120mm, 4 <sup>3</sup> / <sub>4</sub> "	290-342-120
B	140mm, 5 <sup>1</sup> / <sub>2</sub> "	290-342-140
C	180mm, 7"	290-342-160
D	190mm, 7 <sup>1</sup> / <sub>2</sub> "	290-342-180

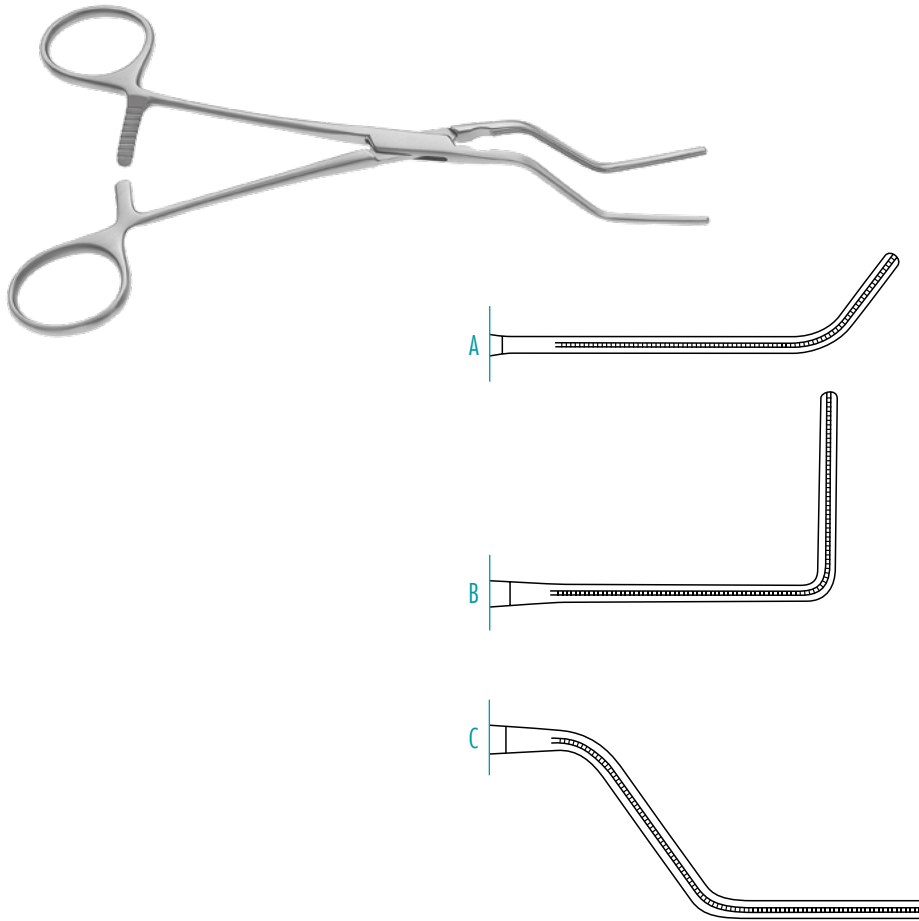

**HUSFELDT**  
Carotid Profunda Clamp

A	180mm, 7"	290-594-175
B	170mm, 6 <sup>2</sup> / <sub>3</sub> "	290-594-170
C	180mm, 7"	290-594-180

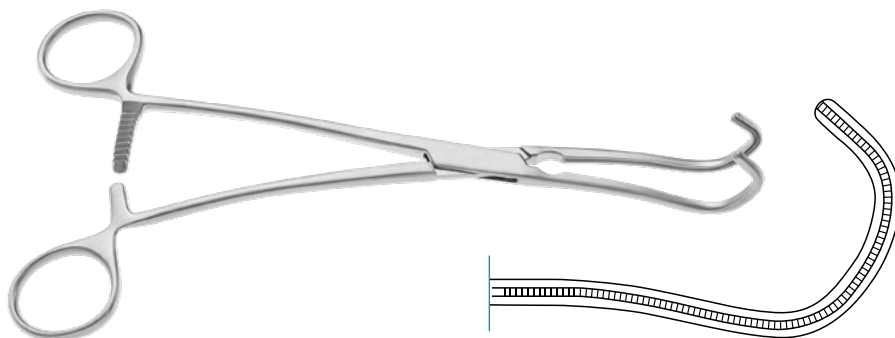

**MITCHELL**  
Clamp

200mm, 8"	290-424-200
-----------	-------------

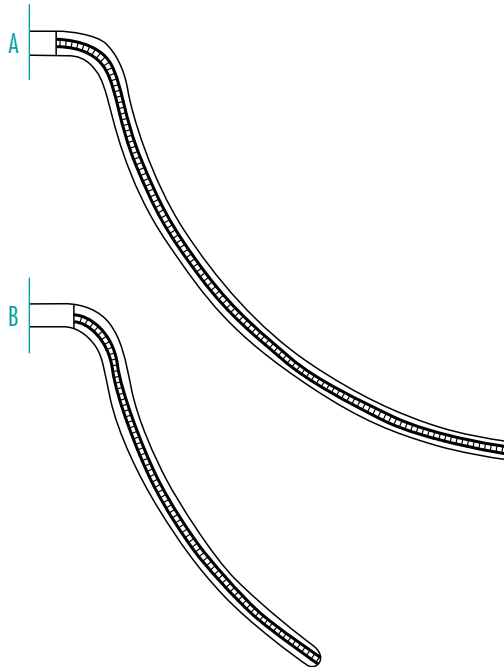

### WYLIE

Vascular Clamps, shanks curved up

A 160mm, 6<sup>1</sup>/<sub>4</sub>" 290-344-160

B 180mm, 7" 290-344-180

shanks curved down

A 170mm, 6<sup>2</sup>/<sub>3</sub>" 290-344-170

B 200mm, 8" 290-344-200

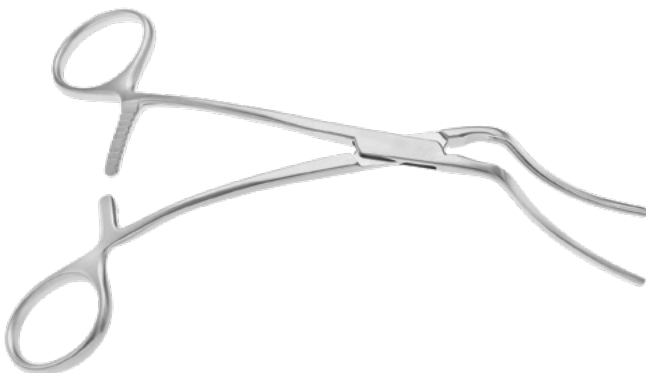

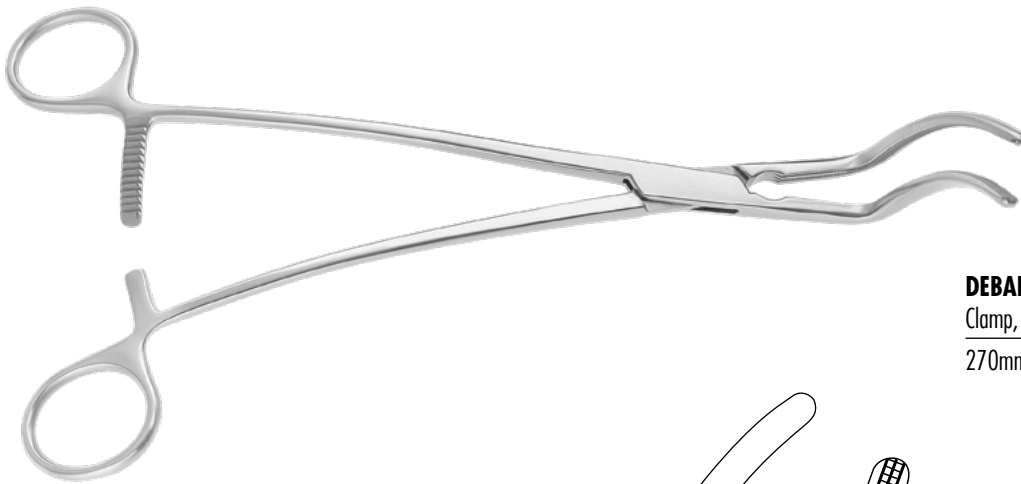

**DEBAKEY**

Clamp, 2x3 teeth

270mm, 10<sup>2</sup>/<sub>3</sub>"

290-420-270

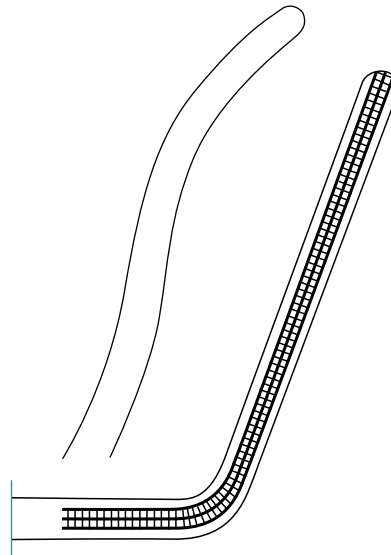

**GRANT**

Abdominal Clamp, 2x3 teeth

245mm, 9<sup>2</sup>/<sub>3</sub>"

290-431-230



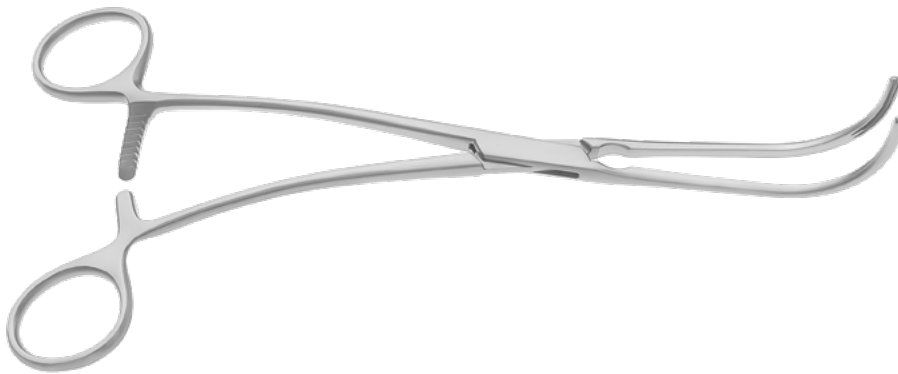

**DEBAKEY**  
Ligature Clamp

A	270mm, 10 <sup>2</sup> / <sub>3</sub> "	290-423-250
B	240mm, 9 <sup>1</sup> / <sub>2</sub> "	290-421-240

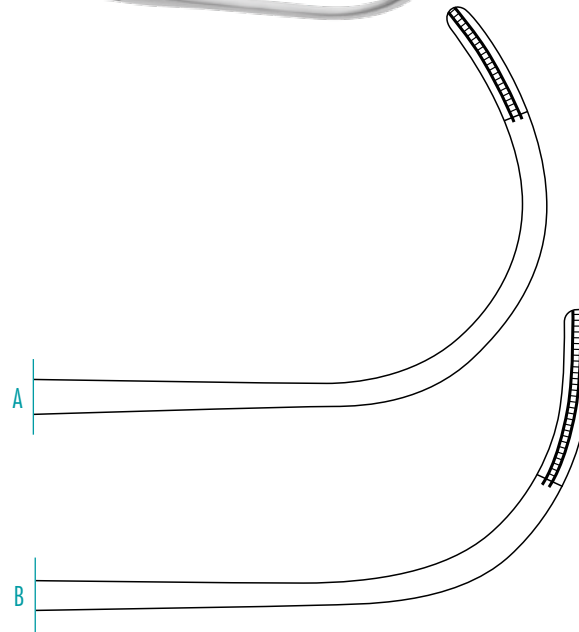

**DEBAKEY**  
Ligature Clamp

A	160mm, 6 <sup>1</sup> / <sub>4</sub> "	290-455-170
B	160mm, 6 <sup>1</sup> / <sub>4</sub> "	290-453-160

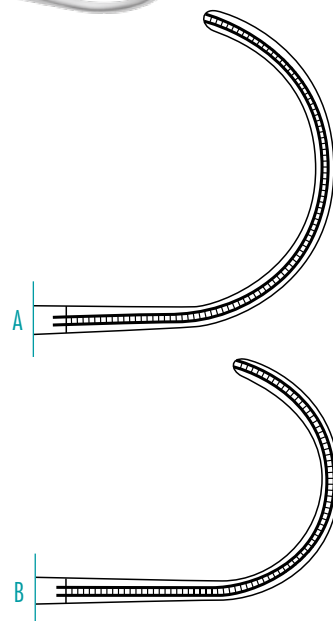

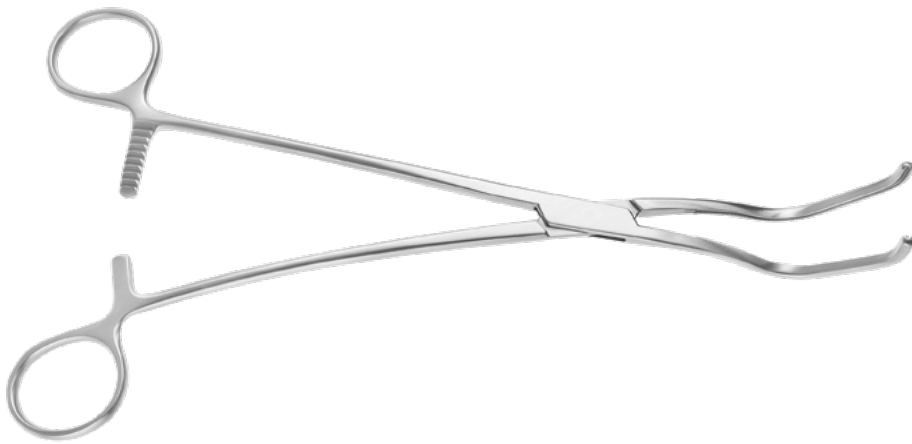

### DEBAKEY HARKEN

Avricle Clamp, 240mm, 9<sup>1</sup>/<sub>2</sub>"

A Fig. 1	290-426-001
B Fig. 2	290-426-002
C Fig. 3	290-426-003
D Fig. 4	290-426-004

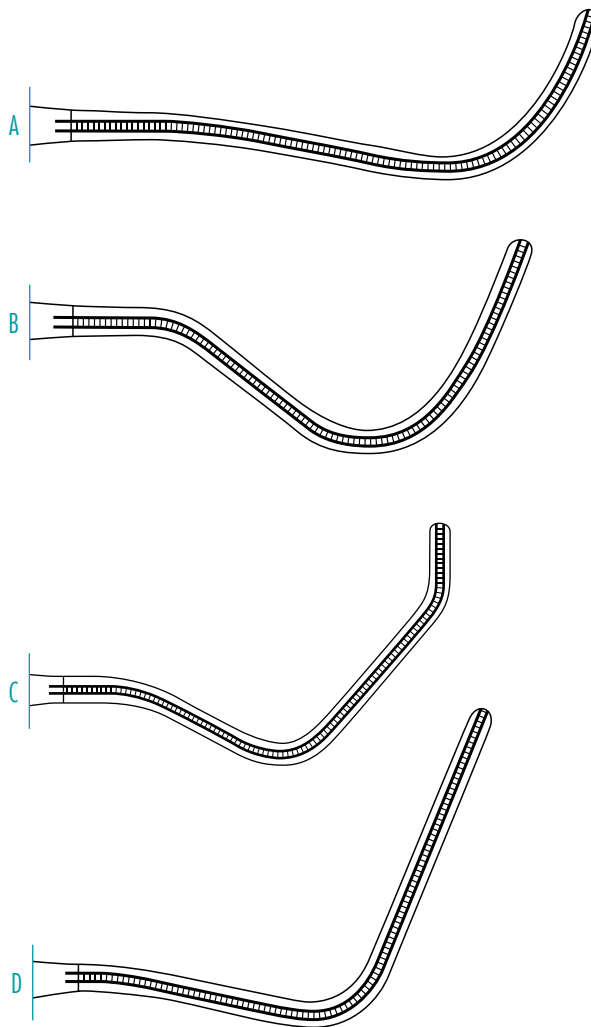

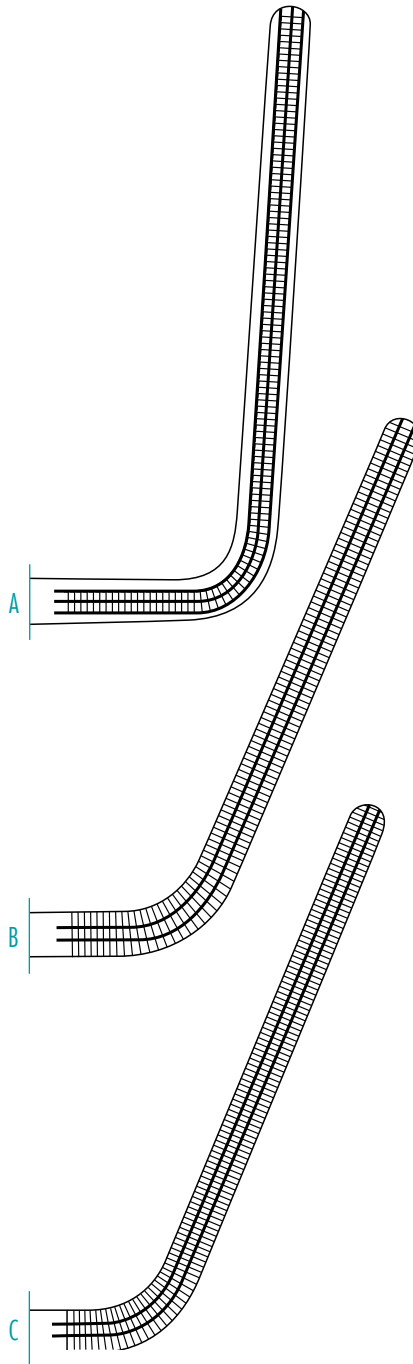
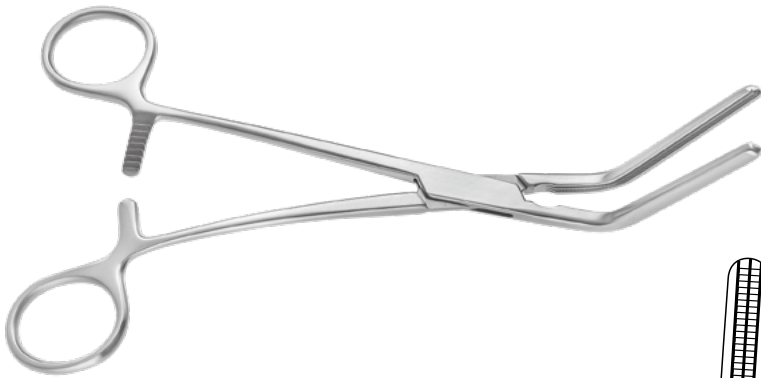

### MORRIS

Clamp, 2x3 teeth

A	230mm, 9"	290-432-230
B	250mm, 9 <sup>7</sup> / <sub>8</sub> "	290-432-250
C	200mm, 8"	290-432-200



### ZANGER

Abdominal Clamp

A	215mm, 8 <sup>1</sup> / <sub>2</sub> "	290-413-220
	1x2 teeth	
B	250mm, 9 <sup>7</sup> / <sub>8</sub> "	290-413-250
	1x2 teeth	
C	305mm, 12"	290-414-310
	2x3 teeth	

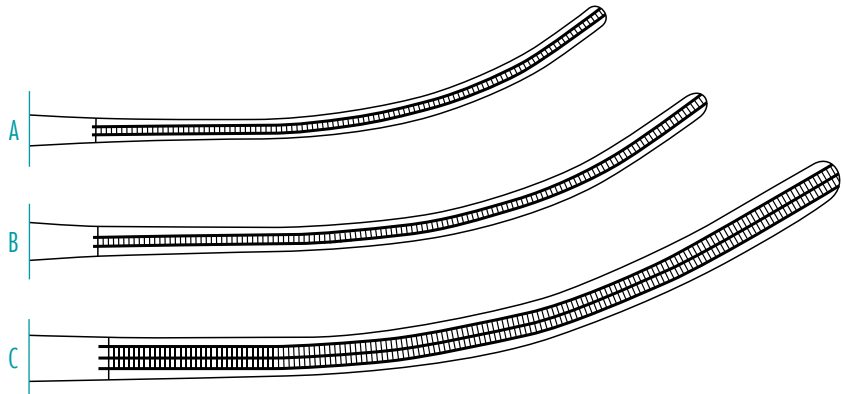

### WYLIE

Hypogastric and Abdominal Clamp

A	240mm, 9 <sup>1</sup> / <sub>2</sub> "	290-454-260
B	240mm, 9 <sup>1</sup> / <sub>2</sub> "	290-454-240
B	280mm, 11"	290-454-280

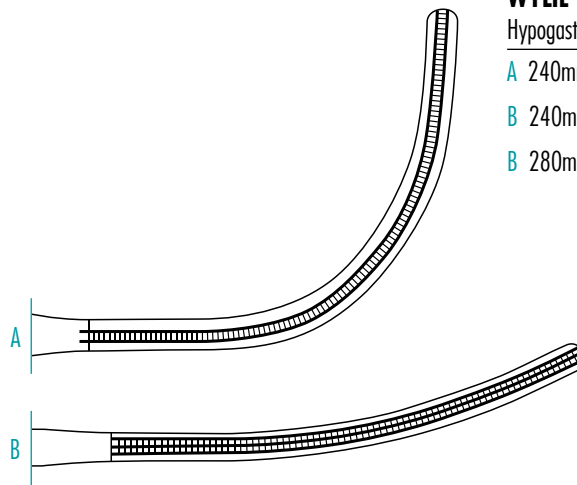

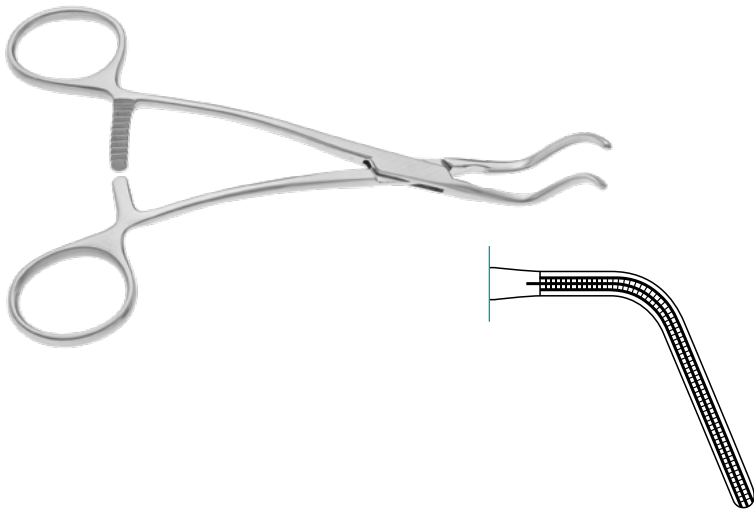

**SUBRAMANIAN**  
Miniature Clamp

160mm, 6<sup>1</sup>/<sub>4</sub>" 290-559-150

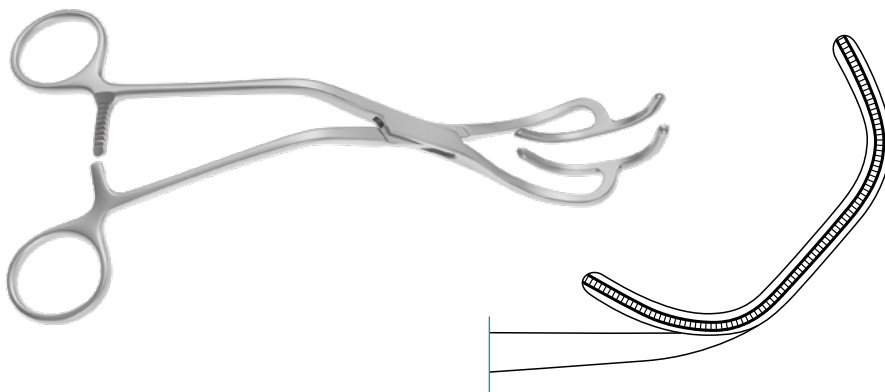

**STRONG**  
Clamp, 175mm, 6<sup>7</sup>/<sub>8</sub>"

41x16mm jaw 290-175-410  
45x23mm jaw 290-175-450

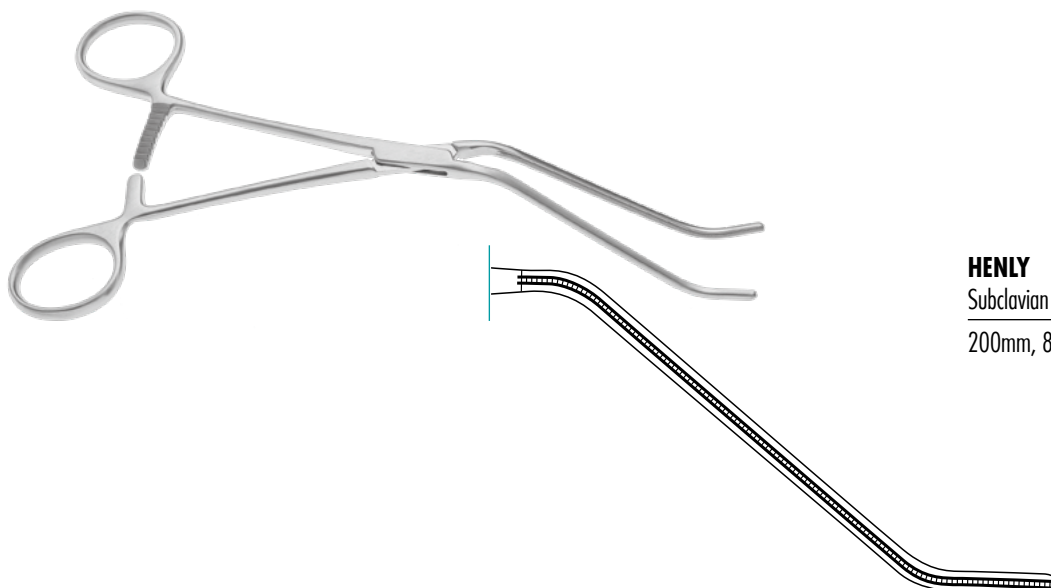

**HENLY**  
Subclavian Artery Clamp

200mm, 8" 290-460-200



**DEBAKEY EXTRA FINE**  
Pediatric Vessel Clamp

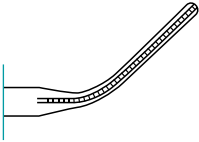

Angled shanks 45°  
105mm, 4<sup>1</sup>/<sub>8</sub>" 290-599-001

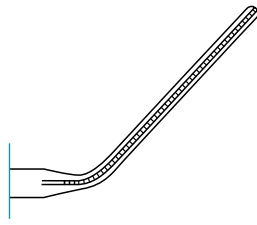

Angled shanks 45°  
125mm, 5" 290-599-002

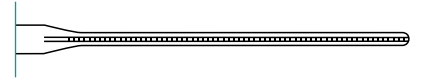

Straight shanks  
140mm, 5<sup>1</sup>/<sub>2</sub>" 290-599-003

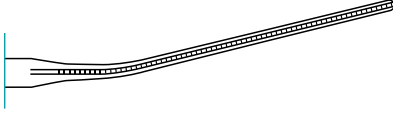

Curved shanks 15°  
140mm, 5<sup>1</sup>/<sub>2</sub>" 290-599-004

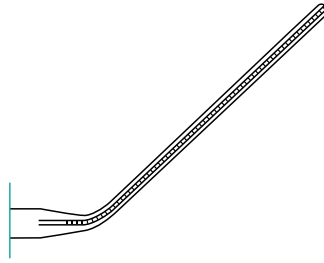

Curved shanks 45°  
140mm, 5<sup>1</sup>/<sub>2</sub>" 290-599-005

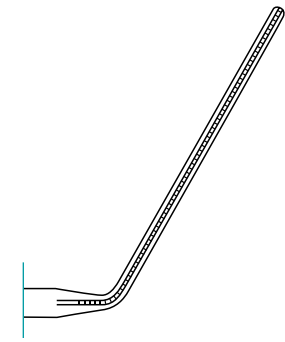

Angled shanks 90°  
140mm, 5<sup>1</sup>/<sub>2</sub>" 290-599-006

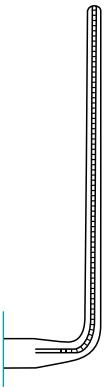

Angled shanks 90°  
140mm, 5<sup>1</sup>/<sub>2</sub>" 290-599-007

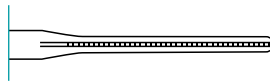

Straight shanks  
155mm, 6<sup>1</sup>/<sub>8</sub>" 290-599-008

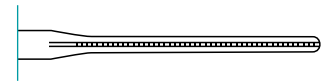

20° angled shanks  
155mm, 6<sup>1</sup>/<sub>8</sub>" 290-599-009

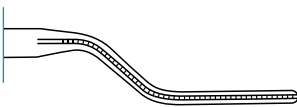

Curved shanks  
150mm, 6" 290-599-010

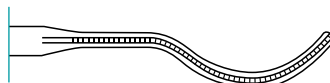

Straight shanks  
150mm, 6" 290-599-011

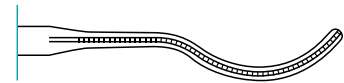

Angled shanks  
145mm, 5<sup>3</sup>/<sub>4</sub>" 290-599-012

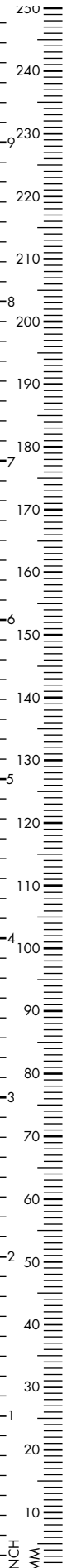



**DEBAKEY EXTRA FINE**  
Pediatric Vessel Clamp

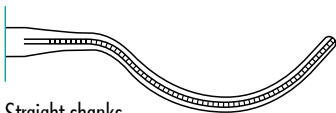

Straight shanks  
155mm, 6<sup>1</sup>/<sub>8</sub>" 290-599-013

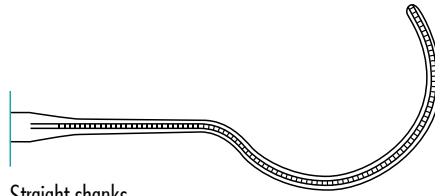

Straight shanks  
170mm, 6<sup>3</sup>/<sub>4</sub>" 290-599-014

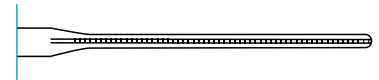

Straight shanks  
165mm, 6<sup>1</sup>/<sub>2</sub>" 290-599-015

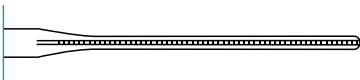

Angled shanks  
165mm, 6<sup>1</sup>/<sub>2</sub>" 290-599-016

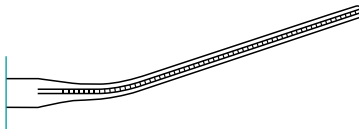

Straight shanks, 15°  
155mm, 6<sup>1</sup>/<sub>8</sub>" 290-599-017

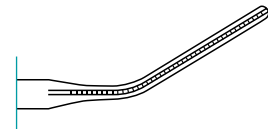

Straight shanks, 30°  
145mm, 5<sup>3</sup>/<sub>4</sub>" 290-599-018

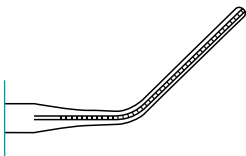

Straight shanks, 45°  
145mm, 5<sup>3</sup>/<sub>4</sub>" 290-599-019

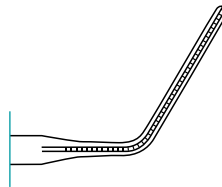

Straight shanks, 60°  
145mm, 5<sup>3</sup>/<sub>4</sub>" 290-599-020

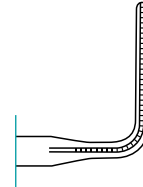

Straight shanks, 90°  
140mm, 5<sup>1</sup>/<sub>2</sub>" 290-599-021

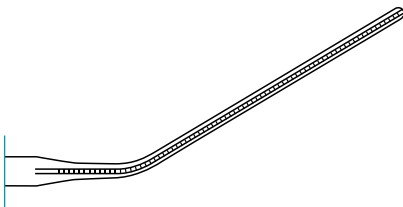

Curved shanks, 30°  
160mm, 6<sup>1</sup>/<sub>4</sub>" 290-599-022

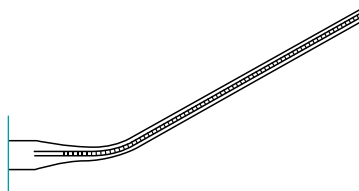

Curved shanks, 45°  
160mm, 6<sup>1</sup>/<sub>4</sub>" 290-599-023

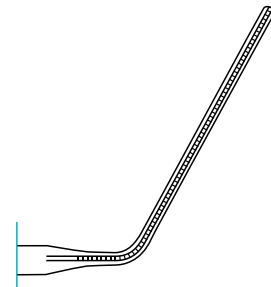

Curved shanks, 60°  
145mm, 5<sup>3</sup>/<sub>4</sub>" 290-599-024



**DEBAKEY EXTRA FINE**  
Pediatric Vessel Clamp

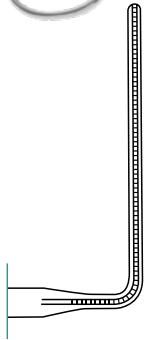

Curved shanks, 90°  
130mm, 5<sup>1</sup>/<sub>8</sub>" 290-599-025

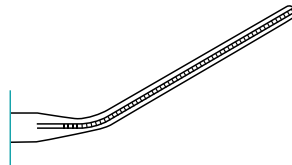

Straight shanks, 30°  
120mm, 4<sup>3</sup>/<sub>4</sub>" 290-599-026

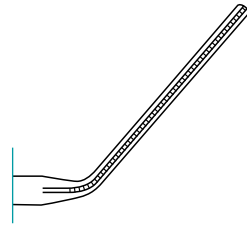

Straight shanks, 50°  
120mm, 4<sup>3</sup>/<sub>4</sub>" 290-599-027

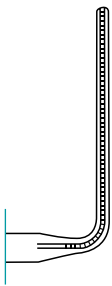

Straight shanks, 90°  
105mm, 4<sup>1</sup>/<sub>8</sub>" 290-599-028

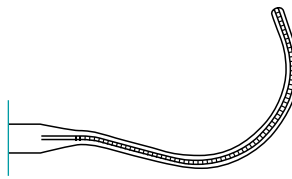

Curved shanks  
120mm, 4<sup>3</sup>/<sub>4</sub>" 290-599-029

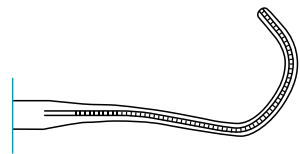

Curved shanks  
145mm, 5<sup>3</sup>/<sub>4</sub>" 290-599-030

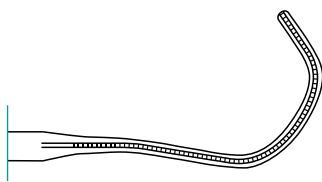

Curved shanks  
145mm, 5<sup>3</sup>/<sub>4</sub>" 290-599-031

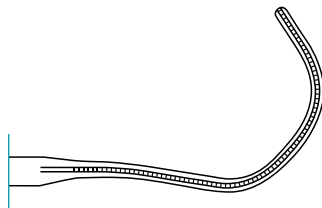

Curved shanks  
160mm, 6<sup>1</sup>/<sub>4</sub>" 290-599-032

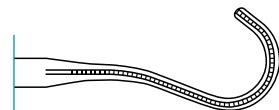

Angled shanks  
115mm, 4<sup>1</sup>/<sub>2</sub>" 290-599-033

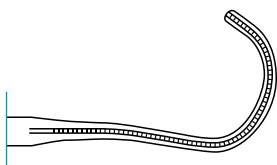

Angled shanks  
115mm, 4<sup>1</sup>/<sub>2</sub>" 290-599-034

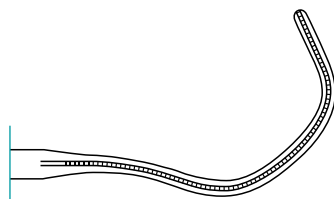

Angled shanks  
150mm, 6" 290-599-035

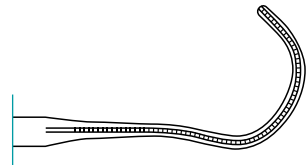

Curved shanks  
115mm, 4<sup>1</sup>/<sub>2</sub>" 290-599-036

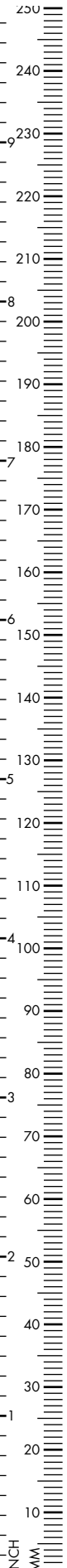





**DEBAKEY EXTRA FINE**  
Pediatric Vessel Clamp

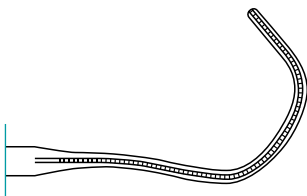

Curved shanks  
150mm, 6" 290-599-037

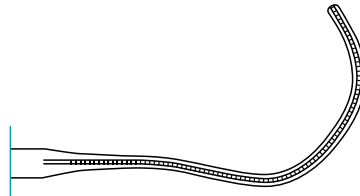

Curved shanks  
160mm, 6<sup>1</sup>/<sub>4</sub>" 290-599-038

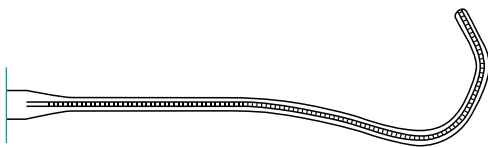

Curved shanks  
180mm, 7" 290-599-039

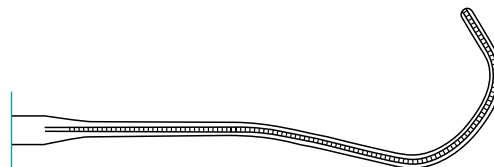

Curved shanks  
180mm, 7" 290-599-040

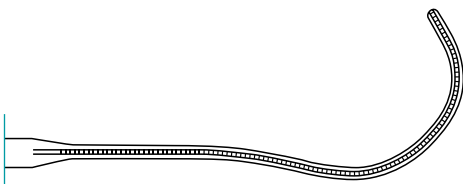

Curved shanks  
180mm, 7" 290-599-041

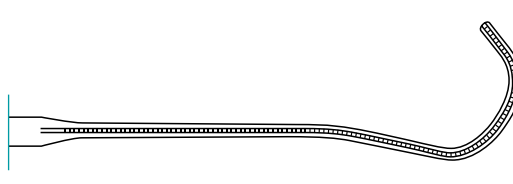

Angled shanks  
180mm, 7" 290-599-042

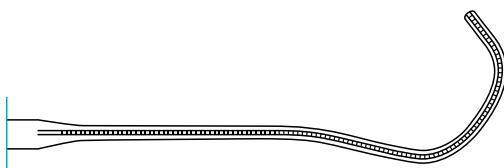

Angled shanks  
180mm, 7" 290-599-043

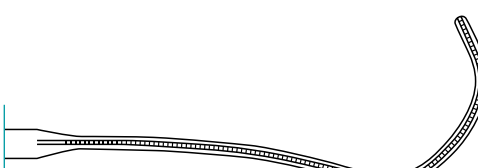

Angled shanks  
180mm, 7" 290-599-044



**DEBAKEY EXTRA FINE**  
Pediatric Vessel Clamp

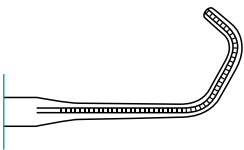

Curved shanks  
115mm, 4<sup>1/2</sup>" 290-599-045

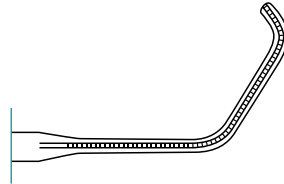

Angled shanks  
120mm, 4<sup>3/4</sup>" 290-599-046

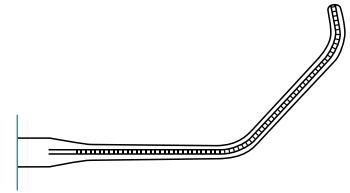

Angled shanks  
150mm, 6" 290-599-047



Curved shanks  
170mm, 6<sup>2/3</sup>" 290-599-048



Curved shanks  
175mm, 6<sup>7/8</sup>" 290-599-049



Curved shanks  
180mm, 7" 290-599-050

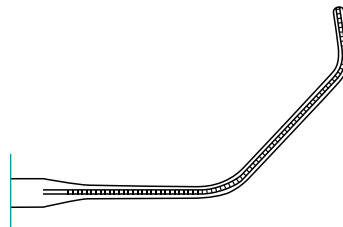

Curved shanks, carotid  
150mm, 6" 290-599-051

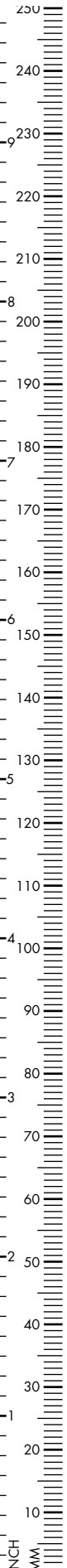



### DEBAKEY

Premature Baby Vascular Clamp,  
ultrafine

105mm, 4<sup>1</sup>/<sub>8</sub>"



Shanks angled backwards

290-587-001

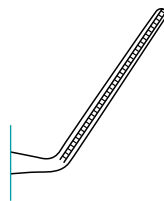

Angled shanks

290-587-002

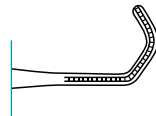

Shanks slightly angled backwards

290-587-003



Straight shanks

290-587-004

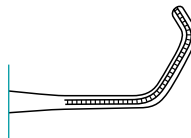

Shanks slightly curved backwards

290-587-005

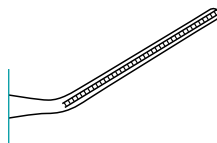

Straight shanks

290-587-006

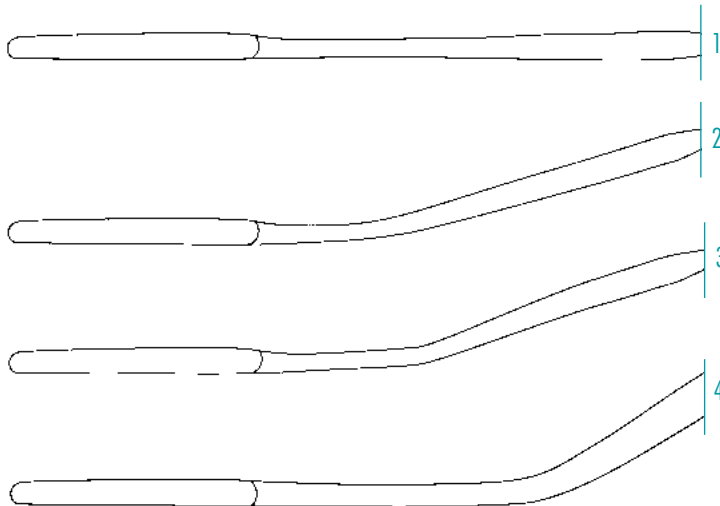
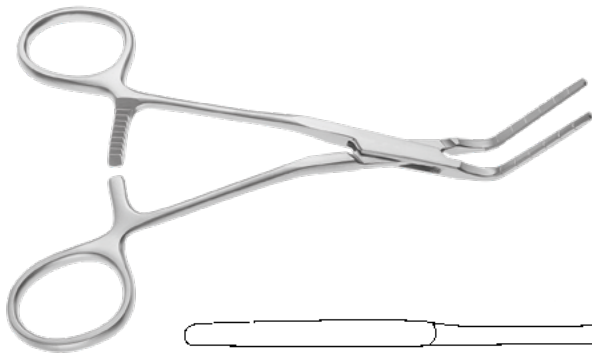

### CASTANEDA

Castaneda Neonatal Clamp, fine  
155mm, 6<sup>1</sup>/<sub>8</sub>"

- 1 Straight shanks
- 2 Slightly curved shanks
- 3 Slightly angled shanks
- 4 Strongly angled shanks

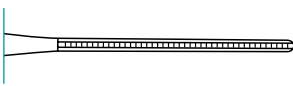

Straight jaw

1	290-594-001
2	290-598-001
3	290-596-001
4	290-597-001

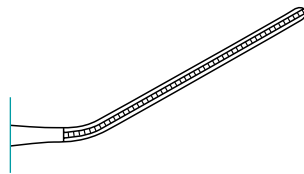

Angled jaw, 30°

1	290-594-002
2	290-598-002
3	290-596-002
4	290-597-002

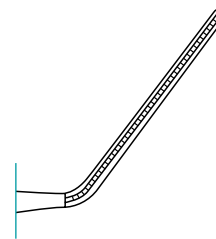

Angled jaw, 45°

1	290-594-003
2	290-598-003
3	290-596-003
4	290-597-003

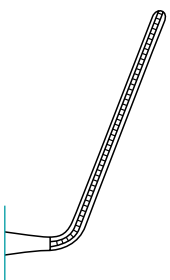

Angled jaw, 60°

1	290-594-004
2	290-598-004
3	290-596-004
4	290-597-004

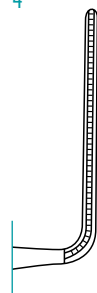

Angled jaw, 90°

1	290-594-005
2	290-598-005
3	290-596-005
4	290-597-005

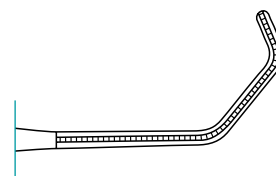

Angled jaw

1	290-594-006
2	290-598-006
3	290-596-006
4	290-597-006

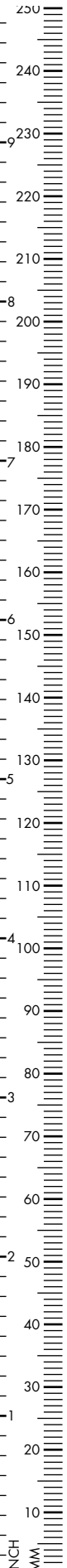

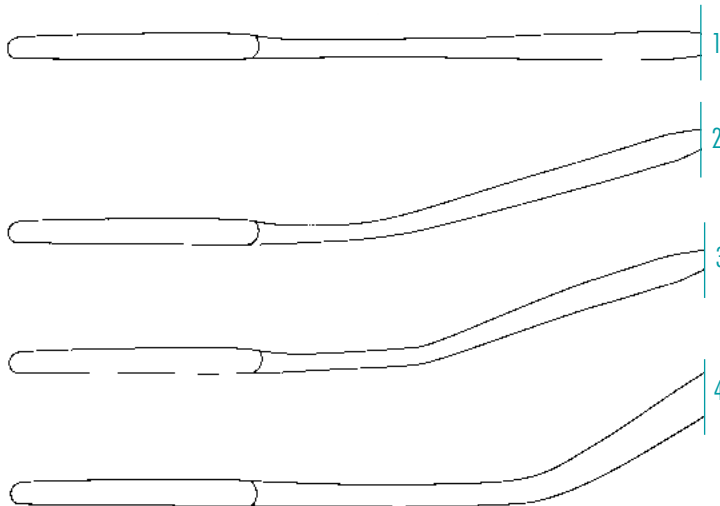
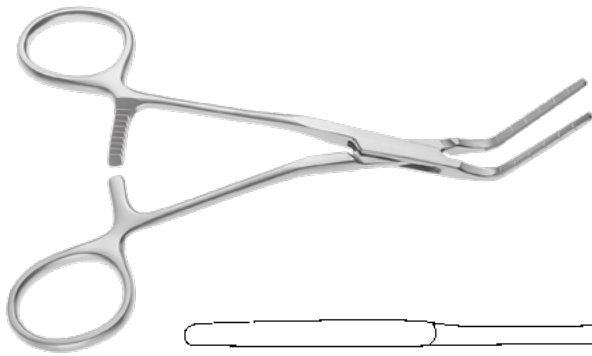

### CASTANEDA

Castaneda Neonatal Clamp, fine  
155mm, 6<sup>1</sup>/<sub>8</sub>"

- 1 Straight shanks
- 2 Slightly curved shanks
- 3 Slightly angled shanks
- 4 Strongly angled shanks

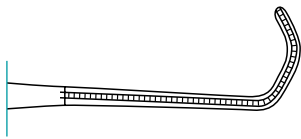

Angled jaw

1	290-594-007
2	290-598-007
3	290-596-007
4	290-597-007

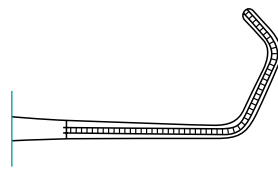

Angled jaw

1	290-594-008
2	290-598-008
3	290-596-008
4	290-597-008

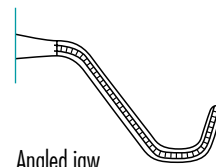

Angled jaw

1	290-594-009
2	290-598-009
3	290-596-009

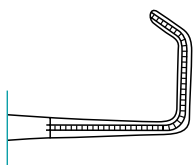

Angled jaw

1	290-594-010
2	290-598-010
3	290-596-010

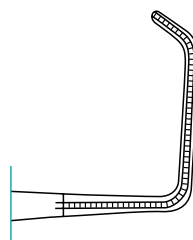

Angled jaw

1	290-594-011
2	290-598-011
3	290-596-011

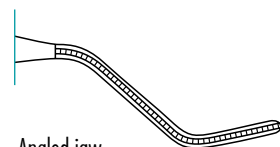

Angled jaw

1	290-594-012
2	290-598-012
3	290-596-012
4	290-597-012

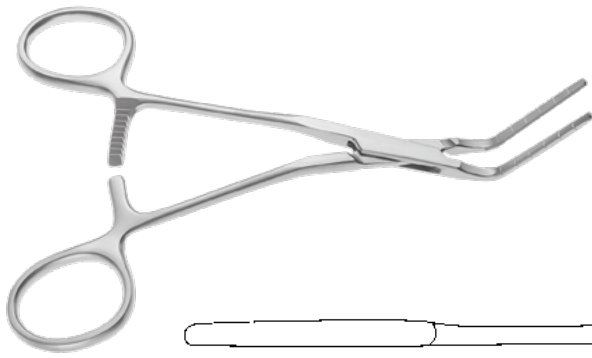

### CASTANEDA

Castaneda Neonatal Clamp, fine  
110mm, 6<sup>1</sup>/<sub>8</sub>"

- 1 Straight shanks
- 2 Slightly curved shanks
- 3 Slightly angled shanks
- 4 Strongly angled shanks

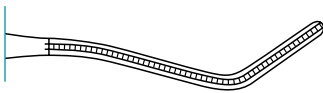
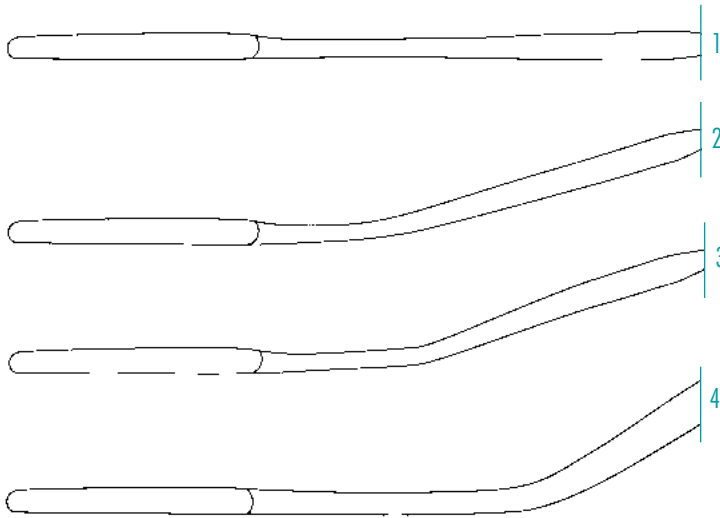

Angled jaw

1	290-594-013
2	290-598-013
3	290-596-013

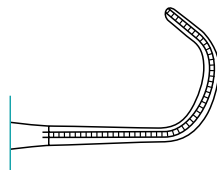

Curved jaw

1	290-594-014
2	290-598-014
3	290-596-014

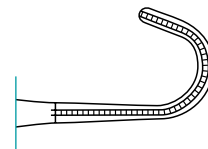

Curved jaw

1	290-594-015
2	290-598-015
3	290-596-015

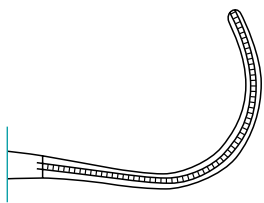

Curved jaw

1	290-594-016
2	290-598-016

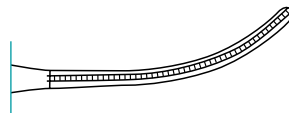

Curved jaw

1	290-594-017
2	290-598-017
3	290-596-017



Curved jaw

1	290-594-018
2	290-598-018

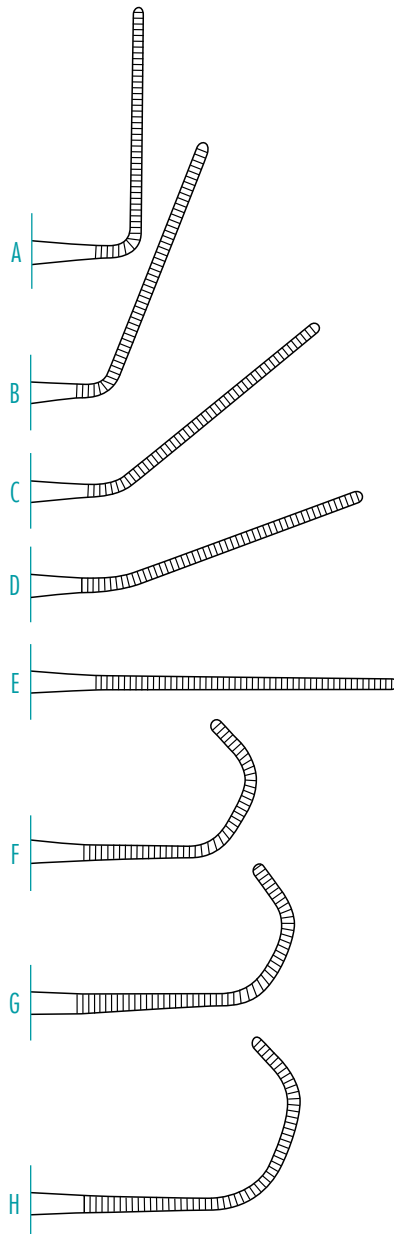

### CASTANEDA

Neonatal Clamp, extra delicate, graduated, shanks curved backwards

A	130mm, 5 <sup>1</sup> / <sub>8</sub> "	290-593-003
B	130mm, 5 <sup>1</sup> / <sub>8</sub> "	290-593-002
C	130mm, 5 <sup>1</sup> / <sub>8</sub> "	290-593-001
D	130mm, 5 <sup>1</sup> / <sub>8</sub> "	290-593-000
E	130mm, 5 <sup>1</sup> / <sub>8</sub> "	290-593-004
F	150mm, 6"	290-595-001
G	150mm, 6"	290-595-002
H	150mm, 6"	290-595-003

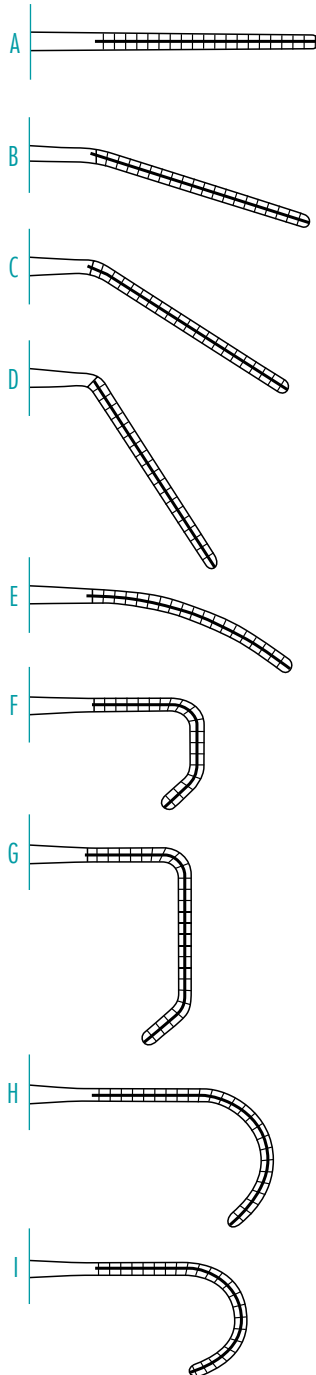

### BABY COOLEY

Pediatric Clamp, shanks curved backwards  
140mm, 5<sup>1</sup>/<sub>2</sub>"

A straight	290-573-001
B angled 15°	290-573-002
C angled 45°	290-573-003
D angled 60°	290-573-004
125mm, 5"	
E curved	290-573-005
130mm, 5 <sup>1</sup> / <sub>8</sub> "	
F angled	290-573-006
140mm, 5 <sup>1</sup> / <sub>2</sub> "	
G angled	290-573-007
H curved	290-573-008
I curved	290-573-009



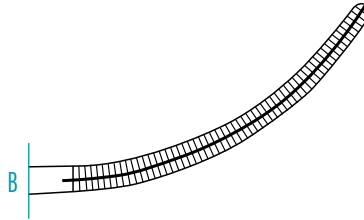
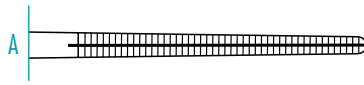
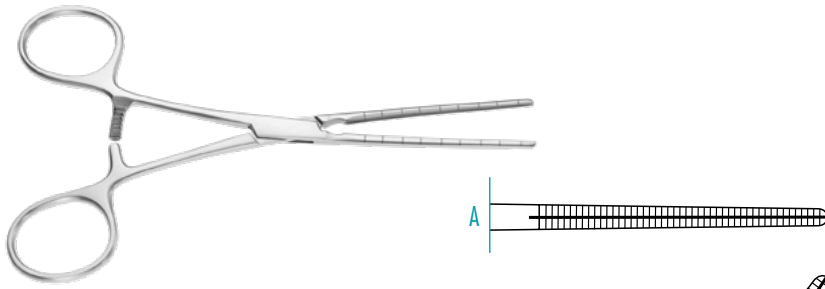

### COOLEY

Atrauma Clamp, straight shanks

A 140mm, 5<sup>1</sup>/<sub>2</sub>" 290-465-000

B 120mm, 4<sup>3</sup>/<sub>4</sub>" 290-465-002

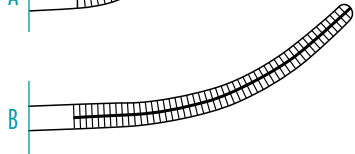
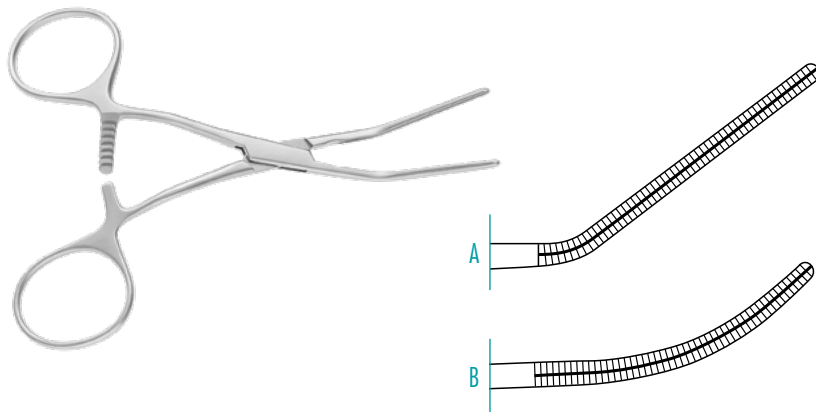

curved shanks

A 125mm, 5" 290-465-004

B 120mm, 4<sup>3</sup>/<sub>4</sub>" 290-465-003

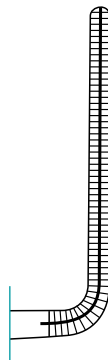

straight shanks

100mm, 4" 290-465-007

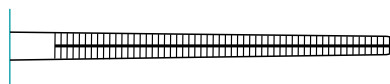
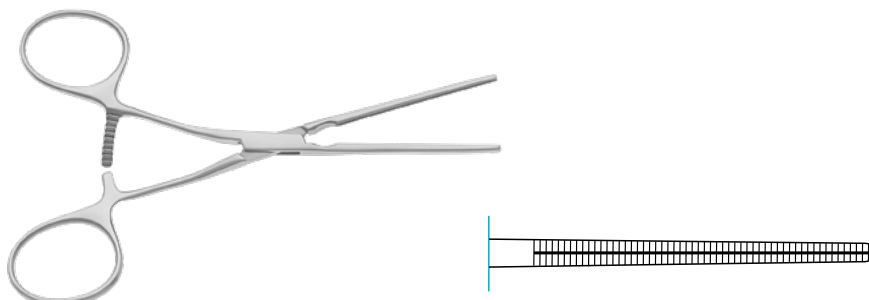

angled shanks

125mm, 5" 290-465-001

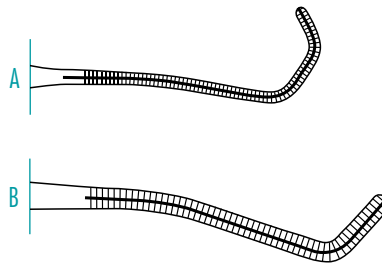

### COOLEY

Atrauma Clamp, s-angled

A	120mm, 4 <sup>3</sup> / <sub>4</sub> "	290-465-008
B	120mm, 4 <sup>3</sup> / <sub>4</sub> "	290-465-005

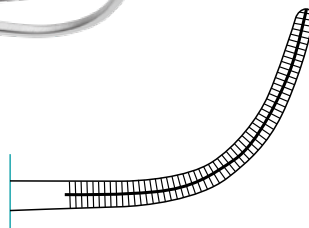
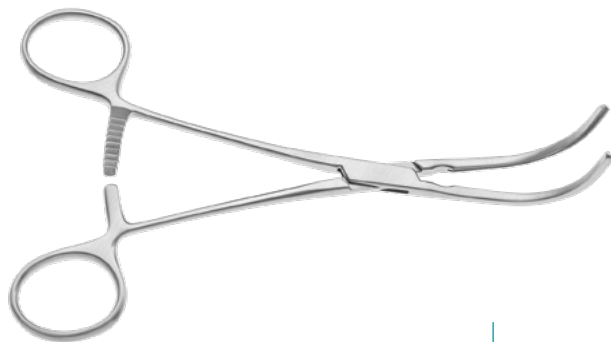

### COOLEY

Vascular Clamp

	160mm, 6 <sup>1</sup> / <sub>4</sub> "	290-469-160
--	--	-------------

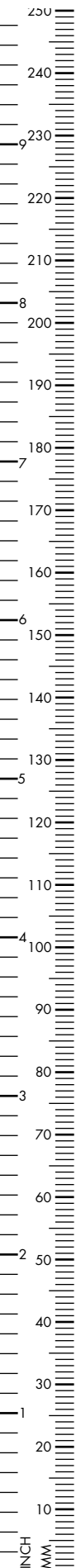

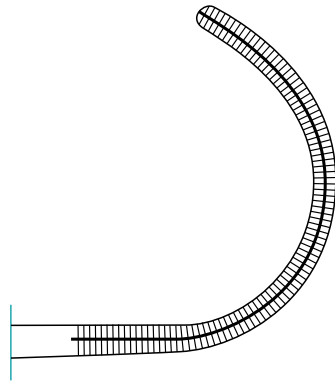

### COOLEY

Multi-Purpose Clamp

200mm, 8"

290-480-200

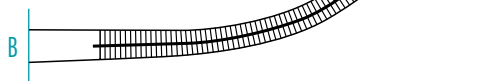
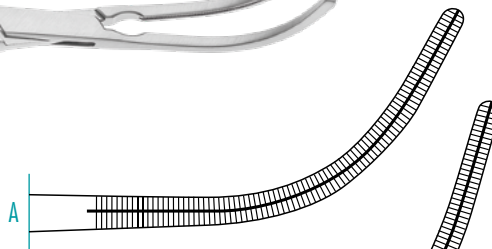
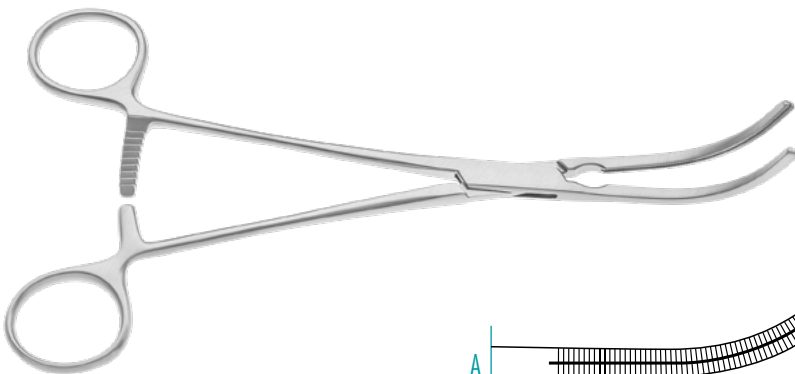

### COOLEY

Multi-Purpose Clamp

A 215mm, 8<sup>1</sup>/<sub>2</sub>"

290-471-215

B 245mm, 9<sup>2</sup>/<sub>3</sub>"

290-471-245

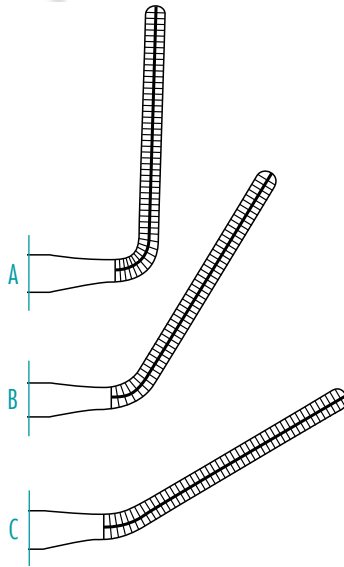
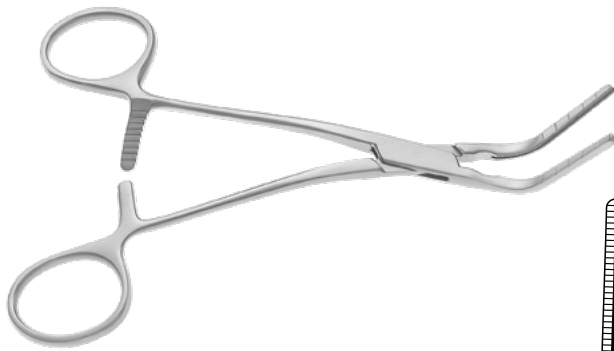

### COOLEY

#### Multi Purpose Forceps

A	150mm, 6"	290-472-150
B	160mm, 6 <sup>1</sup> / <sub>4</sub> "	290-472-155
C	170mm, 6 <sup>2</sup> / <sub>3</sub> "	290-472-160

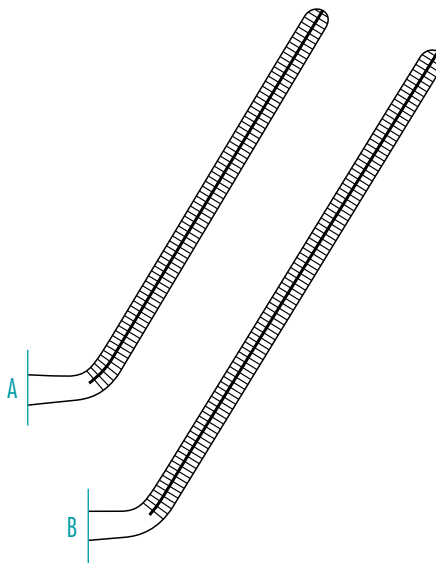
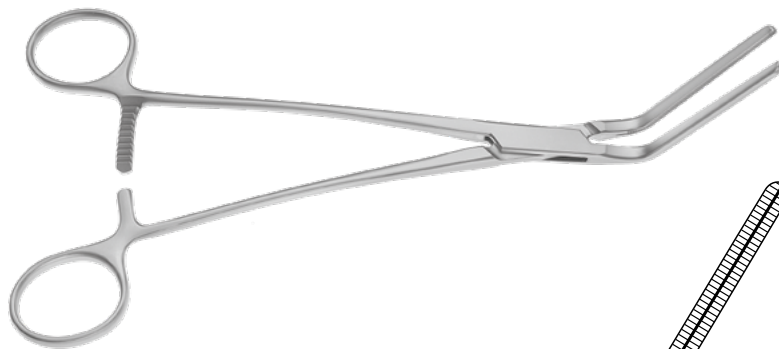

### COOLEY

#### Multi-Purpose Clamp

A	205mm, 8 <sup>1</sup> / <sub>8</sub> "	290-509-200
B	240mm, 9 <sup>1</sup> / <sub>2</sub> "	290-509-240

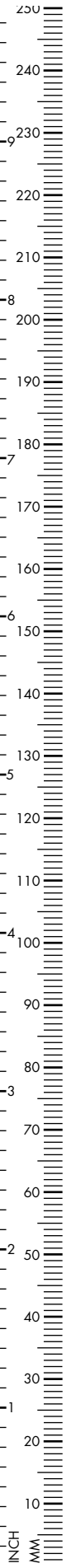



**COOLEY PARRY**  
Anastomosis Clamp,  
shanks angled backwards

A	180mm, 7"	290-481-001
B	235mm, 9 <sup>1</sup> / <sub>4</sub> "	290-481-002

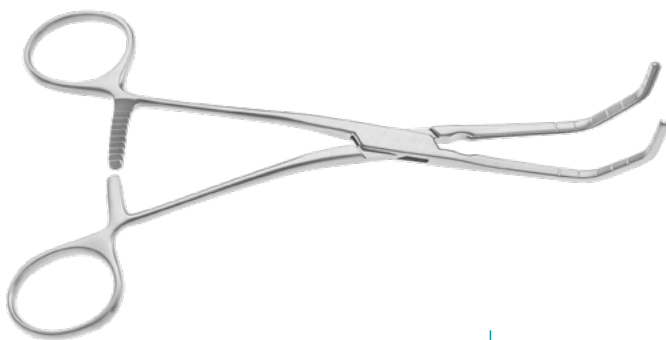
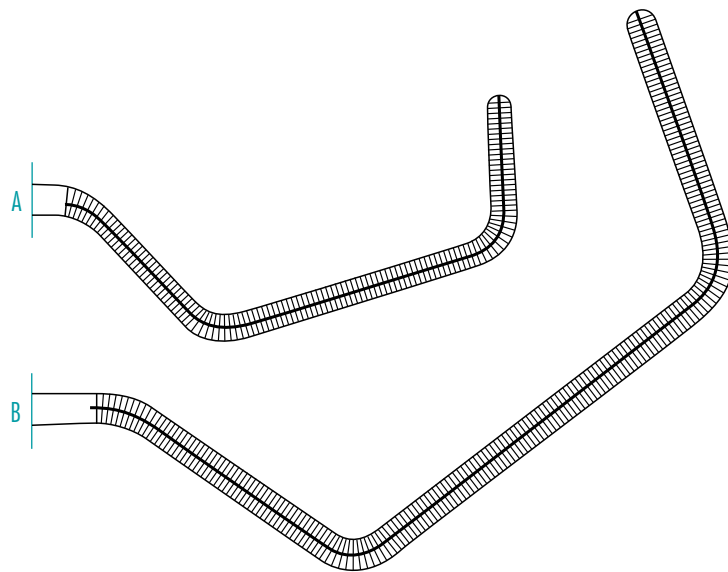

**COOLEY**  
Anastomosis Clamp

A	175mm, 6 <sup>7</sup> / <sub>8</sub> "	290-721-165
B	175mm, 6 <sup>7</sup> / <sub>8</sub> "	290-722-165

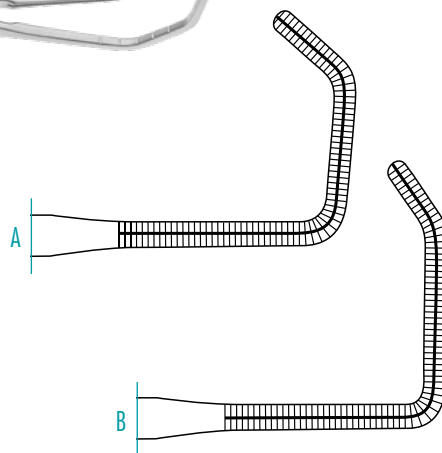

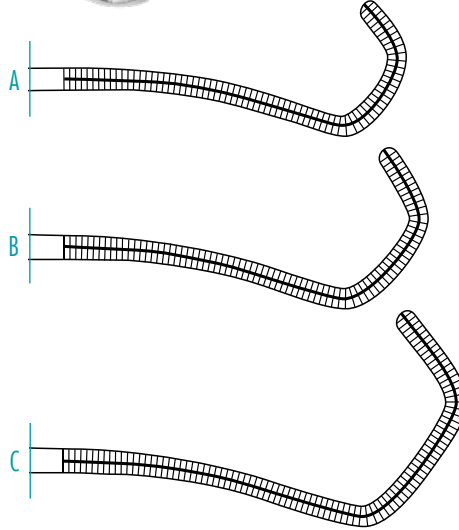
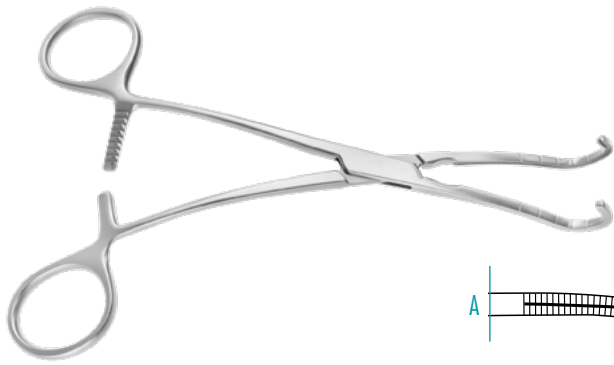

### COOLEY DERRA

Anastomosis Clamp

A	160mm, 6 <sup>1</sup> / <sub>4</sub> "	290-478-160
B	170mm, 6 <sup>2</sup> / <sub>3</sub> "	290-478-170
C	180mm, 7"	290-478-180

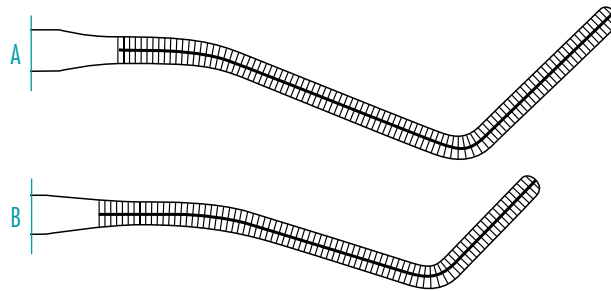
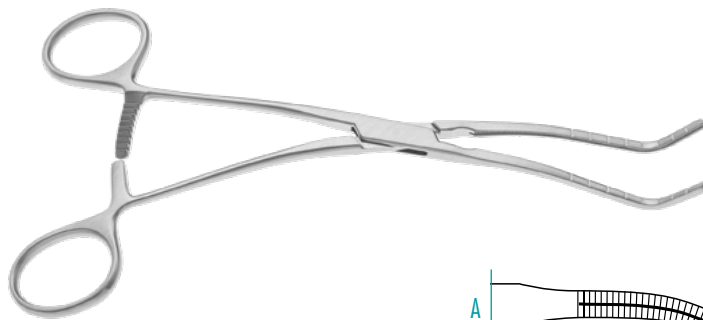

### COOLEY

Clamp

A	195mm, 7 <sup>3</sup> / <sub>4</sub> "	290-469-200
B	185mm, 7 <sup>1</sup> / <sub>4</sub> "	290-469-185

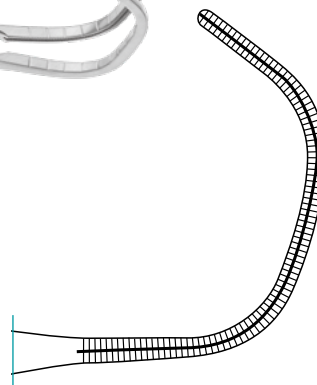

### COOLEY LEITZ

Anastomosis Clamp

	195mm, 7 <sup>3</sup> / <sub>4</sub> "	290-508-190
--	--	-------------

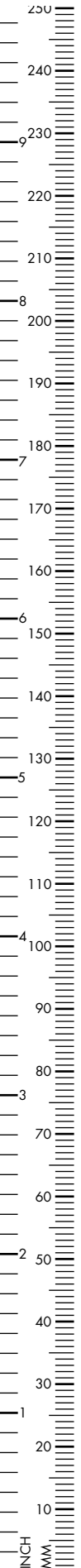

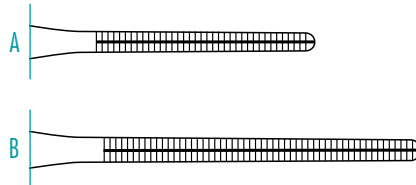

### COOLEY

Forceps, shanks angled

A	160mm, 6 <sup>1</sup> / <sub>4</sub> "	290-473-160
B	170mm, 6 <sup>2</sup> / <sub>3</sub> "	290-473-170

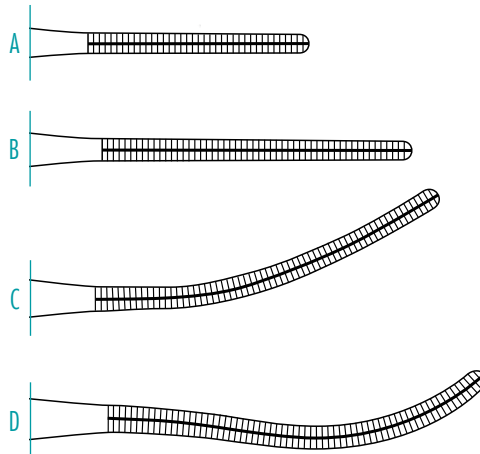
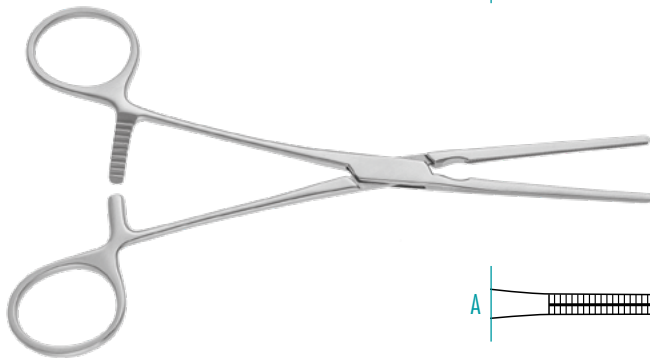

### COOLEY

Forceps, straight

A	160mm, 6 <sup>1</sup> / <sub>4</sub> "	290-468-160
B	170mm, 6 <sup>2</sup> / <sub>3</sub> "	290-468-170
C	170mm, 6 <sup>2</sup> / <sub>3</sub> "	290-474-170
D	170mm, 6 <sup>2</sup> / <sub>3</sub> "	290-476-170

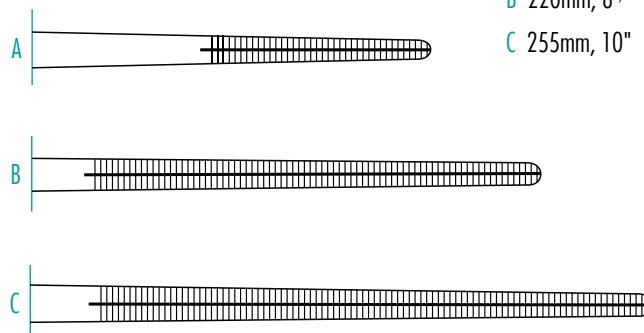
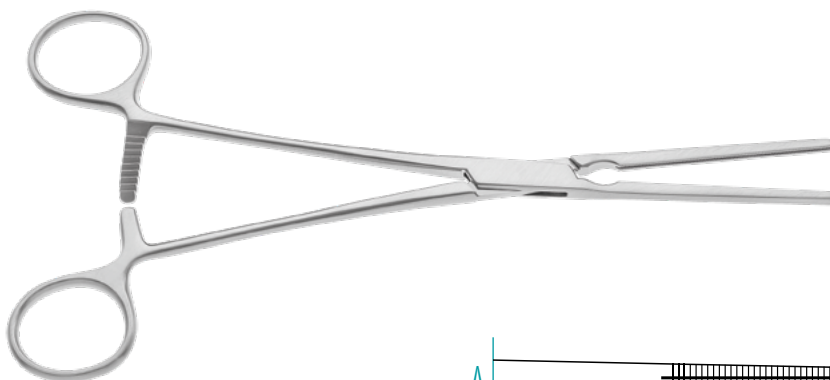

### COOLEY

Clamp,  
straight shanks

A	210mm, 8 <sup>1</sup> / <sub>4</sub> "	290-450-210
B	220mm, 8 <sup>2</sup> / <sub>3</sub> "	290-450-220
C	260mm, 10 <sup>1</sup> / <sub>4</sub> "	290-450-260

angled shanks

A	205mm, 8 <sup>1</sup> / <sub>8</sub> "	290-452-200
B	220mm, 8 <sup>2</sup> / <sub>3</sub> "	290-452-220
C	255mm, 10"	290-452-250

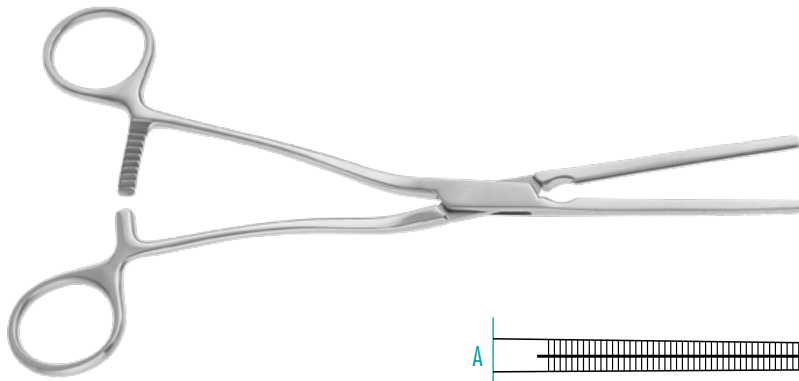

### COOLEY

Iliac Clamp, straight,  
shanks strongly angled

A 210mm, 8<sup>1</sup>/<sub>4</sub>" 290-467-210

B 250mm, 9<sup>7</sup>/<sub>8</sub>" 290-467-255

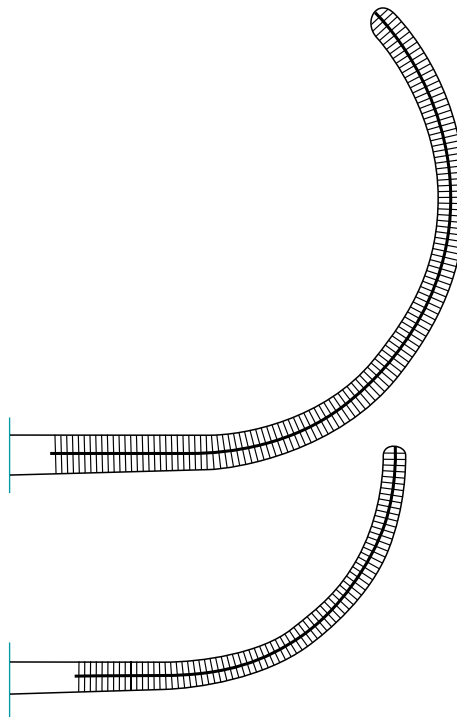

### COOLEY

Clamp, wide curved,  
shanks curved backwards

275mm, 10<sup>7</sup>/<sub>8</sub>" 290-512-270

shanks curved backwards

240mm, 9<sup>1</sup>/<sub>2</sub>" 290-519-240

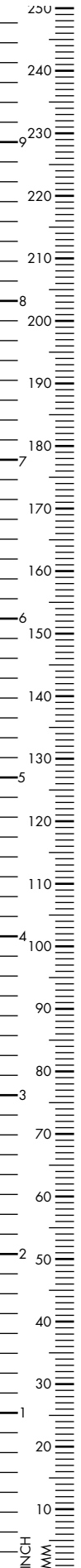





**COOLEY**

Clamp, 3x3teeth, shanks s-curved

310mm, 12<sup>1</sup>/<sub>4</sub>" 290-512-315

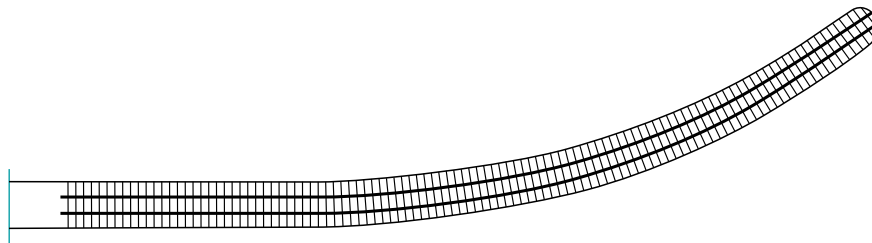

**COOLEY**

Clamp, curved, 3x3 teeth

A 335mm, 13" 290-515-330

2x2 teeth

B 265mm, 10<sup>1</sup>/<sub>2</sub>" 290-514-260

C 190mm, 7<sup>1</sup>/<sub>2</sub>" 290-514-190

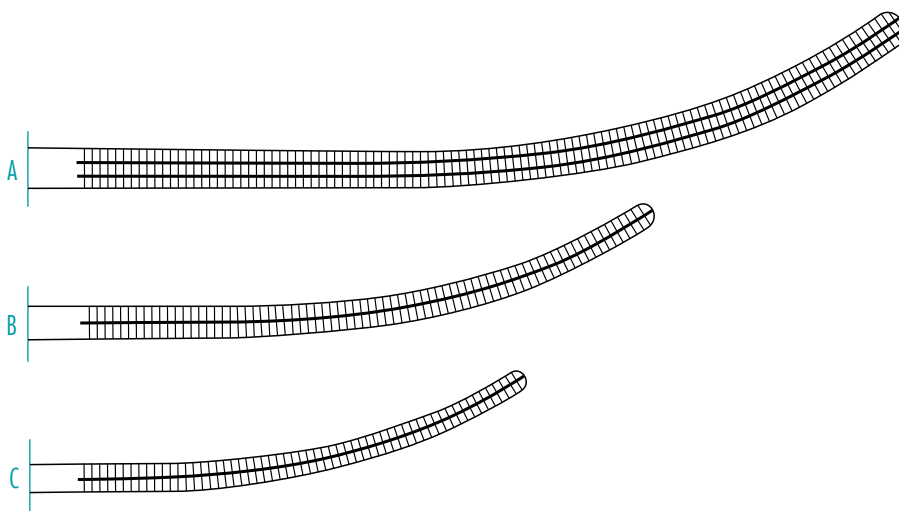



**COOLEY**  
Clamp

225mm, 8 <sup>7</sup> / <sub>8</sub> "	290-516-220
260mm, 10 <sup>1</sup> / <sub>4</sub> "	290-516-260
270mm, 10 <sup>2</sup> / <sub>3</sub> "	290-516-270

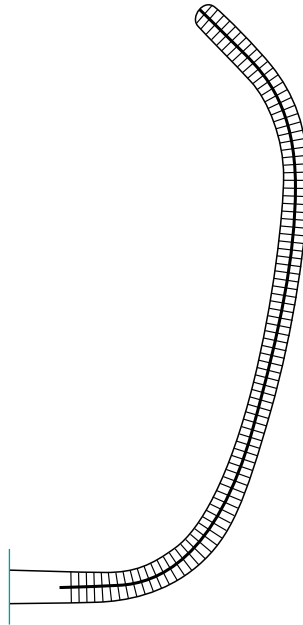

**COOLEY**

Clamp, shanks strongly curved backwards

A 200mm, 8"	290-517-200
B 210mm, 8 <sup>1</sup> / <sub>4</sub> "	290-517-210
C 255mm, 10"	290-517-250

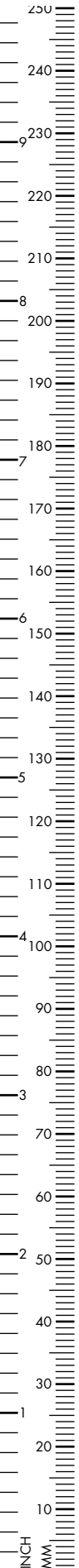
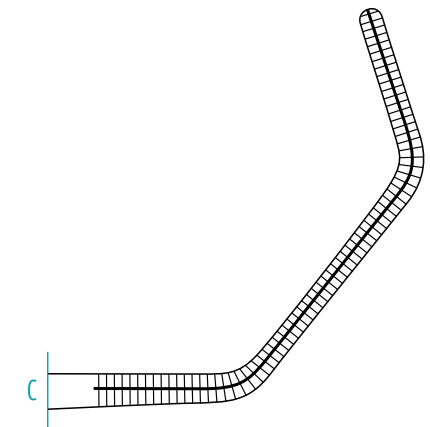
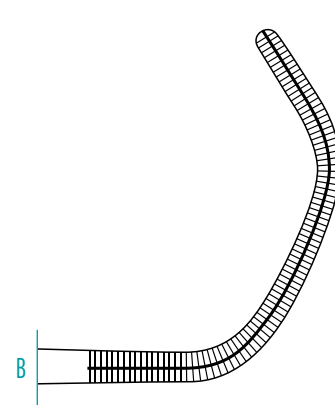
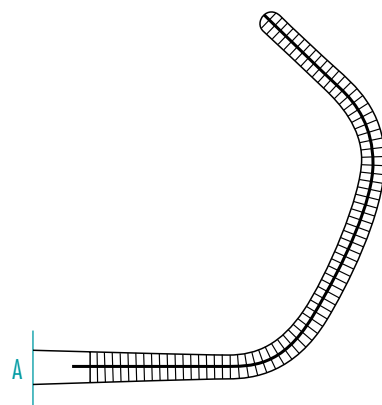

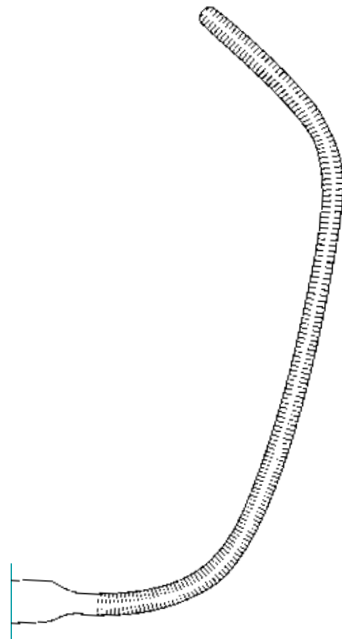
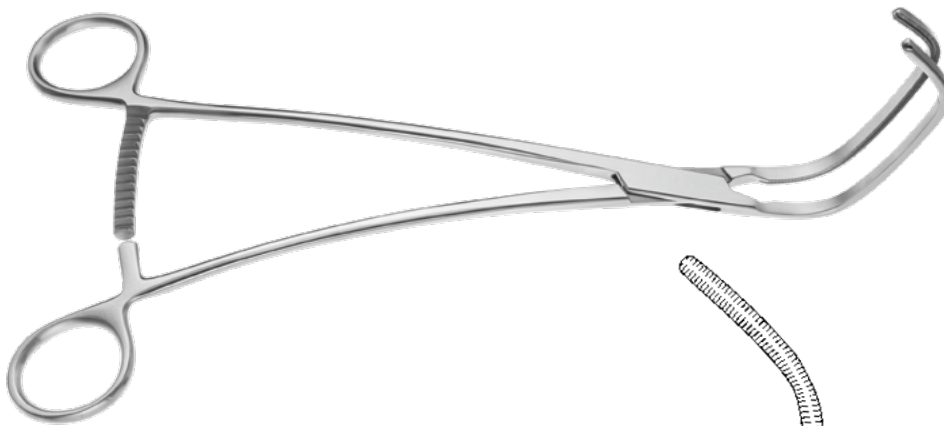

### COOLEY

Clamp, double curved,  
shanks curved backwards

270mm, 10<sup>2/3</sup>"

290-518-270

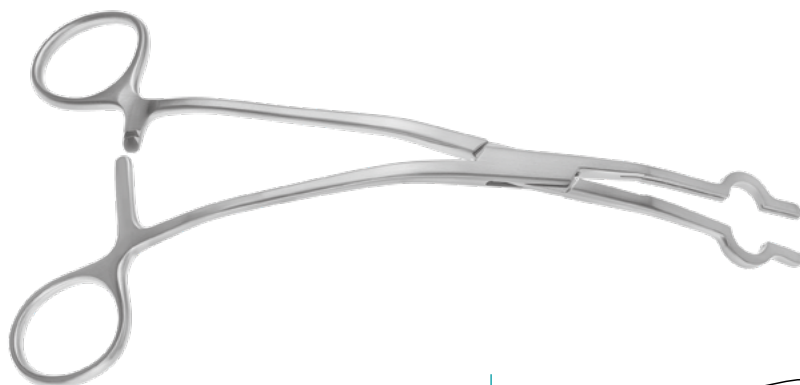

### COOLEY

Clamp, 170mm, 6<sup>2/3</sup>"

20 Charr.

290-350-010

24 Charr.

290-350-001

26 Charr.

290-350-002

28 Charr.

290-350-003

30 Charr.

290-350-004

32 Charr.

290-350-005

36 Charr.

290-350-007

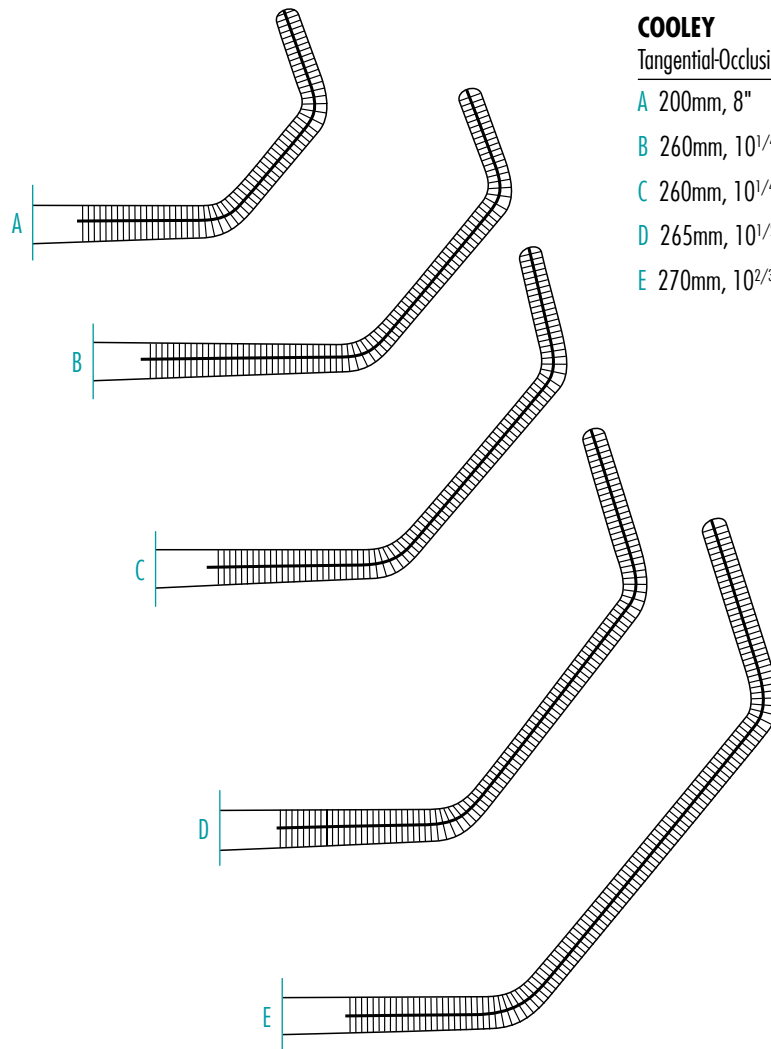
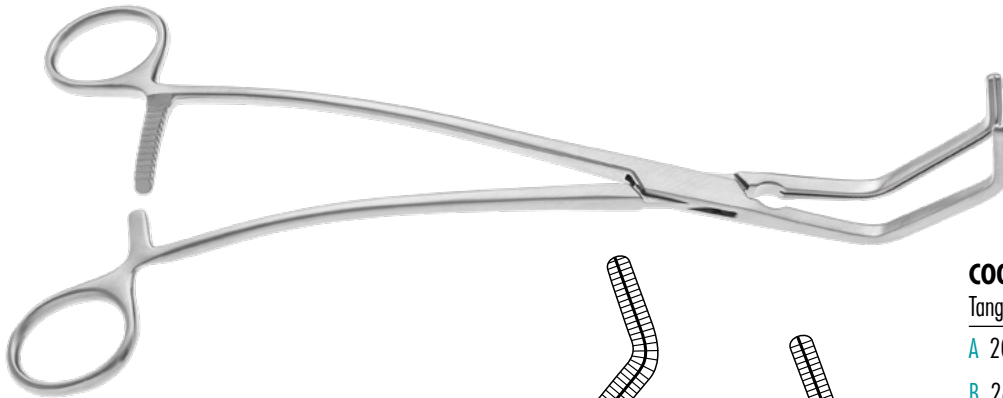

### COOLEY

#### Tangential-Occlusion Clamp

A	200mm, 8"	290-521-200
B	260mm, 10 <sup>1/4</sup> "	290-521-250
C	260mm, 10 <sup>1/4</sup> "	290-521-260
D	265mm, 10 <sup>1/2</sup> "	290-521-265
E	270mm, 10 <sup>2/3</sup> "	290-521-270

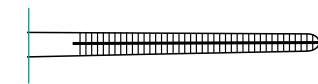
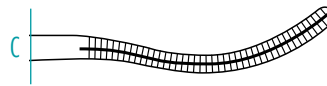
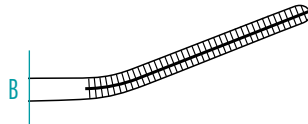

### COOLEY

Pediatric Clamp, 140mm, 5<sup>1</sup>/<sub>2</sub>"

A	290-466-001
B	290-466-002
C	290-466-005

shanks angled

290-466-003

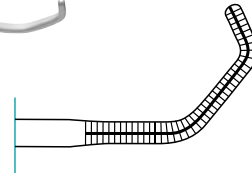
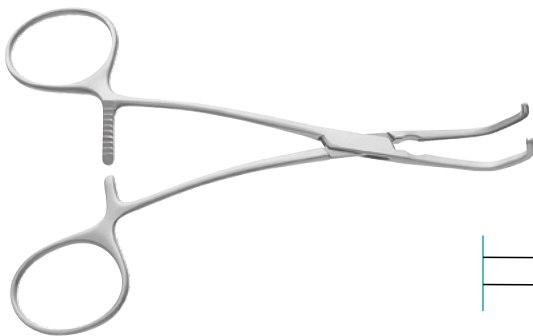

### COOLEY

Pediatric Clamp  
shanks curved backwards

140mm, 5 <sup>1</sup> / <sub>2</sub> "	290-466-004
--	-------------

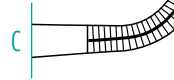
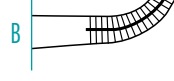
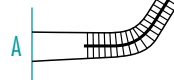

### COOLEY

Pediatric Clamp

A 165mm, 6 <sup>1</sup> / <sub>2</sub> "	290-468-001
B 175mm, 6 <sup>7</sup> / <sub>8</sub> "	290-468-002
C 185mm, 7 <sup>1</sup> / <sub>4</sub> "	290-468-003

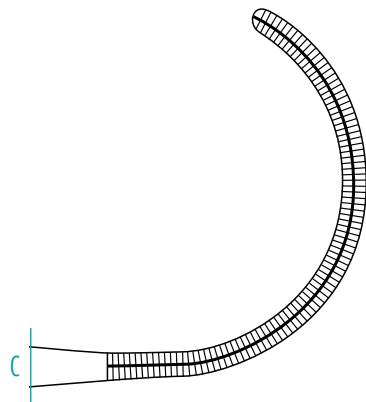
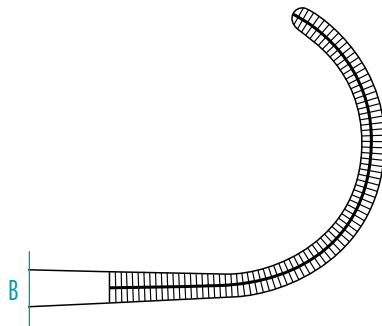
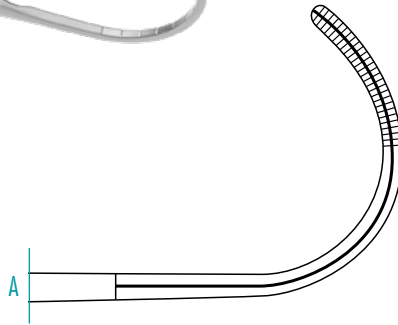

### COOLEY

Forceps, shanks backwards

A	170mm, 6 <sup>2</sup> / <sub>3</sub> "	290-477-150
B	160mm, 6 <sup>1</sup> / <sub>4</sub> "	290-477-160
C	170mm, 6 <sup>2</sup> / <sub>3</sub> "	290-477-170

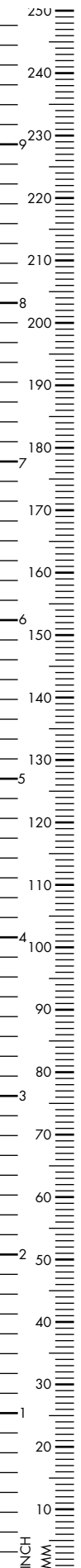



**COOLEY**

Clamp, shanks curved backwards

270mm, 10<sup>2</sup>/<sub>3</sub>"

290-513-270

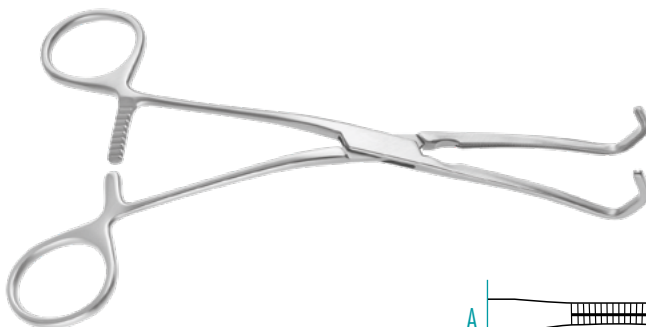
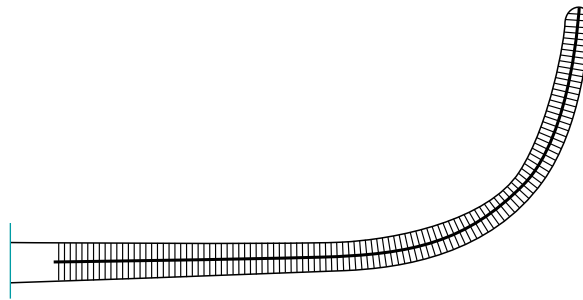

**COOLEY**

Clamp, shanks curved backwards

A 170mm, 6<sup>2</sup>/<sub>3</sub>"

290-470-170

B 170mm, 6<sup>2</sup>/<sub>3</sub>"

290-471-160

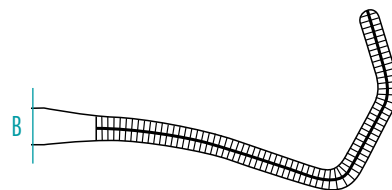
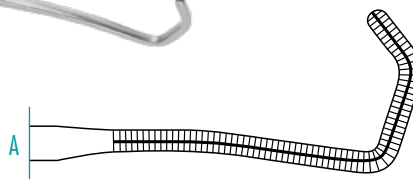

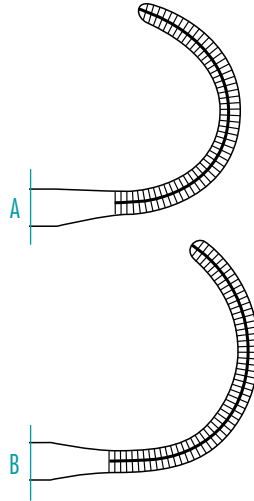

### COOLEY BECK

Vessel Clamp, 150mm, 6"  
narrow curved

A 290-478-150

wide curved

B 290-478-155

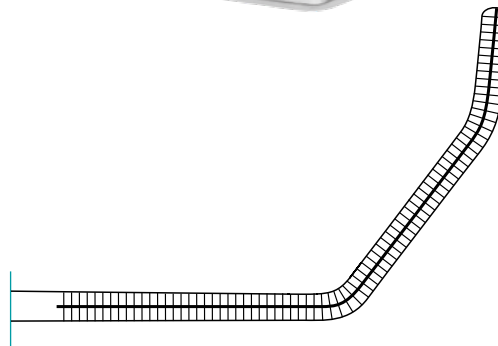

### COOLEY

Clamp, s-angled, shanks curved backwards

250mm, 9<sup>7</sup>/<sub>8</sub>" 290-513-240

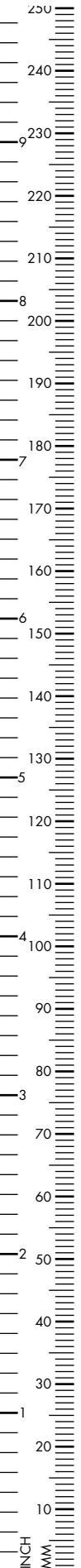





### FOGARTY

Clamp

33mm, 170mm, 6 <sup>2</sup> / <sub>3</sub> "	290-487-170
61mm, 290mm, 11 <sup>1</sup> / <sub>2</sub> "	290-487-290
86mm, 300mm, 11 <sup>7</sup> / <sub>8</sub> "	290-487-300



### FOGARTY

Clamp, 60° curved

33mm, 160mm, 6 <sup>1</sup> / <sub>4</sub> "	290-488-160
61mm, 260mm, 10 <sup>1</sup> / <sub>4</sub> "	290-488-260

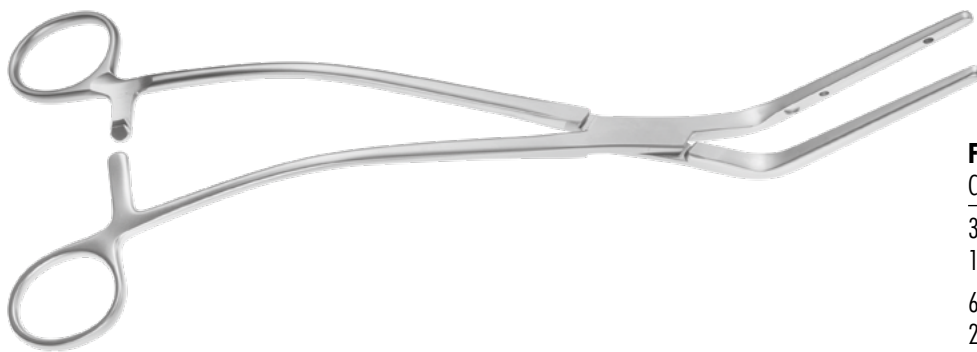

**FOGARTY**

Clamp, curved

33mm, 170mm, 6 <sup>2</sup> / <sub>3</sub> "	290-489-170
61mm, 260mm, 10 <sup>1</sup> / <sub>4</sub> "	290-489-260
86mm, 290mm, 11 <sup>1</sup> / <sub>2</sub> "	290-489-290

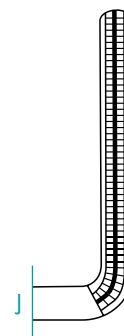
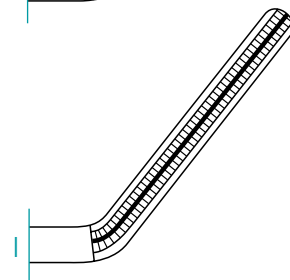
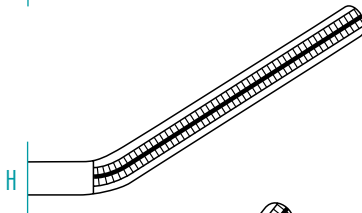
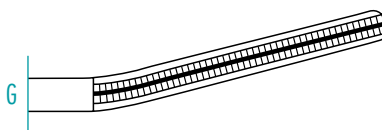
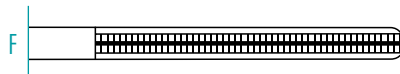
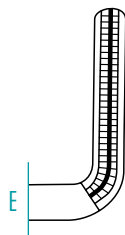
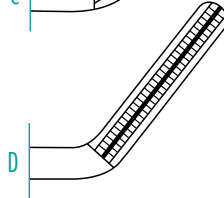
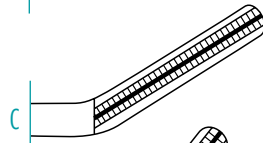
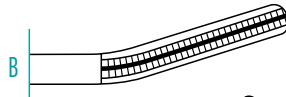
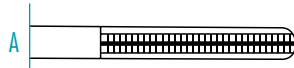

### DARDIK

Multi-Purpose Clamp, 38mm

A	130mm, 5 <sup>1</sup> / <sub>8</sub> "	290-336-000
B	145mm, 5 <sup>3</sup> / <sub>4</sub> "	290-336-015
C	150mm, 6"	290-336-030
D	150mm, 6"	290-336-045
E	150mm, 6"	290-336-090

58mm

F	135mm, 5 <sup>1</sup> / <sub>3</sub> "	290-338-000
G	160mm, 6 <sup>1</sup> / <sub>4</sub> "	290-338-015
H	170mm, 6 <sup>2</sup> / <sub>3</sub> "	290-338-030
I	170mm, 6 <sup>2</sup> / <sub>3</sub> "	290-338-045
J	170mm, 6 <sup>2</sup> / <sub>3</sub> "	290-338-090

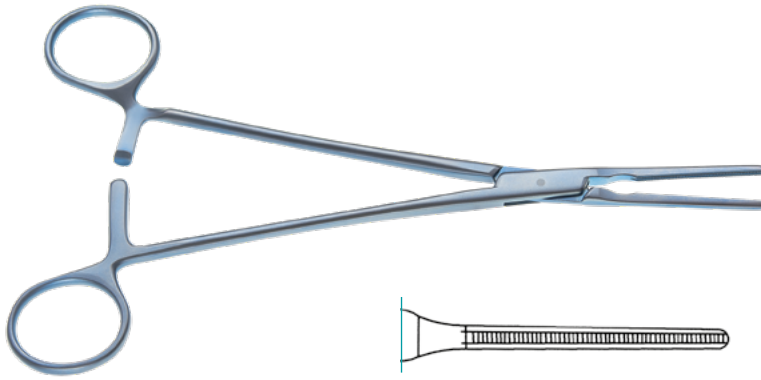

**GLOVER**

Clamp,  
straight shanks

200mm, 8" 290-700-200

angled shanks

200mm, 8" 290-701-200

straight shanks

200mm, 8" 290-700-201

angled shanks

200mm, 8" 290-701-201

straight shanks

210mm, 8<sup>1</sup>/<sub>4</sub>" 290-700-210

angled shanks

210mm, 8<sup>1</sup>/<sub>4</sub>" 290-701-210

straight shanks

220mm, 8<sup>2</sup>/<sub>3</sub>" 290-700-220

angled shanks

220mm, 8<sup>2</sup>/<sub>3</sub>" 290-701-220

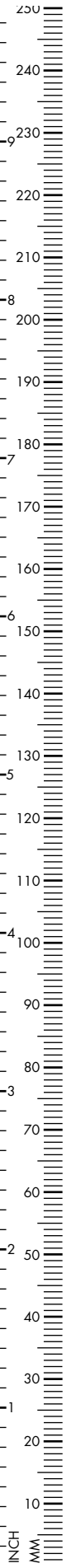

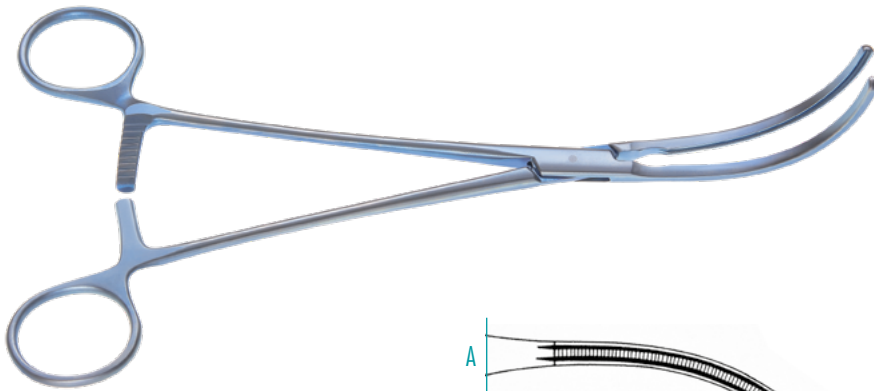

**GLOVER**

Clamp

A	210mm, 8 <sup>1</sup> / <sub>4</sub> "	290-719-210
B	240mm, 9 <sup>1</sup> / <sub>2</sub> "	290-719-240
C	150mm, 6"	290-719-150
D	210mm, 8 <sup>1</sup> / <sub>4</sub> "	290-721-210
E	240mm, 9 <sup>1</sup> / <sub>2</sub> "	290-721-240

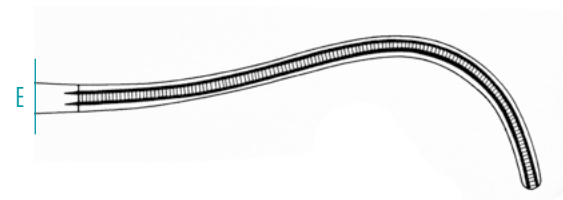
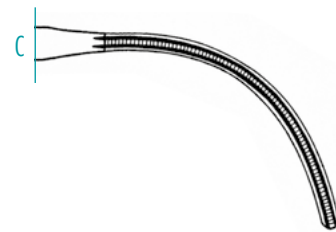
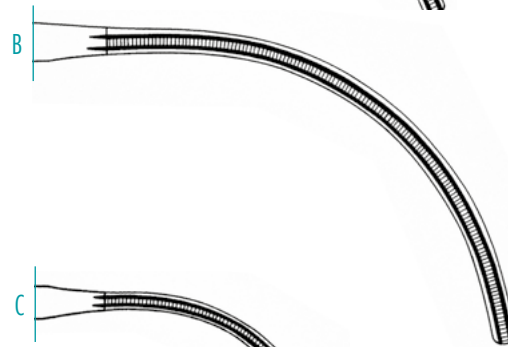
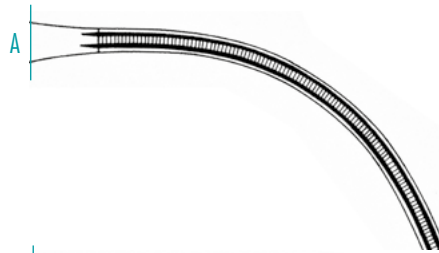

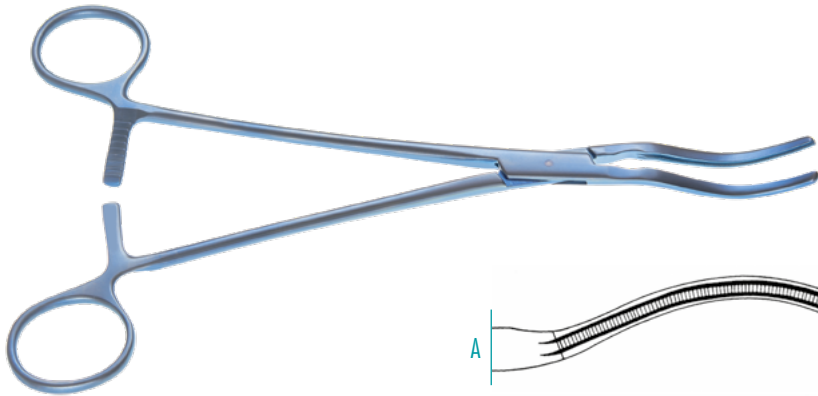
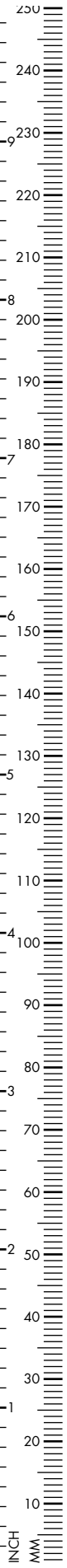

**GLOVER**

Clamp, spoon shaped

A	215mm, 8 <sup>1</sup> / <sub>2</sub> "	290-703-210
B	260mm, 10 <sup>1</sup> / <sub>4</sub> "	290-703-260

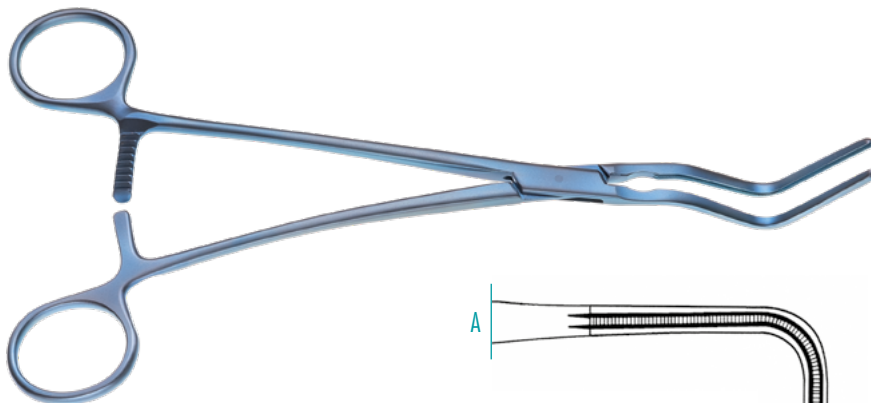
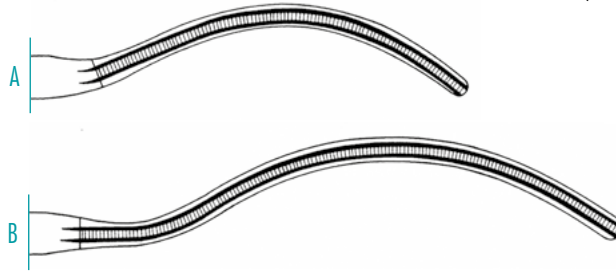

**LEES**

Bronchus Clamp, 220mm, 8<sup>2</sup>/<sub>3</sub>"

A	290-707-220
B	290-707-230

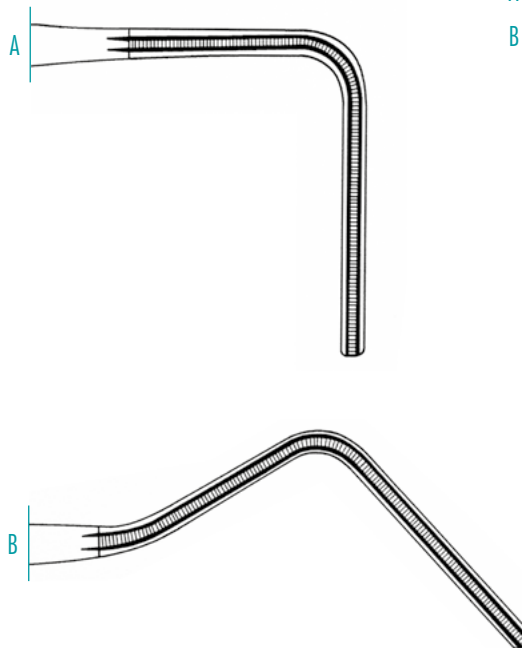

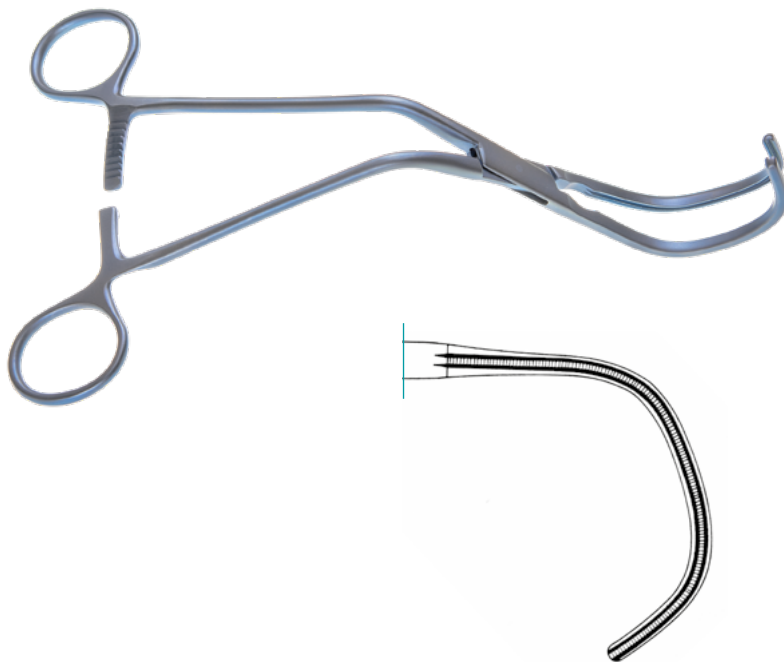

**LAMBERT-KAY**

Clamp

200mm, 8"

290-730-210

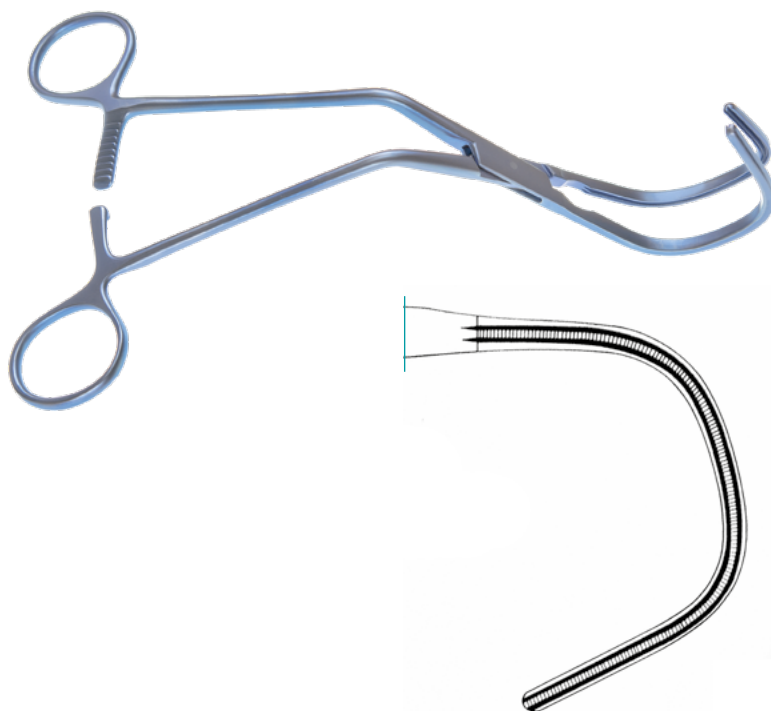

**KAY**

Clamp

200mm, 8"

290-711-200

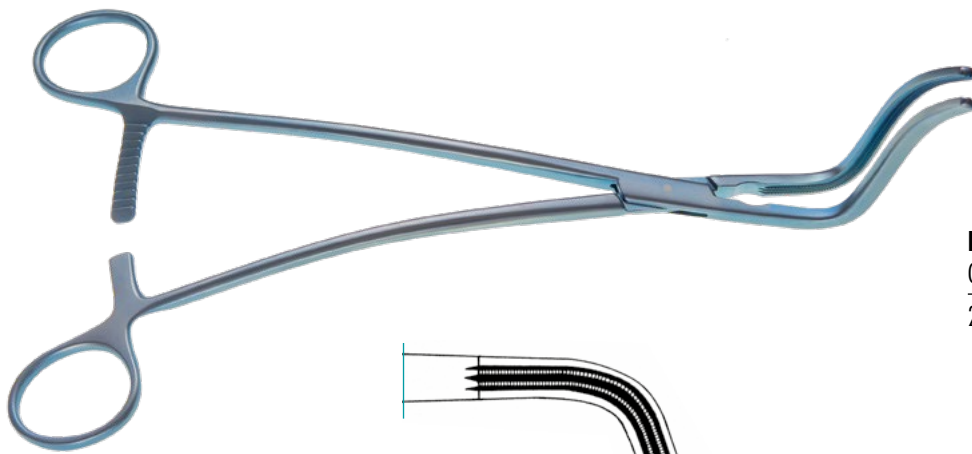

**DEBAKEY**

Clamp

265mm, 10<sup>1</sup>/<sub>2</sub>"

290-713-260

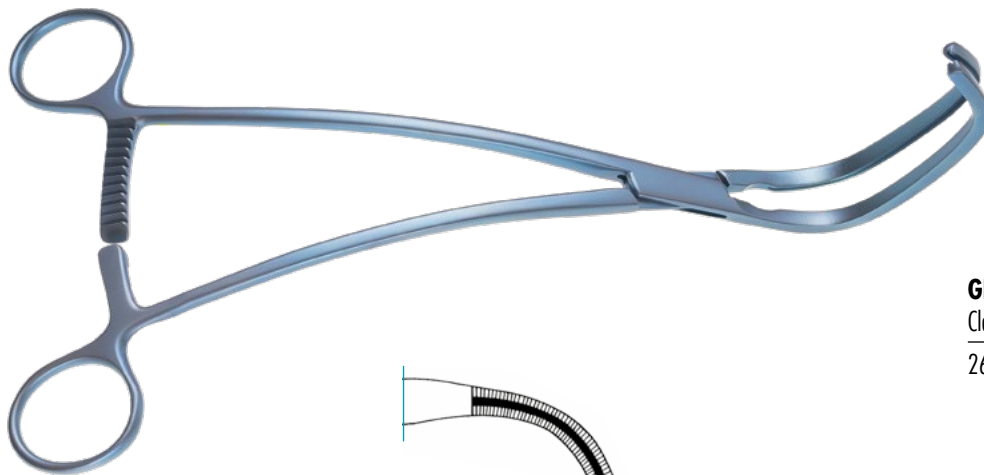
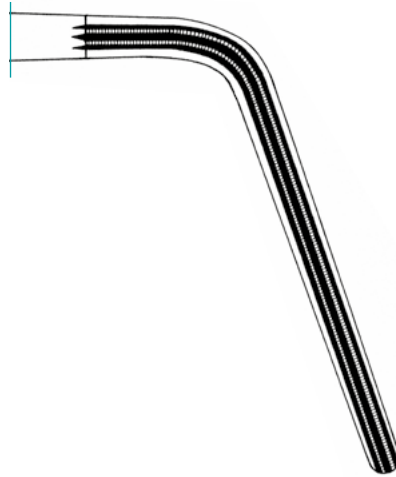

**GLOVER**

Clamp

265mm, 10<sup>1</sup>/<sub>2</sub>"

290-715-260

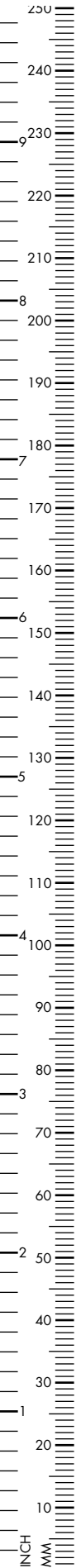



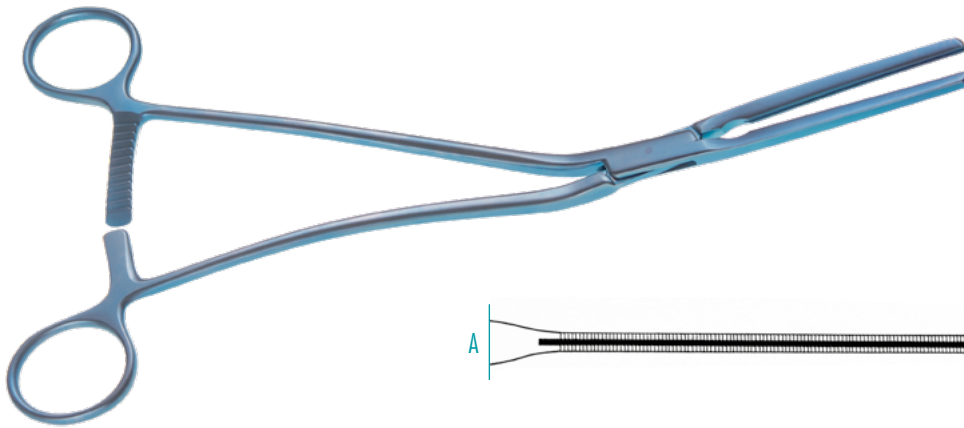

**COOLEY**  
Clamp

A	215mm, 8 <sup>1</sup> / <sub>2</sub> "	290-717-210
B	260mm, 10 <sup>1</sup> / <sub>4</sub> "	290-717-260

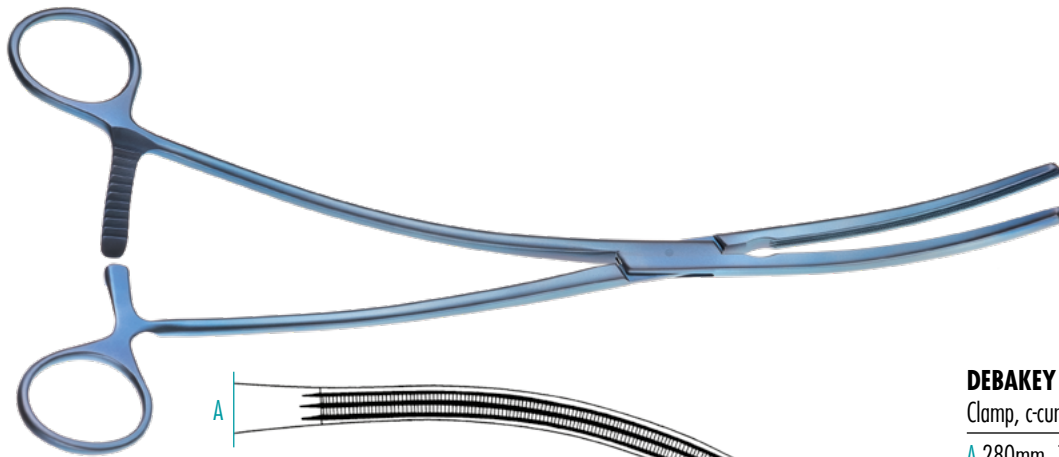

**DEBAKEY**  
Clamp, c-curved

A	280mm, 11"	290-723-280
B	300mm, 11 <sup>7</sup> / <sub>8</sub> "	290-723-300
C	320mm, 12 <sup>5</sup> / <sub>8</sub> "	290-723-320
D	340mm, 13 <sup>1</sup> / <sub>3</sub> "	290-723-340

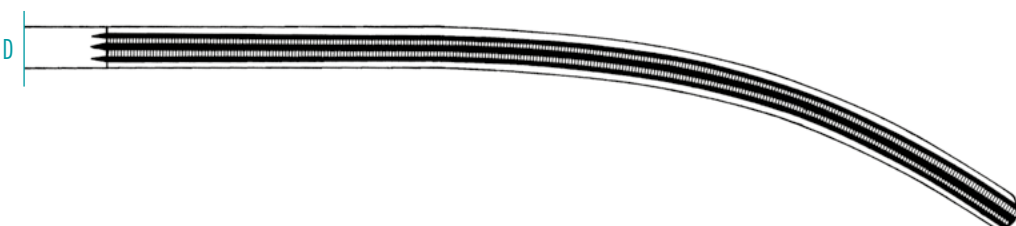
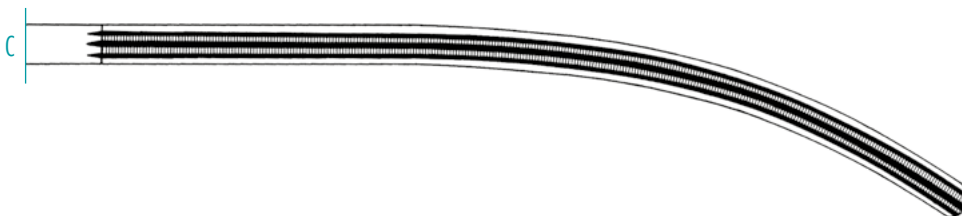
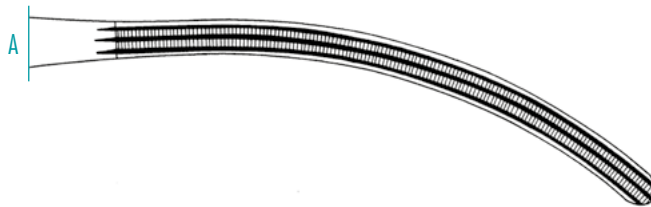

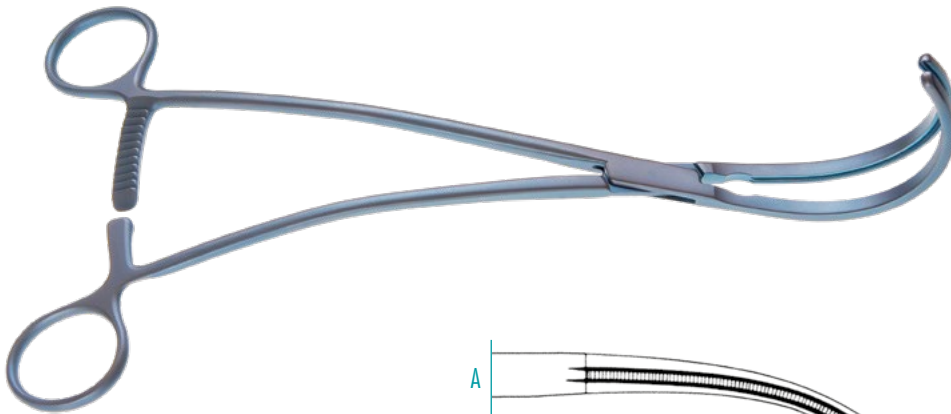

**DEBAKEY**  
Clamp

A	265mm, 10 <sup>1</sup> / <sub>2</sub> "	290-727-270
B	260mm, 10 <sup>1</sup> / <sub>4</sub> "	290-727-260
C	180mm, 7"	290-729-180

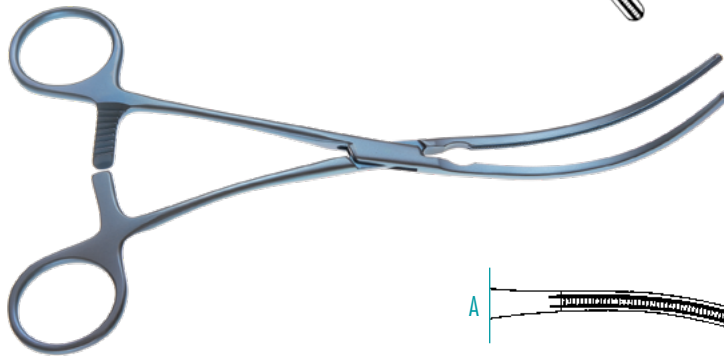
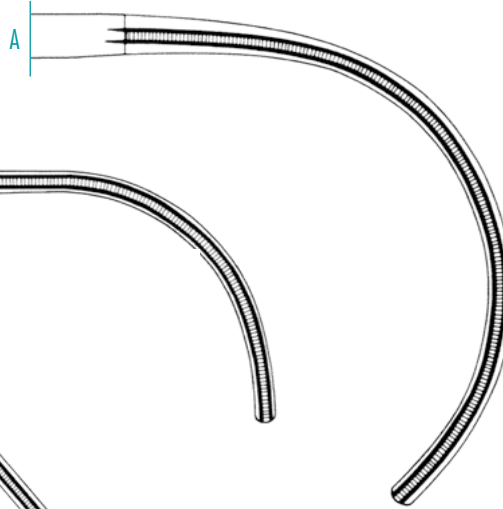

**DEBAKEY**  
Clamp

A	200mm, 8"	290-727-200
B	185mm, 7 <sup>1</sup> / <sub>4</sub> "	290-727-180

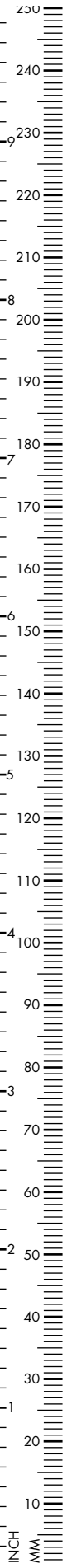
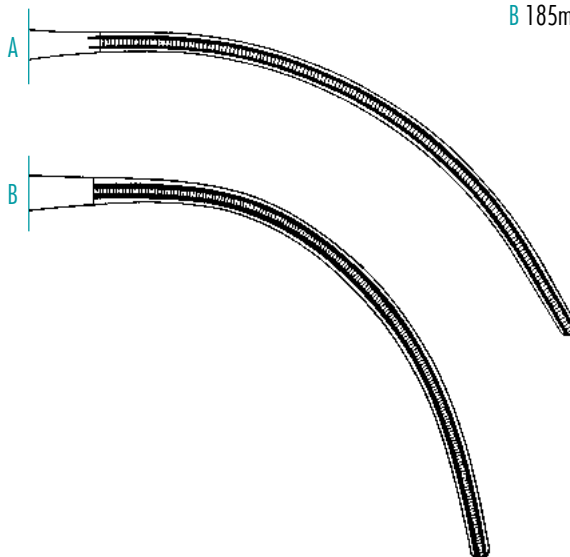

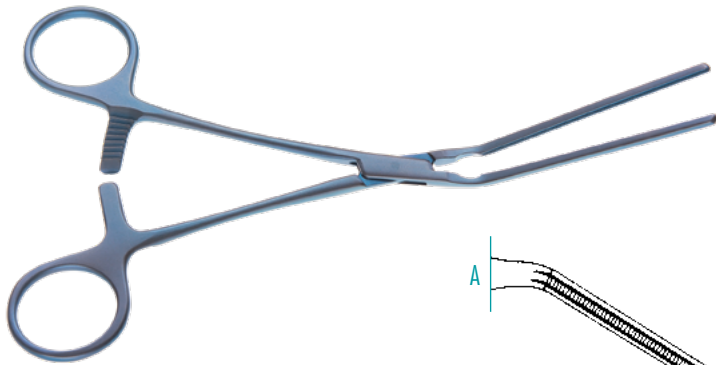

## LELAND JONES

Vascular Clamp

A	190mm, 7 <sup>1</sup> / <sub>2</sub> "	290-731-190
B	200mm, 8"	290-731-200
C	205mm, 8 <sup>1</sup> / <sub>8</sub> "	290-731-210

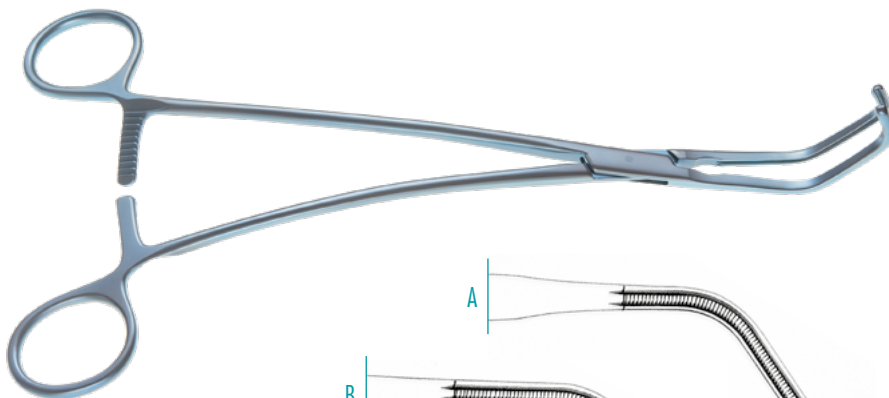
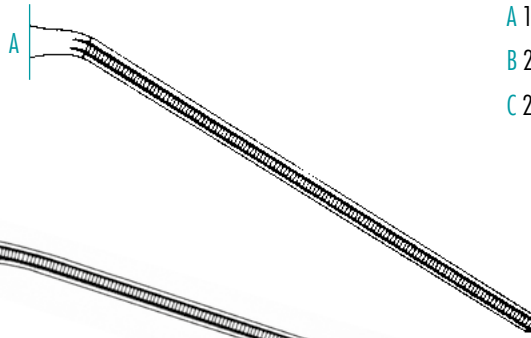

## SATINSKY

Clamp, 250mm, 9<sup>7</sup>/<sub>8</sub>"

A		290-735-001
B		290-735-002
C		290-735-003

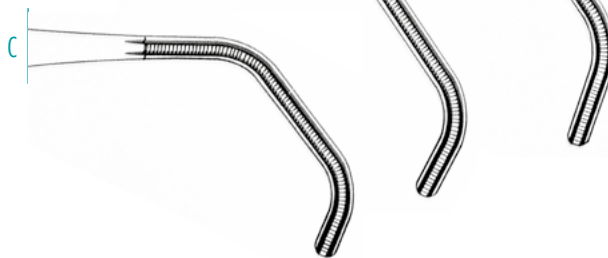
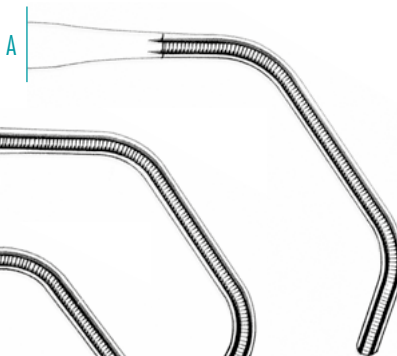

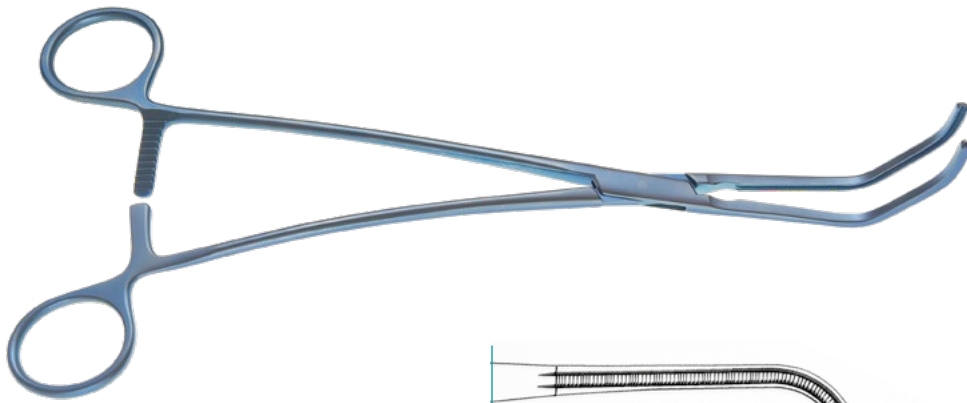

**GLOVER**  
Tangential Clamp

250mm, 9<sup>7</sup>/<sub>8</sub>"

290-735-250

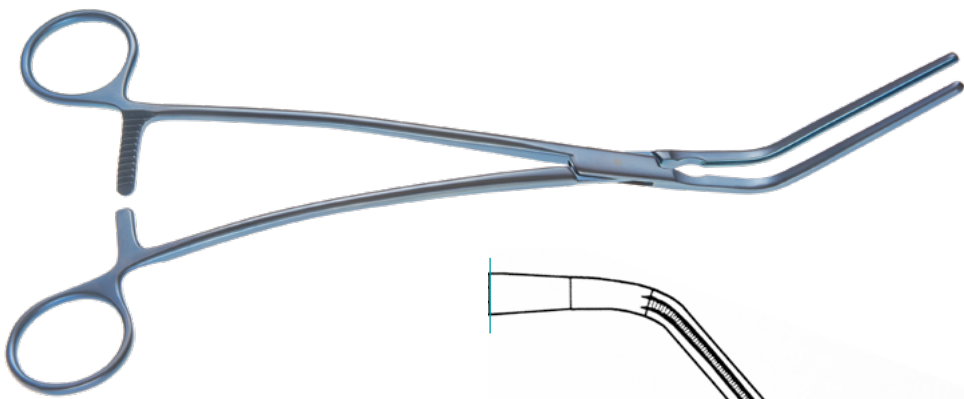
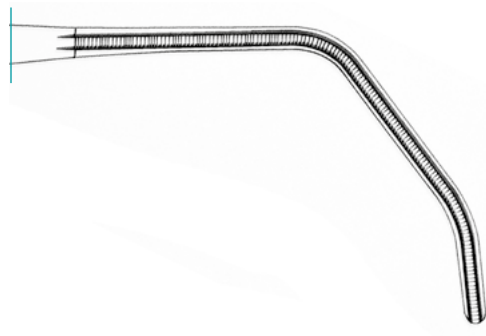

**DEBAKEY**  
Clamp

250mm, 9<sup>7</sup>/<sub>8</sub>"

290-737-260

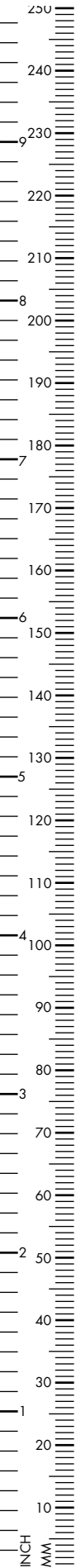
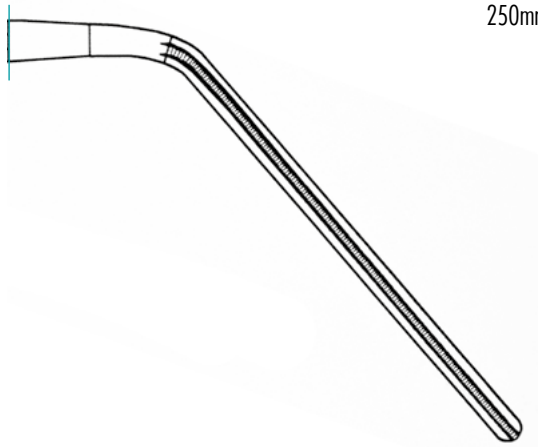

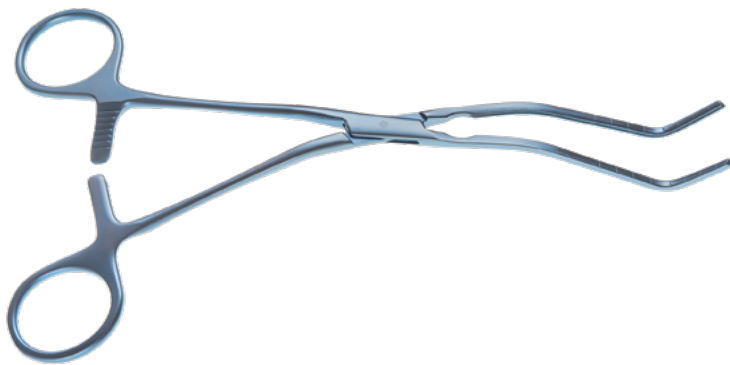

**COOLEY**

Renal Artery Clamp

A	190mm, 7 <sup>1</sup> / <sub>2</sub> "	290-739-190
B	200mm, 8"	290-739-200
C	270mm, 10 <sup>2</sup> / <sub>3</sub> "	290-739-270

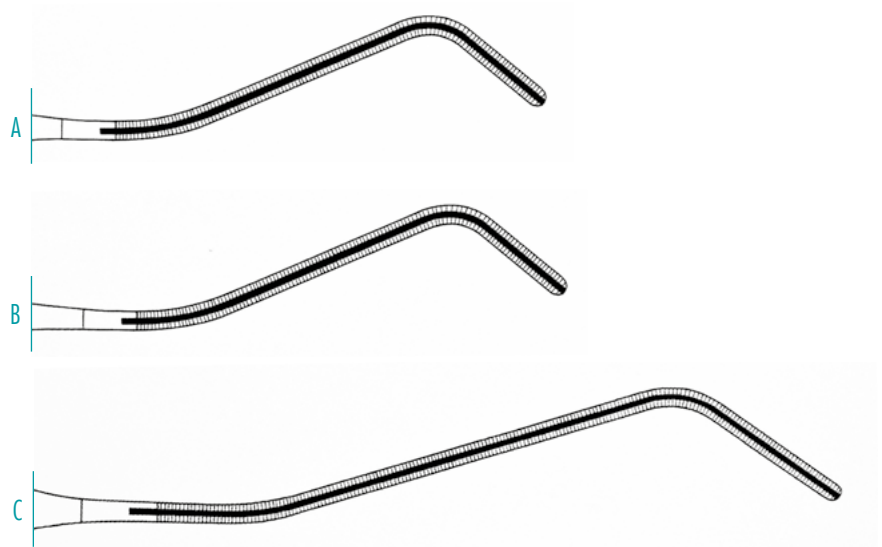

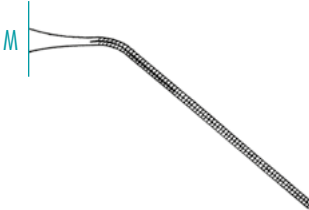
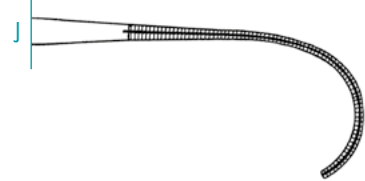
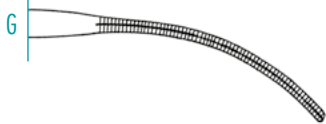
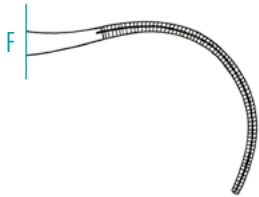
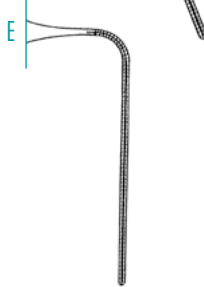
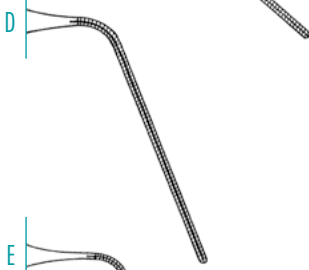
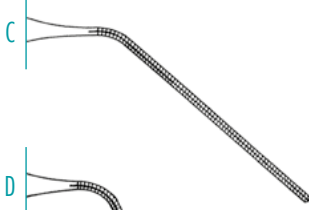
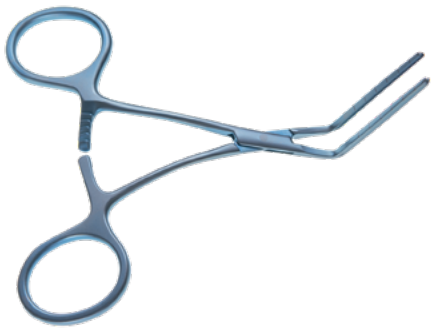

**CASTANEDA**  
Pediatric Clamp

A	130mm, 5 <sup>1</sup> / <sub>8</sub> "	290-732-130
B	130mm, 5 <sup>1</sup> / <sub>8</sub> "	290-734-130
C	130mm, 5 <sup>1</sup> / <sub>8</sub> "	290-735-130
D	120mm, 4 <sup>3</sup> / <sub>4</sub> "	290-734-120
E	110mm, 4 <sup>1</sup> / <sub>3</sub> "	290-732-110
F	120mm, 4 <sup>3</sup> / <sub>4</sub> "	290-793-120
G	130mm, 5 <sup>1</sup> / <sub>8</sub> "	290-794-130
H	150mm, 6"	290-796-150
I	150mm, 6"	290-795-150
J	150mm, 6"	290-797-150
K	160mm, 6 <sup>1</sup> / <sub>4</sub> "	290-798-160
L	160mm, 6 <sup>1</sup> / <sub>4</sub> "	290-799-160
M	150mm, 6"	290-798-150
N	150mm, 6"	290-799-150
O	140mm, 5 <sup>1</sup> / <sub>2</sub> "	290-798-140

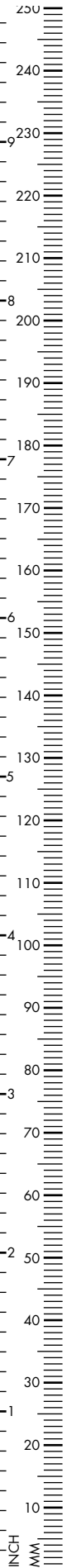
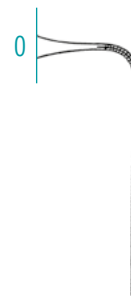
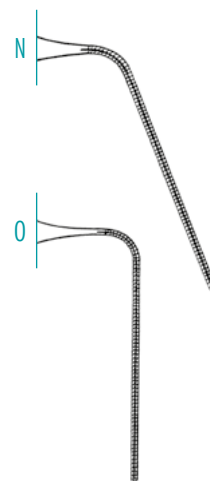

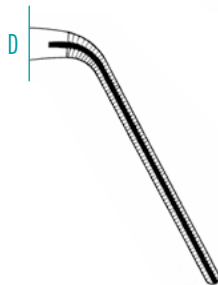
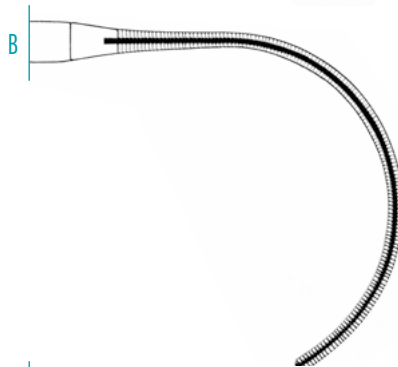
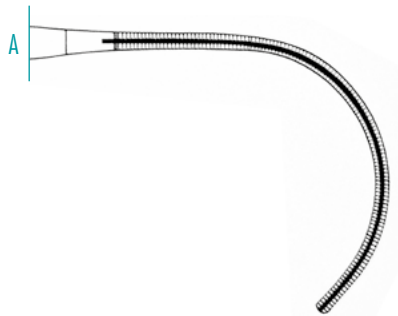
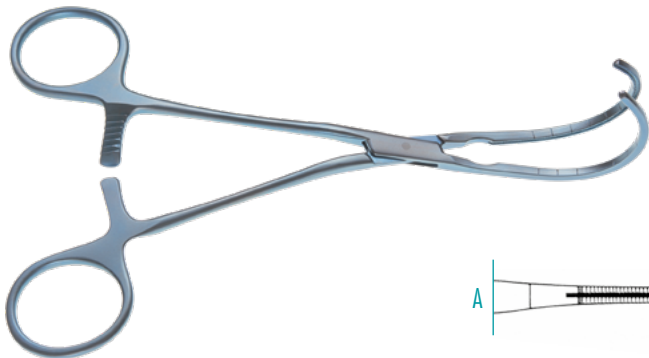

### COOLEY

Pediatric Clamp

A	165mm, 6 <sup>1</sup> / <sub>2</sub> "	290-760-165
B	170mm, 6 <sup>2</sup> / <sub>3</sub> "	290-760-170
C	170mm, 6 <sup>2</sup> / <sub>3</sub> "	290-761-170
D	165mm, 6 <sup>1</sup> / <sub>2</sub> "	290-761-165
E	150mm, 6"	290-761-150

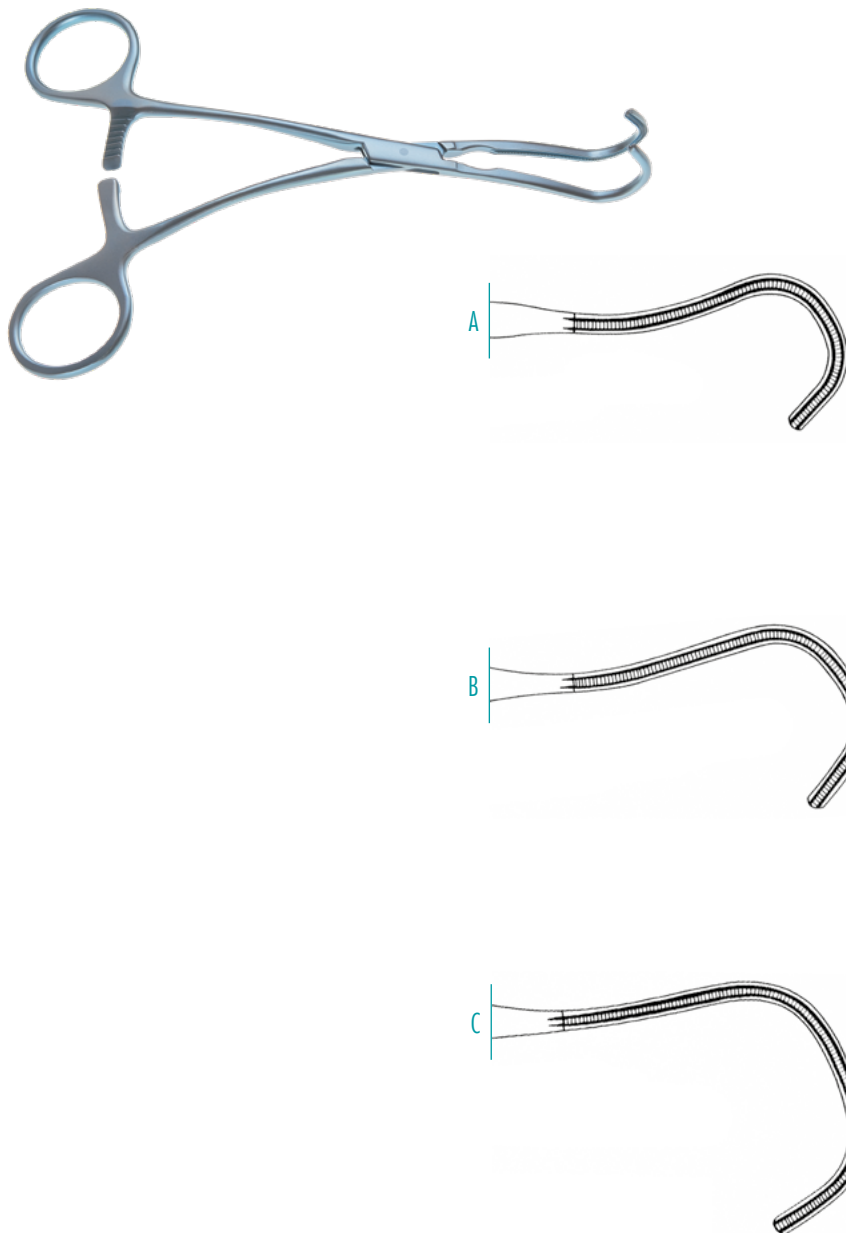

**DERRA**

Anastomosis Pediatric Clamp

A	165mm, 6 <sup>1</sup> / <sub>2</sub> "	290-758-165
B	170mm, 6 <sup>2</sup> / <sub>3</sub> "	290-758-170
C	180mm, 7"	290-759-180



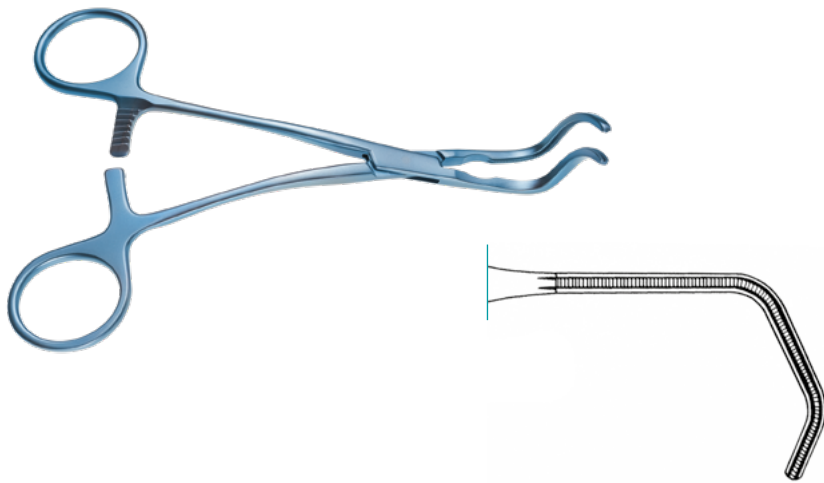

**SUBRAMANIAN**  
Clamp

160mm, 6 <sup>1</sup> / <sub>4</sub> "	290-733-160
--	-------------

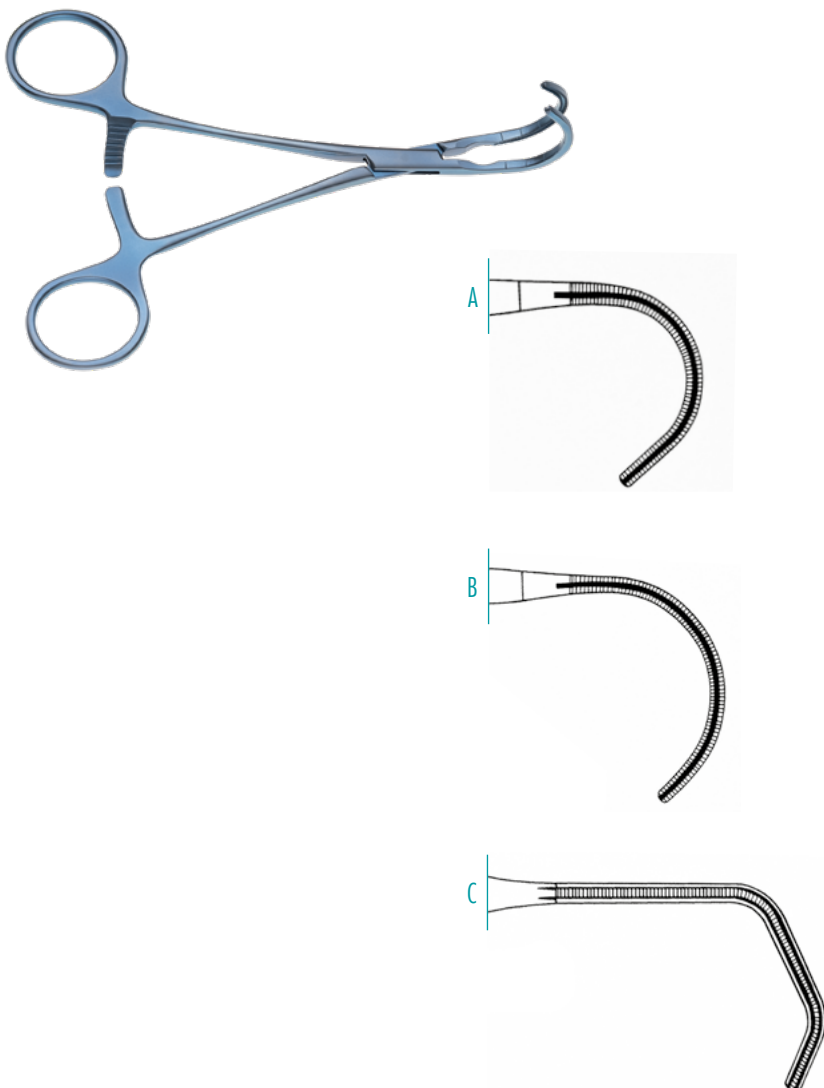

**BECK**

Pediatric Clamp, 150mm, 6"

A small jaw	290-734-150
B large jaw	290-735-150
C 165mm, 6 <sup>1</sup> / <sub>2</sub> "	290-732-165



## COOLEY

Pediatric Clamp

A	170mm, 6 <sup>2</sup> / <sub>3</sub> "	290-762-170
B	180mm, 7"	290-762-180
C	170mm, 6 <sup>2</sup> / <sub>3</sub> "	290-763-170
D	175mm, 6 <sup>7</sup> / <sub>8</sub> "	290-763-175

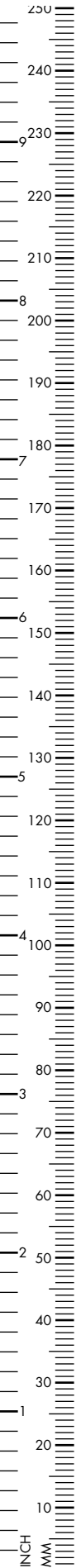
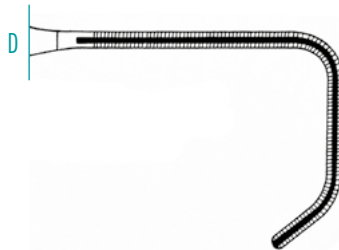
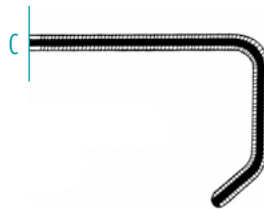
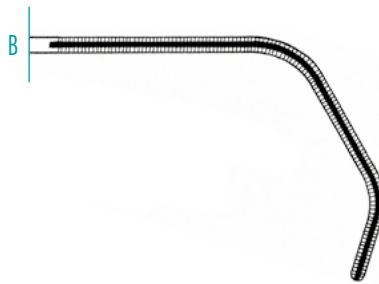
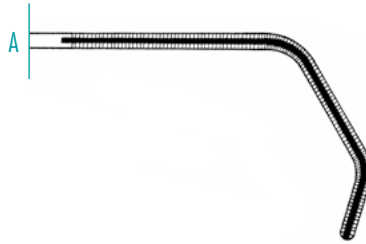
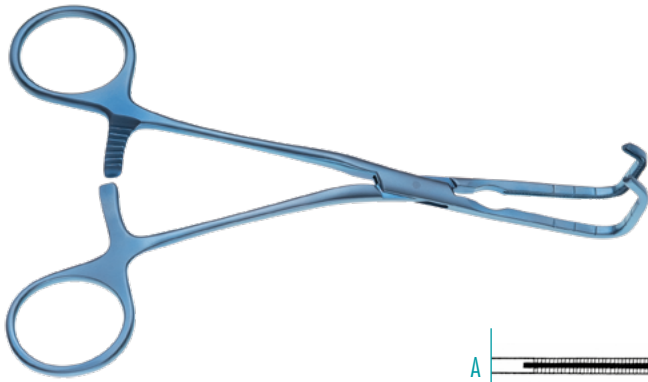

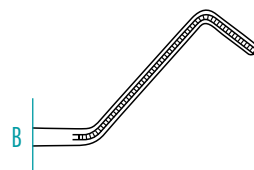
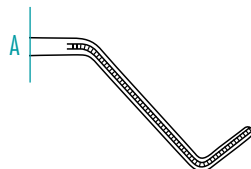
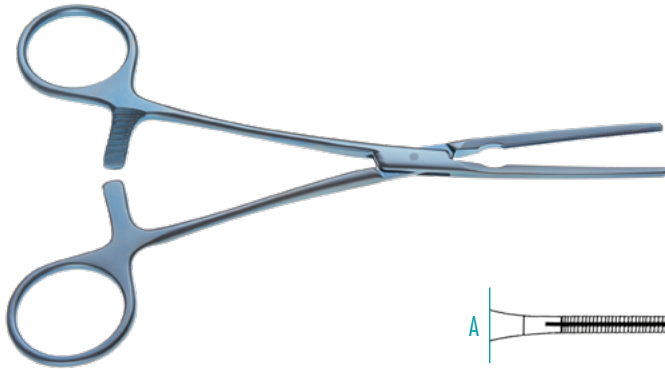

### COOLEY

Pediatric Clamp, straight shanks

A 160mm, 6<sup>1/4</sup>" 290-764-160

angled shanks

A 160mm, 6<sup>1/4</sup>" 290-765-160

straight shanks

B 170mm, 6<sup>2/3</sup>" 290-764-170

straight shanks

B 170mm, 6<sup>2/3</sup>" 290-765-170

straight shanks, curved jaw

C 170mm, 6<sup>2/3</sup>" 290-766-170

straight shanks, spoon-shaped jaw

D 170mm, 6<sup>2/3</sup>" 290-767-170

### KITZMILLER

Pediatric Clamp, 110mm, 4<sup>1/3</sup>"

A left angled 290-723-110

B right angled 290-725-110

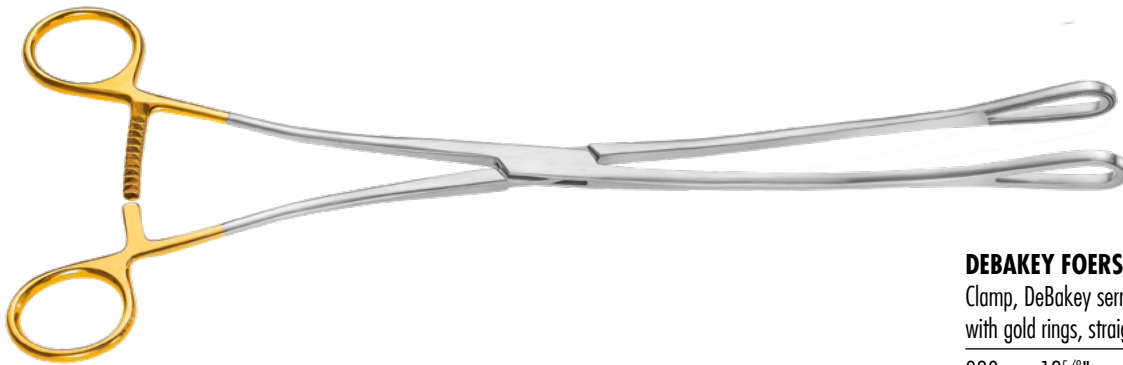

**DEBAKEY FOERSTER**

Clamp, DeBakey serrations,  
with gold rings, straight

320mm, 12<sup>5/8</sup>"

290-000-320

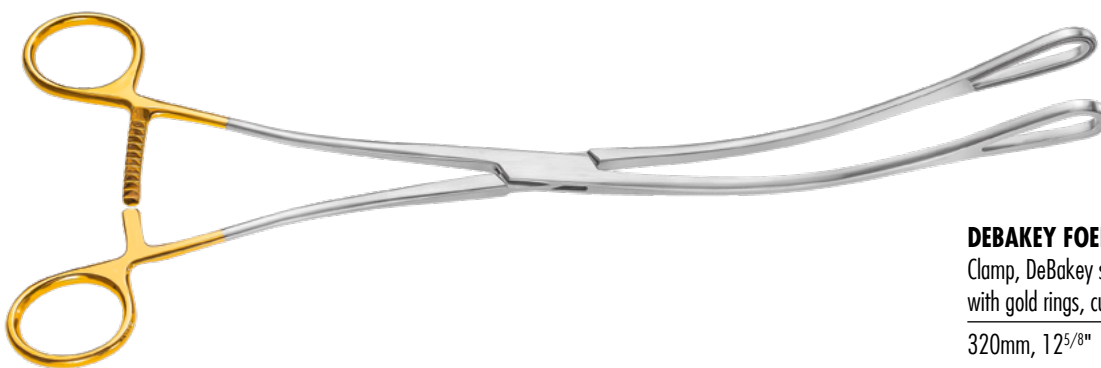

**DEBAKEY FOERSTER**

Clamp, DeBakey serrations,  
with gold rings, curved

320mm, 12<sup>5/8</sup>"

290-000-321

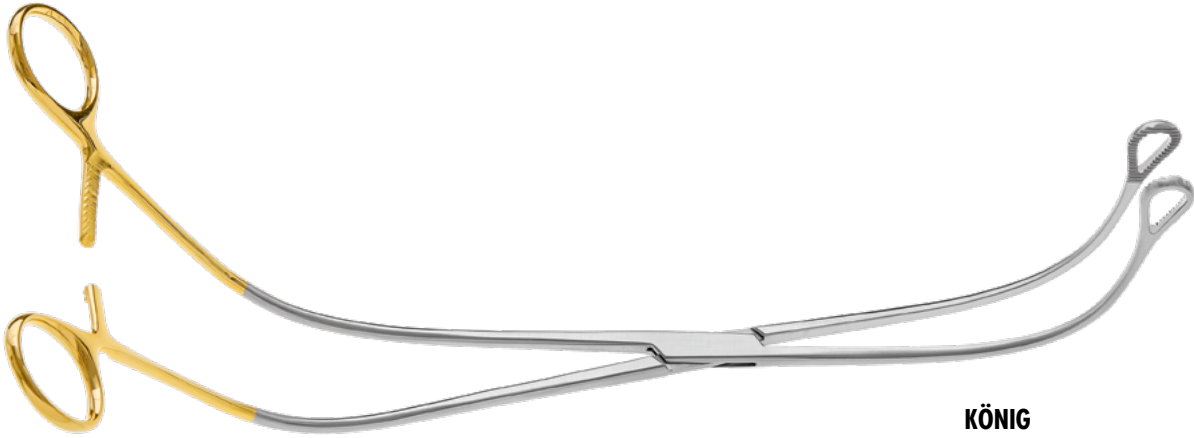
**KÖNIG**

Ring forceps for thoracic surgery

310mm, 12<sup>1</sup>/<sub>4</sub>"

290-000-315

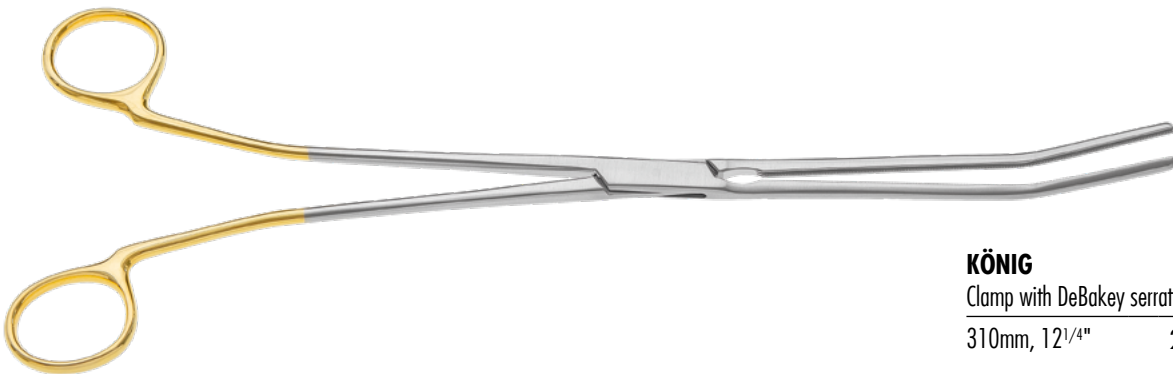
**KÖNIG**

Clamp with DeBakey serration

310mm, 12<sup>1</sup>/<sub>4</sub>"

290-000-310

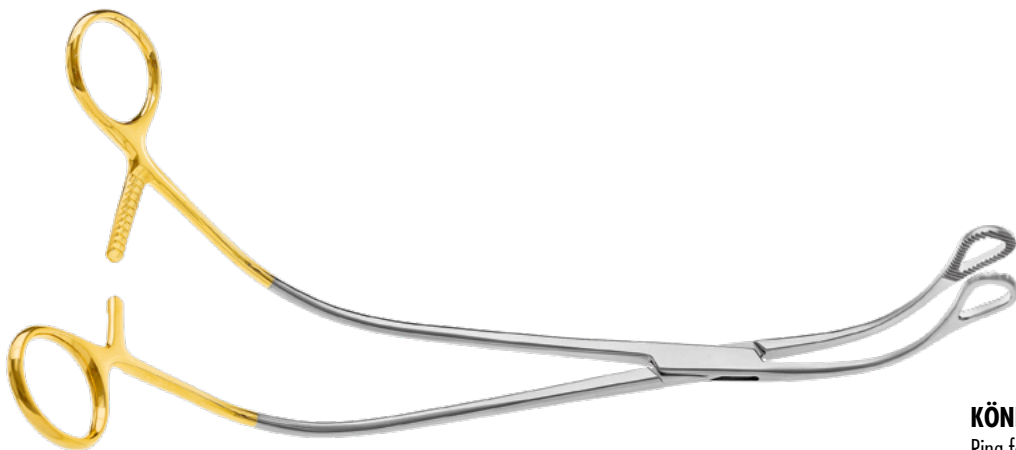

**KÖNIG**

Ring forceps for thoracic surgery

255mm, 10"

290-000-255



**KÖNIG**

T-Clamp with DeBaKey serration

305mm, 12"

290-000-305

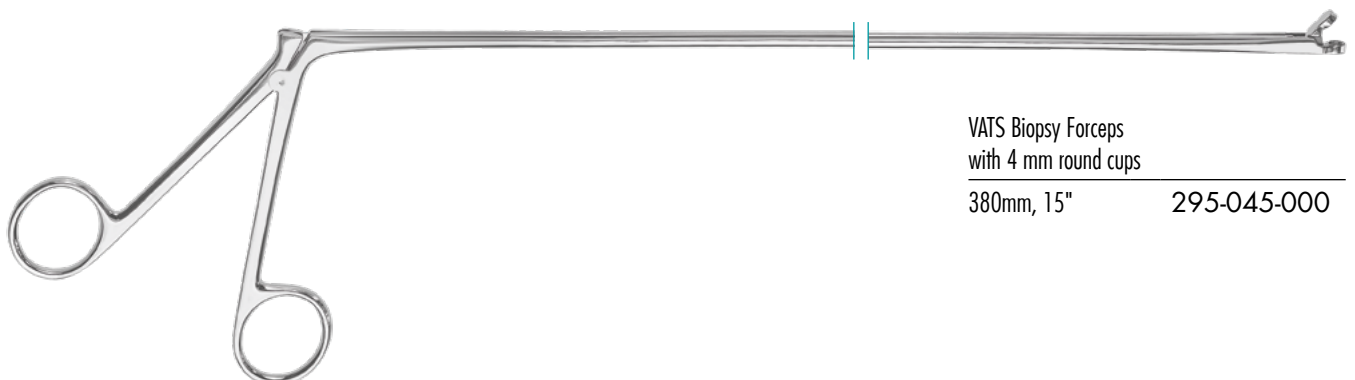

VATS Biopsy Forceps  
with 4 mm round cups

380mm, 15"

295-045-000



Chest Tube Passer, Ø 10mm shaft,  
160mm working length, without ratchet

250mm, 9 <sup>7/8</sup> "	295-080-150
280mm, 11"	295-080-280

155mm working length, with ratchet

240mm, 9 <sup>1/2</sup> "	295-080-170
---------------------------	-------------

280mm working length, with ratchet

355mm, 14"	295-080-281
------------	-------------



### FOERSTER

left curved, oval shape,  
Ø 7mm shaft, 230mm working length

335mm, 13 <sup>1/4</sup> "	295-150-012
----------------------------	-------------

Ø 10mm shaft, 240mm working length

340mm, 13 <sup>1/3</sup> "	295-150-020
----------------------------	-------------



### DUVAL

left curved, triangular shape, 10mm jaw width  
Ø 10mm shaft, 230mm working length

330mm, 13"	295-310-001
------------	-------------

25mm jaw width  
235mm working length

330mm, 13"	295-310-002
------------	-------------



Dissecting Forceps, left curved,  
Ø 7mm shaft, 230mm working length

340mm, 13 <sup>1/3</sup> "	295-100-230
----------------------------	-------------

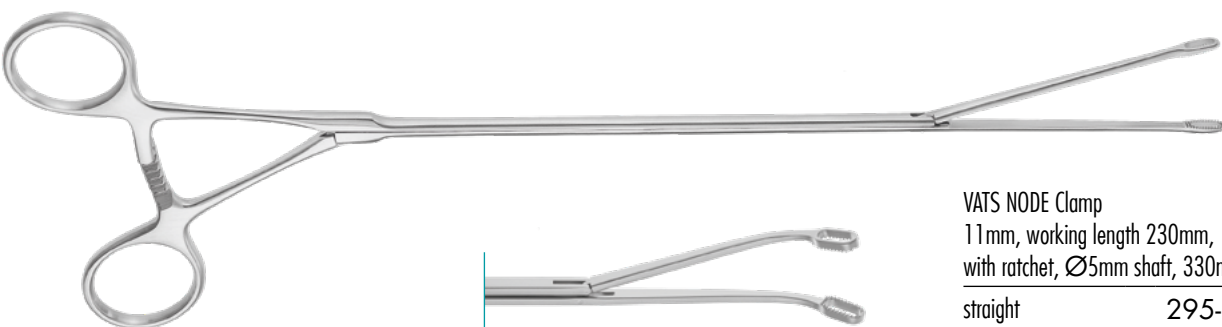

VATS NODE Clamp  
11mm, working length 230mm,  
with ratchet, Ø5mm shaft, 330mm, 13"

straight	295-150-222
----------	-------------

left curved	295-150-223
-------------	-------------



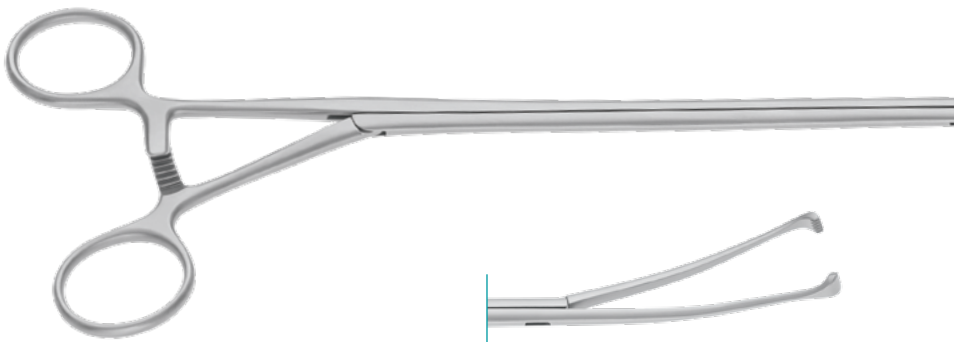

### ALLIS

left curved, 6mm jaw width  
 Ø 7mm shaft, 240mm working length

330mm, 13" 295-310-100



### DEBAKEY

1x2 teeth, Ø 10mm shaft,  
 65mm jaw length, 230mm working length

330mm, 13" 295-290-065

75mm jaw length, 250mm working length

340mm, 13<sup>1</sup>/<sub>3</sub>" 295-290-075

100mm jaw length, 255mm working length

360mm, 14<sup>1</sup>/<sub>4</sub>" 295-290-100



2x3 teeth,  
 100mm jaw length, 250mm working length

350mm, 14" 295-290-101



### COOLEY

1x2 teeth, Ø 10mm shaft,  
 240mm working length, 345mm, 13<sup>1</sup>/<sub>2</sub>"

with ratchet 295-290-300

without ratchet 295-290-301

Fig.1



### HARKEN

1x2 teeth, Ø 10mm shaft, without ratchet,  
 250mm working length, Fig. 1

355mm, 14" 295-290-001

270mm working length, without ratchet, Fig. 2

370mm, 14<sup>1</sup>/<sub>2</sub>" 295-290-002

Fig.2



1x2 teeth, Ø 10mm shaft, with ratchet  
 250mm working length, Fig. 1

355mm, 14" 295-290-010

270mm working length, with ratchet, Fig. 2

370mm, 14<sup>1</sup>/<sub>2</sub>" 295-290-012

### D'AMICO

Ø 10mm shaft, 110mm jaw length  
 270mm working length, 370mm, 14<sup>1</sup>/<sub>2</sub>"

straight 295-290-200

curved 295-290-201





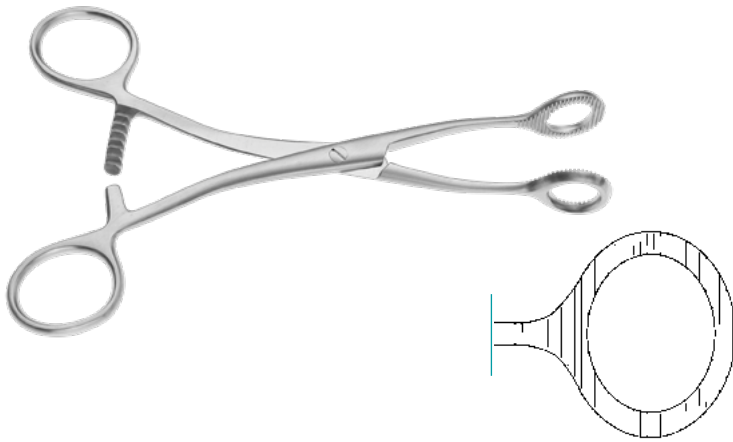

### **COLLIN**

Hemostatic Forceps

160mm, 6<sup>1</sup>/<sub>4</sub>"

140-236-160

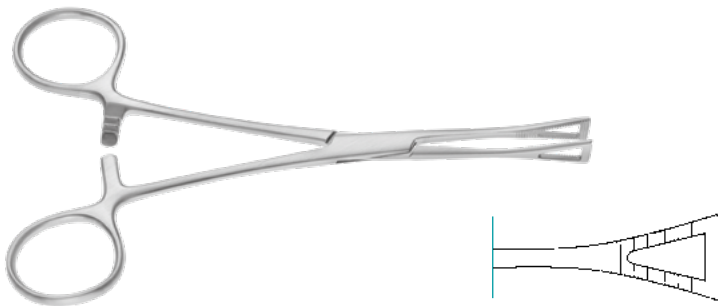

### **PENNINGTON**

Tissue Holding Forceps

155mm, 6<sup>1</sup>/<sub>8</sub>"

140-240-155

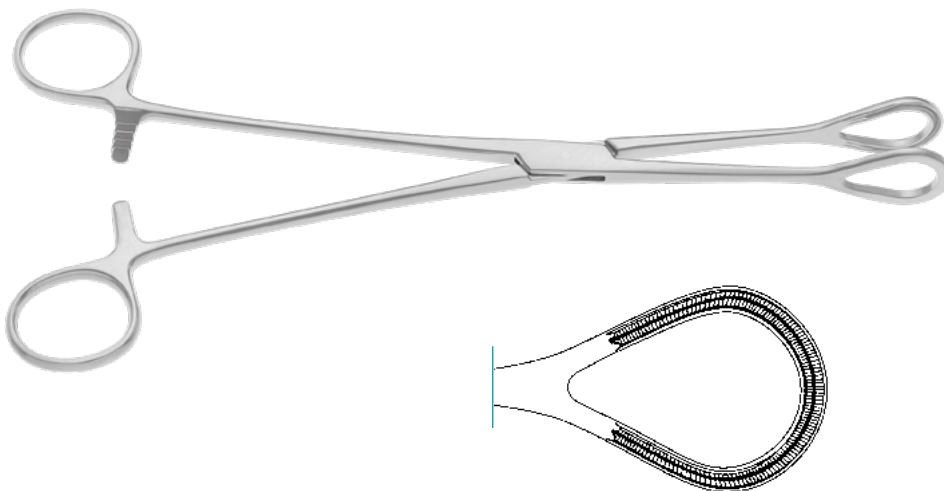

### **DEBAKEY**

Intestinal and Organ Grasping Forceps,  
atraumatic serrations, small ring

260mm, 10<sup>1</sup>/<sub>4</sub>"

140-220-260

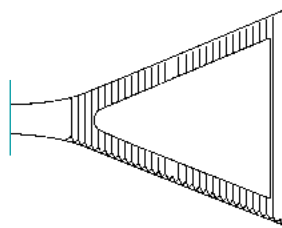
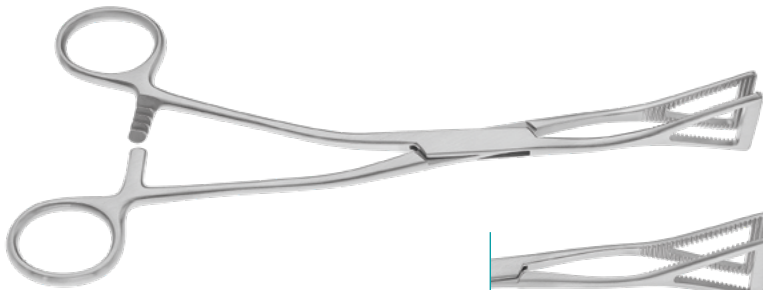

### LOVELACE

Lung Grasping Forceps, 200mm, 8"

straight 290-286-200

curved 290-287-200

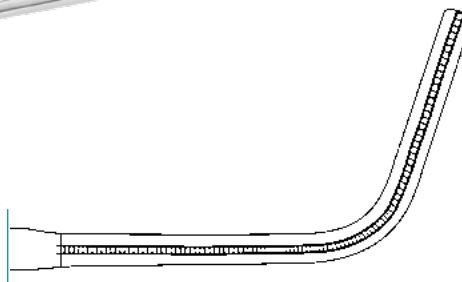

### DEBAKEY MIXTER

Thoracic Forceps, strong serration

280mm, 11" 290-600-230

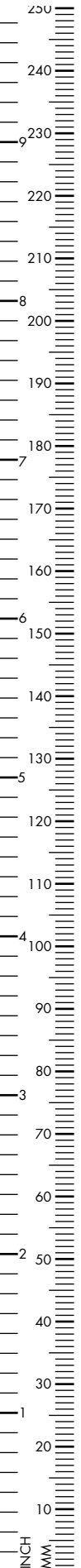

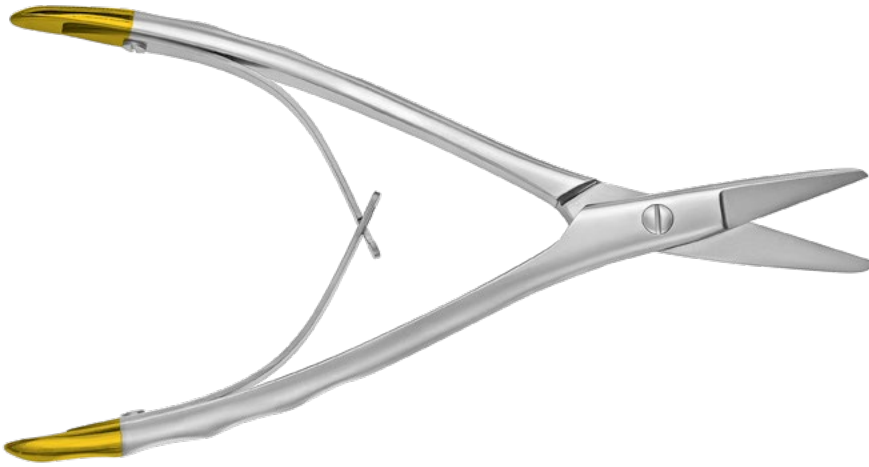

Rib Shears	
230mm, 9"	290-100-230



Rib Shears	
220mm, 8 <sup>2</sup> / <sub>3</sub> "	290-101-220



<b>GLUCK</b>	
Bone / Rib Shears	
220mm, 8 <sup>2</sup> / <sub>3</sub> "	290-107-220



**BETHUNE**

Rib Shears

345mm, 13<sup>5</sup>/<sub>8</sub>"

290-126-340

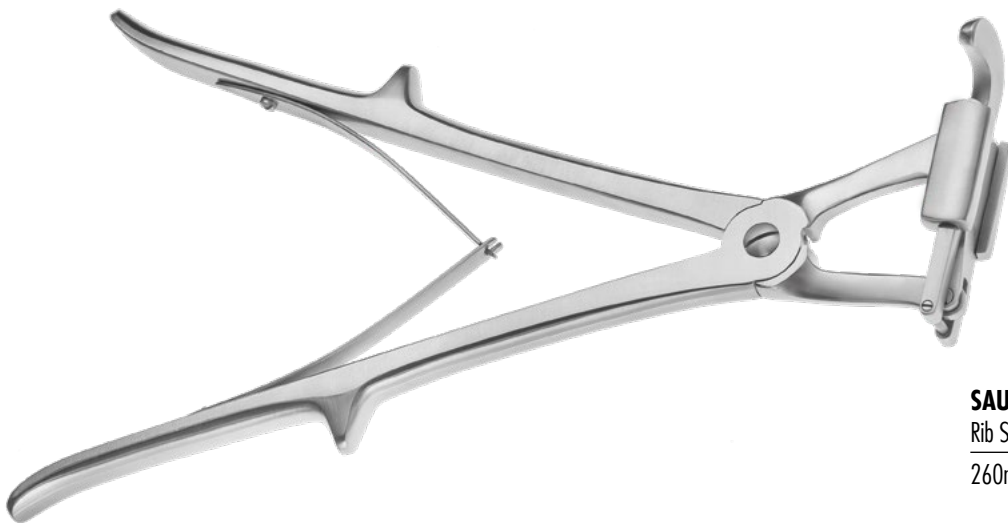

**SAUERBRUCH**

Rib Shears

260mm, 10<sup>1</sup>/<sub>4</sub>"

290-131-260



**GIERTZ STILLE**

Rib Shears, double action

250mm, 9<sup>7</sup>/<sub>8</sub>"

290-137-270

INCH  
MM

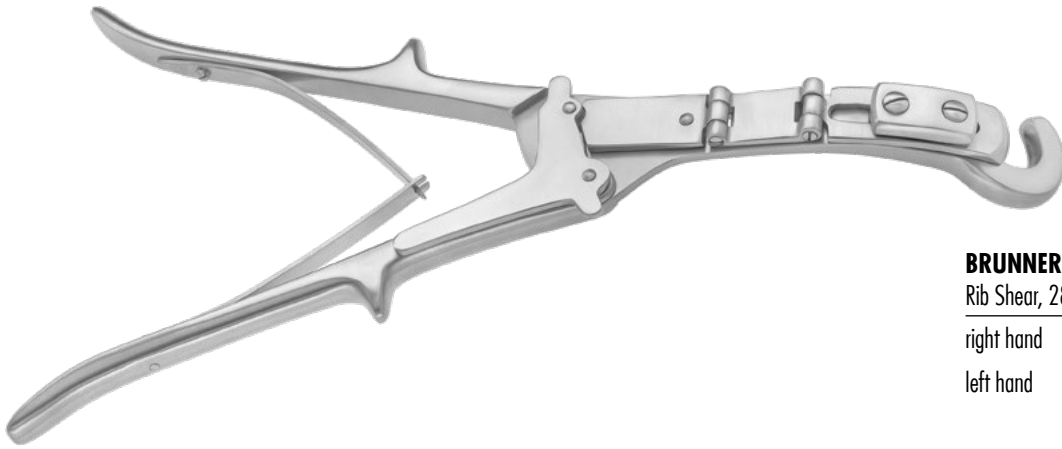

**BRUNNER**

Rib Shear, 280mm, 11"

right hand	290-147-280
left hand	290-149-280



**VEHMEHREN (TUDOR EDWARDS)**

Costotome

240mm, 9 <sup>1/2</sup> "	290-110-240
---------------------------	-------------



**SWEET**

Sternum Punch

230mm, 9"	290-158-245
-----------	-------------

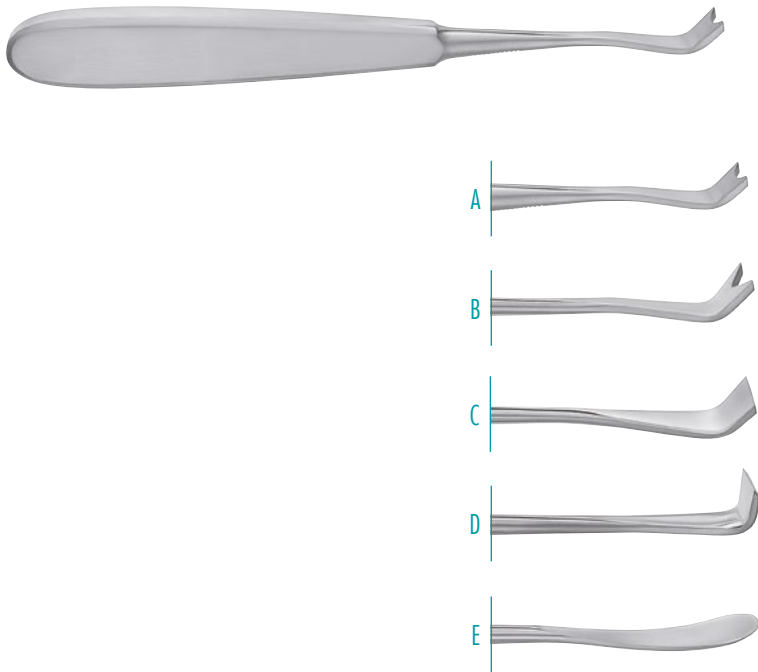

### SEMB

Raspatory, hollow handle, 190mm, 7<sup>1</sup>/<sub>2</sub>"

A 12mm 210-450-001

230mm, 9"

B 12mm 210-450-002

C 13mm 210-450-003

D 13mm 210-450-004

E 15mm 210-450-005

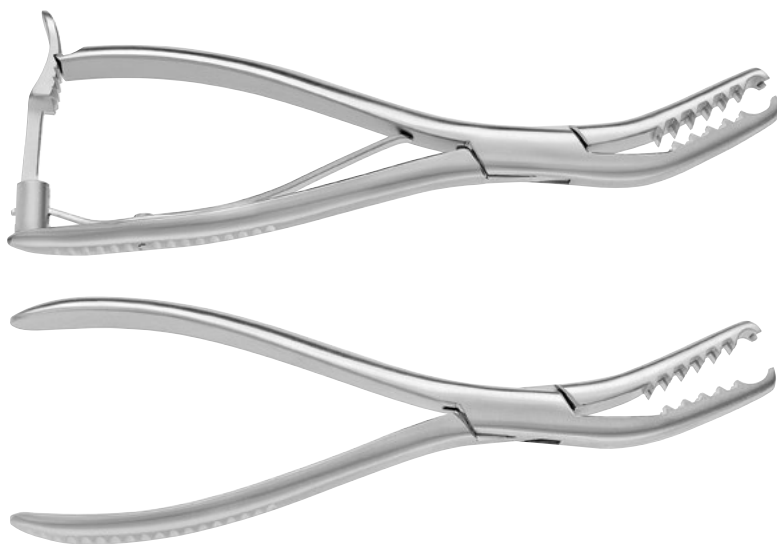

### SEMB

Bone Holding Forceps, laterally curved  
with ratchet

190mm, 7<sup>1</sup>/<sub>2</sub>" 210-624-190

without ratchet

190mm, 7<sup>1</sup>/<sub>2</sub>" 210-623-190



**LEBSCHE**

Sternum Chisel

245mm, 9<sup>2</sup>/<sub>3</sub>"

290-151-240

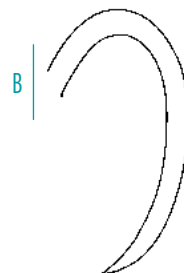

**DOYEN**

Rib Raspatory, 175mm, 6<sup>7</sup>/<sub>8</sub>"

A right, adults

210-331-170

B left, adults

210-333-170

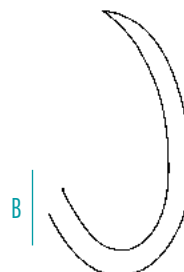

**DOYEN**

Rib Raspatory, 175mm, 6<sup>7</sup>/<sub>8</sub>"

A right, children

210-335-170

B left, children

210-337-170

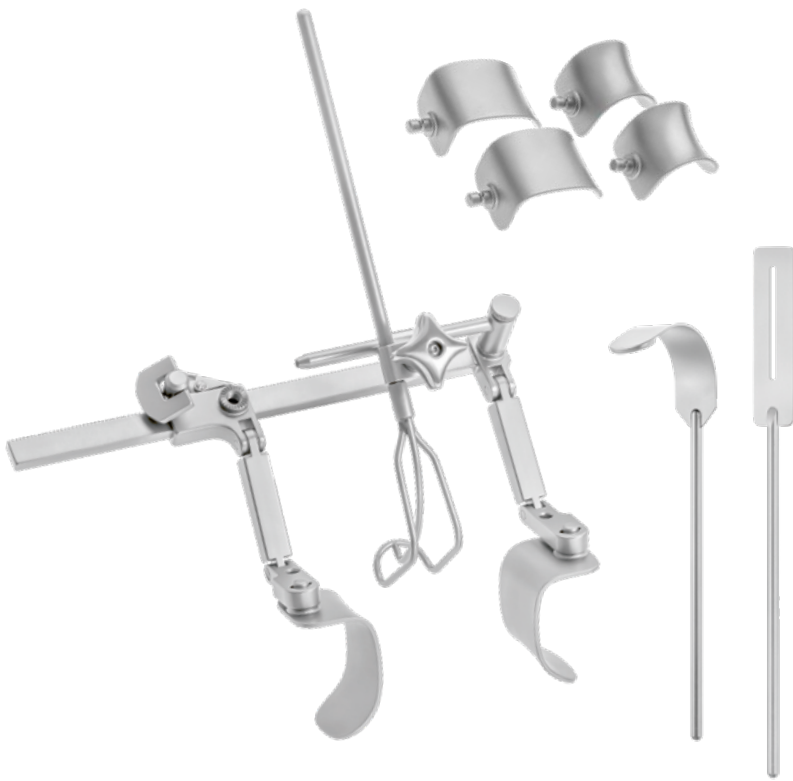

Mini Thoracotomy Retractor,  
double hinge, set with 2 blades pairs  
36 x 55 / 36 x 40mm, detachable crossbar

290-156-000

Blade Pair

40 x 70mm 290-156-001

Blades, 280mm length

95 x 18mm 290-156-004

95 x 22mm 290-156-005



Mini Thoracotomy Retractor

36 x 45mm blades 290-155-045

36 x 60mm blades 290-155-060

36 x 80mm blades 290-155-080

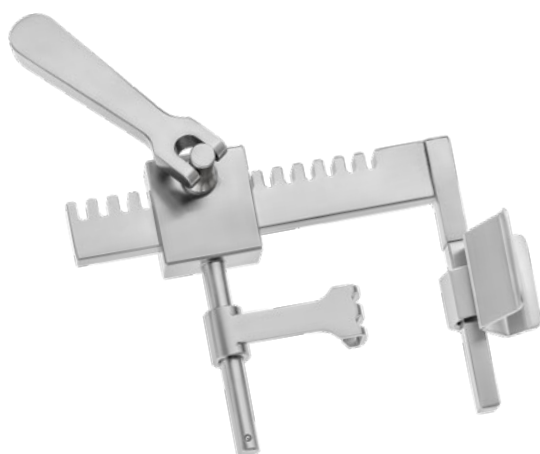

IMA Mini-Sternotomy Retractor,  
complete with U-Blade 38mm, 2x french hooks

120mm, 4<sup>3/4</sup>" 290-184-030

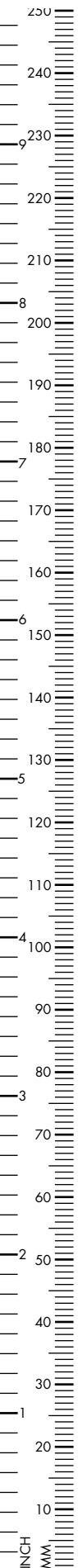





### FINOCHIETTO

Micro Neonatal Rib Spreader

27 x 12 x 10mm (length/width/depth)

35mm spread 290-177-035



### FINOCHIETTO BABY

Rib Spreader, straight arms

51 x 15 x 13mm (length/width/depth)

55mm spread 290-177-055

51 x 15 x 13mm (length/width/depth)

75mm spread 290-177-070

60 x 21 x 18mm (length/width/depth)

80mm spread 290-177-075



### FINOCHIETTO BABY

Rib Spreader, curved arms

60 x 21 x 18mm (length/width/depth)

80mm spread 290-179-075

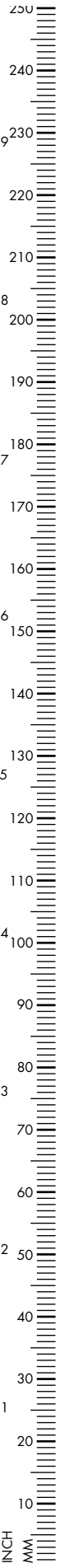

### FINOCHIETTO BABY

Rib Spreader, with contractor  
68 x 21 x 19mm (length/width/depth)

80mm spread 290-178-075



### HAIGHT FINOCHIETTO BABY

Rib Spreader, Aluminium  
76 x 31 x 31mm (length/width/depth)

98mm spread 290-161-002



### HAIGHT

Rib Spreader, small  
64 x 31 x 32mm (length/width/depth)

126mm spread 290-168-060

large  
90 x 31 x 32mm (length/width/depth)

126mm spread 290-168-090



### BAILEY FINOCHIETTO

Rib Spreader, Aluminium

58 x 14 x 12mm (length/width/depth)

74mm spread 290-179-000

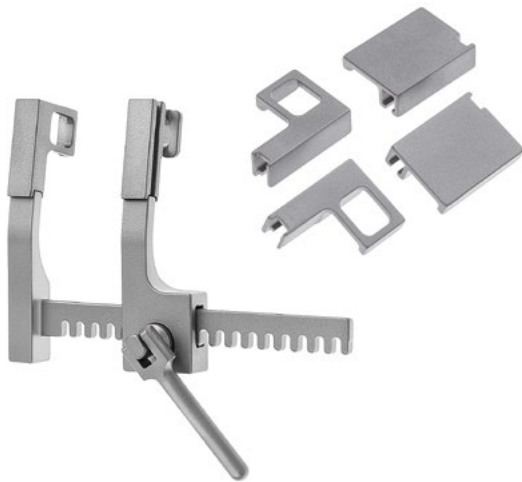

Mini Thorax Spreader, Titanium,

40mm length

39mm spread 290-187-000

Spare Valves, paired

20 x 15mm (width/depth)

290-187-001

Spare Valves, paired

10 x 15mm (width/depth)

290-187-002



### MORSE

Rib Spreader, small, black coated,  
movable valves

56 x 40 x 12mm (length/width/depth)

65mm spread 290-300-255



### CASTANEDA

Rib Spreader, Aluminium

60 x 34 x 11mm (length/width/depth)

74mm spread 290-166-001

80 x 45 x 13mm (length/width/depth)

80mm spread 290-166-002

126 x 60 x 17.5mm (length/width/depth)

110mm spread 290-166-003



### COOLEY CLARKE

Rib Spreader, Infants

70 x 15 x 10mm (length/width/depth)

65mm spread 290-160-010

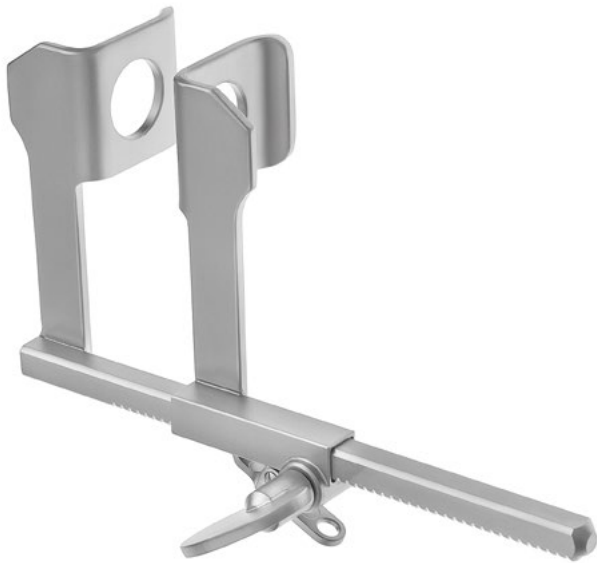

### HAIGHT BABY

Rib Spreader

73 x 35 x 31.5mm (length/width/depth)

90mm spread 290-168-050



### COOLEY

Rib Spreader, Aluminium, Children, with points  
77 x 20.5 x 17mm (length/width/depth)

97mm spread 290-160-000



### COOLEY

Rib Spreader, Aluminium, Children  
58 x 17 x 11mm (length/width/depth)

74mm spread 290-160-001

80 x 30 x 17mm (length/width/depth)

101mm spread 290-160-002



### ANKENEY

Rib Spreader, Aluminium, 4 fixed swivel valves  
114 x 19 x 23mm (length/width/depth)

139mm spread      290-177-000



### RIENHOFF

Rib Spreader  
116 x 33 x 30mm (length/width/depth)

140mm spread      290-169-000

146 x 45 x 47mm (length/width/depth)

140mm spread      290-169-010



### **BADGLEY**

Rib Spreader, 4 prongs

108 x 45 x 50mm (length/width/depth)

165mm spread      170-905-000



### **FINOCHIETTO**

Rib Spreader, curved arms, circular fenestration

111 x 32 x 28mm (length/width/depth)

150mm spread      290-181-180



### MORSE

Rib Spreader, Children, movable valves

125 x 22 x 15mm (length/width/depth)

154mm spread 290-300-300

148 x 29 x 23mm (length/width/depth)

212mm spread 290-300-400



### DEBAKEY

Rib Spreader, Children, incl. 3 paired valves

144mm length

152mm spread 290-180-001

Spare Valves

30 x 30mm (width/depth)

290-180-030

40 x 40mm (width/depth)

290-180-040

50 x 50mm (width/depth)

290-180-050





### TUFFIER

Rib Spreader, toothed valves  
180 x 45 x 48mm (length/width/depth)

178mm spread 290-174-000

serrated valves

180 x 45 x 48mm (length/width/depth)

178mm spread 290-174-010



### COOLEY

Rib Spreader,  
112 x 46 x 25mm (length/width/depth)

137mm spread 290-160-003

140 x 52 x 34mm (length/width/depth)

170mm spread 290-160-004

158 x 102 x 29mm (length/width/depth)

194mm spread 290-160-005



### BURFORD

Rib Spreader, Children, incl. 4 paired valves  
108mm length

157mm spread 290-181-020

Spare Valves  
44 x 47mm (width/depth)

290-181-021

45 x 31mm (width/depth)

290-181-022

33 x 30mm (width/depth)

290-181-023

23 x 22mm (width/depth)

290-181-024



### BURFORD-FINOCHIETTO

Rib Spreader, Aluminium, incl. 2 paired valves  
113mm length

135mm spread 290-164-000

Spare Valves, paired  
42 x 34mm (width/depth)

290-165-102

42 x 48mm (width/depth)

290-165-103

### DUBOST

Rib Spreader, incl. 3 paired valves  
140mm length

160mm spread	290-186-010
--------------	-------------

Spare Valves, paired  
100 x 30mm (width/depth)

290-186-011
-------------

100 x 40mm (width/depth)

290-186-012
-------------

100 x 50mm (width/depth)

290-186-013
-------------

### DUBOST

Rib Spreader, incl. 3 pair valves,  
fixation and Mammary valve  
140mm length

160mm spread	290-186-000
--------------	-------------

Spare Valves, paired  
100 x 30mm (width/depth)

290-186-011
-------------

Spare Valves, paired  
100 x 40mm (width/depth)

290-186-012
-------------

Spare Valves, paired  
100 x 50mm (width/depth)

290-186-013
-------------



### DEBAKEY

Rib Spreader, incl. 3 paired valves  
153mm length

192mm spread 290-185-220

Spare Valves, paired  
30 x 30mm (width/depth)

290-185-030

40 x 40mm (width/depth)

290-185-040

50 x 50mm (width/depth)

290-185-050

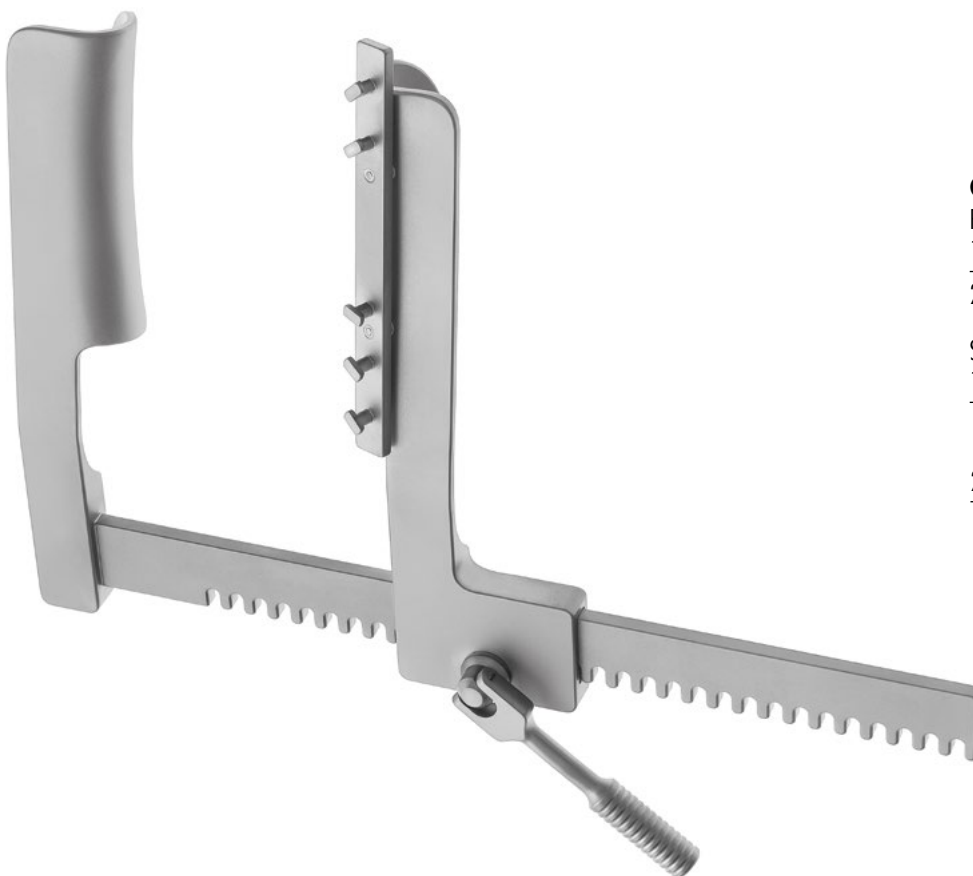

### CARPENTIER

Rib Spreader, incl. 2 paired sternal valves  
165 x 100 x 36mm (length/width/depth)

200mm spread 290-188-000

Spare Valves, paired  
15 x 25mm (width/depth)

290-188-001

25 x 25mm (width/depth)

290-188-002



### FINOCHIETTO

Rib Spreader, curved arms

130 x 45 x 40mm (length/width/depth)

148mm spread 290-178-165

180 x 65 x 50mm (length/width/depth)

200mm spread 290-178-200

180 x 65 x 70mm (length/width/depth)

250mm spread 290-178-250

180 x 65 x 50mm (length/width/depth)

265mm spread 290-179-255

180 x 65 x 50mm (length/width/depth)

310mm spread 290-179-310



straight arms

### FINOCHIETTO

Rib Spreader, straight arms

186 x 66 x 51mm (length/width/depth)

200mm spread 290-177-200

265mm spread 290-177-255

310mm spread 290-177-310

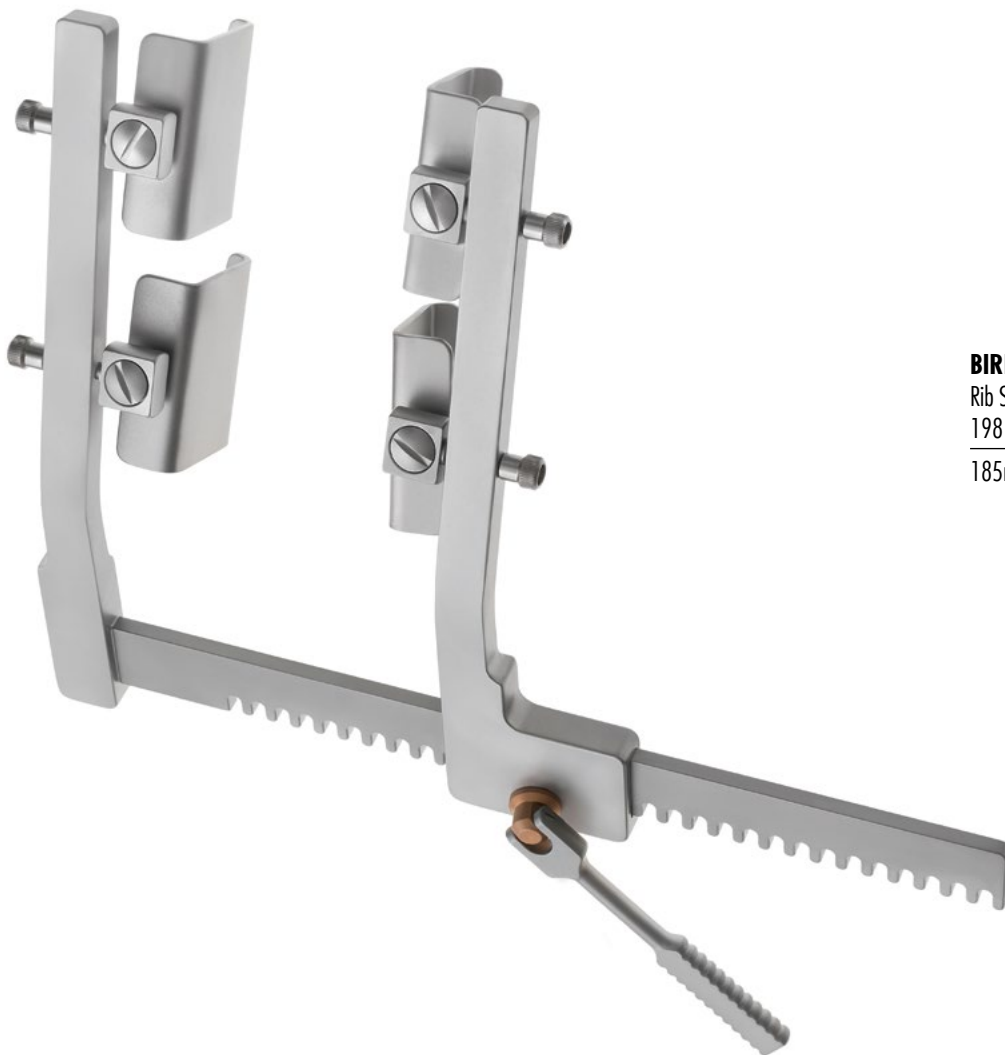

**BIRNBAUM**

Rib Spreader, movable blades

198 x 60 x 40mm (length/width/depth)

185mm spread

290-189-000



### IMA FRENCH

Rib Spreader, incl. 3 paired valves  
150mm length

---

290-184-020

Spare Valves, paired  
50 x 22mm (width/depth)

---

290-184-021

40 x 22mm (width/depth)

---

290-184-022

100mm width

---

290-184-023



### DEBAKEY

Rib Spreader, incl. 3 paired valves  
170mm length

240mm spread 290-185-285

Spare Valves, paired  
60 x 60mm (width/depth)

290-181-060

80 x 50mm (width/depth)

290-181-050

100 x 40mm (width/depth)

290-181-040





### **FAVALORO MORSE**

Rib Spreader, movable valves

205 x 29 x 38mm (length/width/depth)

212mm spread      290-310-000

### **PACIFICO MORSE**

Rib Spreader, with 2 pair valves

148 x 29 x 23mm (length/width/depth)

170mm spread      290-300-150

Spare Valves

29 x 34mm (width/depth)

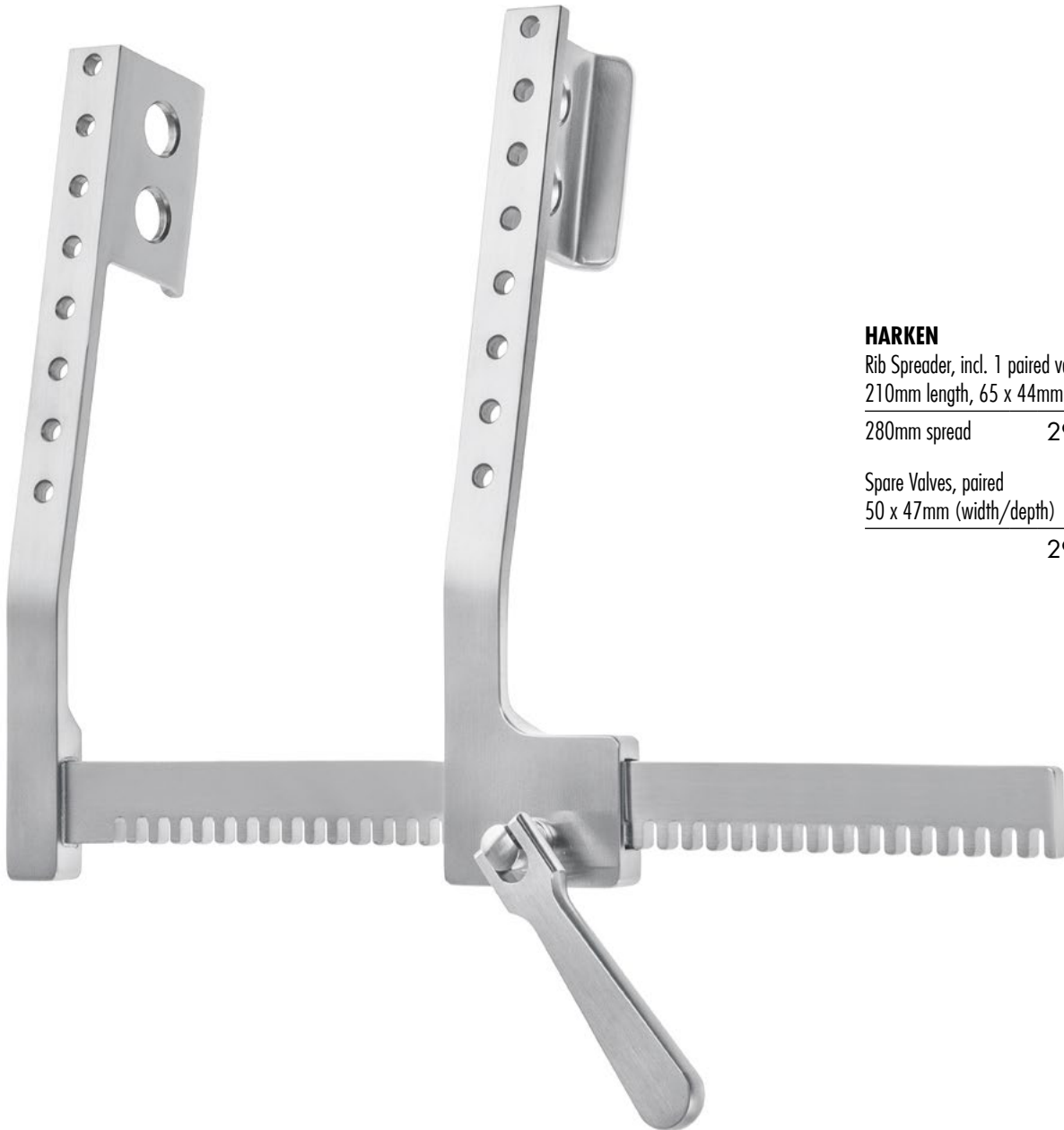

### HARKEN

Rib Spreader, incl. 1 paired valves  
210mm length, 65 x 44mm

280mm spread	290-183-000
--------------	-------------

Spare Valves, paired  
50 x 47mm (width/depth)

	290-183-001
--	-------------

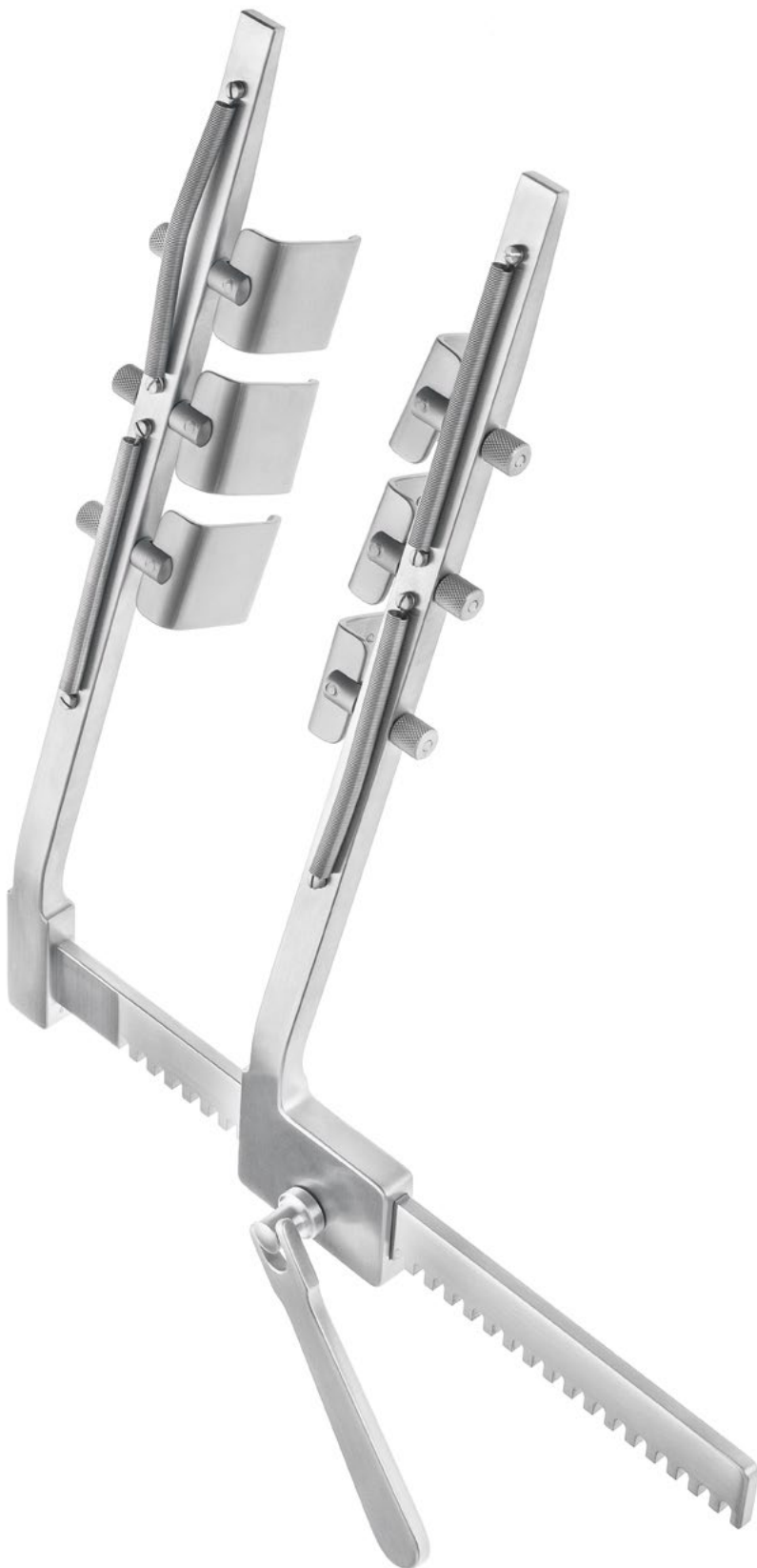
**ANKENEY**

Rib Spreader, Adult, 6 fixed swivel valves  
289 x 35 x 35mm (length/width/depth)

195mm spread

290-178-000

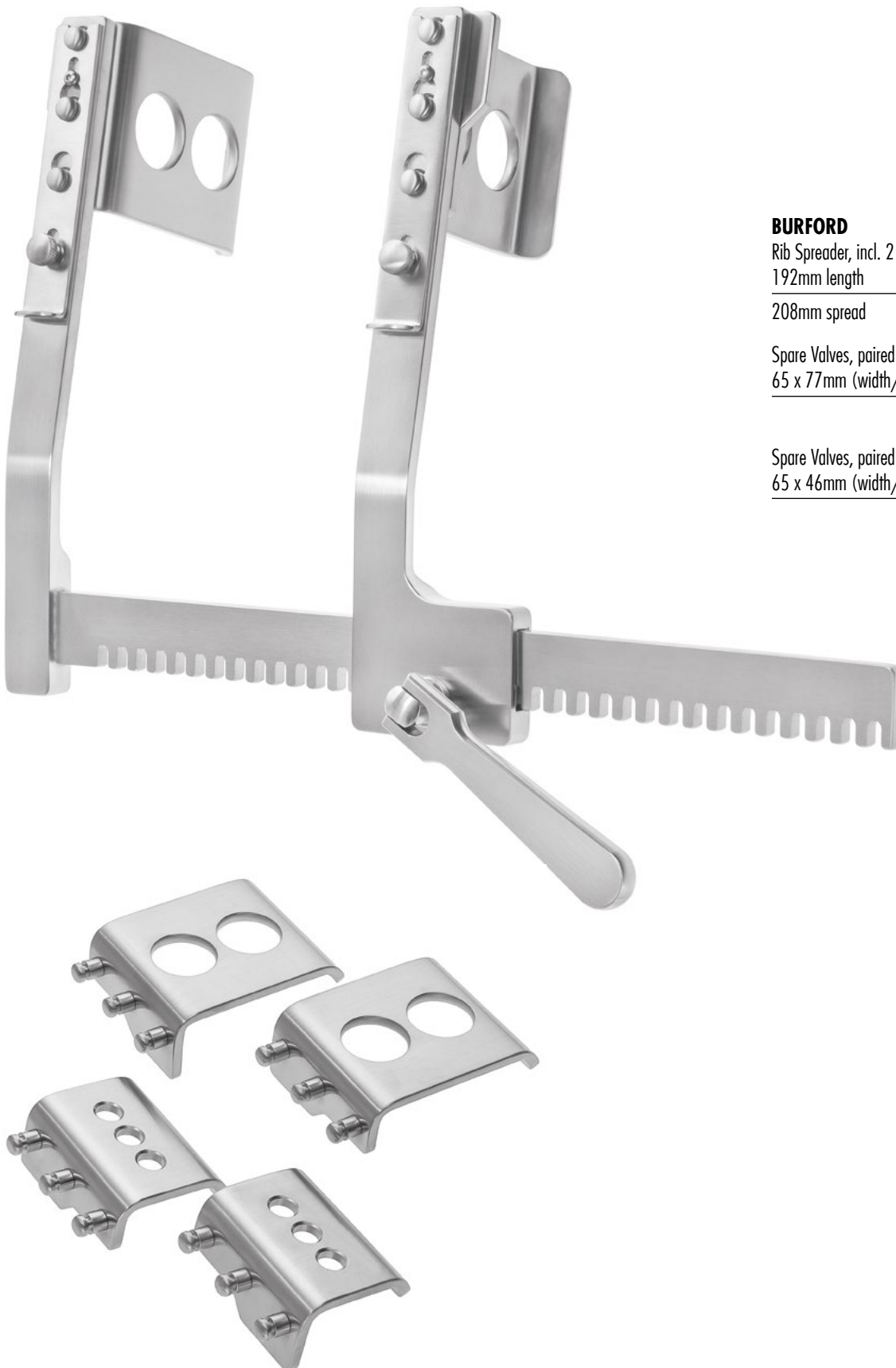

**BURFORD**

Rib Spreader, incl. 2 pair valves  
192mm length

208mm spread 290-181-000

Spare Valves, paired  
65 x 77mm (width/depth)

290-181-001

Spare Valves, paired  
65 x 46mm (width/depth)

290-181-002

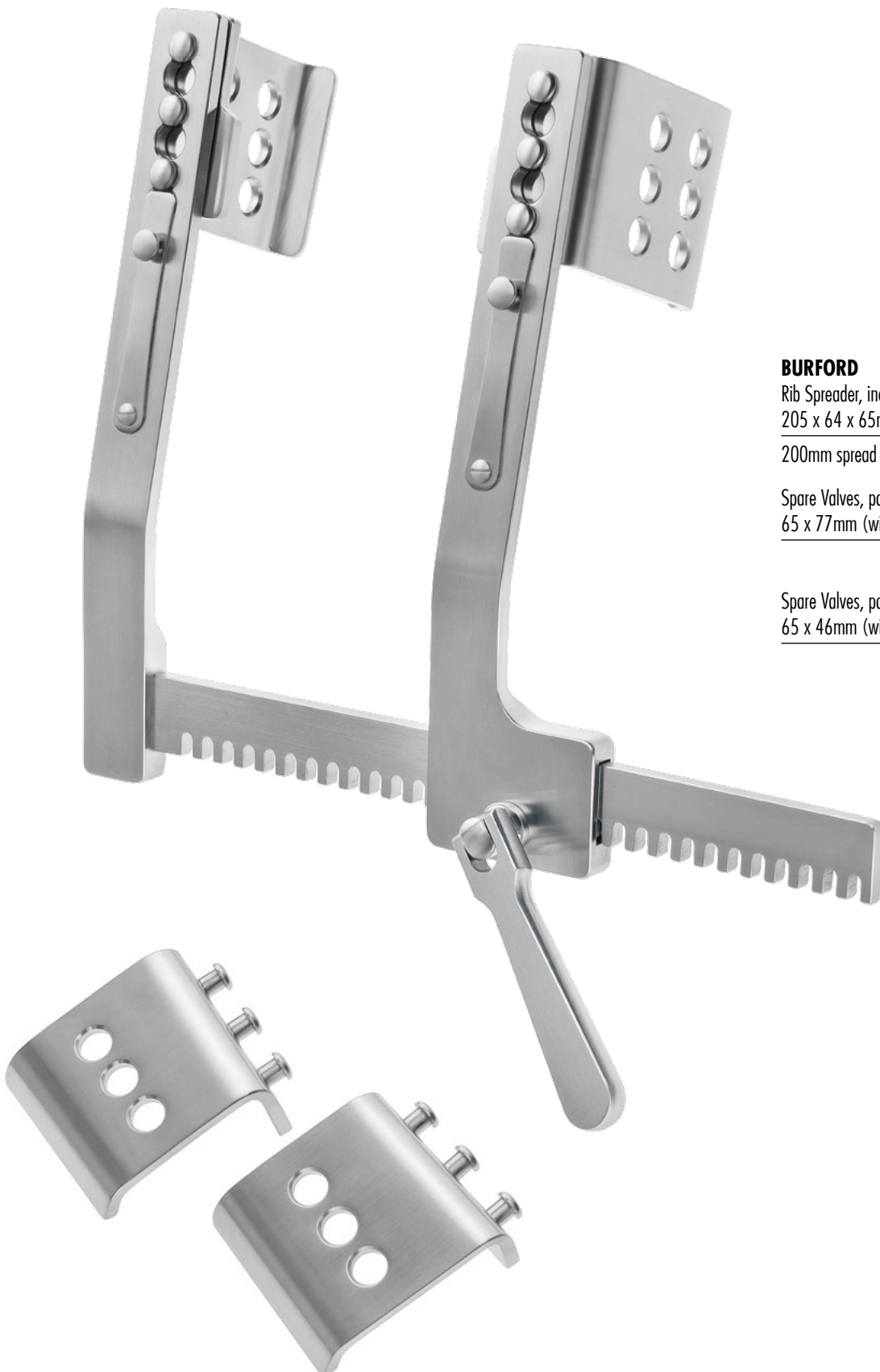

### **BURFORD**

Rib Spreader, incl. 2 pair valves  
205 x 64 x 65mm (length/width/depth)

200mm spread 290-181-010

Spare Valves, paired  
65 x 77mm (width/depth)

290-181-011

Spare Valves, paired  
65 x 46mm (width/depth)

290-181-012

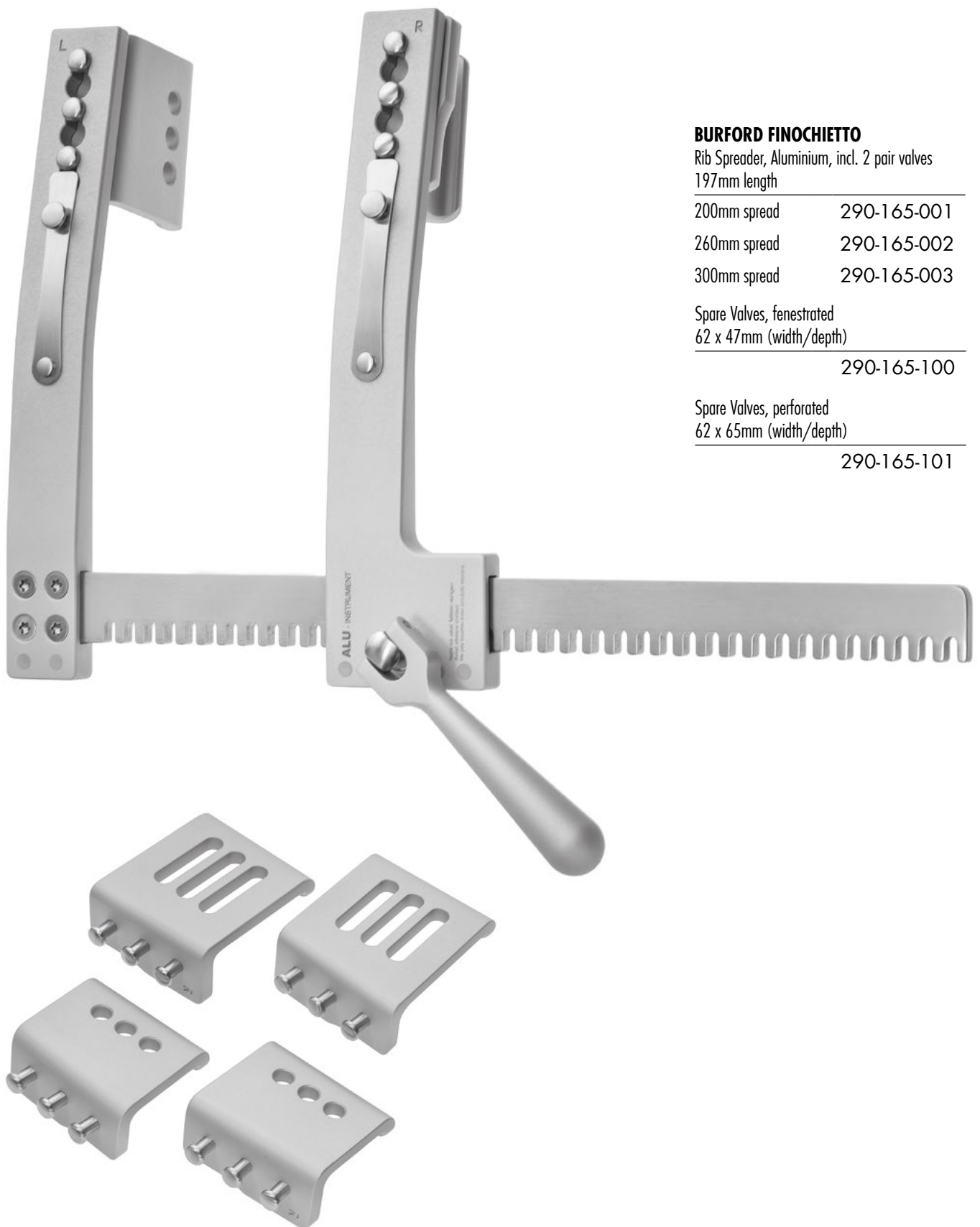

### **BURFORD FINOCHIETTO**

Rib Spreader, Aluminium, incl. 2 pair valves  
197mm length

200mm spread 290-165-001

260mm spread 290-165-002

300mm spread 290-165-003

Spare Valves, fenestrated  
62 x 47mm (width/depth)

290-165-100

Spare Valves, perforated  
62 x 65mm (width/depth)

290-165-101

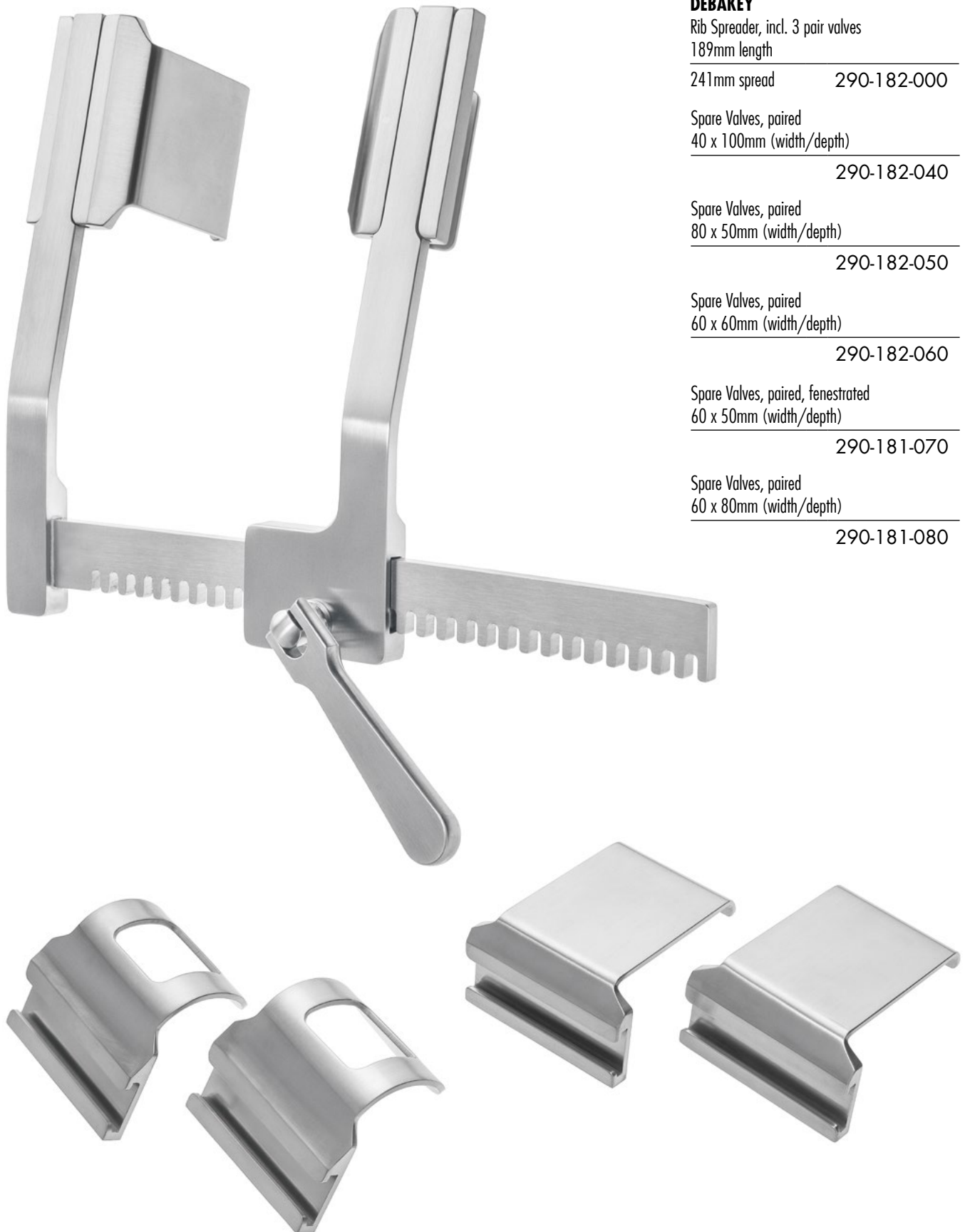

### DEBAKEY

Rib Spreader, incl. 3 pair valves  
189mm length

241mm spread 290-182-000

Spare Valves, paired  
40 x 100mm (width/depth)

290-182-040

Spare Valves, paired  
80 x 50mm (width/depth)

290-182-050

Spare Valves, paired  
60 x 60mm (width/depth)

290-182-060

Spare Valves, paired, fenestrated  
60 x 50mm (width/depth)

290-181-070

Spare Valves, paired  
60 x 80mm (width/depth)

290-181-080





**IMA**

Rib Spreader, complete with Mammary blade  
195 x 150 x 50mm (length/width/depth)

134mm spread

290-184-010



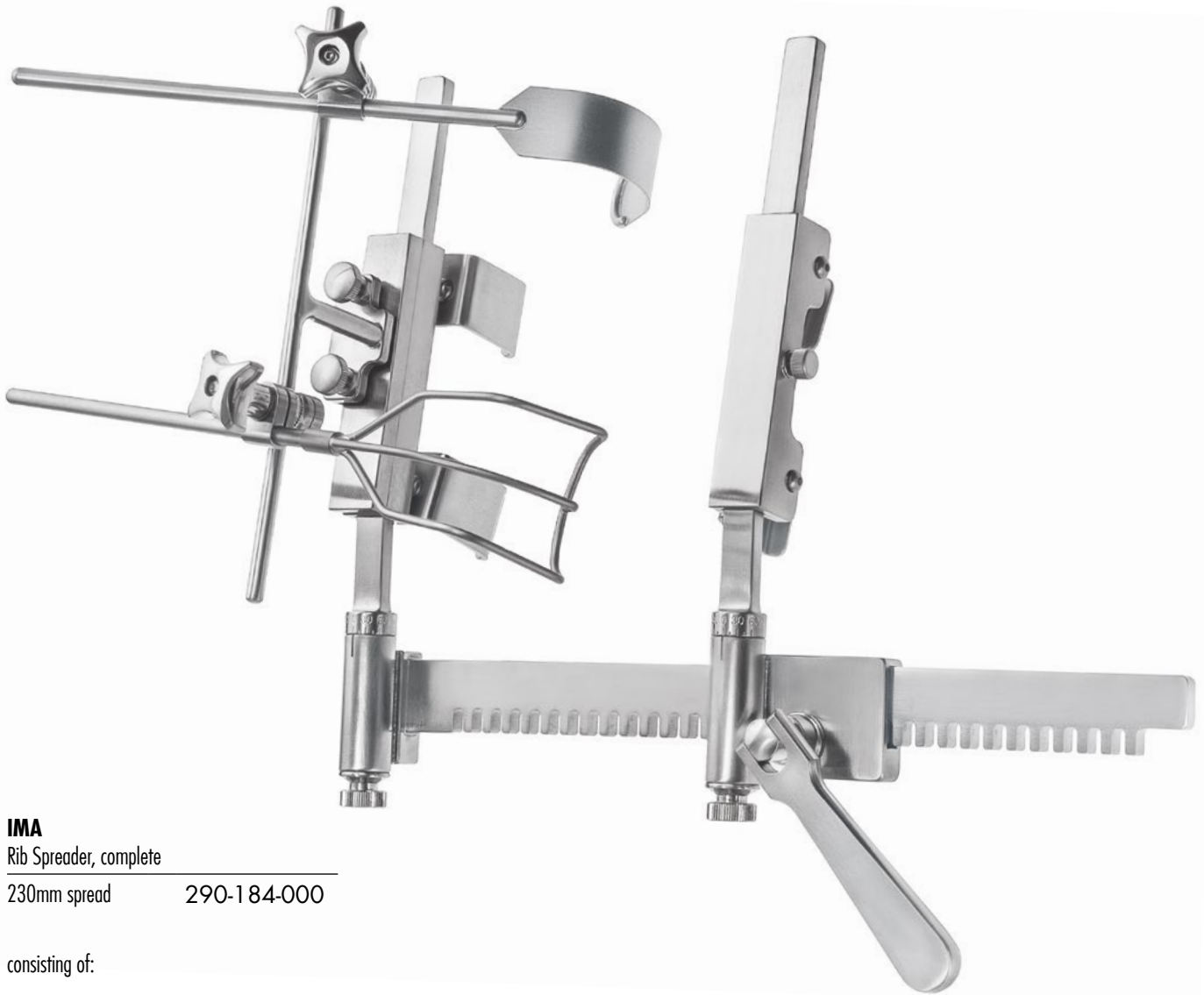

### IMA

Rib Spreader, complete

230mm spread      290-184-000

consisting of:

Double fixation valves

290-184-001

Double fixation valves with notch

290-184-002

T-Clamp

290-184-003

Universal Clamp

290-184-004

### COOLEY

Valve Retractor

small, 25mm      290-184-005

medium, 40mm      290-184-006

large, 50mm      290-184-007

Ribbon malleable valve

290-184-008

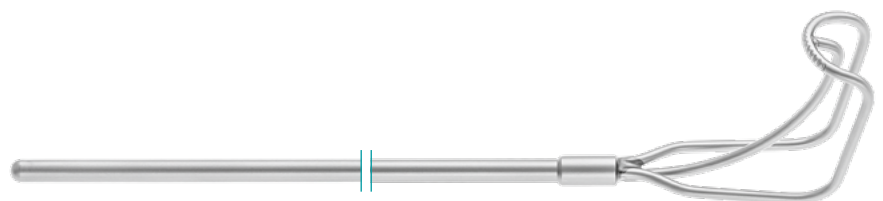

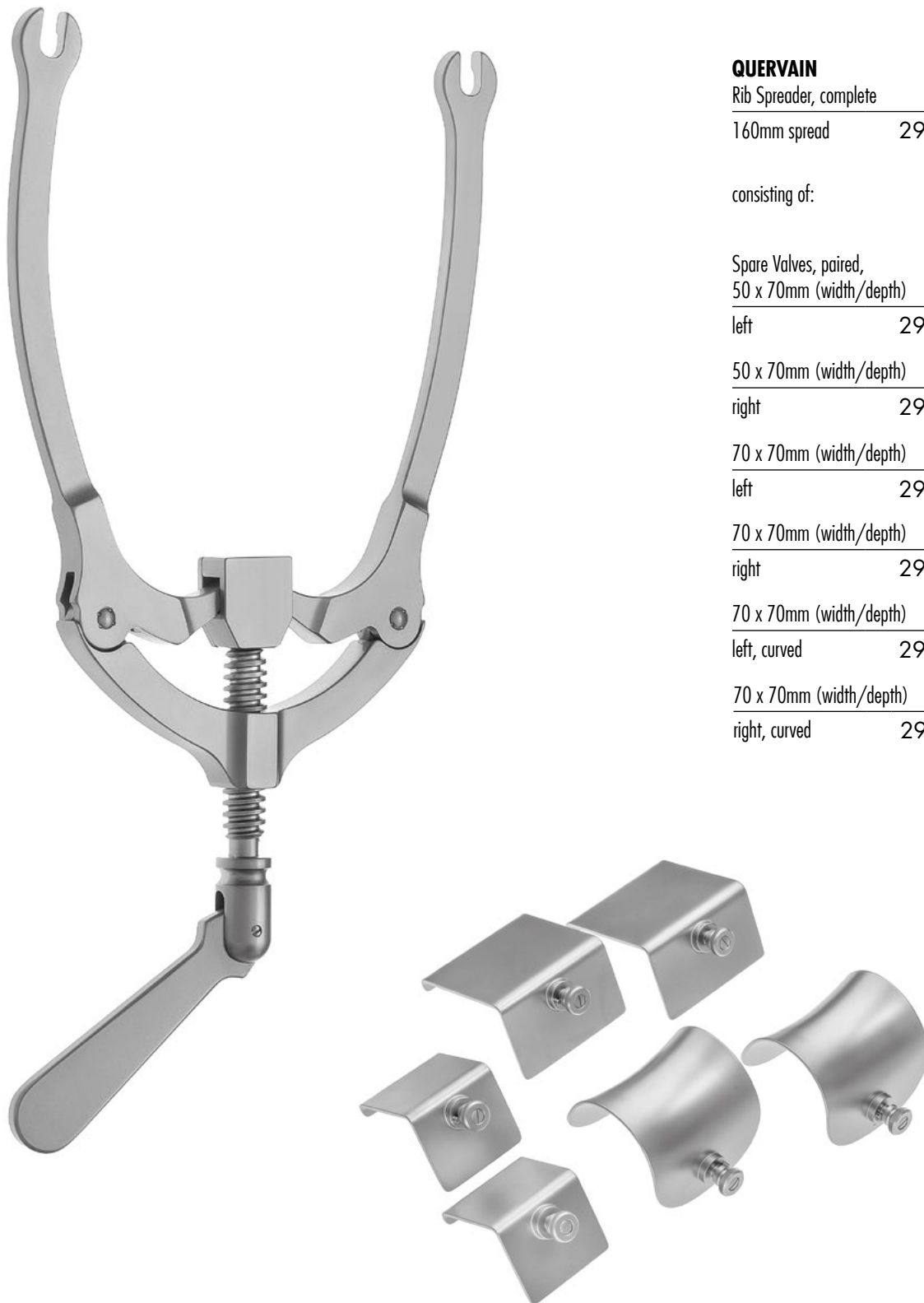

### QUERVAIN

Rib Spreader, complete

160mm spread	290-190-000
--------------	-------------

consisting of:

Spare Valves, paired,  
50 x 70mm (width/depth)

left	290-190-001
------	-------------

50 x 70mm (width/depth)

right	290-190-002
-------	-------------

70 x 70mm (width/depth)

left	290-190-003
------	-------------

70 x 70mm (width/depth)

right	290-190-004
-------	-------------

70 x 70mm (width/depth)

left, curved	290-190-005
--------------	-------------

70 x 70mm (width/depth)

right, curved	290-190-006
---------------	-------------

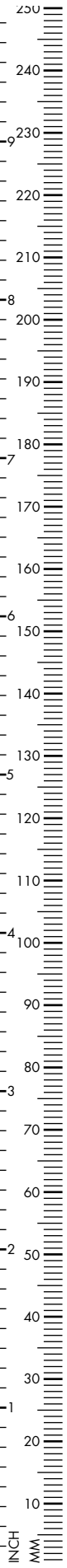

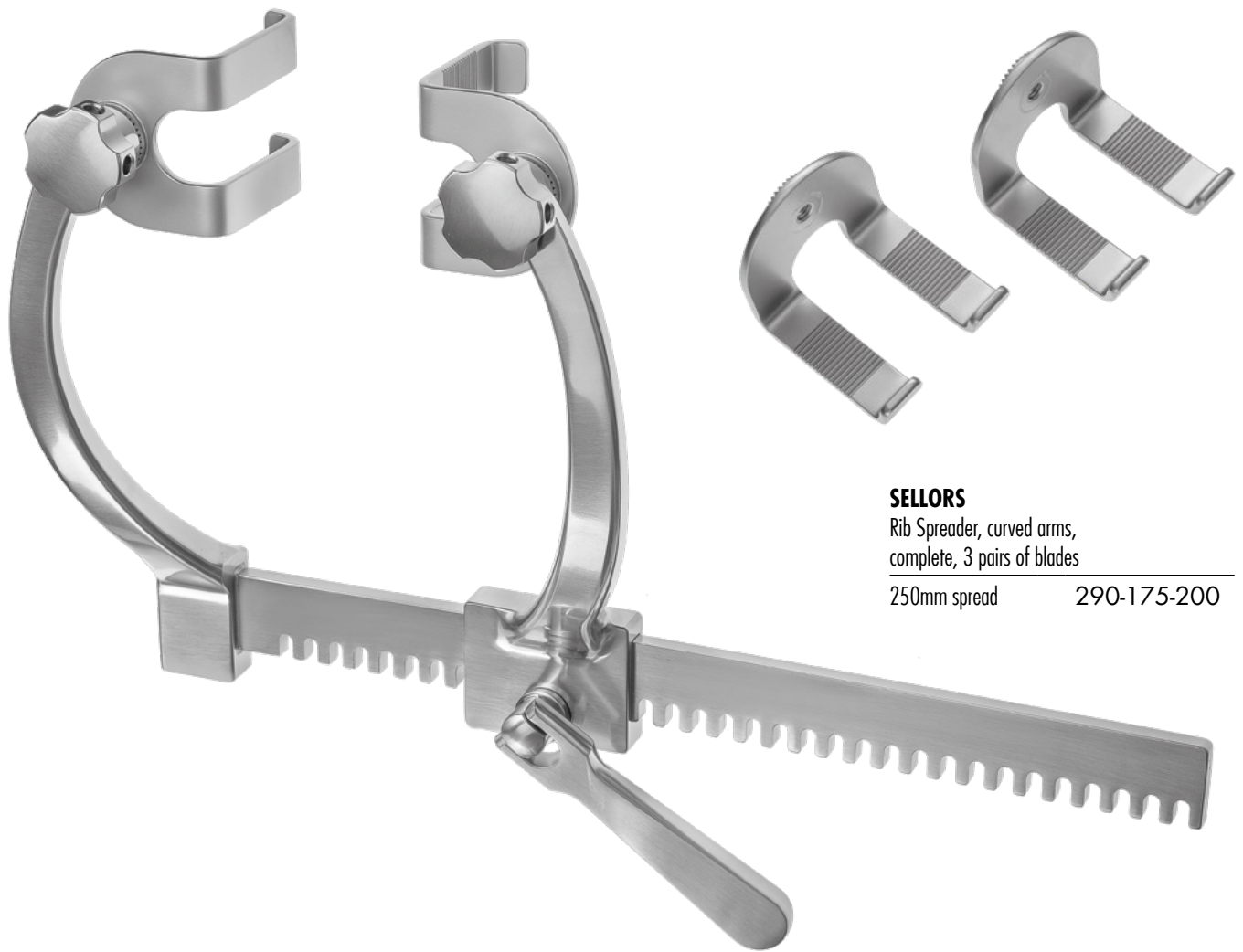

**SELLORS**

Rib Spreader, curved arms,  
complete, 3 pairs of blades

250mm spread

290-175-200



**BAILEY BABY**

Rib Contractor, 3 prongs, 18mm depth

140mm length      290-501-140

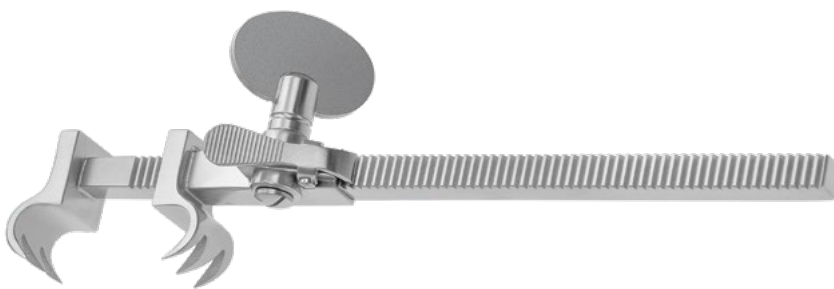

**BAILEY**

Rib Contractor, 3 prongs, 19mm depth

180mm length      290-502-160



**BAILEY GIBBON**

Rib Contractor, 3 prongs, 29mm depth

180mm length      290-503-160



**LEMMON**

Rib Contractor, Children

145mm length      290-504-140

Adults

180mm length      290-504-180

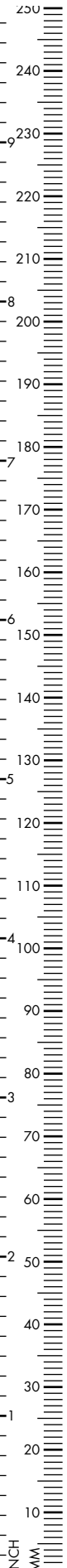



Fig. 1



Fig. 2



Fig. 3



Fig. 1



Fig. 2



Fig. 3



Fig. 4



### ÖSCH

Phlebectomy Hook, right handed

Fig. 1	290-150-501
Fig. 2	290-150-502
Fig. 3	290-150-503
Set	290-150-500

left handed

Fig. 1	290-150-601
Fig. 2	290-150-602
Fig. 3	290-150-603
Set	290-150-600

### MÜLLER

Phlebectomy Hook, right handed

Fig. 1	290-150-001
Fig. 2	290-150-002
Fig. 3	290-150-003
Fig. 4	290-150-004
Set	290-150-000

Phlebectomy Hook, left handed

Fig. 1	290-150-101
Fig. 2	290-150-102
Fig. 3	290-150-103
Fig. 4	290-150-104
Set	290-150-000

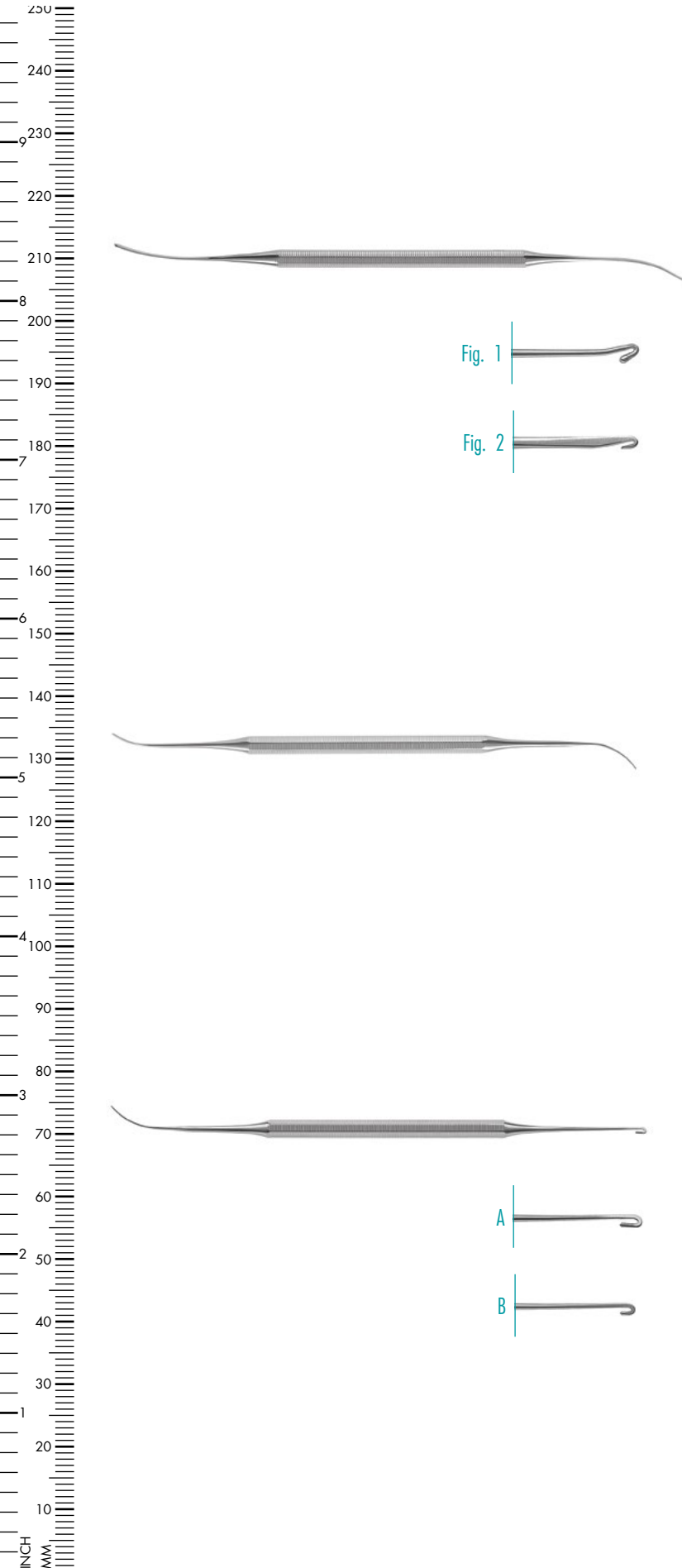

Fig. 1

Fig. 2

A

B

### VARADY

Phlebectomy Dissector

180mm, 7" 160-252-001

Phleboextractor, with hook 180mm, 7"

Fig. 1 160-252-002

Fig. 2 160-252-003

### VARADY

Micro Spatula

175mm, 6<sup>7</sup>/<sub>8</sub>" 160-252-004

### VARADY

Micro Phleboextractor, 170mm, 6<sup>2</sup>/<sub>3</sub>"

A 160-252-005

B 160-252-006

Set 160-252-000



Probe, malleable

400mm, 15 <sup>3</sup> / <sub>4</sub> "	160-210-400
500mm, 19 <sup>3</sup> / <sub>4</sub> "	160-210-500
650mm, 25 <sup>1</sup> / <sub>2</sub> "	160-210-650
800mm, 31 <sup>1</sup> / <sub>2</sub> "	160-210-800



### NABATOFF

Vein Stripper Set consisting of:

Probe tip, plastic	160-250-002
Stripper head, 3mm	160-250-003
Stripper head, 6mm	160-250-006
Stripper head, 9mm	160-250-009
Stripper head, 12mm	160-250-012
T-Handle	160-250-080
Sterilization Box	160-250-095
Set complete	160-250-000



### MYERS

Vein Stripper

Ø 6mm	160-245-006
Ø 9mm	160-245-009
Ø 12.5mm	160-245-125
Ø 16mm	160-245-016

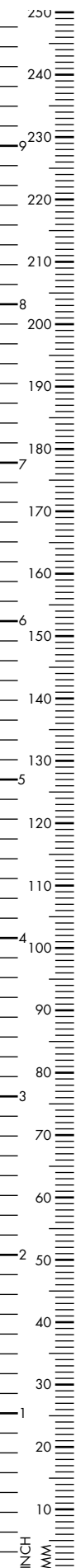

### Vessel Probes, 110mm, 4<sup>1</sup>/<sub>3</sub>"

Ø 0.5mm	290-704-105
Ø 1.0mm	290-704-110
Ø 1.5mm	290-704-115
Ø 2.0mm	290-704-120
Ø 2.5mm	290-704-125
Ø 3.0mm	290-704-130
Ø 3.5mm	290-704-135

Set

290-704-100

### 140mm, 5<sup>1</sup>/<sub>2</sub>"

Ø 0.5mm	290-704-405
Ø 1.0mm	290-704-410
Ø 1.5mm	290-704-415
Ø 2.0mm	290-704-420
Ø 2.5mm	290-704-425
Ø 3.0mm	290-704-430
Ø 3.5mm	290-704-435

Set

290-704-200

### 210mm, 8<sup>1</sup>/<sub>4</sub>"

Ø 0.5mm	290-704-205
Ø 1.0mm	290-704-210
Ø 1.5mm	290-704-215
Ø 2.0mm	290-704-220
Ø 2.5mm	290-704-225
Ø 3.0mm	290-704-230
Ø 3.5mm	290-704-235

Set

290-704-300





### GARRETT

Vascular Dilator, malleable, Ø 0.5mm

140mm, 5 <sup>1</sup> / <sub>2</sub> "	290-195-105
210mm, 8 <sup>1</sup> / <sub>4</sub> "	290-195-000
190mm, 7 <sup>1</sup> / <sub>2</sub> "	290-195-205
350mm, 14"	290-195-305

Ø 1.0mm

140mm, 5 <sup>1</sup> / <sub>2</sub> "	290-195-110
210mm, 8 <sup>1</sup> / <sub>4</sub> "	290-195-010
190mm, 7 <sup>1</sup> / <sub>2</sub> "	290-195-210
350mm, 14"	290-195-310

Ø 1.5mm

140mm, 5 <sup>1</sup> / <sub>2</sub> "	290-195-115
210mm, 8 <sup>1</sup> / <sub>4</sub> "	290-195-015
190mm, 7 <sup>1</sup> / <sub>2</sub> "	290-195-215
350mm, 14"	290-195-315

Ø 2.0mm

140mm, 5 <sup>1</sup> / <sub>2</sub> "	290-195-120
210mm, 8 <sup>1</sup> / <sub>4</sub> "	290-195-020
190mm, 7 <sup>1</sup> / <sub>2</sub> "	290-195-220
350mm, 14"	290-195-320

Ø 2.5mm

140mm, 5 <sup>1</sup> / <sub>2</sub> "	290-195-125
210mm, 8 <sup>1</sup> / <sub>4</sub> "	290-195-025
190mm, 7 <sup>1</sup> / <sub>2</sub> "	290-195-225
350mm, 14"	290-195-325

Ø 3.0mm

140mm, 5 <sup>1</sup> / <sub>2</sub> "	290-195-130
210mm, 8 <sup>1</sup> / <sub>4</sub> "	290-195-030
190mm, 7 <sup>1</sup> / <sub>2</sub> "	290-195-230
350mm, 14"	290-195-330

Ø 3.5mm

140mm, 5 <sup>1</sup> / <sub>2</sub> "	290-195-135
210mm, 8 <sup>1</sup> / <sub>4</sub> "	290-195-035
190mm, 7 <sup>1</sup> / <sub>2</sub> "	290-195-235
350mm, 14"	290-195-335

Ø 4.0mm

140mm, 5 <sup>1</sup> / <sub>2</sub> "	290-195-140
210mm, 8 <sup>1</sup> / <sub>4</sub> "	290-195-040
190mm, 7 <sup>1</sup> / <sub>2</sub> "	290-195-240
350mm, 14"	290-195-340

Ø 4.5mm

140mm, 5 <sup>1</sup> / <sub>2</sub> "	290-195-145
210mm, 8 <sup>1</sup> / <sub>4</sub> "	290-195-045
190mm, 7 <sup>1</sup> / <sub>2</sub> "	290-195-245
350mm, 14"	290-195-345

Ø 5.0mm

140mm, 5 <sup>1</sup> / <sub>2</sub> "	290-195-150
210mm, 8 <sup>1</sup> / <sub>4</sub> "	290-195-050
190mm, 7 <sup>1</sup> / <sub>2</sub> "	290-195-250
350mm, 14"	290-195-350

Set

140mm, 5 <sup>1</sup> / <sub>2</sub> "	290-195-100
210mm, 8 <sup>1</sup> / <sub>4</sub> "	290-195-000
190mm, 7 <sup>1</sup> / <sub>2</sub> "	290-195-200
350mm, 14"	290-195-300



### DEBAKEY

Vascular Dilator, malleable, Ø 0.5mm

190mm, 7<sup>1</sup>/<sub>2</sub>" 290-705-050

350mm, 14" 290-706-050

Ø 2.0mm

190mm, 7<sup>1</sup>/<sub>2</sub>" 290-705-200

350mm, 14" 290-706-200

Ø 3.5mm

190mm, 7<sup>1</sup>/<sub>2</sub>" 290-705-350

350mm, 14" 290-706-350

Ø 5.0mm

190mm, 7<sup>1</sup>/<sub>2</sub>" 290-705-500

350mm, 14" 290-706-500

Ø 1.0mm

190mm, 7<sup>1</sup>/<sub>2</sub>" 290-705-100

350mm, 14" 290-706-100

Ø 2.5mm

190mm, 7<sup>1</sup>/<sub>2</sub>" 290-705-250

350mm, 14" 290-706-250

Ø 4.0mm

190mm, 7<sup>1</sup>/<sub>2</sub>" 290-705-400

350mm, 14" 290-706-400

Ø 7.0mm

190mm, 7<sup>1</sup>/<sub>2</sub>" 290-705-700

350mm, 14" 290-706-700

Ø 1.5mm

190mm, 7<sup>1</sup>/<sub>2</sub>" 290-705-150

350mm, 14" 290-706-150

Ø 3.0mm

190mm, 7<sup>1</sup>/<sub>2</sub>" 290-705-300

350mm, 14" 290-706-300

Ø 4.5mm

190mm, 7<sup>1</sup>/<sub>2</sub>" 290-705-450

350mm, 14" 290-706-450

Ø 9.0mm

190mm, 7<sup>1</sup>/<sub>2</sub>" 290-705-900

350mm, 14" 290-706-900



### COOLEY

Vascular Dilator, malleable, Ø 0.5mm

130mm, 5<sup>1</sup>/<sub>8</sub>" 290-703-005

190mm, 7<sup>1</sup>/<sub>2</sub>" 290-703-105

Ø 2.0mm

130mm, 5<sup>1</sup>/<sub>8</sub>" 290-703-020

190mm, 7<sup>1</sup>/<sub>2</sub>" 290-703-120

Ø 4.0mm

130mm, 5<sup>1</sup>/<sub>8</sub>" 290-703-040

190mm, 7<sup>1</sup>/<sub>2</sub>" 290-703-140

Ø 1.0mm

130mm, 5<sup>1</sup>/<sub>8</sub>" 290-703-010

190mm, 7<sup>1</sup>/<sub>2</sub>" 290-703-110

Ø 2.5mm

130mm, 5<sup>1</sup>/<sub>8</sub>" 290-703-025

190mm, 7<sup>1</sup>/<sub>2</sub>" 290-703-125

Ø 5.0mm

130mm, 5<sup>1</sup>/<sub>8</sub>" 290-703-050

190mm, 7<sup>1</sup>/<sub>2</sub>" 290-703-150

Ø 1.5mm

130mm, 5<sup>1</sup>/<sub>8</sub>" 290-703-015

190mm, 7<sup>1</sup>/<sub>2</sub>" 290-703-115

Ø 3.0mm

130mm, 5<sup>1</sup>/<sub>8</sub>" 290-703-030

190mm, 7<sup>1</sup>/<sub>2</sub>" 290-703-130

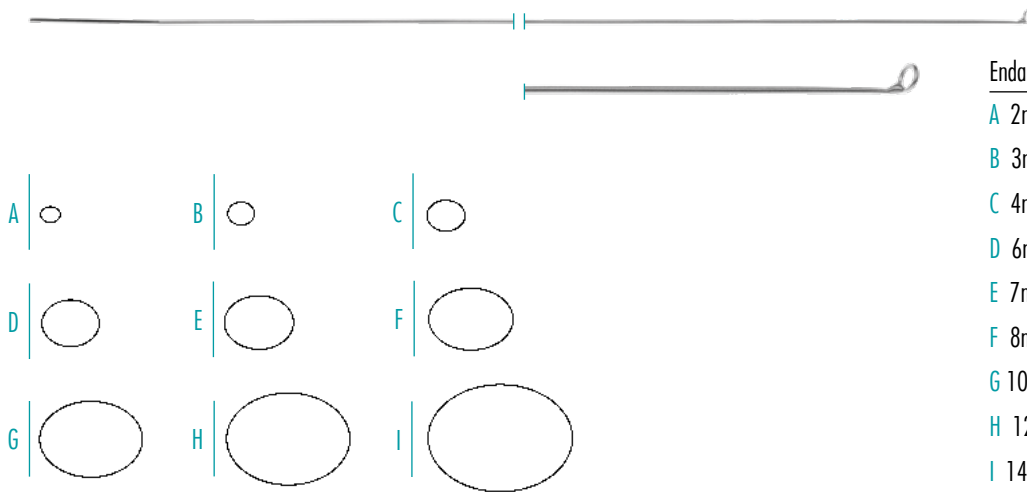

Endarterectomy Stripper, 550mm, 22"

A	2mm	160-251-002
B	3mm	160-251-003
C	4mm	160-251-004
D	6mm	160-251-006
E	7mm	160-251-007
F	8mm	160-251-008
G	10mm	160-251-010
H	12mm	160-251-012
I	14mm	160-251-014



Handle for Endarterectomy Stripper

160-251-030

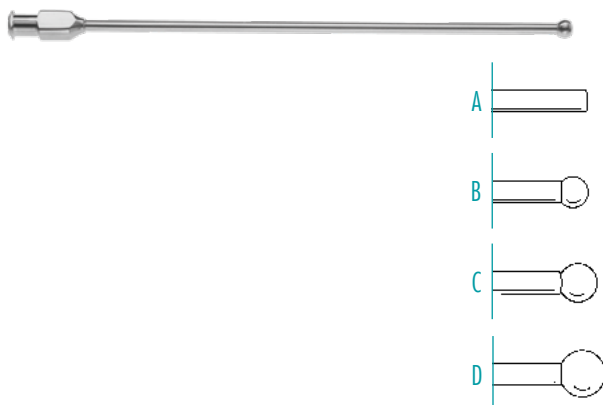

### SCHMID

Vessel irrigating cannula, malleable

A	Ø 3mm	165-700-003
B	Ø 4mm	165-700-004
C	Ø 5mm	165-700-005
D	Ø 6mm	165-700-006



Cannula, venous

18G x 3 1/8"	165-705-120
(1.2 x 80mm)	
17G x 3 1/8"	165-705-150
(1.5 x 80mm)	



### MOCK

Heparin Flushing Needle

60mm, 2 3/8"	165-710-060
--------------	-------------



**TUBBS**

Dilator, adult size  
for mitral valve blade opening 8-42mm

290-482-000

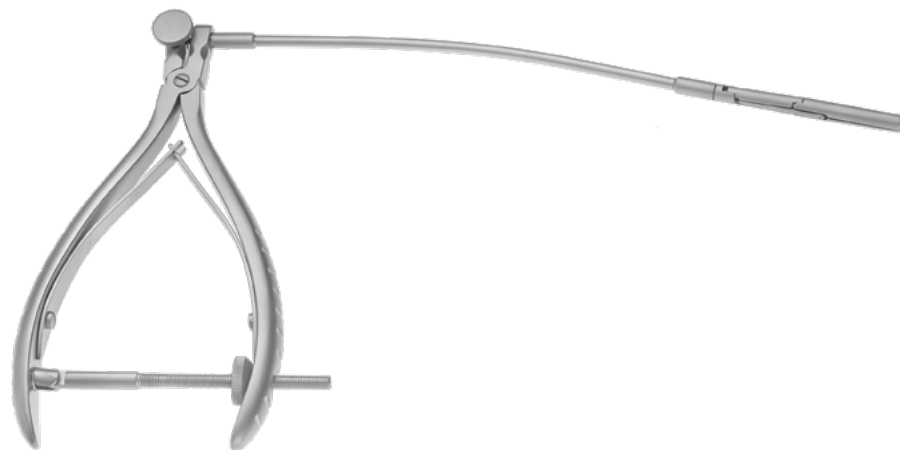

**COOLEY**

Dilator, child size

290-484-000

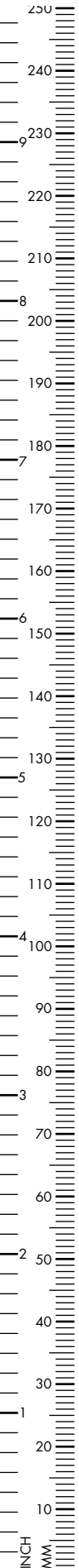

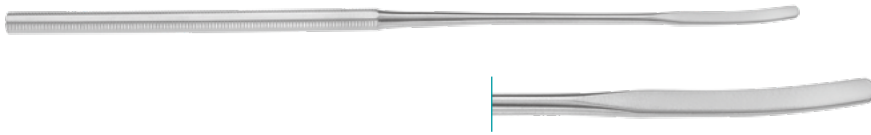

Intima Spatula, 3mm	
180mm, 7"	290-535-180
210mm, 8 <sup>1</sup> / <sub>4</sub> "	290-535-210
4mm	
140mm, 5 <sup>1</sup> / <sub>2</sub> "	290-537-140
5.5mm	
240mm, 9 <sup>1</sup> / <sub>2</sub> "	290-537-240

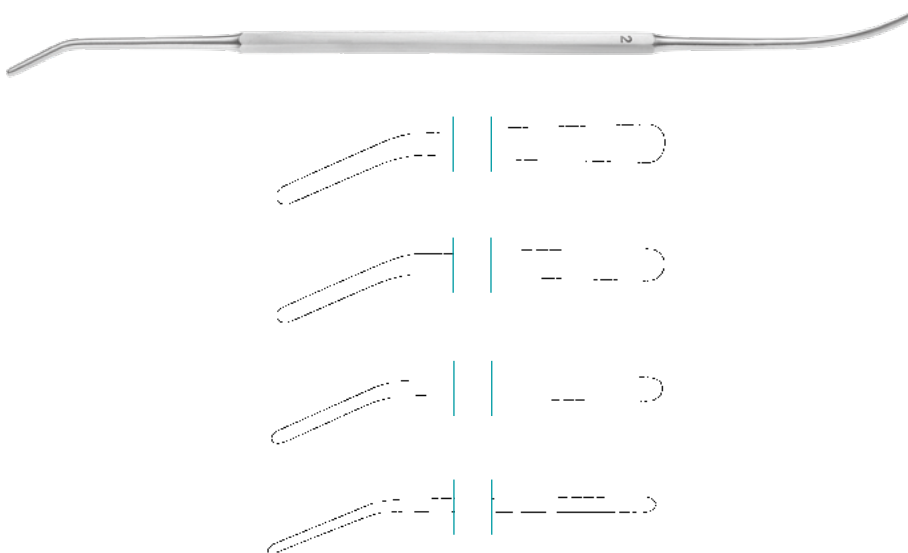

<b>ROBB</b>	
Dissector, 240mm, 9 <sup>1</sup> / <sub>2</sub> "	
Fig. 1, 5 / 2.5mm	290-539-001
Fig. 2, 4 / 2.0mm	290-539-002
Fig. 3, 3 / 1.5mm	290-539-003
Fig. 4, 2 / 1.0mm	290-539-004



<b>LEMMON</b>	
Intima Dissector, 165mm, 6 <sup>1</sup> / <sub>2</sub> "	
4mm wide	290-707-165
8mm wide	290-708-165
15mm wide	290-709-165

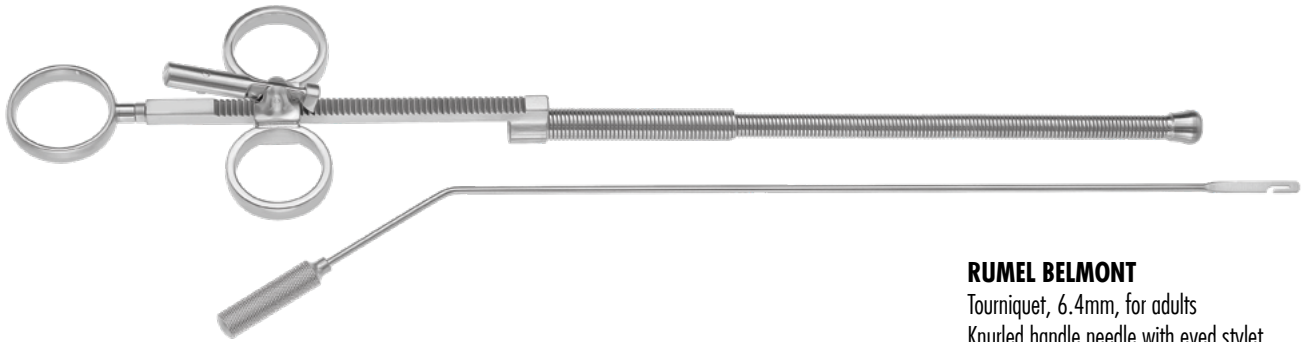

**RUMEL BELMONT**

Tourniquet, 6.4mm, for adults  
Knurled handle needle with eyed stylet

complete	290-558-330
Stylet	290-558-331

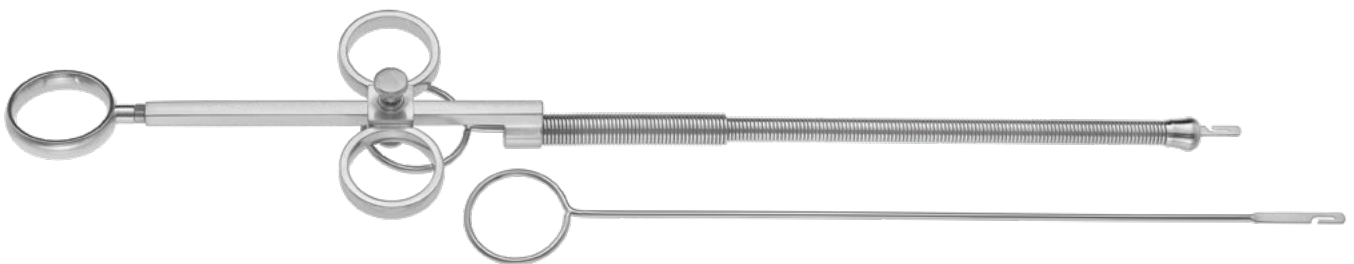

**RUMEL BELMONT**

Tourniquet, 6.5mm, for adults, flexible,  
without ratchet,  
Ring handle needle with eyed stylet

complete	290-564-305
Stylet	290-564-306

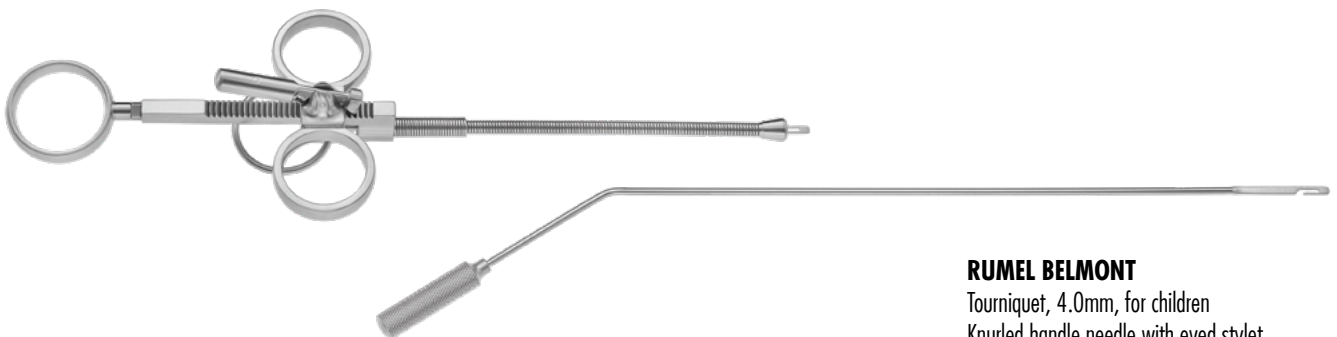

**RUMEL BELMONT**

Tourniquet, 4.0mm, for children  
Knurled handle needle with eyed stylet

complete	290-556-330
Stylet	290-556-331

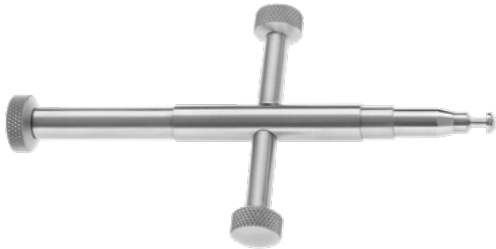

Punch	
120mm, 4 <sup>3</sup> / <sub>4</sub> "	
Ø 3mm	290-712-030
Ø 4mm	290-712-040
Ø 5mm	290-712-050
150mm, 6"	
Ø 4mm	290-715-040
Ø 4.5mm	290-715-045

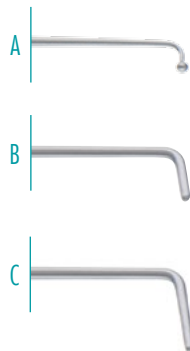

Nerve and Vessel Hook for valve surgery	
A 4.5mm tip length, Ø 1.5mm tip	
350mm, 14"	295-000-001
B 5.0mm tip length, Ø 1.0mm tip	
350mm, 14"	295-000-002
C 9.0mm tip length, Ø 1.5mm tip	
350mm, 14"	295-000-003

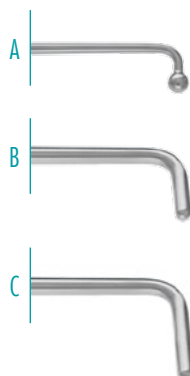

Nerve and Vessel Hook for valve surgery	
A 5.0mm tip length, Ø 3.0mm tip	
330mm, 13"	295-000-101
B 5.0mm tip length, Ø 1.4mm tip	
330mm, 13"	295-000-102
C 9.0mm tip length, Ø 2.3mm tip	
330mm, 13"	295-000-103

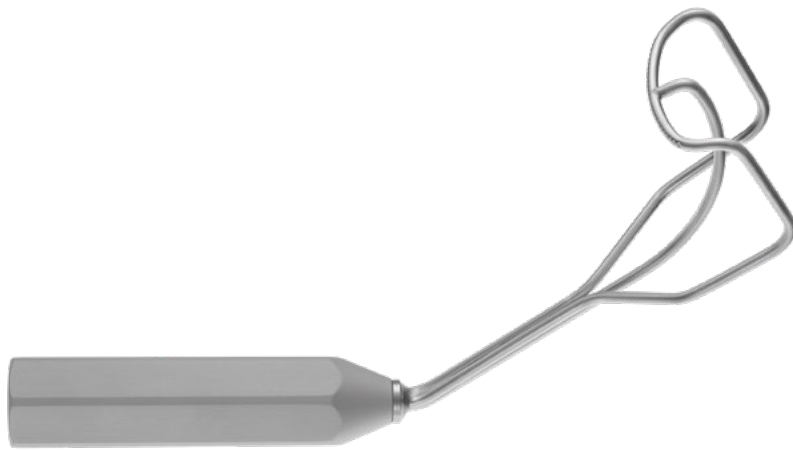

### COOLEY

Retractor, serrated, Aluminium handle, right

25 x 35mm	290-485-201
40 x 35mm	290-485-202
50 x 35mm	290-485-203

left

50 x 10mm	290-485-204
-----------	-------------



### ROSS

Retractor, 270mm, 10<sup>2/3</sup>"

Fig. 1 15 x 16mm	170-475-001
Fig. 2 13 x 23mm	170-475-002
Fig. 3 25 x 18mm	170-475-003
Fig. 4 29 x 13mm	170-475-004
Fig. 5 29 x 29mm	170-475-005
Fig. 6 35 x 21mm	170-475-006



### DAVIDSON

Scapular Retractor, 160mm, 6<sup>1/4</sup>"

75 x 50mm	170-463-001
75 x 90mm	170-463-002



### CORYLLOS

Retractor, 240mm, 9<sup>1/2</sup>"

82 x 22mm	170-461-001
108 x 43mm	170-461-002
115 x 65mm	170-461-003

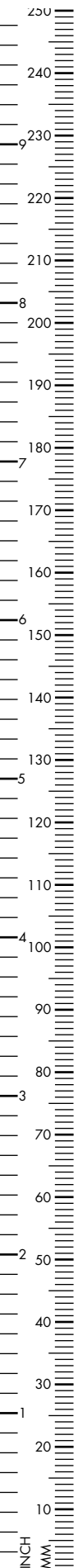





### **BOROWSKI**

Retractor, malleable

17 x 21mm	290-485-301
16 x 23mm	290-485-302
20 x 25mm	290-485-303
24 x 27mm	290-485-304
28 x 20mm	290-485-305
28 x 29mm	290-485-306



### **ALLISON**

Lung Spatula, 40mm

300mm, 11 <sup>7</sup> / <sub>8</sub> "	290-505-300
53mm	
320mm, 12 <sup>1</sup> / <sub>2</sub> "	290-505-320

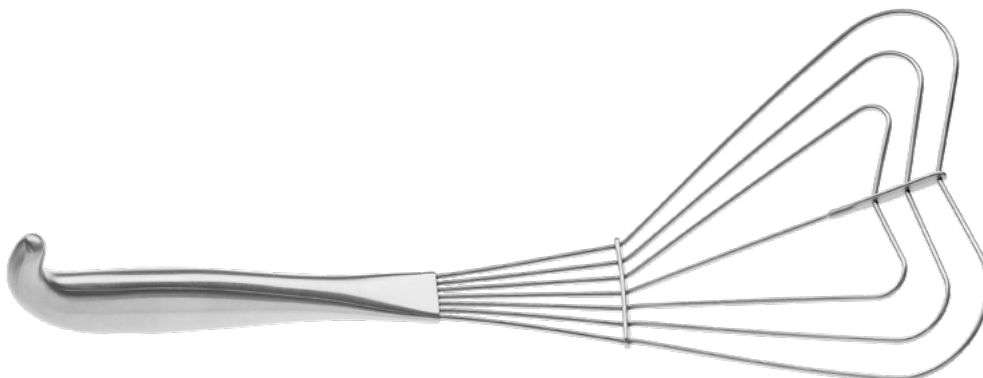

Lung Spatula

300mm, 11 <sup>7</sup> / <sub>8</sub> "	290-511-260
---	-------------

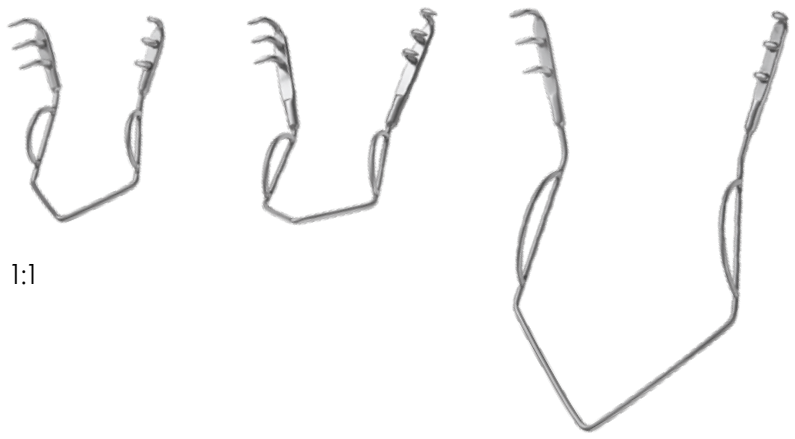
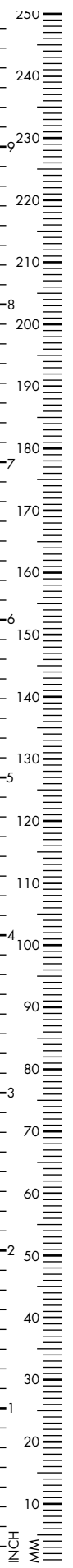

1:1

<b>PARSONNET</b>	
Retractor, 3x3 teeth	
25mm	290-233-025
32mm	290-233-030
50mm	290-233-047

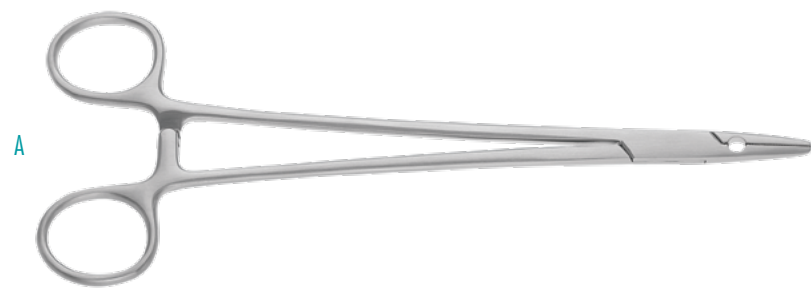

A

<b>Valve Set</b>	
consisting of:	
<b>A Clamp</b>	295-130-000



B

230mm	295-130-008
<b>B Stick</b>	
190mm	295-130-001



C

<b>C Valve</b>	
30 x 35mm	295-130-002
40 x 35mm	295-130-003
50 x 35mm	295-130-004
50 x 45mm	295-130-005
60 x 45mm	295-130-006
75 x 45mm	295-130-007



