

SKIN AND WOUND

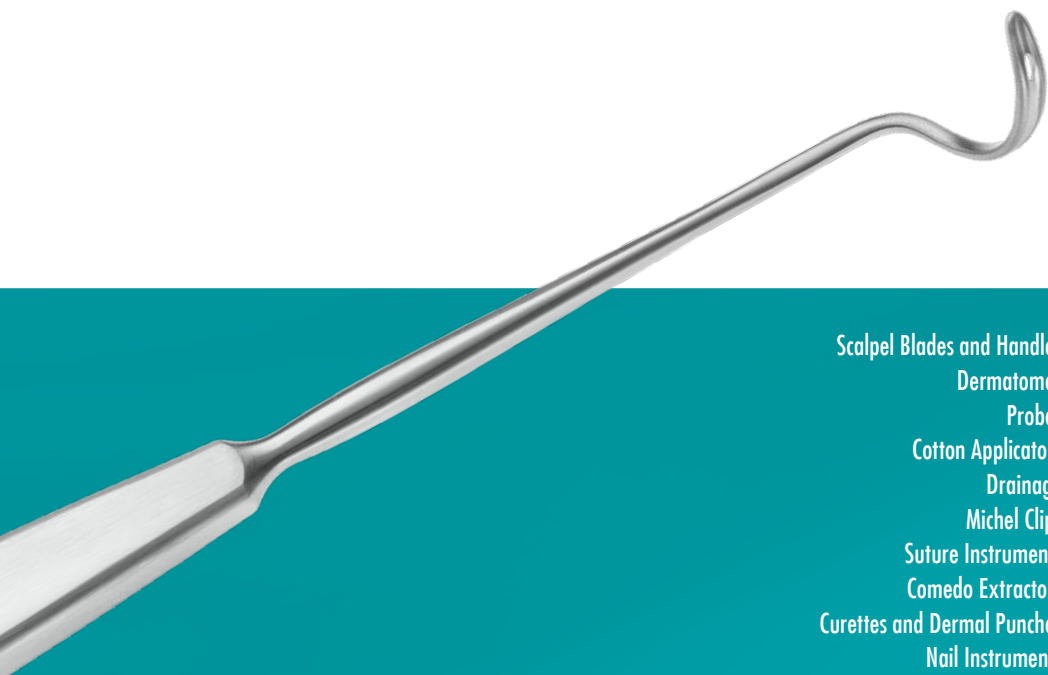

Scalpel Blades and Handles
Dermatomes
Probes
Cotton Applicators
Drainage
Michel Clips
Suture Instruments
Comedo Extractors
Curettes and Dermal Punches
Nail Instruments

FOR BLADES #3

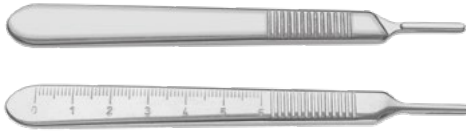

Knife Handle #3, 130mm, 5¹/₈"

110-110-003

with cm/mm scale

110-114-003



Knife Handle #3L

210mm, 8¹/₄"

110-116-033

360mm, 14"

110-116-133



Knife Handle #3LA

210mm, 8¹/₄"

110-117-033



Knife Handle #7

165mm, 6¹/₂"

110-130-077



Knife Handle #7K

130mm, 5¹/₈"

110-130-007

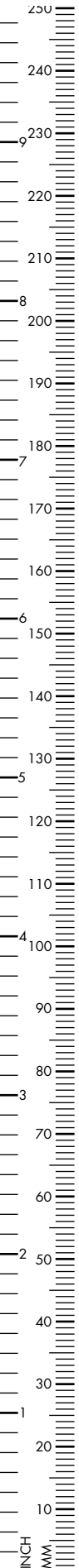

FOR BLADES # 4

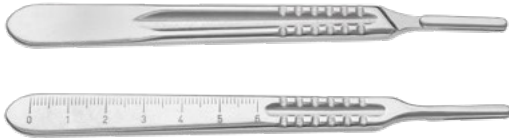

Knife Handle #4, 135mm, 5¹/₃"

110-140-004

with cm/mm scale

110-141-004



Knife Handle #4L

210mm, 8¹/₄"

110-144-004



COLLIN

Scalpel Handle #8

130mm, 5¹/₈"

110-146-008



COLLIN

Scalpel Handle #9

145mm, 5³/₈"

110-146-009

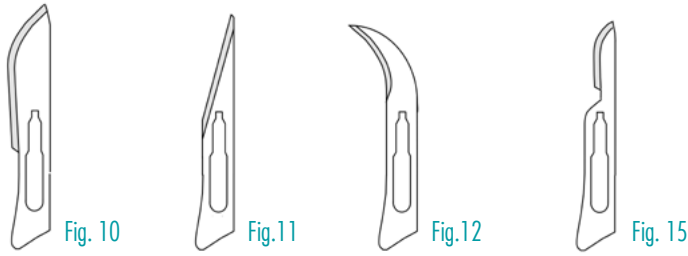

SCALPEL BLADES FOR HANDLES #3

Sterile Pack of 100pcs.

Fig. 10	110-201-010
Fig. 11	110-201-011
Fig. 12	110-201-012
Fig. 15	110-201-015

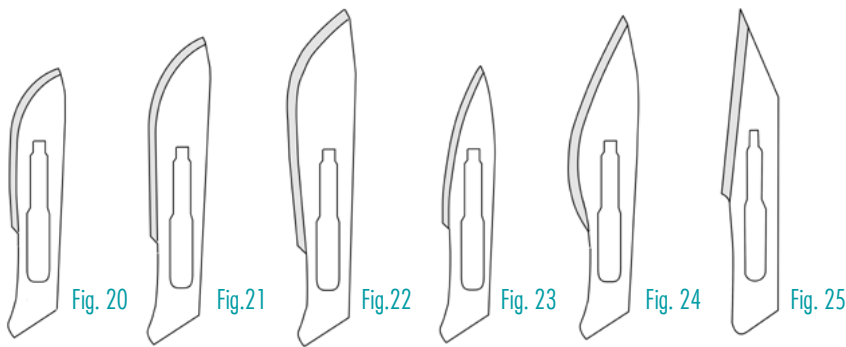

SCALPEL BLADES FOR HANDLES #4

Sterile Pack of 100pcs.

Fig. 20	110-201-020
Fig. 21	110-201-021
Fig. 22	110-201-022
Fig. 23	110-201-023
Fig. 24	110-201-024
Fig. 25	110-201-025

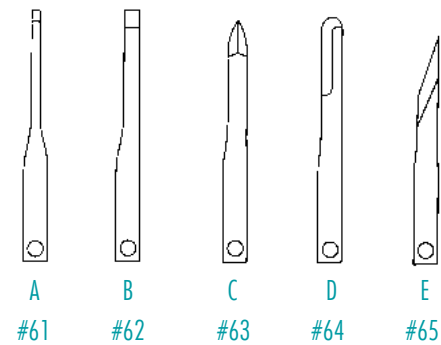

MINI SCALPEL BLADES

Sterile Pack of 100pcs.

A	250-022-361
B	250-022-362
C	250-022-363
D	250-022-364
E	250-022-365

FOR MINI BLADES



Knife Handle, round knurled handle	
#3KS	110-150-095
95mm, 3 ³ / ₄ "	
#3KL	110-150-150
150mm, 6"	
Replacement	
	110-150-000



Knife Handle, hexagonal handle	
#3HL	110-152-160
160mm, 6 ¹ / ₄ "	
Knife Handle, for mini blades	
105mm, 4 ¹ / ₈ "	110-152-105
Replacement	
	110-150-000



CASPAR	
Scalpel Handle	
155mm, 6 ¹ / ₈ "	250-022-048



Scalpel Handle	
200mm, 8"	250-022-054



LANDOLT	
Scalpel Handle	
210mm, 8 ¹ / ₄ "	250-022-053



BRAITHWAITE

Hand Dermatome, right handed, complete, 300mm, 11⁷/₈"

right handed 1 10-098-305

left handed 1 10-097-305

Blade only, non sterile, package of 10 pcs.

1 10-098-399



SILVER

Skin Graft Knife

190mm, 7¹/₂" 1 10-096-019

Spare Blade

1 10-096-119



GOULIAN

Skin Graft Knife, complete with 5 spare blades

180mm, 7" 1 10-096-180

Spare blade

1 10-096-185



SCHINK

Dermatome, with interchangeable blade and 2 skin straightening blades

300mm, 11⁷/₈" 1 10-090-000

Spare Blade

1 10-090-001



Skin straightening plate

1 10-090-002

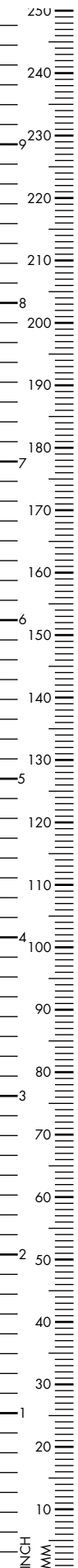



Button-end Probe, \varnothing 1mm

115mm, 4 ^{1/2} "	160-102-115
130mm, 5 ^{1/8} "	160-102-130
145mm, 5 ^{3/4} "	160-102-145
160mm, 6 ^{1/4} "	160-102-160
180mm, 7"	160-102-180
200mm, 8"	160-102-200

\varnothing 2mm

115mm, 4 ^{1/2} "	160-100-115
130mm, 5 ^{1/8} "	160-100-130
145mm, 5 ^{3/4} "	160-100-145
160mm, 6 ^{1/4} "	160-100-160
180mm, 7"	160-100-180
200mm, 8"	160-100-200

Button-end Probe, with eye, \varnothing 2mm

115mm, 4 ^{1/2} "	160-108-115
130mm, 5 ^{1/8} "	160-108-130
145mm, 5 ^{3/4} "	160-108-145
160mm, 6 ^{1/4} "	160-108-160
180mm, 7"	160-108-180
200mm, 8"	160-108-200



Myrtle Leaf Probe, \varnothing 2mm

145mm, 5 ^{3/4} "	160-150-145
160mm, 6 ^{1/4} "	160-150-160
180mm, 7"	160-150-180
200mm, 8"	160-150-200



Probe, \varnothing 1.5mm

130mm, 5 ^{1/8} "	160-099-130
145mm, 5 ^{3/4} "	160-099-145
160mm, 6 ^{1/4} "	160-099-160
200mm, 8"	160-099-200





STACKE

Probe, \varnothing 1mm

140mm, 5^{1/2}" 160-130-140



BOWMAN

Lacrimal Probe, buttoned up, german silver

0/1 400-497-001

00/0 400-497-003

000/00 400-497-005

0000/000 400-497-008

1/2 400-497-012

2/3 400-497-023

3/4 400-497-034



LOCKHART MUMMERY

Fistula Probe, 165mm, 6^{1/2}"

Fig. 1

Fig. 2

Fig. 3

Fig. 4

Fig. 1 160-110-001

Fig. 2 160-110-002

Fig. 3 160-110-003

Fig. 4 160-110-004



Grooved Director

115mm, 4 ^{1/2} "	160-107-115
130mm, 5 ^{1/8} "	160-107-130
145mm, 5 ^{3/4} "	160-107-145
160mm, 6 ^{1/4} "	160-107-160
180mm, 7"	160-107-180
200mm, 8"	160-107-200



Grooved Director, buttoned

130mm, 5 ^{1/8} "	160-170-130
145mm, 5 ^{3/4} "	160-170-145
160mm, 6 ^{1/4} "	160-170-160
180mm, 7"	160-170-180



DOYEN

Director

145mm, 5 ^{3/4} "	160-175-145
---------------------------	-------------



NÉLATON

Director

160mm, 6 ^{1/4} "	160-185-160
---------------------------	-------------



BRODIE

Probe

200mm, 8"	160-090-200
-----------	-------------

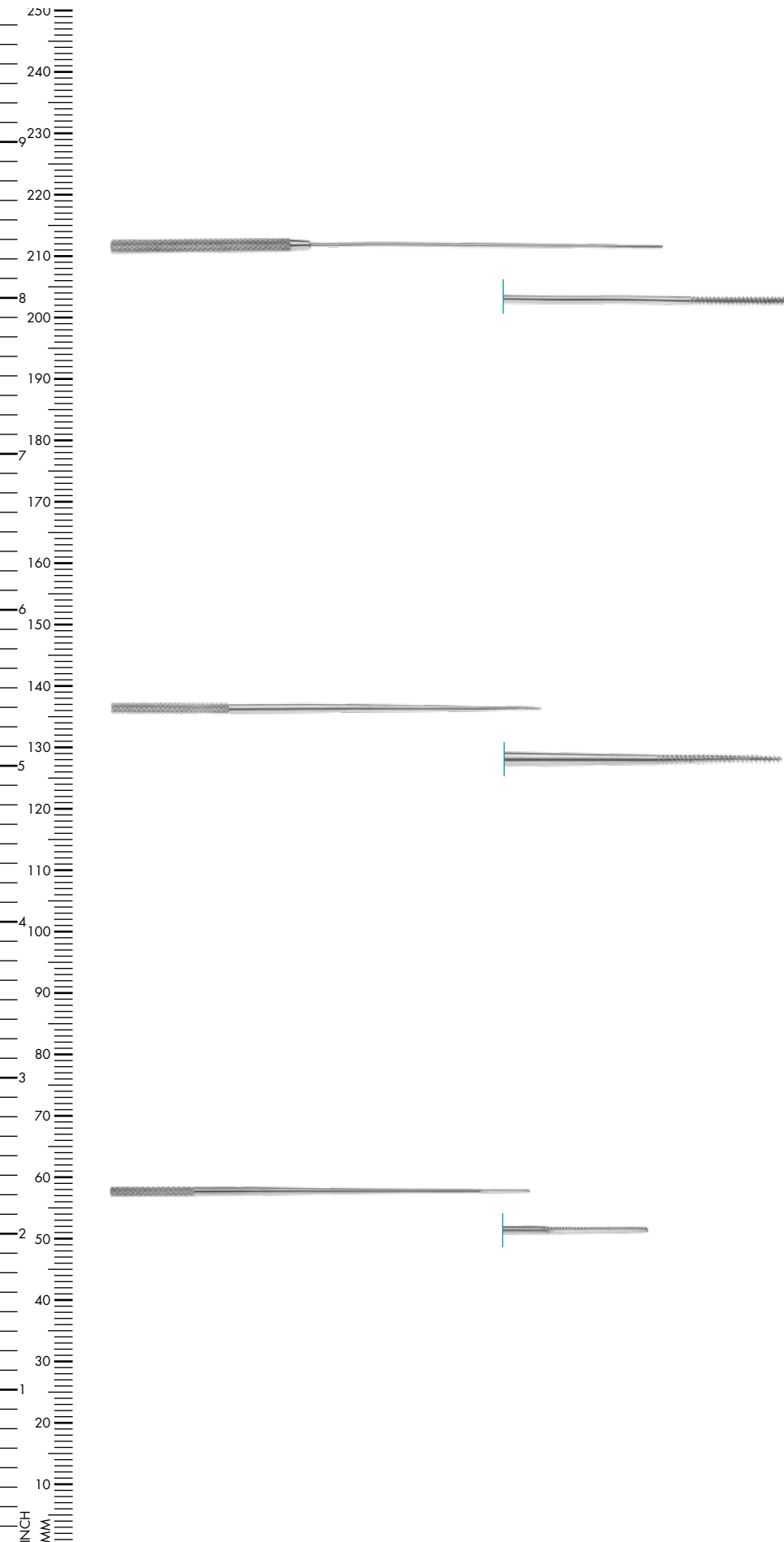

Cotton Applicator, rough spiral end
 \varnothing 1.5mm

180mm, 7"	160-412-180
-----------	-------------

FARRELL (LATHBURY UEBE)

Cotton Applicator, threaded, \varnothing 0.9mm

120mm, 4 ³ / ₄ "	160-420-120
--	-------------

140mm, 5 ¹ / ₂ "	160-420-140
--	-------------

\varnothing 1.2mm

180mm, 7"	160-420-180
-----------	-------------

FARRELL

Cotton Applicator, triangular, \varnothing 0.9mm

120mm, 4 ³ / ₄ "	160-426-120
--	-------------

140mm, 5 ¹ / ₂ "	160-426-140
--	-------------

\varnothing 1.2mm

180mm, 7"	160-426-180
-----------	-------------

230mm, 9"	160-426-230
-----------	-------------



REDON

Guide Needle Knife Tip, slightly curved,
with threaded end
195mm, 7²/₃"

8 Charr	165-200-080
10 Charr	165-200-100
12 Charr	165-200-120
14 Charr	165-200-140
16 Charr	165-200-160
18 Charr	165-200-180

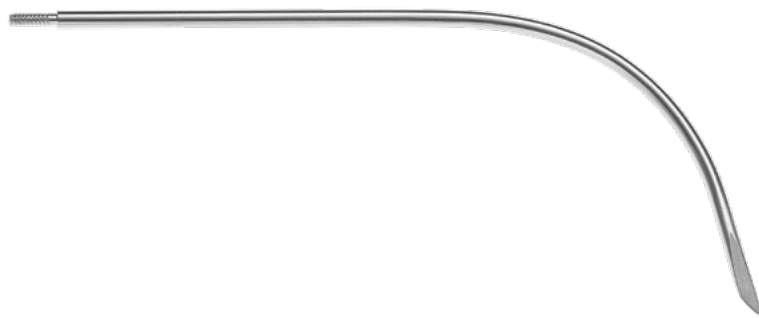

REDON

Guide Needle Knife Tip, curved,
with threaded end
195mm, 7²/₃"

8 Charr	165-202-080
10 Charr	165-202-100
12 Charr	165-202-120
14 Charr	165-202-140
16 Charr	165-202-160
18 Charr	165-202-180



REDON

Guide Needle, lancet tip, slightly curved,
with threaded end
185mm, 7¹/₄"

8 Charr	165-204-080
10 Charr	165-204-100
12 Charr	165-204-120
14 Charr	165-204-140
16 Charr	165-204-160

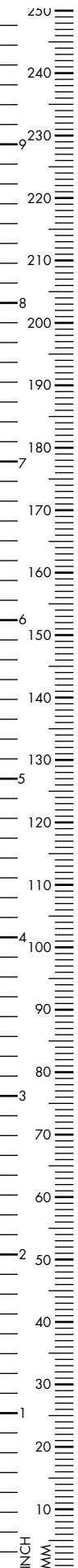

HEGENBARTH

Clip Applying Forceps

125mm, 5"

180-920-125



WACHENFELDT

Clip Applying Forceps

125mm, 5"

180-922-125



MICHEL

Clip Applying & Removal Forceps

120mm, 4³/₄"

180-916-120

**MICHEL**

Clip Removal Forceps

120mm, 4^{3/4}"

180-920-120

**RICHTER-HEATH**

Clip Removal Forceps

140mm, 5^{1/2}"

180-936-140

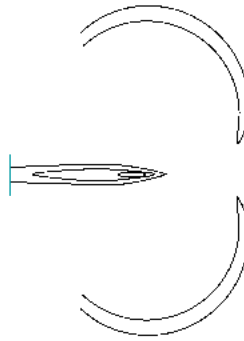
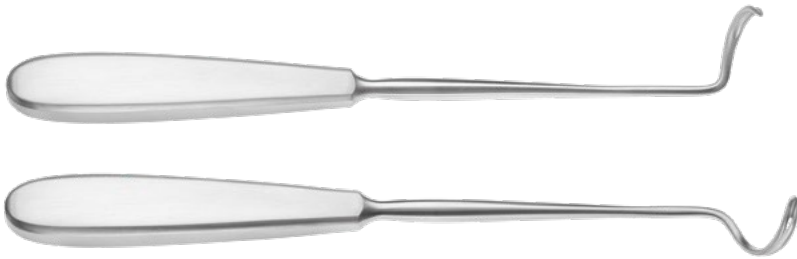
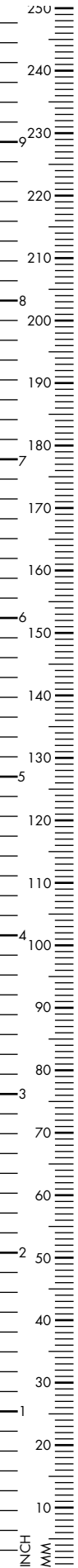

DESCHAMPS

Ligature Needles, sharp

left curved,
for right hand 180-724-200

right curved,
for left hand 180-728-200

blunt

left curved,
for right hand 180-726-210

right curved,
for left hand 180-727-210

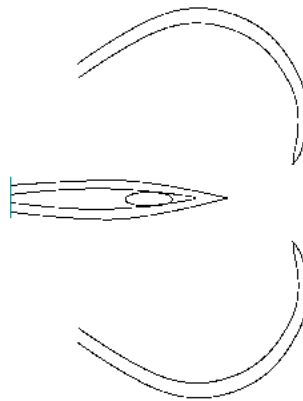
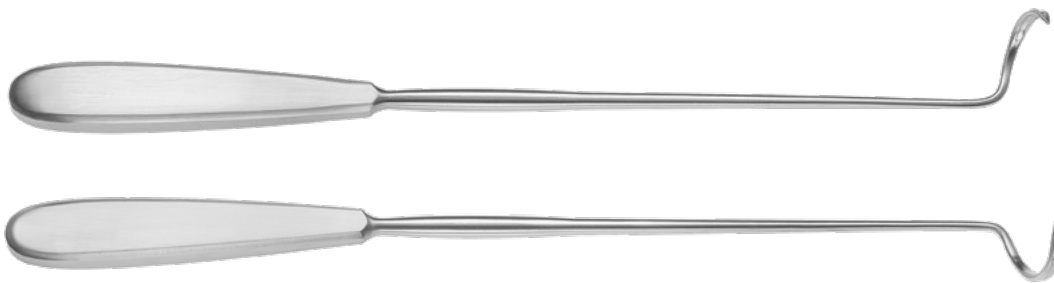

DESCHAMPS

Needle, left curved, sharp, for right hand

270mm, 10²/₃" 180-732-270

right curved, for left hand

270mm, 10²/₃" 180-733-270

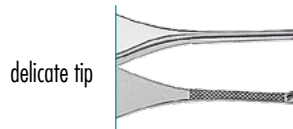
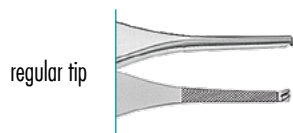

TC ADSON

Needle and Tissue Pulling Forceps, 1x2 teeth
regular tip, cross-serrated

120mm 4 ³ / ₄ "	130-534-120
---------------------------------------	-------------

150mm, 6"	130-534-150
-----------	-------------

delicate tip

120mm 4 ³ / ₄ "	130-537-120
---------------------------------------	-------------

150mm, 6"	130-537-150
-----------	-------------



TC ADSON BROWN

Forceps, 7x7 teeth, tying platform

120mm, 4 ³ / ₄ "	130-529-120
--	-------------

150mm, 6"	130-529-150
-----------	-------------



TC BONNEY

Needle and Tissue Pulling Forceps, 1x2 teeth,
british pattern

170mm, 6 ² / ₃ "	130-514-170
--	-------------

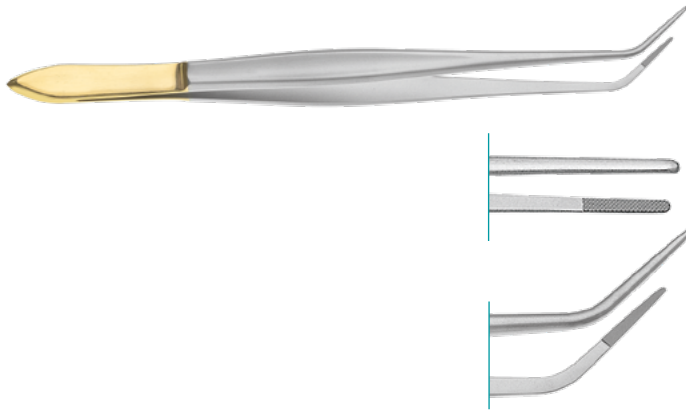
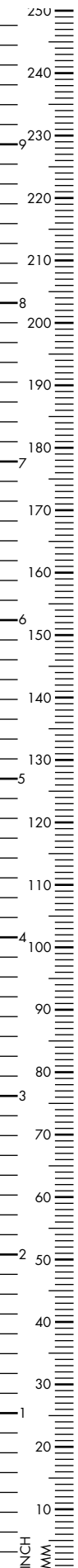

TC CUSHING

Needle and Tissue Pulling Forceps,
with scraper/dissector end, straight

180mm, 7"	130-536-175
-----------	-------------

angled

180mm 7"	130-539-180
----------	-------------



TC DEBAKEY

TC Atraumatic Forceps, 2.0mm wide

160mm, 6 ¹ / ₄ "	130-570-160
--	-------------

200mm, 8"	130-570-200
-----------	-------------

240mm, 9 ¹ / ₂ "	130-570-240
--	-------------



TC DEBAKEY

TC Atraumatic Forceps, 1.5mm wide

160mm, 6 ¹ / ₄ "	130-568-150
--	-------------

200mm, 8"	130-568-190
-----------	-------------

240mm, 9 ¹ / ₂ "	130-568-240
--	-------------

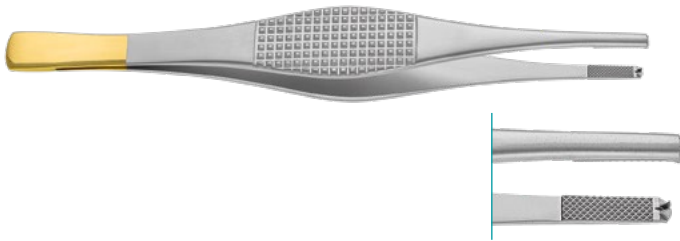

TC FERRIS SMITH

Needle and Tissue Pulling Forceps,
170mm, 6^{2/3}"

1x2 teeth	130-510-170
2x3 teeth	130-511-170

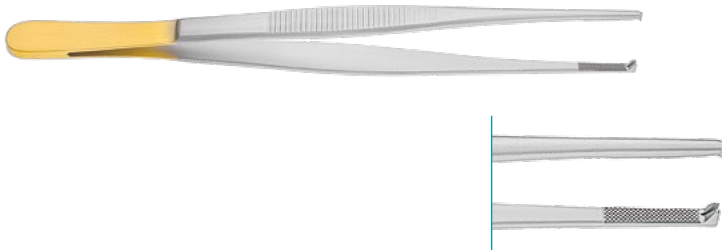

TC OEHLER

Needle and Tissue Pulling Forceps, 1x2 teeth

145mm, 5 ^{3/4} "	130-522-145
160mm, 6 ^{1/4} "	130-522-160
200mm, 8"	130-522-200
250mm, 9 ^{7/8} "	130-522-250



TC GERALD

Needle and Tissue Pulling Forceps, 1x2 teeth

170mm, 6 ^{2/3} "	130-518-170
---------------------------	-------------



TC SEMKEN

Needle and Tissue Pulling Forceps, 1x2 teeth

150mm, 6"	130-512-150
-----------	-------------

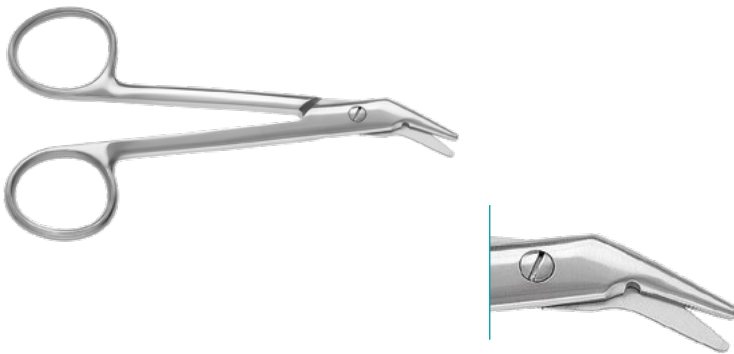

CUT 
 HARD max. 0.6mm
 SOFT max. 1.2mm

UNIVERSAL

Wire Suture Scissors, serrated blade

120mm, 4^{3/4}"

120-265-120

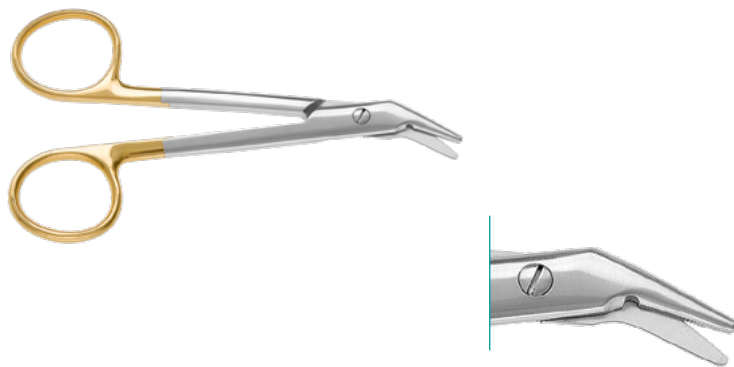

CUT 
 HARD max. 0.6mm
 SOFT max. 1.2mm

Universal Wire Scissors, one serrated blade,
 with TC inserts

120mm, 4^{3/4}"

120-565-120

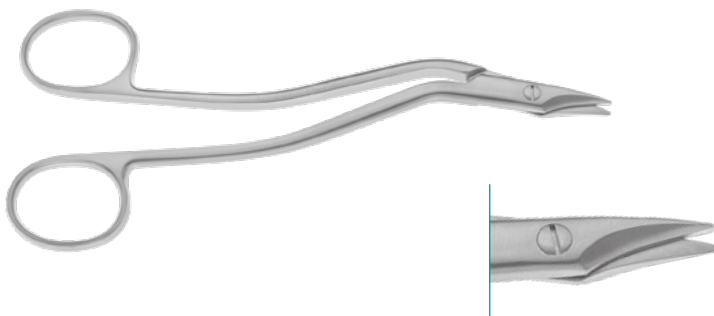

HEATH

Suture Scissors

160mm, 6^{1/4}"

120-226-160

250
240
230
220
210
200
190
180
170
160
150
140
130
120
110
100
90
80
70
60
50
40
30
20
10
0
INCH
MM



SPENCER

Suture Scissors

90mm, 3 ¹ / ₂ "	120-220-090
130mm, 5 ¹ / ₈ "	120-220-130



SHORTBENT

Suture Scissors

90mm, 3 ¹ / ₂ "	120-223-090
---------------------------------------	-------------



NORTHBENT

Suture Scissors

130mm, 5 ¹ / ₈ "	120-222-130
--	-------------

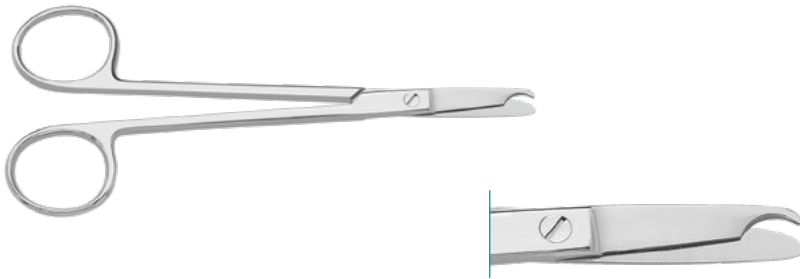

LITTAUER
Stitch Scissors

140mm, 5 ¹ / ₂ "	120-224-140
--	-------------



SPENCER
Suture Scissors

90mm, 3 ¹ / ₂ "	120-220-090
130mm, 5 ¹ / ₈ "	120-220-130

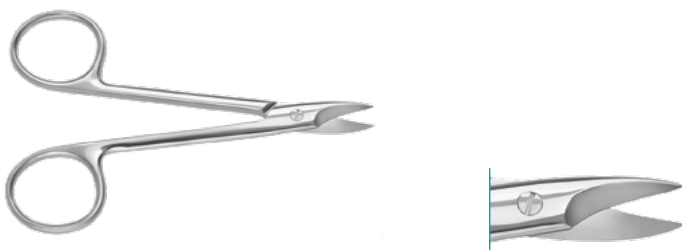

Suture Wire Scissors, serrated
straight

100mm, 4"	120-296-100
-----------	-------------

curved

100mm, 4"	120-297-100
-----------	-------------

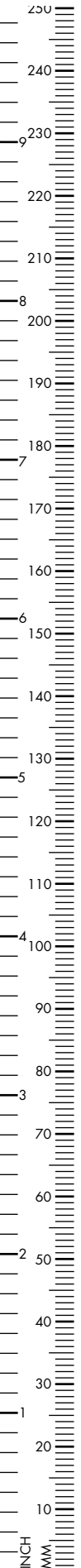

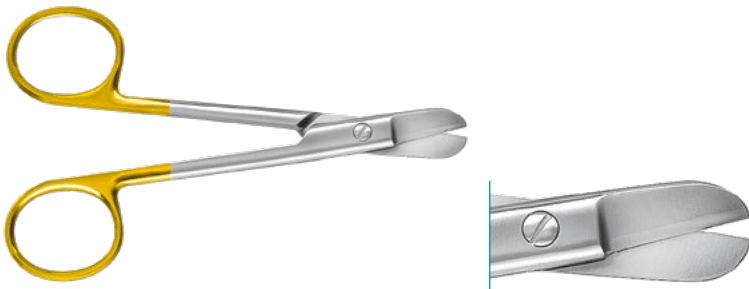

TC Plate Cutting Scissors

120mm, 4³/₄"

120-596-120

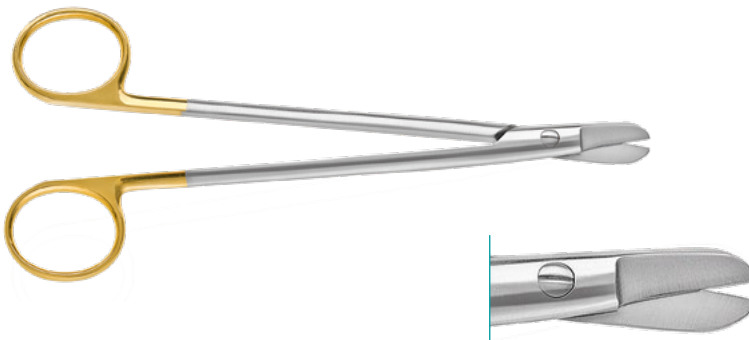

SMITH

TC Wire Scissors

160mm, 6¹/₄"

120-570-160



O'BRIEN

Ligature Scissors, angled blade

95mm, 3³/₄"

120-084-095

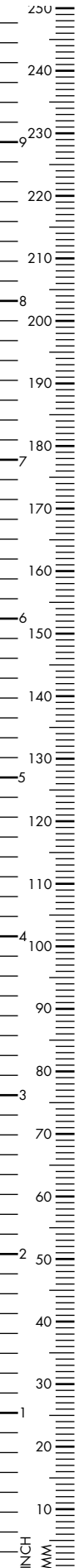

UNNA

Comedo Extractor, round cup, double-ended

140mm, 5¹/₂"

230-232-140



UNNA

Comedo Extractor, oval cup, double-ended

140mm, 5¹/₂"

230-230-140



WALTON

Comedo Extractor, with protection cup, double-ended

140mm, 5¹/₂"

230-240-140

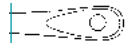

SAALFELD

Comedo Extractor, double-ended

100mm, 4"

230-239-100

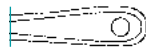
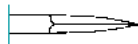

SAALFELD

Comedo Extractor, double-ended

140mm, 5^{1/2}"

230-236-140



SCHAMBERG

Comedo Extractor, double-ended

100mm, 4"

230-238-100

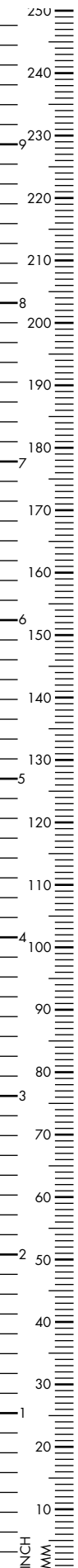

Spatula-Packer, double-ended

135mm, 5^{1/3}" 503-013-000



FROST

Elevator, single-ended

130mm, 5^{1/8}" 503-011-000



FOX

Lupus Curette, round, single-ended,

140mm, 5^{1/2}"

Ø 3mm 230-151-140

Ø 4mm 230-152-140

Ø 5mm 230-153-140

Ø 6mm 230-154-140

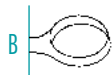
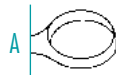

PIFFARD

Lupus Curette, 140mm, 5¹/₂"

A	230-155-001
A	230-155-002
C	230-155-003



KEYES

Dermal Punch Set

Dermal Punch Set	230-160-000
Dermal Punch 120mm, 4 ³ / ₄ "	
A Ø 2mm	230-160-002
B Ø 3mm	230-160-003
C Ø 4mm	230-160-004
D Ø 5mm	230-160-005
E Ø 6mm	230-160-006
F Ø 7mm	230-160-007
G Ø 8mm	230-160-008





Cuticle and Tissue Nipper, convex jaw

110mm, 4^{1/3}" 510-250-110

130mm, 5^{1/8}" 510-251-130



Nail Nipper, double spring, 140mm, 5^{1/2}"

Concave jaw 510-210-140



Nail Nipper, angled concave jaw, double spring

140mm, 5^{1/2}" 510-215-140

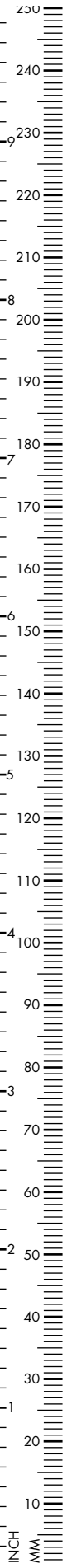

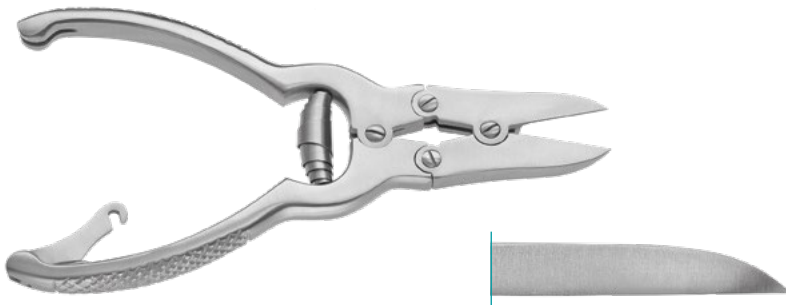

Mycotic Nail Nipper, straight,
heavy duty jaw, with lock, double action

160mm, 6¹/₄" 510-337-160

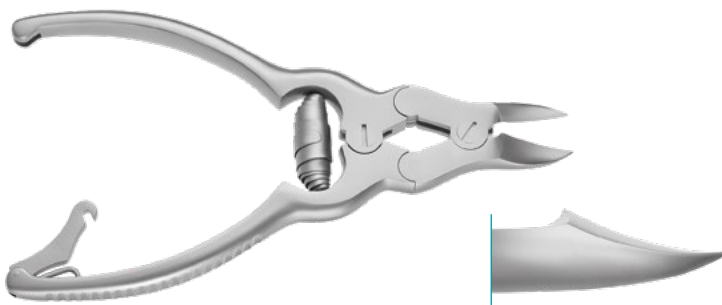

Mycotic Nail Nipper, concave,
heavy duty jaw, with lock, double action

150mm, 6" 510-338-150

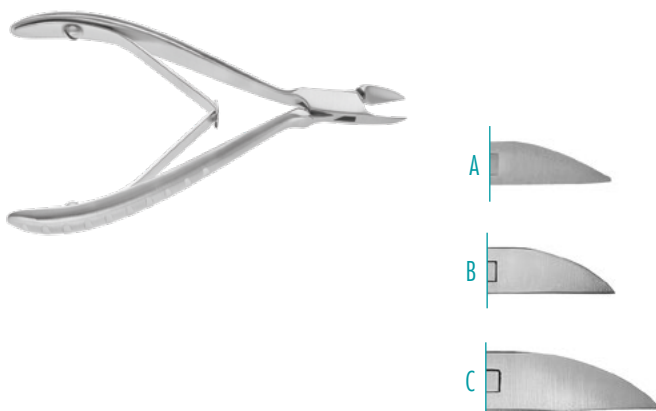

Nail Nipper, straight jaw, double spring

A 100mm, 4" 510-224-140

Delicate, straight jaw

B 110mm, 4¹/₃" 510-225-142

straight jaw

C 130mm, 5¹/₈" 510-226-140

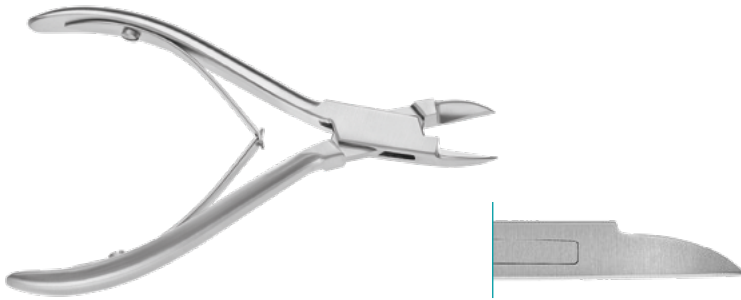

Nail Nipper, straight jaw

130mm, 5^{1/8}"

510-347-130



Nail Nipper, concave jaw,
spring handle with lock

150mm, 6"

510-332-150

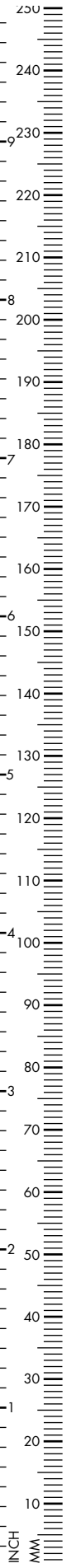



RADOLF

Nail Extraction Forceps, narrow jaw

140mm, 5¹/₂"

510-463-140



RADOLF

Nail Extraction Forceps, concave/convex jaw

135mm, 5¹/₃"

510-462-130



Nail Extraction Forceps, duck shaped jaw

140mm, 5¹/₂"

510-464-140



ANVIL

Nail Splitting Forceps

135mm, 5¹/₃" 510-334-140



Finger Ring Saw, replaceable circular blade

160mm, 6¹/₄" 210-975-170

Spare Blade 210-976-000



Mini Blade Handle, round blade socket,
for mini blades

130mm, 5¹/₈" 510-110-130

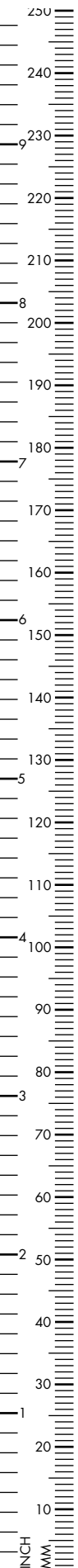



Nail Scissors, curved
90mm, 3¹/₂"

510-425-090



Ingrown Nail Splitting Scissors,
one blade serrated, straight

150mm, 6" 500-380-150

