

RETAINING RETRACTORS

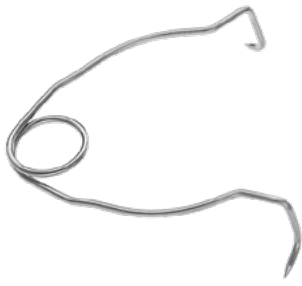

Spring Wire Retractors
Small Self Retaining Retractors
Self Retaining Retractors
Abdominal Self Retaining Retractors
Ring Retractors

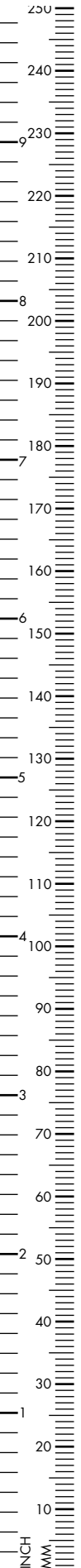

FARR

10mm, sharp

38mm, 1¹/₂"

170-710-038

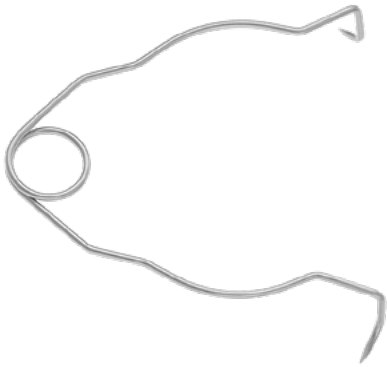

FARR

11mm, sharp

50mm, 2"

58mm, 2¹/₄"

64mm, 2¹/₂"

75mm, 3"

170-710-050

170-710-058

170-710-064

170-710-075

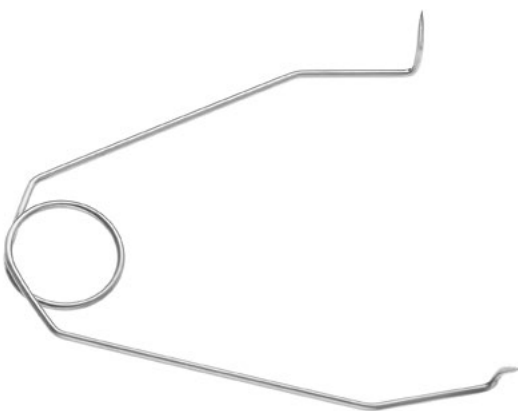

FARR

20mm, sharp

140mm, 5¹/₂"

30mm, sharp

140mm, 5¹/₂"

170-711-140

170-712-140



FARR

12mm flat blades

64mm, 2¹/₂" 170-712-064

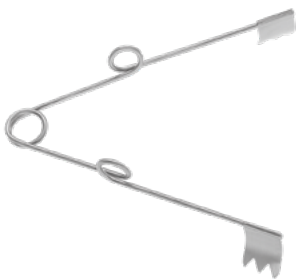

Spring Wire Retractor, 10.5mm sharp points

75mm, 3" 170-100-075

11x15.5mm flat blades

90mm, 3¹/₂" 170-100-090

15.5x20.5mm flat blades

115mm, 4¹/₂" 170-100-115



FINSEN

Spring Retractor, 2x3 teeth, 50mm, 2"

sharp 170-700-050

blunt 170-701-050

3x4 teeth, 70mm, 2³/₄"

sharp 170-702-070

blunt 170-703-070

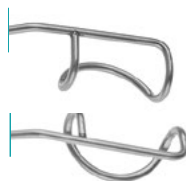

BARRAQUER

Eye Specula

Children, 10mm blade 400-500-030

Adult, 40mm blade 400-500-040

1mm wire thickness

Adult, 40mm blade 400-500-045

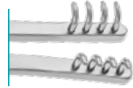

ALM

4x4 teeth, 70mm, 2³/₄"

sharp 170-714-070

blunt 170-715-070

100mm, 4"

sharp 170-714-100

blunt 170-715-100



HOLZHEIMER

Skin Retractor, 4 prongs,
8mm wide, 5mm deep, 100mm, 4"

blunt 170-109-001

sharp 170-109-002

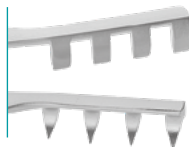

ALLPORT

4x4 prongs, sharp

95mm, 3³/₄" 170-719-095

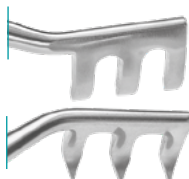

JANSEN

3x3 prongs, 100mm, 4"

sharp 170-720-100

blunt 170-723-100

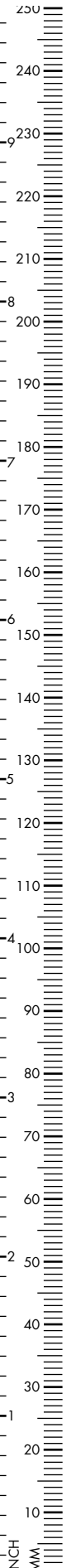



BABY WEITLANER

2x3 teeth, 105mm, 4¹/₈"

sharp 170-748-105

115mm, 4¹/₂"

blunt 170-749-105

semi-sharp 170-750-105

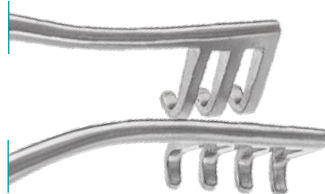

WULLSTEIN

3x4 teeth, curved arms, 105mm, 4¹/₈"

sharp 170-742-105

blunt 170-743-105

130mm, 5¹/₈"

sharp 170-742-130

blunt 170-743-130

150mm, 6"

sharp 170-742-150

blunt 170-743-150

180mm, 7"

sharp 170-742-180

blunt 170-743-180

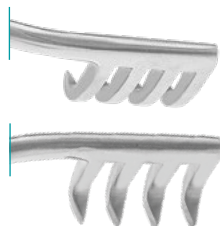

MOLLISON

4x4 teeth, curved arms, sharp

155mm, 6¹/₈" 170-754-155

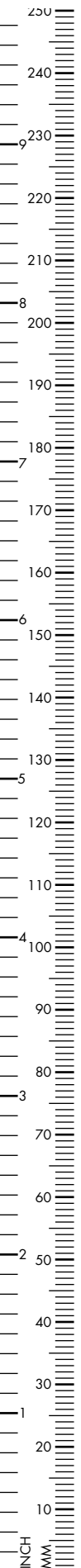

WEITLANER

3x4 teeth, sharp

130mm, 5 ¹ / ₈ "	170-750-130
165mm, 6 ¹ / ₂ "	170-750-165
200mm, 8"	170-750-200
240mm, 9 ¹ / ₂ "	170-750-240

blunt

130mm, 5 ¹ / ₈ "	170-751-130
165mm, 6 ¹ / ₂ "	170-751-165
200mm, 8"	170-751-200
240mm, 9 ¹ / ₂ "	170-751-240



WEITLANER BECKMANN

3x4 teeth, hinged arms, sharp

140mm, 5 ¹ / ₂ "	170-746-140
160mm, 6 ¹ / ₄ "	170-746-160
200mm, 8"	170-746-200
240mm, 9 ¹ / ₂ "	170-746-240

blunt

140mm, 5 ¹ / ₂ "	170-747-140
160mm, 6 ¹ / ₄ "	170-747-160
200mm, 8"	170-747-200
240mm, 9 ¹ / ₂ "	170-747-240



ADSON

4x4 teeth, straight arms, 200mm, 8"

blunt	170-730-200
sharp	170-731-200



ADSON ANDERSON

4x4 teeth, curved arms, 195mm, 7³/₄"

sharp 170-732-200

blunt 170-733-200



ADSON

3x4 teeth, curved arms

265mm, 10¹/₂" 170-730-265



ADSON

3x4 teeth, hinged arms, 200mm, 8"

sharp 170-795-200

blunt 170-794-200

240mm, 9¹/₂"

sharp 170-795-260

blunt 170-794-260

RETAINING RETRACTORS

Self Retaining Retractors



CONE

3x4 teeth, sharp

130mm, 5 ¹ / ₈ "	170-781-130
160mm, 6 ¹ / ₄ "	170-781-160
200mm, 8"	170-781-200
240mm, 9 ¹ / ₂ "	170-781-240

blunt

130mm, 5 ¹ / ₈ "	170-782-130
160mm, 6 ¹ / ₄ "	170-782-160
200mm, 8"	170-782-200
240mm, 9 ¹ / ₂ "	170-782-240

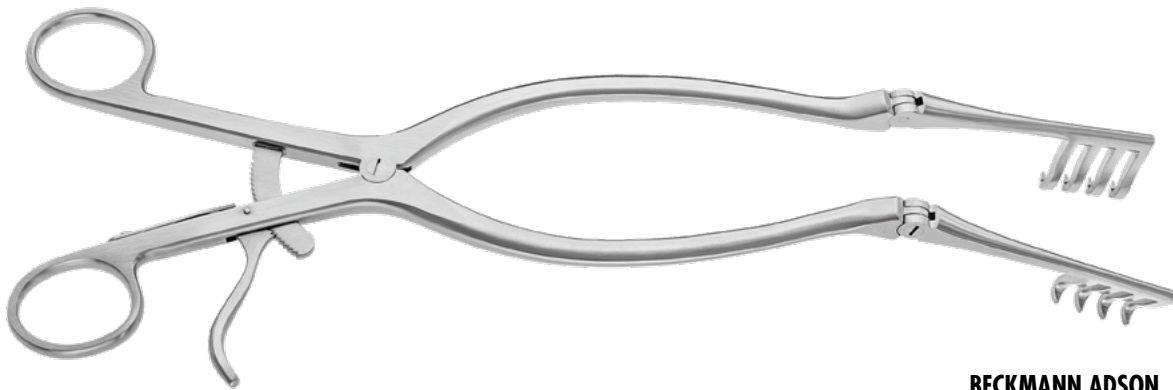

BECKMANN ADSON

4x4 teeth, hinged arms, 310mm, 12¹/₄"
short sharp teeth

25x25mm	170-786-001
---------	-------------

short blunt teeth

25x25mm	170-786-000
---------	-------------

long sharp teeth

25x45mm	170-786-002
---------	-------------

long blunt teeth

25x45mm	170-786-003
---------	-------------

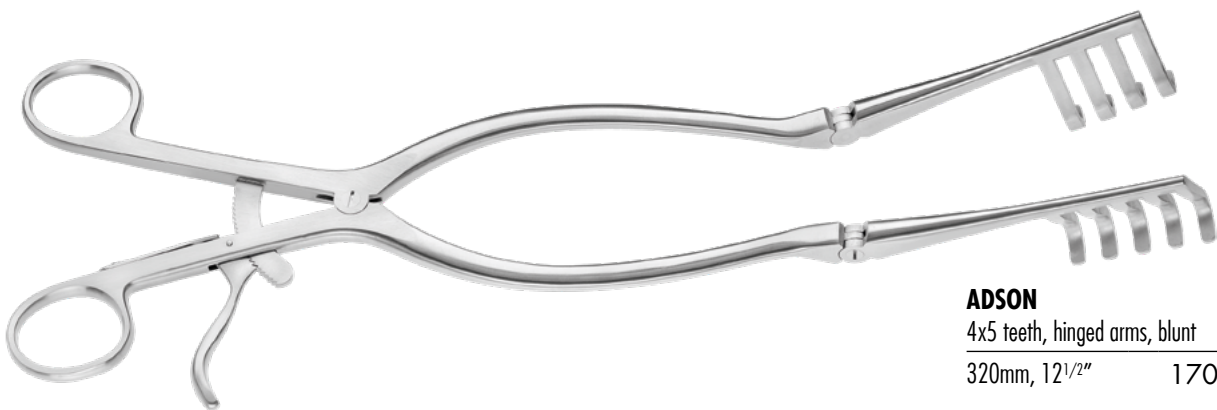

ADSON

4x5 teeth, hinged arms, blunt

320mm, 12 ¹ / ₂ "	170-784-320
---	-------------

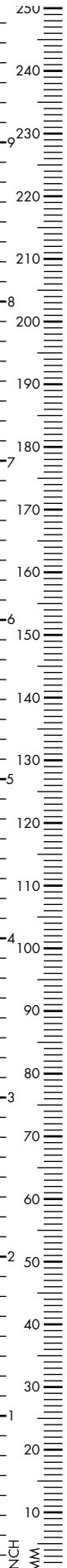

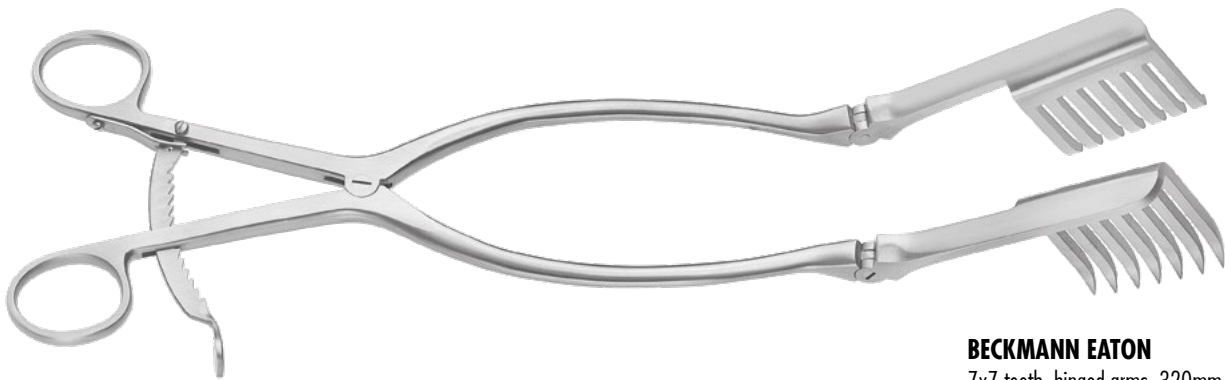

BECKMANN EATON

7x7 teeth, hinged arms, 320mm, 12^{1/2}"

sharp 170-788-320

blunt 170-789-320



MISKIMON

Retractor, 7x7 teeth, 220mm, 8^{2/3}"

sharp 170-738-220

blunt 170-739-220



MEYERDING

Laminectomy Retractor, 200mm, 8"

25x32mm blade	170-791-001
25x54mm blade	170-791-002
19x60mm blade	170-791-003
25x60mm blade	170-791-004



MEYERDING HEMI

Laminectomy Retractor, 180mm, 7"

10mm wide blade, solid blade left

50mm	170-792-001
60mm	170-792-002
70mm	170-792-006

solid blade right

50mm	170-793-001
60mm	170-793-008
70mm	170-793-007

20mm wide blade, solid blade left

50mm	170-792-004
60mm	170-792-003
70mm	170-792-005

solid blade right

50mm	170-793-004
60mm	170-793-005
70mm	170-793-002



MARKHAM MEYERDING

Laminectomy Retractor, 165mm, 6¹/₂"

solid blade right

10x65mm	170-790-006
25x65mm	170-790-007

solid blade left

10x65mm	170-790-005
25x65mm	170-790-008

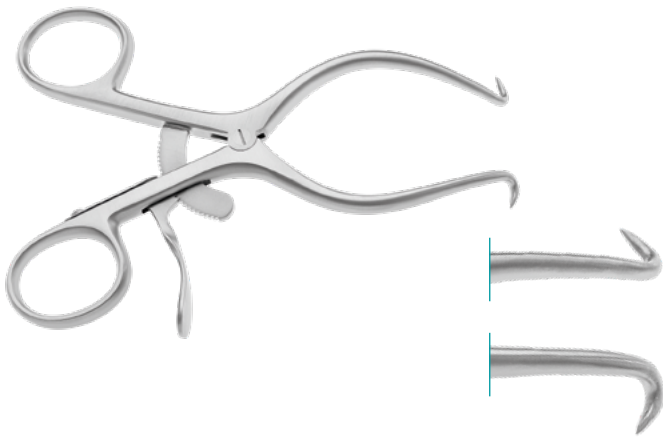

GELPI

Perineal Retractor, pediatric size

90mm, 3 ¹ / ₂ "	170-802-090
110mm, 4 ¹ / ₃ "	170-802-110
135mm, 5 ¹ / ₃ "	170-802-135

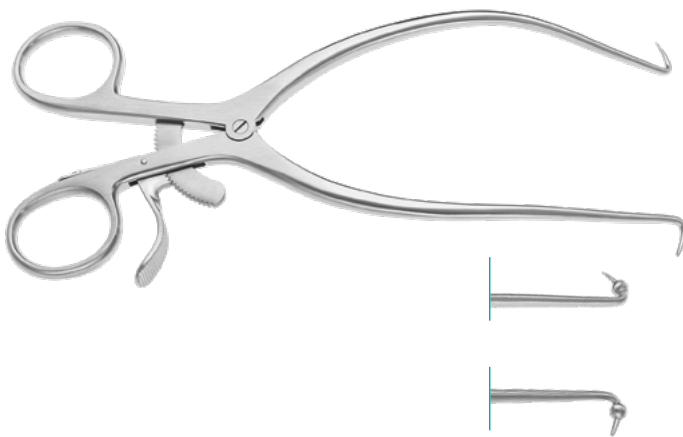

GELPI

Perineal Retractor

180mm, 7"	170-802-180
with ball stops	
190mm, 7 ¹ / ₂ "	170-803-180



DEBAKEY

sharp

100mm, 4"	170-745-100
170mm, 6 ² / ₃ "	170-745-170



JOHNSON

Neuroma Retractor, 90° angled, 7.5mm tip

85mm, 3 ¹ / ₄ "	170-801-085
100mm, 4"	170-801-100



KÖLBL

Skin and Tissue Spreader, blunt tip, straight shaft

1x1 teeth 259-257-016

angled shaft

1x1 teeth 259-257-009

2x2 teeth 259-257-006



KÖLBL

Capsule Retractor, blunt tip, 90° curved

1x1 teeth 259-257-007



BANKHART

Rotator Retractor, 190mm, 7¹/₂"

ring left side 210-905-190

ring right side 210-907-190

250mm, 9⁷/₈"

ring left side 210-905-250

ring right side 210-907-250



KÖLBEL

Retractor, slightly angled

200mm, 8" 259-257-002

Single Blade

36 x 36mm 259-257-003

53 x 36mm 259-257-004

68 x 36mm 259-257-005

36 x 20mm 259-257-013

53 x 20mm 259-257-014

68 x 20mm 259-257-015

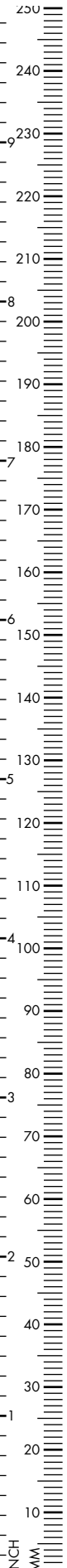



MAYO ADAMS

Retractor Set, removable center blade,
170mm, 6²/₃"

complete set	170-815-170
spreader only	170-815-000
center blade only	170-815-100

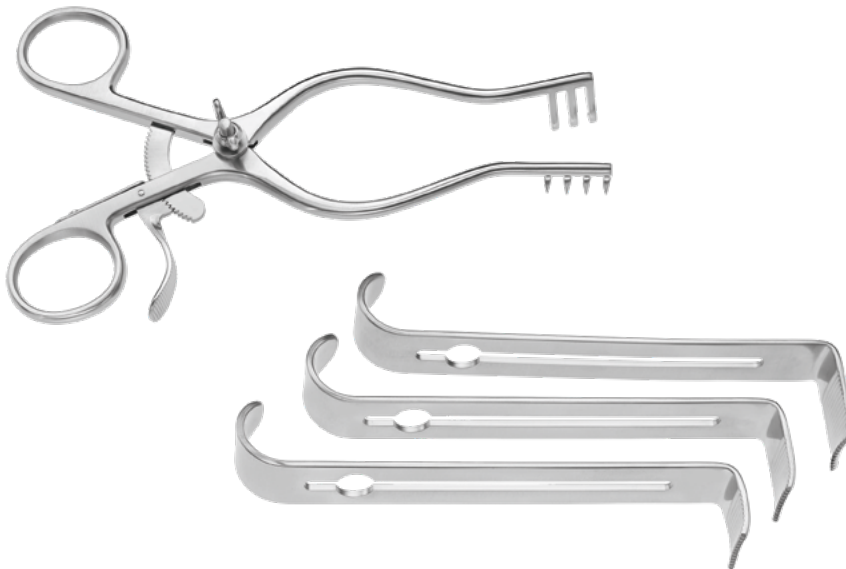

HENLEY

Retractor Set, removable center blade,
160mm, 6¹/₄", sharp/sharp

complete set	170-769-160
--------------	-------------

blunt/blunt

complete set	170-770-160
--------------	-------------

Blades

19x16mm	170-771-001
25x16mm	170-771-002
32x16mm	170-771-003



COLLIN BABY

Abdominal Retractor with 2 pairs of valves
30 x 44mm and 23 x 44mm

180mm, 7"	170-819-000
-----------	-------------

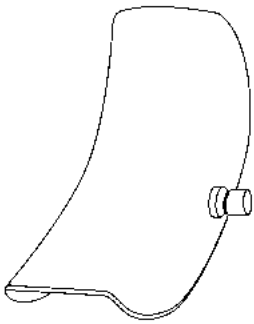

A

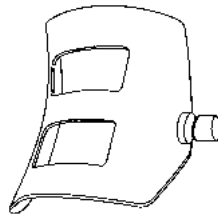

B



COLLIN

Abdominal Retractor,
120mm, 4^{3/4}" spreading, complete with lateral
and centre blades

lateral: 38 x 62mm	170-823-000
centre: 55 x 55mm	

lateral: 40 x 80mm	170-824-000
centre: 55 x 65mm	

lateral: 60 x 80mm	170-825-000
centre: 60 x 75mm	

without centre blade

lateral: 38 x 62mm	170-821-000
--------------------	-------------

A Blade, ball snap closure

40 x 80mm	170-839-040
-----------	-------------

B Blade, ball snap closure

60 x 80mm	170-834-060
-----------	-------------

RICHARD

Abdominal Retractor,
280mm, 11" spreading, complete with lateral
and centre blades

lateral: 72 x 85mm	170-827-000
centre: 80 x 90mm	

300mm, 11^{7/8}" spreading

lateral: 60 x 80mm	170-829-000
centre: 55 x 70mm	



GOSSET

Abdominal Retractor
100mm wide, 26 x 39mm blades

170-818-100

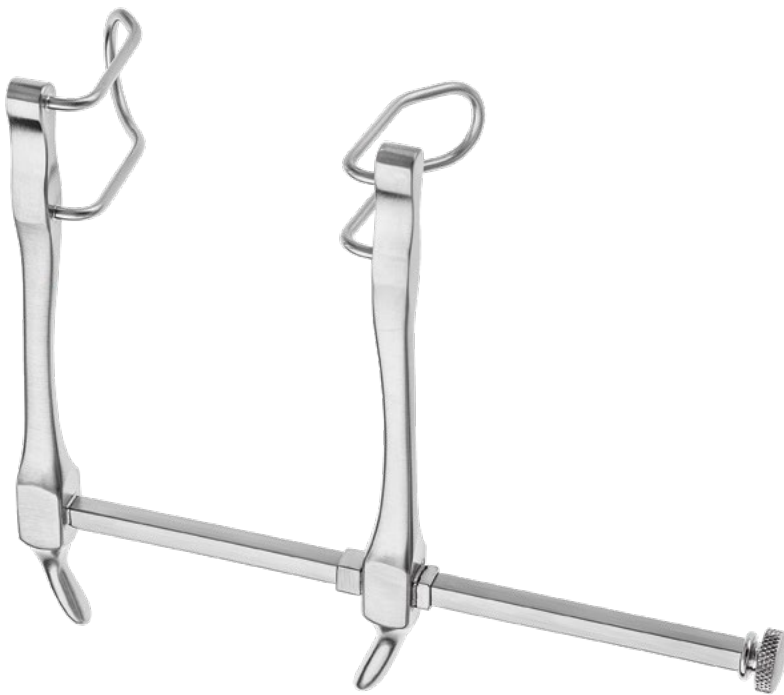
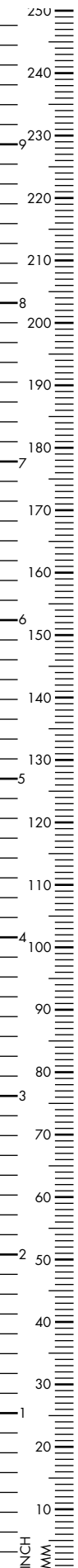

GOSSET

Abdominal Retractor
120mm wide, 30 x 40mm blades

170-818-120

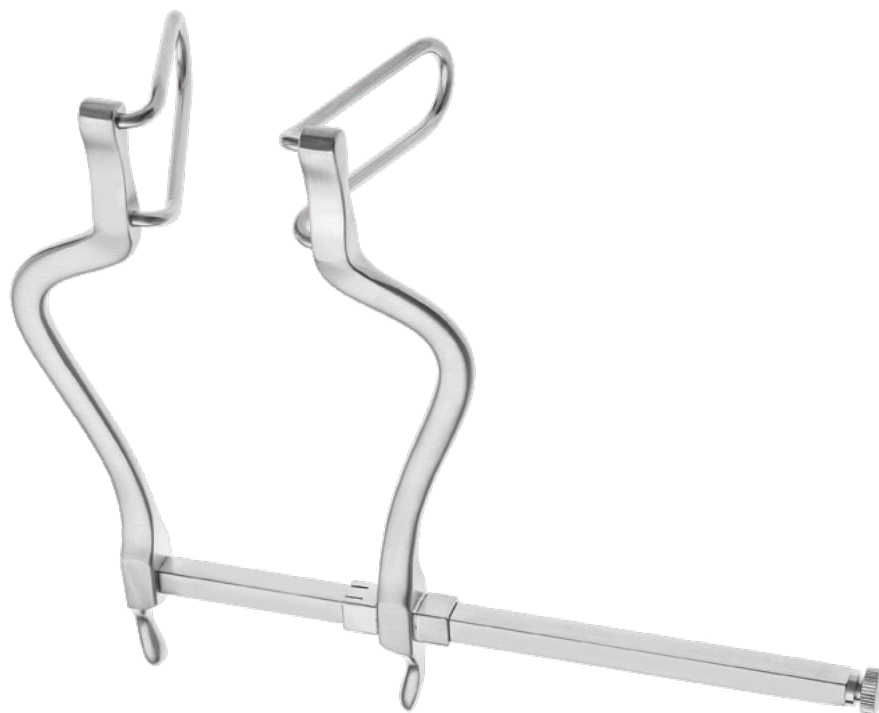

GOSSET

Abdominal Retractor
140mm wide, 26 x 64mm blades

170-818-140



GOSSET

Abdominal Retractor
160mm wide, 56 x 60mm blades

170-818-160

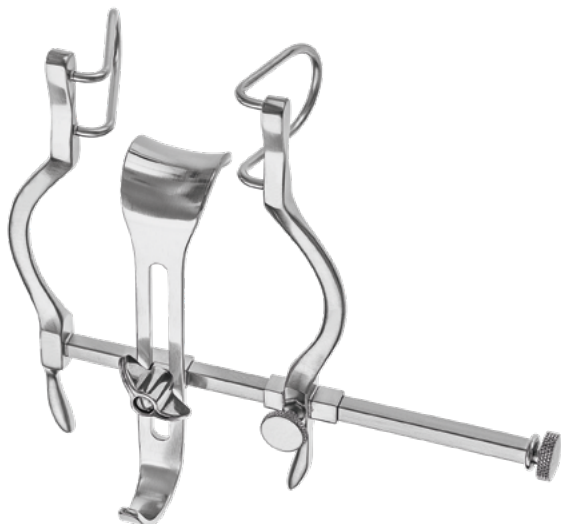

BALFOUR BABY

Abdominal Retractor
95mm wide, 2 lateral blades: 38mm
center blade: 23 x 25mm

170-766-090

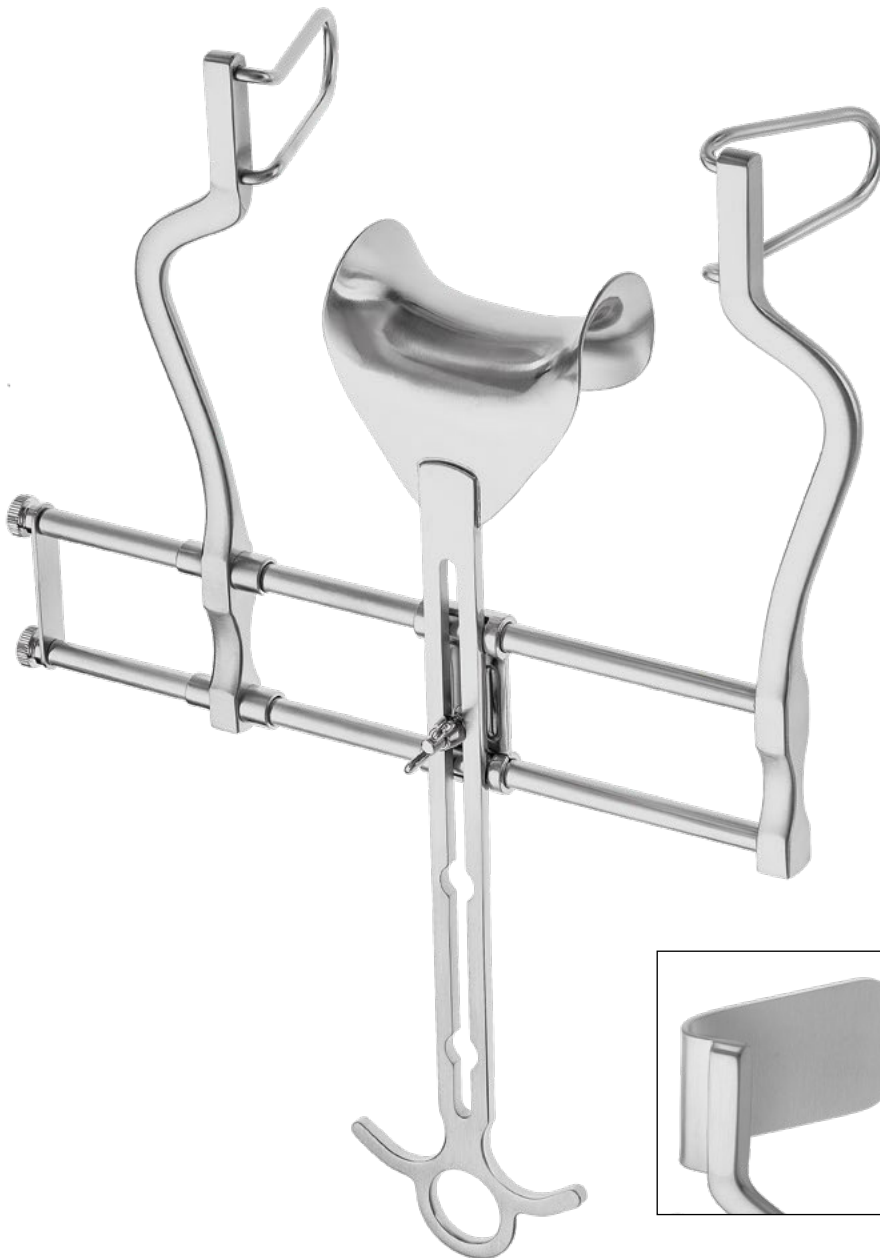

BALFOUR

Abdominal Retractor, 180mm spread width,
lateral wire blades: 50mm

75 x 50mm	170-852-050
-----------	-------------

lateral blades: 63mm

75 x 50mm	170-852-000
-----------	-------------

lateral blades: 100mm

85 x 70mm	170-852-100
-----------	-------------

BALFOUR

Abdominal Retractor, 180mm spread width,
lateral solid blades: 50mm

75 x 50mm	170-854-000
-----------	-------------

lateral blades: 70mm

75 x 50mm	170-854-070
-----------	-------------

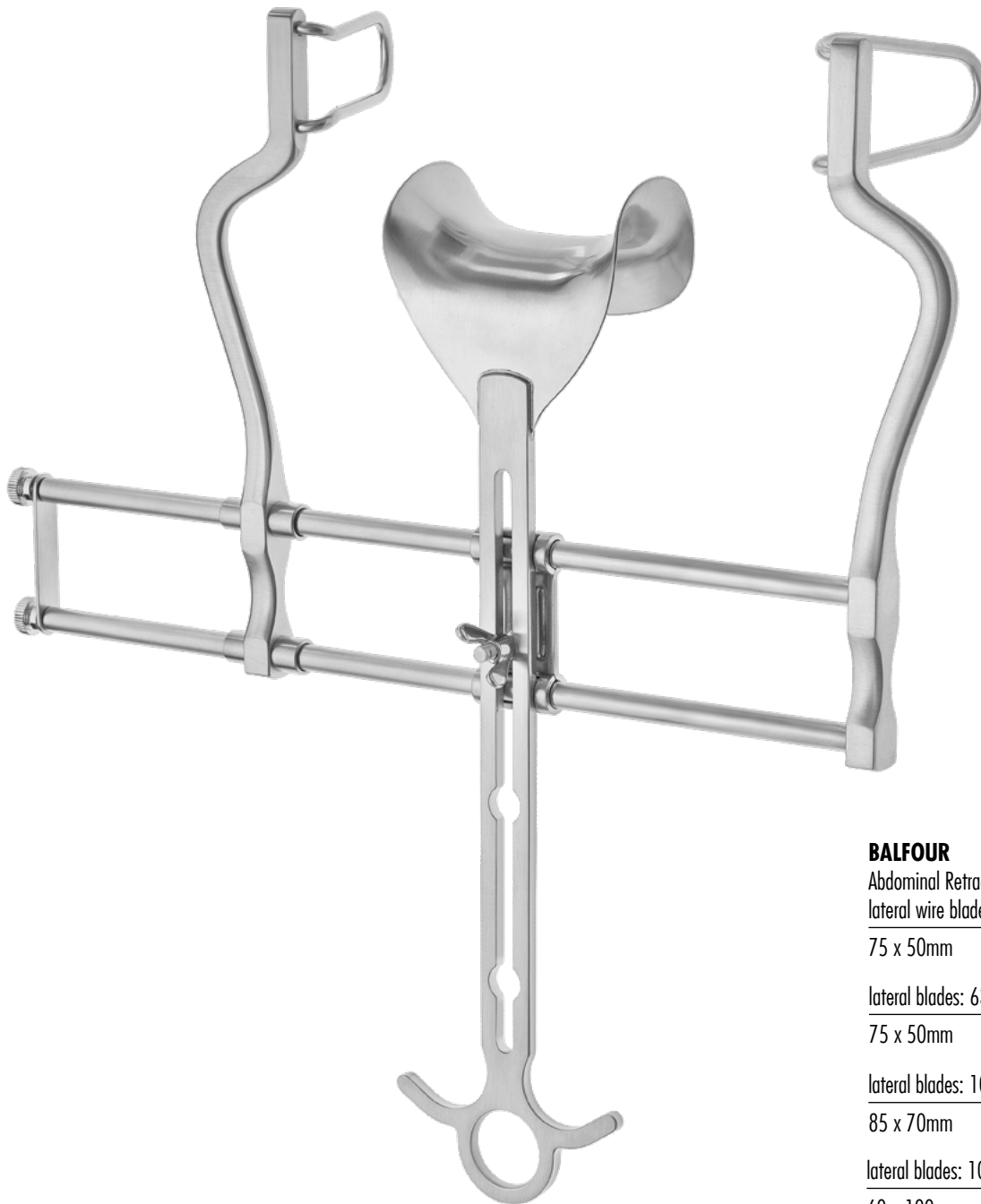

BALFOUR

Abdominal Retractor, 250mm spread width,
lateral wire blades: 50mm

75 x 50mm	170-840-050
-----------	-------------

lateral blades: 63mm

75 x 50mm	170-840-063
-----------	-------------

lateral blades: 100mm

85 x 70mm	170-840-000
-----------	-------------

lateral blades: 100mm

60 x 100mm	170-840-100
------------	-------------



BALFOUR US

Abdominal Retractor Set, 180mm spread width

Set 170-860-180

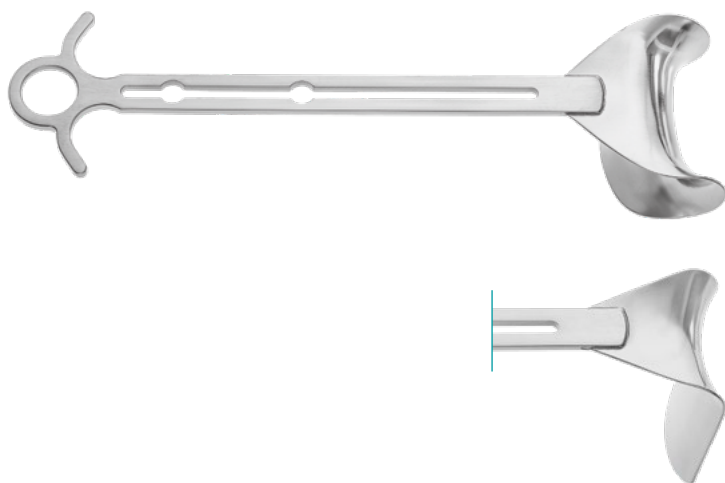

BALFOUR US

Centre Blades, round (W x D)

68 x 40mm	170-863-001
75 x 50mm	170-863-002
85 x 70mm	170-863-003
93 x 44mm	170-863-004

angular

60 x 100mm	170-863-005
70 x 100mm	170-863-006



Lateral Blades Pair

50mm depth	170-860-030
70mm depth	170-860-035
100mm depth	170-860-045



BALFOUR HORGAN

Central Blade, malleable

50 x 198mm	170-863-007
50 x 127mm	170-863-008

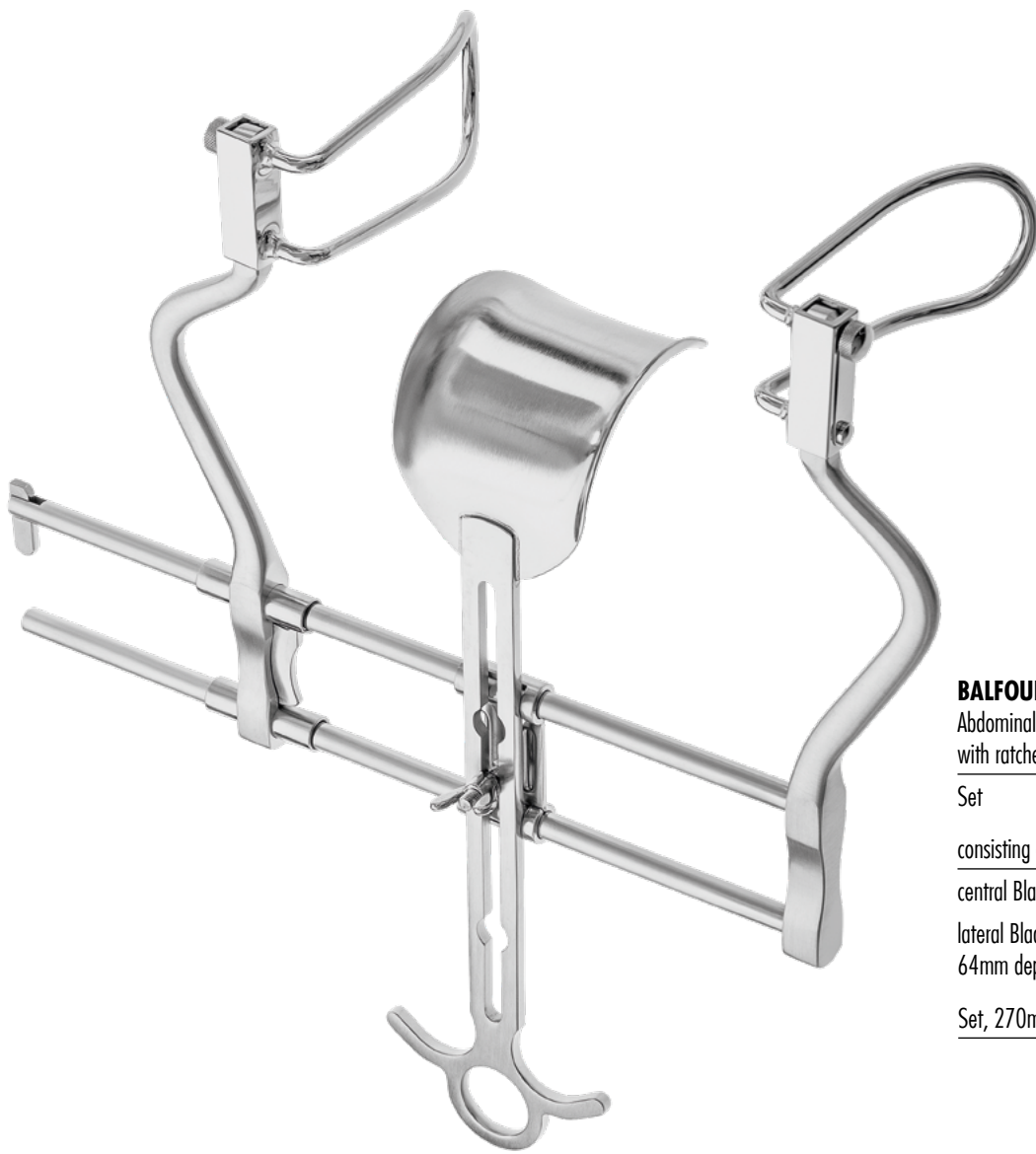

BALFOUR

Abdominal Retractor Set, 200mm spread width,
with ratchet bar positioning system

Set	170-865-200
-----	-------------

consisting of:

central Blade	170-865-001
---------------	-------------

lateral Blade, 64mm depth	170-865-008
------------------------------	-------------

Set, 270mm spread width	170-865-270
-------------------------	-------------

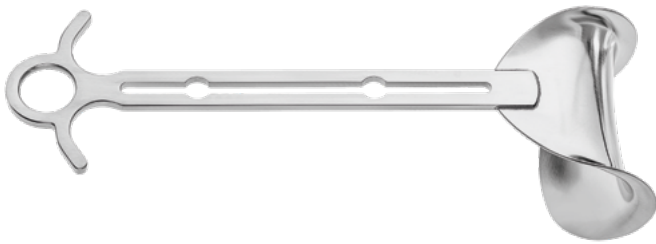

BALFOUR RSC

Central Blade

64 x 64mm	170-865-001
85 x 70mm	170-865-002
93 x 44mm	170-865-003
64 x 44mm	170-865-004



BALFOUR RSC

Central Blade, malleable

51 x 198mm	170-865-005
51 x 171mm	170-865-006
57 x 267mm	170-865-007



BALFOUR RSC

Lateral Blade, fenestrated

64mm	170-865-008
89mm	170-865-009
100mm	170-865-010



BALFOUR

Lateral Blade, closed

64mm	170-865-011
89mm	170-865-012
100mm	170-865-013



BALFOUR EXTENSION ARM

Side Arm

left	170-861-101
right	170-861-100



O'SULLIVAN O'CONNOR

Abdominal Retractor Set with blades

1x 70 x 110mm, 2x 80 x 45mm

170-868-000

Blades

80 x 45mm

170-868-001

70 x 110mm

170-868-002



O'SULLIVAN O'CONNOR

Vaginal Retractor Set with blades

1x 44 x 89mm, 1x 38 x 89mm,

1x 13 x 47mm

170-868-100

Blades

44 x 89mm

170-868-101

38 x 89mm

170-868-102

13 x 47mm

170-868-103

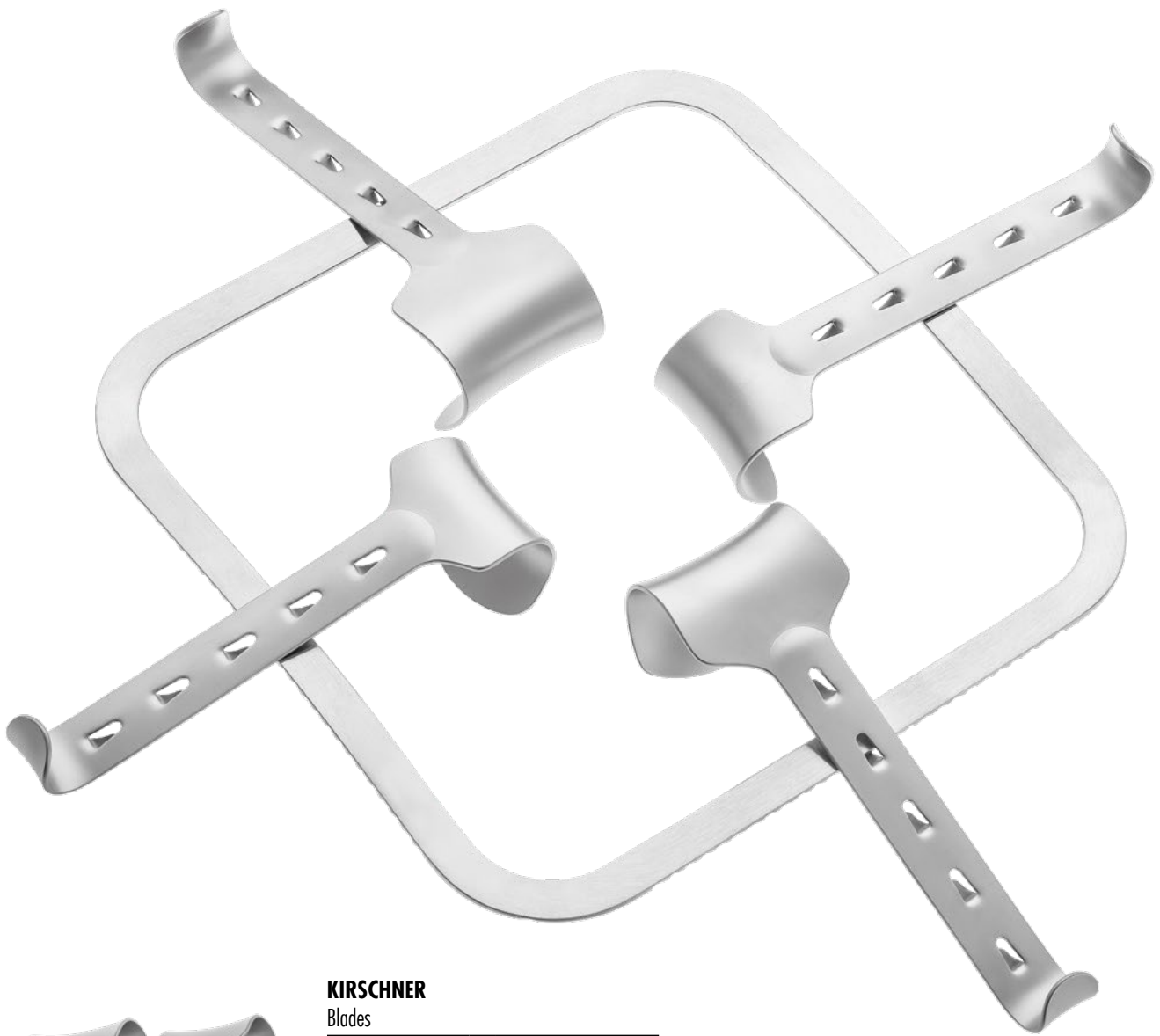

KIRSCHNER

Blades

55 x 40mm	170-889-040
65 x 50mm	170-889-050
85 x 60mm	170-889-060
65 x 78mm	170-889-075
90 x 80mm	170-889-086

Retractor Hook-on

78 x 65mm	170-889-078
80 x 90mm	170-889-080
98 x 50mm	170-889-098
105 x 35mm	170-889-099

Frame

240 x 240mm	170-884-024
-------------	-------------

KIRSCHNER

Abdominal Retractor Set, square
consists of:

Frame 240 x 240 mm,
2 blades 50 x 65mm
2 blades 65 x 50mm

170-884-000

Frame 270 x 270 mm,
2 blades 55 x 40mm
2 blades 65 x 50mm

170-886-000

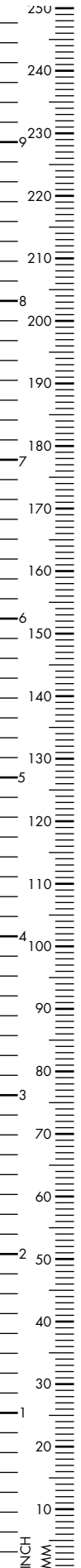

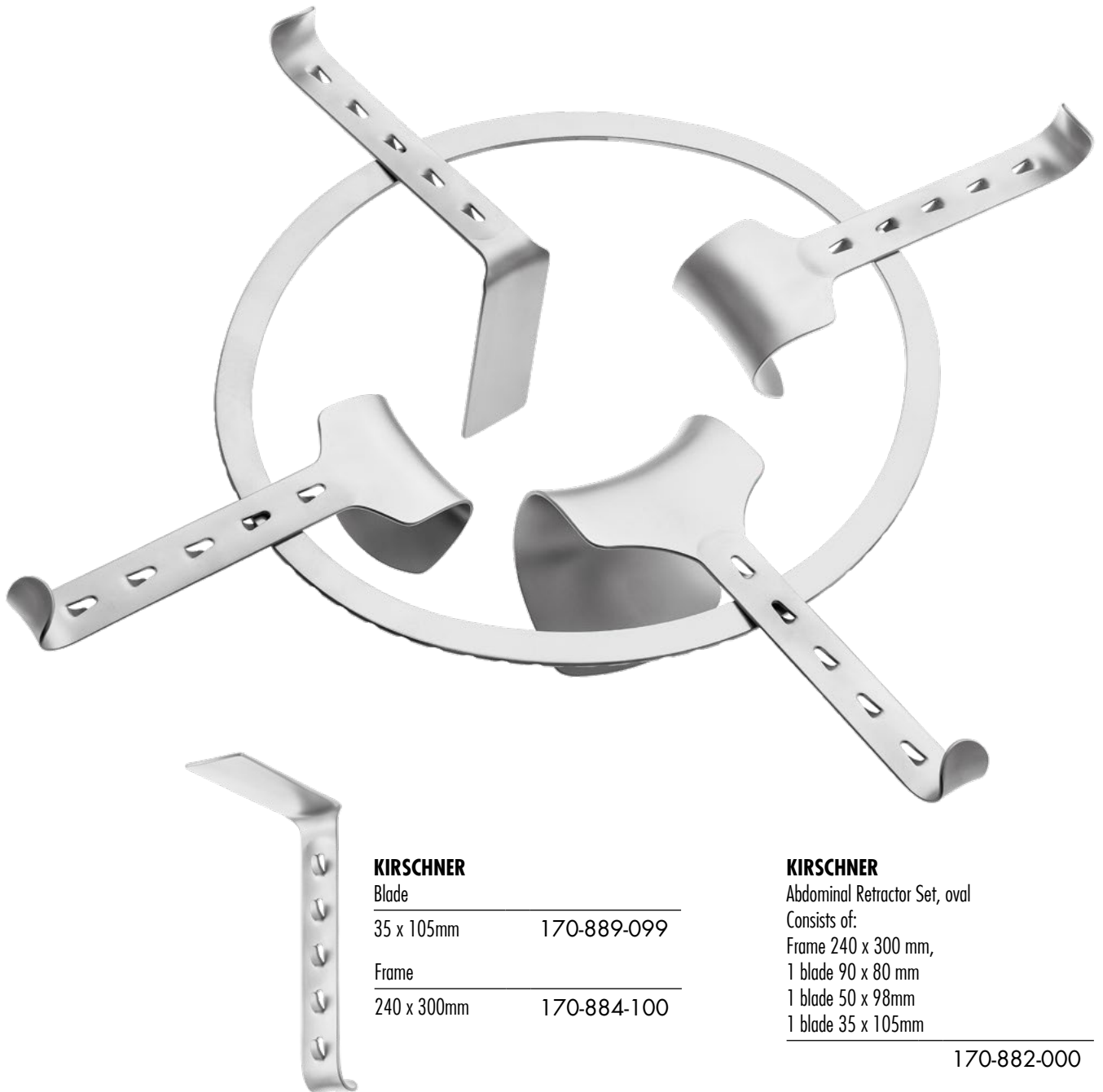

KIRSCHNER

Blade

35 x 105mm	170-889-099
------------	-------------

Frame

240 x 300mm	170-884-100
-------------	-------------

KIRSCHNER

Abdominal Retractor Set, oval

Consists of:

Frame 240 x 300 mm,

1 blade 90 x 80 mm

1 blade 50 x 98mm

1 blade 35 x 105mm

170-882-000

GENUINE RING RETRACTOR SETS

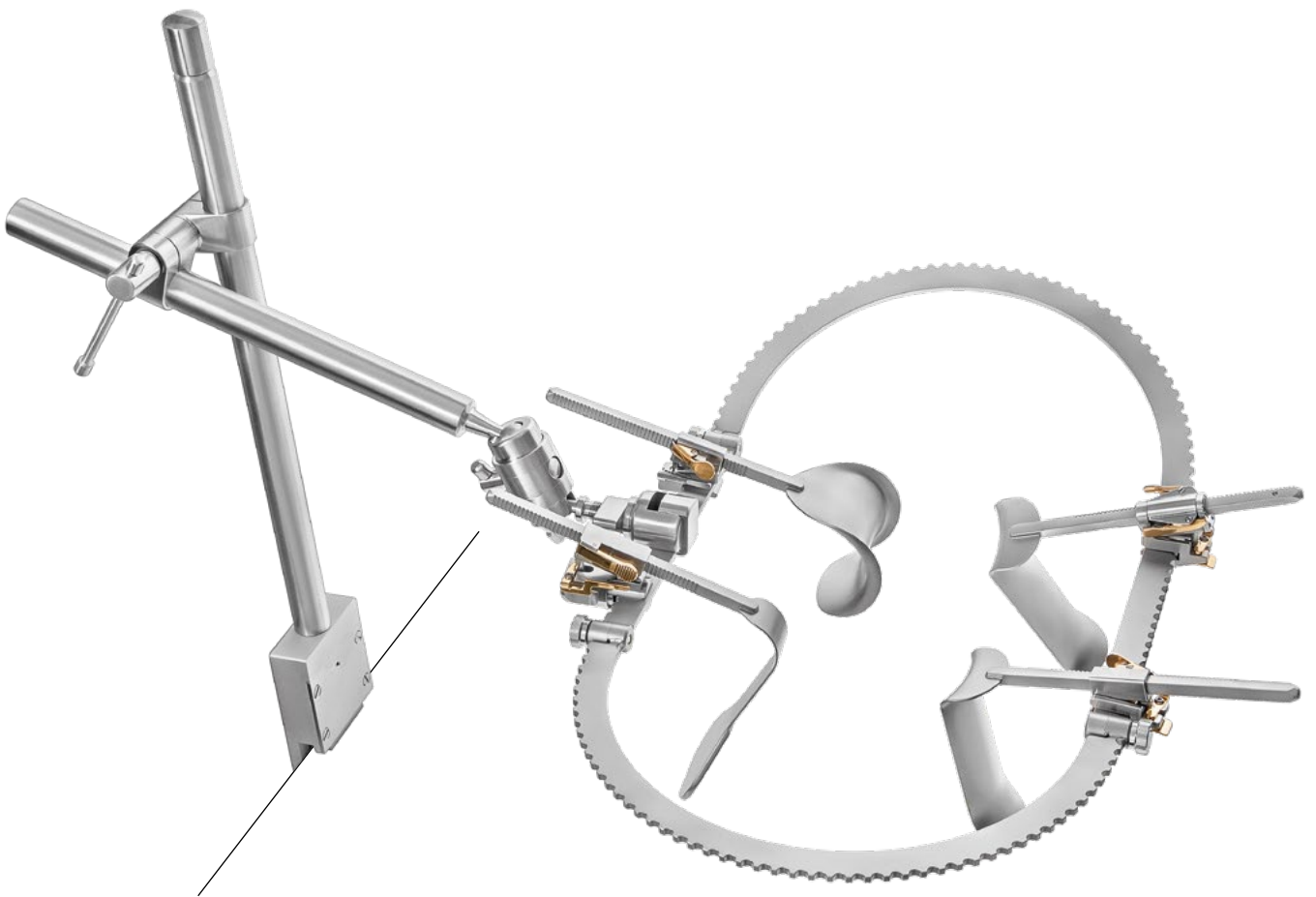

The genuine and established RZ Table Mounted Ring Retractor System provides a large variety of configurations. Every kit can be easily set up and adjusted multi-directional even for complex requirements thanks to the flexible ratchet mechanisms. Any retractor can be applied as an individual set.

- Large assortment of retractor blades in different sizes
- Expandable basic components to assemble a complex system
- Simple assembly and modifications before and during surgery
- All parts fully autoclavable

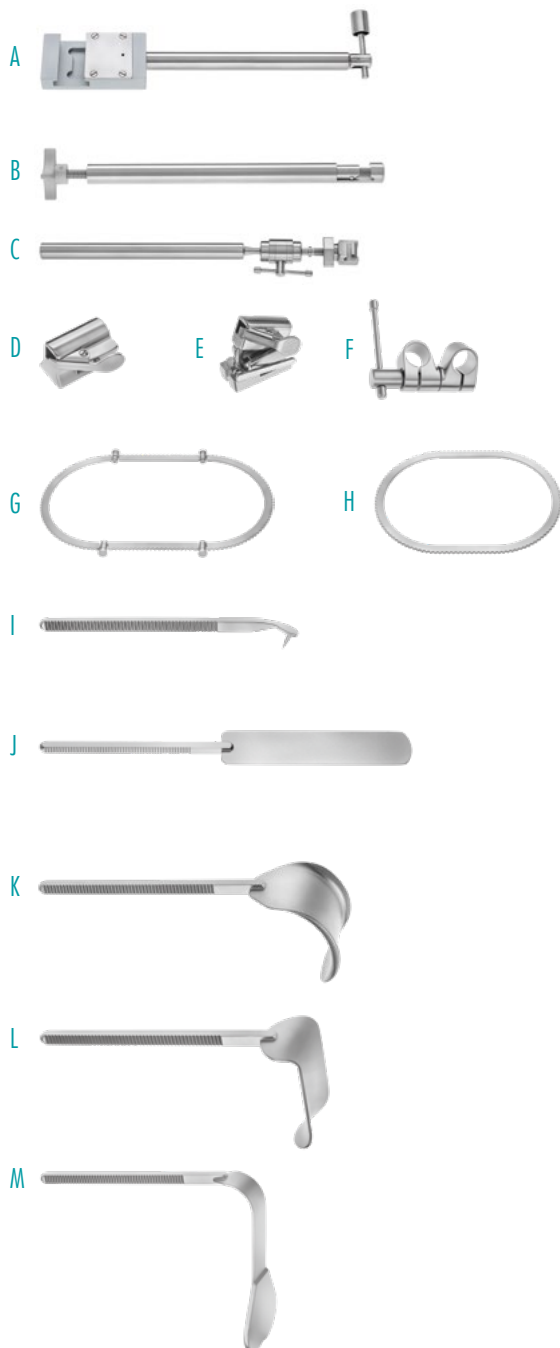

RETRACTOR KIT

12"	170-800-904
18"	170-800-900
24"	170-800-902

RETRACTOR KITS

consisting of:

A	Table Post, 300mm, 11 ^{7/8} "	170-800-100
	Table Post, 460mm, 18"	170-800-099
	Table Post, 610mm, 24"	170-800-098
B	Horizontal Bar	170-800-102
C	Horizontal Flex Bar	170-800-103
D	Standard Ratchet (2x)	170-800-113
E	Tilt Ratchet Mechanism (6x)	170-800-110
F	Post Coupler	170-800-104
G	Oval Frame, medium, segmented 538 x 300mm, 21x11 ^{7/8} "	170-800-032
H	Oval Frame, medium 410 x 294mm, 16 x 11 ^{1/2} "	170-800-012
I	Gelpi Point Retractor	170-800-241
J	Retractor Blade, malleable 38 x 152mm, 1 ^{1/2} x 6"	170-800-231
	51 x 152mm, 2x6" (2x)	170-800-232
	76 x 152mm, 3x6"	170-800-233
K	BALFOUR 75 x 75mm, 3x3"	170-800-202
L	KELLY 51 x 76mm, 2x3" (2x)	170-800-214
	51 x 102mm, 2x4"	170-800-215
	51 x 127mm, 2x5"	170-800-216
	51 x 152mm, 2x6"	170-800-217
M	HARRINGTON Heart-shaped, 64 x 143mm, 2 ^{1/2} x 5 ^{5/8} "	170-800-221

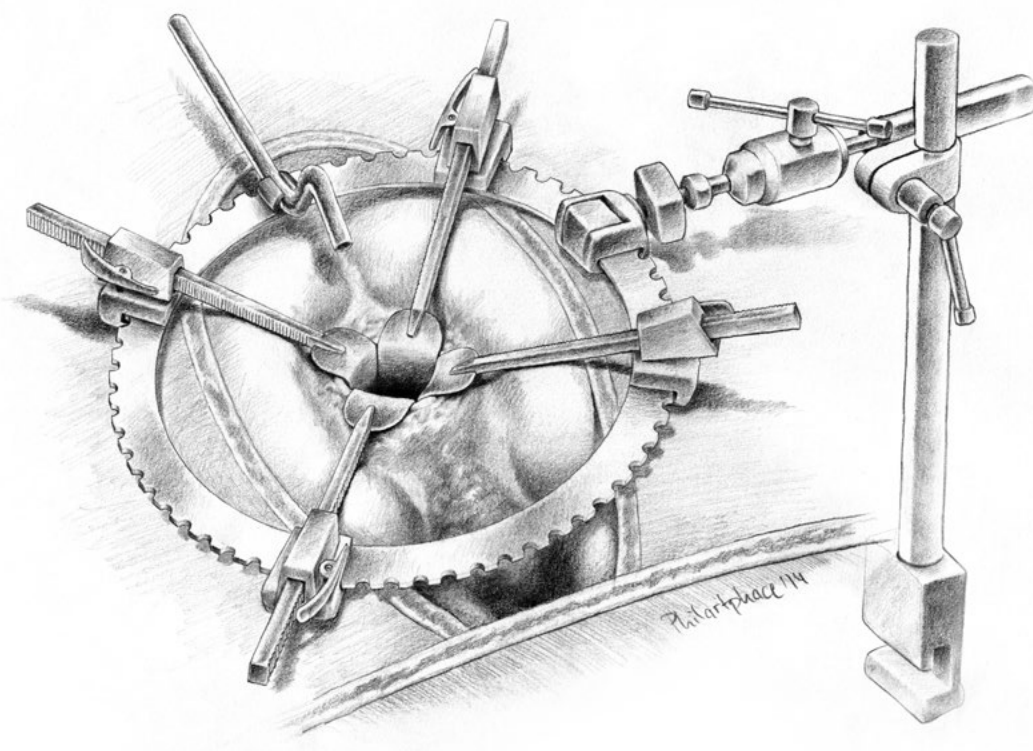

RECTAL SET
170-800-906
consists of:

Round Frame, small	170-800-021
Rectal Blade, small 22 x 72mm (2x)	170-800-311
large 23 x 98mm (2x)	170-800-312

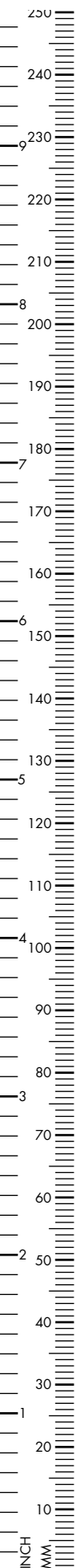

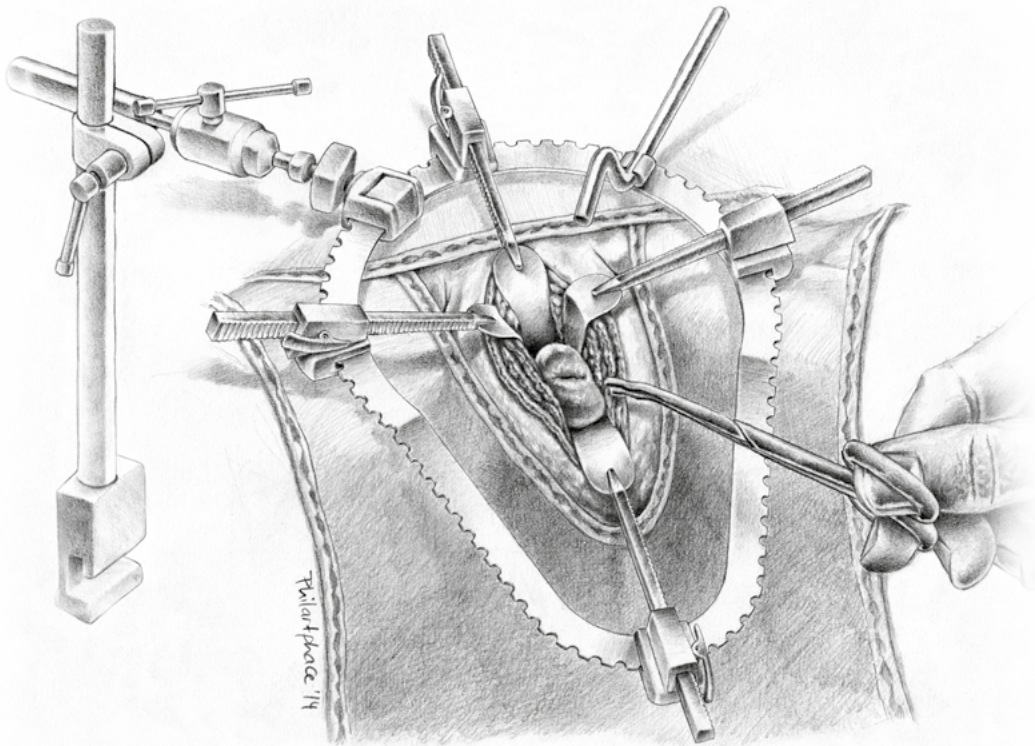

VAGINAL RETRACTOR KIT (STANDARD SETUP)

170-800-909

consists of:



Table Post, 300mm, 11 ^{7/8} "	170-800-100
---	-------------

Horizontal Flex Bar	170-800-103
---------------------	-------------

Tilt Ratchet Mechanism (6x)	170-800-110
--------------------------------	-------------

Post Coupler	170-800-104
--------------	-------------

Vaginal Frame, oval, 20° angled 203 x 267mm, 8 x 10 ^{1/2} "	170-800-051
---	-------------

DEAVER small	170-800-261
------------------------	-------------

large	170-800-262
-------	-------------

Vaginal Retractor 25 x 76mm, 1 x 3" (2x)	170-800-271
---	-------------

25 x 114mm, 1 x 4 ^{1/2} "	170-800-272
------------------------------------	-------------

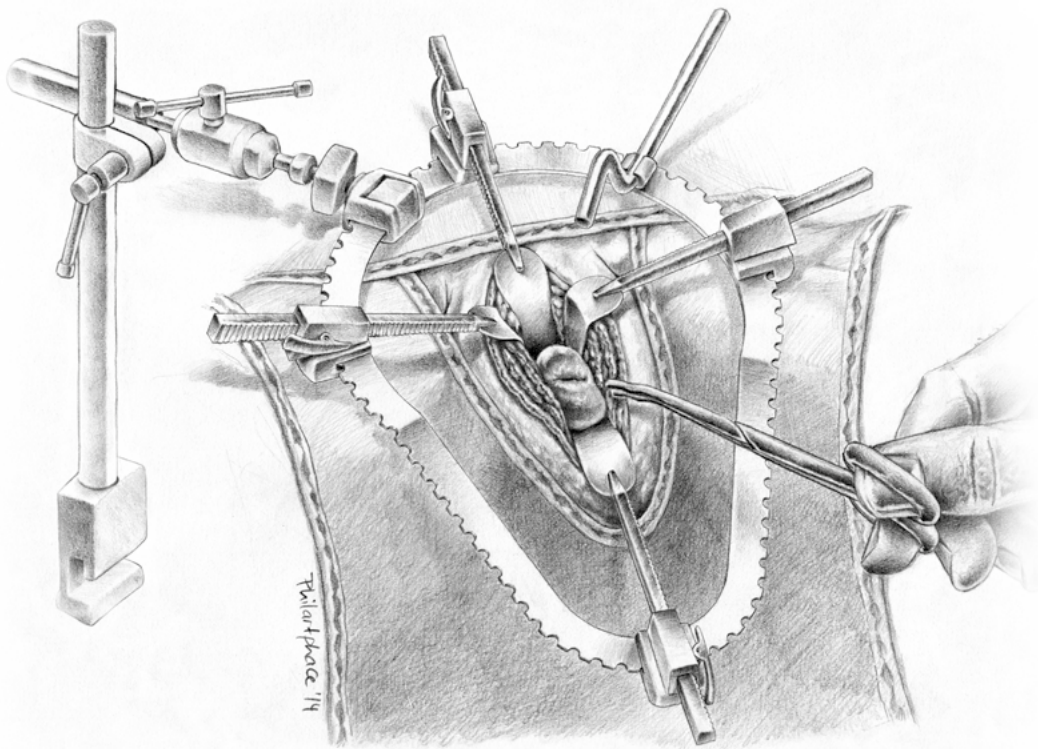

VAGINAL RETRACTOR KIT (ALTERNATIVE SETUP)

170-800-910

consists of:



Table Post, 200mm, 8"	170-800-097
--------------------------	-------------

Rotate and Tilt Ratchet Mechanism (6x)	170-800-112
---	-------------

Vaginal Frame, oval, segmented 305 x 241mm, 12 x 9 ¹ / ₂ "	170-800-050
---	-------------

Retractor Blade, malleable 25 x 102mm, 1 x 4"	170-800-237
--	-------------

Vaginal Retractor 25 x 76mm, 1 x 3" (2x)	170-800-271
---	-------------

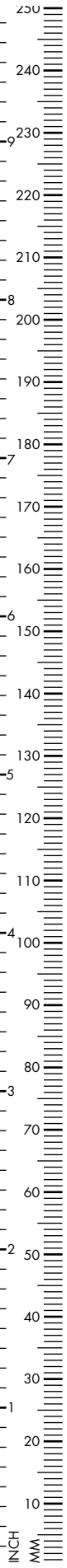

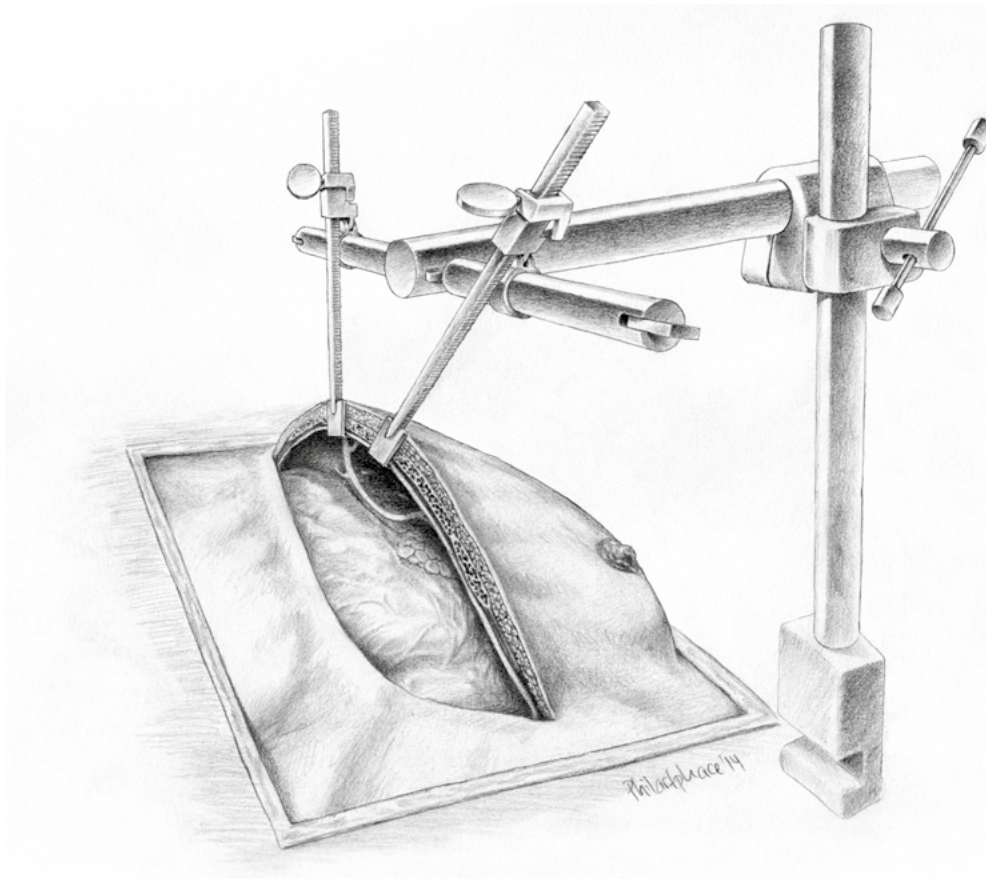

IMA RETRACTOR KIT

170-800-905

consists of:



Table Post, 300mm, 1 7/8"	170-800-100
------------------------------	-------------



Horizontal Bar	170-800-102
----------------	-------------



Cross Bar	170-798-046
-----------	-------------



Post Coupler	170-800-104
--------------	-------------



Ratchet Mechanism	170-798-047
-------------------	-------------



Retractor Blade	170-798-048
-----------------	-------------

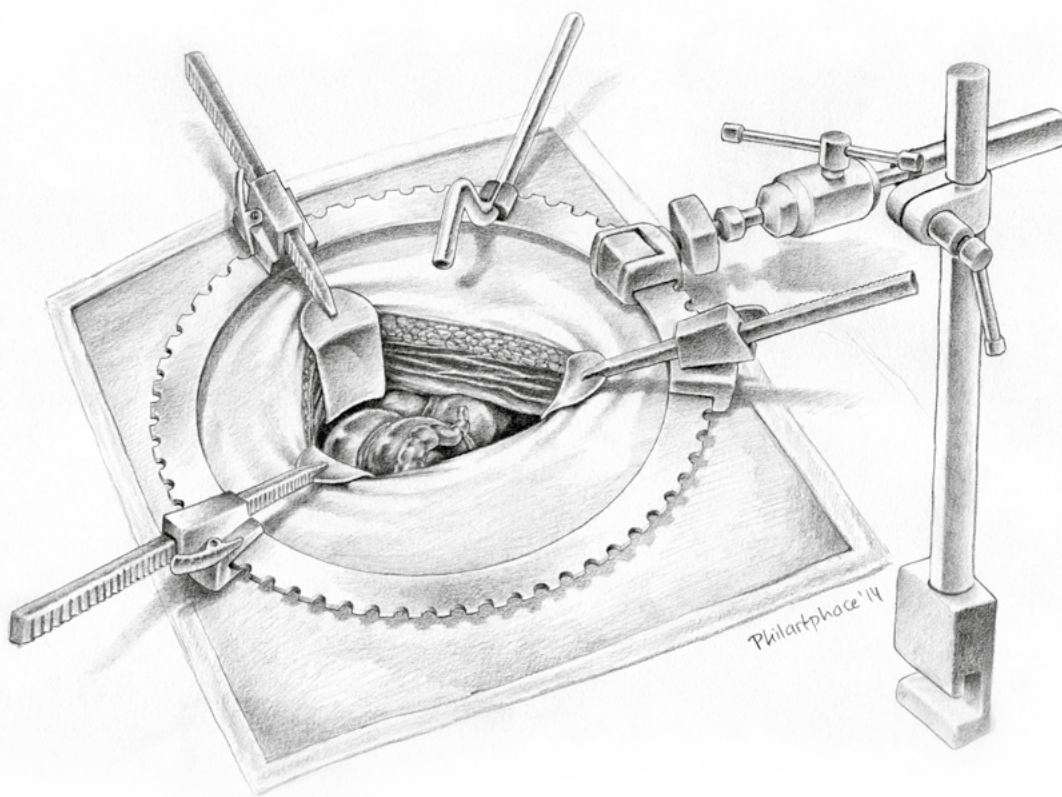

SMALL INCISION KIT

170-800-907

consists of:

Round Frame, small Ø 248mm, 9 ³ / ₄ "	170-800-021
--	-------------

Gelpi Point Retractor	170-800-241
-----------------------	-------------

KELLY

25 x 38mm, 1 x 1 ¹ / ₂ "	170-800-208
--	-------------

25 x 63mm, 1 x 2 ¹ / ₂ "	170-800-209
--	-------------

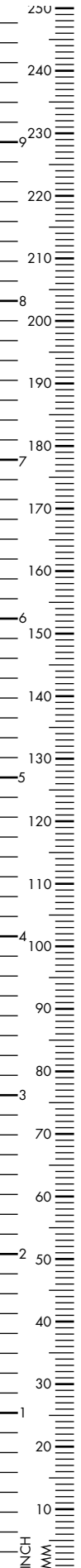

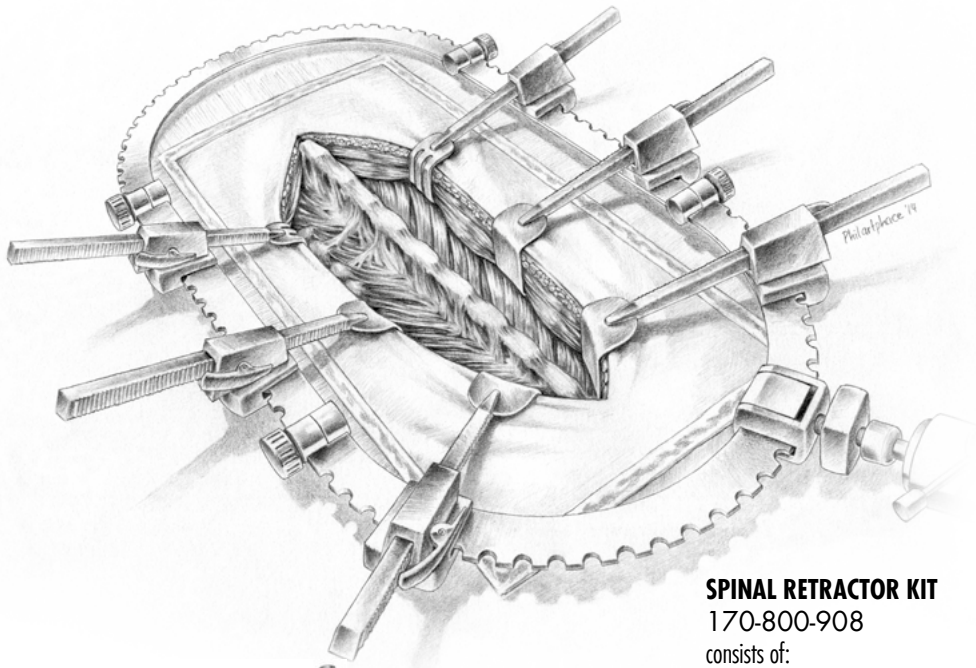

















SPINAL RETRACTOR KIT

170-800-908

consists of:

	Table Post, 300mm, 11 ⁷ / ₈ "	170-800-100
	Horizontal Flex Bar	170-800-103
	Self-Retaining Tilt Ratchet (6x)	170-800-111
	Tilt Ratchet Mechanism (6x)	170-800-110
	Post Coupler	170-800-104
	Round Ring Segment, small, 2 pieces Ø 254mm, 10"	170-800-041
	Ring Segment, small, 100mm, 4" (2x)	170-800-061
	Ring Segment, medium, 150mm, 6" (2x)	170-800-062
	Ring Segment, large, 200mm, 8" (2x)	170-800-063
	SCOVILLE small, 25 x 40mm (2x)	170-800-321
	large, 25 x 80mm	170-800-322
	MEYERDING small, 60 x 17mm (2x)	170-800-331
	medium, 85 x 25mm (2x)	170-800-332
	large, 95 x 50mm (2x)	170-800-333
	MEYERDING 3 prongs (2x)	170-800-343
	4 prongs	170-800-344
	6 prongs	170-800-345

GENUINE RING RETRACTOR SETS

RETRACTOR KITS

Single Parts

A	Table Post, 300mm, 11 ^{7/8} "	170-800-100
	Table Post, 460mm, 18"	170-800-099
	Table Post, 610mm, 24"	170-800-098
B	Horizontal Bar	170-800-102
C	Horizontal Flex Bar	170-800-103
D	Cross Bar	170-798-046
E	Standard Ratchet	170-800-113
F	Tilt Ratchet Mechanism	170-800-110
G	Self-Retaining Tilt Ratchet	170-800-111
H	Rotate and Tilt Ratchet Mechanism	170-800-112
I	Ratchet Mechanism	170-798-047
J	Post Coupler	170-800-104
K	Round Frame, small ∅ 248mm, 9 ^{3/4} "	170-800-021
L	Oval Frame, medium, 410 x 294mm, 16 x 11 ^{1/2} "	170-800-012
M	Oval Frame, medium, segmented 538 x 300mm, 21 x 11 ^{7/8} "	170-800-032
N	Vaginal Frame, oval, 20° angled 203 x 267mm, 8 x 10 ^{1/2} "	170-800-051
O	Vaginal Frame, segmented 305 x 241mm, 12 x 9 ^{1/2} "	170-800-050
P	Round Ring Segment, small, 2 pieces ∅ 254mm, 10"	170-800-041
Q	Ring Segment, small, 100mm, 4"	170-800-061
	Ring Segment, medium, 150mm, 6"	170-800-062
	Ring Segment, large, 200mm, 8"	170-800-063

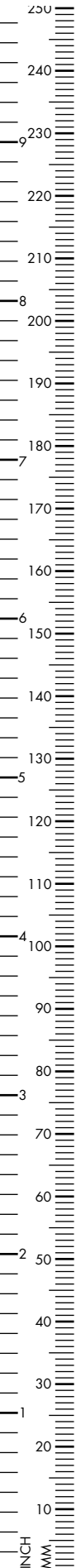

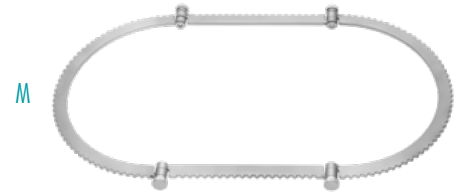
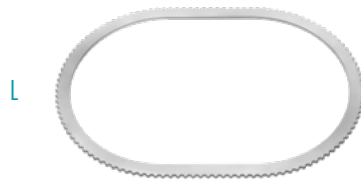

RETRACTOR KITS

Single Parts

A	Gelpi Point Retractor	170-800-241	H	BALFOUR	
B	Retractor Blade, malleable			75 x 75mm	170-800-202
	38 x 152mm	170-800-231		89 x 70mm	170-800-201
	51 x 152mm	170-800-232	I	KELLY	170-800-208
	76 x 152mm	170-800-233		25x 38	
	76 x 254mm	170-800-234		25 x 63mm	170-800-209
	102 x 215mm	170-800-235		51 x 76mm	170-800-214
	51 x 254mm	170-800-236		51 x 102mm	170-800-215
	Retractor Blade, malleable, with lib			51 x 127mm	170-800-216
	25 x 102mm	170-800-237		51 x 152mm	170-800-217
	38 x 168mm	170-800-238		51 x 200mm	170-800-218
	51 x 168mm	170-800-239	J	HARRINGTON	
	75 x 168mm	170-800-240		64 x 143mm	170-800-221
	Retractor Blade, extra malleable,			90 x 251mm	170-800-222
	with lib, 25 x 102mm	170-800-247	K	DEAVER	
	38 x 168mm	170-800-248		small	170-800-261
	51 x 168mm	170-800-249		large	170-800-262
	75 x 168mm	170-800-250	L	Vaginal Retractor	
C	Retractor Blade, malleable,			25 x 76mm	170-800-271
	titanium coated, with lib, 38 x 279mm	170-800-229		25 x 114mm	170-800-272
	51 x 279mm	170-800-230	M	Titanium Retractor Blade	170-800-360
	76 x 279mm	170-800-227		25x 102mm	
	102 x 279mm	170-800-228		25 x 127mm	170-800-361
D	SCOVILLE			25 x 152mm	170-800-362
	Hook, small	170-800-321		25 x 178mm	170-800-363
	Hook, large	170-800-322		25 x 203mm	170-800-364
E	MEYERDING			51 x 102mm	170-800-365
	3 prongs	170-800-343		51 x 127mm	170-800-366
	4 prongs	170-800-344		51 x 152mm	170-800-367
	6 prongs	170-800-345		51 x 178mm	170-800-368
F	Retractor Blade	170-798-048		51 x 203mm	170-800-369
G	MEYERDING		N	Malleable Blade with groove	170-800-242
	small	170-800-331		51 x 152mm	
	medium	170-800-332			
	large	170-800-333			

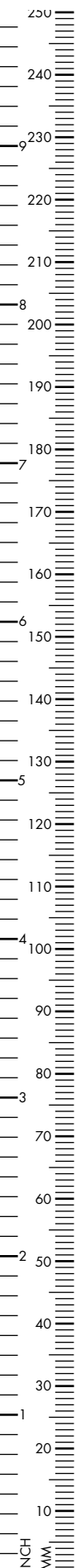





SET

Blades, Accessories, Case

		170-800-912
Standard Ratchet Mechanism	2x	170-800-113
Tilt Ratchet Mechanism	6x	170-800-110
Post Coupler	1x	170-800-104
Harrington Retractor	1x	170-800-221
Kelly Retractor, 76mm	1x	170-800-214
Kelly Retractor, 102mm	1x	170-800-215
Kelly Retractor, 127mm	1x	170-800-216
Kelly Retractor, 152mm	1x	170-800-217
Balfour Retractor	1x	170-800-202
Gelpi Point Retractor	1x	170-800-241
Blade, malleable, 38mm	1x	170-800-231
Blade, malleable, 51mm	1x	170-800-232
Blade, malleable, 76mm	1x	170-800-233
Case, 527 x 250 x 100mm	1x	170-800-915



SET

Table Fixation and Ring Case

		170-800-913
Table Post	1x	170-800-100
Horizontal Flex Bar	1x	170-800-103
Horizontal Bar	1x	170-800-102
Oval Frame, medium, segmented	1x	170-800-032
Oval Frame, medium	1x	170-800-012
Case, 537 x 250 x 197mm	1x	170-800-914

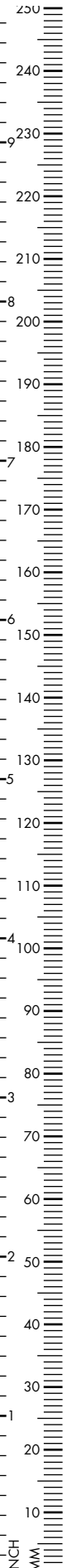

RETAINING RETRACTORS

