

# HAND HELD RETRACTORS

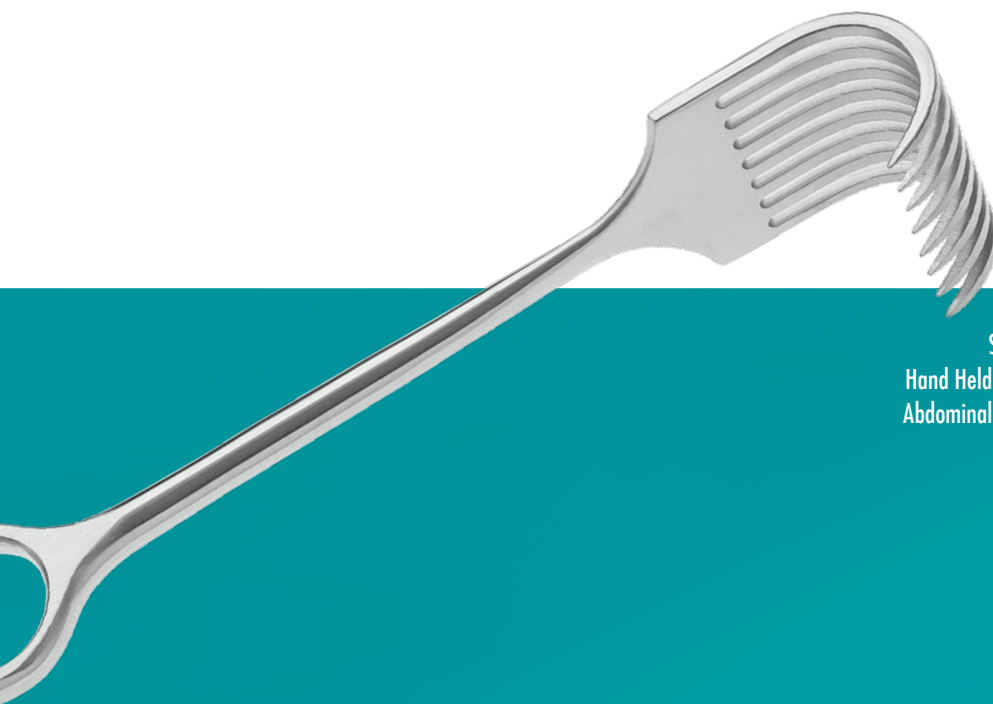

Skin Hooks  
Hand Held Retractors  
Abdominal Retractors

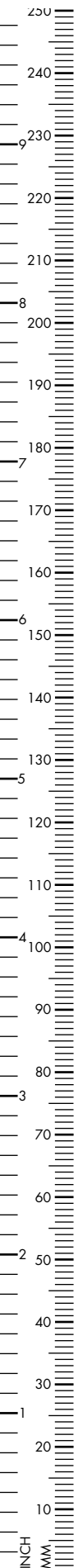

### GRAEFE

Micro Skin Hook, 125mm, 5"

sharp	170-010-125
blunt	170-011-125

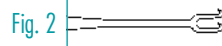
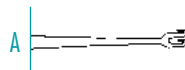

### GUTHRIE

Micro Skin Hook, 2 prongs, sharp

A 120mm, 4 <sup>3</sup> / <sub>4</sub> "	170-042-130
Fig. 1 160mm, 6 <sup>1</sup> / <sub>4</sub> "	170-042-160
Fig. 2 160mm, 6 <sup>1</sup> / <sub>4</sub> "	170-044-160



### O'CONNOR

Skin Hook

120mm, 4 <sup>3</sup> / <sub>4</sub> "	170-040-160
--	-------------



### FRAZIER

Skin Hook

130mm, 5<sup>1</sup>/<sub>8</sub>"

170-013-130



### BARSKY

Double Skin Hooklet, 2 prongs

150mm, 6"

170-019-000



### KNAPP

Skin Retractor, 4 prongs, 130mm, 5<sup>1</sup>/<sub>8</sub>"

sharp 170-080-001

blunt 170-080-002



### MILLER

Skin Retractor, 9 prongs, 135mm, 5<sup>1</sup>/<sub>3</sub>"

sharp 170-085-130

blunt 170-086-130

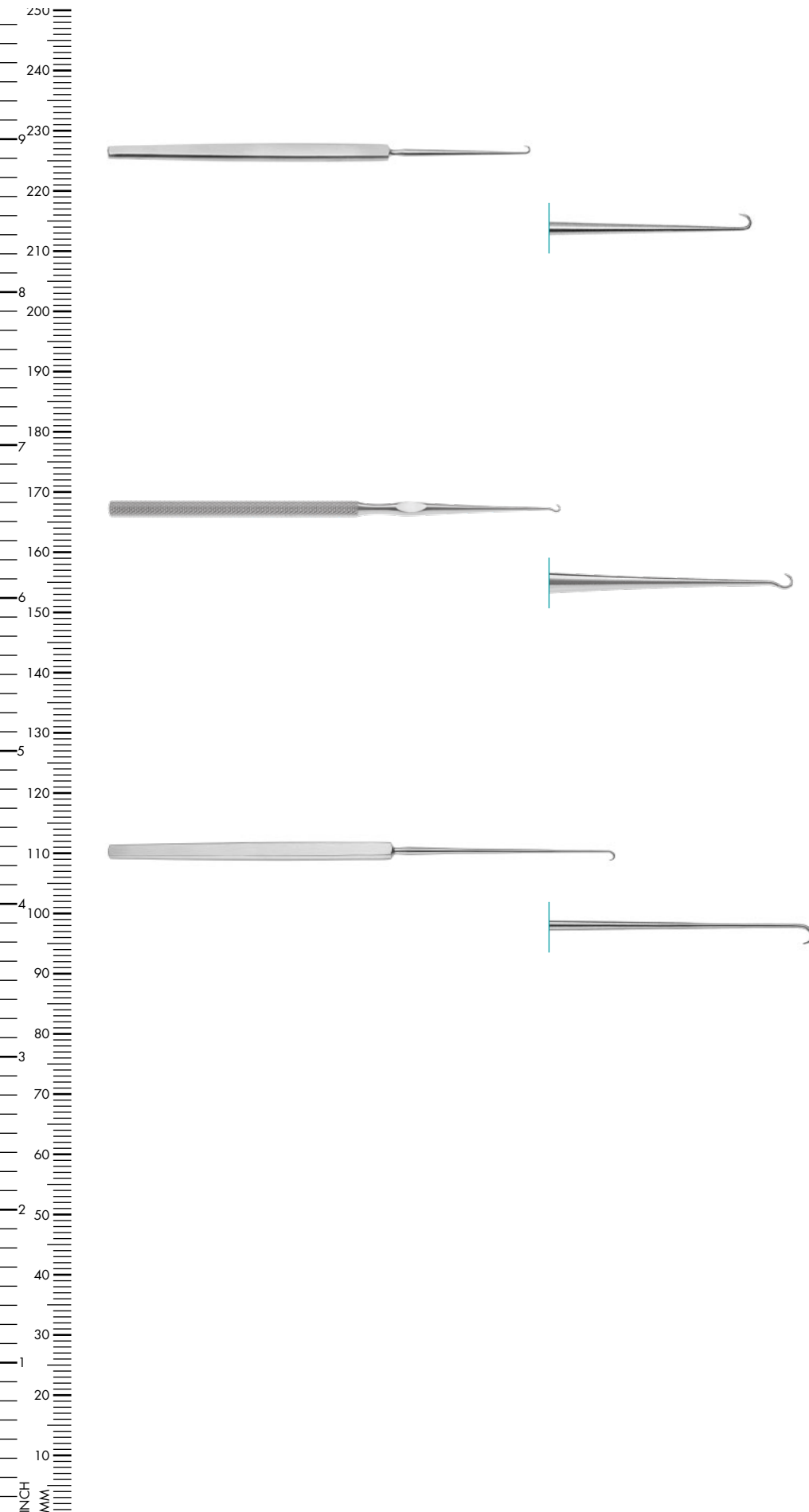

### CUSHING

Skin Hook, sharp

140mm, 5<sup>1/2</sup>"

170-015-140

### KILNER

Skin Hook, sharp

150mm, 6"

230-203-150

### CLOWARD

Skin Hook, sharp

160mm, 6<sup>1/4</sup>"

170-014-165



### KLEINERT KUTZ

Skin Hook, sharp, 160mm, 6<sup>1</sup>/<sub>4</sub>"

Small, 3mm	170-020-001
Medium, 5mm	170-020-002
Large, 8mm	170-020-003

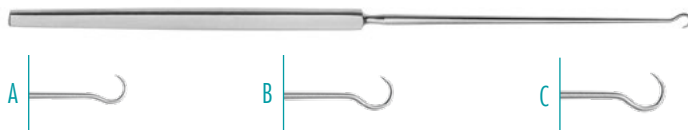

### GILLIES

Skin Hook, 180mm, 7"

A Small	230-205-180
B Medium	230-207-180
C Large	230-209-180

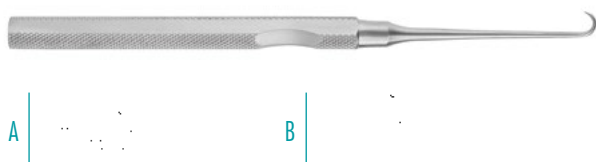

### MANNERFELT (MODIF.)

Skin Hook, sharp, 1 prong

A 155mm, 6 <sup>1</sup> / <sub>8</sub> "	420-560-155
2 prongs (3.5 x 12mm)	
B 155mm, 6 <sup>1</sup> / <sub>8</sub> "	420-561-155

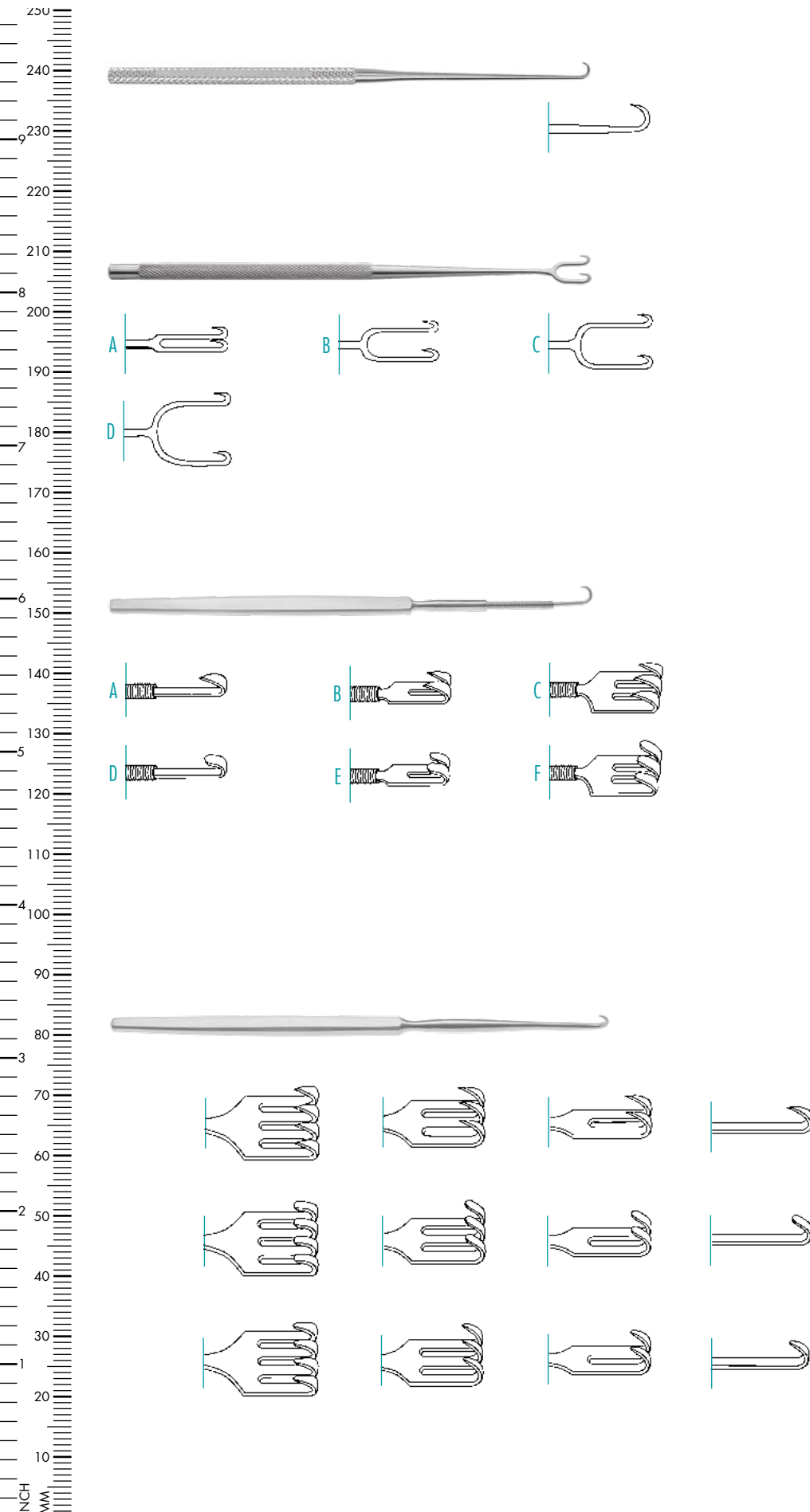

### JOSEPH

Skin Hook

160mm, 6<sup>1</sup>/<sub>4</sub>" 170-014-001

### JOSEPH

Skin Hook, 2 prongs, 160mm, 6<sup>1</sup>/<sub>4</sub>"

A 2mm wide 170-014-002

B 5mm wide 170-014-005

C 7mm wide 170-014-007

D 10mm wide 170-014-010

Skin Hook, flexible shaft

160mm, 6<sup>1</sup>/<sub>4</sub>", sharp

A 1 prong 170-079-161

B 2 prongs 170-079-162

C 3 prongs 170-079-163

blunt

D 1 prong 170-076-161

E 2 prongs 170-076-162

F 3 prongs 170-076-163

Hand Held Retractor, 160mm, 6<sup>1</sup>/<sub>4</sub>", sharp

1 prong 170-074-161

2 prongs 170-074-162

3 prongs 170-074-163

4 prongs 170-074-164

blunt

1 prong 170-075-161

2 prongs 170-075-162

3 prongs 170-075-163

4 prongs 170-075-164

semi-blunt

1 prong 170-077-161

2 prongs 170-077-162

3 prongs 170-077-163

4 prongs 170-077-164

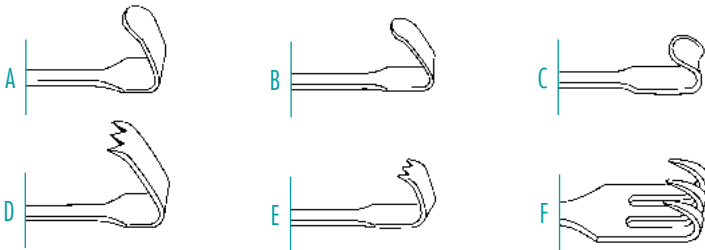

### MEYERDING

Hand Held Retractor, 180mm, 7"

A	18 x 7mm	170-079-181
B	10 x 3mm, prongs	170-079-183
C	7 x 4mm	170-079-185
D	16 x 5mm, prongs	170-079-182
E	7 x 4mm	170-079-184
F	4 x 10mm, prongs	170-079-186



### MINI LANGENBECK

Hand Held Retractor, 160mm, 6 1/4"

10 x 6mm (AxB)	170-130-160
17 x 5mm (AxB)	170-131-160
20 x 6mm (AxB)	170-132-160
22 x 8mm (AxB)	170-133-160



### DESMARRES

Hand Held Retractor, 130mm, 5 1/8"

8mm	170-108-130
10mm	170-110-130
12mm	170-112-130
14mm	170-114-130
16mm	170-116-130
18mm	170-118-130

160mm, 6 1/4"

8mm	170-108-160
10mm	170-110-160
12mm	170-112-160
14mm	170-114-160
16mm	170-116-160
18mm	170-118-160

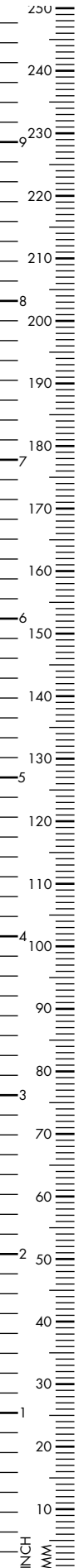

### CUSHING

Vein Retractor, 200mm, 8"

8mm	170-231-080
10mm	170-231-100
12mm	170-231-120
14mm	170-231-140
16mm	170-231-160
18mm	170-231-180

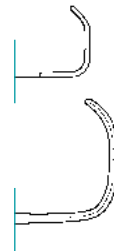
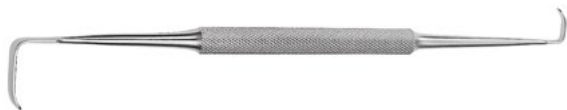

### RAGNELL

Hand Held Retractor, double ended,  
8 x 3mm and 16 x 5mm blade

150mm, 6"	170-206-150
-----------	-------------

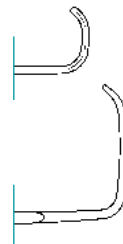

### RAGNELL DAVIS

Hand Held Retractor, double ended,  
8 x 4mm and 15 x 5.5mm blade

140mm, 5 1/2"	170-207-140
---------------	-------------



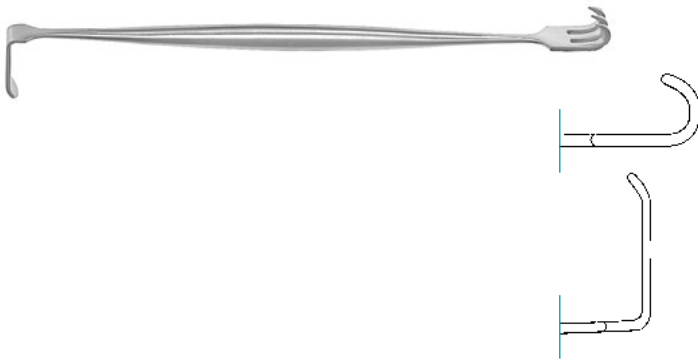

### SENN MILLER

Hand Held Retractor,  
8 x 7mm / 18 x 5.5mm, 160mm, 6<sup>1</sup>/<sub>4</sub>"

sharp	170-210-160
blunt	170-212-160

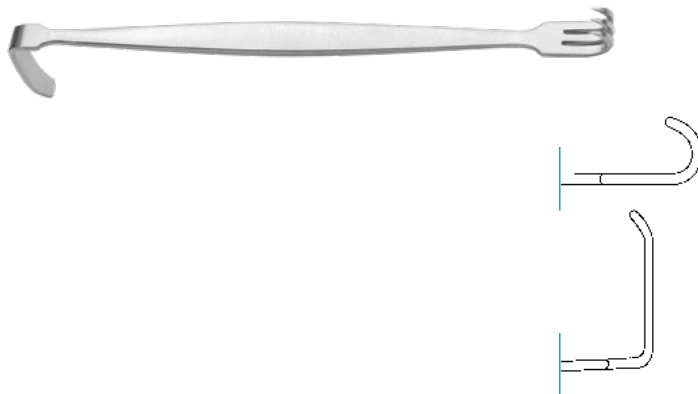

### BABY SENN-MILLER

Hand Held Retractor,  
8 x 7mm / 20 x 7mm, 155mm, 6<sup>1</sup>/<sub>8</sub>"

sharp	170-214-160
blunt	170-213-160



### GIL VERNET

Hand Held Retractor, malleable  
135mm, 5<sup>1</sup>/<sub>3</sub>"

8mm	170-236-108
11mm	170-236-111
15mm	170-236-115
200mm, 8"	
8mm	170-236-208
11mm	170-236-211
15mm	170-236-215
17mm	170-236-217
20mm	170-236-220
23mm	170-236-223

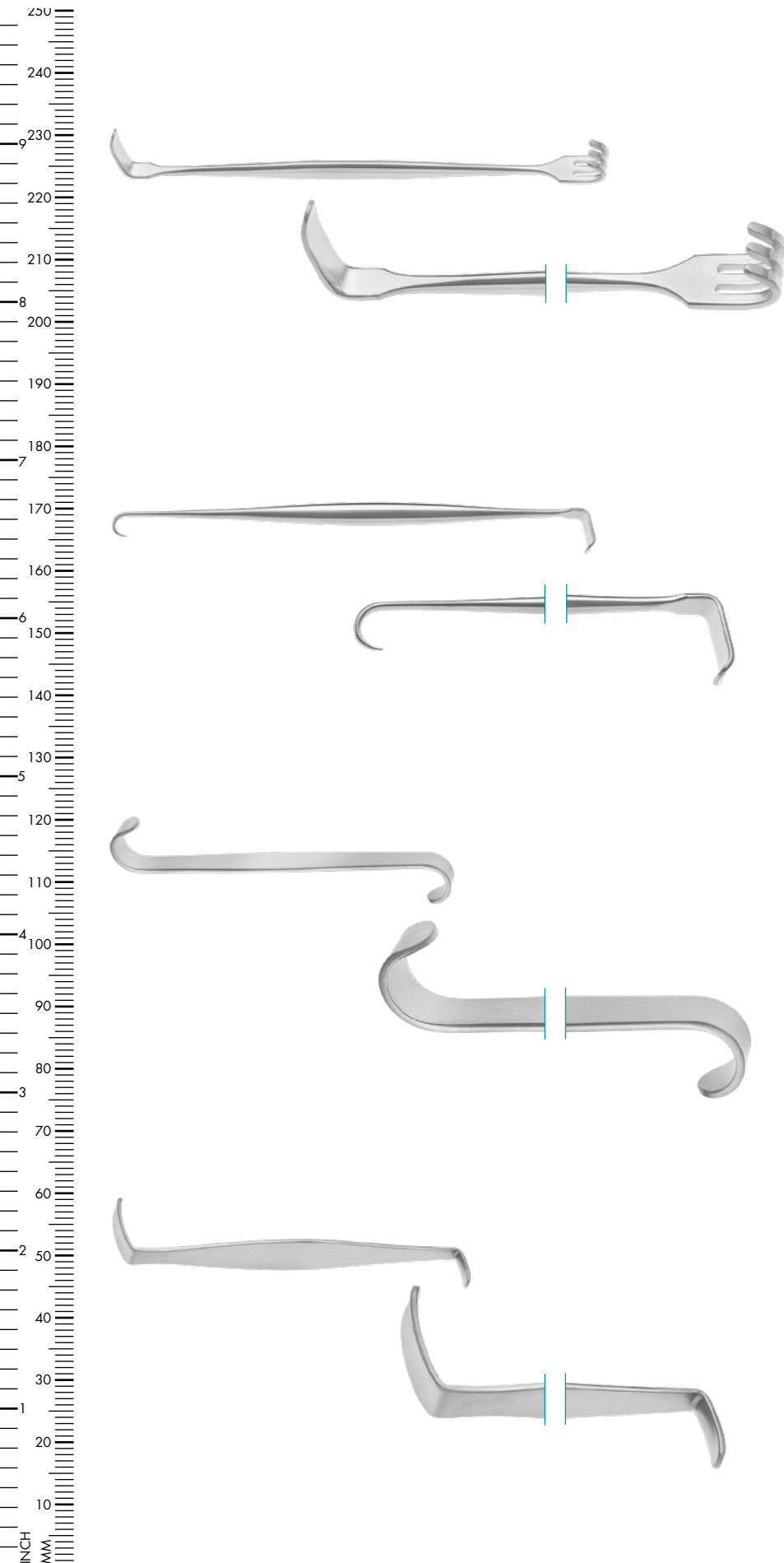

### **MATHIEU**

Hand Held Retractor, 160mm, 6<sup>1</sup>/<sub>4</sub>"  
20 x 6.5mm, 8mm wide

sharp	170-001-160
blunt	170-002-160

### **MEYERDING**

Hand Held Retractor and Skin Hook,  
16 x 5mm

155mm, 6 <sup>1</sup> / <sub>8</sub> "	170-165-155
--	-------------

### **LUER**

Retractor, 10 x 5mm / 14 x 9mm

110mm, 4 <sup>1</sup> / <sub>3</sub> "	170-671-110
--	-------------

### **CRILE**

Retractor, 12 x 4mm / 20 x 6mm

115mm, 4 <sup>1</sup> / <sub>2</sub> "	170-670-115
--	-------------

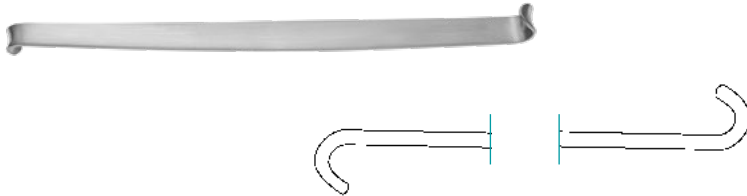

### MINI ROUX

Retractor, double-ended, 6 x 7mm

140mm, 5<sup>1</sup>/<sub>2</sub>"

170-667-006

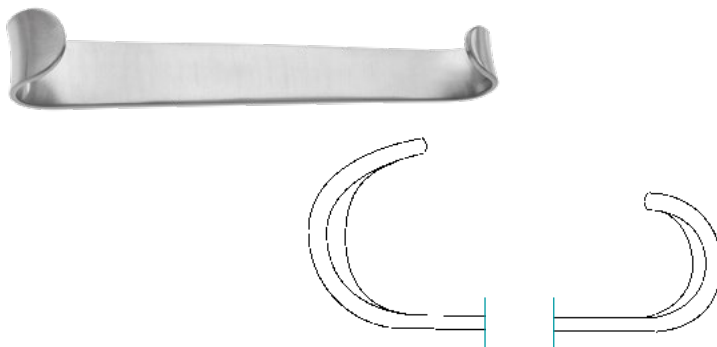

### BABY ROUX

Retractor, 17 x 16mm / 18 x 22mm

130mm, 5<sup>1</sup>/<sub>8</sub>"

170-669-130

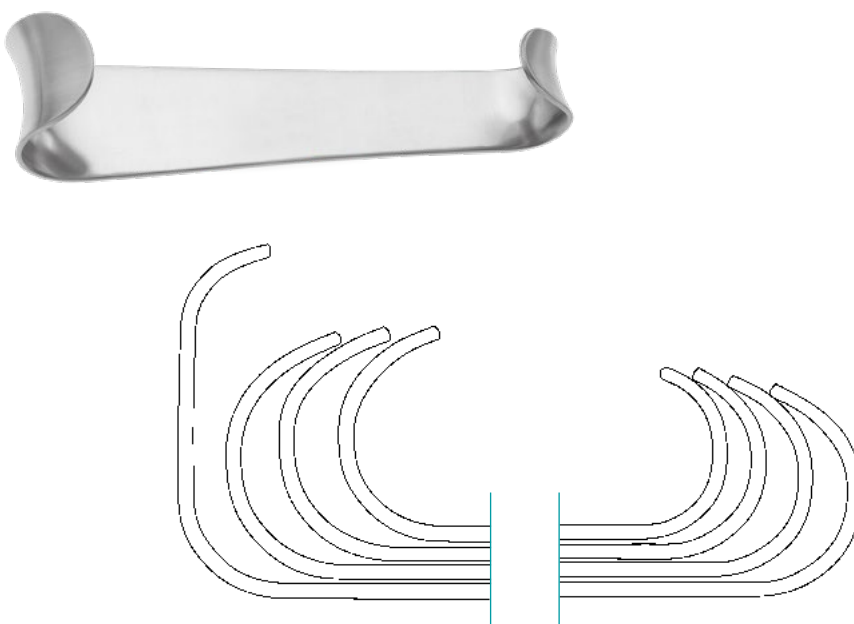

### ROUX

Retractor, 165mm, 6<sup>1</sup>/<sub>2</sub>"

Fig. 1, 19 x 22mm / 23 x 30mm 170-655-140

Fig. 2, 25 x 26mm / 28 x 38mm 170-655-150

Fig. 3, 28 x 29mm / 33 x 45mm 170-655-170

Set of Fig 1-3 170-655-000

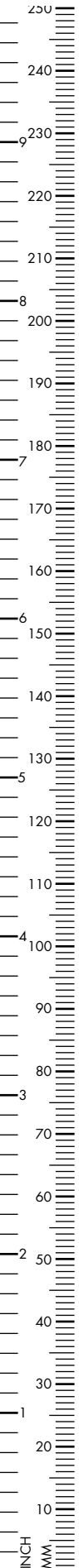

### FARABEUF

Retractor Set

Fig. 1 30 x 10mm / 26 x 10mm

Fig. 2 30 x 13mm / 34 x 13mm, Fig 2

120mm, 4<sup>3/4</sup>"

170-663-120

Fig. 1 23 x 16mm / 27 x 16mm

Fig. 2 27 x 16mm / 30 x 16mm

150mm, 6"

170-665-150



### PARKER

Retractor Set

19 x 15mm / 19 x 15mm

22 x 15mm / 22 x 15mm

140mm, 5<sup>1/2</sup>"

170-673-001

26 x 25mm / 27 x 25 mm

29 x 25mm / 27 x 25 mm

185mm, 7<sup>1/4</sup>"

170-673-002



### COLLIN

Retractor Set

28 x 16mm / 32 x 16mm

145mm, 5<sup>3/4</sup>"

170-666-145



### PARKER MOTT

Retractor Set, Fig. 1 + 2

21 x 24mm / 68 x 24mm

15 x 24mm / 72 x 24mm

160mm, 6<sup>1/4</sup>"

170-675-000



### **MATHIEU**

Retractor Set

42 x 13mm / 42 x 26mm

47 x 13mm / 46 x 26mm

200mm, 8"

170-683-000



### **PARKER LANGENBECK (US ARMY)**

Retractor Set

210mm, 8<sup>1/4</sup>"

170-687-210



### **GOELET**

Retractor, 40 x 40mm / 30 x 30mm

195mm, 7<sup>1/2</sup>"

170-695-000

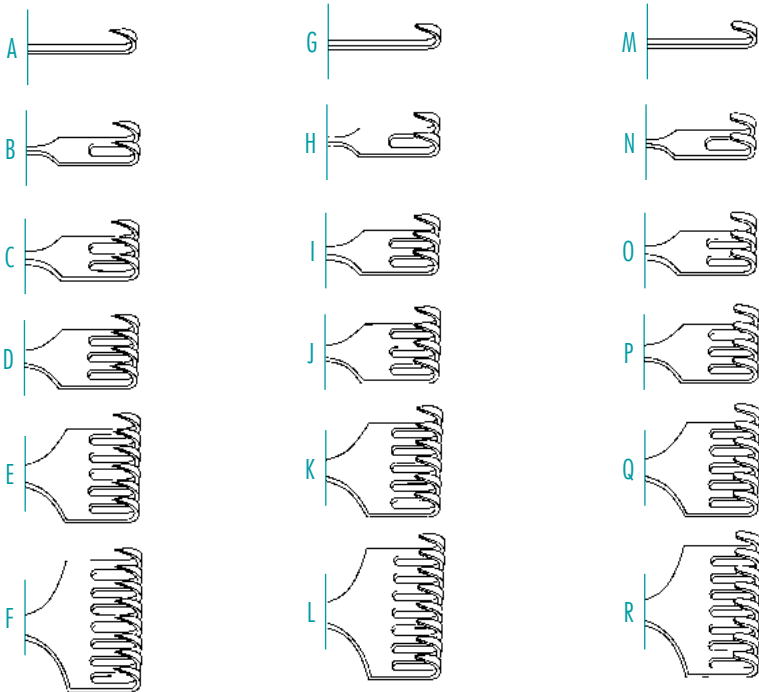

### KOCHER

Retractor, 220mm, 8<sup>2</sup>/<sub>3</sub>"  
sharp

A	1 prong, 15mm	170-310-221
B	2 prongs, 9x8mm	170-310-222
C	3 prongs, 15x15mm	170-310-223
D	4 prongs, 15x20mm	170-310-224
E	6 prongs, 15x30mm	170-310-226
F	8 prongs, 15x40mm	170-310-228

### semi - sharp

G	1 prong, 15mm	170-312-221
H	2 prongs, 9x8mm	170-312-222
I	3 prongs, 15x15mm	170-312-223
J	4 prongs, 15x20mm	170-312-224
K	6 prongs, 15x30mm	170-312-226
L	8 prongs, 15x40mm	170-312-228

### blunt

M	1 prong, 15mm	170-311-221
N	2 prongs, 9x8mm	170-311-222
O	3 prongs, 15x15mm	170-311-223
P	4 prongs, 15x20mm	170-311-224
Q	6 prongs, 15x30mm	170-311-226
R	8 prongs, 15x40mm	170-311-228

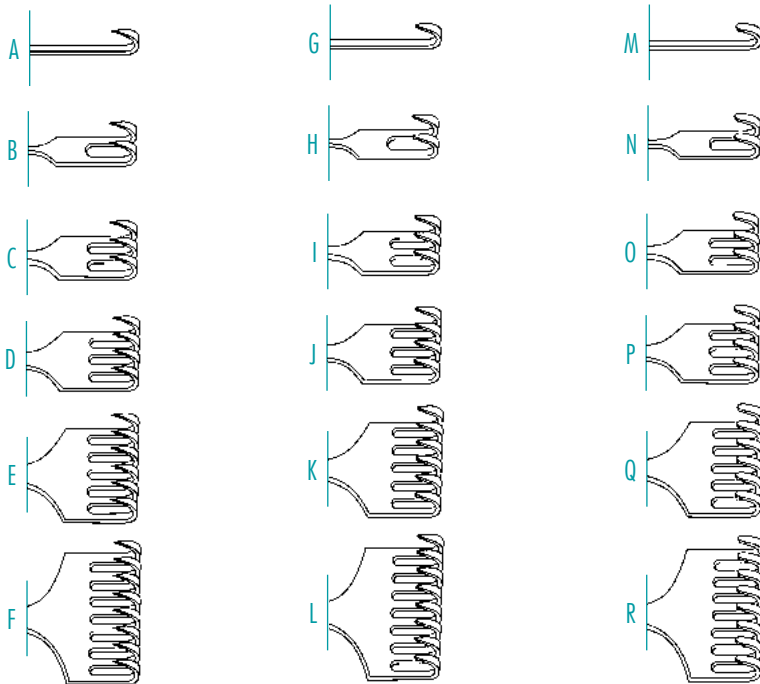

### VOLKMANN

Retractor, 215mm, 8<sup>1/2</sup>"  
sharp

A	1 prong, 9mm	170-220-215
B	2 prongs, 9x8mm	170-222-215
C	3 prongs, 9x13mm	170-224-215
D	4 prongs, 9x19mm	170-226-215
E	6 prongs, 9x29mm	170-228-215
F	8 prongs, 9x40mm	170-230-215

semi - sharp

G	1 prong, 9mm	170-231-215
H	2 prongs, 9x8mm	170-233-215
I	3 prongs, 9x13mm	170-235-215
J	4 prongs, 9x19mm	170-237-215
K	6 prongs, 9x29mm	170-239-215
L	8 prongs, 9x40mm	170-241-215

blunt

M	1 prong, 9mm	170-221-215
N	2 prongs, 9x8mm	170-223-215
O	3 prongs, 9x13mm	170-225-215
P	4 prongs, 9x19mm	170-227-215
Q	6 prongs, 9x29mm	170-229-215
R	8 prongs, 9x40mm	170-232-215



### VOLKMANN

Retractor, 115mm, 4<sup>1/2</sup>"  
sharp

1 prong, 7.5mm wide	170-140-002
2 prongs, 9.2mm wide	170-140-003
3 prongs, 12.2mm wide	170-140-004
4 prongs, 19.0mm wide	170-140-006

blunt

1 prong, 7.5mm wide	170-141-002
2 prongs, 9.2mm wide	170-141-003
3 prongs, 12.2mm wide	170-141-004
4 prongs, 19.0mm wide	170-141-006



### MURPHY

Retractor, 200mm, 8"  
sharp

2 prongs	170-218-102
3 prongs	170-218-103
4 prongs	170-218-104
6 prongs	170-218-106

blunt

2 prongs	170-218-202
3 prongs	170-218-203
4 prongs	170-218-204
6 prongs	170-218-206

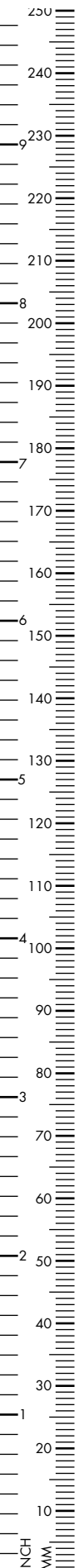





### OLLIER

Retractor, blunt, 230mm, 9"

3 prongs, 36 x 30mm 170-214-003

4 prongs, 36 x 60mm 170-214-004



### ISRAEL

Retractor, blunt, 250mm, 9<sup>7</sup>/<sub>8</sub>"

4 prongs, 40x40mm 170-220-004

5 prongs, 45x50mm 170-220-005

6 prongs, 50x60mm 170-220-006

6 prongs, 70x70mm 170-220-007



### WASSMUND

Retractor

200mm, 8" 170-216-200



### KOERTE

Retractor, 40 x 30mm, 240mm, 9<sup>1</sup>/<sub>2</sub>"

sharp	170-218-008
blunt	170-219-008



### KOERTE WAGNER

Retractor, 25 x 40mm, semi - sharp

280mm, 11"	170-220-280
------------	-------------



### LANGENBECK

Retractor, 210mm, 8<sup>1</sup>/<sub>4</sub>"

55 x 20mm	170-225-210
60 x 20mm	170-226-210
63 x 20mm	170-227-210

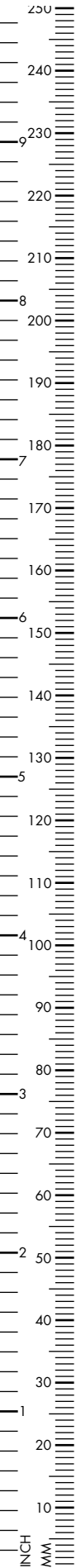
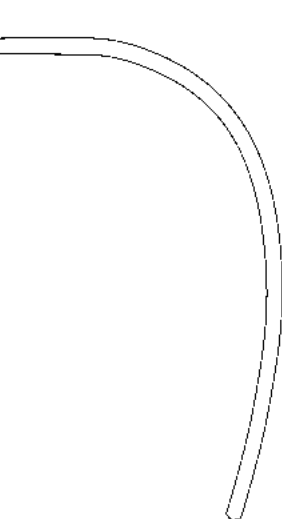
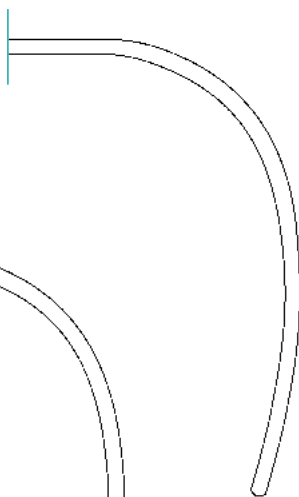
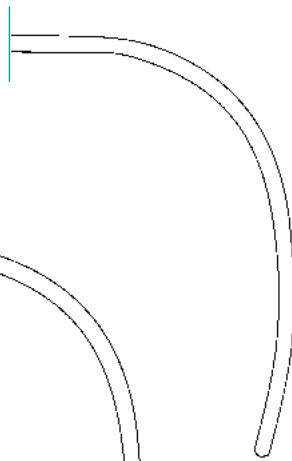

**LAHEY**

Retractor, 28 x 6mm

190mm, 7<sup>1/2</sup>"

170-312-190

**LITTLE**

Retractor, 15 x 12mm

200mm, 8"

170-313-200

**GREEN**

Retractor, 20 x 23mm

220mm, 8<sup>2/3</sup>"

170-319-220

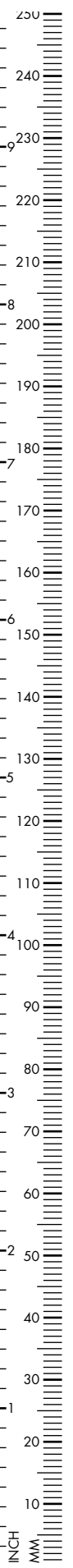

### MIDDELDORPF

Retractor, hollow handle

14 x 17mm	170-363-001
215mm, 8 <sup>1/2</sup> "	
20 x 22mm	170-363-002
220mm, 8 <sup>2/3</sup> "	
26 x 30mm	170-363-003
235mm, 9 <sup>1/4</sup> "	



fenestrated handle

14 x 17mm	170-325-001
215mm, 8 <sup>1/2</sup> "	
20 x 22mm	170-325-002
220mm, 8 <sup>2/3</sup> "	
26 x 30mm	170-325-003
235mm, 9 <sup>1/4</sup> "	

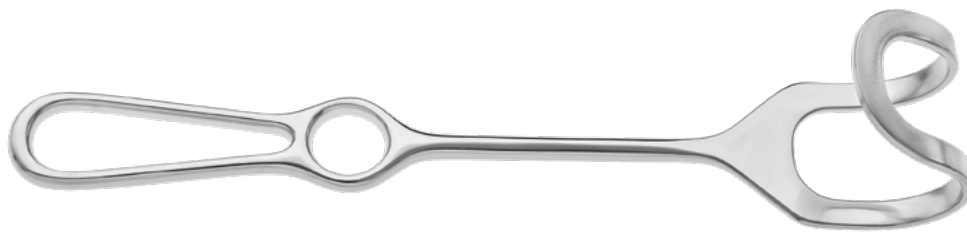

### MIDDELDORPF

Abdominal Retractor, 255mm, 10"

40 x 45mm	170-443-001
40 x 50mm	170-443-002
55 x 70mm	170-443-003

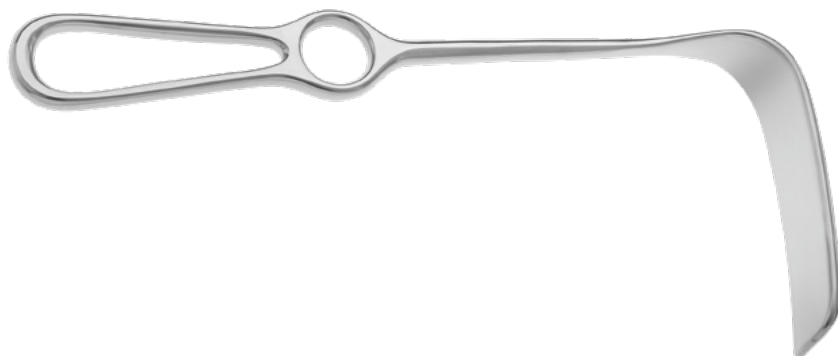

### DOYEN STILLE

Retractor, 240mm, 9<sup>1</sup>/<sub>2</sub>"

120 x 55mm	170-440-001
110 x 40mm	170-440-002
90 x 30mm	170-440-003

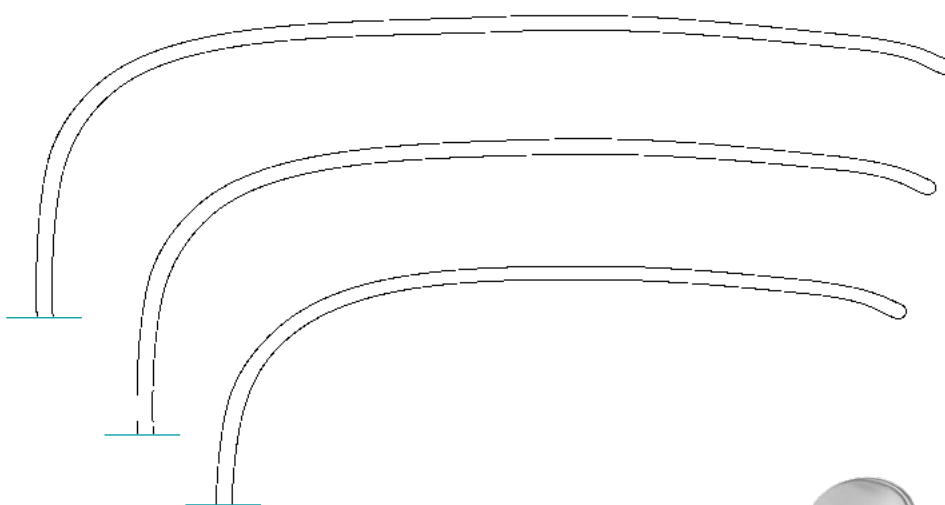

### FRITSCH

Retractor, 240mm, 9<sup>1</sup>/<sub>2</sub>"

45 x 40mm	170-447-040
45 x 50mm	170-447-050
45 x 60mm	170-447-060
55 x 75mm	170-447-075
65 x 85mm	170-447-085



### KOCHER

Retractor

70 x 25mm	170-449-225
220mm, 8 <sup>2</sup> / <sub>3</sub> "	
80 x 42mm	170-451-002
250mm, 9 <sup>7</sup> / <sub>8</sub> "	
80 x 50mm	170-451-003
250mm, 9 <sup>7</sup> / <sub>8</sub> "	
80 x 60mm	170-451-004
250mm, 9 <sup>7</sup> / <sub>8</sub> "	





### RICHARDSON EASTMAN

Retractor, 260mm, 10<sup>1</sup>/<sub>4</sub>" / 280mm, 11"

Set (Fig. 1+2) 170-381-000

Fig. 1,  
28 x 20mm /  
36 x 28mm

Fig. 2,  
40 x 38 mm /  
71 x 43 mm



### RICHARDSON

Retractor, loop handle, 240mm, 9<sup>1</sup>/<sub>2</sub>"

28 x 20mm 170-383-001

36 x 28mm 170-383-002

44 x 38mm 170-383-003

52 x 22mm 170-383-004



### RICHARDSON

Retractor, hollow grip handle, 240mm, 9<sup>1</sup>/<sub>2</sub>"

20 x 25mm 170-386-001

38 x 38mm 170-386-003

19 x 51mm 170-386-004

41 x 64mm 170-386-005

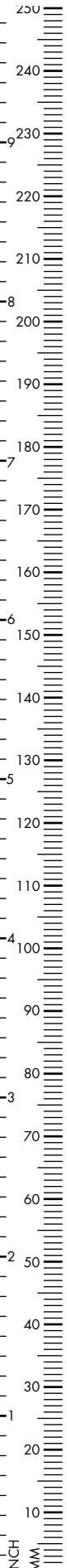



### KELLY

Retractor, loop handle, 240mm, 9<sup>1</sup>/<sub>2</sub>"

65 x 50mm	170-383-005
70 x 65mm	170-383-006
40 x 50mm	170-383-007
75 x 90mm	170-383-008
260mm, 10 <sup>1</sup> / <sub>4</sub> "	



### KELLY

Retractor, hollow grip handle, 245mm, 9<sup>2</sup>/<sub>3</sub>"

40 x 54mm	170-386-006
53 x 65mm	170-386-007
65 x 81mm	170-386-008



### MURPHY

Gallbladder Retractor, 50mm blade

280mm, 11"	170-500-255
------------	-------------



**DOYEN**

Retractor, 50x85mm

250mm, 9<sup>7</sup>/<sub>8</sub>"

170-461-250



**DOYEN**

Retractor, 280mm, 11"

60 x 95mm

170-879-001

65 x 105mm

170-879-002

65 x 115mm

170-879-003

65 x 125mm

170-879-004

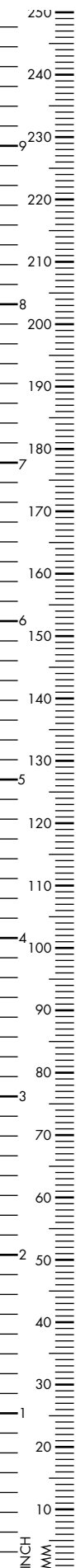



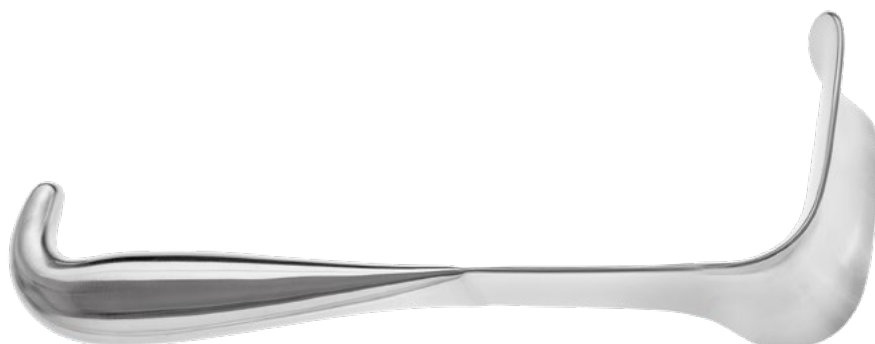

### TUFFIER

Retractor, 64 x 60mm

230mm, 9"

170-453-230



### DOYEN

Retractor, slightly concave, 220mm, 8<sup>2</sup>/<sub>3</sub>"

Fig. 1, 55 x 35mm 350-290-001

Fig. 2, 85 x 35mm 350-290-002

Fig. 3, 115 x 35mm 350-290-003

Fig. 1, 55 x 45mm 350-290-004

Fig. 2, 85 x 45mm 350-290-005

Fig. 3, 115 x 45mm 350-290-006

Fig. 4, 160 x 45mm 350-290-007

Fig. 1, 55 x 60mm 350-290-008

Fig. 2, 85 x 60mm 350-290-009

Fig. 3, 115 x 60mm 350-290-010

Fig. 4, 160 x 60mm 350-290-011



**MAYO**

Retractor, 70mm blade

275mm, 10<sup>7</sup>/<sub>8</sub>"

170-070-275



**WEINBERG**

Vagotomy Retractor

155 x 93mm / 54 x 51mm blades

220mm, 8<sup>2</sup>/<sub>3</sub>"

170-800-220



**MORRIS**

Retractor, 245mm, 9<sup>2</sup>/<sub>3</sub>"

70 x 38mm

170-465-380

70 x 50mm

170-465-510

70 x 65mm

170-465-650

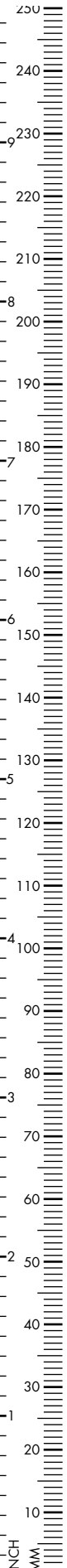



### MEYERDING

Retractor, 225mm, 8<sup>7/8</sup>"

90 x 50mm	170-490-500
75 x 25mm	170-475-160
50 x 16mm	170-450-160



### HIBBS

Retractor, 230mm, 9"

25 x 13mm	170-200-000
75 x 25mm	170-200-001
80 x 25mm	170-200-002



### SIMON

Retractor, 280mm, 11"

115 x 22mm	170-457-001
115 x 27mm	170-457-002

# HAND HELD RETRACTORS

## Hand Held Retractors



### BRUNNER

Retractor, 250mm, 9<sup>7</sup>/<sub>8</sub>"

80 x 20mm	170-471-008
100 x 20mm	170-471-010
120 x 25mm	170-471-012
140 x 25mm	170-471-014
160 x 30mm	170-471-016
180 x 30mm	170-471-018

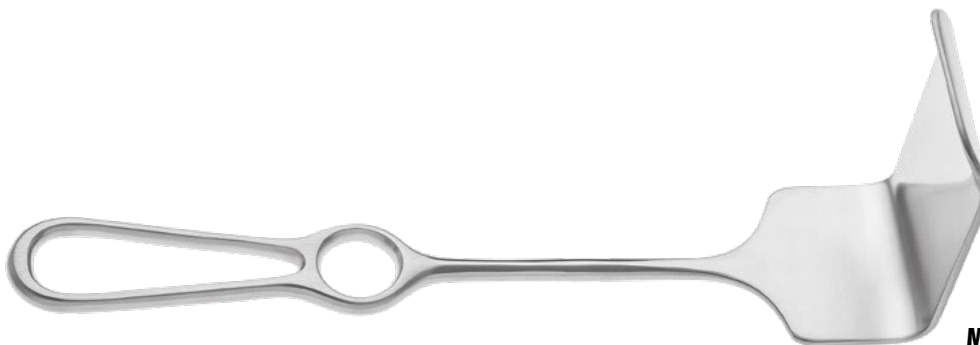

### MIKULICZ

Retractor, 90 x 50mm

260mm, 10 <sup>1</sup> / <sub>4</sub> "	170-607-260
---	-------------



### MIKULICZ

Retractor, 260mm, 10<sup>1</sup>/<sub>4</sub>"

85 x 35mm	170-489-001
120 x 50mm	170-489-002
150 x 50mm	170-489-003

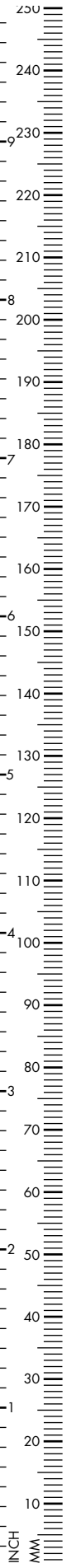



### KELLY

Retractor, 270mm, 10<sup>2</sup>/<sub>3</sub>"

160 x 38mm	170-531-260
160 x 57mm	170-530-260
190 x 38mm	170-533-260
190 x 57mm	170-532-260



### CORYLLOS

Retractor, 240mm, 9<sup>1</sup>/<sub>2</sub>"

115 x 65mm	170-461-003
108 x 43mm	170-461-002
82 x 22mm	170-461-001



### SAUERBRUCH

Retractor, 125 x 37mm

250mm, 9 <sup>7</sup> / <sub>8</sub> "	170-465-250
--	-------------



### ZENKER

Retractor

250mm, 9 <sup>7</sup> / <sub>8</sub> "	170-319-250
35 x 8mm	
260mm, 10 <sup>1</sup> / <sub>4</sub> "	170-319-260
60 x 12mm	
275mm, 10 <sup>7</sup> / <sub>8</sub> "	170-319-270
75 x 12mm	



### SEMB

Retractor, 250mm, 9<sup>7</sup>/<sub>8</sub>"

Fig. 1, 25 x 25mm	170-462-001
3 prongs	
Fig. 2, 25 x 20mm	170-462-002
4 prongs	



### LANGENBECK

Retractor, solid handle, 220mm, 8<sup>2</sup>/<sub>3</sub>"

30 x 11mm	170-222-220
30 x 14mm	170-222-221
30 x 16mm	170-222-222
40 x 11mm	170-222-223
50 x 11mm	170-222-224

fenestrated handle

30 x 11mm	170-293-001
30 x 14mm	170-293-002
30 x 16mm	170-293-003
40 x 11mm	170-293-004
50 x 11mm	170-293-005

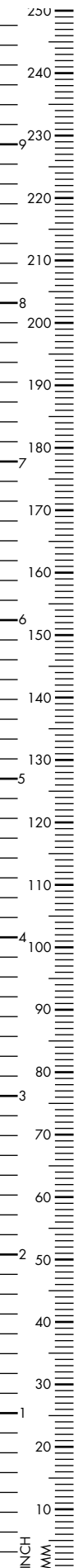



### KOCHER LANGENBECK

Retractor, 215mm, 8<sup>1/2</sup>"

22 x 6mm	170-317-022
25 x 8mm	170-317-025
25 x 6mm	170-317-026
35 x 8mm	170-317-035
35 x 11mm	170-317-036
35 x 15mm	170-317-037
40 x 11mm	170-317-040
55 x 11mm	170-317-055
70 x 15mm	170-317-070
80 x 12mm	170-317-080
80 x 15mm	170-317-081



### KOCHER

Retractor, 230mm, 9"

40 x 18mm	170-315-018
60 x 20mm	170-315-020
60 x 25mm	170-315-025
75 x 30mm	170-315-030
75 x 40mm	170-315-040



### SAUERBRUCH

Retractor, 225mm, 8<sup>7/8</sup>"

Fig. 1, 44 x 16mm	170-561-001
Fig. 2, 55 x 22mm	170-561-002
Fig. 3, 72 x 19mm	170-561-003



### HARRINGTON

Retractor, 320mm, 12<sup>1/2</sup>"

127 x 40mm	170-481-040
------------	-------------

127 x 62mm	170-481-062
------------	-------------



### HARRINGTON PEMBERTON

Retractor, 295mm, 11<sup>2/3</sup>"

175 x 64mm	170-481-295
------------	-------------



### WYLIE

Retractor, 310mm, 12<sup>1/4</sup>"

25 x 100mm	170-430-001
------------	-------------

25 x 180mm	170-430-002
------------	-------------

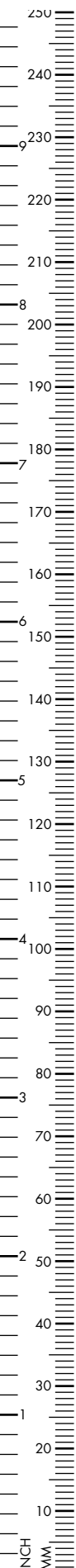





**ALLISON**

Lung Spatula, 40mm

---

300mm, 11<sup>7</sup>/<sub>8</sub>" 290-505-300

54mm

---

320mm, 12<sup>1</sup>/<sub>2</sub>" 290-505-320

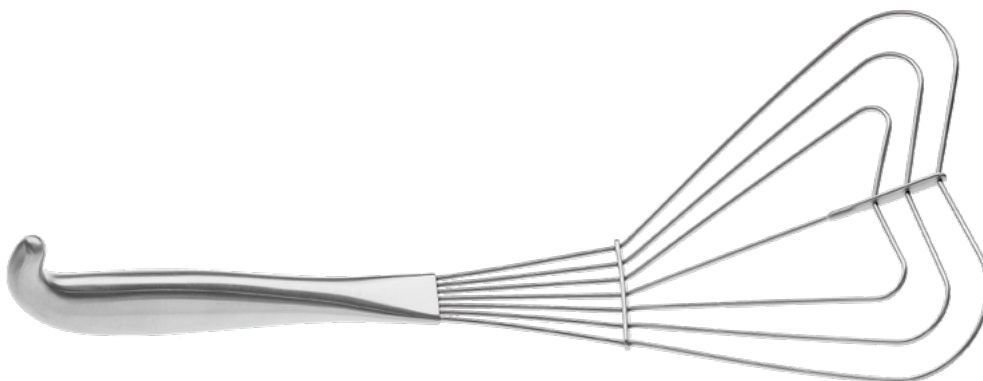

Lung Spatula

---

300mm, 11<sup>7</sup>/<sub>8</sub>" 290-511-260



### ROCHARD

Mounting Frame for one side

260mm / 530mm	170-950-000
(26" / 21")	



### ROCHARD

Fixation Device

190mm, 7 <sup>1/2</sup> "	170-950-050
---------------------------	-------------

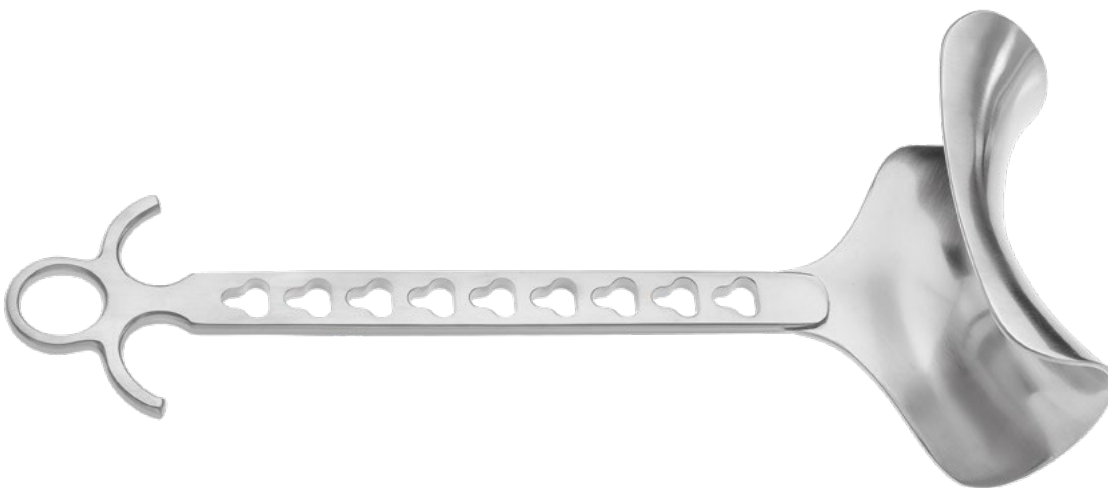

### ROCHARD

Retractor, 280mm, 11"

48 x 90mm	170-950-090
48 x 105mm	170-950-105
48 x 120mm	170-950-115
48 x 135mm	170-950-135
48 x 155mm	170-950-155

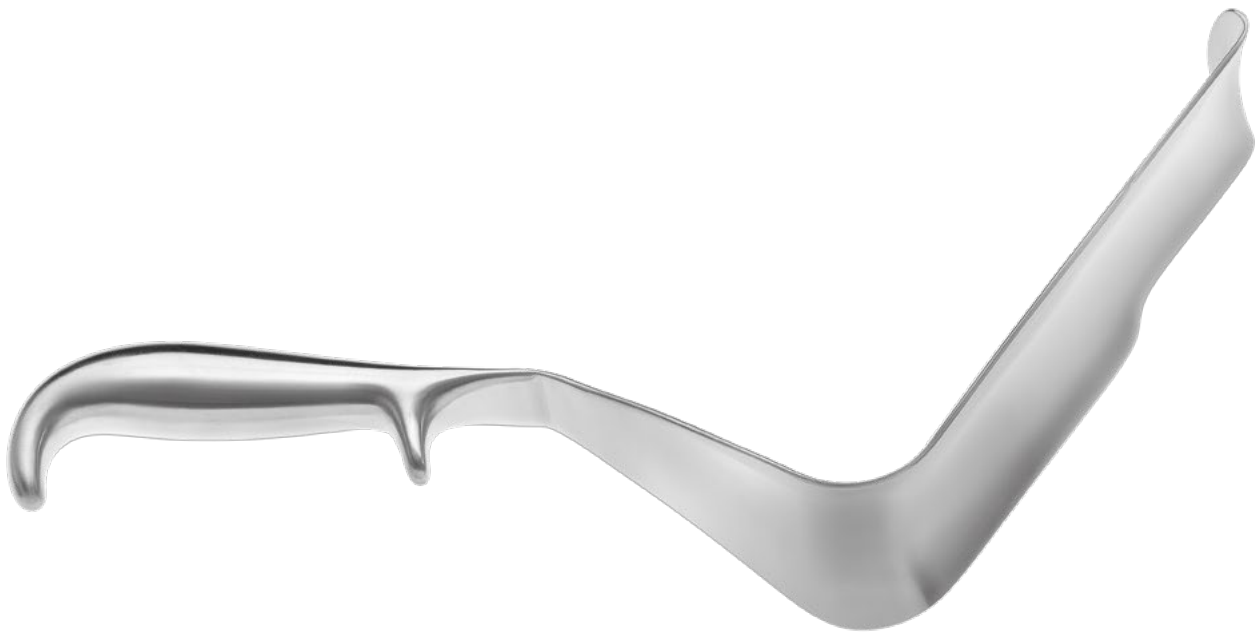

### ST. MARKS

Pelvic Retractor with lip,  
130x60mm

290mm, 11 <sup>1</sup> / <sub>2</sub> "	170-493-001
---	-------------

180x60mm	
----------	--

330mm, 13"	170-493-002
------------	-------------

180x60mm, without lip	
-----------------------	--

330mm, 13"	170-493-003
------------	-------------



### LERICHE

Retractor, 275mm, 10<sup>7</sup>/<sub>8</sub>"

45mm	170-245-275
------	-------------

60mm	170-260-275
------	-------------



**KUEMMEL**

Abdominal Retractor, 100 x 45mm

280mm, 11" 170-621-280



**KOERTE**

Abdominal Retractor, 120 x 47mm

280mm, 11" 170-617-280



**DEAVER WILLAUER**

Retractor, 160 x 25mm

380mm, 15" 170-160-025

160x50mm

390mm, 15<sup>1/4</sup>" 170-160-050

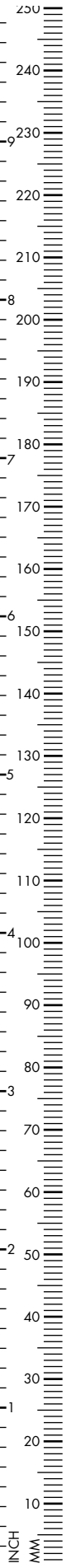

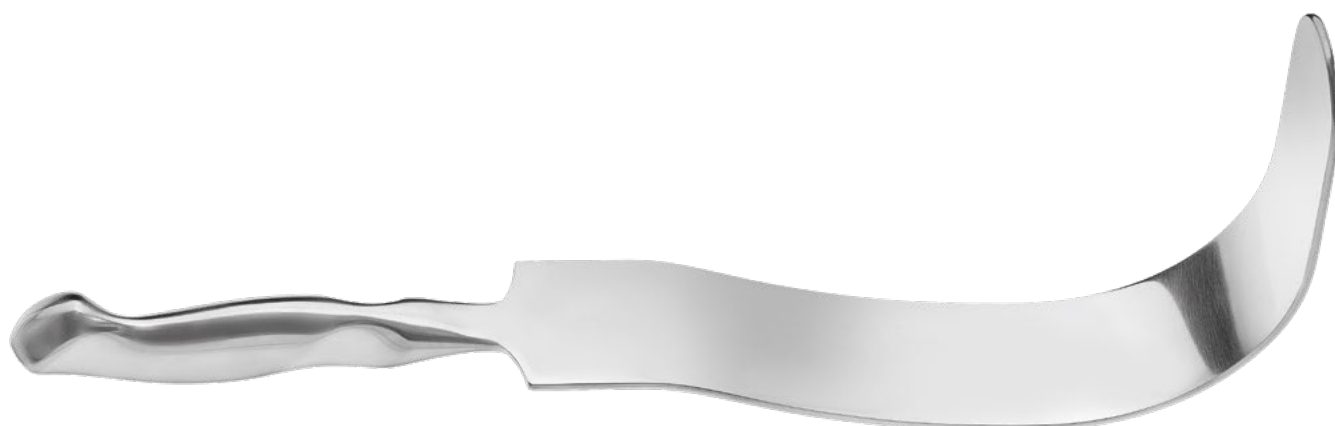

### DEAVER FORD

Retractor with lip, 420mm, 16<sup>1/2</sup>"

255 x 150 x 50mm	170-420-050
255 x 150 x 75mm	170-420-075
255 x 150 x 100mm	170-420-100



### DEAVER

Retractor, hollow handle, 250mm, 9<sup>7/8</sup>"

25 x 254mm	170-483-024
25 x 300mm	170-483-025
25 x 330mm	170-483-026
38 x 300mm	170-483-038
50 x 310mm	170-483-050
75 x 300mm	170-483-075
100 x 300mm	170-483-100

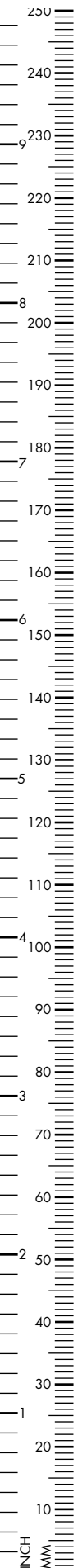

### DEAVER

Retractor, smooth working end,  
180mm, 7"

19mm	170-591-180
------	-------------

serrated working end

19mm	171-591-180
------	-------------

smooth working end,  
215mm, 8<sup>1/2</sup>"

22mm	170-591-215
------	-------------

serrated working end

22mm	171-591-215
------	-------------



### DEAVER

Retractor, smooth working end,  
230mm, 9"

25mm	170-591-230
------	-------------

serrated working end,  
230mm, 9"

25mm	171-591-230
------	-------------

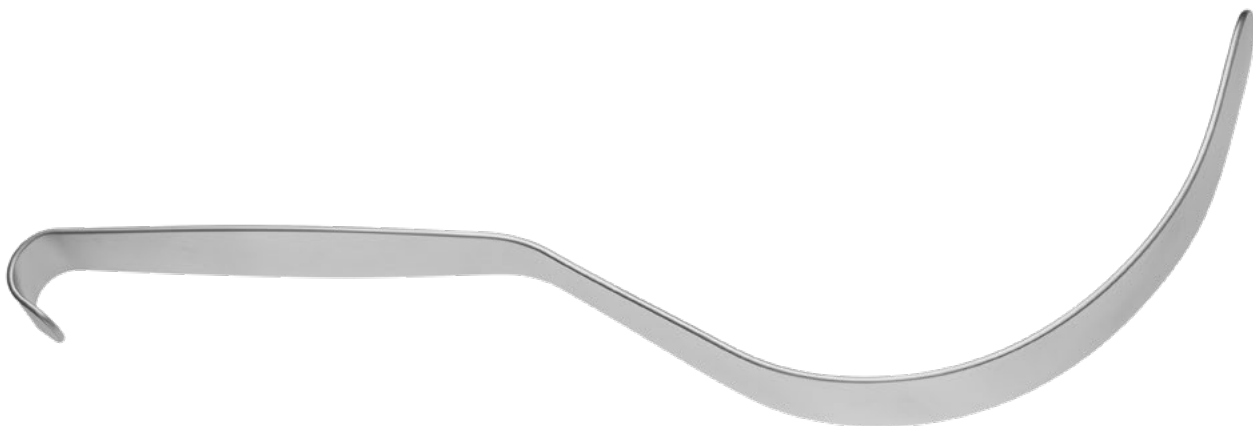

### DEAVER

Retractor, smooth working end, 25mm

300mm, 11 <sup>7/8</sup> "	170-591-300
----------------------------	-------------

330mm, 13"	170-591-330
------------	-------------

360mm, 14 <sup>1/8</sup> "	170-591-360
----------------------------	-------------

300mm, 11<sup>7/8</sup>"

38mm	170-593-300
------	-------------

50mm	170-595-300
------	-------------

75mm	170-597-300
------	-------------

100mm	170-598-300
-------	-------------

serrated working end, 25mm

300mm, 11 <sup>7/8</sup> "	171-591-300
----------------------------	-------------

330mm, 13"	171-591-330
------------	-------------

360mm, 14 <sup>1/8</sup> "	171-591-360
----------------------------	-------------

300mm, 11<sup>7/8</sup>"

38mm	171-593-300
------	-------------

50mm	171-595-300
------	-------------

75mm	171-597-300
------	-------------

100mm	171-598-300
-------	-------------

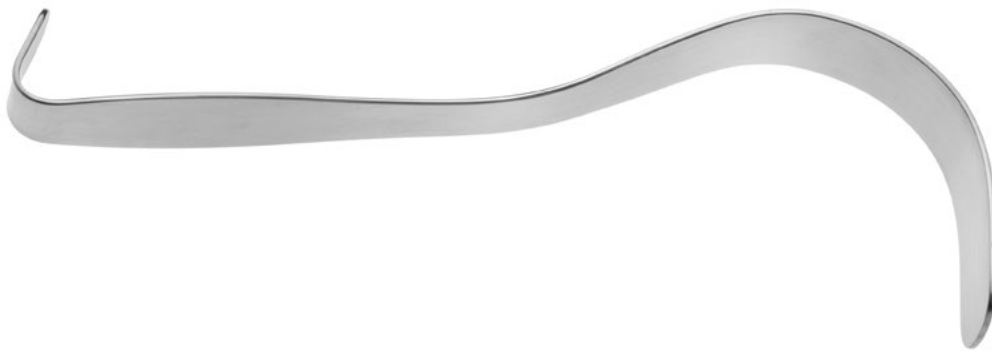
**DEAVER**

Retractor

25x265mm

170-025-265

**DEAVER**

Retractor, pediatric size

10x180mm

170-010-180

**DEAVER**Retractor, pediatric size, 170mm, 6<sup>2</sup>/<sub>3</sub>"

8mm

170-008-170

10mm

170-010-170

15mm

170-015-170

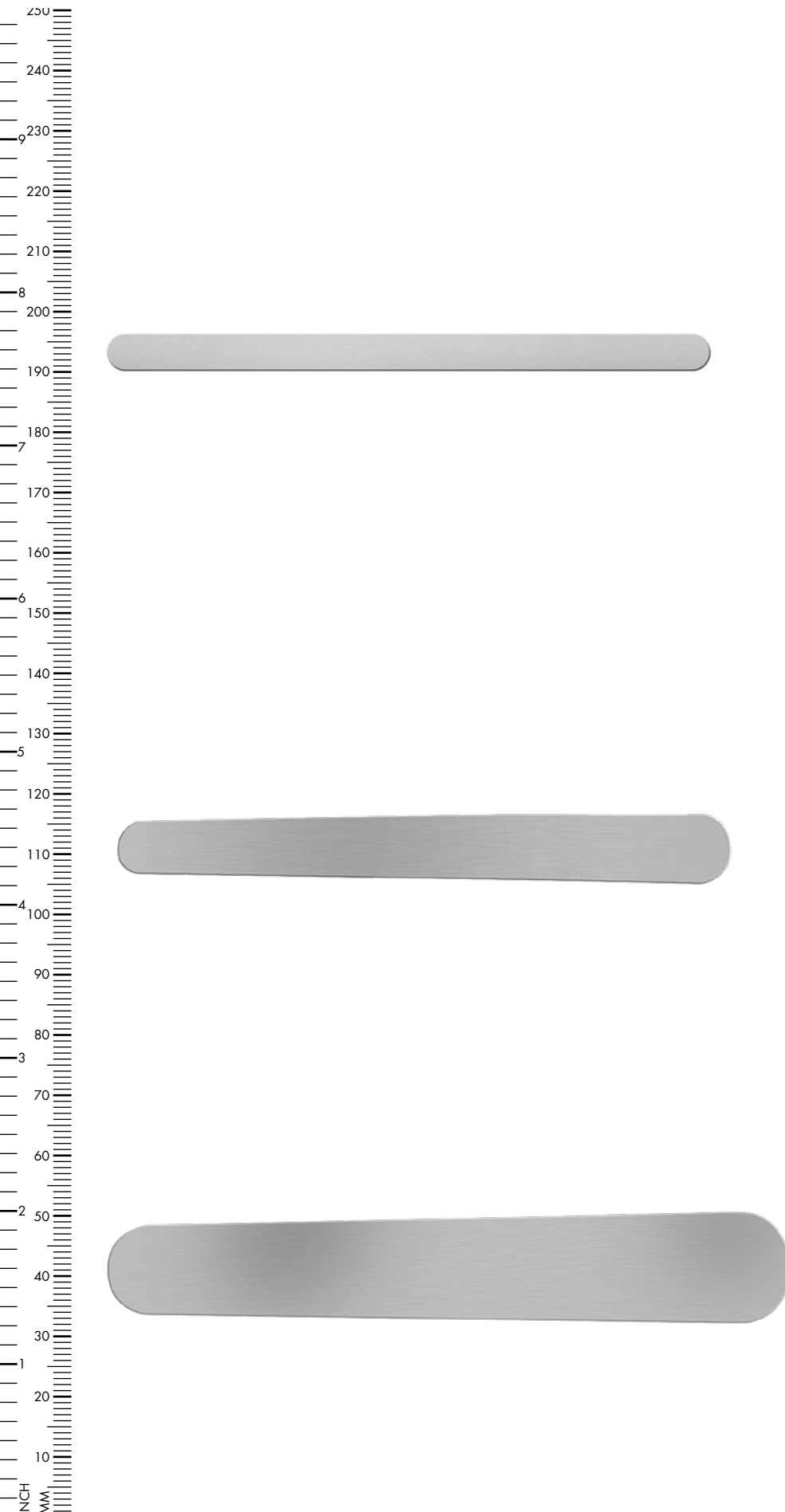

### RIBBON

Abdominal Retractor, malleable

200 x 6mm	170-973-006
200 x 12mm	170-973-012
200 x 17mm	170-973-017
200 x 20mm	170-973-020
250 x 25mm	170-973-025

330 x 10mm	170-963-010
330 x 13mm	170-963-013
330 x 20mm	170-963-019
330 x 25mm	170-963-025
330 x 32mm	170-963-032
330 x 40mm	170-963-040
330 x 50mm	170-963-050
330 x 68mm	170-963-068

### TUFFIER

Abdominal Retractor, malleable

200 x 25mm	170-975-250
------------	-------------

### HABERER

Abdominal Retractor, malleable

280 x3 5mm 25/30mm	170-971-250
300 x 37mm 37/45mm	170-971-300
300 x 40mm 40/50mm	170-971-370



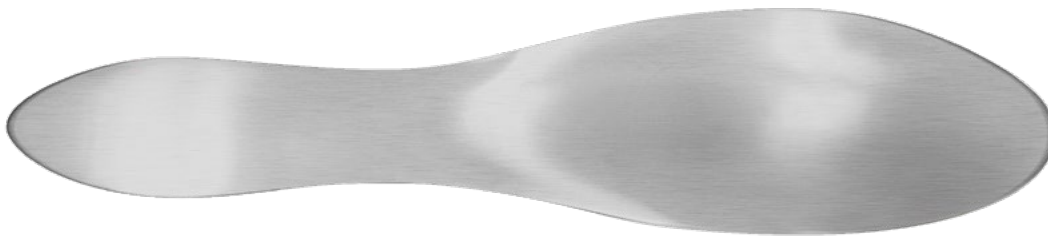

### REVERDIN

Abdominal Retractor

280 x 45/60mm 170-953-280



### RIBBON

Retractor, hollow handle, 460mm, 18"

19mm	170-964-019
25mm	170-964-025
32mm	170-964-032
38mm	170-964-038
51mm	170-964-050



### KADER

Retractor, 270mm, 10<sup>2</sup>/<sub>3</sub>"

30mm	170-623-300
40mm	170-623-400

