

# SCISSORS



Surgical Scissors  
Dissecting Scissors  
Bandage and Cloth Scissors  
Plaster Scissors  
Wire Scissors  
Suture Scissors  
Ligature Scissors  
Orthopaedics Scissors  
Neuro Scissors  
Vascular Scissors  
Vessel Scissors  
Eye Scissors  
Tenotomy Scissors  
ENT Scissors  
Plastic Scissors  
Gynecology Scissors  
Supercut Scissors  
Tungsten Carbide TC Scissors  
CeraCut® Scissors



Fig. 1



Fig. 2



Fig. 3

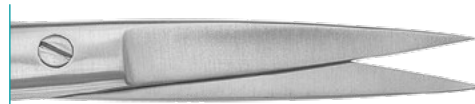

### STANDARD

Fig. 1 (blunt/blunt), straight

115mm, 4 <sup>1</sup> / <sub>2</sub> "	120-010-115
130mm, 5 <sup>1</sup> / <sub>8</sub> "	120-010-130
145mm, 5 <sup>3</sup> / <sub>4</sub> "	120-010-145
155mm, 6 <sup>1</sup> / <sub>8</sub> "	120-010-155
165mm, 6 <sup>1</sup> / <sub>2</sub> "	120-010-165
175mm, 6 <sup>7</sup> / <sub>8</sub> "	120-010-175
185mm, 7 <sup>1</sup> / <sub>4</sub> "	120-010-185
200mm, 8"	120-010-200
curved	
115mm, 4 <sup>1</sup> / <sub>2</sub> "	120-011-115
130mm, 5 <sup>1</sup> / <sub>8</sub> "	120-011-130
145mm, 5 <sup>3</sup> / <sub>4</sub> "	120-011-145
155mm, 6 <sup>1</sup> / <sub>8</sub> "	120-011-155
165mm, 6 <sup>1</sup> / <sub>2</sub> "	120-011-165
175mm, 6 <sup>7</sup> / <sub>8</sub> "	120-011-175
185mm, 7 <sup>1</sup> / <sub>4</sub> "	120-011-185
200mm, 8"	120-011-200

Fig. 2 (sharp/blunt), straight

115mm, 4 <sup>1</sup> / <sub>2</sub> "	120-012-115
130mm, 5 <sup>1</sup> / <sub>8</sub> "	120-012-130
145mm, 5 <sup>3</sup> / <sub>4</sub> "	120-012-145
155mm, 6 <sup>1</sup> / <sub>8</sub> "	120-012-155
165mm, 6 <sup>1</sup> / <sub>2</sub> "	120-012-165
175mm, 6 <sup>7</sup> / <sub>8</sub> "	120-012-175
185mm, 7 <sup>1</sup> / <sub>4</sub> "	120-012-185
200mm, 8"	120-012-200
curved	
115mm, 4 <sup>1</sup> / <sub>2</sub> "	120-013-115
130mm, 5 <sup>1</sup> / <sub>8</sub> "	120-013-130
145mm, 5 <sup>3</sup> / <sub>4</sub> "	120-013-145
155mm, 6 <sup>1</sup> / <sub>8</sub> "	120-013-155
165mm, 6 <sup>1</sup> / <sub>2</sub> "	120-013-165
175mm, 6 <sup>7</sup> / <sub>8</sub> "	120-013-175
185mm, 7 <sup>1</sup> / <sub>4</sub> "	120-013-185
200mm, 8"	120-013-200

Fig. 3 (sharp/sharp), straight

115mm, 4 <sup>1</sup> / <sub>2</sub> "	120-014-115
130mm, 5 <sup>1</sup> / <sub>8</sub> "	120-014-130
145mm, 5 <sup>3</sup> / <sub>4</sub> "	120-014-145
155mm, 6 <sup>1</sup> / <sub>8</sub> "	120-014-155
165mm, 6 <sup>1</sup> / <sub>2</sub> "	120-014-165
curved	
115mm, 4 <sup>1</sup> / <sub>2</sub> "	120-015-115
130mm, 5 <sup>1</sup> / <sub>8</sub> "	120-015-130
145mm, 5 <sup>3</sup> / <sub>4</sub> "	120-015-145
155mm, 6 <sup>1</sup> / <sub>8</sub> "	120-015-155
165mm, 6 <sup>1</sup> / <sub>2</sub> "	120-015-165

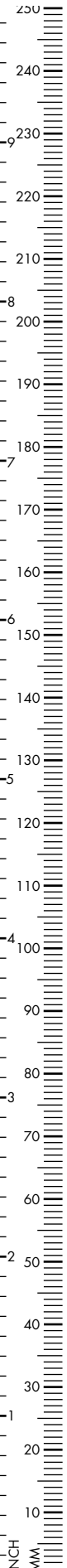

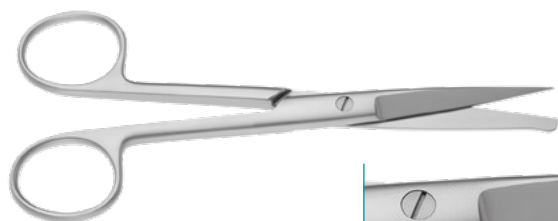

### GRAZIL

straight, blunt/blunt

130mm, 5<sup>1</sup>/<sub>8</sub>" 120-016-130

145mm, 5<sup>3</sup>/<sub>4</sub>" 120-016-145

curved

130mm, 5<sup>1</sup>/<sub>8</sub>" 120-017-130

145mm, 5<sup>3</sup>/<sub>4</sub>" 120-017-145

straight, sharp/blunt

130mm, 5<sup>1</sup>/<sub>8</sub>" 120-018-130

145mm, 5<sup>3</sup>/<sub>4</sub>" 120-018-145

curved

130mm, 5<sup>1</sup>/<sub>8</sub>" 120-019-130

145mm, 5<sup>3</sup>/<sub>4</sub>" 120-019-145

straight, sharp/sharp

130mm, 5<sup>1</sup>/<sub>8</sub>" 120-020-130

145mm, 5<sup>3</sup>/<sub>4</sub>" 120-020-145

curved

130mm, 5<sup>1</sup>/<sub>8</sub>" 120-021-130

145mm, 5<sup>3</sup>/<sub>4</sub>" 120-021-145

Incision Scissors, straight

130mm, 5<sup>1</sup>/<sub>8</sub>" 120-022-130

145mm, 5<sup>3</sup>/<sub>4</sub>" 120-022-145

### DEAVER

straight, 120mm 4<sup>3</sup>/<sub>4</sub>"

blunt/blunt 120-026-120

blunt/sharp 120-024-120

sharp/sharp 120-028-120

curved, 120mm 4<sup>3</sup>/<sub>4</sub>"

blunt/blunt 120-027-120

blunt/sharp 120-025-120

sharp/sharp 120-029-120

145mm, 5<sup>3</sup>/<sub>4</sub>", sharp/blunt

straight 120-024-145

curved 120-025-145

145mm, 5<sup>3</sup>/<sub>4</sub>"

straight, blunt/blunt 120-026-145

curved, blunt/blunt 120-027-145

straight, sharp/sharp 120-028-145

curved, sharp/sharp 120-029-145



### MAYO

straight

145mm, 5 <sup>3</sup> / <sub>4</sub> "	120-030-145
150mm, 6"	120-030-150
170mm, 6 <sup>2</sup> / <sub>3</sub> "	120-030-170

curved

145mm, 5 <sup>3</sup> / <sub>4</sub> "	120-031-145
150mm, 6"	120-031-150
170mm, 6 <sup>2</sup> / <sub>3</sub> "	120-031-170



### MAYO STILLE

straight

150mm, 6"	120-036-150
170mm, 6 <sup>2</sup> / <sub>3</sub> "	120-036-170
195mm, 7 <sup>3</sup> / <sub>4</sub> "	120-036-195
210mm, 8 <sup>1</sup> / <sub>4</sub> "	120-036-210

curved

150mm, 6"	120-037-150
170mm, 6 <sup>2</sup> / <sub>3</sub> "	120-037-170
195mm, 7 <sup>3</sup> / <sub>4</sub> "	120-037-195
210mm, 8 <sup>1</sup> / <sub>4</sub> "	120-037-210

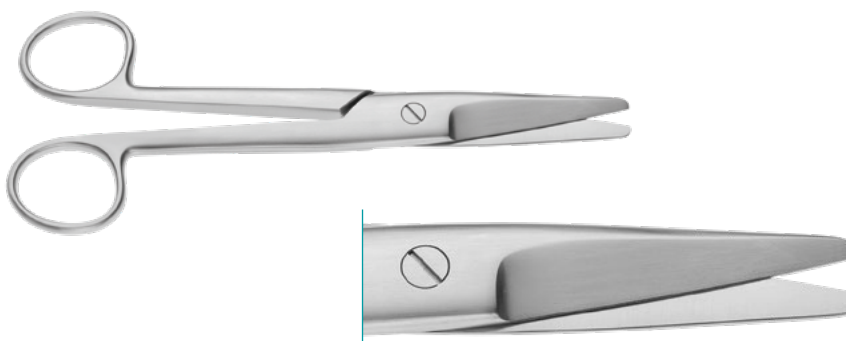

### MAYO NOBLE

straight

170mm, 6 <sup>2</sup> / <sub>3</sub> "	120-048-170
--	-------------

curved

170mm, 6 <sup>2</sup> / <sub>3</sub> "	120-049-170
190mm, 7 <sup>1</sup> / <sub>2</sub> "	120-049-190

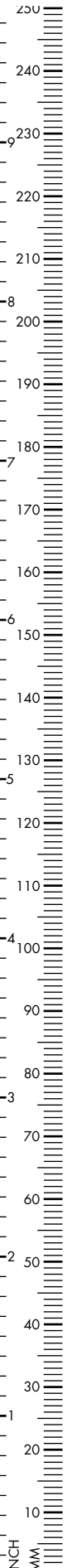





### LEXER BABY

Dissecting Scissors, blunt/blunt, 105mm, 4<sup>1</sup>/<sub>8</sub>"

straight	120-136-100
curved	120-137-100



### LEXER

Dissecting Scissors, 160mm, 6<sup>1</sup>/<sub>4</sub>"

straight	120-126-160
curved	120-127-160

210mm, 8<sup>1</sup>/<sub>4</sub>"

straight	120-126-210
curved	120-127-210

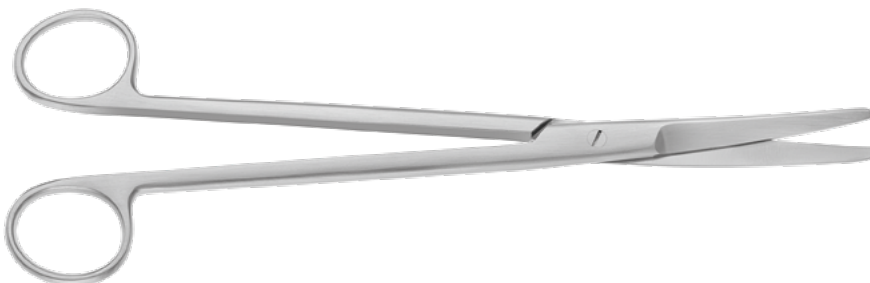

### MAYO HARRINGTON

Dissecting Scissors, straight

230mm, 9"	120-030-230
280mm, 11"	120-030-280

curved

230mm, 9"	120-031-230
280mm, 11"	120-031-280

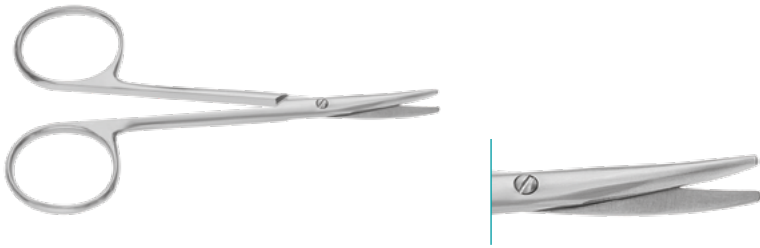

### BABY METZENBAUM

straight

115mm, 4 <sup>1</sup> / <sub>2</sub> "	120-110-115
--	-------------

curved

115mm, 4 <sup>1</sup> / <sub>2</sub> "	120-111-115
--	-------------



### METZENBAUM

straight

145mm, 5 <sup>3</sup> / <sub>4</sub> "	120-110-145
--	-------------

160mm, 6 <sup>1</sup> / <sub>4</sub> "	120-110-160
--	-------------

curved

145mm, 5 <sup>3</sup> / <sub>4</sub> "	120-111-145
--	-------------

160mm, 6 <sup>1</sup> / <sub>4</sub> "	120-111-160
--	-------------

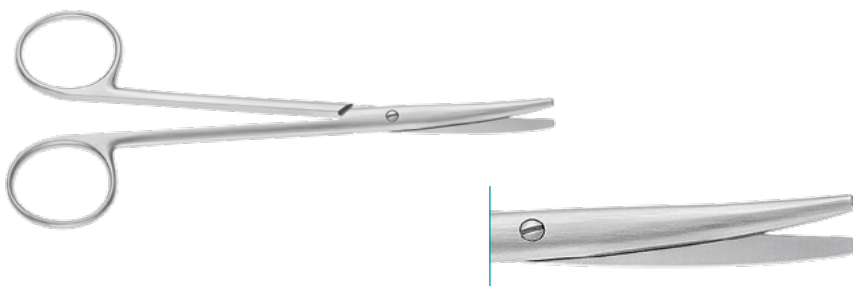

### METZENBAUM LAHEY

curved

145mm, 5 <sup>3</sup> / <sub>4</sub> "	120-330-145
--	-------------

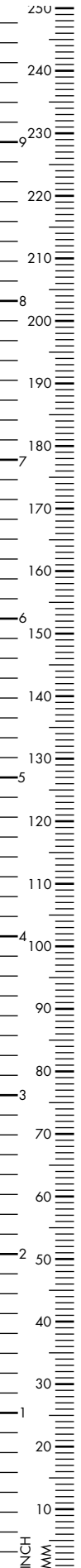

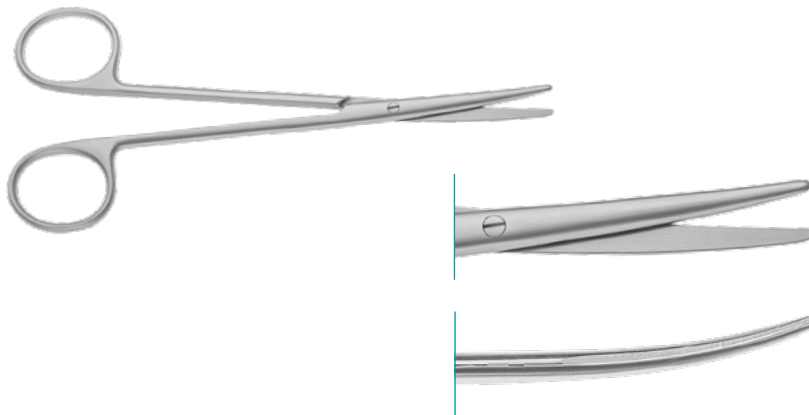

### METZENBAUM FINO

straight

145mm, 5 <sup>3</sup> / <sub>4</sub> "	120-152-145
180mm, 7"	120-152-180
200mm, 8"	120-152-200
230mm, 9"	120-152-230

curved

145mm, 5 <sup>3</sup> / <sub>4</sub> "	120-153-145
180mm, 7"	120-153-180
200mm, 8"	120-153-200
230mm, 9"	120-153-230

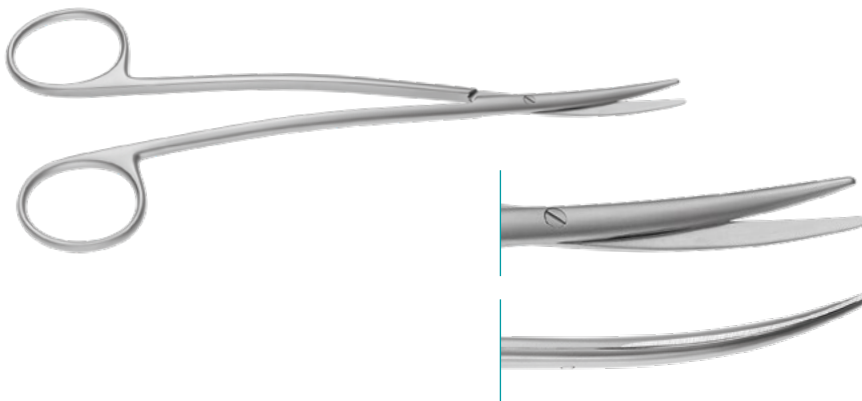

### METZENBAUM FINO

s-shaped, blunt

180mm, 7"	120-157-180
200mm, 8"	120-157-200
230mm, 9"	120-157-230

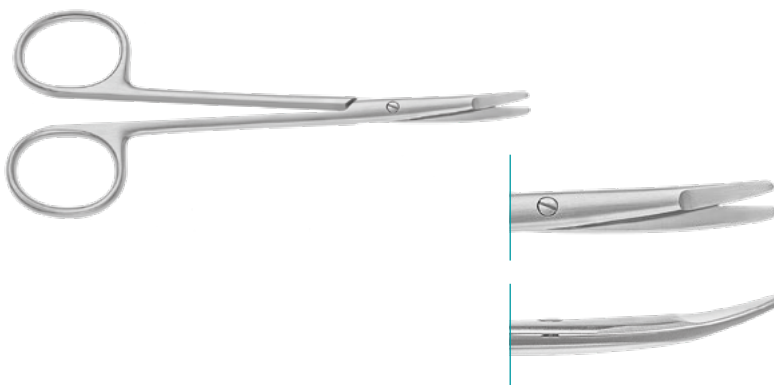

### KILNER RAGNELL

curved, blunt

130mm, 5 <sup>1</sup> / <sub>8</sub> "	120-065-130
150mm, 6"	120-065-150
180mm, 7"	120-065-180
200mm, 8"	120-065-200
230mm, 9"	120-065-230



### METZENBAUM NELSON

blunt, straight

180mm, 7"	120-110-180
200mm, 8"	120-110-200
230mm, 9"	120-110-230
250mm, 9 <sup>7</sup> / <sub>8</sub> "	120-110-250
280mm, 11"	120-110-280
300mm, 11 <sup>7</sup> / <sub>8</sub> "	120-110-300

blunt, curved

180mm, 7"	120-111-180
200mm, 8"	120-111-200
230mm, 9"	120-111-230
250mm, 9 <sup>7</sup> / <sub>8</sub> "	120-111-250
280mm, 11"	120-111-280
300mm, 11 <sup>7</sup> / <sub>8</sub> "	120-111-300

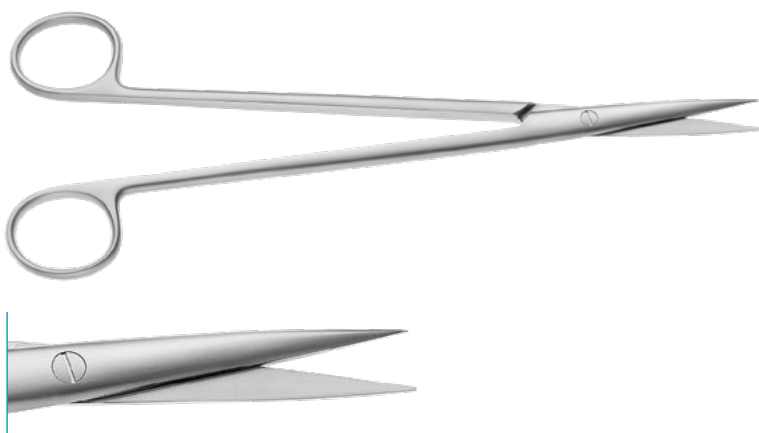

### METZENBAUM NELSON

straight, sharp/sharp

145mm, 5 <sup>3</sup> / <sub>4</sub> "	120-114-145
180mm, 7"	120-114-180
200mm, 8"	120-114-200

curved, sharp/sharp

145mm, 5 <sup>3</sup> / <sub>4</sub> "	120-115-145
180mm, 7"	120-115-180
200mm, 8"	120-115-200

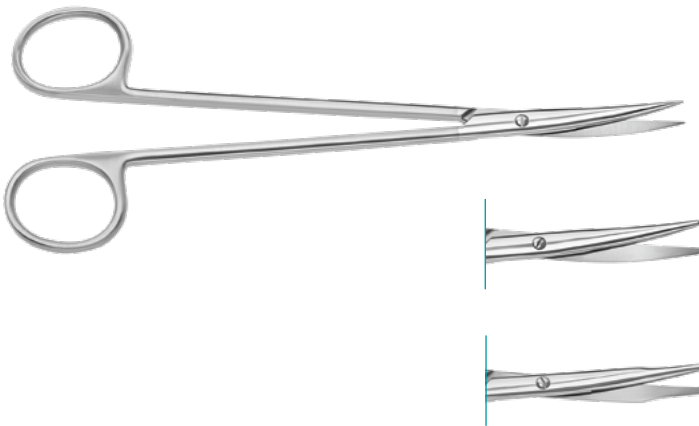

### LILLEHEI POTTS

straight, 180mm, 7"

sharp 125-322-180

blunt 125-326-180

blunt, tenotomy 125-328-180

curved, 180mm, 7"

sharp 125-323-180

blunt 125-327-180

blunt, tenotomy 125-329-180

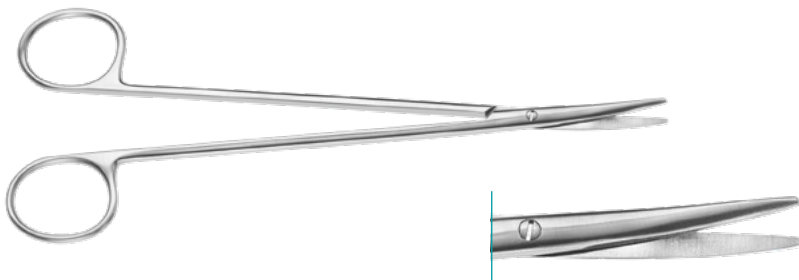

### DEBAKEY

Dissecting Scissors, slightly curved

175mm, 6<sup>7</sup>/<sub>8</sub>" 120-135-175

200mm, 8" 120-135-200

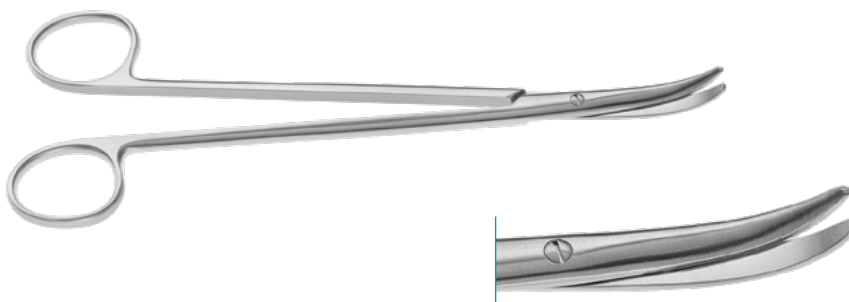

### THOREK

Dissecting Scissors

190mm, 7<sup>1</sup>/<sub>2</sub>" 120-133-190

230mm, 9" 120-133-230



### COTTLE MASING

Nasal pasticc scissors, curved, 105mm, 4<sup>1</sup>/<sub>8</sub>"

blunt 120-112-110

sharp 120-110-110



### BROWN

Dissecting Scissors, curved

140mm, 5<sup>1</sup>/<sub>2</sub>" 120-048-140

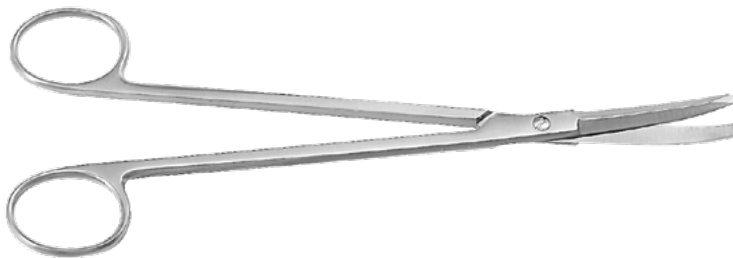

### POTTS SMITH

Dissecting Scissors, curved

145mm, 5<sup>3</sup>/<sub>4</sub>" 120-216-145

190mm, 7<sup>1</sup>/<sub>2</sub>" 120-216-190

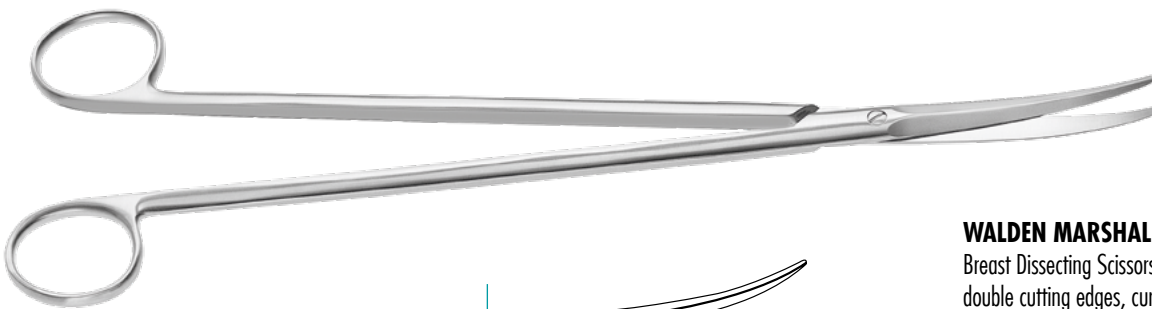

A

B

C

D

### WALDEN MARSHALL

Breast Dissecting Scissors,  
double cutting edges, curved

230mm, 9" 120-580-230

250mm, 9<sup>7</sup>/<sub>8</sub>" 120-580-250

305mm, 12" 120-580-305

355mm, 14" 120-580-355

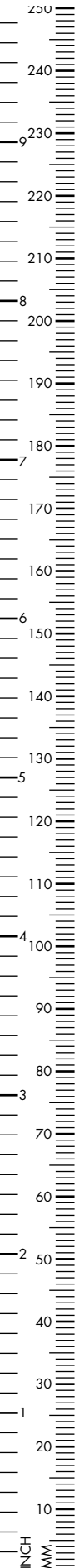

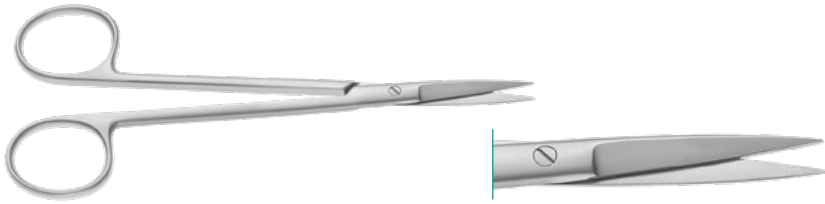

### JOSEPH

sharp, 140mm, 5<sup>1</sup>/<sub>2</sub>"

straight	120-058-140
curved	120-059-140



### KELLY

160mm, 6<sup>1</sup>/<sub>4</sub>"

straight	120-046-160
curved	120-047-160

200mm, 8"

straight	120-046-200
curved	120-047-200

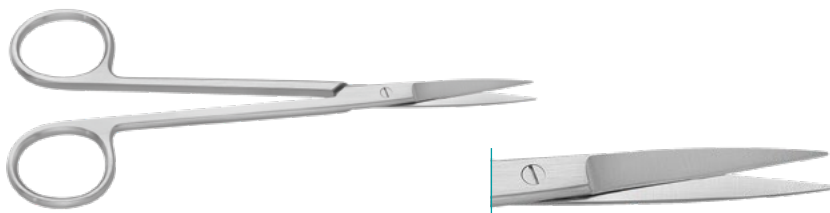

### SANVENERO

sharp, 140mm, 5<sup>1</sup>/<sub>2</sub>"

straight	120-056-140
curved	120-057-140



### REYNOLDS

curved

150mm, 6"	120-043-150
-----------	-------------

180mm, 7"	120-043-180
-----------	-------------

curved, toothed

150mm, 6"	120-043-151
-----------	-------------

180mm, 7"	120-043-181
-----------	-------------

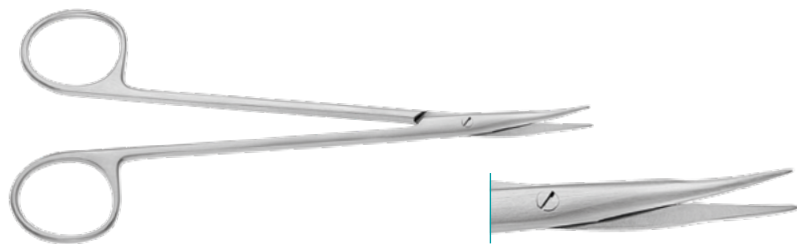

### JAMESON WERBER

curved

130mm, 5 <sup>1</sup> / <sub>8</sub> "	120-313-130
--	-------------



### JAMESON

curved, blunt

150mm, 6"	120-315-150
-----------	-------------

180mm, 7"	120-315-180
-----------	-------------

200mm, 8"	120-315-200
-----------	-------------

230mm, 9"	120-315-230
-----------	-------------





### LISTER

Bandage Scissors

90mm, 3 <sup>1</sup> / <sub>2</sub> "	190-165-090
110mm, 4 <sup>1</sup> / <sub>3</sub> "	190-165-110
140mm, 5 <sup>1</sup> / <sub>2</sub> "	190-165-140
180mm, 7"	190-165-180
200mm, 8"	190-165-200



### LISTER

Bandage Scissors with 1 large ring

210mm, 8 <sup>1</sup> / <sub>4</sub> "	190-170-210
--	-------------



### KNOWLES

Bandage Scissors, 140mm, 5<sup>1</sup>/<sub>2</sub>"

Straight	190-160-140
Angled	190-161-140
Straight, knee bent shanks	190-162-140



**UNIVERSAL**

small, 140mm, 5 1/2"

black	190-209-151
red	190-209-152
yellow	190-209-153
green	190-209-154



**UNIVERSAL**

large, 180mm, 7"

blue	190-209-180
black	190-209-181
red	190-209-182
yellow	190-209-183
green	190-209-184
orange	190-209-185

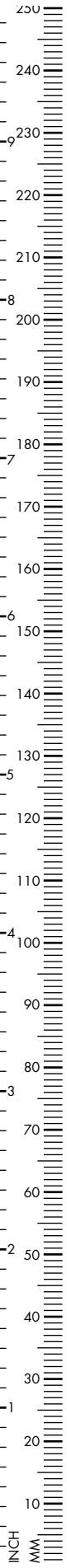



**LORENZ**

Bandage Scissors, curved

230mm, 9"

190-155-230



**BERGMANN**

Plaster Scissors

230mm, 9"

190-195-230



**ESMARCH**

Plaster Scissors

200mm, 8"

190-205-200

220mm, 8<sup>2/3</sup>"

190-205-220

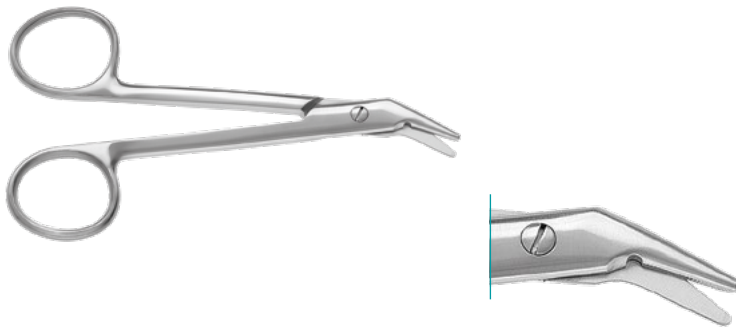

Wire Cutting Scissors, serrated

120mm, 4 <sup>3</sup> / <sub>4</sub> "	120-265-120
--	-------------

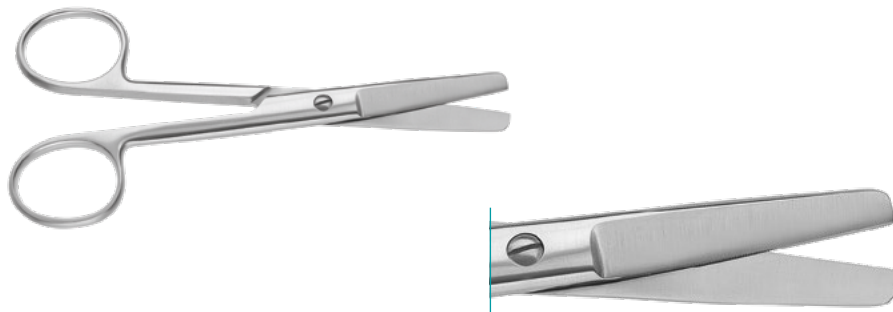

### HARVEY

Wire Cutting Scissors, both serrated blade, straight

125mm, 5"	120-262-125
-----------	-------------

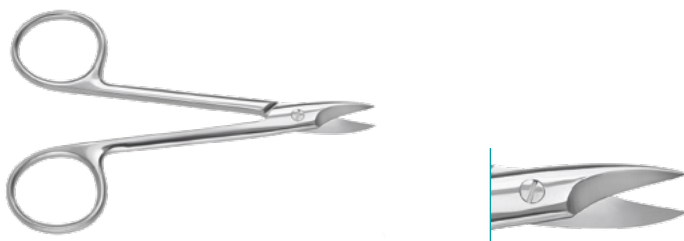

Crown & Collar Scissors, straight, serrated

100mm, 4"	120-296-100
-----------	-------------

120mm, 4 <sup>3</sup> / <sub>4</sub> "	120-296-120
--	-------------

curved

100mm, 4"	120-297-100
-----------	-------------

120mm, 4 <sup>3</sup> / <sub>4</sub> "	120-297-120
--	-------------

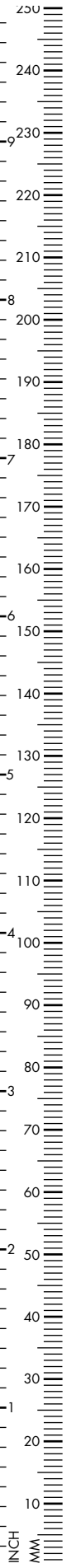



### SPENCER

Suture Scissors, straight

90mm, 3 <sup>1</sup> / <sub>2</sub> "	120-220-090
---------------------------------------	-------------

130mm, 5 <sup>1</sup> / <sub>8</sub> "	120-220-130
--	-------------

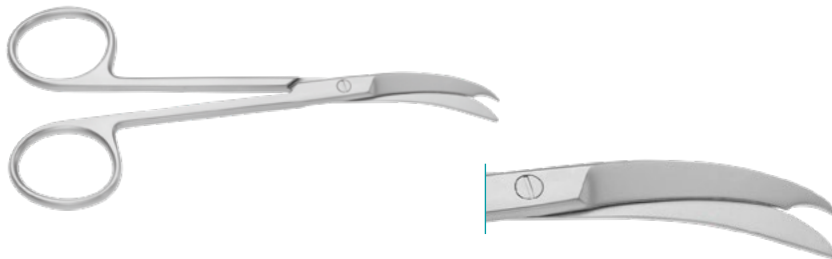

### NORTHBENT

Ligature Scissors, curved

130mm, 5 <sup>1</sup> / <sub>8</sub> "	120-222-130
--	-------------

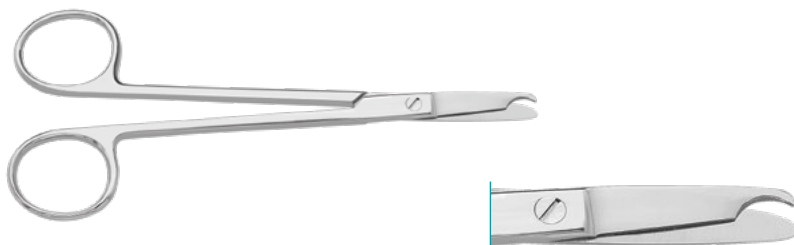

### LITTAUER

Ligature Scissors, straight

115mm, 4 <sup>1</sup> / <sub>2</sub> "	120-224-115
--	-------------

140mm, 5 <sup>1</sup> / <sub>2</sub> "	120-224-140
--	-------------



Stitch Removal Scissors, curved, ribbon handle  
100mm, 4" 120-078-100



**BUCK**  
Ligature Scissors, straight  
145mm, 5<sup>3</sup>/<sub>4</sub>" 120-228-145  
180mm, 7" 120-228-180



Ligature Scissors, SC, TC inserts, curved,  
serrated blades  
115mm, 4<sup>1</sup>/<sub>2</sub>" 120-611-115  
140mm, 5<sup>1</sup>/<sub>2</sub>" 120-611-140  
180mm, 7" 120-611-180  
230mm, 9" 120-611-230

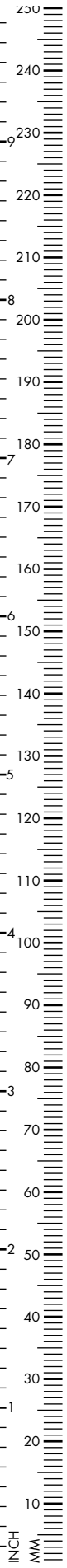
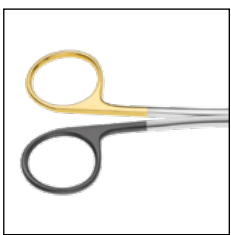

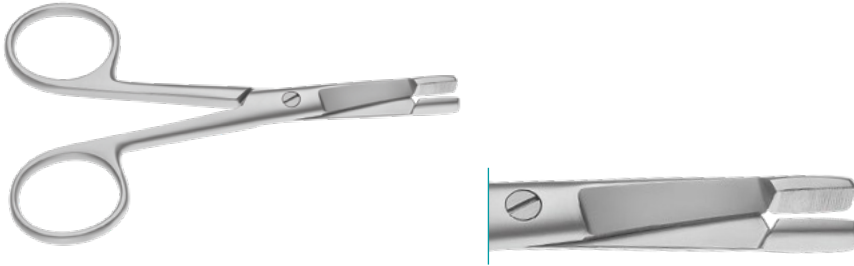

**EISELSBERG**  
Ligature Scissors

120mm, 4<sup>3/4</sup>"

120-230-120

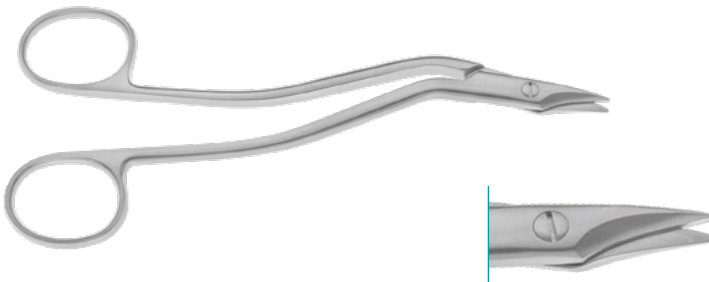

**HEATH**  
Ligature Scissors

160mm, 6<sup>1/4</sup>"

120-226-160



**NEW'S**  
Suture Scissors, angled on flat

165mm, 6<sup>1/2</sup>"

120-225-165

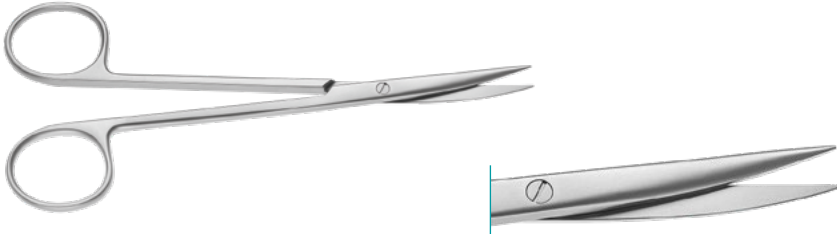
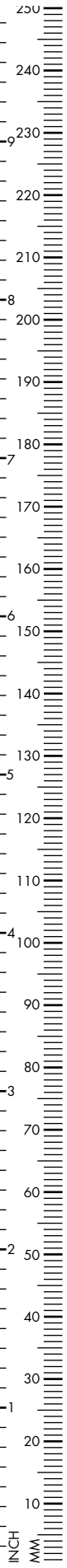

### **BROPHY**

Gum and Suture Scissors, 140mm, 5<sup>1/2</sup>"

straight	120-054-140
curved	120-055-140



### **LITTLER**

Suture Scissors, with hole, slightly curved, sharp

115mm, 4 <sup>1/2</sup> "	120-061-115
---------------------------	-------------



### **O'BRIEN**

Suture Scissors

95mm, 3 <sup>3/4</sup> "	120-084-095
--------------------------	-------------



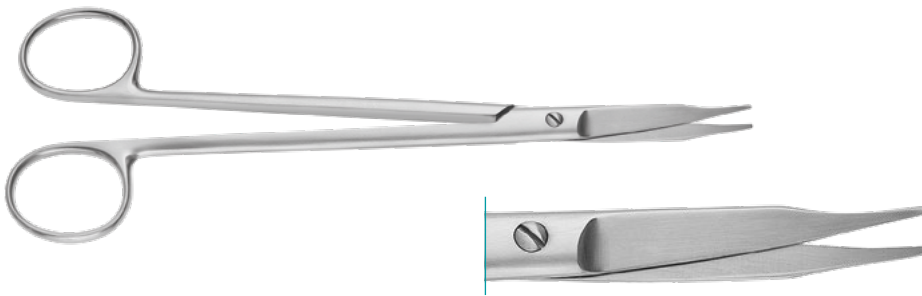

**MARTIN**

Cartilage Scissors

200mm, 8"

120-206-200

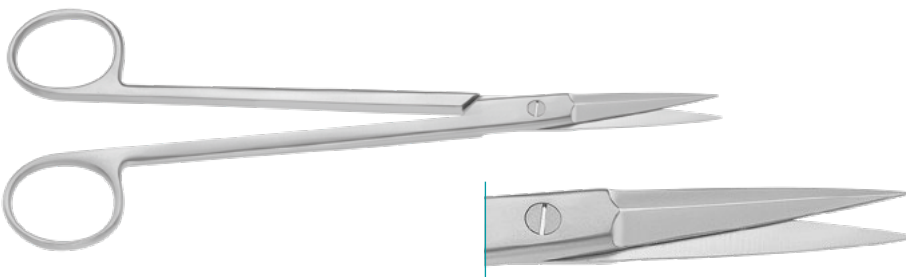

**MCINDOE**

Cartilage Scissors, straight, sharp/sharp  
serrated blade, outside cutting blades

185mm, 7<sup>1</sup>/<sub>4</sub>"

120-190-190



**RESANO**

Capsule Scissors, angled, sharp/blunt

250mm, 9<sup>7</sup>/<sub>8</sub>"

120-241-250

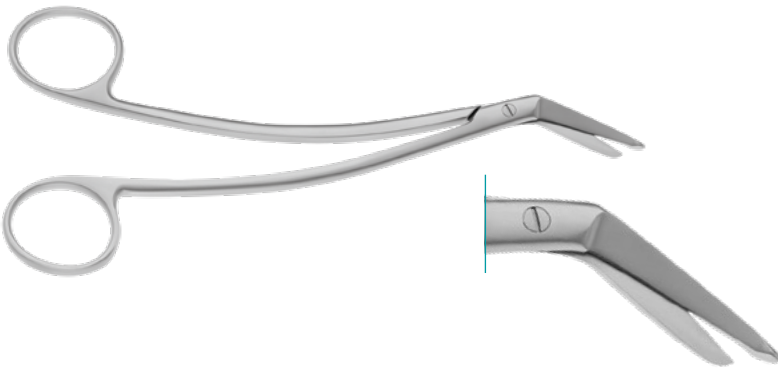

### SCHMIEDEN-TAYLOR

Scissors

170mm, 6<sup>2</sup>/<sub>3</sub>" 120-430-170

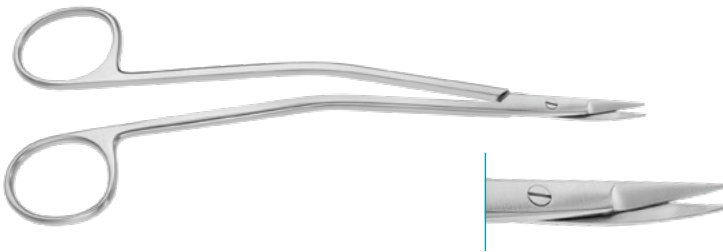

### DANDY

Neurosurgical Scissors, s-shape

170mm, 6<sup>2</sup>/<sub>3</sub>" 120-253-170

195mm, 7<sup>3</sup>/<sub>4</sub>" 120-253-195

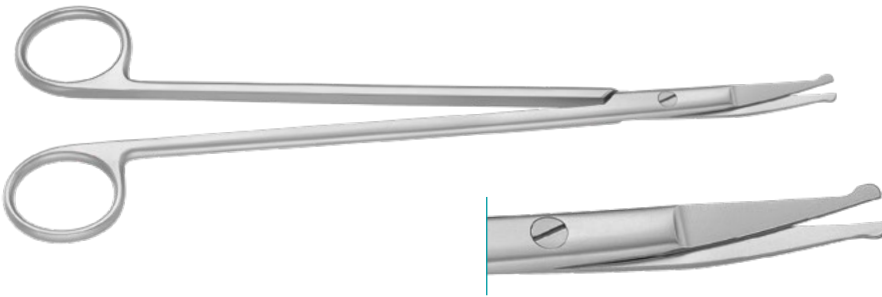

### STRULLY

Neurosurgical Scissors, curved,  
220mm, 8<sup>2</sup>/<sub>3</sub>"

with probe point 120-250-220

without probe point 120-251-220



Nerve dissection Scissors, 150mm, 6"

straight 120-120-150

curved 120-121-150



### HOHENFELLER

S-Curved

180mm, 7"	120-060-180
210mm, 8 <sup>1</sup> / <sub>4</sub> "	120-060-210
240mm, 9 <sup>1</sup> / <sub>2</sub> "	120-060-240

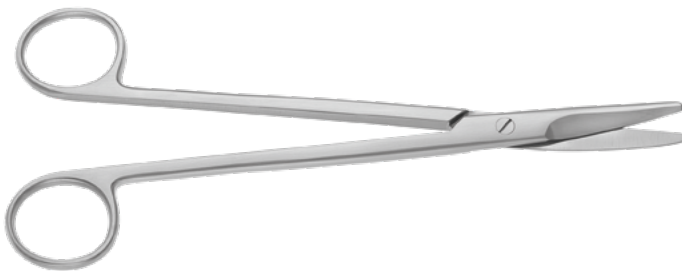

### COOLEY

Vascular Scissors, curved

180mm, 7"	120-134-180
230mm, 9"	120-134-230



### SATINSKY

Vascular Scissors, s-curved

245mm, 9 <sup>2</sup> / <sub>3</sub> "	120-203-245
--	-------------

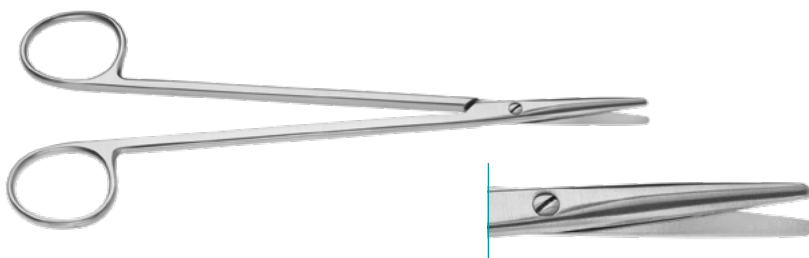

### LINCOLN

Vascular Scissors, straight

170mm, 6 <sup>2</sup> / <sub>3</sub> "	120-260-170
--	-------------

curved

170mm, 6 <sup>2</sup> / <sub>3</sub> "	120-261-170
--	-------------

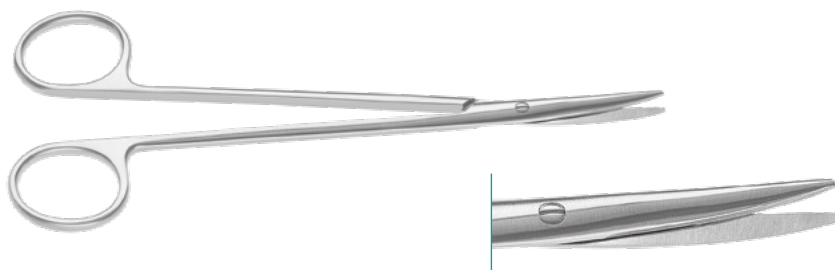
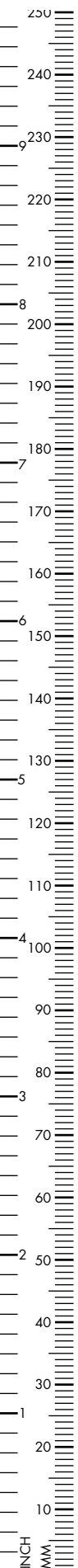

### DE MARTEL

Vascular Scissors, 175mm, 6<sup>7</sup>/<sub>8</sub>"

blunt	120-261-175
sharp	120-263-175

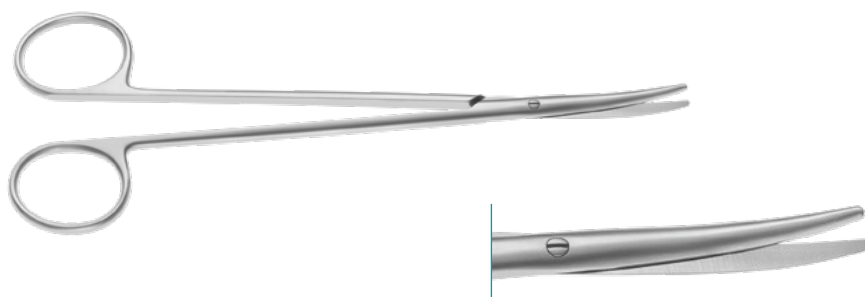

### DEBAKEY

Endarterectomy Scissors, 180mm, 7"

slightly curved	120-319-180
strongly curved	120-320-180



### TOENNIS

Vascular Scissors, 180mm, 7"

Straight	120-254-180
Curved	120-255-180

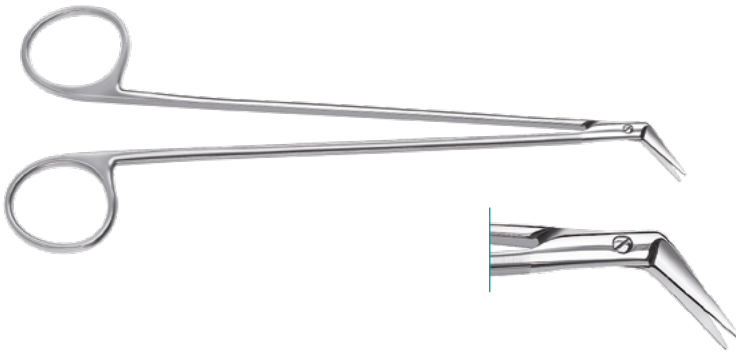

### DIETRICH

delicate, 14mm, 180mm, 7"

25°	125-175-025
45°	125-175-045
60°	125-175-060
90°	125-175-090
125°	125-175-125

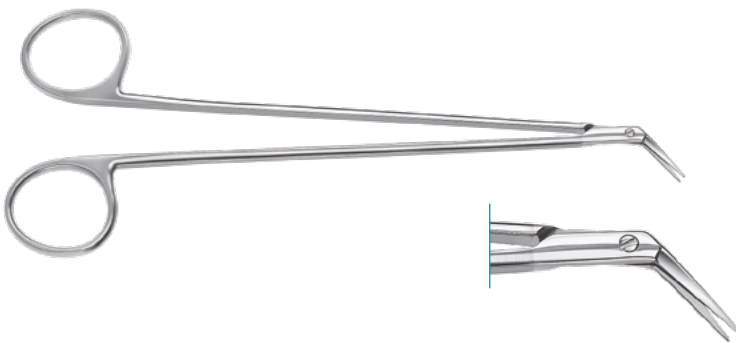

### DIETRICH

extra delicate, 14mm, 180mm, 7"

25°	125-170-025
45°	125-170-045
60°	125-170-060
90°	125-170-090
125°	125-170-125

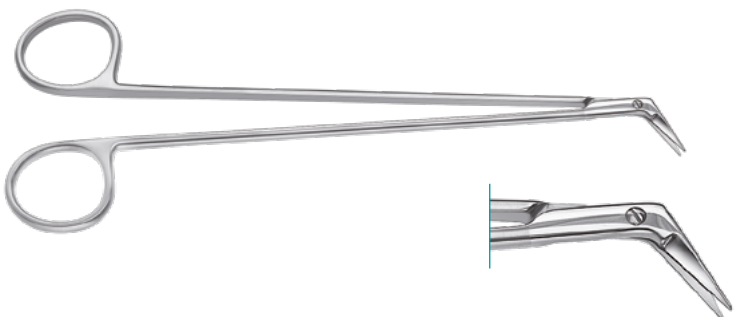

### DIETRICH HEGEMANN

13mm, 180mm, 7"

0°	125-180-000
25°	125-180-025
45°	125-180-045
60°	125-180-060
90°	125-180-090
125°	125-180-125

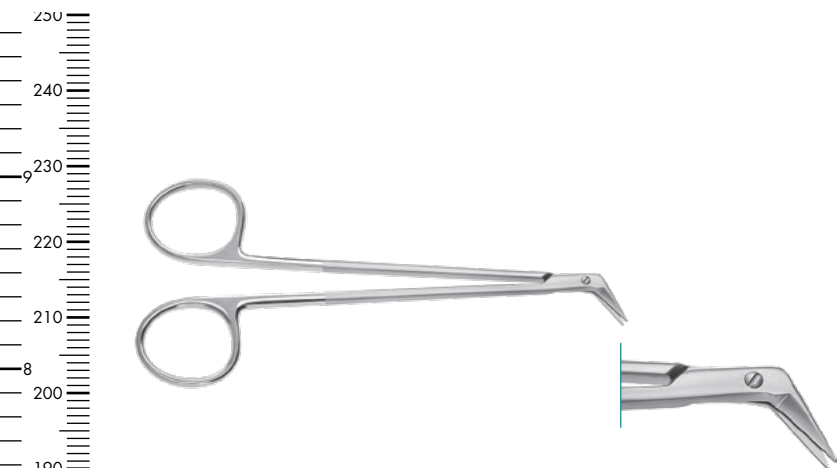

### DIETRICH

Peripheral, 13mm, 130mm, 5 1/8"

25°	125-130-025
45°	125-130-045
60°	125-130-060
90°	125-130-090
125°	125-130-125

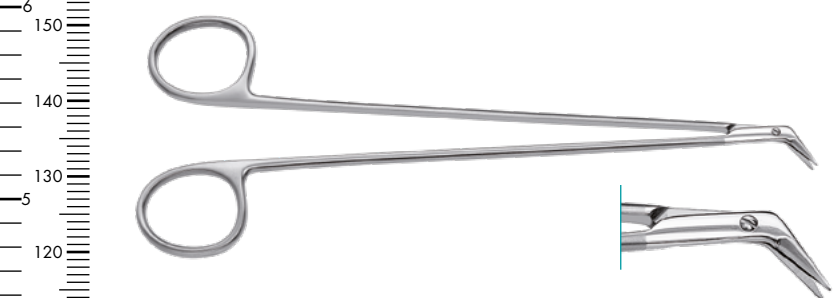

### DIETRICH

9mm, 180mm, 7"

25°	125-178-025
45°	125-178-045
60°	125-178-060
90°	125-178-090
125°	125-178-125

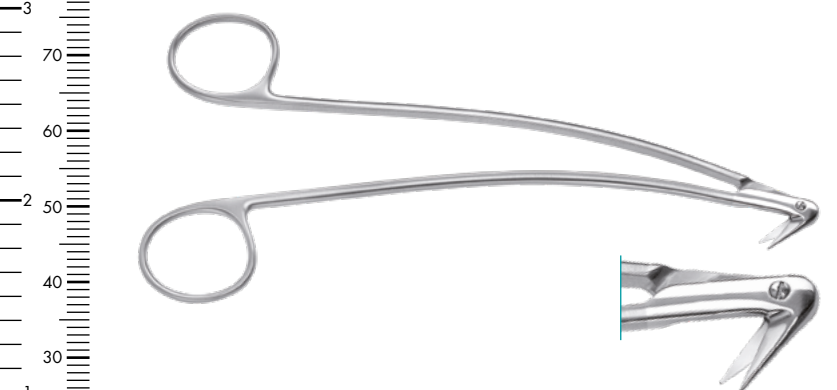

### DIETRICH FAVALORO

13mm, 180mm, 7"

125°	125-185-125
------	-------------

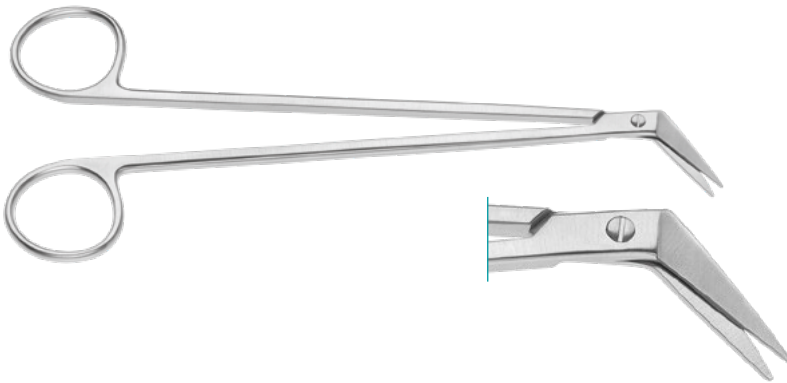

### POTTS SMITH

190mm, 7<sup>1/2</sup>"

25°	120-181-190
40°	120-182-190
60°	120-183-190

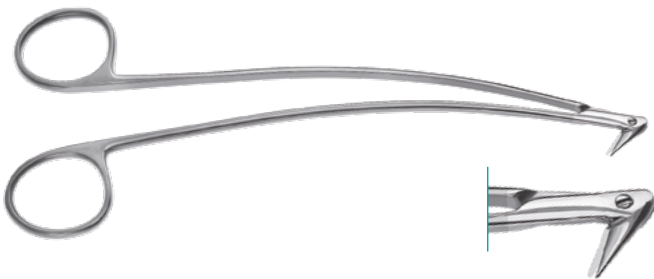

### DIETHRICH FAVALORO

9mm, 170mm, 6<sup>3/4</sup>"

125°	125-168-025
------	-------------

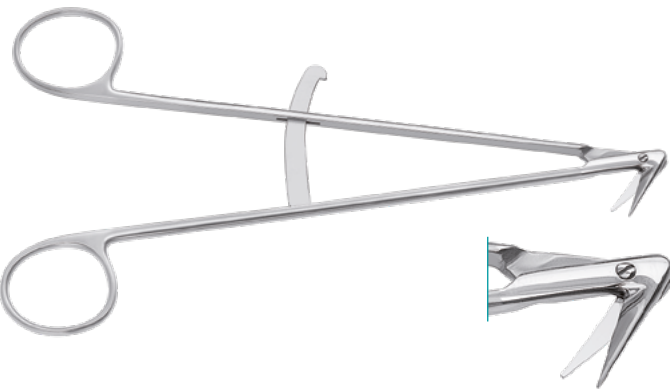

### DIETHRICH ARTEY

13mm, 180mm, 7"

125°	125-200-125
------	-------------



### BEALL

Circumflex, 150mm, 6"

115°	125-300-115
------	-------------

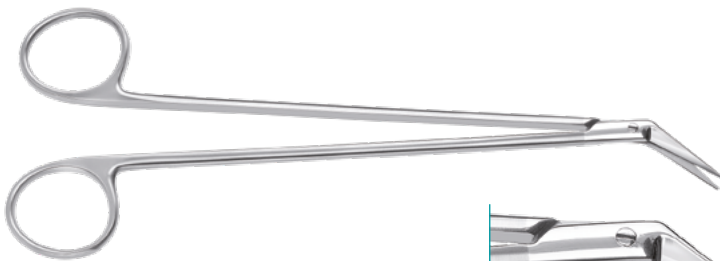
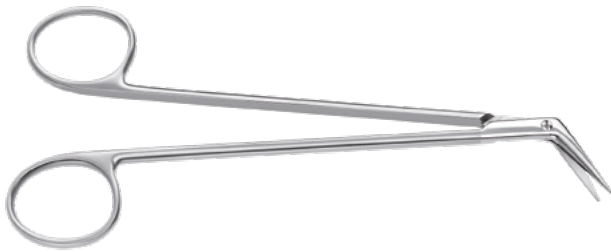

### DIETRICH

26mm, 160mm, 6<sup>1</sup>/<sub>4</sub>"

25°, blunt tip	125-216-025
25°, sharp tip	125-217-025
45°, blunt tip	125-216-045
45°, sharp tip	125-217-045

225mm, 8<sup>7</sup>/<sub>8</sub>"

25°, blunt tip	125-220-025
25°, sharp tip	125-221-025
45°, blunt tip	125-220-045
45°, sharp tip	125-221-045
60°, blunt tip	125-220-060
60°, sharp tip	125-221-060

### POTTS SMITH

22mm, 190mm, 7<sup>1</sup>/<sub>2</sub>"

25°	125-490-025
45°	125-490-045
60°	125-490-060

### POTTS SMITH

22mm, 140mm, 5<sup>1</sup>/<sub>2</sub>"

25°	125-440-025
45°	125-440-045
60°	125-440-060

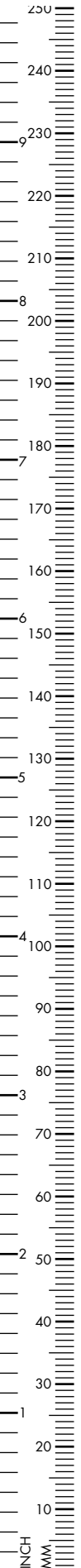





### KNAPP

Iris Scissors, 105mm, 4<sup>1</sup>/<sub>8</sub>"  
straight

sharp/sharp 120-174-105

sharp/blunt 120-175-105

blunt/blunt 120-176-105

curved

sharp/sharp 120-179-105

sharp/blunt 120-178-105

blunt/blunt 120-177-105

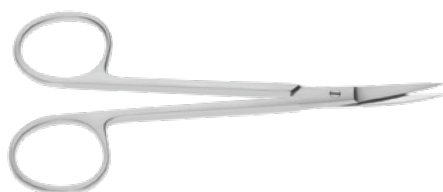

Iris Scissors, straight

90mm, 3<sup>1</sup>/<sub>2</sub>" 120-070-090

105mm, 4<sup>1</sup>/<sub>8</sub>" 120-070-105

115mm, 4<sup>1</sup>/<sub>2</sub>" 120-070-115

curved

90mm, 3<sup>1</sup>/<sub>2</sub>" 120-071-090

105mm, 4<sup>1</sup>/<sub>8</sub>" 120-071-105

115mm, 4<sup>1</sup>/<sub>2</sub>" 120-071-115



Iris Scissors, square model, 120mm, 4<sup>3</sup>/<sub>4</sub>"

straight 120-086-120

curved 120-087-120

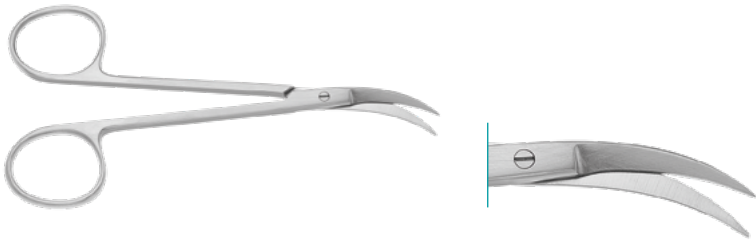

Iris Scissors, sideways curved

115mm, 4 1/2"

120-083-115

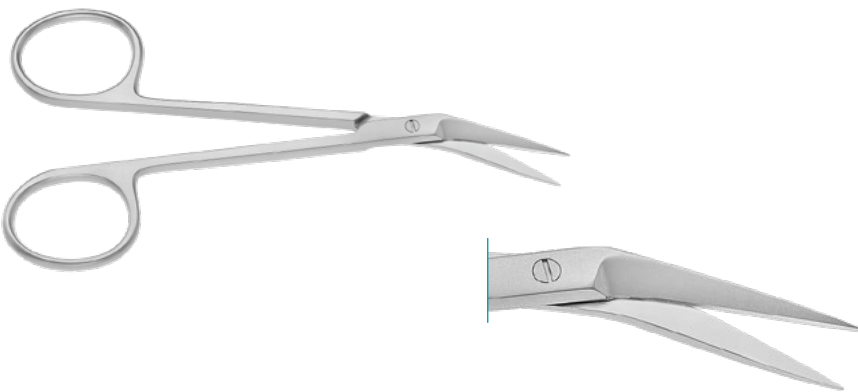

Iris Scissors, angled to side

115mm, 4 1/2"

120-085-115



Iris Scissors, angled on side, probe point

115mm, 4 1/2"

120-360-103

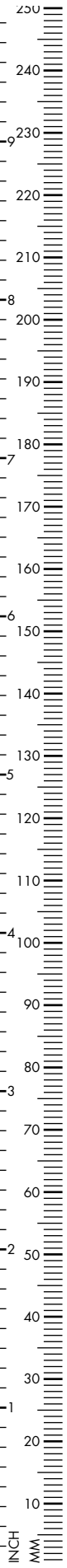

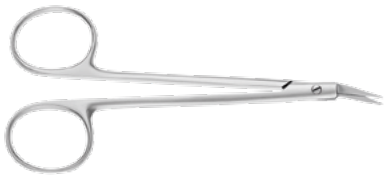

### WILMER

Utility Scissors, angled on flat

100mm, 4"	120-084-100
-----------	-------------



Iris Scissors, sharp, large rings, 100mm, 4",

straight	120-082-100
----------	-------------

curved	120-083-100
--------	-------------



Iris Scissors, 105mm, 4<sup>1</sup>/<sub>8</sub>"

straight	120-080-105
----------	-------------

curved	120-081-105
--------	-------------

115mm, 4<sup>1</sup>/<sub>2</sub>"

straight	120-080-115
----------	-------------

curved	120-081-115
--------	-------------

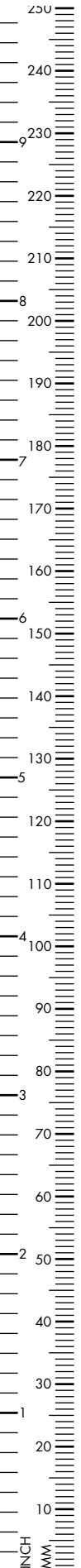

### BONN

Iris Scissors, very delicate, 90mm, 3<sup>1</sup>/<sub>2</sub>" sharp

straight 120-072-080

curved 120-073-080

### blunt

straight 120-074-080

curved 120-075-080



Iris Scissors, sharp, ribbon handle, 105mm, 4<sup>1</sup>/<sub>8</sub>"

straight 120-078-105

curved 120-083-105

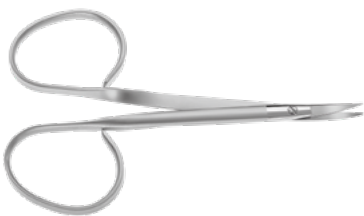

Iris Scissors, sharp, ribbon handle, 95mm, 3<sup>3</sup>/<sub>4</sub>"

straight 120-080-095

curved 120-081-095



Strabismus Scissors, 115mm, 4<sup>1</sup>/<sub>2</sub>"

straight	120-094-115
curved	120-095-115

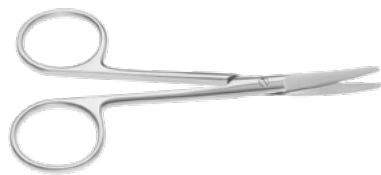

### KNAPP

Strabismus Scissors, blunt, 105mm, 4<sup>1</sup>/<sub>8</sub>"

straight	400-112-105
curved	400-113-105



Strabismus Scissors, ribbon handle,  
105mm, 4<sup>1</sup>/<sub>8</sub>"

straight	120-094-105
curved	120-095-105

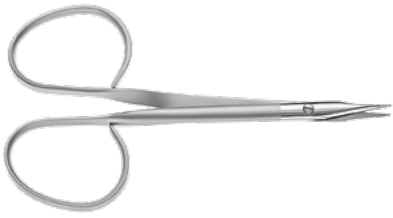
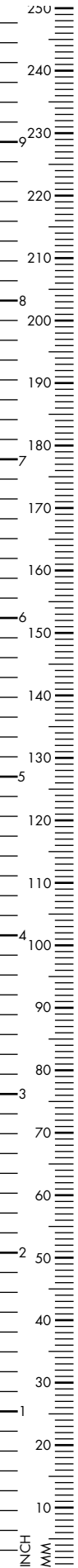

**GRADLE WALTON**

curved, sharp, ribbon handle

100mm, 4"

120-133-200



Enucleation Scissors, medium curved

110mm, 4<sup>1/3</sup>"

120-082-110



Enucleation Scissors  
slightly curved, blunt

130mm, 5<sup>1/8</sup>"

400-881-130

strongly curved

130mm, 5<sup>1/8</sup>"

400-883-130



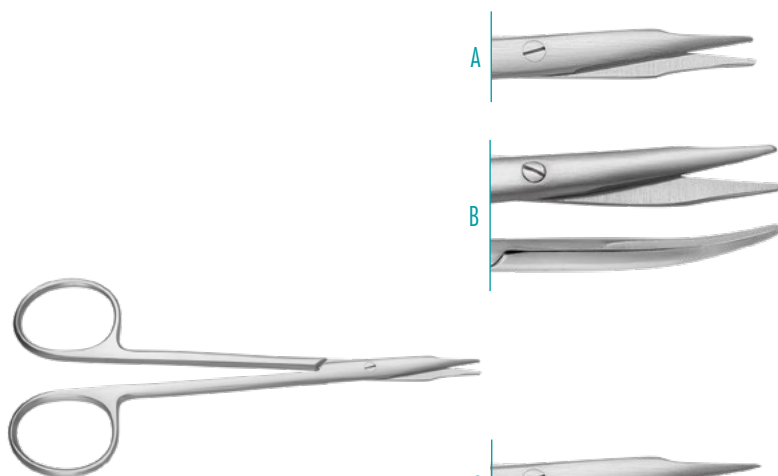

A

B

C

D

### STEVENS

A Tenotomy Scissors, ring handle, blunt, straight

105mm, 4<sup>1</sup>/<sub>8</sub>" 120-092-105

115mm, 4<sup>1</sup>/<sub>2</sub>" 120-092-115

125mm, 5" 120-092-125

B blunt, curved

90mm, 3<sup>1</sup>/<sub>2</sub>" 120-093-090

105mm, 4<sup>1</sup>/<sub>8</sub>" 120-093-105

115mm, 4<sup>1</sup>/<sub>2</sub>" 120-093-115

125mm, 5" 120-093-125

C sharp, straight

105mm, 4<sup>1</sup>/<sub>8</sub>" 120-090-105

115mm, 4<sup>1</sup>/<sub>2</sub>" 120-090-115

125mm, 5" 120-090-125

D sharp, curved

105mm, 4<sup>1</sup>/<sub>8</sub>" 120-091-105

115mm, 4<sup>1</sup>/<sub>2</sub>" 120-091-115

125mm, 5" 120-091-125



A

B

### STEVENS RIBBON

A blunt, straight, ribbon handle

100mm, 4" 120-098-100

B blunt, curved, ribbon handle

100mm, 4" 120-099-100

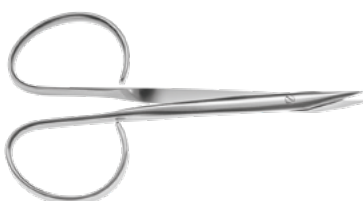

### WALTON

Tenotomy Scissors, curved, sharp, ribbon handle

95mm, 3<sup>3</sup>/<sub>4</sub>" 120-091-095



**CINELLI**

Lower Lateral Nasal Scissors

127mm, 5"

120-338-110



**FOMON**

Lower Lateral Nasal Scissors

120mm, 4<sup>3/4</sup>"

120-339-120

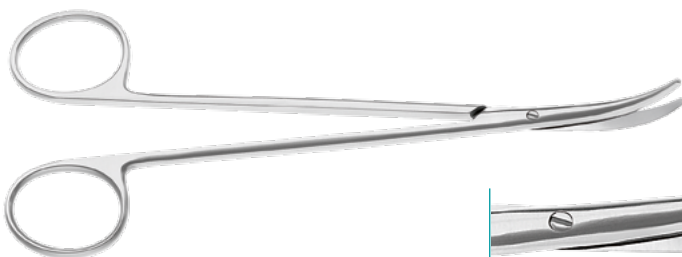

**FOMON**

Lateral Scissors, fully curved

170mm, 6<sup>2/3</sup>"

120-339-170

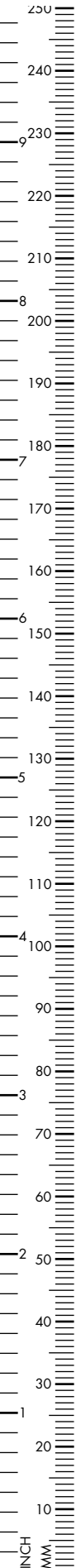





**BEUSE**

Nasal Scissors, slightly curved

110mm, 4<sup>1</sup>/<sub>3</sub>" 120-281-110

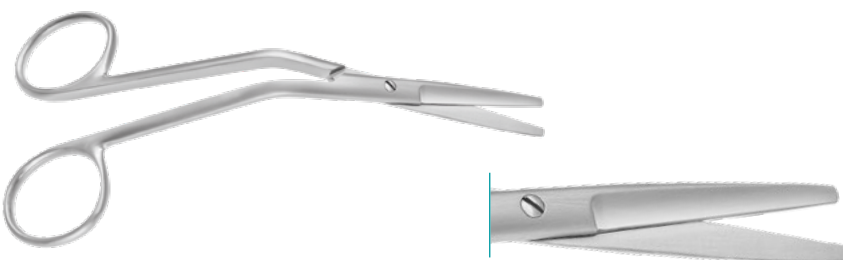

**FOMON**

Nasal Scissors, serrated, knee bent

145mm, 5<sup>3</sup>/<sub>4</sub>" 120-280-150

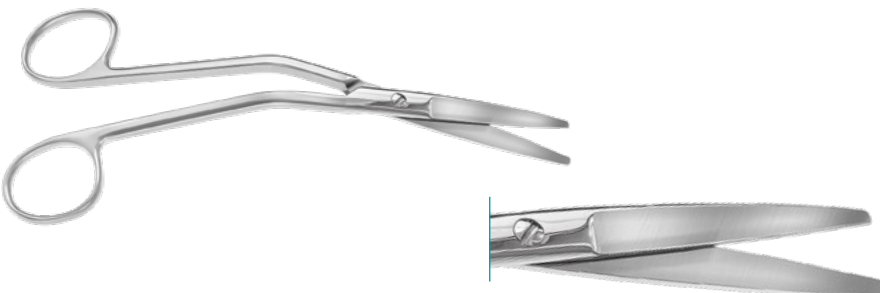

**GOLDMAN**

Nasal Scissors, knee bent

147mm, 6" 120-356-150



**BOETTCHER**

Tonsill Scissors, curved

180mm, 7" 120-209-180



**COTTLE**

Nasal Scissors, knee bent

160mm, 6<sup>1/4</sup>"

120-281-160



**COTTLE**

Septum Scissors, serrated blade

175mm, 6<sup>7/8</sup>"

420-119-175



**SEILER**

Nasal Scissors, angled

170mm, 6<sup>2/3</sup>"

120-289-170



**HEYMAN KNIGHT**

Nasal Scissors, knee bent

180mm, 7"

120-283-180

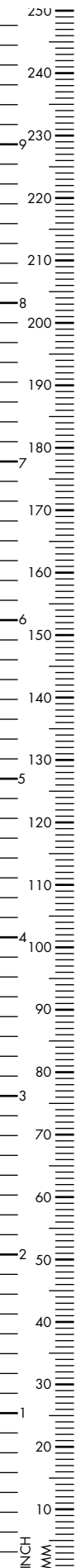

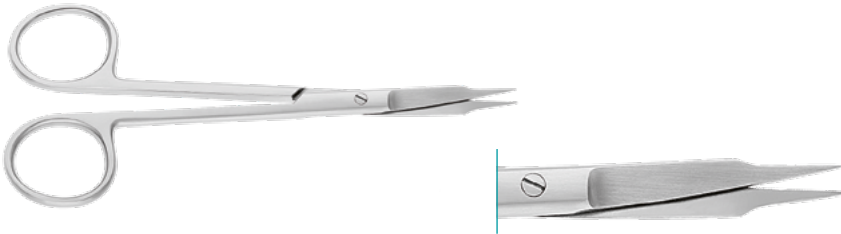

**GOLDMAN FOX**

Gum Scissors, 1 blade serrated,  
straight

130mm, 5<sup>1</sup>/<sub>8</sub>" 120-666-130

curved

130mm, 5<sup>1</sup>/<sub>8</sub>" 120-667-130

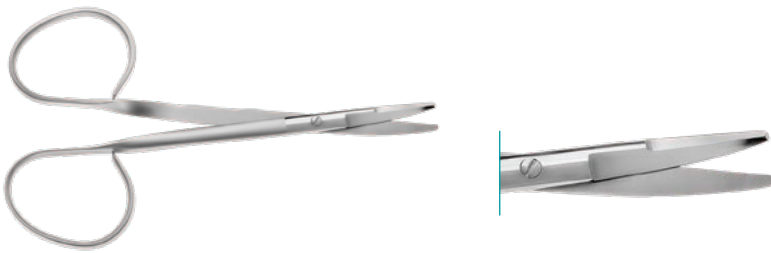

**KAYE**

Blepharoplasty Scissors, ribbon handle,  
curved

115mm, 4<sup>1</sup>/<sub>2</sub>" 120-135-115

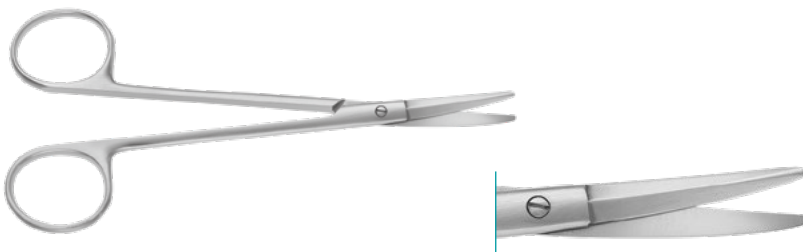

**FOMON**

Saber Scissors, curved

135mm, 5<sup>1</sup>/<sub>3</sub>" 120-139-135



### DOYEN

Scissors, 160mm, 6<sup>1</sup>/<sub>4</sub>"

straight 120-040-160

curved 120-041-160

175mm, 6<sup>7</sup>/<sub>8</sub>"

straight 120-040-175

curved 120-041-175



### WILLAUER

Scissors, straight

250mm, 9<sup>7</sup>/<sub>8</sub>" 120-214-250

280mm, 11" 120-214-280

curved

250mm, 9<sup>7</sup>/<sub>8</sub>" 120-215-250

280mm, 11" 120-215-280



### JORGENSEN

Scissors, curved

220mm, 8<sup>2</sup>/<sub>3</sub>" 120-325-220



Enterotomy Scissors

210mm, 8<sup>1</sup>/<sub>4</sub>"

A 120-233-210

B 120-234-210

C 120-235-210



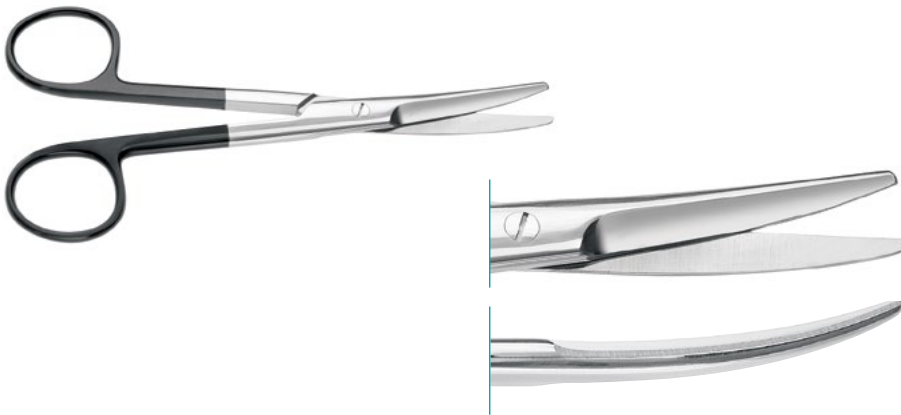

### MAYO SC

Surgical Scissors, straight

145mm, 5 <sup>3</sup> / <sub>4</sub> "	121-030-145
--	-------------

170mm, 6 <sup>2</sup> / <sub>3</sub> "	121-030-170
--	-------------

230mm, 9"	121-030-230
-----------	-------------

curved

145mm, 5 <sup>3</sup> / <sub>4</sub> "	121-031-145
--	-------------

170mm, 6 <sup>2</sup> / <sub>3</sub> "	121-031-170
--	-------------

230mm, 9"	121-031-230
-----------	-------------

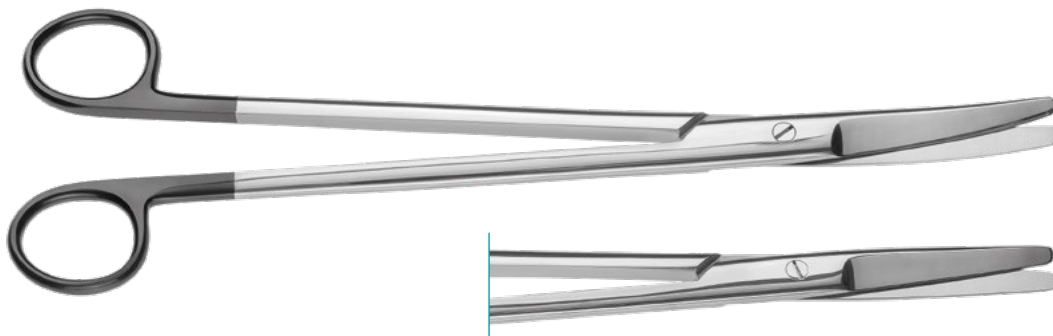

### MAYO HARRINGTON SC

curved

280mm, 11"	121-033-280
------------	-------------

straight

300mm, 11 <sup>7</sup> / <sub>8</sub> "	121-032-300
---	-------------

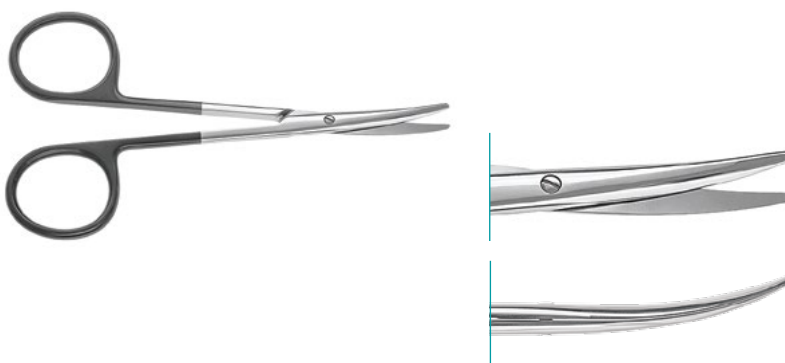

### METZENBAUM BABY SC

Dissecting Scissors, curved

110mm, 4 <sup>1</sup> / <sub>3</sub> "	121-317-110
--	-------------

145mm, 5 <sup>3</sup> / <sub>4</sub> "	121-317-145
--	-------------

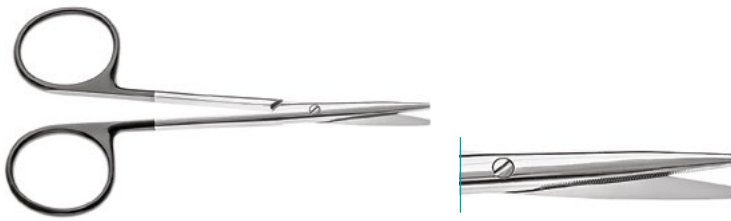

### STRABISMUS SC

Dissecting Scissors, 115mm, 4<sup>1/2</sup>"

straight	121-094-115
curved	121-095-115



### METZENBAUM SC

145mm, 5<sup>3/4</sup>"

straight	121-110-145
curved	121-111-145



### METZENBAUM NELSON SC

curved, blunt

180mm, 7"	121-111-180
200mm, 8"	121-111-200
230mm, 9"	121-111-230
280mm, 11"	121-111-280
300mm, 11 <sup>7/8</sup> "	121-111-300
355mm, 14"	121-111-355
straight	
180mm, 7"	121-110-180
200mm, 8"	121-110-200
230mm, 9"	121-110-230
260mm, 11"	121-110-260

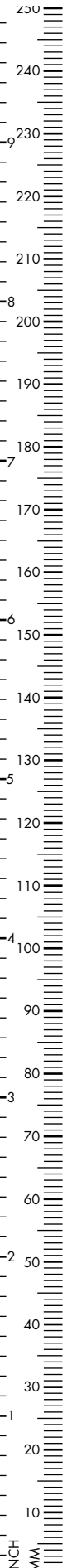

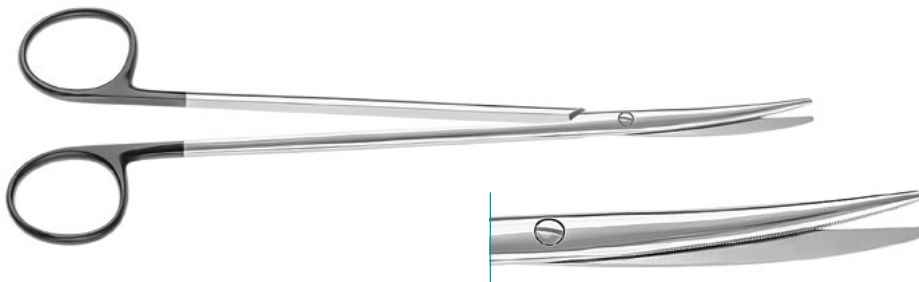

### METZENBAUM FINO SC

curved, blunt

115mm, 4 <sup>1/2</sup> "	121-153-115
145mm, 5 <sup>3/4</sup> "	121-153-145
180mm, 7"	121-153-180
200mm, 8"	121-153-200
230mm, 9"	121-153-230

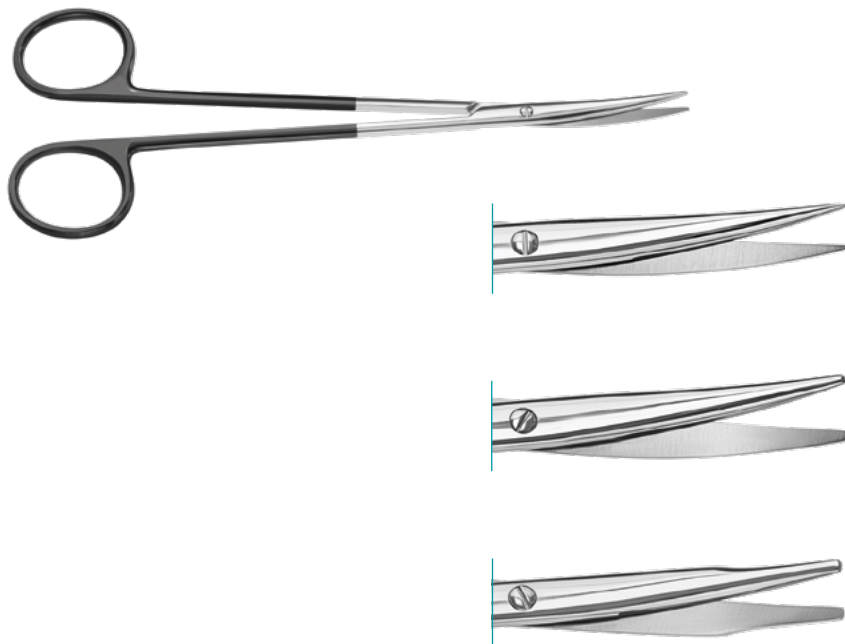

### LILLEHEI POTTS SC

curved, 180mm, 7"

sharp	126-312-180
blunt	126-313-180
blunt, tenotomy	126-314-180

curved, 230mm, 9"

sharp	126-312-230
blunt	126-313-230
blunt, tenotomy	126-314-230

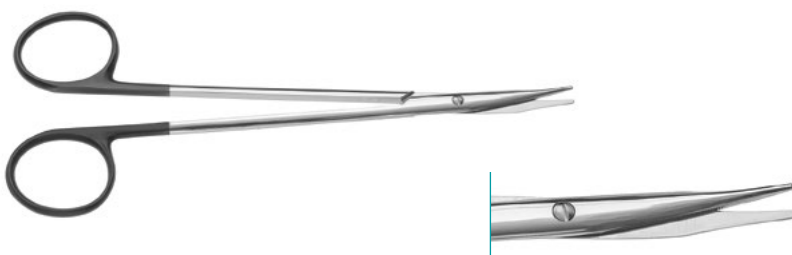

### JAMESON SC

curved, blunt

150mm, 6"	121-315-150
180mm, 7"	121-315-180



### RZ DAVIS SC

curved, sharp

180mm, 7"

121-313-170

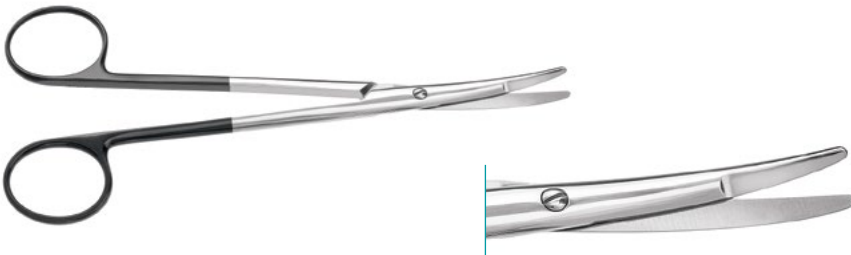

### RAGNELL KILNER SC

curved, flat, blunt

150mm, 6"

121-332-150

180mm, 7"

121-332-180

200mm, 8"

121-332-200



### PAR TYPE SC

curved

110mm, 4<sup>1</sup>/<sub>3</sub>"

121-331-110

150mm, 6"

121-331-150





### FOMON SC

Lateral Scissors, strongly curved

110mm, 4<sup>1</sup>/<sub>3</sub>"

121-131-110

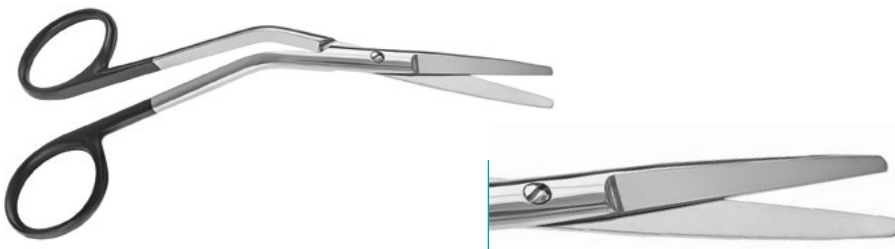

### FOMON SC

Dorsal Scissors, straight, shanks knee bent

145mm, 5<sup>3</sup>/<sub>4</sub>"

121-280-145

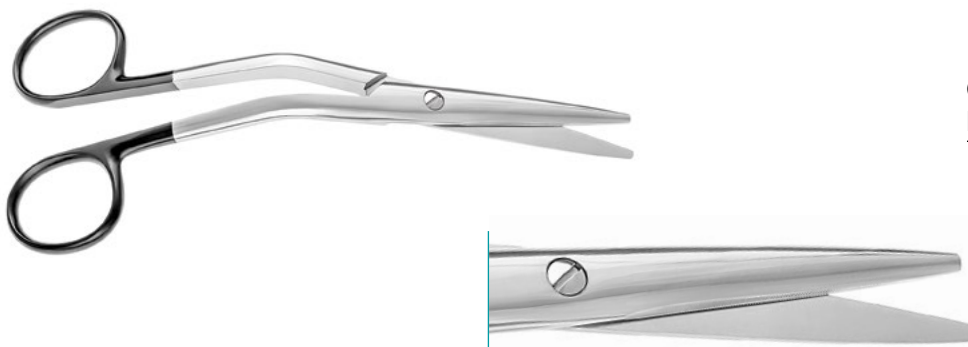

### COTTLE SC

Dorsal Scissors, shanks knee bent

170mm, 6<sup>2</sup>/<sub>3</sub>"

121-290-165

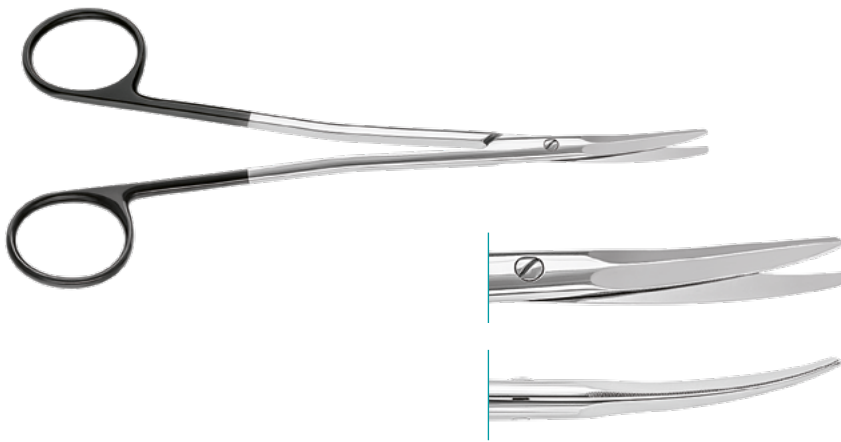

### KAYE FREEMAN SC

Facelift Scissors, flat tip, splayed shanks  
180mm, 7"

straight	121-328-180
curved	121-329-180

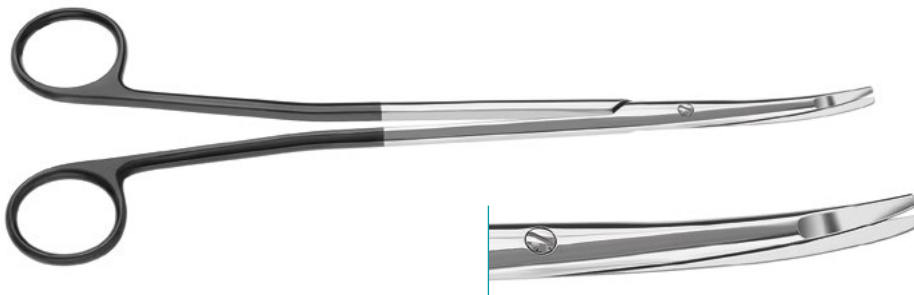

### METZENBAUM FREEMAN SC

Rhytidectomy Scissors, flat tip, splayed shanks  
curved

180mm, 7"	121-211-180
200mm, 8"	121-211-200
230mm, 9"	121-211-230

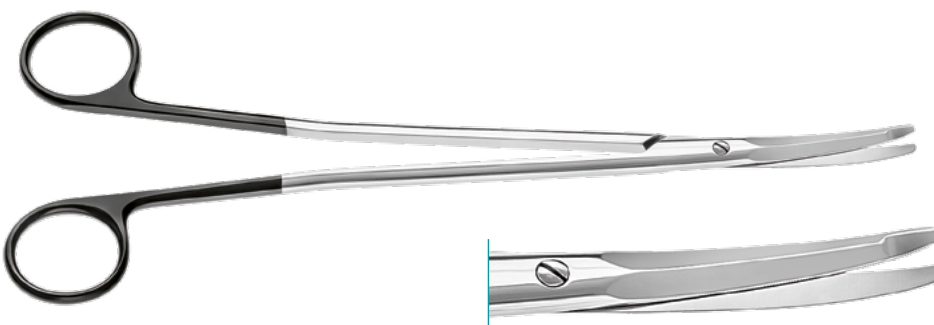

### GOURNEY FREEMAN SC

Platysma Scissors, flat tip, curved

230mm, 9"	121-345-230
-----------	-------------



### GORNEY SC

Plastic Surgery Scissors, straight

190mm, 7 <sup>1</sup> / <sub>2</sub> "	121-336-190
--	-------------

curved

185mm, 7 <sup>1</sup> / <sub>4</sub> "	121-337-185
--	-------------

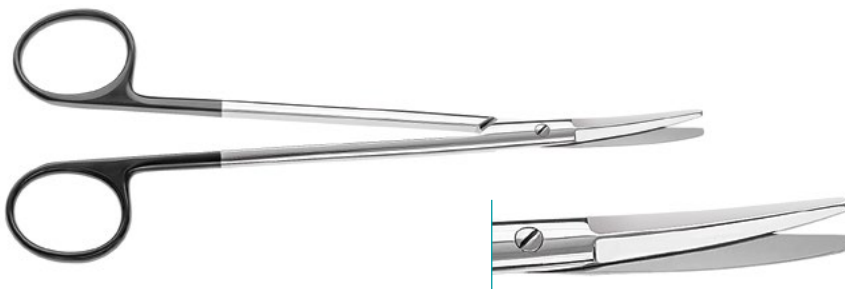

### KAYE SC

Facelift Scissors, curved

145mm, 5 <sup>3</sup> / <sub>4</sub> "	121-327-145
--	-------------

180mm, 7"	121-327-180
-----------	-------------



### GORNEY FREEMAN SC

Facelift Scissors, flat tip, splayed shanks

190mm, 7<sup>1</sup>/<sub>2</sub>"

straight	121-342-190
----------	-------------

curved	121-343-190
--------	-------------

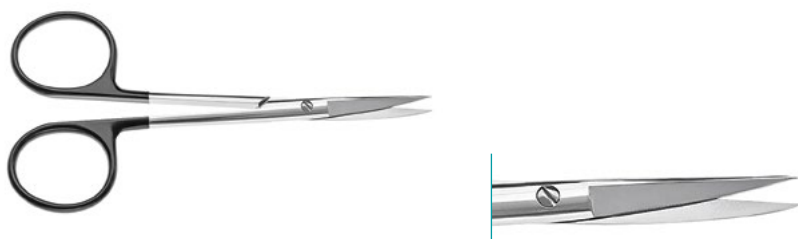
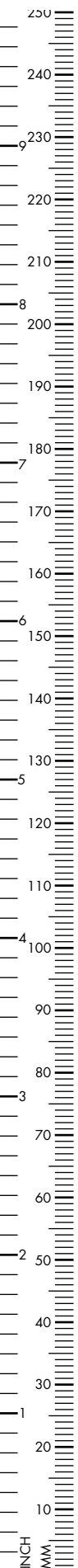

**IRIS SC**

sharp, 110mm, 4<sup>1</sup>/<sub>3</sub>"

straight 121-070-110

curved 121-071-110

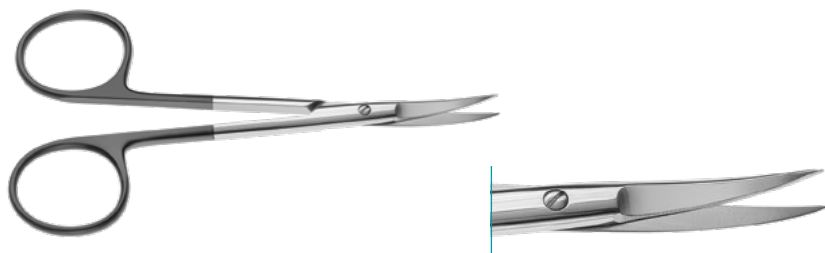

**JABALEY SC**

curved, with large rings

130mm, 5<sup>1</sup>/<sub>8</sub>" 121-089-130



**JAMESON WERBER SC**

curved

135mm, 5<sup>1</sup>/<sub>3</sub>" 121-313-135



### LITTLER SC

with hole, slightly curved, sharp

115mm, 4 <sup>1</sup> / <sub>2</sub> "	121-061-115
--	-------------



### STEVENS SC

Tenotomy Scissors, square model,  
blunt, straight

105mm, 4 <sup>1</sup> / <sub>8</sub> "	121-196-100
--	-------------

115mm, 4 <sup>1</sup> / <sub>2</sub> "	121-196-110
--	-------------

125mm, 5"	121-196-120
-----------	-------------

curved

105mm, 4 <sup>1</sup> / <sub>8</sub> "	121-197-100
--	-------------

115mm, 4 <sup>1</sup> / <sub>2</sub> "	121-197-110
--	-------------

125mm, 5"	121-197-120
-----------	-------------



### STEVENS SC

curved, sharp/sharp

110mm, 4 <sup>1</sup> / <sub>3</sub> "	121-089-110
--	-------------

150mm, 6"	121-089-150
-----------	-------------



### GRADLE SC

sharp, curved

120mm, 4 <sup>3</sup> / <sub>4</sub> "	121-134-120
--	-------------

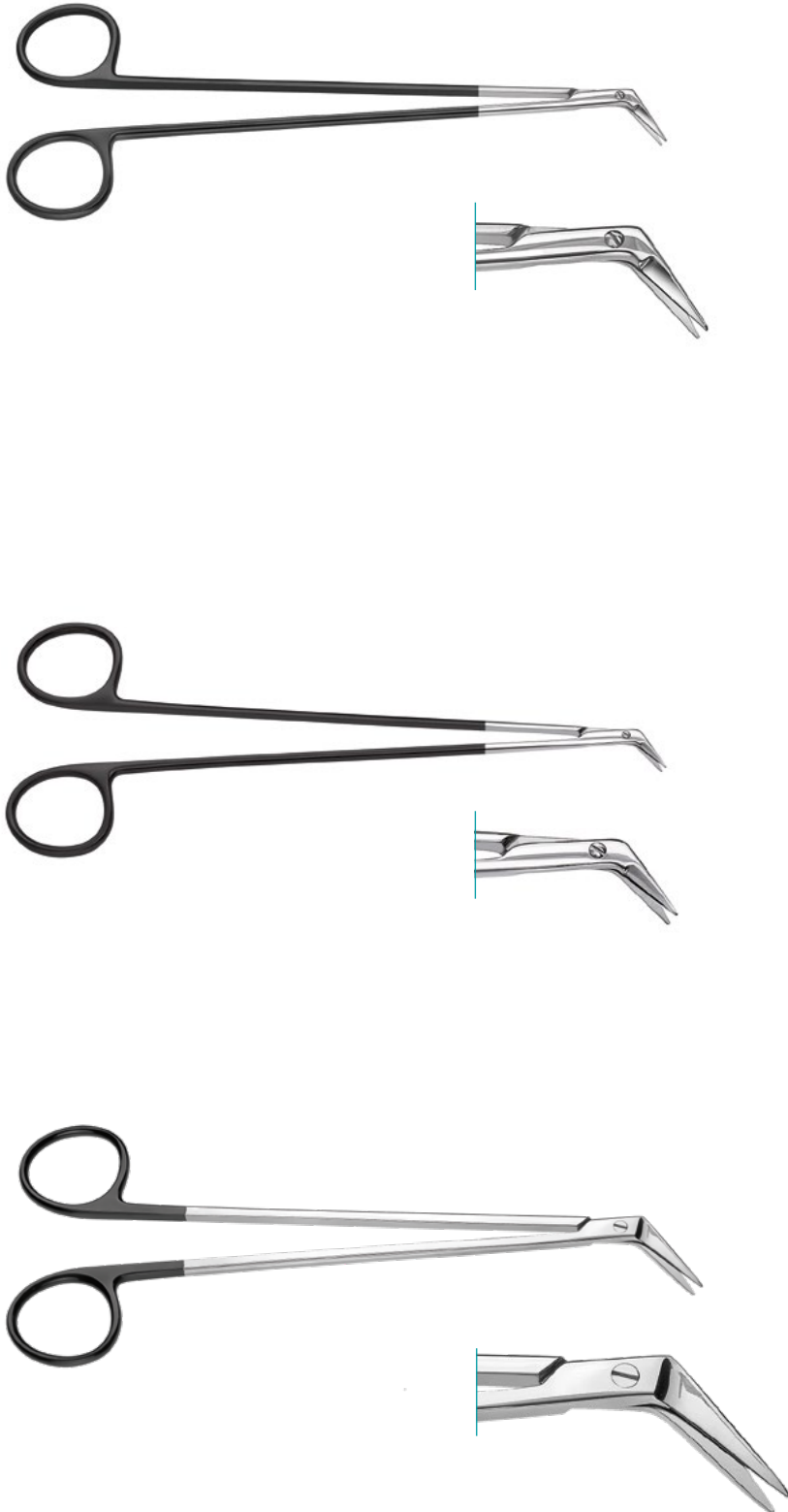
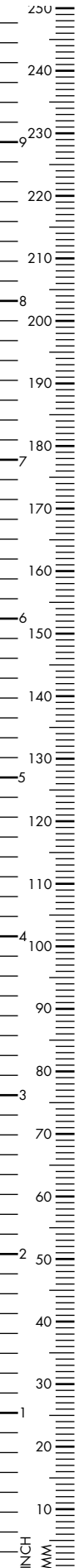

### DIETRICH HEGEMANN SC

Vascular Scissors, 13mm standard blade  
130mm, 5<sup>1</sup>/<sub>8</sub>"

25°	126-130-025
45°	126-130-045
60°	126-130-060
90°	126-130-090
125°	126-130-125

180mm, 7"

25°	126-180-025
45°	126-180-045
60°	126-180-060
90°	126-180-090
125°	126-180-125

### DIETRICH SC

Vascular Scissors, delicate, 9mm short blades  
180mm, 7"

25°	126-178-025
45°	126-178-045
60°	126-178-060
90°	126-178-090
125°	126-178-125

### POTTS SMITH SC

Vascular Scissors, 190mm, 7<sup>1</sup>/<sub>2</sub>"

25°	121-183-190
45°	121-182-190
60°	121-181-190

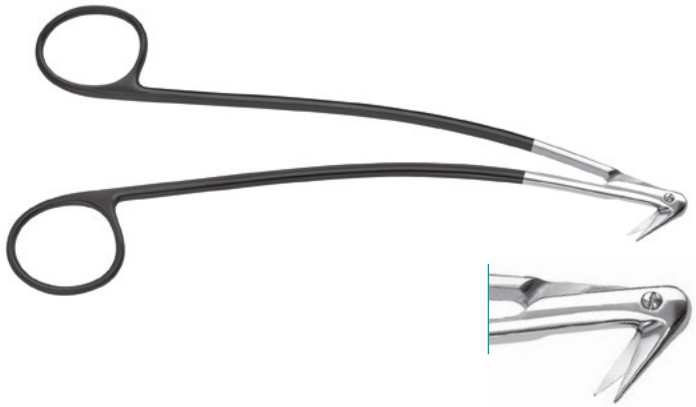

**DIETHRICH FAVALORO SC**

Vascular Scissors, 13mm standard blades  
180mm, 7"

125° 126-185-125

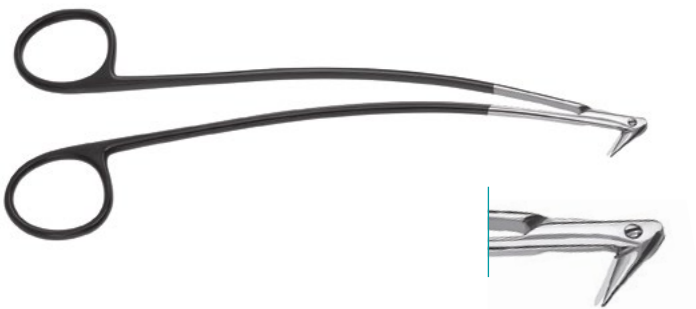

**DIETHRICH FAVALORO SC**

Vascular Scissors, 9mm short blades  
170mm, 6<sup>2</sup>/<sub>3</sub>"

125° 126-168-125

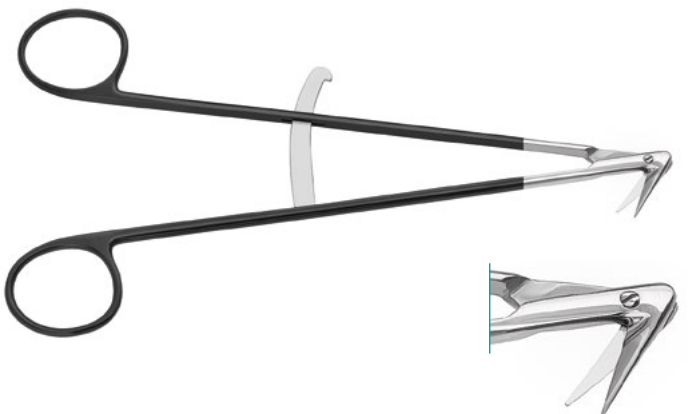

**DIETHRICH ARTERY SC**

Vascular Scissors, 13mm standard blades  
with guide  
180mm, 7"

125° 126-200-125

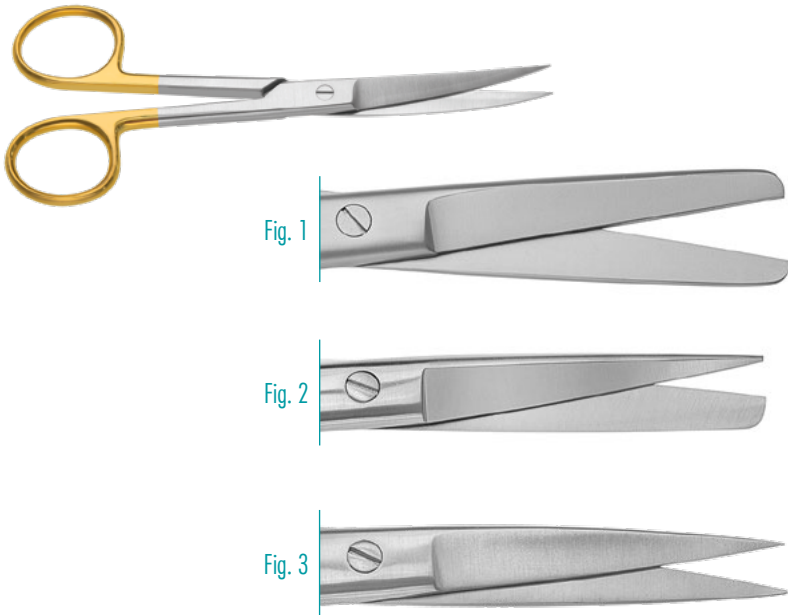

Fig. 1

Fig. 2

Fig. 3

### STANDARD TC

straight, 145mm, 5<sup>3</sup>/<sub>4</sub>"

Fig. 1 120-500-145  
(blunt/blunt)

curved, 145mm, 5<sup>3</sup>/<sub>4</sub>"

Fig. 1 120-501-145  
(blunt/blunt)

straight, 145mm, 5<sup>3</sup>/<sub>4</sub>"

Fig. 2 120-502-145  
(sharp/blunt)

Fig. 3 120-504-145  
(sharp/sharp)

curved, 145mm, 5<sup>3</sup>/<sub>4</sub>"

Fig. 2 120-503-145  
(sharp/blunt)

Fig. 3 120-505-145  
(sharp/sharp)

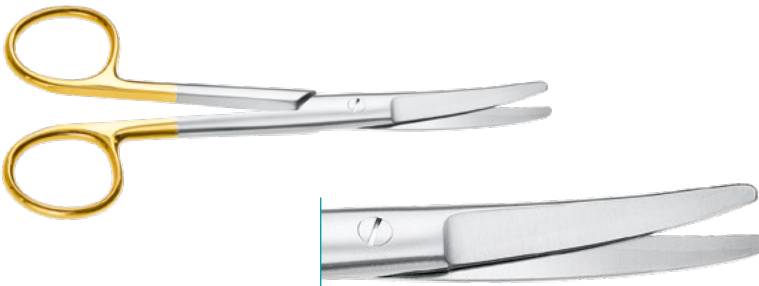

### MAYO TC

straight

145mm, 5<sup>3</sup>/<sub>4</sub>" 120-506-145

170mm, 6<sup>2</sup>/<sub>3</sub>" 120-506-170

curved

145mm, 5<sup>3</sup>/<sub>4</sub>" 120-507-145

170mm, 6<sup>2</sup>/<sub>3</sub>" 120-507-170

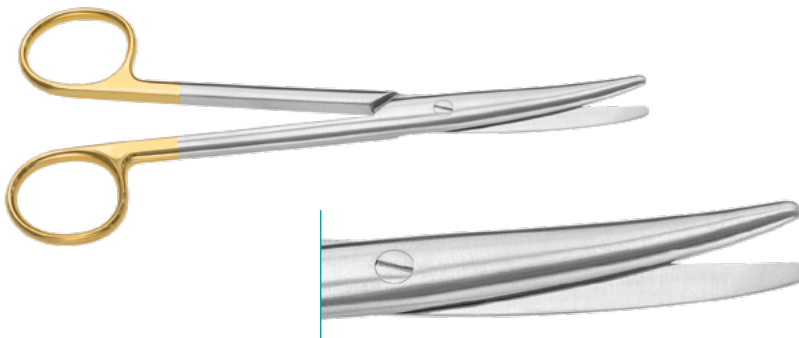

### MAYO STILLE TC

straight

150mm, 6" 120-508-150

170mm, 6<sup>2</sup>/<sub>3</sub>" 120-508-170

curved

150mm, 6" 120-509-150

170mm, 6<sup>2</sup>/<sub>3</sub>" 120-509-170





### MAYO-HARRINGTON TC

straight

230mm, 9"

120-506-230

curved

230mm, 9"

120-507-230

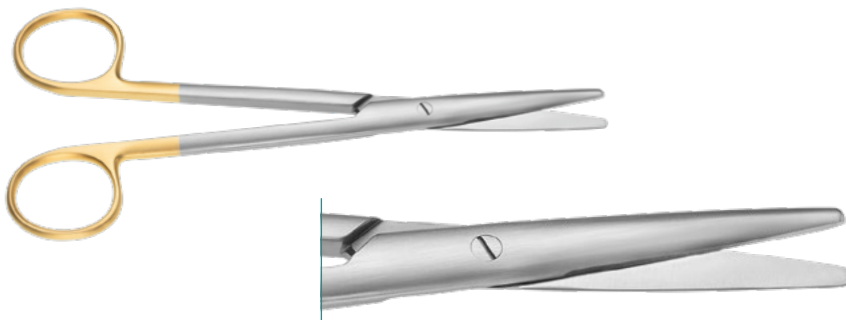

### LEXER TC

straight

160mm, 6<sup>1/4</sup>"

120-516-160

210mm, 8<sup>1/4</sup>"

120-516-210

curved

160mm, 6<sup>1/4</sup>"

120-517-160

210mm, 8<sup>1/4</sup>"

120-517-210



### TOENNIS ADSON TC

curved

170mm, 6<sup>2/3</sup>"

120-531-170

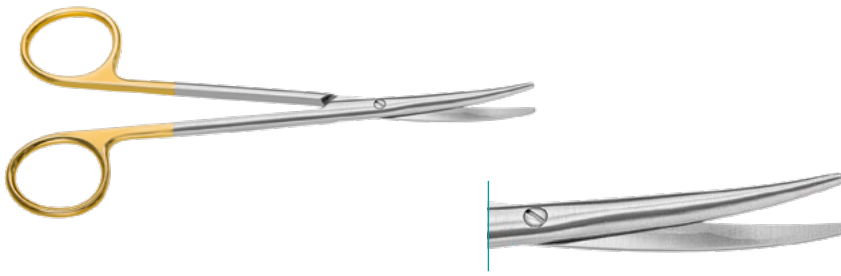

### **METZENBAUM LAHEY TC**

curved, blunt

140mm, 5<sup>1/2</sup>"

120-530-140

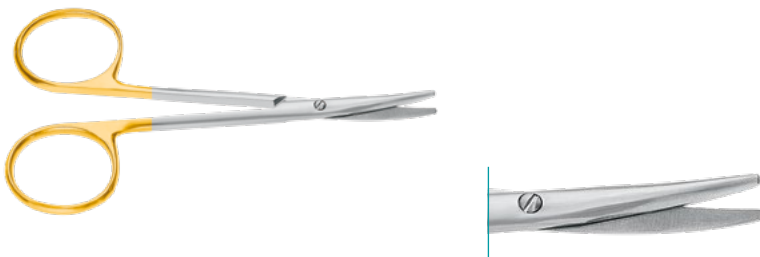

### **METZENBAUM BABY TC**

straight, blunt

115mm, 4<sup>1/2</sup>"

120-510-115

curved, blunt

115mm, 4<sup>1/2</sup>"

120-511-115

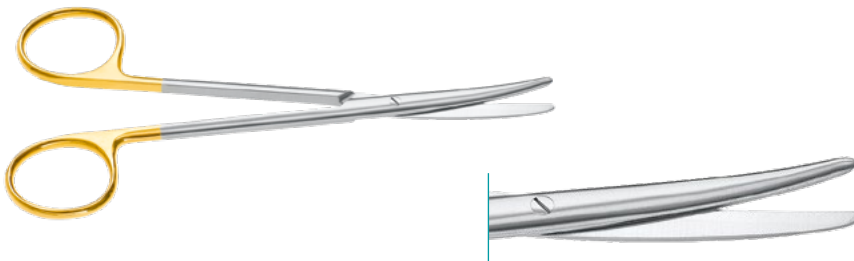

### **METZENBAUM TC**

straight, blunt/blunt

145mm, 5<sup>3/4</sup>"

120-510-145

180mm, 7"

120-510-180

200mm, 8"

120-510-200

230mm, 9"

120-510-230

curved

145mm, 5<sup>3/4</sup>"

120-511-145

180mm, 7"

120-511-180

200mm, 8"

120-511-200

230mm, 9"

120-511-230

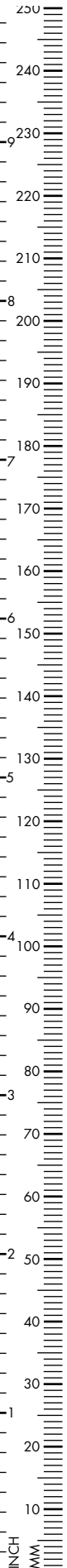

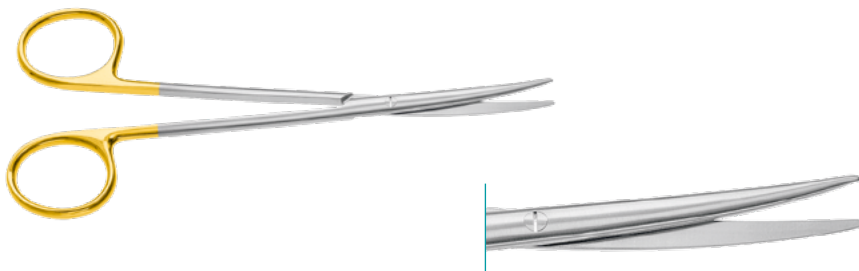

### METZENBAUM FINO TC

straight, blunt/blunt

145mm, 5 <sup>3</sup> / <sub>4</sub> "	120-520-145
180mm, 7"	120-520-180
200mm, 8"	120-520-200
230mm, 9"	120-520-230

curved, blunt/blunt

145mm, 5 <sup>3</sup> / <sub>4</sub> "	120-521-145
180mm, 7"	120-521-180
200mm, 8"	120-521-200
230mm, 9"	120-521-230

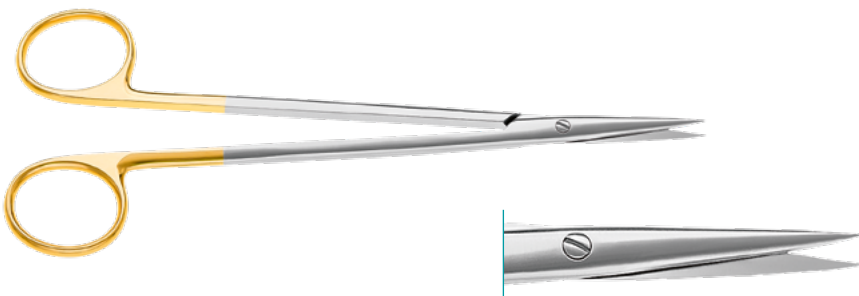

### METZENBAUM TC

straight, sharp/sharp

145mm, 5 <sup>3</sup> / <sub>4</sub> "	120-514-145
180mm, 7"	120-514-180
200mm, 8"	120-514-200
230mm, 9"	120-514-230

curved, sharp/sharp

145mm, 5 <sup>3</sup> / <sub>4</sub> "	120-515-145
180mm, 7"	120-515-180
200mm, 8"	120-515-200
230mm, 9"	120-515-230

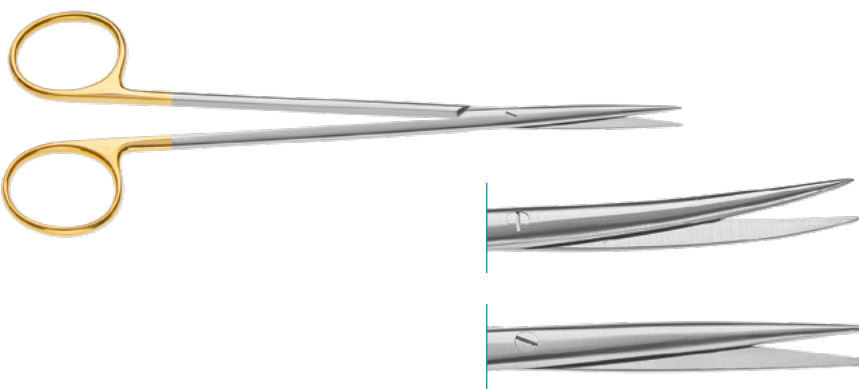

### METZENBAUM FINO TC

straight, sharp/sharp

145mm, 5 <sup>3</sup> / <sub>4</sub> "	120-522-145
180mm, 7"	120-522-180
200mm, 8"	120-522-200
230mm, 9"	120-522-230

curved, sharp/sharp

145mm, 5 <sup>3</sup> / <sub>4</sub> "	120-523-145
180mm, 7"	120-523-180
200mm, 8"	120-523-200
230mm, 9"	120-523-230

s-curved, blunt

180mm, 7"	120-525-180
200mm, 8"	120-525-200

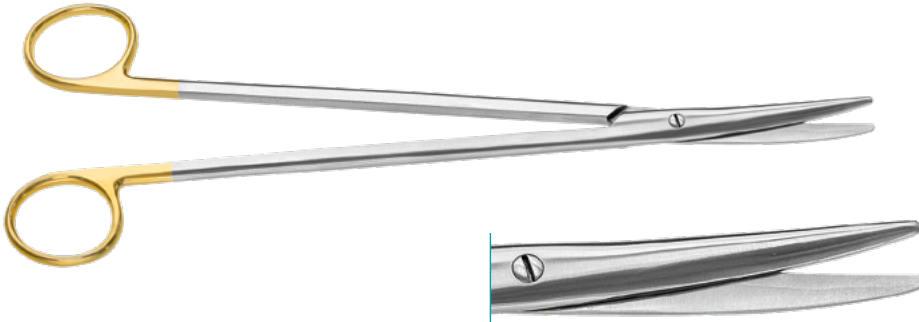

### METZENBAUM NELSON TC

straight, Fig.1

250mm, 9 <sup>7</sup> / <sub>8</sub> "	120-510-250
280mm, 11"	120-510-280
300mm, 11 <sup>7</sup> / <sub>8</sub> "	120-510-300

curved, Fig.1

250mm, 9 <sup>7</sup> / <sub>8</sub> "	120-511-250
280mm, 11"	120-511-280
300mm, 11 <sup>7</sup> / <sub>8</sub> "	120-511-300
360mm, 14"	120-511-360

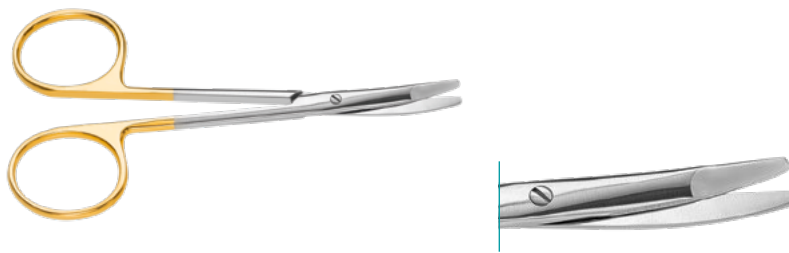

### RAGNELL TC

Scissors

120mm, 4 <sup>3</sup> / <sub>4</sub> "	120-559-120
150mm, 6"	120-559-150
180mm, 7 <sup>1</sup> / <sub>2</sub> "	120-559-180



### BABY METZENBAUM TC

Strabismus Scissors, straight

115mm, 4 <sup>1</sup> / <sub>2</sub> "	120-594-115
--	-------------

curved

115mm, 4 <sup>1</sup> / <sub>2</sub> "	120-595-115
--	-------------

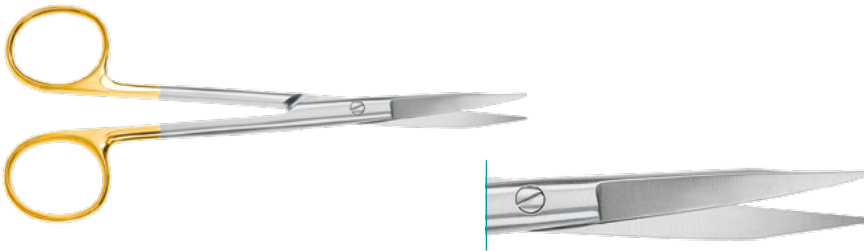

### **GOLDMAN FOX TC**

curved

130mm, 5<sup>1</sup>/<sub>8</sub>"

120-967-130

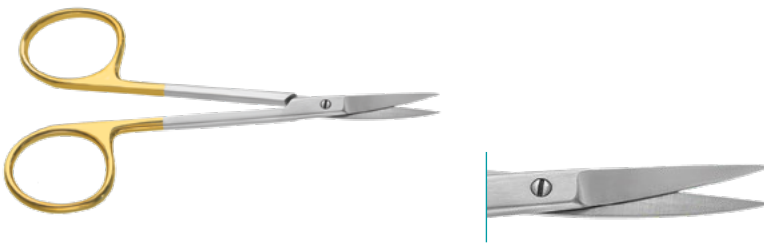

### **IRIS TC**

straight

115mm, 4<sup>1</sup>/<sub>2</sub>"

120-554-115

curved

115mm, 4<sup>1</sup>/<sub>2</sub>"

120-555-115

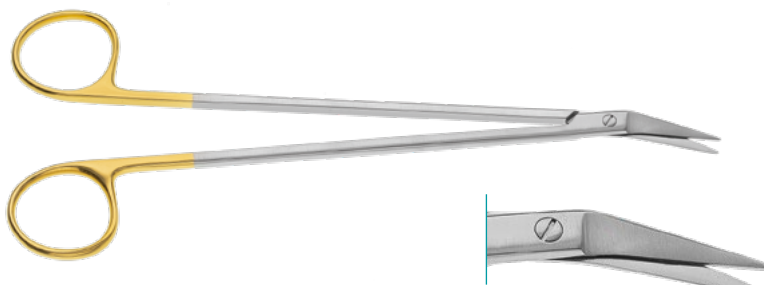

### **POTTS SMITH TC**

Vascular Scissors, 190mm, 7<sup>1</sup>/<sub>2</sub>"

25° 120-581-190

45° 120-582-190

60° 120-583-190

90° 120-584-190

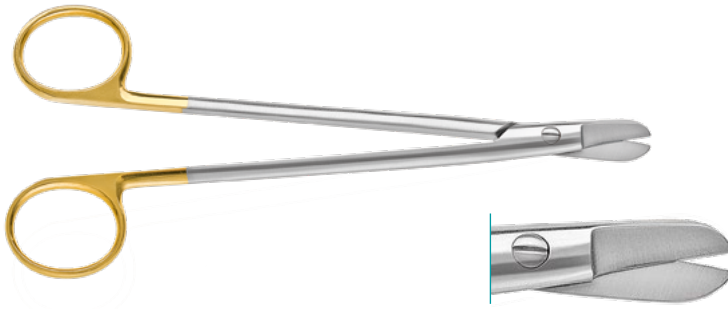
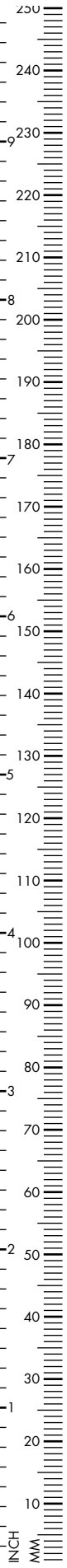

### SMITH TC

Wire cutting Scissors, straight

160mm, 6<sup>1</sup>/<sub>4</sub>" 120-570-160

curved

160mm, 6<sup>1</sup>/<sub>4</sub>" 120-571-160

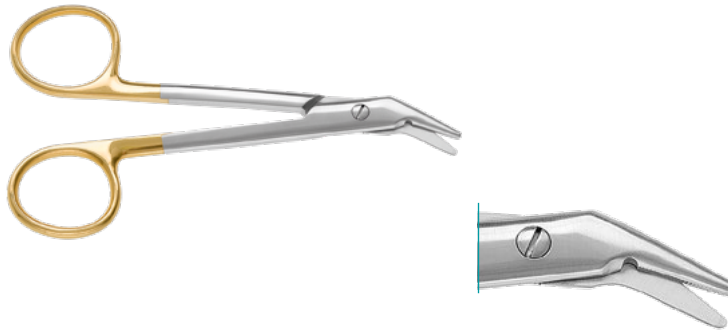

TC Universal Wire Scissors for cutting suture and wire up to 26 gauge and smaller

120mm, 4<sup>3</sup>/<sub>4</sub>" 120-565-120



TC Parametrium Scissors, 230mm, 9"

slightly curved 120-537-002

medium curved 120-537-003

angled 120-537-004

265mm, 10<sup>1</sup>/<sub>2</sub>"

slightly curved 120-536-002

medium curved 120-536-003

angled 120-536-004

305mm, 12"

slightly curved 120-538-002

medium curved 120-538-003

angled 120-538-004



**IRIS CERACUT®**  
115mm, 4<sup>1/2</sup>"

straight	123-070-115
curved	123-071-115



**STEVENS CERACUT®**

Tenotomy Scissors, curved, blunt

100mm, 4"	123-197-100
120mm, 4 <sup>3/4</sup> "	123-197-120
150mm, 6"	123-197-150
180mm, 7"	123-092-185
sharp	
110mm, 4 <sup>1/3</sup> "	123-197-110



**STEVENS CERACUT®**

Dissecting Scissors, straight, square rings  
115mm, 4<sup>1/2</sup>"

sharp	123-182-115
blunt	123-184-115

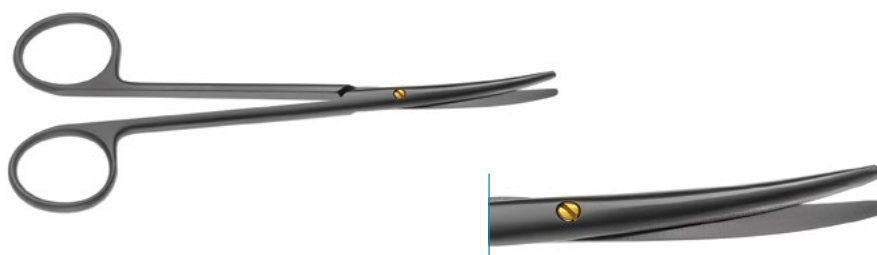

**BABY METZENBAUM CERACUT®**

curved

110mm, 4 <sup>1/3</sup> "	123-317-110
145mm, 5 <sup>3/4</sup> "	123-317-145



**METZENBAUM NELSON CERACUT®**

curved

145mm, 5 <sup>3</sup> / <sub>4</sub> "	123-111-145
180mm, 7"	123-111-180
200mm, 8"	123-111-200
230mm, 9"	123-111-230



**MAYO CERACUT®**

straight

145mm, 5 <sup>3</sup> / <sub>4</sub> "	123-030-145
170mm, 6 <sup>2</sup> / <sub>3</sub> "	123-030-170

curved

145mm, 5 <sup>3</sup> / <sub>4</sub> "	123-031-145
170mm, 6 <sup>2</sup> / <sub>3</sub> "	123-031-170



**MAYO STILLE CERACUT®**

170mm, 6<sup>2</sup>/<sub>3</sub>"

straight	123-036-170
curved	123-037-170

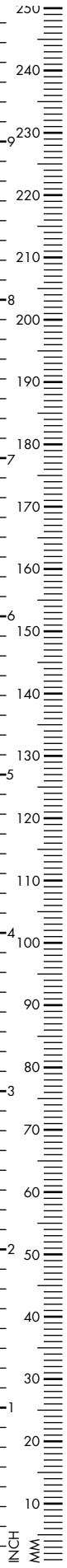





**MATARASSO TC CERACUT®**

Facelift Scissors, curved

170mm, 6 <sup>2</sup> / <sub>3</sub> "	123-305-170
200mm, 8"	123-305-200



**GORNEY CERACUT®**

Facelift Scissors, serrated, flat tip

190mm, 7<sup>1</sup>/<sub>2</sub>"

straight	123-584-190
curved	123-585-190



**DIETHRICH HEGEMANN CERACUT®**

180mm, 7"

45°	123-175-045
60°	123-175-060

