

PCNL Percutaneous Nephrolithotomy



Your system for stone management

MINI PCNL SYSTEM



12
CHARR.

MINI PCNL

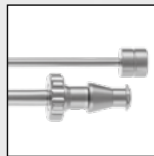

Closure system

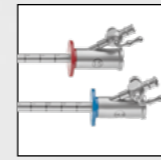

Mini PCNL sheaths with additional part

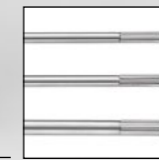

One-Step-Dilators in different sizes



Mini Scope with minimal diameter for the maximum visualization

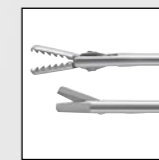

The right instrument for all stones

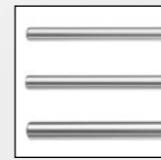

Long mini PCNL sheaths for the vacuum cleaner effect

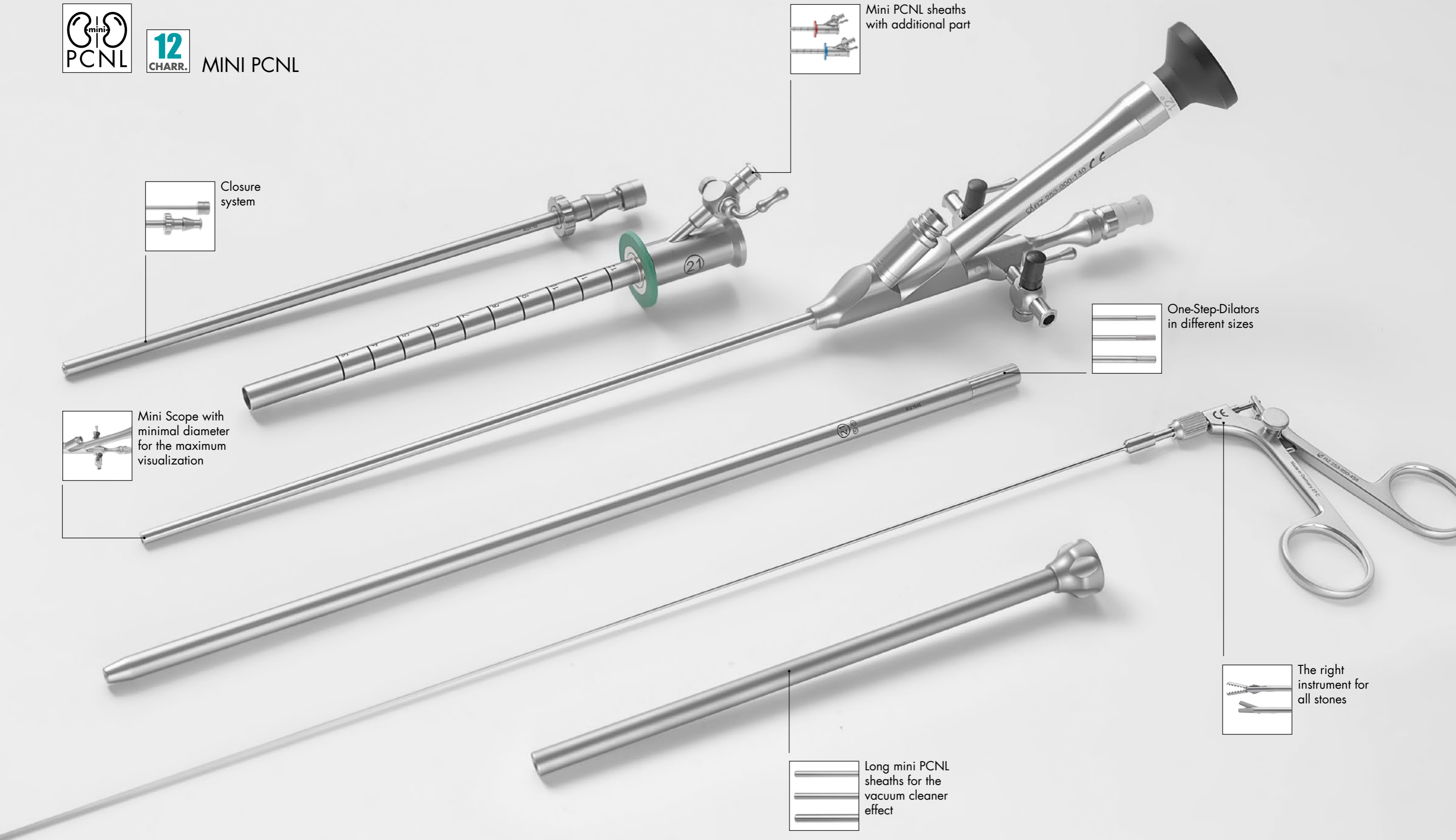

MINI PCNL SYSTEM



12 Charr. MINI NEPHROSCOPE

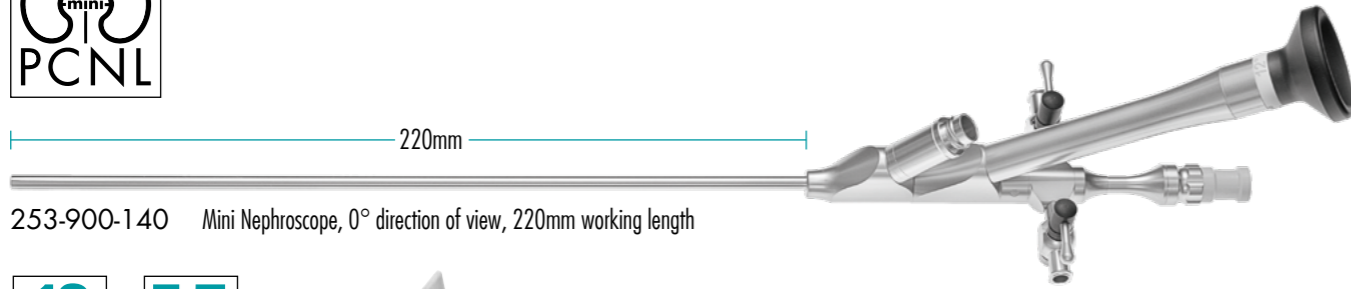

253-900-140 Mini Nephroscope, 0° direction of view, 220mm working length

12 CHARR. **7.5** CHARR.
 Ø SHAFT WORKING CHANNEL*

* for use with instruments up to 5 Charr.



253-905-400 Silicone Valve, package with 5 pieces



253-900-010 Silicone Valve, package with 10 pieces, for use with very delicate instruments from 0.5 – 1.6mm diameter.

Mini PCNL Operating Sheaths with valve



253-900-141 15.0 Charr. ●



253-900-142 16.5 Charr. ●



253-900-143 21.0 Charr. ●

Mini PCNL Sheaths

253-900-171 15.0 Charr.
 253-900-175 16.5 Charr.
 253-900-173 21.0 Charr.

One-Step Dilators with 1 central guide wire channel

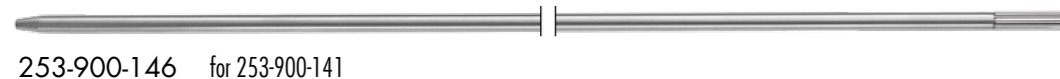

253-900-146 for 253-900-141



253-900-147 for 253-900-142, with 1 excentric guide wire channel

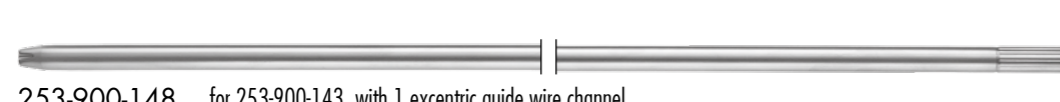

253-900-148 for 253-900-143, with 1 excentric guide wire channel

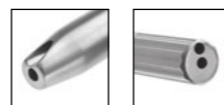
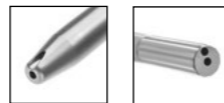
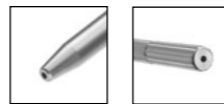

253-900-145 2-piece Sealing Adapter with sheath and obturator for use with 253-900-141

RZ NEPHROSCOPY INSTRUMENTS

semi-rigid, 5 Charr.

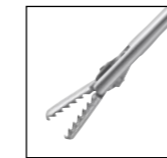
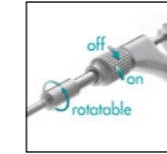
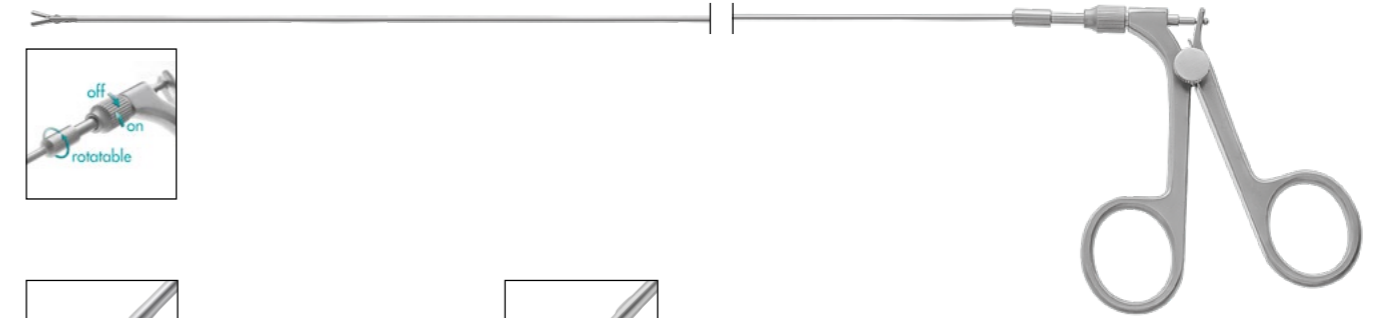

Stone Grasping Forceps, double action jaws, retrograde serration 253-950-455 450mm working length

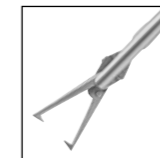

Stone Grasping Forceps for large stones, double action jaws, 1 x 1 teeth 253-952-455* 450mm working length



Hamada Long Stone Grasping Forceps, double action jaws, fine serrated 253-954-455 450mm working length

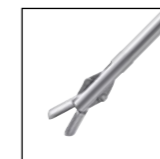

Biopsy Forceps, double action jaws 253-956-455 450mm working length

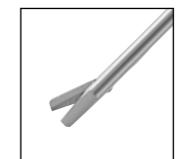

Scissors, single action jaws 253-958-455 450mm working length

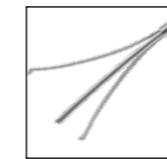

253-960-360 Stone grasping forceps, rigid, 5 Charr., 400mm, for grasping of bigger stones&fragments triple toothed jaw, U-spring handle

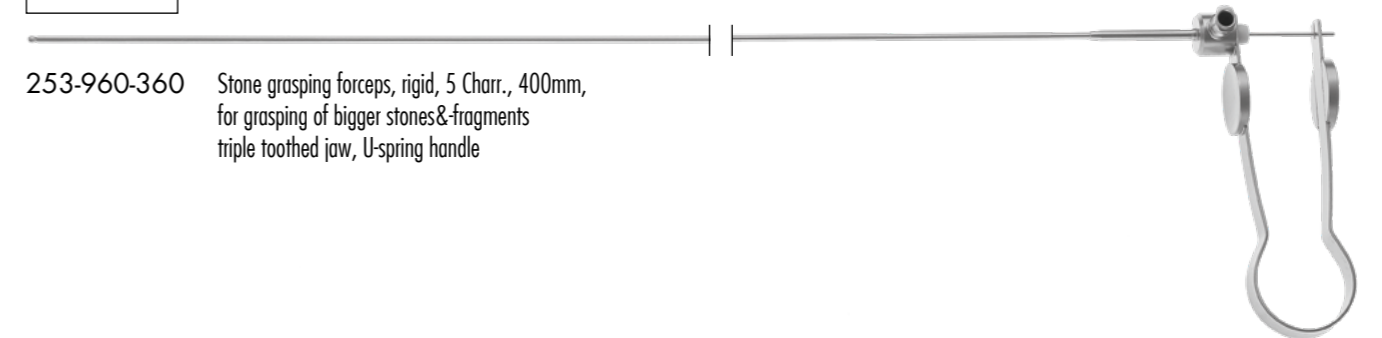

253-900-200 Sterile disposable Guide wire, J-tip, flexible, 150cm length



COMPACT NEPHROSCOPE



COMPACT NEPHROSCOPE



COMPACT NEPHROSCOPE COMPONENTS

- 1 Compact Nephroscope, 12°/30°, with adapter
- 2 Shaft with Obturator (23 Charr)
- 3 Nephroscope Instruments

COMPACT NEPHROSCOPE

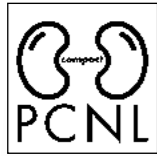

RZ COMPACT NEPHROSCOPE

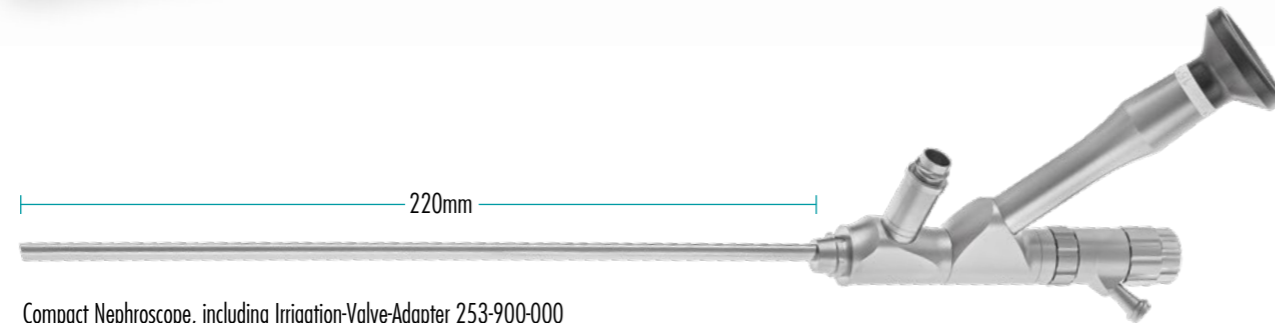
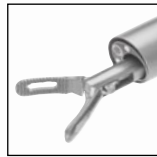

Compact Nephroscope, including Irrigation-Valve-Adapter 253-900-000
 18.8 Charr., 12.9 Charr working channel
 253-900-815 15°
 253-900-830 30°



Suitable Shaft, with obturator, 23 Charr., 220mm working length
 253-900-888



253-900-000
 Irrigation-Valve-Adapter

STANDARD PCNL

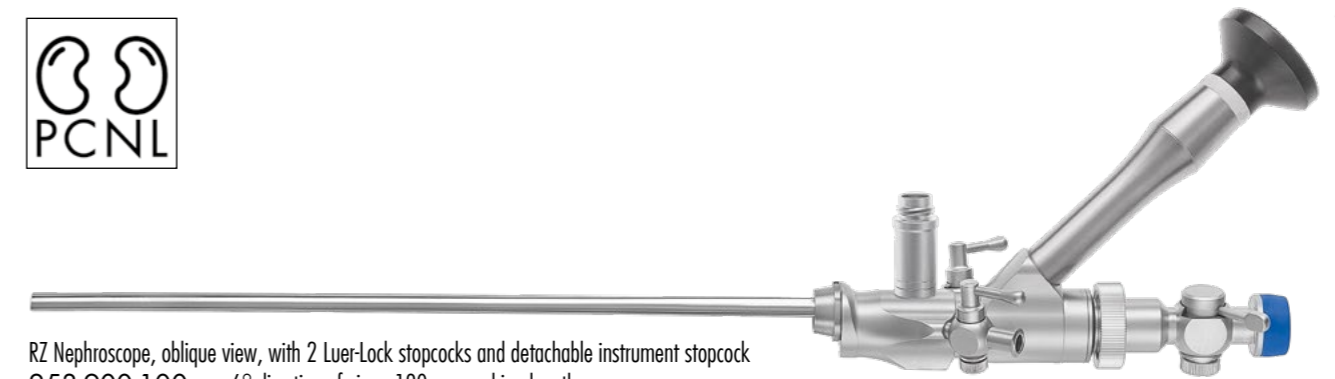
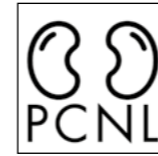

RZ Nephroscope, oblique view, with 2 Luer-Lock stopcocks and detachable instrument stopcock
 253-900-100 6° direction of view, 190mm working length
 253-900-120 6° direction of view, 250mm working length
 253-900-150 15° direction of view, 190mm working length
 253-900-160 15° direction of view, 250mm working length



253-900-105 Stopcock, only for use with RZ Nephrosopes

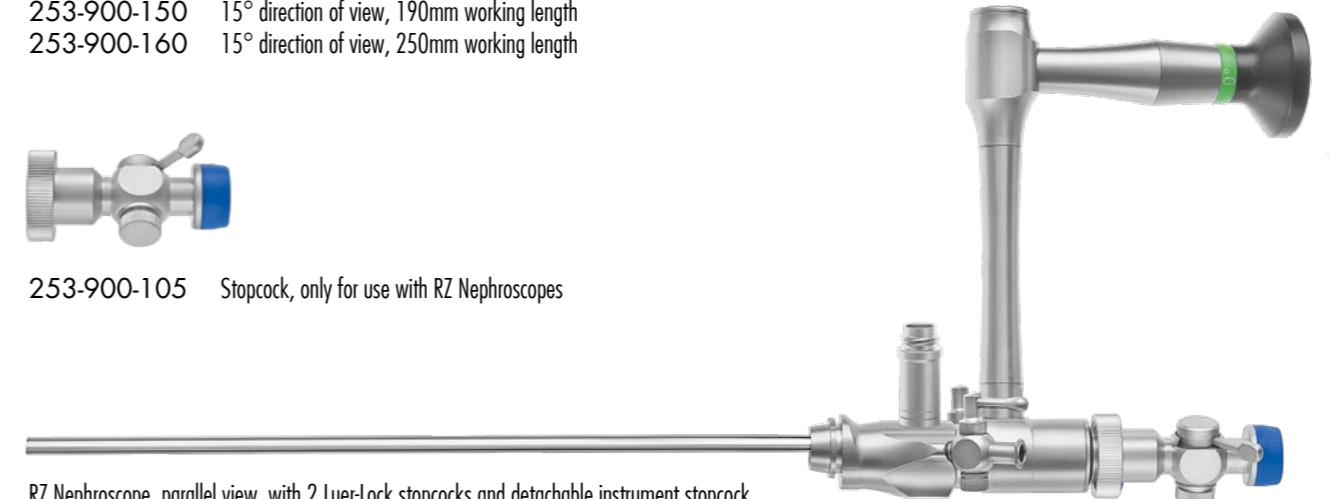

RZ Nephroscope, parallel view, with 2 Luer-Lock stopcocks and detachable instrument stopcock
 253-900-101 6° direction of view, 190mm working length
 253-900-121 6° direction of view, 250mm working length
 253-900-151 15° direction of view, 190mm working length
 253-900-161 15° direction of view, 250mm working length



Operating Sheaths
 253-900-110 26 Charr., 190mm working length ●
 253-900-111 24 Charr., 190mm working length ●
 253-900-130 26 Charr., 250mm working length ●
 253-900-131 24 Charr., 250mm working length ●



Hollow Obturators
 253-900-115 26 Charr., 190mm working length ●
 253-900-116 24 Charr., 190mm working length ●
 253-900-135 26 Charr., 250mm working length ●
 253-900-136 24 Charr., 250mm working length ●

STANDARD PCNL

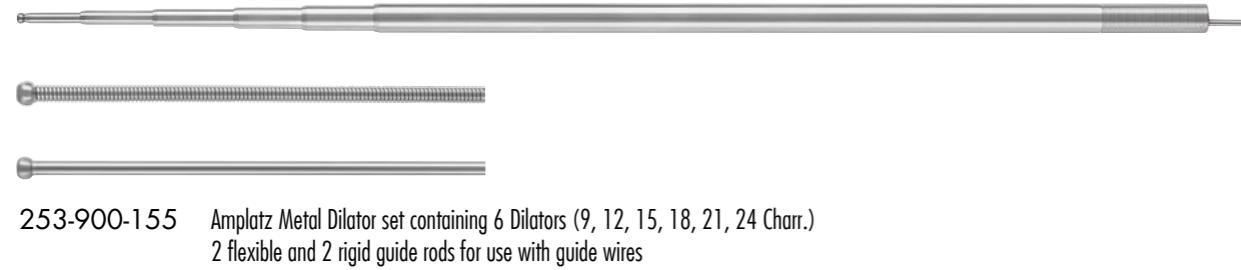

253-900-155 Amplatz Metal Dilator set containing 6 Dilators (9, 12, 15, 18, 21, 24 Charr.)
2 flexible and 2 rigid guide rods for use with guide wires



Amplatz Metal Dilator
253-900-156 27 Charr.
253-900-157 30 Charr.

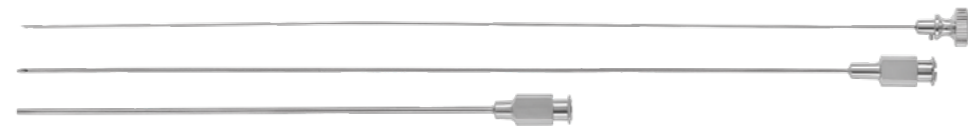

253-900-201 Puncture Cannula with inner and outer cannula



253-900-202 Dilation Cannula, 3mm \varnothing with inner and outer cannula



253-900-200 Sterile disposable Guide wire, J-tip, flexible, 150cm length

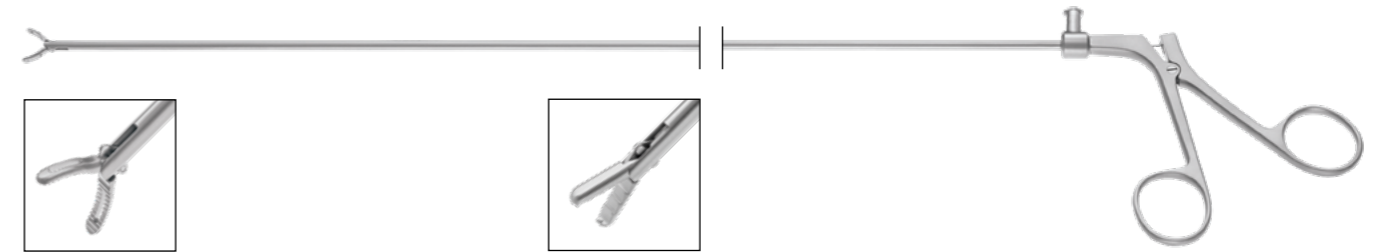

Stone Grasping forceps with fenestrated jaws,
double action, with flushing port
253-900-210* 360mm working length
253-900-250* 430mm working length



Stone Grasping forceps with coarse serrated jaws,
double action
253-900-212* 360mm working length
253-900-252* 430mm working length



Biopsy forceps with sharp cup,
single action
253-900-211 360mm working length
253-900-251 430mm working length

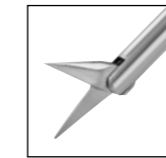

Scissors, sharp tip,
single action
253-900-213 360mm working length
253-900-253 430mm working length

Stone Grasping Forceps with spring handle and finger platform
 \varnothing 4mm, Luer-Lock connection

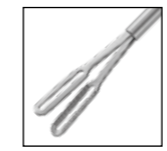

Fenestrated jaws
253-900-205 360mm
253-900-245 450mm



3 prongs
253-900-206 360mm
253-900-246 450mm

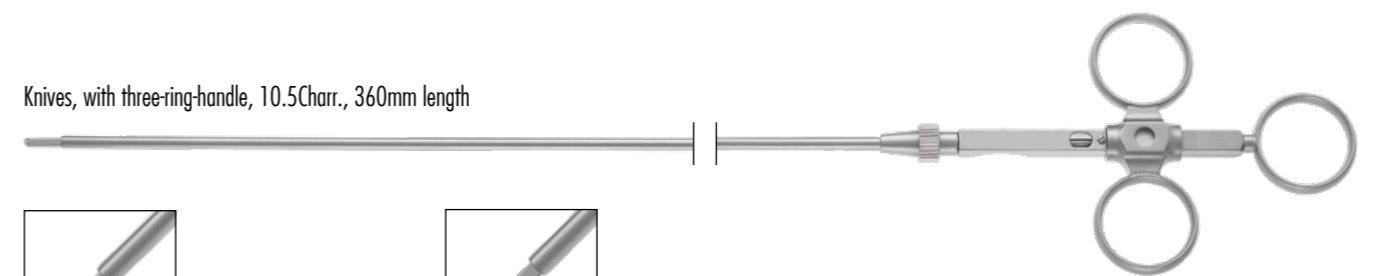

253-900-238
Straight Knife



253-900-239
Sickle Knife



RZ Medizintechnik GmbH

Unter Hasslen 20
78532 Tuttlingen, Germany

Phone: +49 (0)7462/9470-0
Fax: +49 (0)7462/9470-50

sales@rz-medizintechnik.com
www.rz-medizintechnik.com



Products marked with this symbol
are not available with RZ-marking,
and not the CE sign/CE number
of RZ.

