



OTOLOGY

Instruments and
Equipment for
Otology



100-102-100

XENON OP Stirnleuchte, Stirrband schwarz, KI-Kabel geteilt, Stirrband mit Kopfbügel

XENON OP Headlight, black head band, super light-weight, leather padded FO cable bifurcated, top headband

Distanz/Distance	Spot \varnothing
20 cm	11 mm - 67 mm
30 cm	12 mm - 101 mm
40 cm	13 mm - 136 mm
50 cm	14 mm - 172 mm
60 cm	16 mm - 208 mm



100-103-100

Kopfleuchte mit Kaltlichtkabel Adaptern zur Verwendung an üblichen Kaltlichtquellen, mit Lederpolsterung

Head Light with light cable for use with all common light sources, with leather pad at silicone band



100-104-000

CLAR

Stirnlampe 55, komplett, 6 V, mit Celluloidband

Head Light 55, complete, 6 V, with Celluloidband

100-104-001

Weißes Stirrband aus Celluloid allein, zur Stirnlampe 100-104-000

White celluloid headband only, for head light 100-104-000

100-104-002

Reflektor allein, für Stirnlampe 100-104-000

Mirror only, for head light 100-104-000

100-104-006

Ersatz-Birnchen allein, 6Volt

Spare bulb, 6 volt



100-103-120

FO Mini Stirnleuchte STANDARD, fokussierbar,
ergonomisches Stirnband, 2,6mm Ø FO Kabel
FO Head Light STANDARD, focussable, ergonomical
head band, 2.6mm Ø FO cable



100-103-400

LED Kopfleuchte mit Li-Ionen Batterie, Stirnband mit
stufenlosem Einstellrad, inkl. Ladegerät
LED Head light with Li-Ion battery, head band with
stepless regulation wheel, including charger



100-100-002

ZIEGLER

Stirnband aus Kunststoff allein, schwarz
Headband, plastic, black

100-100-003

ZIEGLER

Stirnband aus Kunststoff allein, weiß
Headband, plastic, white



100-105-010

MURPHY

Stirnband aus Celluloid, weiß, allein
Headband, celluloid, white

100-100-006

Doppelgelenk aus Metall
Double joint of metal

100-100-006





250-039-000



250-038-000



250-048-000



250-051-000



250-037-000



250-044-000



250-045-000



250-052-000



250-059-000

Adaperstücke / Adaptor pieces

250-039-000	RZ/Storz
250-038-000	ACMI/British Standard CUDA
250-048-000	Luxtec
250-051-000	Stryker
250-037-000	Wolf
250-044-000	Olympus
250-045-000	Olympus - Standard
250-052-000	Heine
250-059-000	Pentax



100-610-100

Kopflupe, 1.8 x Vergrößerung mit verstellbarem Kopfband
Head Loup, 1.8x magnification with adjustable head band

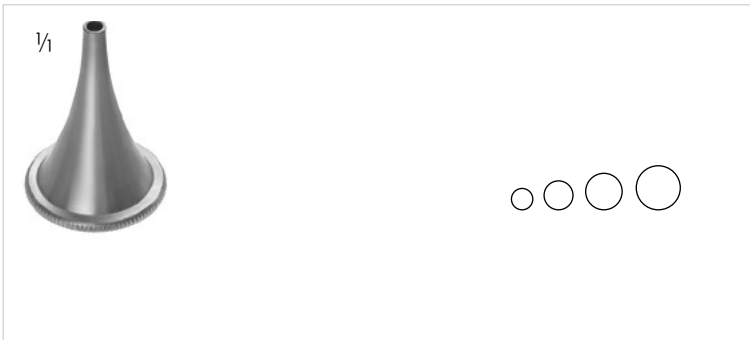

- 410-009-003 Innen/inner Ø: 2mm, Außen/outer Ø: 3mm
- 410-009-004 Innen/inner Ø: 3mm, Außen/outer Ø: 4mm
- 410-009-005 Innen/inner Ø: 4mm, Außen/outer Ø: 5mm
- 410-009-006 Innen/inner Ø: 5mm, Außen/outer Ø: 6mm
- 410-009-100 Satz aus 4 Teilen / Set of 4 pieces

POLITZER

Ohrspekula rund, gerade, 19mm Ø Rändel, 27mm Länge, rostfrei, für Kinder

Aural Speculum round, 19mm knurl Ø, straight, 27mm length, stainless, for children

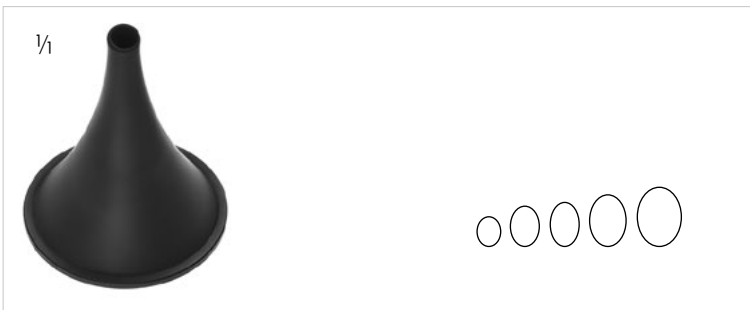

- 410-011-001 Außen/outer Ø: 3.3x4.1mm
- 410-011-002 Außen/outer Ø: 4.0x5.5mm
- 410-011-003 Außen/outer Ø: 5.0x7.5mm
- 410-011-004 Außen/outer Ø: 6.0x8.5mm
- 410-011-005 Außen/outer Ø: 7.0mmx9.5mm
- 410-011-100 Satz aus 5 Teilen / Set of 5 pieces

SHEA

Ohrspekula oval, abgeschrägt, geschwärzt, 38mm Länge
Aural Speculum oval, angled, black finish, 38mm length

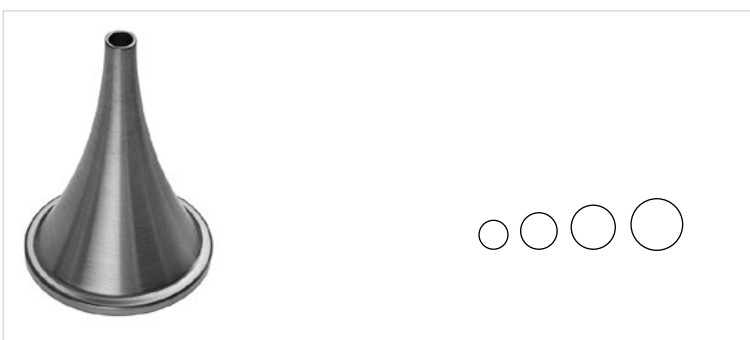

- | | Innen/inner Ø | Außen/outer Ø |
|-------------|-----------------------------------|---------------|
| 410-014-004 | 3mm | 4mm |
| 410-014-005 | 4mm | 5mm |
| 410-014-006 | 5mm | 6mm |
| 410-014-007 | 6mm | 7mm |
| 410-014-100 | Satz aus 4 Teilen/Set of 4 Pieces | |

TOYNBEE

Ohrspekula rund, gerade 36mm Länge

Aural Speculum round, straight, 36mm length

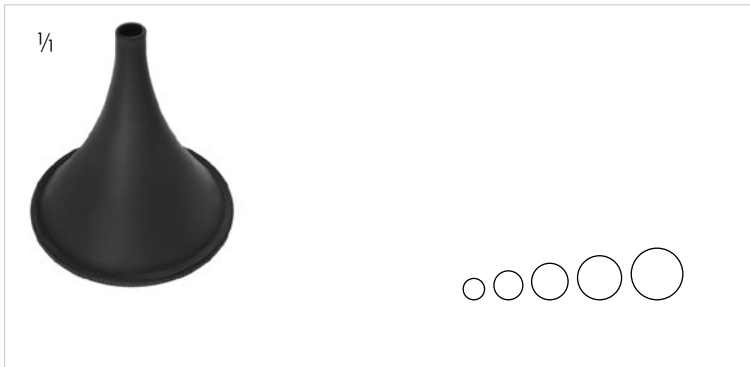

- 410-016-001 Außen/outer \varnothing : 3mm, rund/round
- 410-016-002 Außen/outer \varnothing : 4mm, rund/round
- 410-016-003 Außen/outer \varnothing : 5mm, rund/round
- 410-016-004 Außen/outer \varnothing : 6mm, rund/round
- 410-016-005 Außen/outer \varnothing : 7mm, rund/round

ROSEN

Ohrspekula gerade, geschwärzt, 38mm Länge
Aural Speculum straight, black finish, 38mm length



- 410-018-004 Innen/inner \varnothing : 3mm, Außen/outer \varnothing : 4mm
Länge/length: 31mm
- 410-018-005 Innen/inner \varnothing : 4mm, Außen/outer \varnothing : 5mm
Länge/length: 32mm
- 410-018-006 Innen/inner \varnothing : 5mm, Außen/outer \varnothing : 6mm
Länge/length: 33mm
- 410-018-007 Innen/inner \varnothing : 6mm, Außen/outer \varnothing : 7mm
Länge/length: 34mm
- 410-018-008 Innen/inner \varnothing : 7mm, Außen/outer \varnothing : 8mm
Länge/length: 35mm
- 410-018-085 Innen/inner \varnothing : 7.6mm, Außen/outer \varnothing : 8.5mm
Länge/length: 36mm
- 410-018-009 Innen/inner \varnothing : 8mm, Außen/outer \varnothing : 9mm
Länge/length: 36mm
- 410-018-010 Innen/inner \varnothing : 8mm, Außen/outer \varnothing : 10mm
Länge/length: 37mm

BOUCHERON

Ohrspekula rund, gerade, verchromt
Ear speculum, round, straight end, chrome plated



- Erwachsene/Adult: 36mm Länge/length
- 410-019-030 Außen/outer \varnothing : 3mm
 - 410-019-040 Außen/outer \varnothing : 4mm
 - 410-019-050 Außen/outer \varnothing : 5mm
 - 410-019-060 Außen/outer \varnothing : 6mm
 - 410-019-075 Außen/outer \varnothing : 7.5mm

Kinder/Children: 27mm Länge/length

- 410-019-003 Außen/outer \varnothing : 3mm
- 410-019-004 Außen/outer \varnothing : 4mm
- 410-019-005 Außen/outer \varnothing : 5mm

HARTMANN

Ohrspekula rund, gerade, rostfrei
Aural Speculum round, straight, stainless

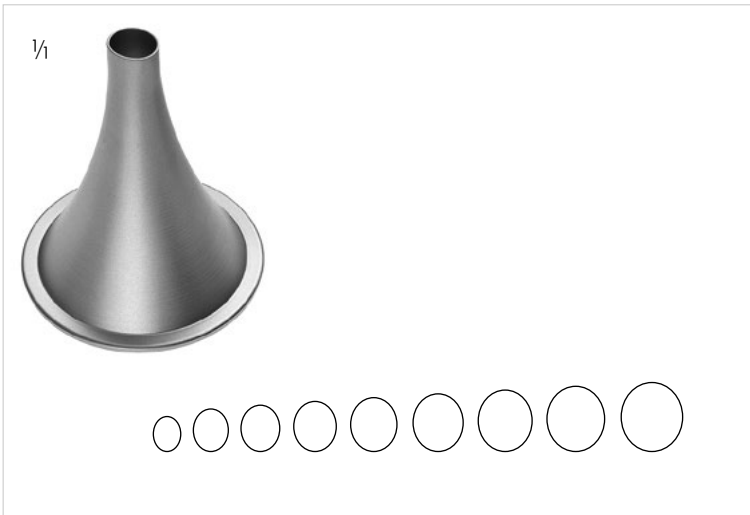

	Innen/inner \varnothing	Außen/outer \varnothing
410-021-001	3x4mm	3.8x4.8mm
410-021-002	4x5mm	4.8x5.8mm
410-021-003	4.5x5.5mm	5.3x6.3mm
410-021-004	5x6mm	5.8x6.8mm
410-021-005	5.5x6.5mm	6.3x7.3mm
410-021-006	6x7mm	6.8x7.8mm
410-021-007	6.5x7.5mm	7.3x8.3mm
410-021-008	7x8mm	7.8x8.8mm
410-021-009	7.5x8.5mm	8.3x9.3mm
410-021-000	Satz mit 9 Stück Set of 9 pieces	

FARRIOR

Ohrspekula oval, gerade, 43mm, rostfrei
Aural Speculum oval, straight, 43mm, stainless



	Innen/inner \varnothing	Außen/outer \varnothing
410-022-001	3.3mm	4.1mm
410-022-002	4.3mm	5.1mm
410-022-003	4.8mm,	5.6mm
410-022-004	5.3mm	6.1mm
410-022-005	5.8mm	6.6mm
410-022-006	6.3mm	7.1mm
410-022-007	6.7mm	7.5mm
410-022-008	7.2mm	8.0mm
410-022-009	7.7mm	8.5mm
410-022-000	Satz aus 9 Teilen Set of 9 Pieces	

FARRIOR

Ohrspekula rund, gerade, 35mm \varnothing Rändel, 43mm Länge, rostfrei
Aural Speculum round, 35mm knurl \varnothing , straight, 43mm length, stainless



	Innen/inner \varnothing	Außen/outer \varnothing
410-023-001	3x4mm	3.8x4.8mm
410-023-002	4x5mm	4.8x5.8mm
410-023-003	4.5x5.5mm	5.3x6.3mm
410-023-004	5x6mm	5.8x6.8mm
410-023-005	5.5x6.5mm	6.3x7.3mm
410-023-006	6x7mm	6.8x7.8mm
410-023-007	6.5x7.5mm	7.3x8.3mm
410-023-008	7x8mm	7.8x8.8mm
410-023-009	7.5x8.5mm	8.3x9.3mm
410-023-000	Satz mit 9 Stück Set of 9 pieces	

FARRIOR

Ohrspekula oval, 20° abgeschrägt, 43mm, rostfrei
Aural Speculum oval, 20° oblique end, 43mm, stainless

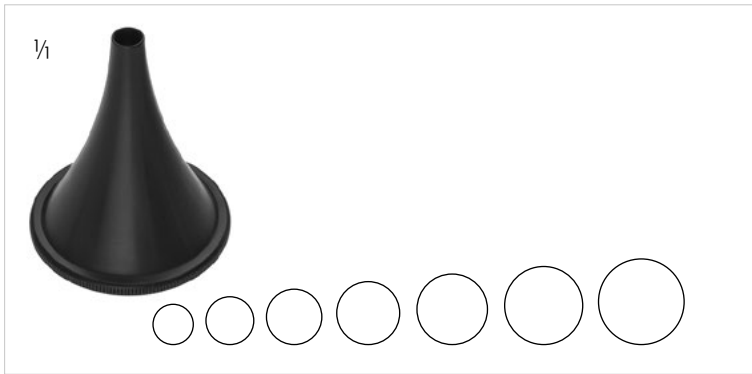

	Innen/inner Ø	Außen/outer Ø
410-024-001	4.5mm	5.5mm
410-024-002	5.5mm	6.5mm
410-024-003	6.5mm	7.5mm
410-024-004	7.5mm	8.5mm
410-024-005	8.5mm	9.5mm
410-024-006	9.5mm	10.5mm
410-024-007	10.5mm	11.5mm

FARRIOR

Ohrspekula rund, gerade, 36mm, geschwärzt
Aural Speculum round, 36mm straight end, black finish



	Innen/inner Ø	Außen/outer Ø
410-032-050	4mm	5mm
410-032-060	5mm	6mm
410-032-070	6mm	7mm

HOLMGREN

Ohrspekula, selbsthaltend, geschwärzt
Aural Speculum, self retaining, black finish



	Innen/inner Ø	Außen/outer Ø
410-132-001	4.5x5.5mm	5.5x6.5mm
410-132-002	5.5x6.5mm	6.5x7.5mm
410-132-003	6.5x7.5mm	7.5x8.5mm
410-132-004	7.5x8.5mm	8.5x9.5mm
410-132-005	8.5x9.5mm	9.5x10.5mm
410-132-006	9.5x10.5mm	10.5x11.5mm

ZOELLNER

Ohrspekula oval, gerade, geschwärztes Aluminium, 38mm Länge
Aural Speculum oval, straight, black finished aluminium, 38mm length



250-066-275

LEYLA

Ohrspekulahalter komplett, einstellbar zum Befestigen an Kopfbügel oder Stange des OP-Tisches. Der Arm wird durch den Spannhebel über einen Exzenter gespannt und in fixe Stellung gebracht.

Aural specula holder, flexible, for attaching to head bow or to the railing of operating table. The flexible part can be put in any fixed position by means of the wing-screw attached to an eccentric.

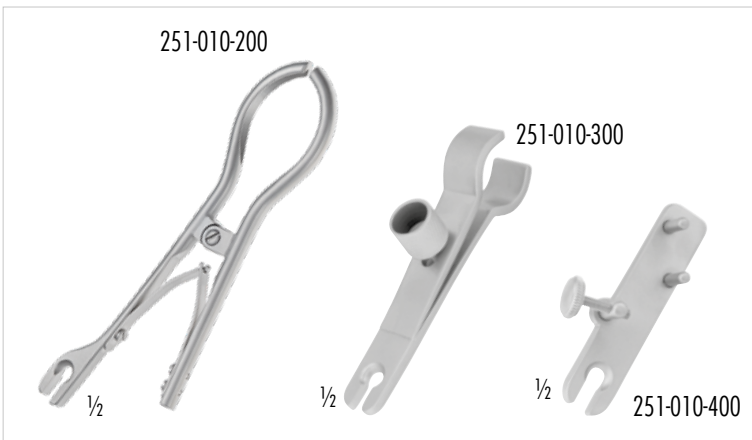

251-010-200

251-010-200

Ohrspekula Halter für flexiblen Spannarm
Aural specula holder for flexible arm

251-010-300

251-010-300

Endoskop Halterung für flexiblen Spannarm
Endoscope clamp for flexible arm

251-010-400

251-010-400

Nasenspekula Halterung für flexiblen Spannarm
Nasal specula clamp for flexible arm



251-010-000

RZ

Flexibler Arm komplett mit Haltestange ohne Gelenkkloben

Flexible Arm complete with holding rod without Rotating Clamp

251-010-100

Gelenkkloben für flexiblen Spannarm zur Befestigung am OP-Tisch

Rotating clamp for flexible tension arm attachable to operating table



410-004-000

Otoskop, 0°, Ø 4 mm, Arbeitslänge 50 mm

Otoscope, 0°, Ø 4 mm, working length 2 inch

410-004-030

Otoskop, 30°, Ø 4 mm, Arbeitslänge 50 mm

Otoscope, 30°, Ø 4 mm, working length 2 inch



410-027-000

Otoskop, 0°, Ø 2,7 mm, Arbeitslänge 75mm

Otoscope, 0°, Ø 2.7 mm, working length 2 ¾ inch

410-027-030

Otoskop, 30°, Ø 2,7 mm, Arbeitslänge 75mm

Otoscope, 30°, Ø 2.7 mm, working length 2 ¾ inch

410-027-070

Otoskop, 70°, Ø 2,7 mm, Arbeitslänge 75mm

Otoscope, 70°, Ø 2.7 mm, working length 2 ¾ inch

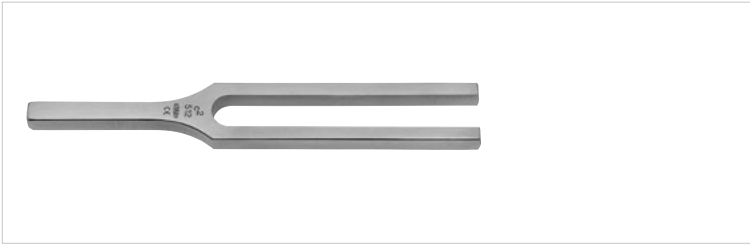

410-185-010 = c 128 410-185-110 = c1 256
 410-185-210 = c2 512 410-185-310 = c3 1024
 410-185-410 = c4 2048 410-185-510 = c5 4096

HARTMANN
 Stimmgabel
 Tuning fork



410-174-128 = c 128 410-174-256 = c1 256
 410-174-512 = c2 512 410-174-102 = c3 1024
 410-174-204 = c4 2048

LUCAE
 Stimmgabel mit Fuß
 Tuning fork with platform

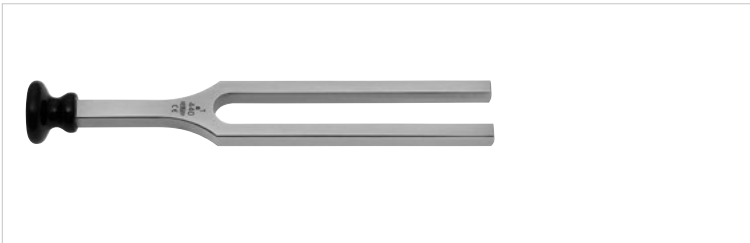

410-190-440 = c1 440
 Stimmgabel mit Fuß
 Tuning fork with platform

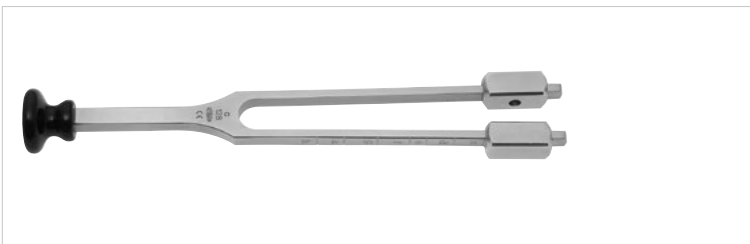

410-175-128 = c 128
LUCAE
 Stimmgabel für den Neurologen, mit Fuß und Dämpfer
 Tuning fork (for neurologists), with platform and clamps



410-195-010 = c 128
 410-195-110 = c1 256
HARTMANN
 Stimmgabel mit Dämpfer
 Tuning fork with clamps



410-180-125 = c 64 oder/or c 128
RYDEL-SEIFFER
 Stimmgabel mit Fuß, mit Dämpfer c 64,
 ohne Dämpfer c 128, abnehmbar
 Tuning fork with platform, with clamp c 64,
 without clamp c 128, detachable



410-180-010 = c 128 410-180-020 = c1 256
 410-180-030 = c2 512 410-180-040 = c3 1024
 Stimmgabel aus einer Aluminium-Speziallegierung
 Tuning fork, aluminum-alloy



410-185-200

HARTMANN

Stimmgabelsatz in Etui, enthaltend:

Tuning fork set in case containing:

410-195-010	= c	128
410-195-110	= c1	256
410-185-210	= c2	512
410-185-310	= c3	1024
410-185-410	= c4	2048
410-185-510	= c5	4096



410-195-000

HARTMANN

Stimmgabelsatz in Etui, enthaltend:

Tuning fork set containing:

410-195-010	= c	128
410-195-110	= c1	256
410-185-210	= c2	512
410-185-310	= c3	1024
410-185-410	= c4	2048

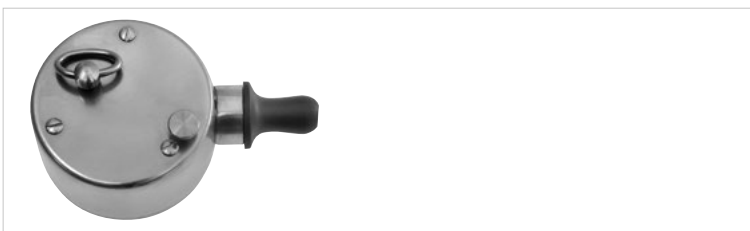

410-227-000

BARANY

Lärmtrommel mit Ohrolive

Noise instrument apparatus, with aural piece



410-797-050 50 ml
410-797-100 100 ml

SYRINGE

Ohrspritze komplett, Ganzmetallausführung mit konischem und abgerundetem Aufsatz

Aural syringe, all metal, complete with conical and bulbous pipe

410-798-100 110ccm

SYRINGE

Ohrspritze komplett, **Glasausführung** mit konischem und abgerundetem Aufsatz

Aural syringe, **Glas edition**, complete with conical and bulbous pipe

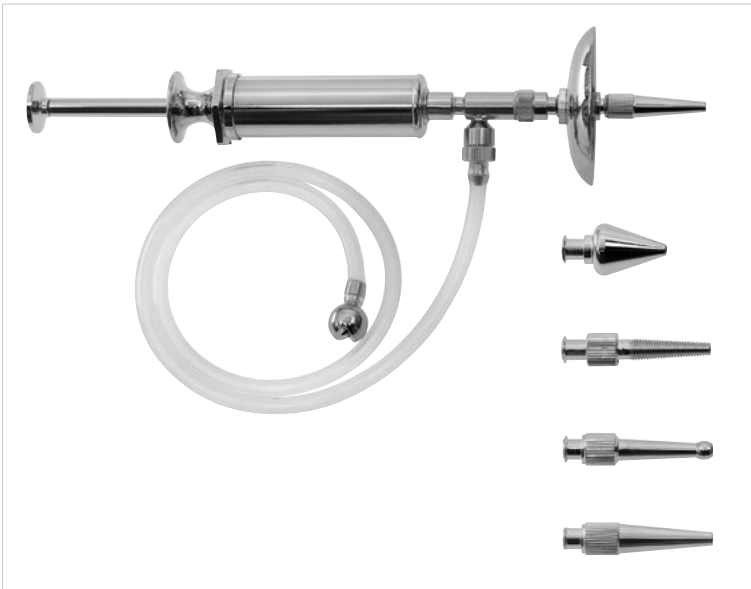

410-800-000

Ohrspritze komplett, 10 ml selbstfüllend, Ganzmetallausführung, verchromt, mit Luer-Lock-Ansatz bestehend aus:

Aural syringe, 10 ml, all metal chromium plated, for easy continous one hand filling and emptying. Luer-Lock attachment, consisting of:

410-800-100 Spritze, Ventilaufsatz, Saugfuß, Schutzteller
Syringe, valve attachment, metal sinker, Protection shield

410-800-020 Plastikschlauch, 600 mm,
Außen-Ø 5 mm, Innen-Ø 2 mm
Plastic tube, 600 mm long,
outside 5 mm, inside 2 mm

410-800-050 Set mit 4 Aufsätzen
Set with 4 tips

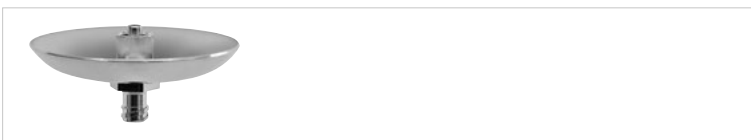

410-800-040

Schutzteller
Protection shield



410-800-030

Saugfuß
Metal sinker



410-800-010

Ventilaufsatz
Valve attachment



410-200-000
POLITZER
 Luftdusche mit Metallkonus
 Air douche, with metal cone

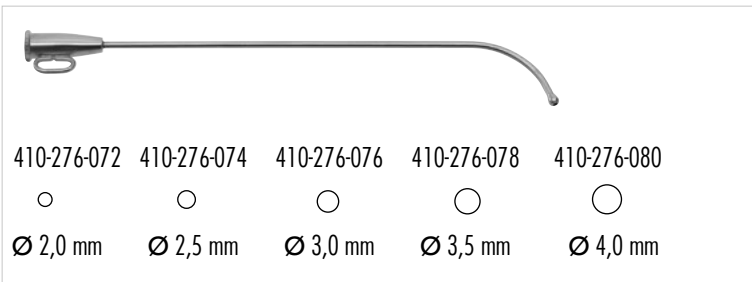

410-276-072 Ø 2,0 mm
 410-276-074 Ø 2,5 mm
 410-276-076 Ø 3,0 mm
 410-276-078 Ø 3,5 mm
 410-276-080 Ø 4,0 mm
HARTMANN
 Tubenkatheter
 Eustachian catheter



410-205-000
KABIERSKE
 Pulverbläser komplett mit 3 Aufsätzen und Gummiball
 Atomizer, complete with 3 metal tips and rubber bulb
 410-205-100 Gummiball allein
 Rubber bulb only
 410-205-001 Aural Kanüle, gerade, 100 mm
 Aural cannula, straight tip, 4 inch

410-205-001

410-205-002



160-131-105
STACKE Ø 0,8 mm
 Ohrsonde, 100 mm
 Aural probe, 4 inch

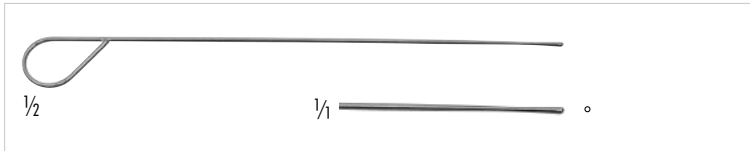

160-131-140
CAWTHORNE
 Ohrsonde, mit Ringgriff und abgeflachter Spitze, 140 mm
 Probe, ring handled and flattened end, 5 1/2 inch



160-410-120
BUCK Ø 0,9 mm
 Ohrwatteträger, Arbeitsende spiralförmig, 120 mm
 Cotton Applicator, rough spiral serrated end, 4 3/4 inch

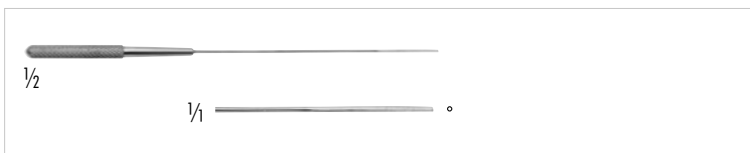

160-420-110
MODELL PICCOLO Ø 0,7 mm
 Ohrwatteträger, Arbeitsende rund gerieft, 110 mm
 Cotton applicator, slender, round serrated end, 4 1/2 inch



160-421-110
MODELL PICCOLO Ø 0,7 mm
 Ohrwatteträger, Arbeitsende dreikant gerieft, 110 mm
 Cotton applicator, slender, triangular serrated end, 4 1/2 inch

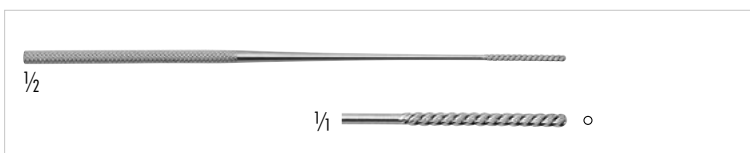

160-422-110 110 mm/4 1/2 inch
 160-422-140 140 mm/5 1/2 inch
FARRELL Ø 1,2 mm
 Ohrwatteträger, Arbeitsende rund gerieft
 Cotton applicator, round serrated end

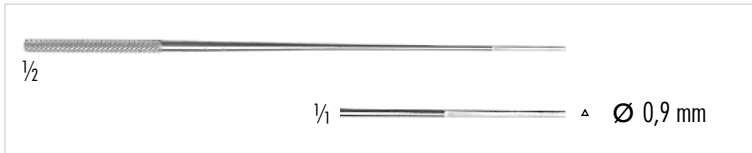

160-426-120 120mm, 4 ¾ inch
 160-426-140 140mm, 5 ½ inch
 Ohrwatteträger, Arbeitsende dreikant gerieft, Ø 0,9 mm
 Cotton applicator, triangular serrated end, Ø 0.9 mm

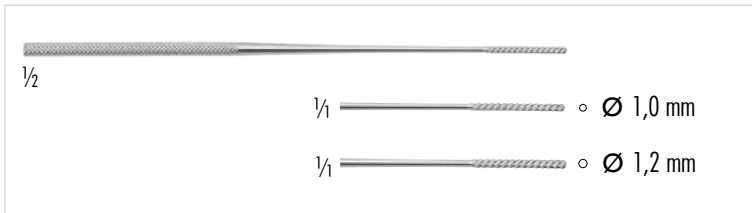

160-010-140 Ø 1,0 mm
 160-012-140 Ø 1,2 mm
 Ohrwatteträger, Arbeitsende spiralförmig, 140 mm
 Cotton applicator, spiral serrated end, 5 ½ inch

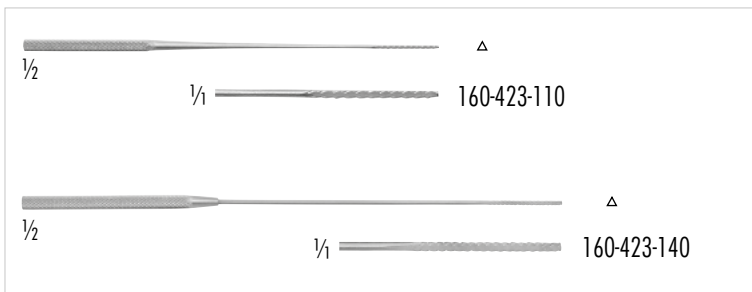

160-423-110 110 mm, 4 ½ inch
 160-423-140 140mm, 5 ½ inch
LATHBURY-FARRELL
 Ohrwatteträger, Arbeitsende dreikant gerieft, Ø 1,4 mm
 Cotton applicator, triangular serrated end, Ø 1.4 mm



160-255-140 140 mm, 5 ½ inch
 160-255-180 180 mm, 7 inch
JOBSON HORNE
 Ohrsonde
 Aural probe

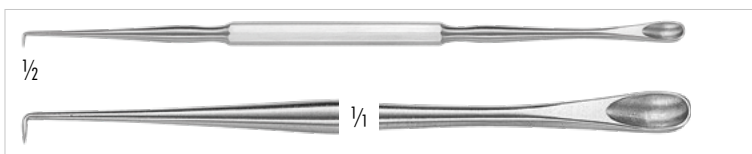

410-145-175 spitz/pointed
 410-146-175 stumpf/blunt
FORMBY
 Zerumenlöffel und - häkchen, 130 mm
 Cerumen scoop and hook, 5 ⅞ inch

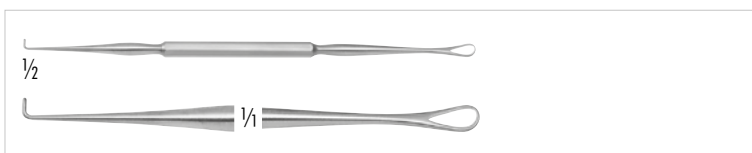

410-147-175 spitz/pointed
 410-148-175 stumpf/blunt
FORMBY
 Zerumenschlinge und - häkchen, 120 mm
 Cerumen loop and hook, 4 ¾ inch

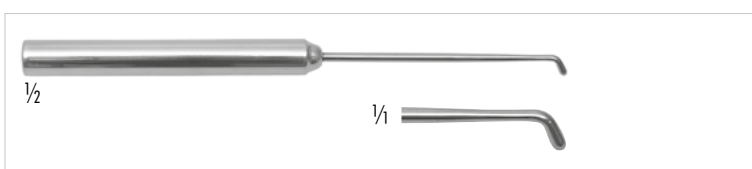

410-147-145
CAWTHORNE
 Zerumenhäkchen, 145 mm
 Cerumen hook, 5 ½ inch



410-581-160
ALLPORT
Ohrhäkchen, stumpf, 160 mm
Aural hook, blunt, 6 1/4 inch



410-583-150
ZAUFAL-JANSEN
Ohrhebel, geknöpft, 45° abgewinkelt, 150 mm
Aural hook, probe ended, 45° angled, 6 inch



410-584-001 Fig. 1
410-584-002 Fig. 2
DAY
Ohrhäkchen, 150 mm
Aural hook, 6 inch

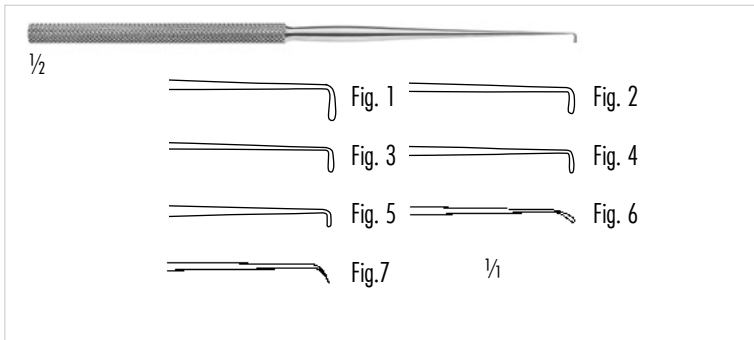

410-585-001 Fig. 1
410-585-002 Fig. 2
410-585-003 Fig. 3
410-585-004 Fig. 4
410-585-005 Fig. 5
410-585-006 Fig. 6
410-585-007 Fig. 7
WAGENER
Ohrhebel, 140 mm
Aural hook, 5 1/2 inch

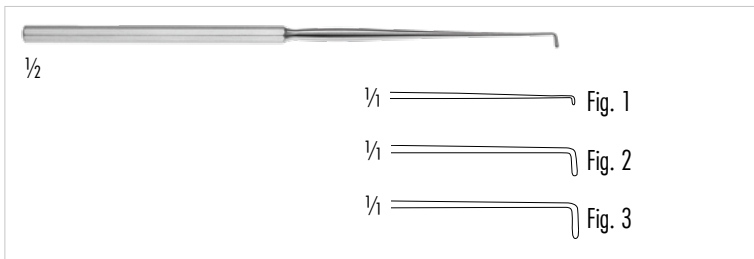

410-586-141 Fig. 1
410-586-142 Fig. 2
410-586-143 Fig. 3
LUCAE
Ohrhebel, geknöpft, 140 mm
Aural hook, probe ended, 5 1/2 inch

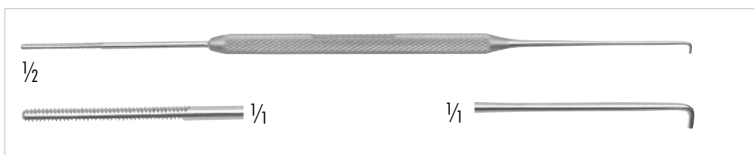

410-584-180
MUSGROVE
Zerumennadel und Watteträger, 180 mm
Cerumen pick and cotton applicator, 7 inch

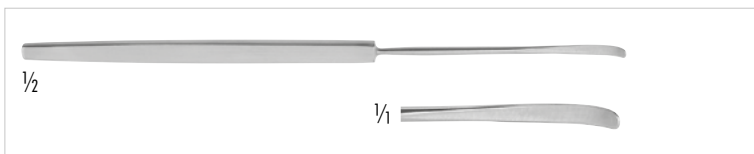

410-583-160
ZAUFAL
Ohrhebel, stumpf, 160 mm
Aural elevator, blunt, 6 1/4 inch

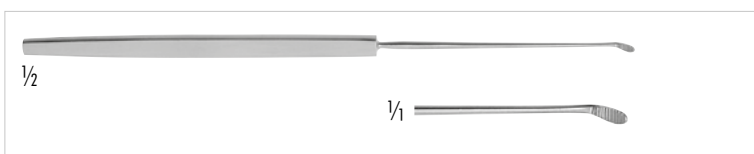

410-584-160
MOLDENHAUER
Fremdkörperhebel, 160 mm
Foreign body elevator, 6 1/4 inch

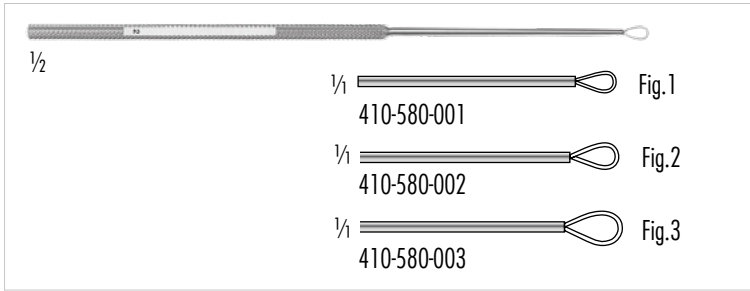

410-580-001 Fig.1
410-580-002 Fig.2
410-580-003 Fig.3

BILLEAU

Ohrschlinge, gerade, 160 mm
Aural loop, straight, 6 1/4 inch

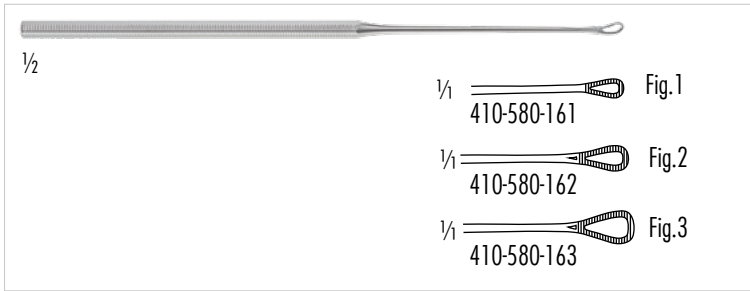

410-580-161 Fig.1
410-580-162 Fig.2
410-580-163 Fig.3

SNELLEN (WEBER-LOCH)

Ohrschlinge, gebogen, gerieft, 160 mm
Aural loop, curved, serrated, 6 1/4 inch

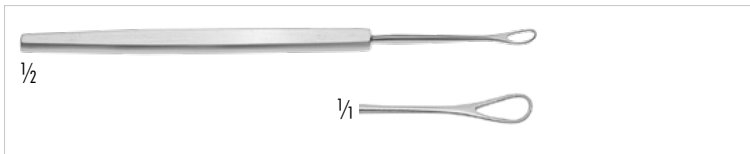

410-580-130

LANGENBECK

Ohrschlinge, stumpf, leicht gebogen, 130 mm
Aural loop, blunt, slightly curved, 5 inch

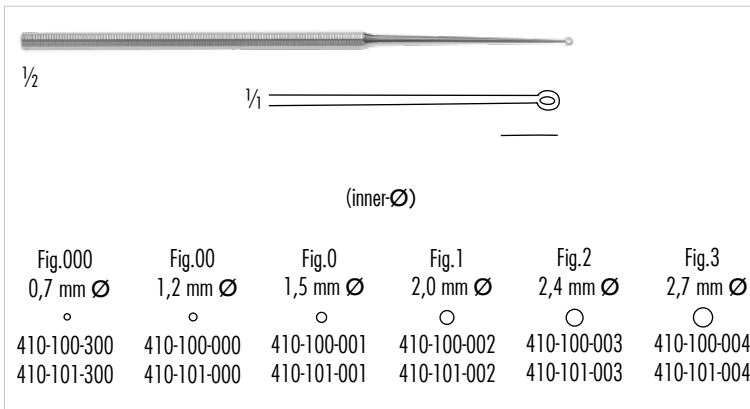

stumpf/blunt

410-100-000
410-100-001
410-100-002
410-100-003
410-100-004
410-100-300

scharf/sharp

410-101-000
410-101-001
410-101-002
410-101-003
410-101-004
410-101-300

BUCK

Ohrkürette, gerade, 150 mm
Aural curette, straight, 6 inch

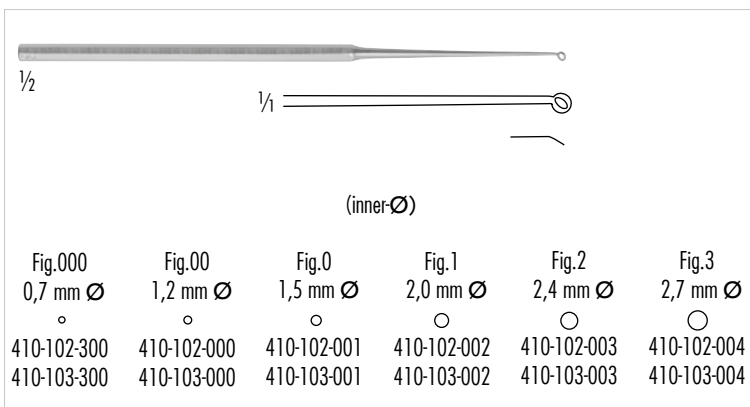

stumpf/blunt

410-102-000
410-102-001
410-102-002
410-102-003
410-102-004
410-102-300

scharf/sharp

410-103-000
410-103-001
410-103-002
410-103-003
410-103-004
410-103-300

BUCK

Ohrkürette, gebogen, 150 mm
Aural curette, curved, 6 inch

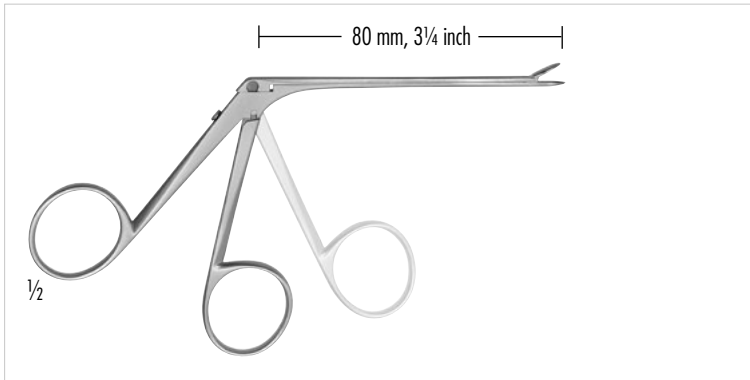

Fremdkörper- Ohrzängchen zur Untersuchung, **Zeigefingerringteil** beweglich, mit Schiebescchaft
Aural foreign body forceps for examination, opening and closing of the jaws by means of **finger ring-handle**, sliding shaft



410-210-085 1 x 8 mm, gerieftes Maulteil/serrated jaws
410-215-085 1 x 8 mm, glattes Maulteil/smooth jaws
HARTMANN
Faßzängchen, gerade
Aural forceps, straight



410-211-085 2 x 6 mm
HARTMANN
Faßzängchen, gerade, 1 x 2 Zähne
Aural forceps, straight, 1 x 2 teeth

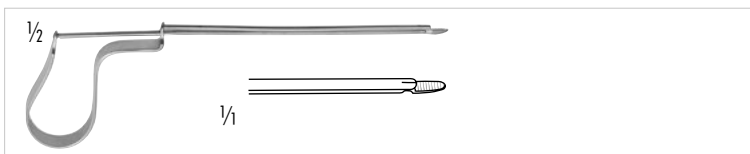

410-330-090
QUIRE
Fremdkörperinstrument, 90 mm
Aural forceps for removal of foreign bodies, 3 1/2 inch

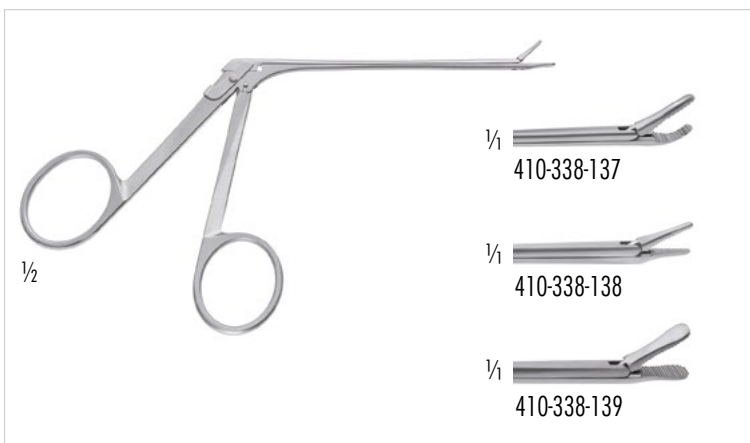

410-338-137 **WEINGARTNER**, 7 mm Maullänge/7 mm jaws
links gebogen/left curved
410-338-138 **HOUSE** 8 mm gerieft/8 mm serrated
410-338-139 **DUCKBILL** 8 mm gerieft/8 mm serrated
Ohrzängchen, Arbeitslänge: 87 mm
Ear Forceps, Working length: 3 1/8 inch

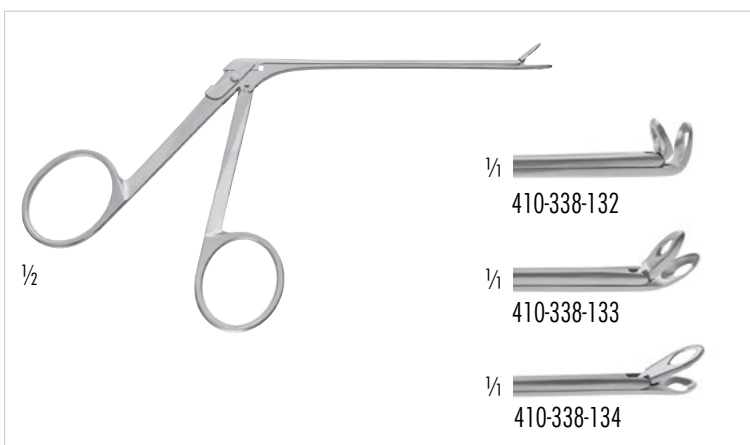

410-338-132 90° aufwärts/90° upwards, 2.5 x 6.0 mm
410-338-133 45° aufwärts/45° upwards, 2.5 x 6.5 mm
410-338-134 gerade/straight, 2.5 x 7.0 mm
STRUEMPEL
Ohrzängchen, Arbeitslänge: 87 mm
Ear Forceps, Working length: 3 1/8 inch

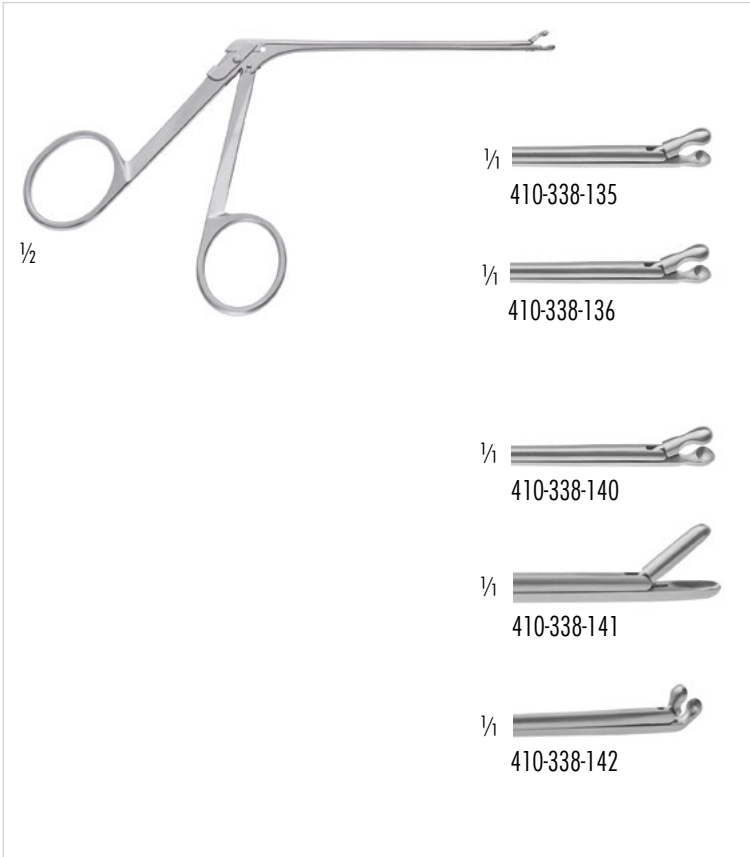

HARTMANN-HERZFELD

Ohrzängchen, Arbeitslänge: 87 mm
 Ear Forceps, Working length: 3 1/8 inch
 410-338-135 2 mm Löffel/2 mm spoon
 410-338-136 2,5 mm Löffel/2.5 mm spoon

410-338-140 3 mm Löffel/3 mm spoon
 410-338-141 2x6 mm Löffel/2x6 mm spoon
 410-338-142 2 mm Löffel, aufgebogen
 2 mm spoon, curved upwards

Ohrzängchen, Arbeitslänge: 87 mm
 Ear Forceps, Working length: 3 1/8 inch

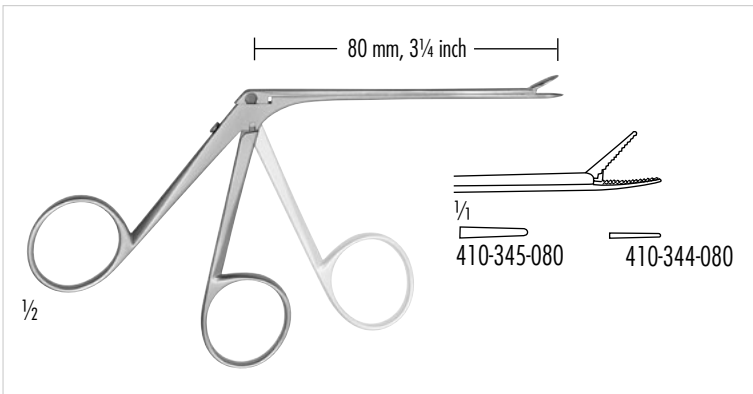

Fremdkörper-Ohrzängchen zur Untersuchung, feine Ausführung,
Zeigefingerringteil beweglich, mit Schiebenschaft
 Aural foreign body forceps for examination, extra fine pattern, opening
 and closing of the jaws by means of **finger ring-handle**, sliding shaft

410-345-080 0,8 x 6 mm
HARTMANN-WULLSTEIN
 Faßzängchen, gerade
 Aural forceps, straight

410-344-080 0,8 x 4 mm
HARTMANN-WULLSTEIN
 Faßzängchen, gerade
 Aural forceps, serrated jaws, straight

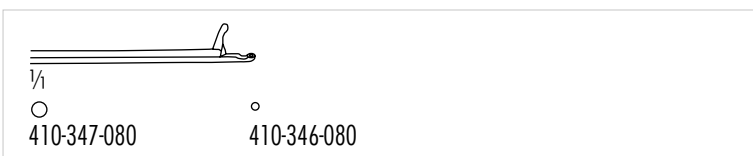

410-346-080 1 mm
 410-347-080 2 mm
HARTMANN-WULLSTEIN
 Löffelzängchen, gerade, runder Löffel
 Aural forceps, cup-shaped, straight, round cup

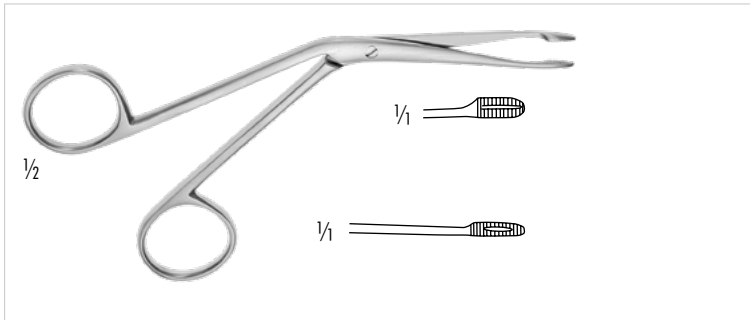

410-230-140
HARTMANN
 Ohrtamponzange, kräftiges Modell, 120 mm
 Aural tampon forceps, strong pattern, 4 3/4 inch

410-230-120
HARTMANN
 Ohrtamponzange, feines Modell, 135 mm
 Aural tampon forceps, delicate pattern, 5 inch

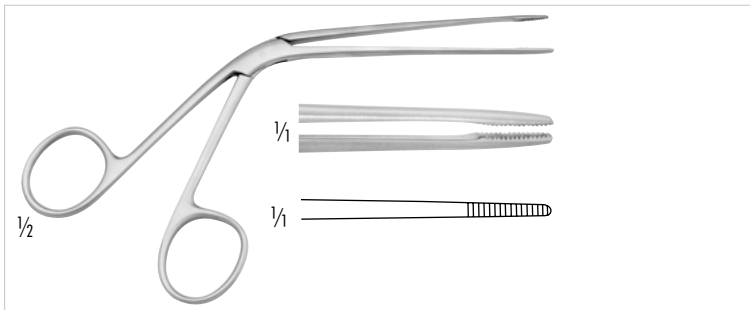

410-231-140
TILLEY
 Ohrtamponzange, extra feines Modell, 140 mm
 Aural tampon forceps, extra fine pattern, 5 1/2 inch

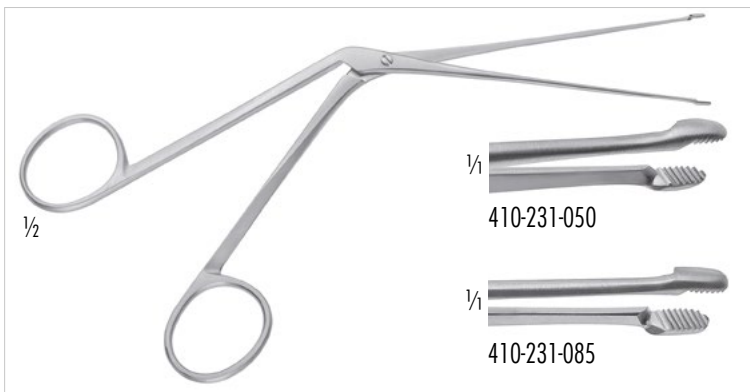

410-231-050
TOBEY
 Ohrzängchen, 4mm Maullänge, 50mm Länge von der
 Schraube bis zur Maulspitze
 Ear Forceps, 4mm long jaws, 50mm length from
 screw till jaw tip

410-231-085
CORGILL
 Ohrzängchen, 4mm Maullänge, 85mm Länge von der
 Schraube bis zur Maulspitze
 Ear Forceps, 4mm long jaws, 85mm length from screw till jaw tip



410-391-140

LUCAE

Ohrpinzette, anatomisch, bajonettförmig, 140 mm
Aural dressing forceps, bayonet shaped, 5 1/2 inch



410-375-100

TROELTSCH

Ohrpinzette, fein und klein, gerieft, 45 mm Nutzlänge
Aural dressing forceps, delicate and small, serrated,
45 mm working length

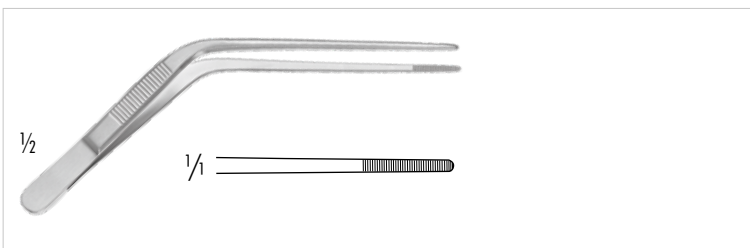

410-375-120

TROELTSCH

Ohrpinzette, anatomisch, kniegebogen, 1,8 mm breit, 115 mm
Aural dressing forceps, angled, tip 1,8 mm, serrated, 4 1/2 inch

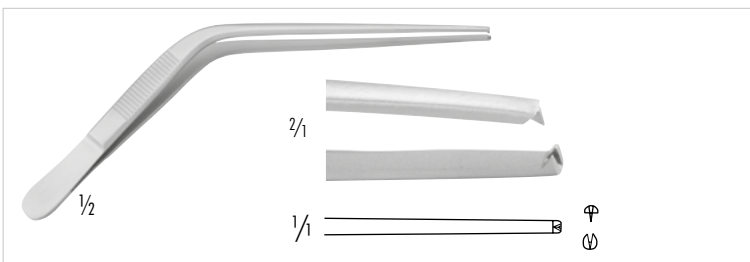

410-377-120

TROELTSCH

Ohrpinzette, chirurgisch, 1 x 2 Zähne, kniegebogen, 125 mm
Aural tissue forceps, 1 x 2 teeth, knee bent, 5 inch

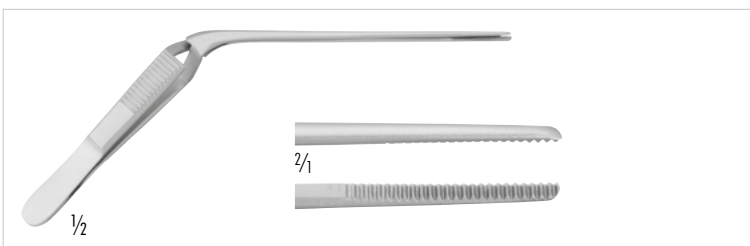

410-381-130

TROELTSCH

Ohrpinzette, anatomisch, selbst schließend, kniegebogen, 130 mm
Aural dressing forceps, knee bent, cross action, serrated, 4 1/8 inch

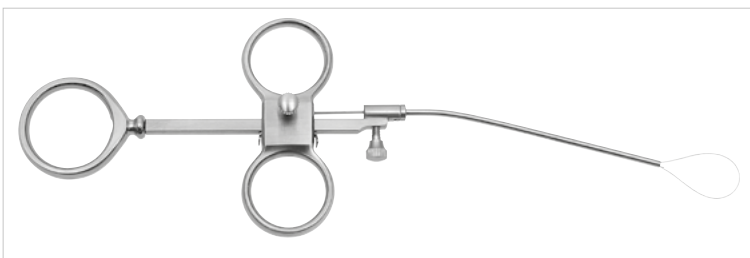

410-410-160

KRAUSE

Ohrpolypenschnürer, 165 mm
Aural snare, 6 1/2 inch

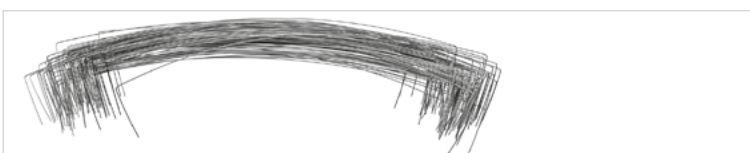

410-411-100 Ø 0,2 mm

Ohrpolypen-Schlingendraht

Bestelleinheit: PH=Packung á 100 Stück

Aural snare wire

Sales unit: PH=Package of 100 pieces



410-350-150
POLTIZER
 Ohr-Furunkelmesser, 160 mm
 Aural Sickle knife, 6 1/4 inch



410-352-170
SEXTON
 Ohr-Furunkelmesser, bajonettförmig, 170 mm
 Aural Sickle knife, bayonet-shaped, 6 3/4 inch

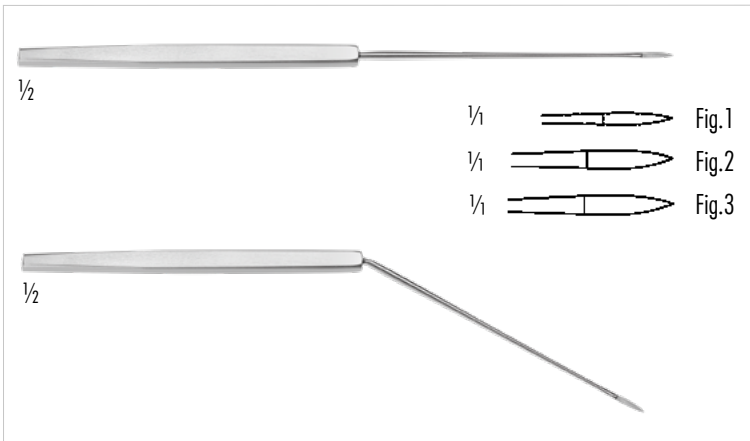

410-354-180 Fig.1 gerade/straight
410-355-180 Fig.2 gerade/straight
410-356-180 Fig.3 gerade/straight
410-357-180 Fig.1 kniegebogen/knee bent
410-358-180 Fig.2 kniegebogen/knee bent
410-359-180 Fig.3 kniegebogen/knee bent
SEXTON
 Trommelfellmesser, 180 mm
 Ear drum knife, 7 inch

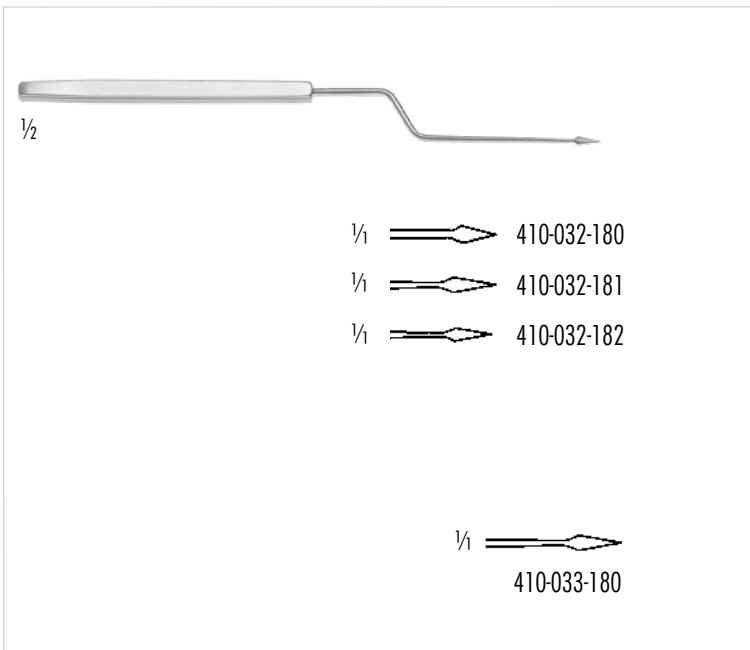

410-031-180
LUCAE
 Paracentese-Nadel, bajonettförmig, für Kinder, 160 mm
 Tympanum perforator, bayonet-shaped, for children, 6 1/4 inch

410-032-180 Spitze/tip 2.0 mm
410-032-181 Spitze/tip 1.8 mm
410-032-182 Spitze/tip 1.5 mm

LUCAE
 Paracentese-Nadel, bajonettförmig, für Erwachsene, senkrecht, 190 mm
 Tympanum perforator, bayonet-shaped, for adults, vertical, 7 1/2 inch

410-033-180
LUCAE
 Paracentese-Nadel, bajonettförmig, für Erwachsene, waagrecht, 180 mm
 Tympanum perforator, bayonet-shaped, for adults, horizontal, 7 inch



410-030-160

POLITZER

Paracentese-Nadel, gerade, 183 mm

Tympanum perforator, straight, 7 1/4 inch



410-031-140

JACOBSON

Ohrhakchen, 140mm

Ear hook, 5 1/2 inch

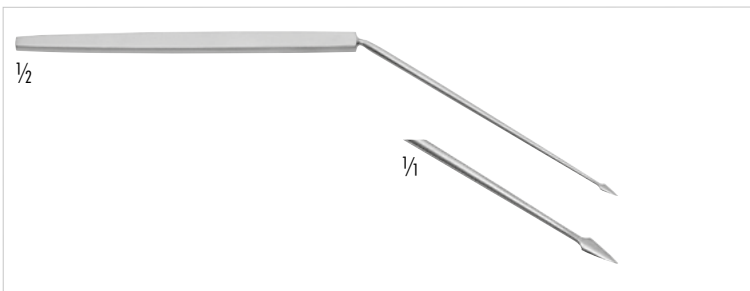

410-032-160

POLITZER

Paracentese-Nadel, kniegebogen, senkrecht, 160 mm

Tympanum perforator, knee bent, vertical, 6 1/4 inch

410-033-160

POLITZER

Paracentese-Nadel, waagrecht, kniegebogen, 160 mm

Tympanum perforator, knee bent, horizontal, 6 1/4 inch

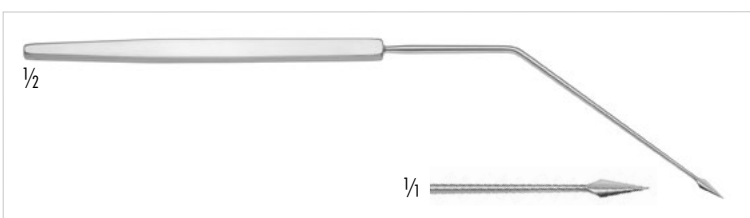

410-032-175

AGNEW (POLITZER)

Paracentesis Nadel, kniegebogen, 180 mm

Paracentesis needle, knee bent, 7 inch

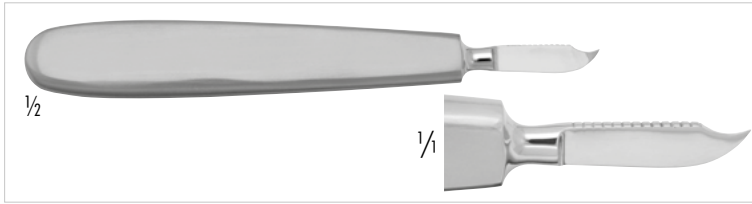

210-394-150
MUCK
Periostmesser, 150 mm
Periosteal knife, 6 inch



210-395-130
POLITZER
Mastoidmesser, 130 mm
Mastoid knife, 5 1/8 inch

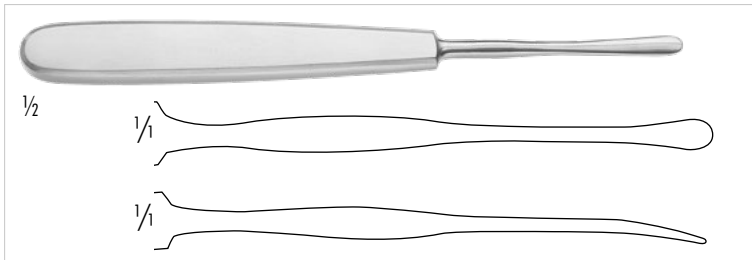

210-395-175
SEBILEAU
Elevatorium, 5 mm breit, 175 mm
Elevator, 5 mm wide, 7 inch



431-630-007	7mm	431-630-006	6mm
431-630-009	9mm	431-630-011	11mm

OBWEGESER
Raspatorium, 9 mm breit, 175 mm
Periosteal Elevator, 9 mm wide, 7 inch

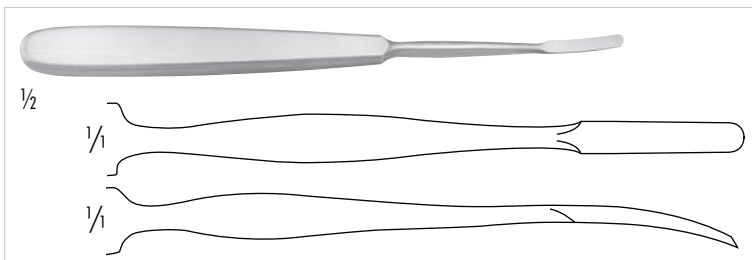

210-396-160
JOSEPH
Raspatorium, leicht gebogen, 160 mm
Periosteal Elevator, slightly curved, 6 1/4 inch

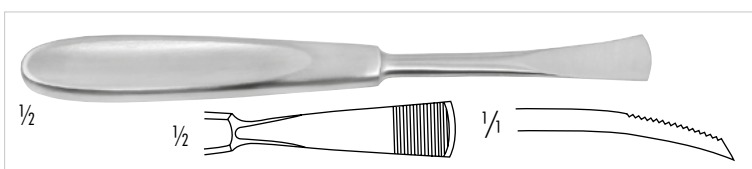

210-303-165
JANSEN
Raspatorium, gebogen, 15 mm breit, 165 mm
Periosteal Elevator, curved, 15 mm wide, 6 1/2 inch



210-397-185
LEMPERT
Raspatorium, halbscharf, 185 mm
Periosteal Elevator, semi sharp, 7 1/4 inch

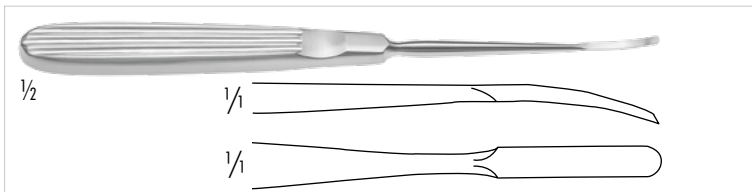

420-530-165	2mm
420-531-165	3mm
420-532-165	4mm

JOSEPH
Septum Raspatorium, leicht gebogen, 160 mm
Septum Raspatory, slightly curved, 6 1/4 inch

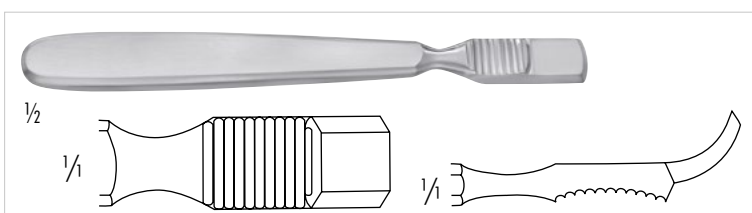

210-311-150
FARABEUF
Raspatorium, gebogen, 140 mm
Periosteal Elevator, curved cutting edge, 5 1/2 inch

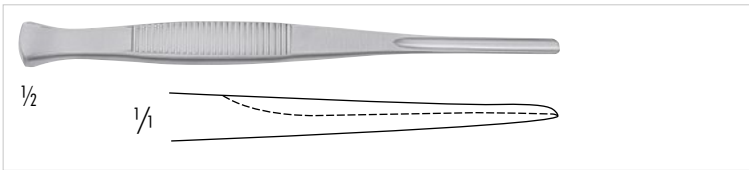

210-109-002 3 mm
210-109-005 5 mm
210-109-007 7 mm

210-109-004 4 mm
210-109-006 6 mm

PARTSCH
Hohlmeißel, gerade, 140 mm
Gouge, straight, 5 1/2 inch

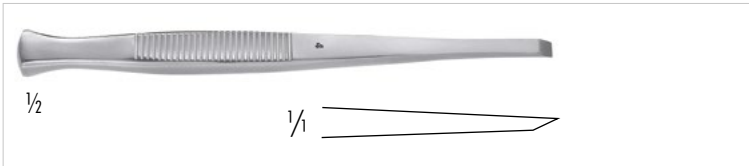

210-303-135 3 mm
210-305-135 5 mm
210-307-135 7 mm

210-304-135 4 mm
210-306-135 6 mm

PARTSCH
Flachmeißel, gerade, 140 mm
Chisel, straight, 5 1/2 inch

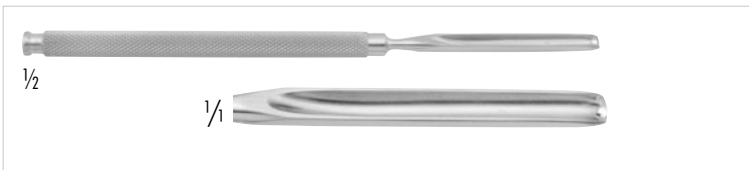

210-160-004 4 mm
210-160-006 6 mm

BRUENINGS
Hohlmeißel, 160 mm
Gouge, 6 1/4 inch



210-160-104 4 mm
210-160-106 6 mm

BRUENINGS
Flachmeißel, gerade, 160 mm
Chisel, straight, 6 1/4 inch

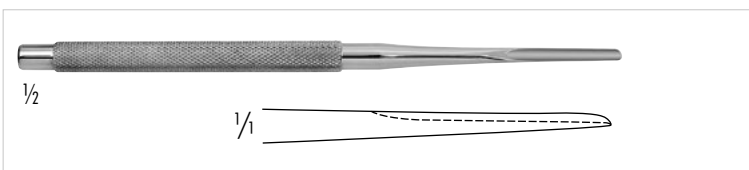

210-103-160 3 mm
210-105-160 5 mm

LUCAS
Hohlmeißel, gerade, 160 mm
Gouge, straight, 6 1/4 inch

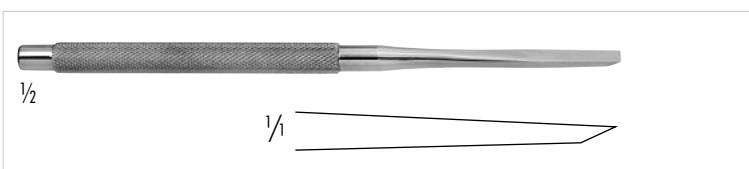

210-204-160 4 mm
210-206-160 6 mm

LUCAS
Flachmeißel, gerade, 160 mm
Chisel, straight, 6 1/4 inch

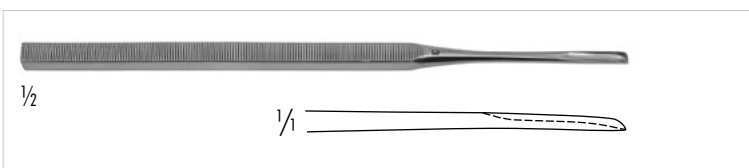

210-100-162 2 mm
210-100-163 3 mm
210-100-164 4 mm

THIES
Hohlmeißel, gerade, 160 mm
Gouge, straight, 6 1/4 inch



210-102-162 2 mm
210-102-163 3 mm
210-102-164 4 mm

THIES
Flachmeißel, gerade, 160 mm
Chisel, straight, 6 1/4 inch

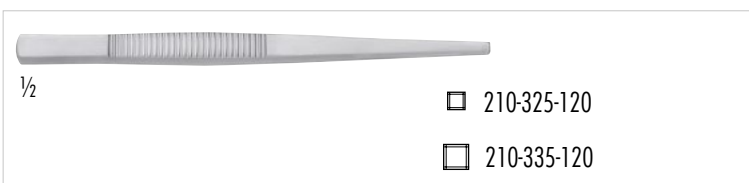

210-325-120 2,5 mm
210-335-120 3,5 mm

PASSOW
Blutstillungsmeißel, 120 mm
Hemostatic chisel, 4 3/4 inch

□ 210-325-120

□ 210-335-120



210-244-220 130 g
HAJEK
Hammer, 220 mm
Mallet, 8 3/4 inch



210-224-180 155 g
PARTSCH
Hammer, Kopf mit Bleifüllung, 190 mm
Mallet, lead filled head, 7 1/2 inch



210-240-180 235 g
COTTLE
Hammer, 1 Seite flach, 1 Seite convex, 185 mm
Mallet, 1 side plain, 1 side convex, 7 1/4 inch



210-264-140 135 g
Hammer, mit austauschbaren Kunststoffbacken, 185 mm
Mallet, head with interchangeable plastic discs, 7 1/4 inch

210-265-000
Ersatzbackenpaar für Hammer 210-264-140
Pair of interchangeable discs for mallet 210-264-140

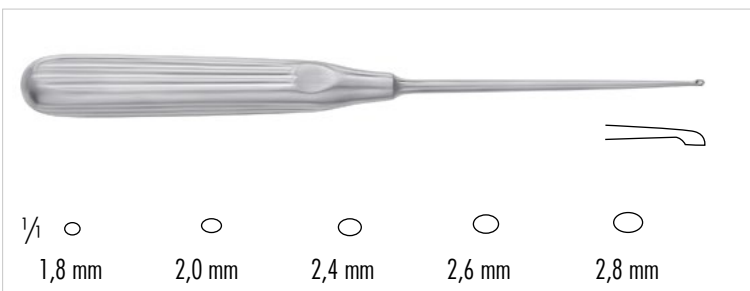

210-348-001 1,8 mm
210-348-300 2,0 mm
210-348-200 2,4 mm
210-348-000 2,6 mm
210-348-010 2,8 mm

LEMPERT
Scharfer Löffel, 200 mm
Endaural curette, 8 inch

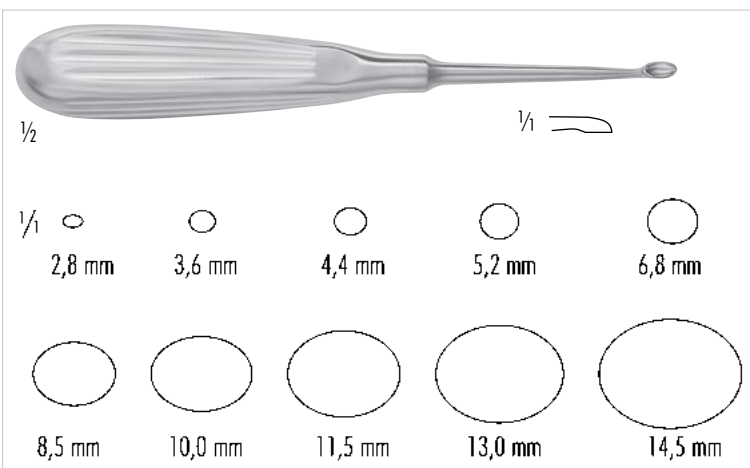

210-304-400 2,8 mm
210-304-300 3,6 mm
210-304-200 4,4 mm
210-304-100 5,2 mm
210-304-010 6,8 mm
210-304-020 8,5 mm
210-304-030 10,0 mm
210-304-040 11,5 mm
210-304-050 13,0 mm
210-304-060 14,5 mm

VOLKMANN
Scharfer Löffel, 170 mm
Endaural curette, 6 3/4 inch

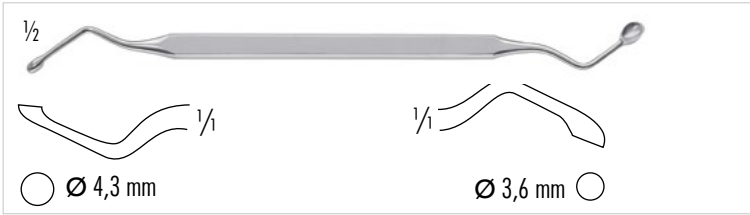

210-216-150
JANSEN
Scharfer Doppellöffel, runde Löffel, 160 mm
Aural curette, sharp, double-ended, round cups, 6 ¼ inch

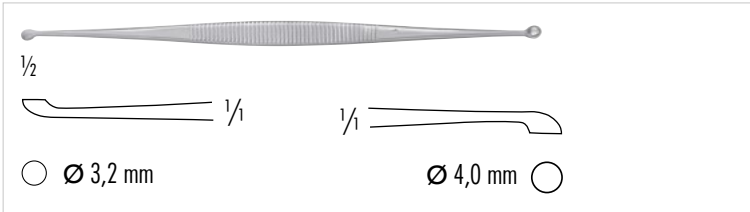

210-218-012
MARTINI
Scharfer Doppellöffel, runde Löffel, 140 mm
Aural curette, sharp, double-ended, round cups, 5 ½ inch

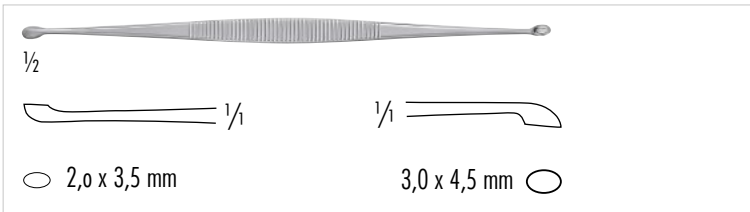

210-216-001
WILLIGER
Scharfer Doppellöffel, ovale Löffel, 145 mm
Aural curette, sharp, double-ended, oval cups, 5 ¾ inch

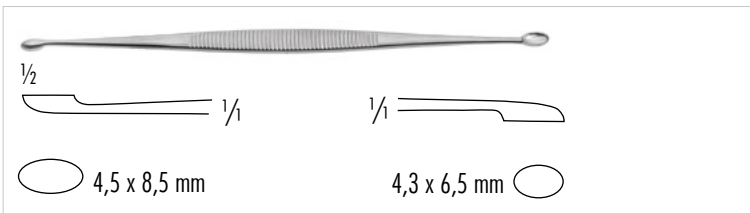

210-213-140
JACOBSON
Scharfer Doppellöffel, ovale Löffel, 140 mm
Aural curette, sharp, double-ended, oval cups, 5 ½ inch

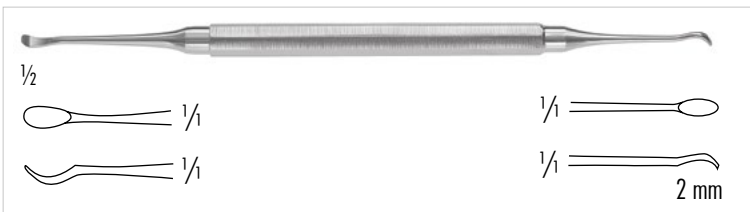

410-216-180
MILLER
Doppel-Kürette, 180 mm
Aural curette, double-ended, 7 inch

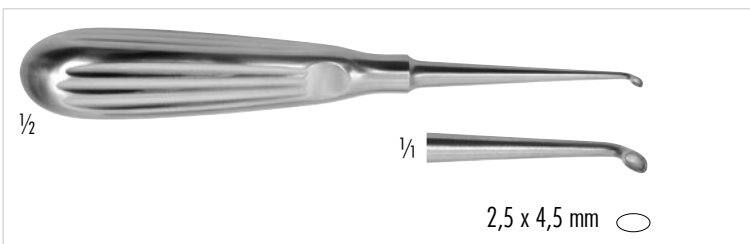

210-305-400 Fig. 0000
VOLKMANN
Mikro Ohrlöffel, abgewinkelt, ovaler Löffel
Micro aural curette, angled, oval cup

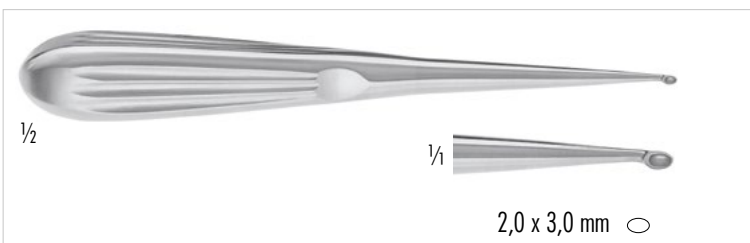

210-304-500 Fig. 00000
VOLKMANN
Mikro Ohrlöffel, gerade, ovaler Löffel
Micro aural curette, straight, ovaler cup

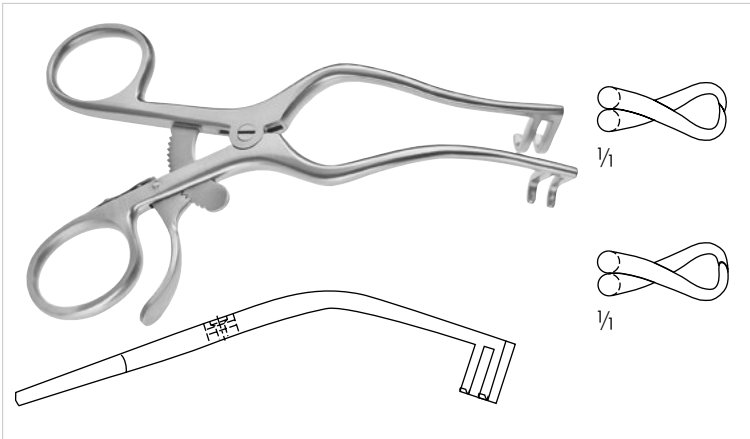

170-763-130
PLESTER
 Wundspreizer, 2 x 2 Zähne, scharf, 130 mm
 Retractor, self-retaining, 2 x 2 prongs, sharp, 5 1/8 inch

170-762-130
PLESTER
 Wundspreizer, 2 x 2 Zähne, stumpf, 130 mm
 Retractor, self-retaining, 2 x 2 prongs, blunt, 5 1/8 inch



170-760-110
PLESTER
 Wundspreizer, stumpf, volles Blatt rechts, 2 Zähne links, 110 mm
 Retractor, self-retaining, blunt, solid blade on right, 2 teeth left, 4 3/8 inch

170-761-110
PLESTER
 Wundspreizer, stumpf, volles Blatt links, 2 Zähne rechts, 110 mm
 Retractor, self-retaining, blunt, solid blade on left, 2 teeth right, 4 3/8 inch



170-754-110 volles Blatt links mit scharfen Zähnen,
 2 Zähne rechts
 full blade left side with sharp teeth,
 2 prongs right

170-755-110 volles Blatt rechts mit scharfen Zähnen,
 2 Zähne links
 full blade right side with sharp teeth,
 2 prongs left

PERKINS
 Wundsperrerr, 110mm
 Retractor, 4 1/3 inch



170-765-110 volles Blatt rechts mit scharfen Zähnen,
 3 Zähne links
 full blade right side with sharp teeth,
 3 prongs left

PERKINS
 Wundsperrerr, 110mm / Retractor, 4 1/3 inch



170-757-110 gerieftes Blatt links, 2 Zähne rechts
 left serrated blade, 2 prongs right

170-758-110 gerieftes Blatt rechts, 2 Zähne links
 right serrated blade, 2 prongs left

WIEGAND
 Wundsperrerr, 110mm
 Retractor, 4 1/3 inch

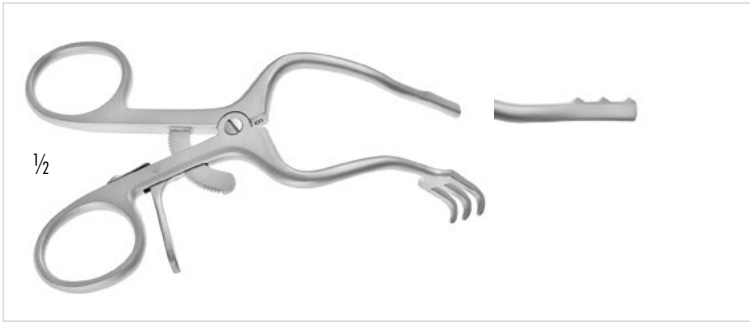

- 170-735-110 linkes Blatt scharf, 3 Zähne rechts, 110mm
left blade sharp, 3 teeth right, 4^{1/3} inch
- 170-735-130 linkes Blatt scharf, 3 Zähne rechts, 130mm
left blade sharp, 3 teeth right, 5^{1/8} inch
- 170-736-110 rechtes Blatt scharf, 3 Zähne links, 110mm
right blade sharp, 3 teeth left, 4^{1/3} inch
- 170-736-130 rechtes Blatt scharf, 3 Zähne links, 130mm
right blade sharp, 3 teeth left, 5^{1/8} inch

WIEGAND
Wundsperrrer
Retractor

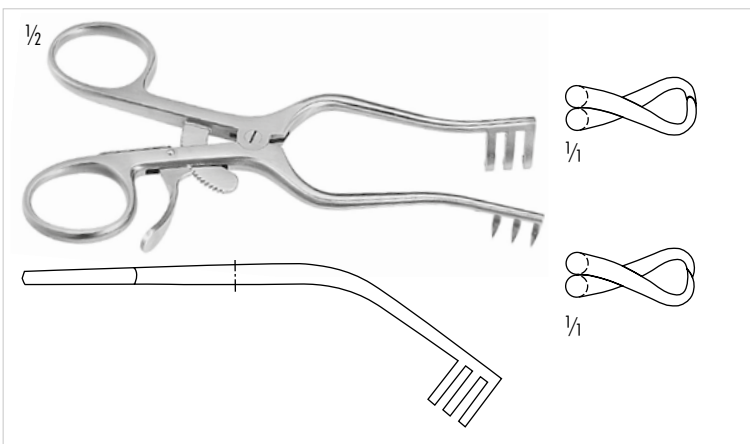

- 170-752-130
WULLSTEIN
Wundspreizer, 3 x 3 Zähne, scharf, 130 mm
Retractor, self-retaining, 3 x 3 prongs, sharp, 5 1/8 inch

- 170-753-130
WULLSTEIN
Wundspreizer, 3 x 3 Zähne, stumpf, 130 mm
Retractor, self-retaining, 3 x 3 prongs, blunt, 5 1/8 inch

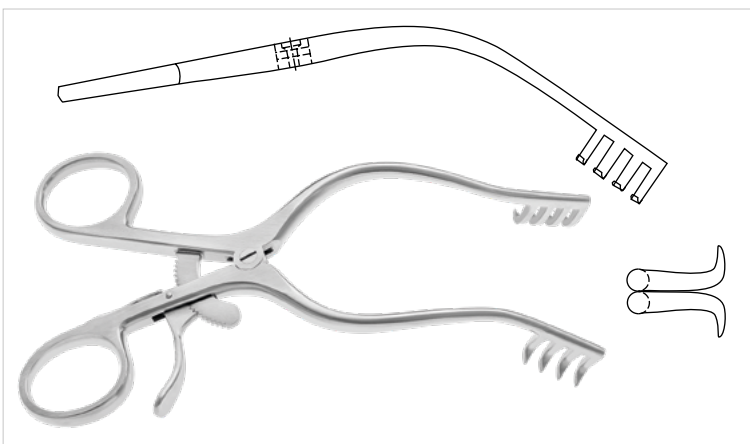

- 170-754-155
MOLLISON
Wundspreizer, 4 x 4 Zähne, scharf, 155 mm
Retractor, self-retaining, 4 x 4 prongs, sharp, 6 inch



- 170-780-170
RZ
Gelenkwundsperrrer 3 x 3 Zähne, 170 mm
Retractor, self-retaining, articulating joints, 3 x 3 prongs, 6 1/2 inch



170-780-165 linkes Blatt voll, rechts 3 Zähne
left blade full, right side 3 prongs
170-781-165 rechtes Blatt voll, links 3 Zähne
right blade full, left side 3 prongs

RZ
Wundsperrerr mit Gelenk, 165mm
Retractor with hinge, 6^{1/2}inch

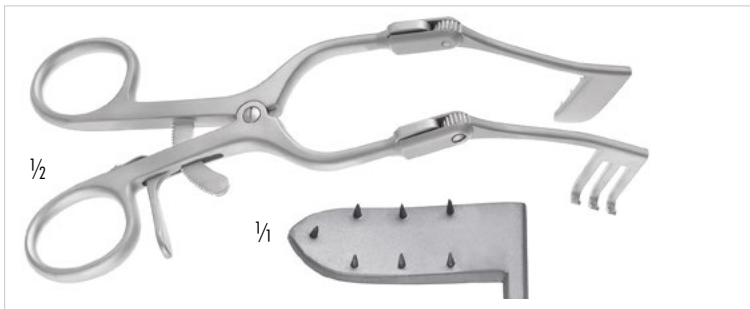

170-783-165 links volles Blatt, rechts 3 Zähne
left side full blade, right 3 prongs
170-784-165 rechtes volles Blatt, links 3 Zähne
right side full blade, left 3 prongs

HOUSE
Wundsperrerr mit Gelenk, 165mm
Retractor with hinge, 6^{1/2}inch

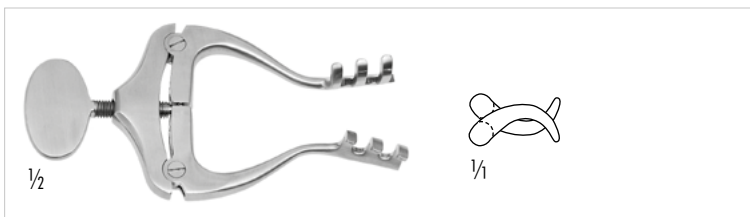

170-723-100
JANSEN
Wundsperrerr, stumpf, 3 x 3 Zähne, 100 mm
Mastoid retractor, blunt, 3 x 3 prongs, 4 inch

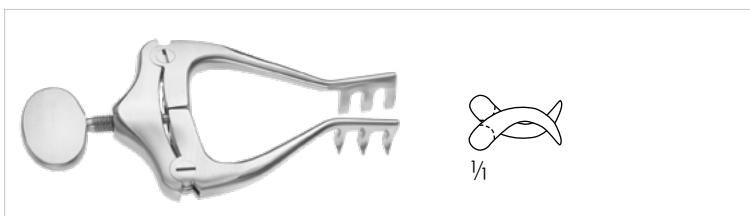

170-720-100
JANSEN
Wundsperrerr, scharf, 3 x 3 Zähne, 100 mm
Mastoid retractor, sharp 3 x 3 prongs, 4 inch

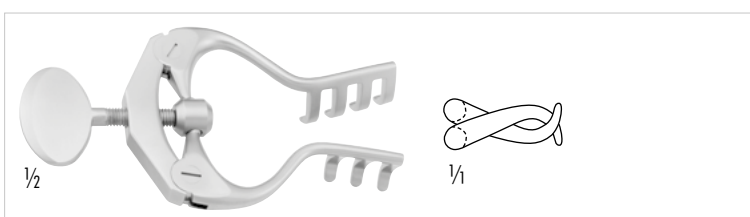

170-723-105
JANSEN
Wundsperrerr, stumpf, 3 x 4 Zähne, 100 mm
Mastoid retractor, blunt 3 x 4 prongs, 4 inch

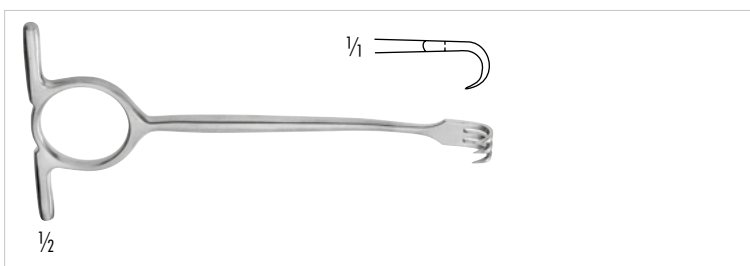

170-234-120 gerade / straight
170-235-120 links gebogen / left curved
WILLIGER
Wundhaken, scharf, 120 mm
Wound retractor, sharp, 4 3/4 inch

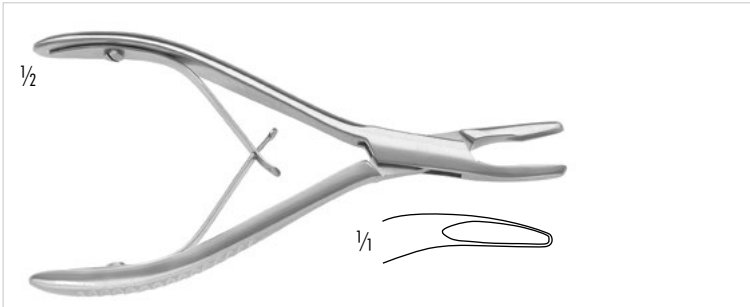

210-640-140
LUER-FRIEDMANN
 Hohlmeisselzange, leicht gebogen, 145 mm
 Bone Rongeur, slightly curved, 5 3/4 inch

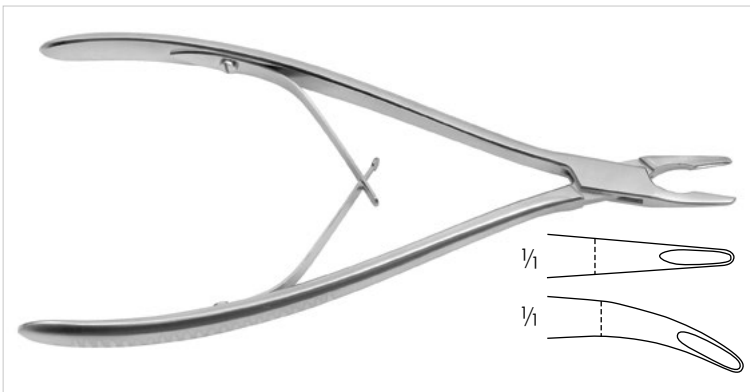

210-832-185
LEMPERT
 Hohlmeisselzange, gerade, 200 mm
 Bone Rongeur, straight, 8 inch

210-833-185
LEMPERT
 Hohlmeisselzange, gebogen, 200 mm
 Bone Rongeur, curved, 8 inch

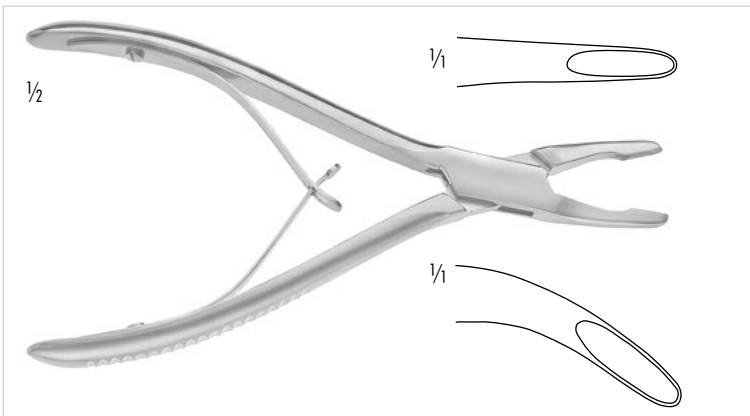

210-826-180
JANSEN
 Hohlmeisselzange, gerade, 175 mm
 Bone Rongeur, straight, 7 inch

210-829-180
JANSEN
 Hohlmeisselzange, gebogen, 175 mm
 Bone Rongeur, curved, 7 inch

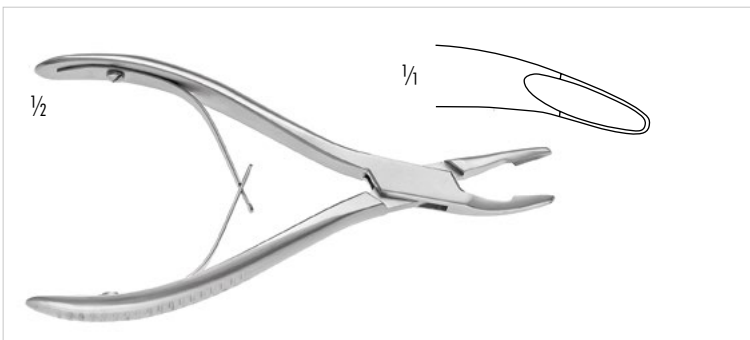

210-815-165
MEAD (BANE)
 Hohlmeisselzange, gebogen, 165 mm
 Bone Rongeur, curved, 6 1/2 inch

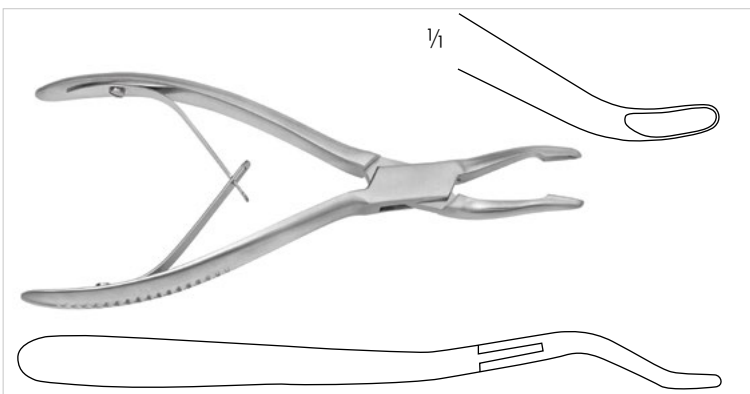

210-829-170
JANSEN
 Hohlmeisselzange, s-förmig gebogen, 190 mm
 Bone Rongeur, s-shaped, 7 1/2 inch

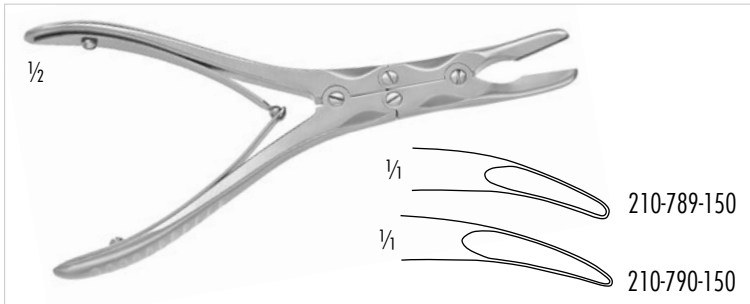

210-789-150

BOEHLERHohlmeisselzange, gebogen, übersetzt, 3 mm Maul, 155 mm
Bone Rongeur, curved, double action, 3 mm jaw, 6 inch

210-790-150

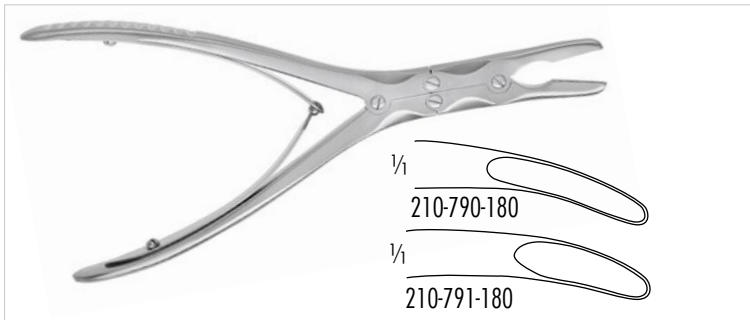
BOEHLERHohlmeisselzange, gebogen, übersetzt, 2mm Maul, 155 mm
Bone Rongeur, curved, double action, 2mm jaw, 6 inch

210-790-180

BEYERHohlmeisselzange, gebogen, übersetzt, 180 mm
Bone Rongeur, curved, double action, 7 inch

210-791-180

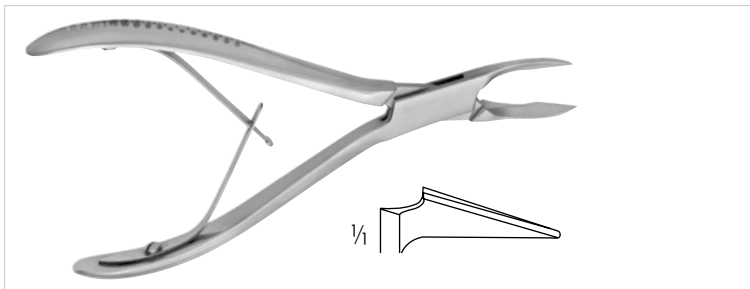
ZAUFAL-JANSENHohlmeisselzange, gebogen, übersetzt, 180 mm
Bone Rongeur, curved, double action, 7 inch

210-846-150

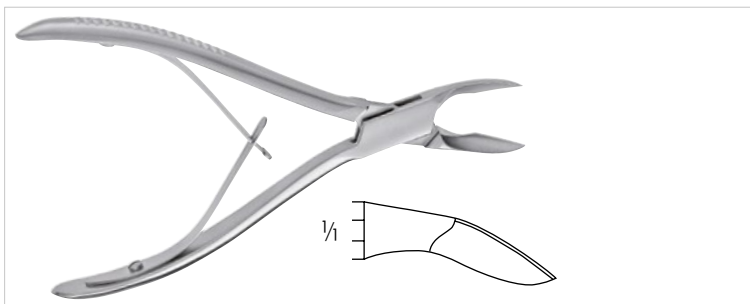
STAMMKnochensplitterzange, 150 mm
Bone cutting forceps, 6 inch

210-845-170

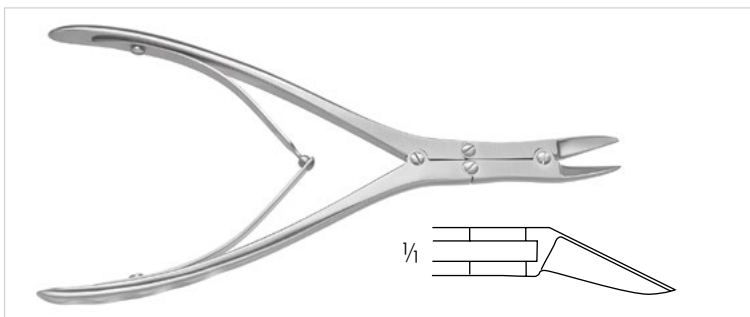
Knochenschneidezange, aufgebogen, 170 mm
Bone cutting forceps, curved on flat, 6 3/4 inch

210-880-175

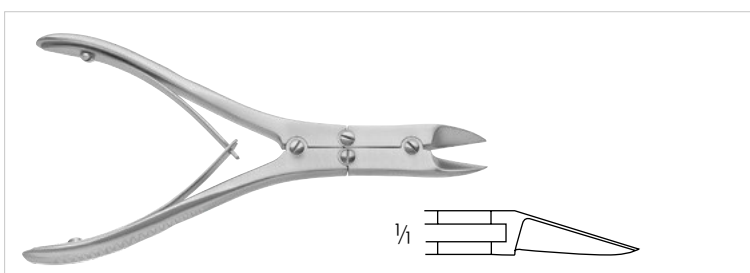
MC INDOEKnochensplitterzange, abgewinkelt, übersetzt, 175 mm
Bone cutting forceps, angled on flat, double action, 7 inch

210-890-150

BOEHLERKnochenschneidezange, abgewinkelt, übersetzt, 145 mm
Bone cutting forceps, angled on flat, double action, 5 3/4 inch

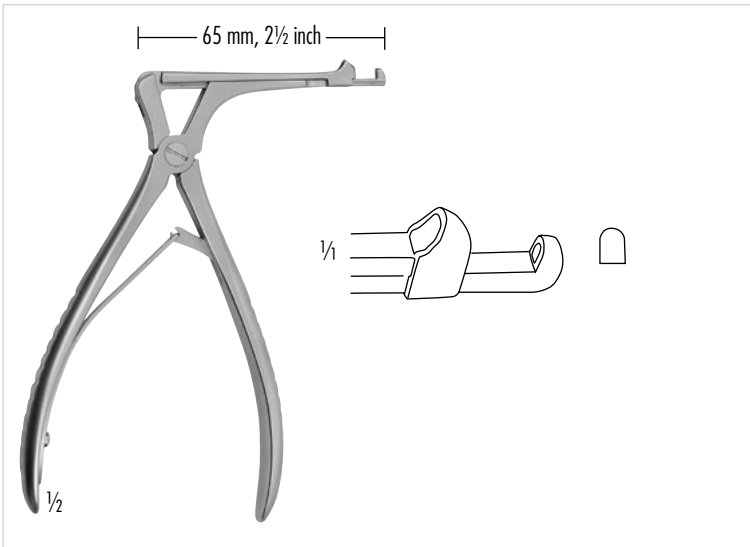

410-241-035
CITELLI
 Knochenstanze, durchschneidend, 2,0 mm
 Bone Punch, through cutting, 2.0 mm

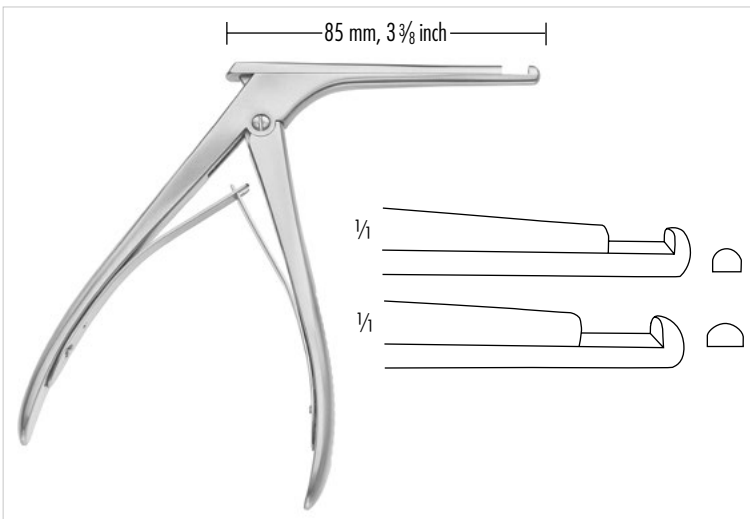
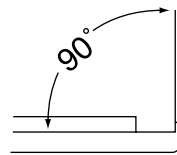

410-245-001 4 mm
 410-245-002 5 mm
KERRISON
 Knochenstanze
 Bone Punch

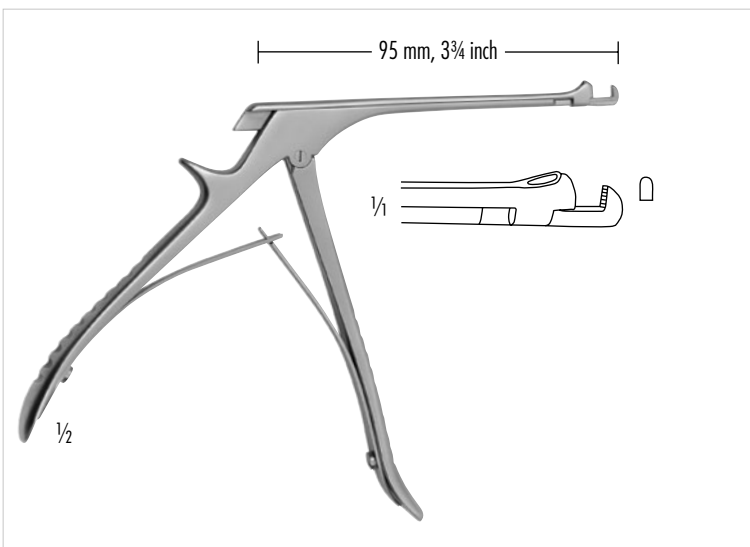
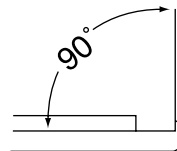

410-242-018 1,8 mm
CITELLI-BEYER
 Knochenstanze
 Bone Punch

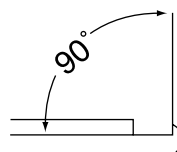

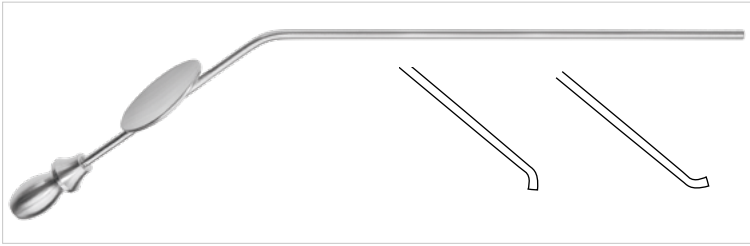
**VERHOEVEN**

410-134-320 Saugrohr , 2,0 mm , gerade
Suction tube, 2.0 mm , straight

410-134-120 dito, nach oben
same, curved up

410-134-220 dito, nach unten
same, curved down

410-134-316 Saugrohr, 1,5 mm, gerade
Suction tube, 1.5 mm, straight

410-134-116 dito, nach oben
same, curved up

410-134-216 dito, nach unten
same, curved down

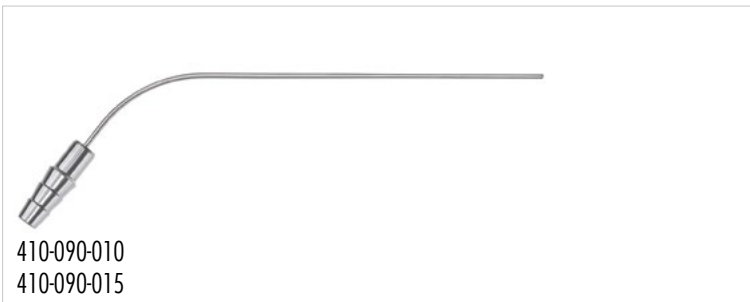

410-090-010
410-090-015

410-090-010 Saugrohr, kniegebogen, zylindr., Luer, 1,0 mm
Suction tube, knee bent, cylindr., Luer, 1.0 mm

410-090-015 dito, 1,5 mm
same, 1.5 mm

410-090-020 dito, 2,0 mm
same, 2.0 mm

410-090-030 dito, 3,0 mm
same, 3.0 mm

410-090-040 dito, 4,0 mm
same, 4.0 mm

410-090-050 dito, 5,0 mm
same, 5.0 mm



410-150-015 - 410-150-020

50mm, 2 inch

BARNES

410-150-015 Saugrohr, Luer, 1,5 mm
Suction tube, Luer, 1.5 mm

410-150-017 dito, 1,7 mm
same, 1.7 mm

410-150-020 dito, 2,0 mm
same, 2.0 mm

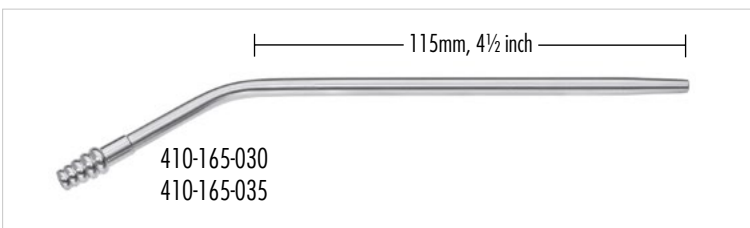

410-165-030
410-165-035

115mm, 4½ inch

410-165-030 Saugrohr, konisch, 165 mm, Luer, 3,0 mm
Suction tube, conical, 165 mm, Luer, 3.0mm

410-165-035 dito, 3,5 mm
same, 3.5 mm

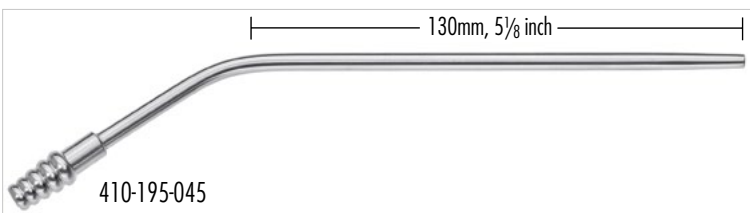

410-195-045

130mm, 5⅞ inch

410-195-045 Saugrohr, 195 mm lang, 4,5 mm,
Suction tube, 195 mm long, 4.5 mm,

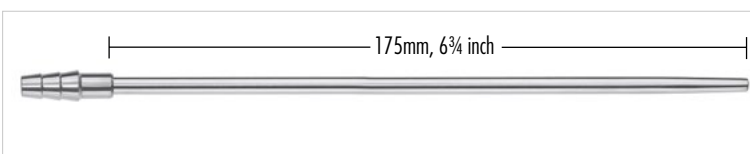

175mm, 6¾ inch

410-225-003 Saugrohr, biegsam, 225 mm, Ø 3mm, Luer
Suction tube, malleable, 225 mm, Ø 3mm, Luer

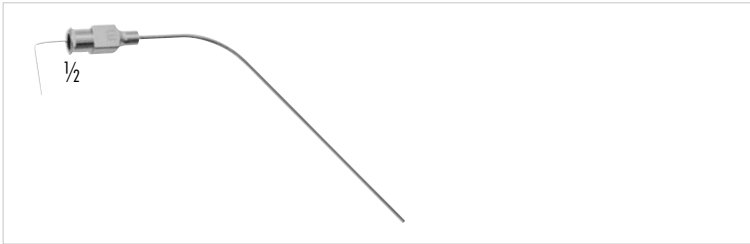

- 410-134-016 Ø 16 swg., Ø 1,6 mm
- 410-134-012 Ø 18 swg., Ø 1,2 mm
- 410-134-009 Ø 20 swg., Ø 0,9 mm
- 410-134-007 Ø 22 swg., Ø 0,7 mm
- 410-134-006 Ø 24 swg., Ø 0,6 mm

VERHOEVEN-ROSEN

Saugkanüle, mit LUER-Lock, 100 mm
Suction cannula, with LUER-Lock, 4 inch

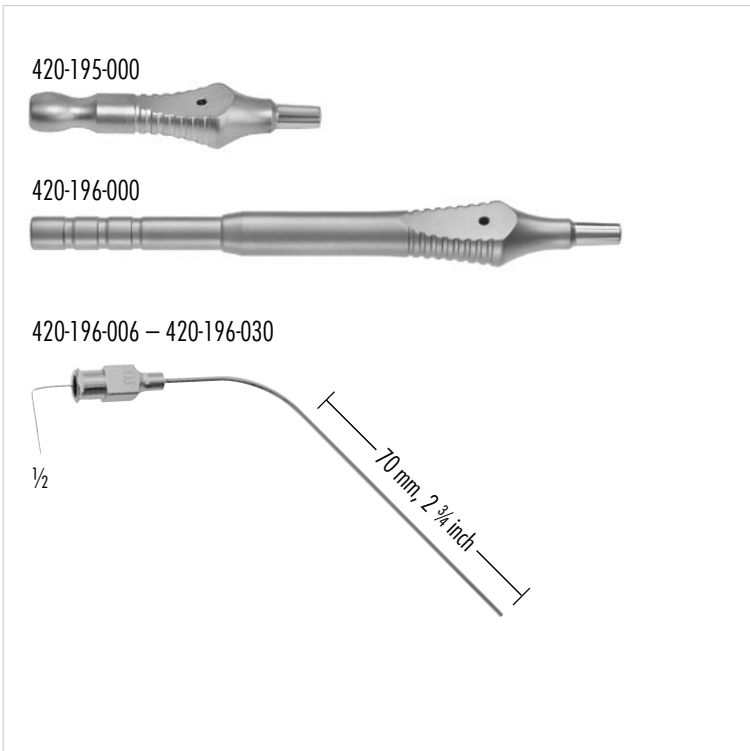

420-195-000

HOUSE

Saugadapter, 51 mm, Saugunterbrecher Durchmesser Olive: 7 mm
Suction adapter, 2 1/8", finger cut-off, Diameter olive: 7 mm

420-196-000 Saughandgriff mit LUER-Konus, mit Unterbrecher
Suction handle, with finger cut-off, with LUER cone

HOUSE

Saugkanülen mit Luer-lock, 2 Stück
Suction cannulas with Luer-lock, 2 pieces per package

- 420-196-006 Ø 0.6 mm
- 420-196-008 Ø 0.8 mm
- 420-196-010 Ø 1.0 mm
- 420-196-012 Ø 1.2 mm
- 420-196-015 Ø 1.5 mm
- 420-196-018 Ø 1.8 mm
- 420-196-020 Ø 2.0 mm
- 420-196-022 Ø 2.2 mm
- 420-196-025 Ø 2.5 mm
- 420-196-030 Ø 3.0 mm



410-267-100

ZOELLNER

Saugkanüle, allein
Suction cannula, only

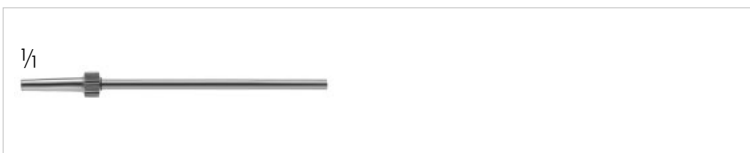

- 410-267-012 Ø 18 swg., Ø 1,2 mm
- 410-267-009 Ø 20 swg., Ø 0,9 mm
- 410-267-007 Ø 22 swg., Ø 0,7 mm
- 410-267-006 Ø 24 swg., Ø 0,6 mm
- 410-267-004 Ø 26 swg., Ø 0,4 mm

ZOELLNER

Auswechselbare Spitzen, Bestelleinheit: PZ = Packung á 10 Stück
Detachable suction tips, Sales unit: PZ = Package of 10 pieces



410-135-000

WULLSTEIN

Saughandgriff, mit Fingerunterbrecher, 140 mm
Suction handle, with finger-cut-off, 5 1/2 inch

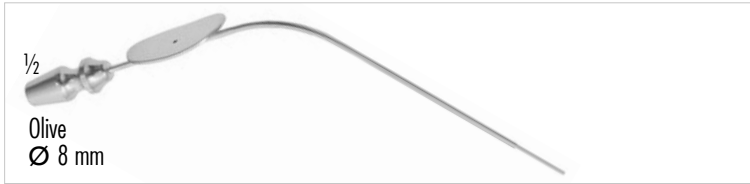

165-536-010 18 Gauge 165-536-009 20 Gauge
165-536-007 22 Gauge 165-536-006 24 Gauge

SCHUKNECHT

Saugkanüle, 130 mm
Suction cannula, 5 1/8 inch

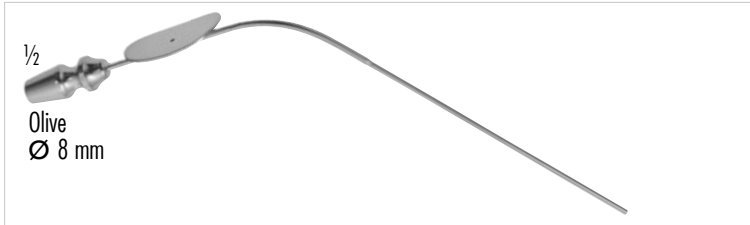

	75 mm/3 inch	100 mm/4 inch
3Charr./1,0 mm	165-538-003	165-539-003
5Charr./1,8 mm	165-538-005	165-539-005
7Charr./2,3 mm	165-538-007	165-539-007

BARRON

Saugkanüle mit Saugunterbrecher und Mandrin
Suction cannula with finger cut-off and stylet



Ø	130 mm/5 inch	180 mm/7 inch
1,5 mm	165-625-005	165-525-005
2,0 mm	165-625-006	165-525-006
2,5 mm	165-625-008	165-525-008
3,0 mm	165-625-010	165-525-010
4,0 mm	165-625-012	165-525-012
5,0 mm	165-625-015	165-525-015

FERGUSSON

Saugkanüle mit Saugunterbrecher und Mandrin,
Griffplatte mit LUER-Bohrung
Suction cannula with finger cut-off and stylet,
thumb piece with LUER hub

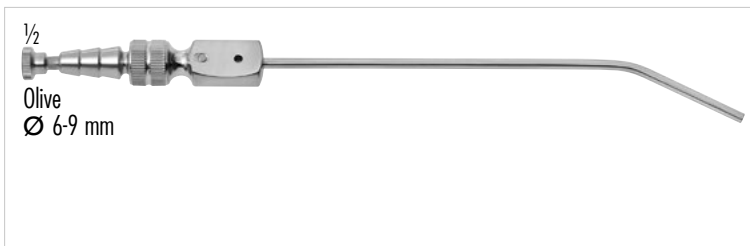

165-725-008	Ø 2,5 mm
165-725-010	Ø 3,0 mm
165-725-012	Ø 4,0 mm
165-725-015	Ø 5,0 mm

PLESTER

Saugkanüle mit Saugunterbrecher und Mandrin, Griffplatte parallel
zur Biegung, LUER-Bohrung, 195 mm
Suction cannula with finger cut-off and stylet, thumb piece parallel
to curve, with LUER hub, 7 3/4 inch

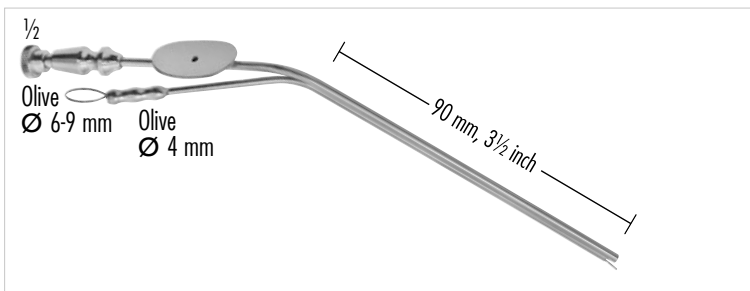

252-140-003	Saugrohr Ø 0,9 mm, Spühlrohr Ø 0,7 mm suction tube Ø 0.9 mm, irrigation tube Ø 0.7 mm
252-140-004	Saugrohr Ø 1,2 mm, Spühlrohr Ø 0,9 mm suction tube Ø 1.2 mm, irrigation tube Ø 0.9 mm
252-140-005	Saugrohr Ø 1,5 mm, Spühlrohr Ø 1,2 mm suction tube Ø 1.5 mm, irrigation tube Ø 1.2 mm

HOUSE

Saugkanüle mit Saugunterbrecher und Mandrin, LUER-Bohrung
Suction cannula with finger cut-off and stylet, with LUER hub



410-135-160	Ø 1,5 mm
410-132-160	Ø 2,0 mm

WULLSTEIN

Saugrohr, zylindrisch, aus Silber, mit Mandrin, Olive mit LUER Bohrung
Suction tube, cylindrical, silver plated, with stylet, olive with LUER hub
160 mm, 6 1/4 inch



410-133-160

WULLSTEIN

Saugrohr, konisch, aus Silber, Olive mit LUER-Bohrung, 160 mm
Suction tube, conical, silver plated, olive with LUER hub, 6 1/4 inch



110-110-003
Skalpell Griff Nr. 3, 130 mm
Scalpel Handle No. 3, 5 1/8 inch



110-114-003
Skalpell Griff Nr. 3, graduiert, 130 mm
Scalpel Handle No. 3, graduated, 5 1/8 inch



110-130-077
Skalpell Griff Nr. 7, 165 mm
Scalpel Handle No. 7, 6 1/2 inch

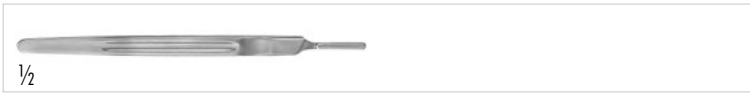

110-130-007
Skalpell Griff Nr. 7K, 130 mm
Scalpel Handle No. 7K, 5 inch

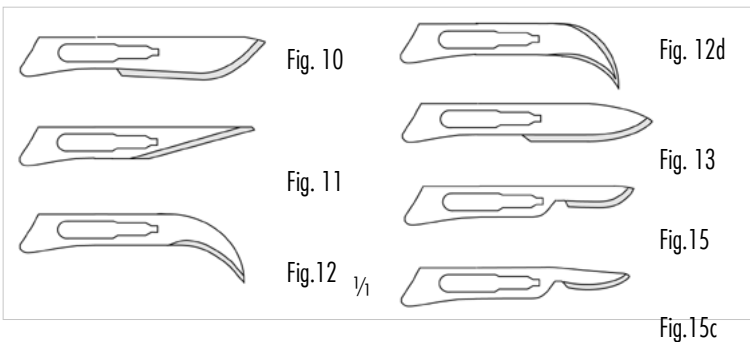

110-201-010 Fig.10
110-201-011 Fig.11
110-201-012 Fig.12
110-201-112 Fig.12d
110-201-013 Fig.13
110-201-015 Fig.15
110-201-115 Fig.15c
Skalpellklingen Fig. 15, steril, PA à 100 Stück
Scalpel blades Fig. 15, sterile, PA = 100 pieces

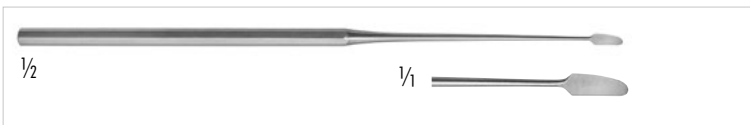

410-329-160
WULLSTEIN
Raspatorium, gebogen, 160 mm
Raspatory, rounded blade, curved, 6 1/4 inch



410-328-165
BEALES
Raspatorium, 165 mm
Raspatory, 6 1/2 inch

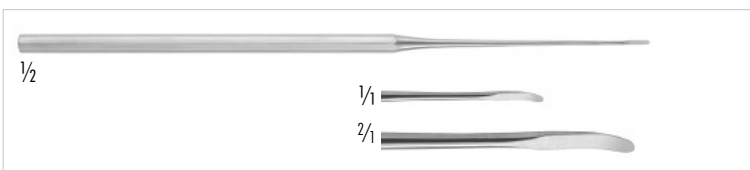

410-327-165
BEALES
Raspatorium, spatelförmiges Blatt, klein, 165 mm
Raspatory, spatula end, small, 6 1/2 inch



410-330-160
LEMPERT
Raspatorium, schmal, gerade, 160 mm
Raspatory, narrow, straight, 6 1/4 inch

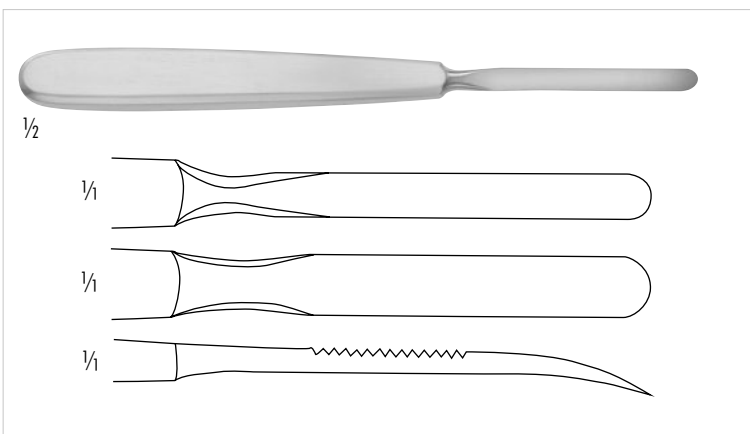

210-439-006 6 mm
210-439-008 8 mm
Raspatorium, leicht gebogen, 165 mm
Raspatory, slightly curved, 6 1/2 inch



120-047-120

WAGNER

Zahnfleischschere, gebogen, stumpf, 120 mm
Gum scissors, curved, blunt, 4 3/4 inch



120-057-140

SANVENERO

Chirurgische Schere, gebogen, spitz, 140 mm
Operating scissors, curved, sharp, 5 1/2 inch



120-071-105

Irisschere, gebogen, 105 mm
Iris scissors, curved, 4 1/4 inch

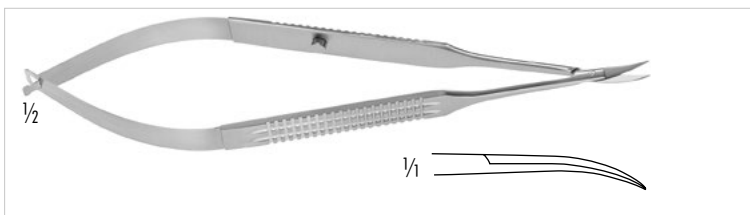

250-064-021

MILLESI

Mikro Federschere, gebogen, Schneiden gezahnt, 160 mm
Micro Scissors (Spring Type), toothed blades, curved, 6 1/4 inch



250-064-079

Mikro Nadelhalter, gebogen, mit breitem Griff, 160 mm
Micro Needle Holder, curved, with wide handle, 6 1/4 inch

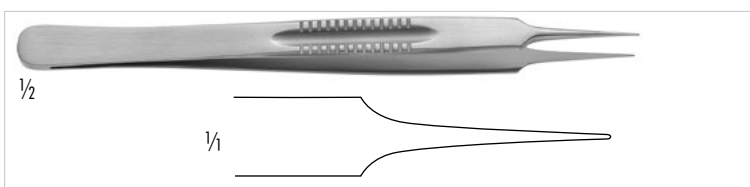

250-024-260

Mikro Lazar Pinzette, 0,5 mm Spitzen, 155 mm
Micro Lazar Forceps, 0.5 mm tips, 6 inch

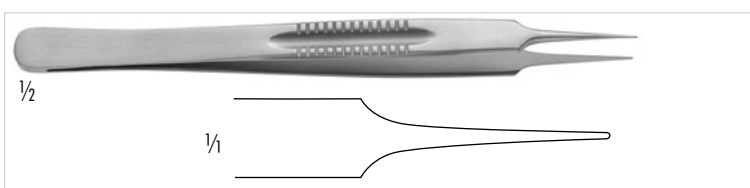

250-024-261

Mikro Lazar Pinzette, 0,8 mm Spitzen, 155 mm
Micro Lazar Forceps, 0.8 mm tips, 6 inch



251-613-110

Gefäßdilator, gerade, Flachgriff, 9 mm breit, 110 mm
Vessel dilator, straight, flat handle, 9 mm wide, 4 3/8 inch



130-145-125 125 mm / 5 inch
130-145-150 150 mm / 6 inch

SEMKEN
Chirurgische Pinzette, 1 x 2 Zähne,
Tissue forceps, 1 x 2 teeth, 5 inch



130-144-150
SEMKEN
Anatomische Pinzette, 150 mm
Dressing forceps, 6 inch



410-383-120
DERLACKI
Chirurgische Gehörknöchelchen-Pinzette mit Schließschraube,
Mehrfachzahnung, 120 mm
Aural tissue forceps with locking screw, for small aural bones,
multiple teeth, 4 3/4 inch



130-550-120
Mikro- Adson Pinzette, 1 x 2 Zähne, 120 mm
Micro- Adson Forceps, 1 x 2 teeth, 4 3/4 inch



130-548-120
Mikro- Adson Pinzette, gerieft, 120 mm
Micro- Adson dressing forceps, serrated, 4 3/4 inch



130-503-100
GRAEFE
Feine chirurgische Pinzette, 1x2 Zähne, gerade, 100 mm
Delicate tissue forceps, 1x2 teeth, straight, 4 inch



130-504-100
GRAEFE
Feine chirurgische Pinzette, 1x2 Zähne, gebogen, 100 mm
Delicate tissue forceps, 1x2 teeth, curved, 4 inch



130-500-100
GRAEFE
Feine anatomische Pinzette, gerade, 100 mm
Delicate dressing forceps, straight, 4 inch



130-501-100
GRAEFE
Feine anatomische Pinzette, gebogen, 100 mm
Delicate dressing forceps, curved, 4 inch

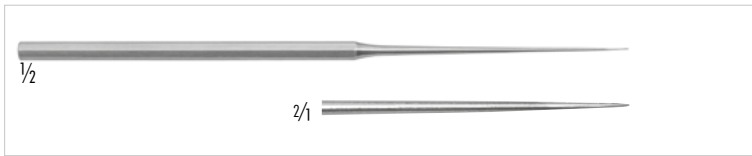

410-110-155 spitz/pointed
 410-110-160 stumpf/blunt
BARBARA
 Mikro- Nadel (Perforator), gerade, 160 mm
 Micro Needle (perforator), straight, sharp point, 6 1/4 inch

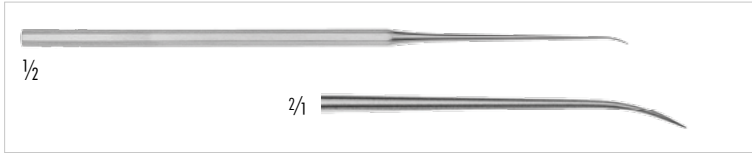

410-111-155
WULLSTEIN
 Mikro- Nadel (Perforator), leicht gebogen, 160 mm
 Micro Needle (perforator), slightly curved, sharp point, 6 1/4 inch

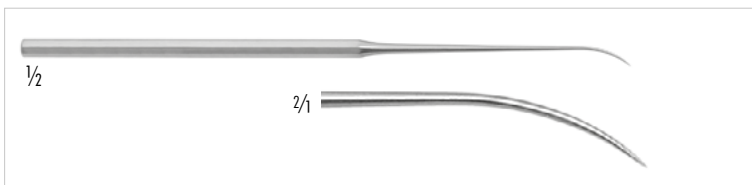

410-112-155
BARBARA
 Mikro-Nadel (Perforator), leicht, lange Biegung, 160 mm
 Micro Needle (perforator), slightly, long curvature, 6 1/4 inch

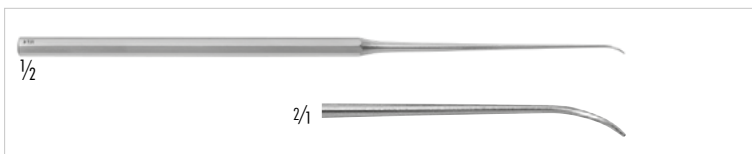

410-114-155
BARBARA
 Mikro-Nadel (Perforator), stark gebogen, 160 mm
 Micro Needle (perforator), acute curved, sharp point, 6 1/4 inch

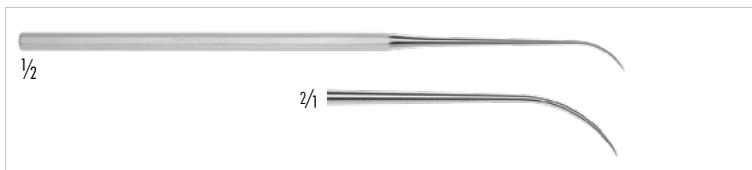

410-116-155
ROSEN
 Mikro-Häkchen, stark lang gebogen, 160 mm
 Micro Hook, acute long curvature, 6 1/4 inch

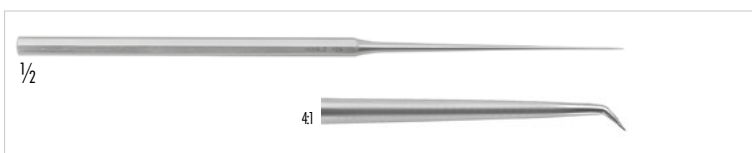

410-115-003 0,3 mm
 410-115-006 0,6 mm
 410-115-010 1,0 mm
SHAMBOUGH
 Mikro-Häkchen, 25° abgewinkelt, 160 mm
 Micro Hook, 25° angled, 6 1/4 inch

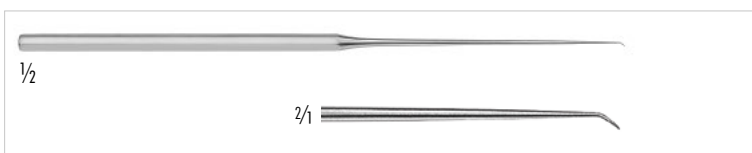

410-117-002 0,2 mm 410-117-003 0,3 mm
 410-117-004 0,4 mm 410-117-006 0,6 mm
 410-117-008 0,8 mm 410-117-010 1,0 mm
 410-117-012 1,2 mm 410-117-015 1,5 mm
 410-117-020 2,0 mm 410-117-025 2,5 mm
SHAMBOUGH
 Mikro-Häkchen, 45° abgewinkelt, 160 mm
 Micro Hook, 45° angled, 6 1/4 inch

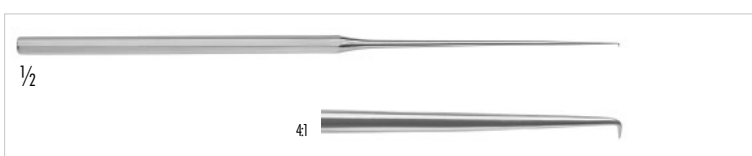

410-210-002 0,2 mm 410-210-003 0,3 mm
 410-210-004 0,4 mm 410-210-006 0,6 mm
 410-210-008 0,8 mm 410-210-010 1,0 mm
 410-210-012 1,2 mm 410-210-015 1,5 mm
 410-210-020 2,0 mm 410-210-025 2,5 mm
SHAMBOUGH
 Mikro-Häkchen, 90° abgewinkelt, 160 mm
 Micro Hook, 90° angled, 6 1/4 inch

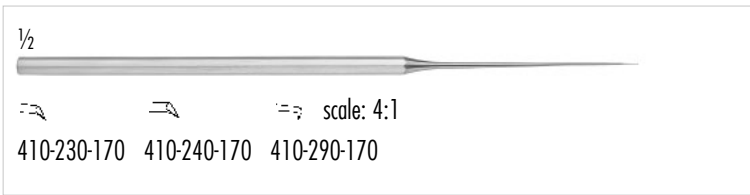

410-230-170 0.33mm Spitze/tip, 30° gebogen/angled
410-240-170 0.66mm Spitze/tip, 30° gebogen/angled
410-290-170 0.33mm Spitze/tip, 90° gebogen/angled

HOUSE

Oval Window Pick, 8-kant Griff, spitz, 17cm
Oval Window Pick, Octagon handle, pointed, 6³/₄ inch

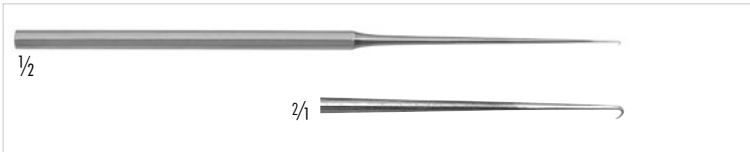

410-119-010 1,0 mm
410-119-011 2,5 mm
Mikro-Häkchen, retrograd gebogen, 160 mm
Micro hook, reverse curved, 6 1/4 inch

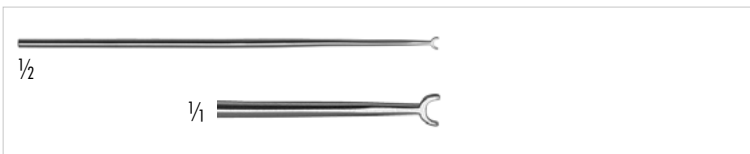

410-119-110

BLOCH

Ohrstopfer, 110 mm
Aural plugger, 4 1/3 inch

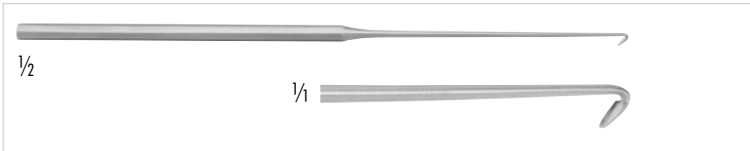

410-120-020 2,0 mm

PLESTER

Ohrschaber, 60° abgewinkelt, zum Anfrischen der Trommelfellrückseite, 160 mm
Aural scraper, 60° angled, for roughening of tympanum surface, 6 1/4 inch



410-216-006 0,6 mm

HEERMANN

Häkchen, retrograd schneidend, 160 mm
Hook, reverse cutting, 6 1/4 inch



410-216-004 0,4 mm

PLESTER

Fußplatten-Häkchen, 90° abgewinkelt, oval, stumpf, 160 mm
Footplate hook, 90° angled, oval, blunt, 6 1/4 inch

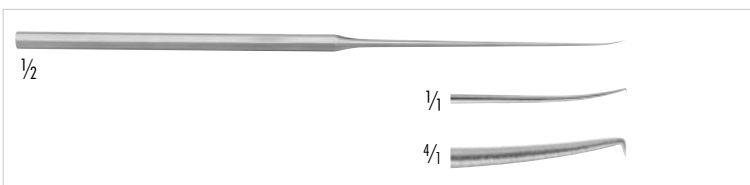

410-216-007

Mikro-Häkchen, leicht abgewinkelte Spitze, 160 mm
Mikro Hook, slightly angled at tip, 6 1/4 inch

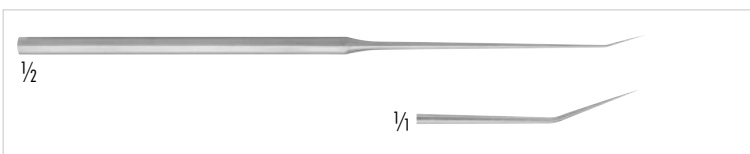

410-216-008

BEALE

Mikro-Ohrhäkchen, nach oben abgewinkelt, 160 mm
Footplate Hook, angled upwards for removal of footplate, 6 1/4 inch

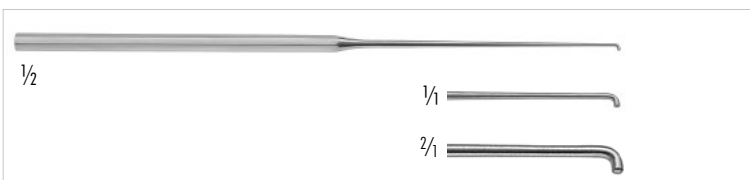

410-216-009

PLESTER

Antrumhäkchen, 90° abgewinkelt, zylindrisch, 160 mm
Antrum hook, 90° angled, cylindrical, 6 1/4 inch

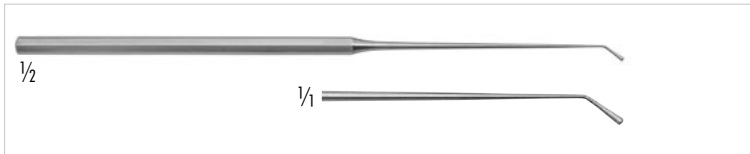

410-216-045

PLESTER

Antrumhäkchen, 45° abgewinkelt, zylindrisch, 160 mm
Antrum hook, 45° angled, cylindric, 6 1/4 inch

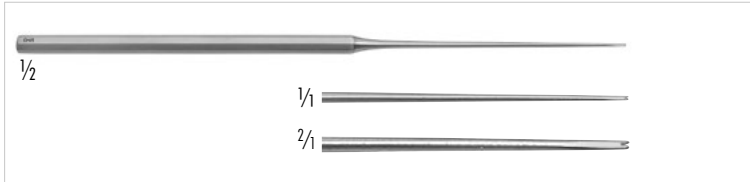

410-216-160

PLESTER

Applikationsinstrument (Führungsgabel, Stapesreiter) für
Stapesprothesen mit Drahtschlinge, (Arbeitsende flach), 160 mm
Wire guide and applicator for stapesprosthesis,
flat end with V-notch, 6 1/4 inch



410-216-165

HUGHES

Steigbügelhäkchen, 165 mm
Stapes mobiliser, 6 1/2 inch

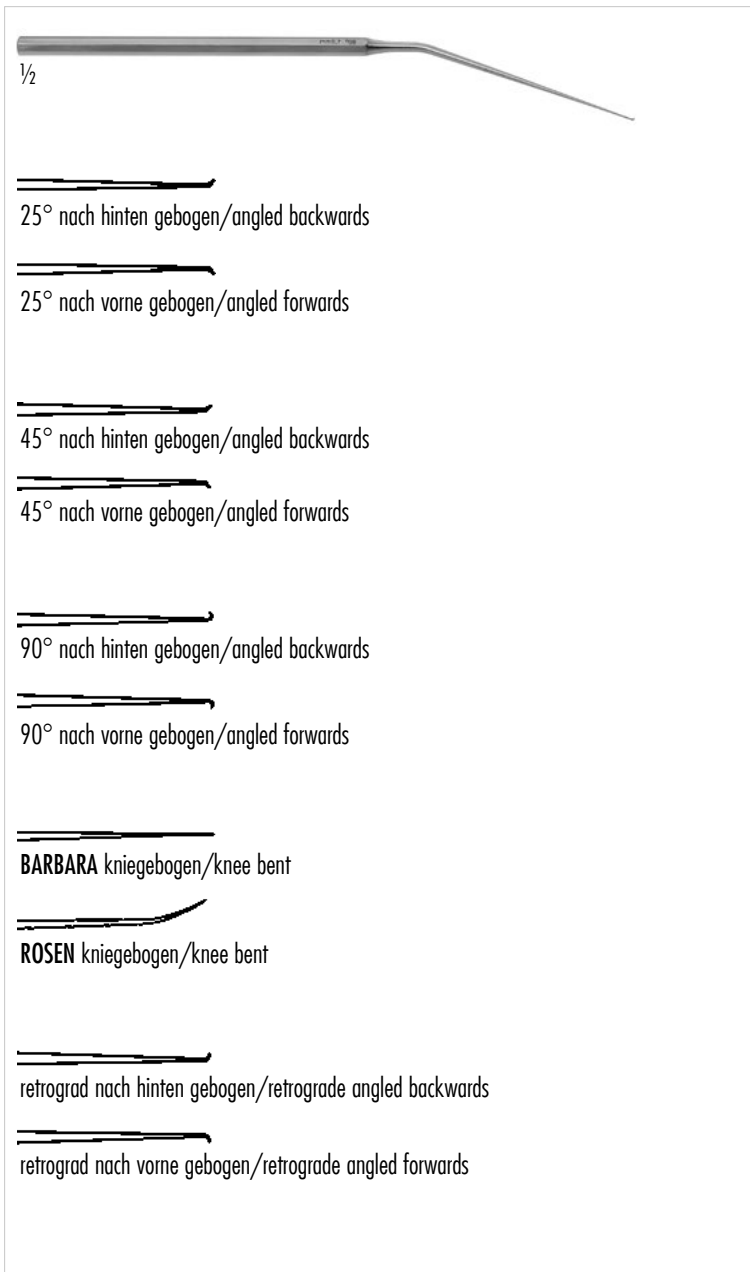

25° nach hinten gebogen
/angled backwards

410-210-303 0,3 mm
410-210-306 0,6 mm
410-210-310 1,0 mm

BARBARA kniegebogen/knee bent
410-113-155
gerade/straight

25° nach vorne gebogen
/angled forwards

410-210-203 0,3 mm
410-210-206 0,6 mm
410-210-210 1,0 mm

ROSEN kniegebogen/knee bent
410-115-153
gebogen/curved

retrograd nach hinten gebogen
/retrograde angled backwards
410-116-205 0,5 mm
410-116-210 1,0 mm

45° nach hinten gebogen
/angled backwards

410-217-003 0,3 mm
410-217-006 0,6 mm
410-217-010 1,0 mm

retrograd nach vorne gebogen
/retrograde angled forwards
410-116-305 0,5 mm
410-116-310 1,0 mm

45° nach vorne gebogen
/angled forwards

410-217-103 0,3 mm
410-217-106 0,6 mm
410-217-110 1,0 mm

90° nach hinten gebogen
/angled backwards

410-216-003 0,3 mm
410-216-005 0,6 mm
410-216-010 1,0 mm

90° nach vorne gebogen
/angled forwards

410-116-103 0,3 mm
410-116-105 0,6 mm
410-116-110 1,0 mm

HOUGH

Mikro Häkchen, 160 mm
Micro hook, 6 1/4 inch

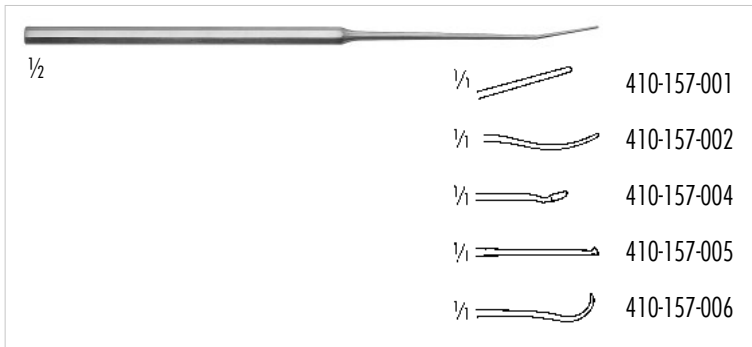

- 410-157-001 Elevatorium/Elevator 1,0 mm
 - 410-157-002 Raspatorium/Raspatory 1,0 mm
 - 410-157-003 Raspatorium/Raspatory 1,2 mm
 - 410-157-004 Löffel/Spoon
 - 410-157-005 Häkchen retrograd scheidend, 0,6 mm
 - 410-157-006 Hook retrograde cutting, 0.6 mm
- 410-157-006** Raspatorium/Raspatory 1,8 mm
- AUSTIN**
165 mm
6 1/2 inch

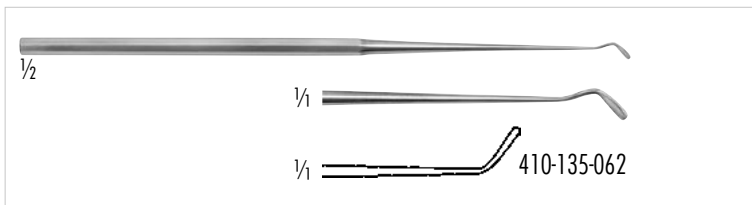

- 410-135-060 doppelt gebogen links
double curved left
 - 410-135-062 einfach gebogen links
single curved left
- Trommelfell Exkavator, schmal, 160 mm
Excavator, narrow, 6 1/4 inch

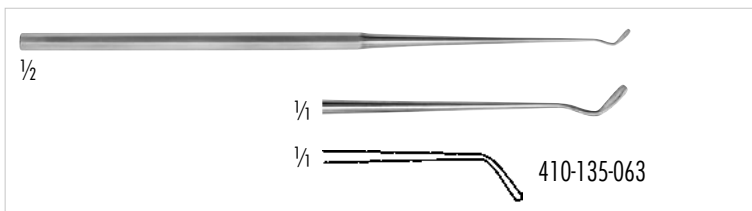

- 410-135-061 doppelt gebogen rechts
double curved rechts
 - 410-135-063 einfach gebogen rechts
single curved rechts
- Trommelfell Exkavator, schmal, 160 mm
Tympanum Excavator, narrow, 6 1/4 inch

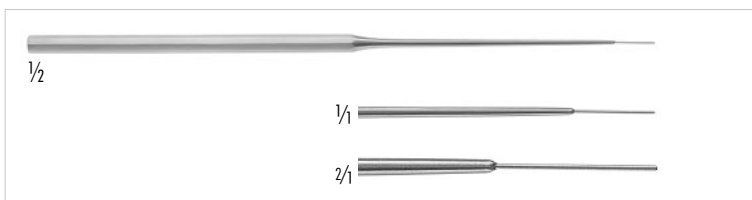

- 410-137-004 0,4 mm
 - 410-137-006 0,6 mm
 - 410-137-008 0,8 mm
- Messzylinder, 165 mm
Caliper, 6 1/2 inch



- 410-137-013 0,3 mm
 - 410-137-014 0,4 mm
 - 410-137-015 0,5 mm
 - 410-137-016 0,6 mm
- Perforator, 165 mm
Perforator, 6 1/2 inch

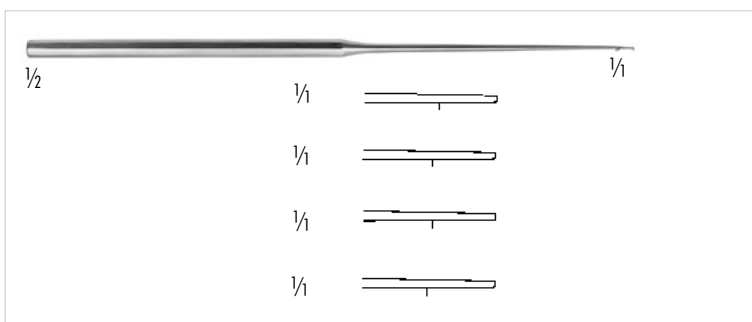

- 410-142-166 Mess-Sonde, Markierungen bei 3,5 - 4 - 4,5 mm zur
Längenbestimmung der Stapesprothese, 160 mm
Measuring probe (caliper) markings at 3.5 - 4 - 4.5 mm,
to determine length of stapes prosthesis, 6 1/4 inch
- 410-142-135 Markierung 3,5 mm/Mark 3.5 mm
- 410-142-140 Markierung 4,0 mm/Mark 4.5 mm
- 410-142-145 Markierung 4,5 mm/Mark 4.5 mm
- 410-142-150 Markierung 5,0 mm/Mark 5.0 mm



410-143-000 92 x 54 mm
 Präpariertablett aus Metall mit mm Skala
 Preparation tray with mm scale, stainless steel

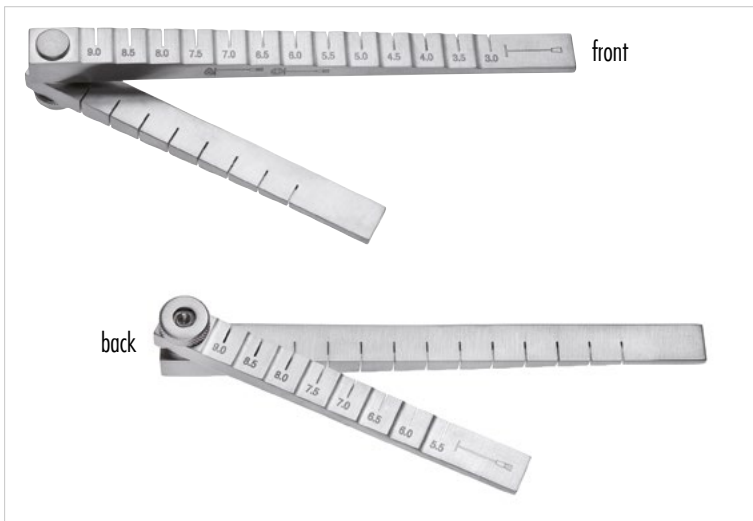

410-155-800
 Universal Titan Prothesen Messgerät, Messbereich von 2.5 bis 9mm
 Universal Titanium Prosthesis Sizer, measuring from 2.5 till 9mm

HEERMANN

Instrumentarium zur Ausmeisselung der Stapes-Fussplatte
Instruments for the removal of the stapedia footplate

410-144-007 0,7 mm
Hohlmeissel, sehr fein
Gouge, very delicate

410-144-010 1,0 mm
Hohlmeissel für Fensterung
Gouge for fenestration

410-144-015 1,5 mm
Hohlmeissel für Fensterung
Gouge for fenestration

410-144-017 0,7 mm
Flachmeissel, sehr fein
Chisel, very delicate

410-144-030 3,0 mm
Hohlmeissel für Fensterung
Gouge for fenestration

410-144-100

Handgriff für die Spezialmeissel. Die Meissel können mit der Feststellschraube in jeder Position fixiert werden.
Handle to hold specially designed chisel and gouges. The knurled screw holds inserts securely in place.

410-144-200

HEERMANN

Metallhammer, mit Hohlheft, 195 mm
Mallet, metal, with hollow handle, narrow head, 7 3/4 inch

410-145-000

SCHUKNECHT

Biegergerät zum Formen von Stapes Drahtprothesen aus rostfreiem Stahl. Biegeplatte mit Millimereinteilung.
Bending device for stapes. This dye is used to pre-form stainless steel wire prosthesis to produce the appropriate button-hook shape for easy attachment to the incus. Measuring the length of the prosthesis, millimeter scale is centered on the bending dye.

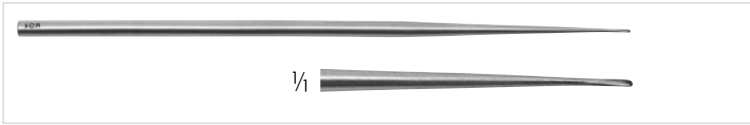



410-046-160 1,5 x 2,5 mm

SHEA

Scharfer Löffel für Tympanoplastik, oval, mit kniegebogenem Schaft, 160 mm

Curette, sharp for tympanoplasty, oval cup, upwards cutting with knee bent shaft, 6 1/4 inch



410-047-160 1,5 x 2,5 mm

SHEA

Scharfer Löffel für Tympanoplastik und Myringoplastik, ovaler Löffel, 160 mm

Curette, sharp for tympanoplasty and myringoplasty, oval cups, 6 1/4 inch



410-044-001 Ø 1,0 + 1,2 mm

410-044-002 Ø 1,5 + 1,8 mm

HOUSE

Scharfer Doppel-Löffel für Stapedektomie, ovale Löffel, leicht gebogen, 150 mm

Curette, sharp, double ended, for stapedectomy, oval cups, slightly curved, 6 inch



410-044-003 Ø 1,0 + 1,2 mm

410-044-004 Ø 1,5 + 1,8 mm

HOUSE

Scharfer Doppel-Löffel für Stapedektomie, oval, stark gebogen, 150 mm

Curette, sharp, double ended, for stapedectomy, oval cups, strongly curved, 6 inch



410-044-150

HOUSE-STAPES

Kürette, doppelendig, 2,2 x 3,0mm, 2,5 x 3,2mm, 30° abgewinkelt, 170mm

Curette, double ended, 2.2 x 3.0mm, 2.5 x 3.2mm, 30° angled, 6 2/3 inch

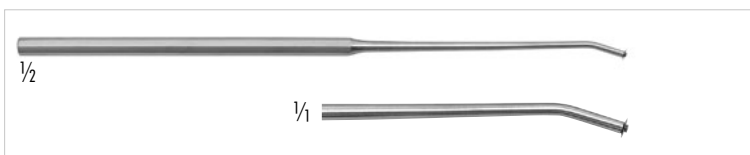

410-089-001

SCHUKNECHT

Rollmesser, rechtwinklig zum Schaft, zur Inzision im äusseren Gehörgang, 160 mm

Roller knife, for incision of the bony external auditory meatus, blade at the right angle to shaft, 6 1/4 inch

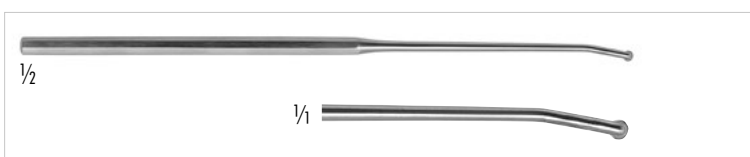

410-089-002

SCHUKNECHT

Rollmesser, parallel zum Schaft, zur Inzision im äusseren Gehörgang, 160 mm

Roller knife, for incision of the bony external auditory meatus, but blade in line with shaft, 6 1/4 inch

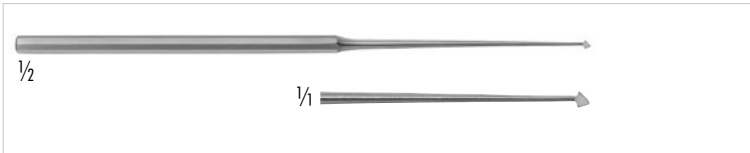

410-093-160

ROSEN

Lanzettenmesser, 160 mm

Knife and elevator, spear pointed blade, 6 1/4 inch

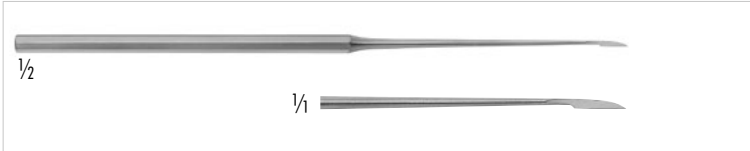

410-100-160

Diszisionsmesser, gerades Blatt, 160 mm

Footplate knife, straight blade, 6 1/4 inch

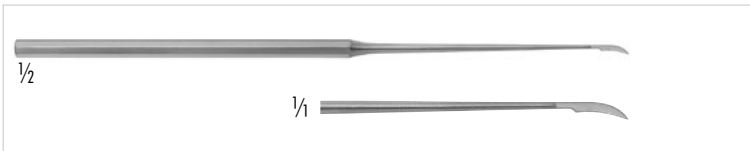

410-101-160

PLESTER

Sichelmesser, leicht gebogenes Blatt, 160 mm

Sickle knife, slightly curved blade, 6 1/4 inch

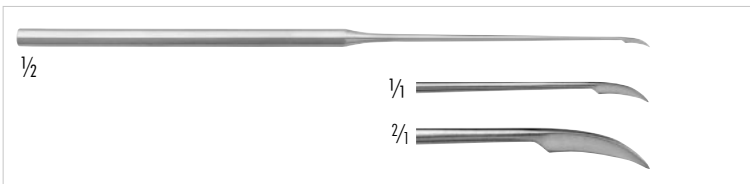

410-103-160

THORBURN

Sichelmesser, gebogenes Blatt, 165 mm

Sickle knife, curved blade, 6 1/2 inch

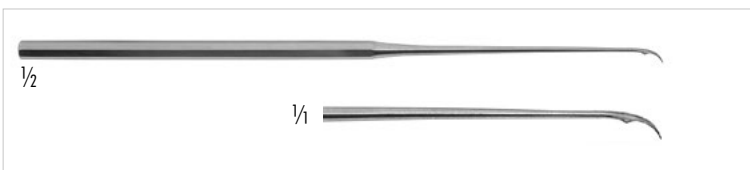

410-109-170

BEALES

Sehnenmesser, 170 mm

Tendon knife, 6 3/4 inch

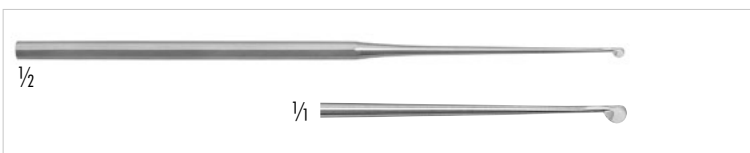

410-124-160 2,4 mm x 3 mm

PLESTER

Lappenmesser, rundum schneidend, 160 mm

Flap knife, round cutting, 6 1/4 inch

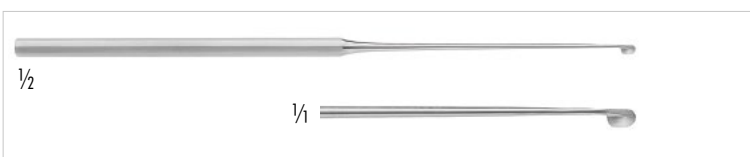

410-092-001 2,4 mm x 3,5 mm

PLESTER

Lappenmesser, rundum schneidend, 160 mm

Flap knife, round cutting, 6 1/4 inch

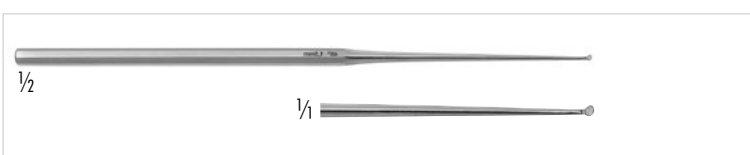

410-118-010 Ø 1,0 mm

410-118-012 Ø 1,2 mm

410-118-015 Ø 1,5 mm

410-118-016 Ø 1,6 mm

410-118-020 Ø 2,0 mm

410-118-023 Ø 2,3 mm

410-118-026 Ø 2,6 mm

410-118-028 Ø 2,8 mm

410-118-030 Ø 3,0 mm

ROSEN

Rundschnittmesser, sehr fein, 45° abgewinkelt, 160 mm

Round cutting knife, slender, 45° angled, 6 1/4 inch



- 410-119-015 Ø 1,5 mm
 410-119-020 Ø 2,0 mm
 410-119-025 Ø 2,5 mm
 410-119-030 Ø 3,0 mm

ROSEN

Rundschnittmesser, 90° abgewinkelt, 160 mm
 Round cutting knife, 90° angled, 6 1/4 inch



- 410-135-048 2 mm breit / wide
 Transplantat-Träger und Raspatorium, 160 mm
 Graft holder and elevator, for lifting drum forward, 6 1/4 inch

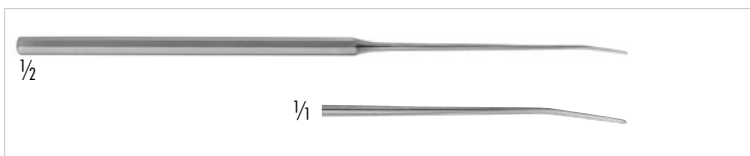

- 410-135-050 1 mm breit / wide
 Stapes-Elevatorium, leicht abgewinkelt, 160 mm
 Stapes Elevator for lifting drum forward, slightly angled, 6 1/4 inch

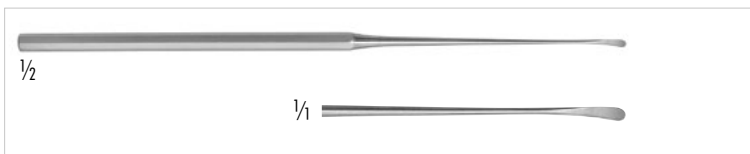

- 410-135-051 1,8 mm breit / wide
 Raspatorium, Spitze rund, zum Ablösen von weichem Gewebe,
 leicht aufgebogen, 160 mm
 Elevator, round edge, slightly curved, for dissection of soft
 tissue, 6 1/4 inch

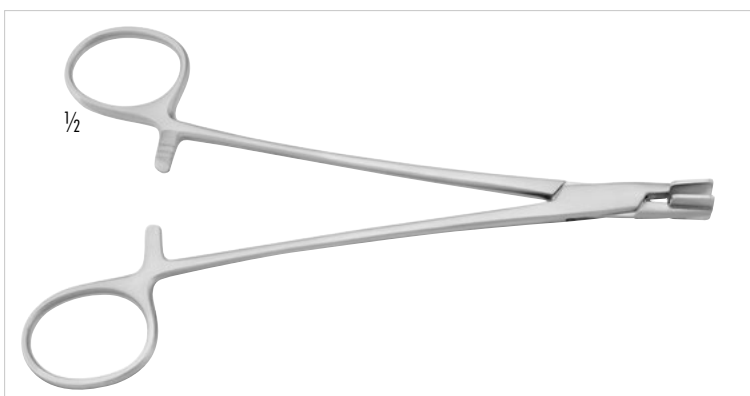

- 410-154-130 12x15mm Blatt, 130 mm
 12x15mm plates, 5 1/8 inch
 410-154-180 11x14 mm Blatt, 180 mm
 11x14 mm plates, 7 inch
 410-155-180 30x30mm Blatt, 180 mm
 30x30mm plates, 7 inch
 410-156-180 22x30mm Blatt, 180 mm
 22x30mm plates, 7 inch

Implantate Presszange, glattes rechteckiges Maul
 Vein graft, press forceps, smooth square jaws,

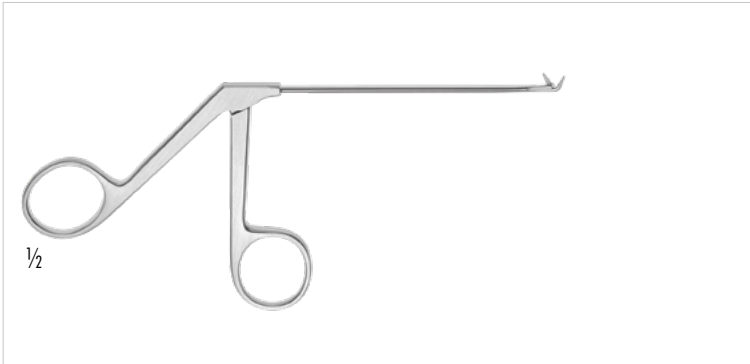

410-330-000 - 410-339-000
 Mikro Faßzängchen, **Rohrschaft**
 80mm Arbeitslänge
 Micro aural forceps with **tubular shaft**
 80mm working length

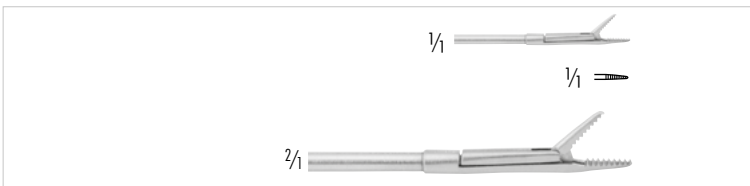

410-330-000 0,8 x 3,5 mm
 gerade
 straight

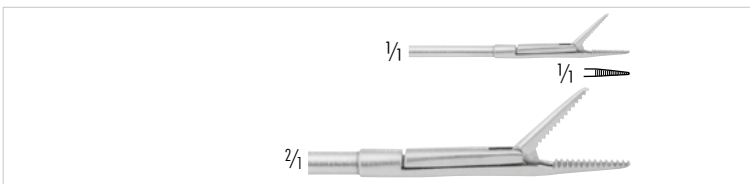

410-335-000 1 x 5 mm
 gerade
 straight

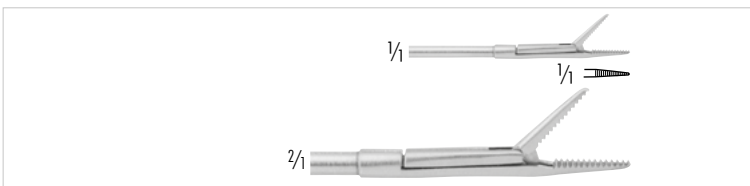

410-321-000 1,5 x 6,0 mm
 gerade
 straight

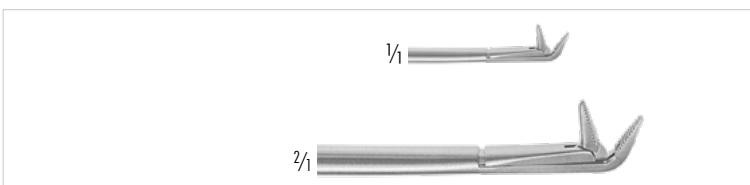

410-330-200 0,8 x 3,5 mm
 65° nach oben gebogen
 curved up 65°

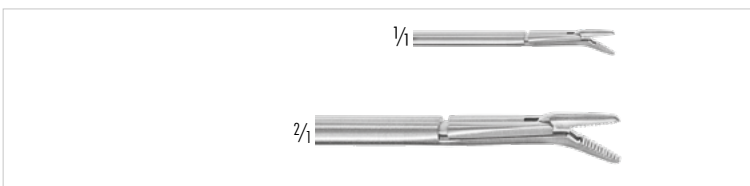

410-332-000 0,8 x 3,5 mm
 45° nach unten gebogen
 curved down 45°

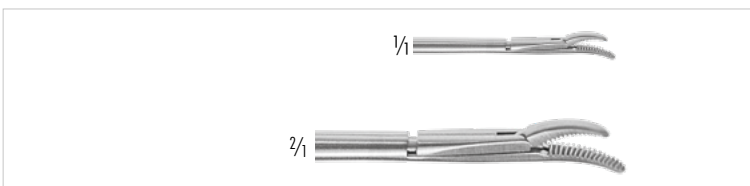

410-339-000 1 x 5 mm
 rechts gebogen
 curved to the right

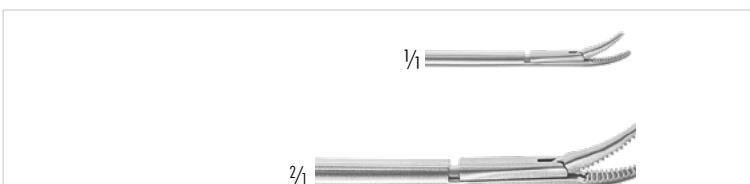

410-338-000 1 x 5 mm
 links gebogen
 curved to the left



410-341-000 - 410-348-000
Mikro-Löffelzängchen, Rohrschaft
80mm Arbeitslänge
Micro cupped forceps with tubular shaft
80mm working length

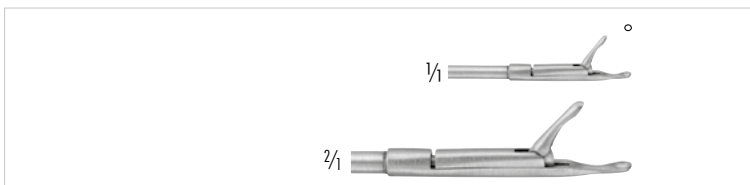

410-341-000 0,9 x 1,0 mm
gerade, Löffel oval
straight, oval cup

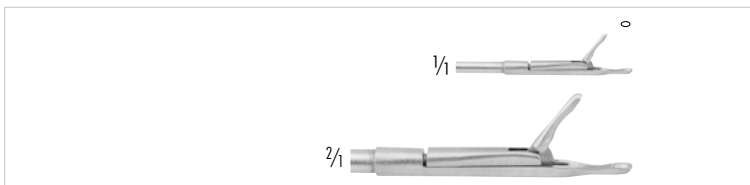

410-345-000 0,8 x 1,3 mm
WULLSTEIN
gerade, Löffel oval
straight, oval cup

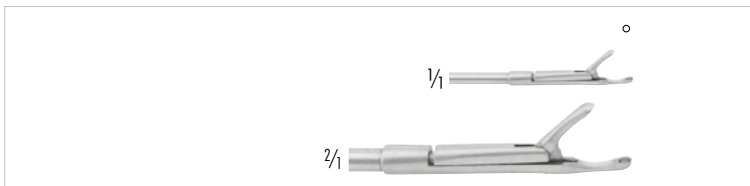

410-346-000 Ø 1,0 mm
WULLSTEIN
gerade, Löffel rund
straight, round cup

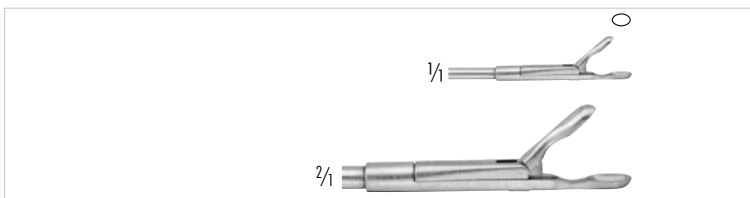

410-348-000 1,7 x 2,5 mm
WULLSTEIN
gerade, Löffel oval
straight, oval cup

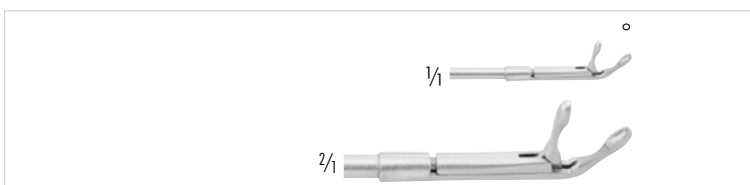

410-342-000 0,9 x 1,0 mm
gebogen, Löffel oval
curved up, oval cup

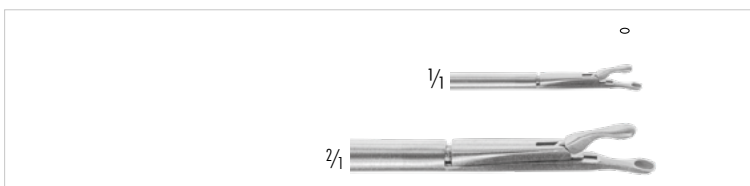

410-343-000 0,8 x 1,3 mm
WULLSTEIN
links gebogen, Löffel oval
curved to the left, oval cup

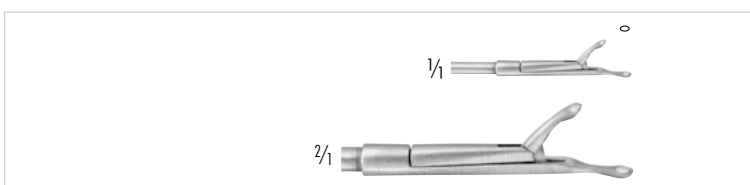

410-344-000 0,8 x 1,3 mm
WULLSTEIN
rechts gebogen, Löffel oval
curved to the right, oval cup

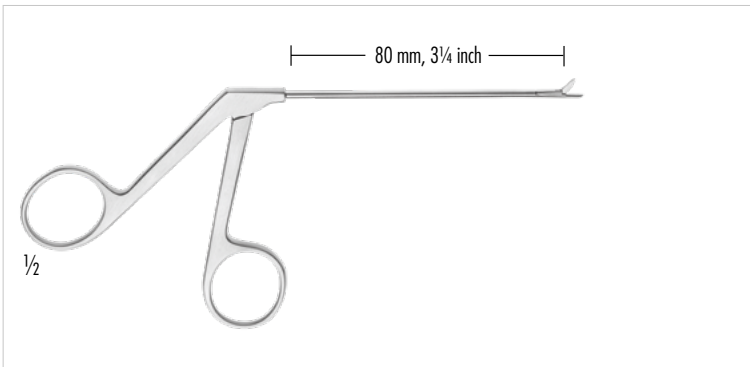

410-350-000 - 410-360-000
 Mikro-Scherchen, Mikro-Stanzen,
 Mikro-Drahtbiegezangchen, **Rohrschaft**
 Micro scissors with, micro punches,
 micro wire bending forceps, **tubular shaft**

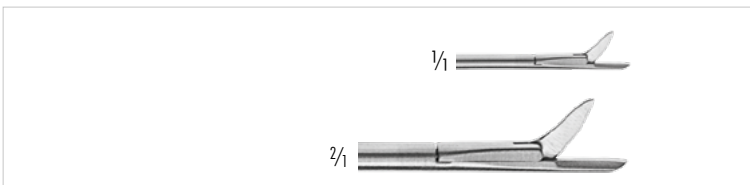

410-350-000 5mm
BELLUCCI
 Mikro-Scherchen, gerade, spitz/spitz
 Micro scissors, straight, sharp/sharp

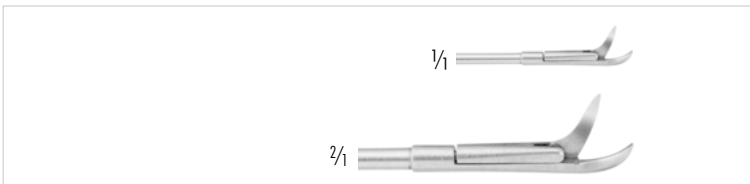

410-352-000 5mm
BELLUCCI
 Mikro-Scherchen, nach links gebogen, spitz/spitz
 Micro scissors, curved to the left, sharp/sharp

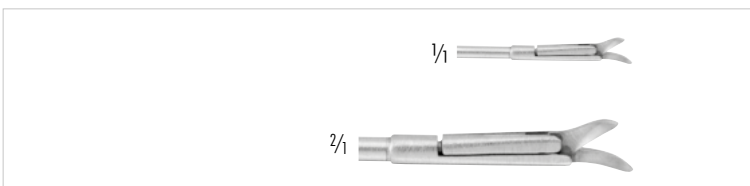

410-353-000 5mm
BELLUCCI
 Mikro-Scherchen, nach rechts gebogen, spitz/spitz
 Micro scissors, curved to the right, sharp/sharp

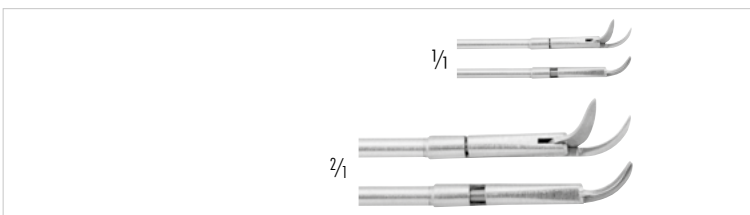

410-355-000
BELLUCCI
 Mikro-Scherchen, horizontal schneidend
 Micro scissors, horizontal cutting

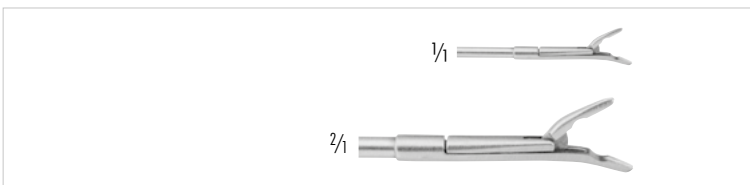

410-359-000
MC GEE
 Mikro-Drahtbiegezangchen, nach unten gebogen, Maullange 3,5 mm
 Wire bending forceps, curved down, jaw length 3.5 mm

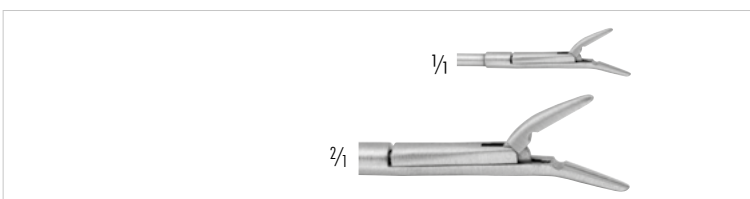

410-360-000
MC GEE
 Mikro-Drahtbiegezangchen, nach unten gebogen, Maullange 5 mm
 Wire bending forceps, curved down, jaw length 5 mm



410-208-100

SOFFERMANN

Nadelhalter mit Sperre, mit Schiebescraft, kariertes Maul,
4,5 mm Maullänge, Arbeitslänge: 100 mm
Needle Holder with ratchet, with sliding shaft, serrated jaws,
4.5 mm long jaw, Working length: 4 inch



410-370-082 Rechts gebogen/offset right

410-370-081 Links gebogen/offset left

JUERS

Ohrzängchen, bajonettförmig, 6 mm Maullänge,
Arbeitslänge: 80 mm
Ear Forceps, bayonet shaped, 6 mm long jaws,
Working length: 3 1/8 inch



410-335-800 4,5 mm langes Maulteil/4.5 mm long jaw

410-330-800 3,0 mm langes Maulteil/3.0 mm long jaw

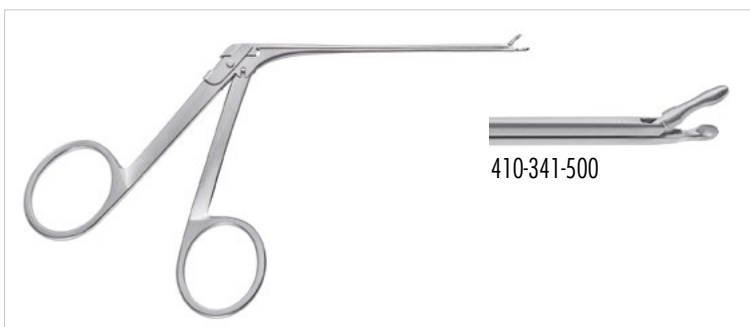
410-335-700 4,5 mm langes Maulteil/4.5 mm long jaw
glatt/smoothAlligator Ohrzängchen, superfein, 0,8 mm breit,
Arbeitslänge: 80mmAlligator Ear Forceps, extra fine, 0.8 mm wide,
Working length: 3 1/8 inch

410-341-500 gerade/straight

410-343-500 links/left curved

410-344-500 rechts/right curved

Ohrzängchen ovaler Löffel, 0,9 mm breit
feines Modell, 4,5 mm Maullänge, Arbeitslänge: 80 mm
Ear Forceps with oval cups, 0.9 mm wide
fine model, 4.5 mm jaw length, Working length: 3 1/8 inch

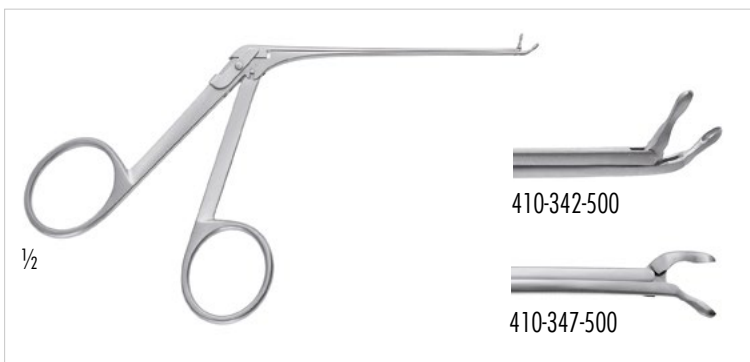

410-342-500 aufwärts/upwards curved

410-347-500 abwärts/down curved

Ohrzängchen ovaler Löffel, 0,9 mm breit,
feines Modell, 4,5mm Maullänge, Arbeitslänge: 80 mm
Ear Forceps with oval cups, 0.9 mm wide,
fine model, 4.5mm jaw length, Working length: 3 1/8 inch

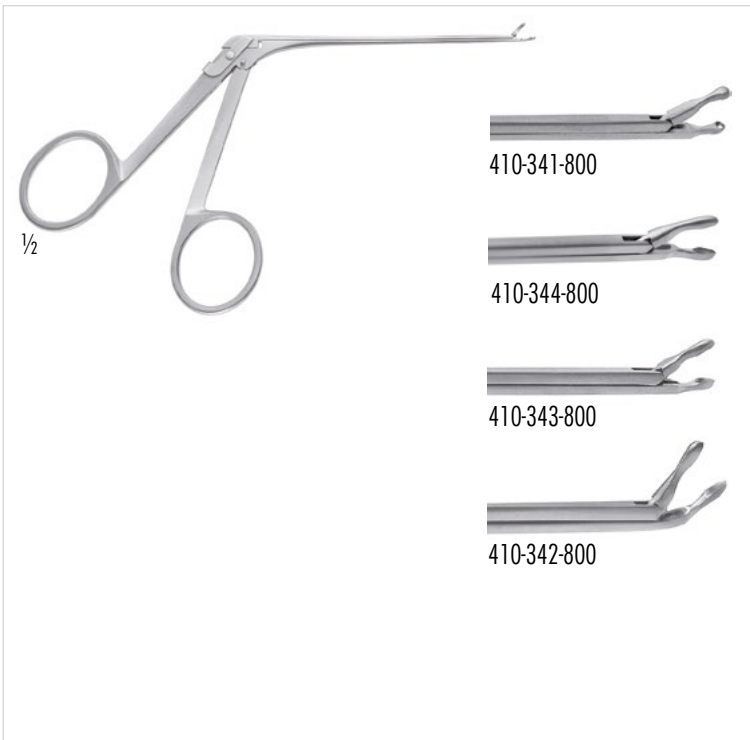

- 410-341-800 gerade/straight
- 410-344-800 rechts gebogen/right curved
- 410-343-800 links gebogen/left curved
- 410-342-800 35° aufgebogen/35° upcurved

Löffelzängchen superfein, 0,6 mm Löffel, 4,5 mm langes Maulteil, Arbeitslänge: 80mm
 Oval Cup Forceps, 0.6 mm wide spoon, 4.5 mm long jaw, Working length: 3 1/8 inch

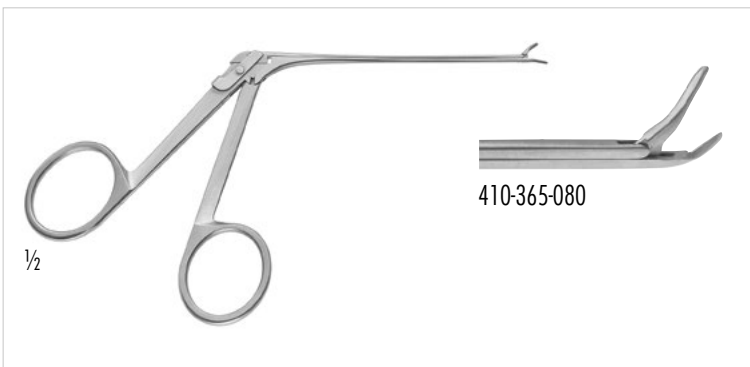

- 410-365-080 45° links/45° left
- 410-366-080 45° rechts/45° rechts

HOUGH
 Seitenschneider, gewinkelt, feines Modell, Arbeitslänge: 80 mm
 Crura Nipper Forceps, angled, fine model, Working length: 3 1/8 inch



- 410-350-700 gerade/straight
- 410-353-700 rechts gebogen/right curved
- 410-352-700 links gebogen/left curved

HOUSE BELLUCCI
 Ohrscherchen, feines Modell, 4,5 mm Schneide, Arbeitslänge: 80 mm
 Ear Scissors, fine model, 4.5 mm blade, straight, 3 1/8 inch

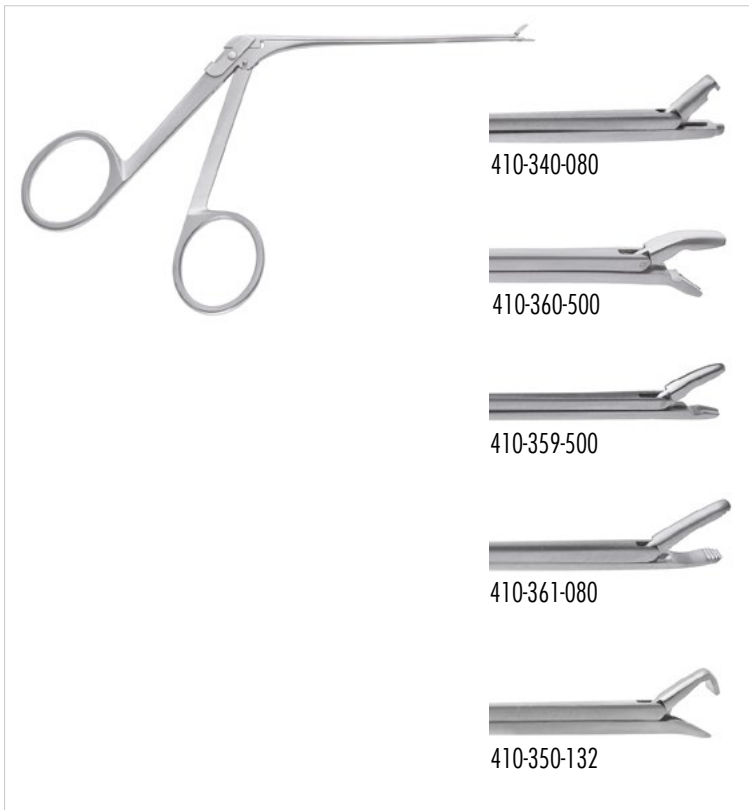

410-340-080

VENT

Tube Ohrzängchen, feines Modell, Arbeitslänge: 80 mm
 Tube Forceps, fine model, Working length: 3 1/8 inch

410-360-500

MCGEE

Drahtschließzängchen, großes Modell, Arbeitslänge: 80 mm
 Malleus Crimper, large model, Working length: 3 1/8 inch

410-359-500

MCGEE

Drahtschließzängchen, superfeines Modell, Arbeitslänge: 80 mm
 Malleus Crimper, super-fine model, Working length: 3 1/8 inch

410-361-080

GREVEN

Ohrzängchen, feines Modell, Arbeitslänge: 80 mm
 Ear Forceps, fine model, Working length: 3 1/8 inch

410-350-132

KOS

Ohrzängchen, feines Modell, Arbeitslänge: 80 mm
 Ear Forceps, fine model, Working length: 3 1/8 inch

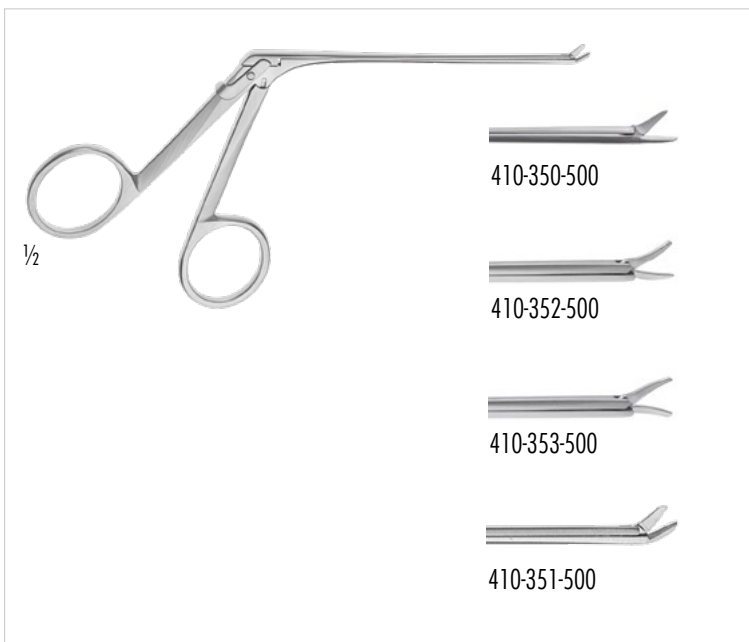

410-350-500

gerade/straight

410-352-500

links gebogen/left curved

410-353-500

rechts gebogen/right curved

410-351-500

35° aufgebogen/35° upcurved

HOUSE BELLUCCI

Ohrscherchen, mittleres Modell, 5,0 mm Schneide,
 Arbeitslänge: 87 mm

Ear Scissors, middle model, 5.0 mm blade length,
 Working length: 3 1/8 inch



410-223-010

Paukenröhrchen Einführinstrument, 100mm
 Tube insertion instrument, 100mm

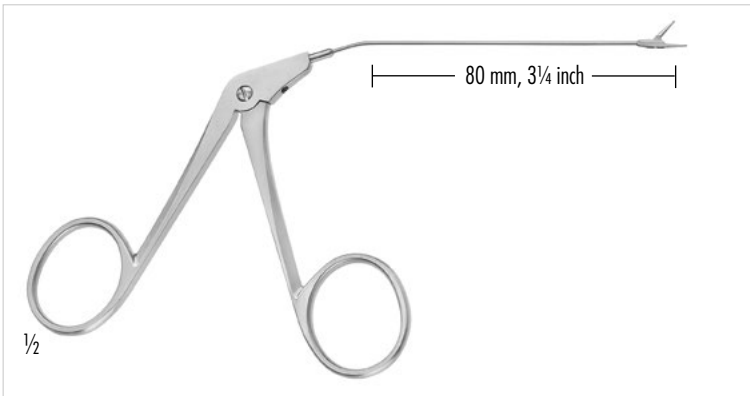

Ohrscheren, **Rohrschaft**
Aural scissors, **tubular shaft**

Ohrscheren
Aural scissors

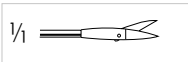
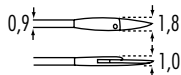

410-352-010

Ohrscheren
Aural scissors

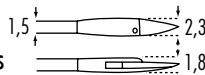

410-351-010

gerade
straight



410-352-020



410-351-020

gerade horizontal
straight horizontal

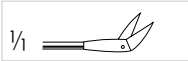

410-352-030



410-351-030

aufgebogen
angled up



410-352-040



410-351-040

aufgebogen horizontal
angled up horizontal

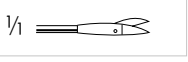

410-352-050

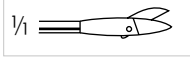

410-351-050

rechts gebogen
curved right

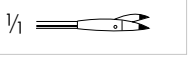

410-352-060



410-351-060

links gebogen
curved left

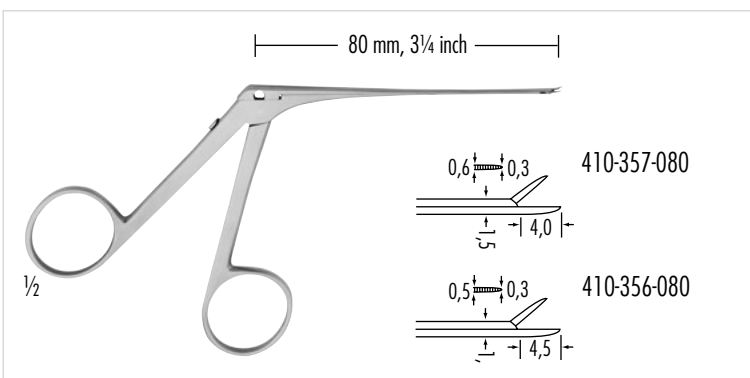

410-357-080 0,6 x 4 mm

410-356-080 0,5 x 4,5 mm, Schafthöhe 1,3 mm
thickness of shaft 1.3 mm

FISCH

Mikro Ohrfasszange, extra zart, gerade, gerieft,
Schafthöhe 1,5 mm, 80 mm Arbeitslänge,
Micro aural forceps, very delicate, straight, serrated,
thickness of shaft 1.5 mm, 3 1/4 inch working length

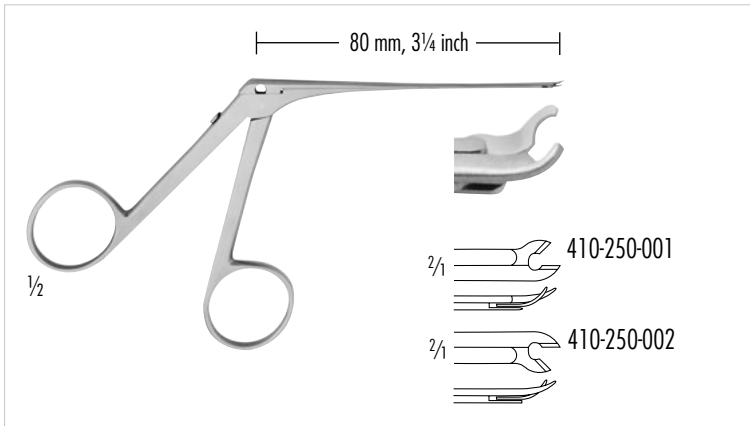

410-250-001 nach rechts öffnend/opening to right
 410-250-002 nach links öffnend/opening to left
FISCH
 Crurotomie Scherchen, Arbeitslänge 80 mm
 Crurotomy scissors, working length 3 1/4 inch



410-302-000
 Neurektomie Schere, 160 mm
 Neurectomy scissors, 6 1/4 inch

Neurektomiescheren
 Neurectomy scissors

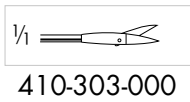

410-303-000

Neurektomiescheren
 Neurectomy scissors

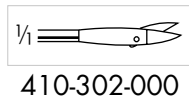

410-302-000

gerade
 straight

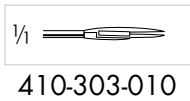

410-303-010

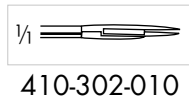

410-302-010

gerade horizontal
 straight horizontal

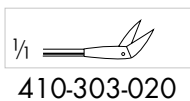

410-303-020

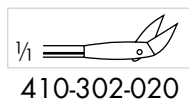

410-302-020

aufgebogen
 angled up

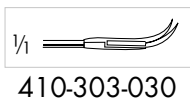

410-303-030

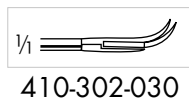

410-302-030

aufgebogen horizontal
 angled up horizontal

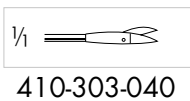

410-303-040

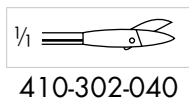

410-302-040

rechts gebogen
 curved right

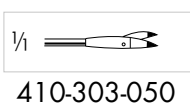

410-303-050

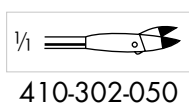

410-302-050

links gebogen
 curved left

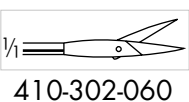

410-302-060

gerade 8,0 mm
 straight 8.0 mm

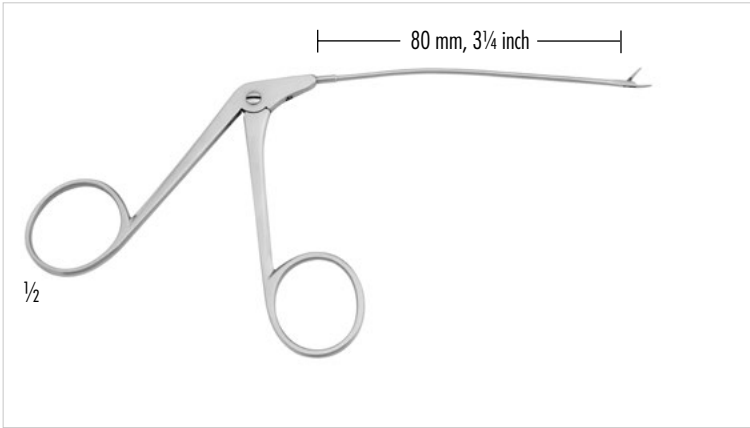

Ohrzängchen, **Rohrschaft**, Rohr 0,9 mm, Maul 1,8 mm
Aural forceps, **tubular shaft**, tube 0.9 mm, jaws 1.8 mm

1 x 2 Zahn
1 x 2 teeth

gerieftes Maul
serrated jaws

Alligator Maul
alligator jaws

Ohrzangen
Aural forceps

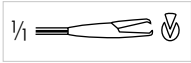

410-343-100

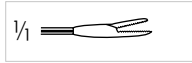

410-341-100

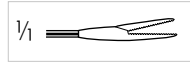

410-340-100

gerade
straight



410-343-200



410-341-200

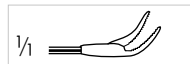

410-340-200

aufgebogen
angled up

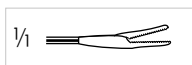

410-341-300

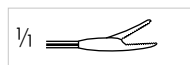

410-340-300

rechts gebogen
curved right

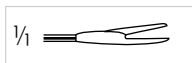

410-341-400

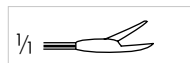

410-340-400

links gebogen
curved left

o 1 mm Ø

oval
oval

Löffelzangen
Cup-shaped forceps

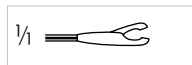

410-340-110



410-340-210

gerade
straight

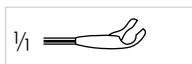

410-340-120

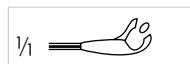

410-340-220

aufgebogen
angled up

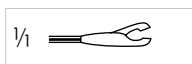

410-340-130

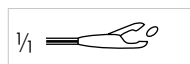

410-340-230

rechts gebogen
curved right

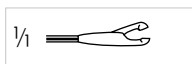

410-340-140

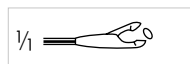

410-340-240

links gebogen
curved left

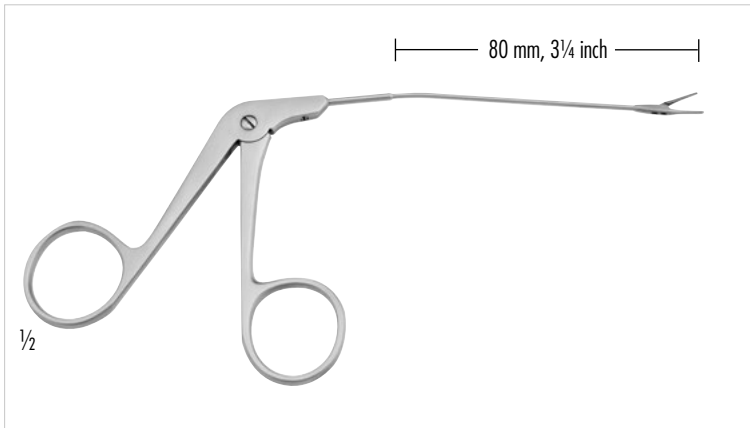

Ohrzängchen, **Rohrschaft**, Schaft 1,5 mm, Maul 2,3 mm
 Aural forceps, **tubular shaft**, shaft 1.5 mm, jaws 2.3 mm

1 x 2 Zahn
 1 x 2 teeth



410-342-100

gerieftes Maul
 serrated jaws



410-342-110

Alligator Maul
 alligator jaws



410-342-210

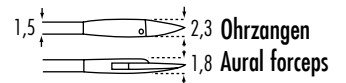

Ohrzangen
 Aural forceps

gerade
 straight

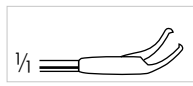

410-342-200

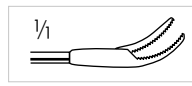

410-342-120

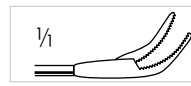

410-342-220

aufgebogen
 angled up



410-342-130

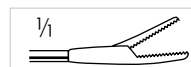

410-342-230

rechts gebogen
 curved right

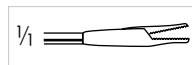

410-342-140



410-342-240

links gebogen
 curved left

◦ 1 mm Ø

◦ 1,5 mm Ø

◦ 2 mm Ø

◦ 2,5 mm Ø

oval = 1,5 x 0,8 mm
 ovale = 1.5 x 0.8 mm

Löffelzangen
 Cup-shaped forceps

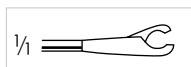

410-343-110



410-343-210



410-343-310

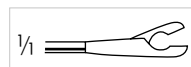

410-343-410

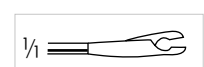

410-343-510

gerade
 straight

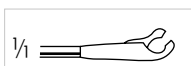

410-343-120

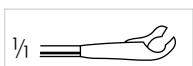

410-343-220

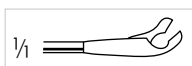

410-343-320

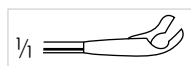

410-343-420



410-343-520

aufgebogen
 angled up

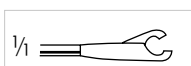

410-343-130

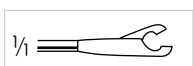

410-343-230

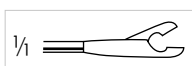

410-343-330

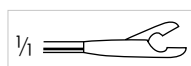

410-343-430

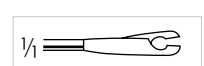

410-343-530

rechts gebogen
 curved right



410-343-140

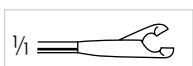

410-343-240

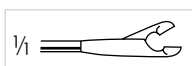

410-343-340

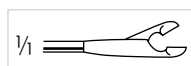

410-343-440



410-343-540

links gebogen
 curved left

Schieberschaft Instrumente/Sliding shaft Instruments

410-354-000 4.0 mm x 1.5 mm
CAWTHORNE
 Mikro-Ohrscherchen, gerade, spitz/spitz
 Micro scissors, straight, sharp/sharp

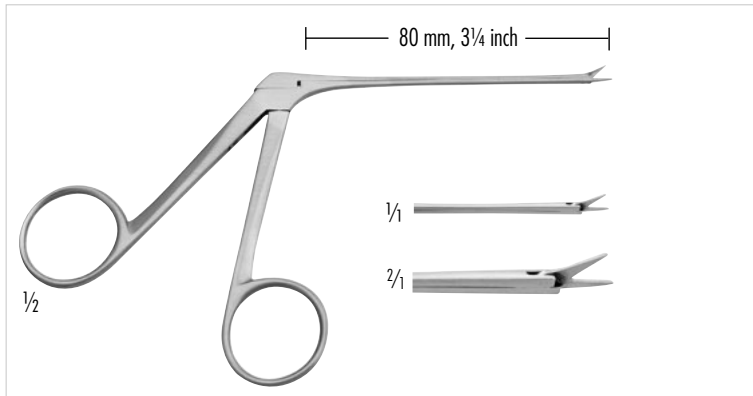

410-423-000 4.0 mm x 1.7 mm
ORMEROD
 Mikro-Löffelzängchen, gerade, Löffel rund
 Micro cupped forceps, straight, round cup

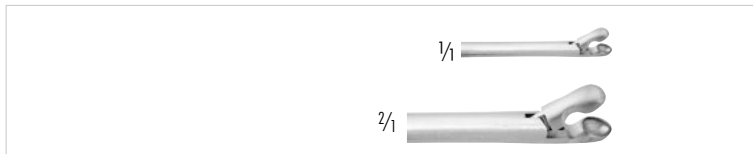

410-424-000 5 mm x 1 mm
ORMEROD
 Mikro-Löffelzängchen, gerade, Löffel oval
 Micro cupped forceps, straight, oval cup

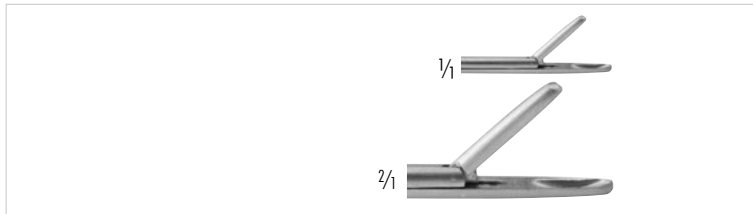

410-349-000 4.0 mm x 0.8 mm
SHEA
 Mikro-Löffelzängchen, gerade, Löffel oval
 Micro cupped forceps, straight, oval cup

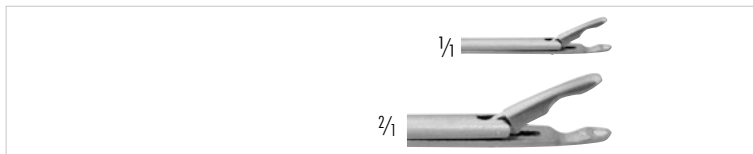

410-329-000 1 mm x 5.0 mm
HOUGH
 Mikro-Ohrzängchen, gerade, gerieftes Maul
 Micro Alligator forceps, straight, serrated jaws

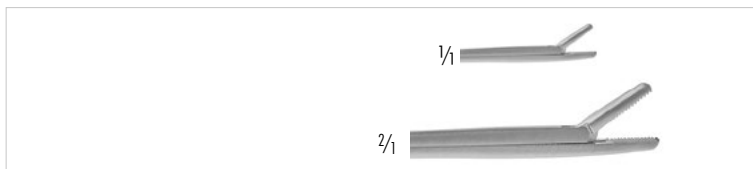

410-334-000 1.25 mm x 7.0 mm
CAWTHORNE
 Mikro-Ohrzängchen, gerade, glattes Maul
 Micro Alligator forceps, straight, smooth jaws

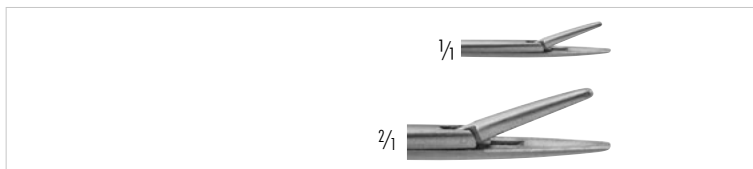

410-300-000
HOUSE-DIETER
 Mikro-Stanze, nach oben schneidend
 Malleus nipper, upwards cutting

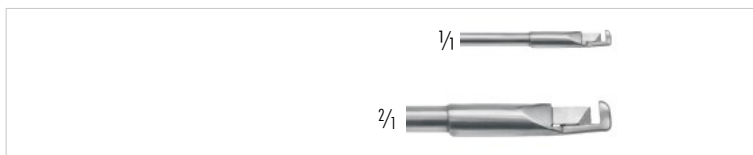

410-301-000
HOUSE-DIETER
 Mikro-Stanze, nach unten schneidend
 Malleus nipper, downwards cutting

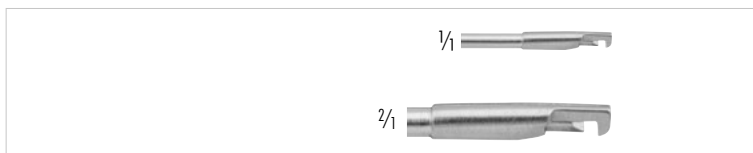

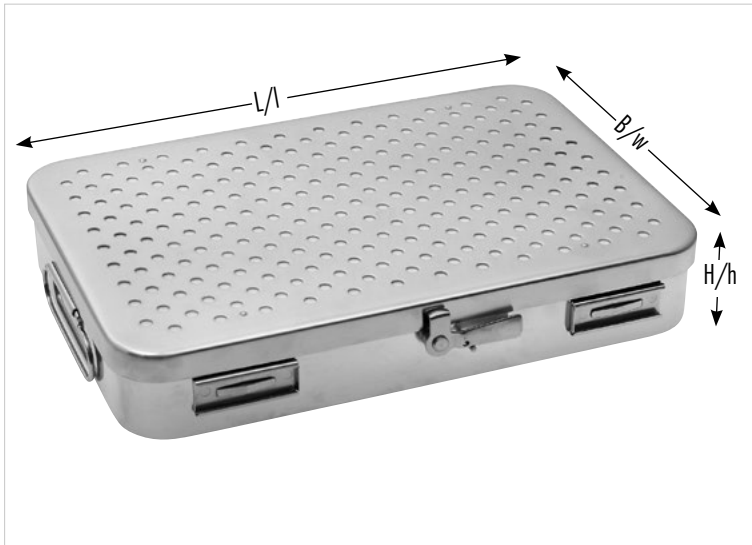

600-405-420	420mm x 175mm x 75mm
600-405-300	300mm x 200mm x 75mm
600-400-300	300mm x 200mm x 50mm
600-400-230	230mm x 130mm x 50mm

Metalletui, gelocht, mit abnehmbarem Deckel, mit Textilfilter, Länge x Breite x Höhe
 Metall case, detachable lid, with textile filter, length x width x height



	Innenmaße/inner dimension
600-402-140	200 x 140 x 54mm
600-402-195	280 x 195 x 45mm
600-402-255	265 x 255 x 45mm
600-402-260	380 x 260 x 45mm

Mikro Container mit Deckel- und Bodenlochung, mit Textil-Langzeitfilter für Dampfsterilisation, TÜV-geprüft, Einfach Lagerung
 Micro container with lid and bottom perforation, with textile «Longterm» filter, steam sterilization, TÜV-approved, single bearing system



RHINOLOGY

Instruments and
Equipment for
Rhinology

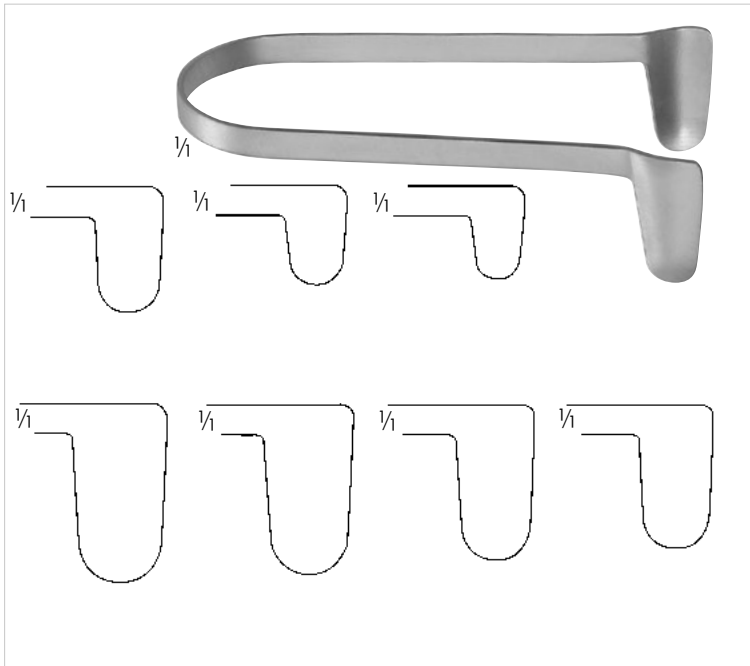

- 420-050-001 8,5 x 6,0 mm
- 420-050-002 9,0 x 7,0 mm
- 420-050-003 12,5 x 8,0 mm
- 420-050-004 15,0 x 8,5 mm
- 420-050-005 16,5 x 9,0 mm
- 420-050-006 18,0 x 10,0 mm
- 420-050-007 19,5 x 10,5 mm

THUDICHUM (MARK HOVELL)

Nasenspekulum, 70 mm
Nasal specula

- 420-050-101 8,5 x 6,0 mm
- 420-050-102 9,0 x 7,0 mm
- 420-050-103 12,5 x 8,0 mm
- 420-050-104 15,0 x 8,5 mm
- 420-050-105 16,5 x 9,0 mm
- 420-050-106 18,0 x 10,0 mm
- 420-050-107 19,5 x 10,5 mm

Nasenspekulum, **isoliert**, 70 mm
Nasal specula, **insulated**

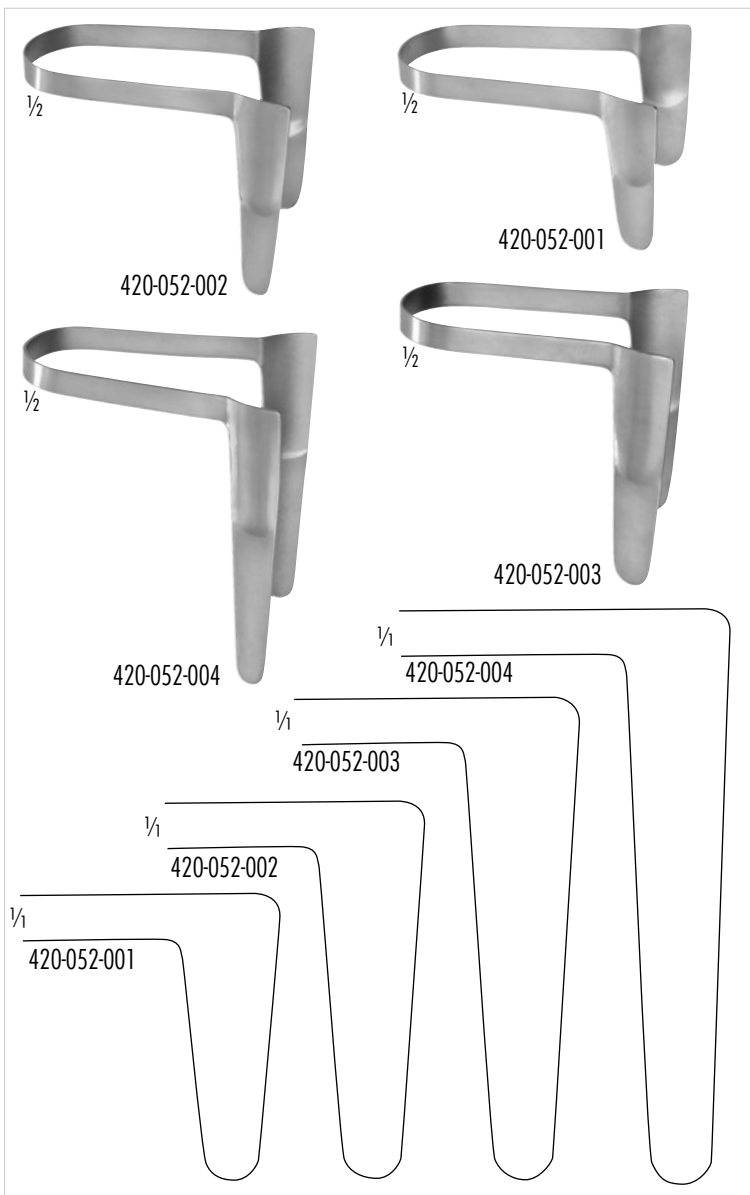

- 420-052-001 38 mm
- 420-052-002 50 mm
- 420-052-003 65 mm
- 420-052-004 75 mm

ST CLAIR THOMPSON

Nasenspekulum, 73 mm
Nasal specula, 2 1/2 inch

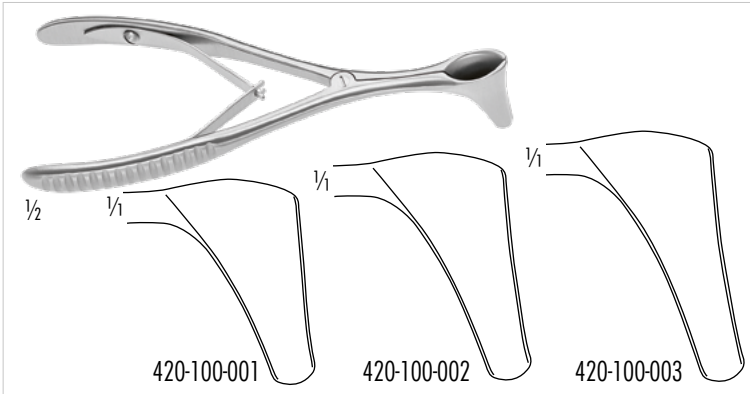

420-100-001 Fig.1 27 x 7 mm
 420-100-002 Fig.2 30 x 7 mm
 420-100-003 Fig.3 33 x 7 mm
 Wiener Modell Nasenspekulum, 130 mm
 Vienna pattern nasal specula, 5 inch

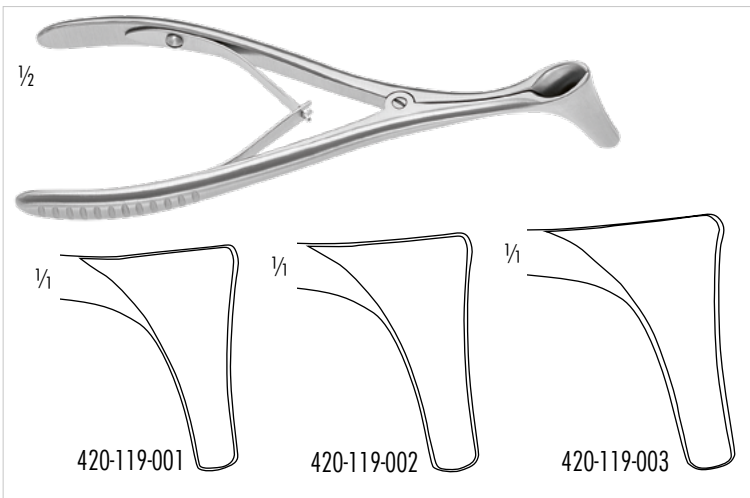

420-119-001 29 x 7 mm
 420-119-002 33 x 7 mm
 420-119-003 35 x 7 mm
HARTMANN
 Nasenspekulum, 160 mm
 Nasal specula, 6 1/4 inch

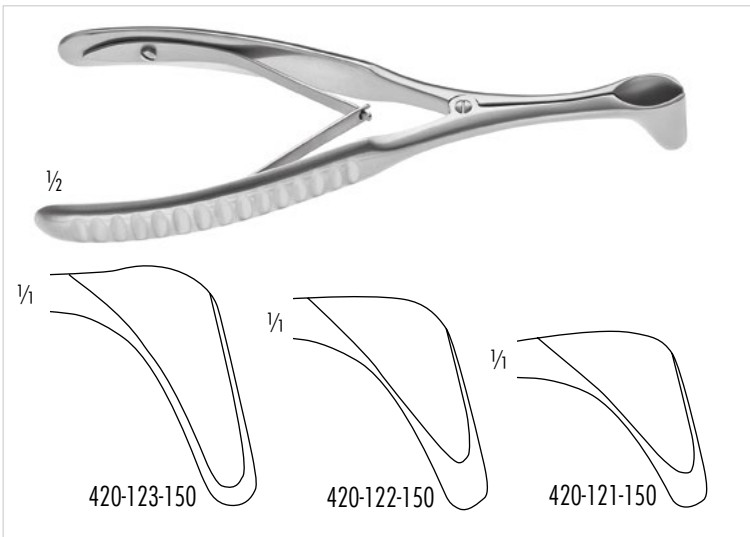

420-121-150 27 mm
 420-122-150 31 mm
 420-123-150 35 mm
HARTMANN-HALLE
 Nasenspekulum, 155 mm
 Nasal specula, 6 inch

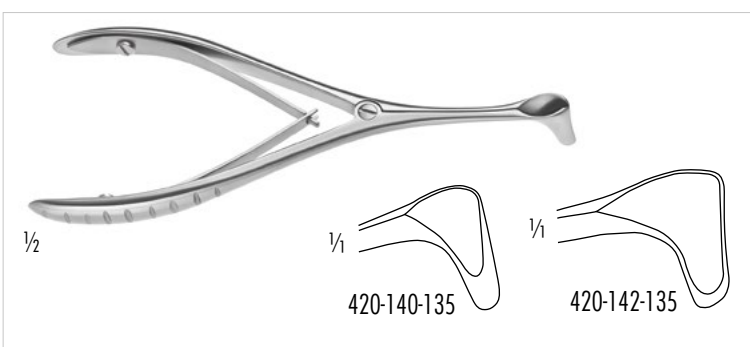

420-140-135 klein/small
 420-142-135 groß/large
TIECK-HALLE
 Nasenspekulum, Kindermodelle, 135 mm
 Nasal specula, pediatric pattern, 5 1/4 inch

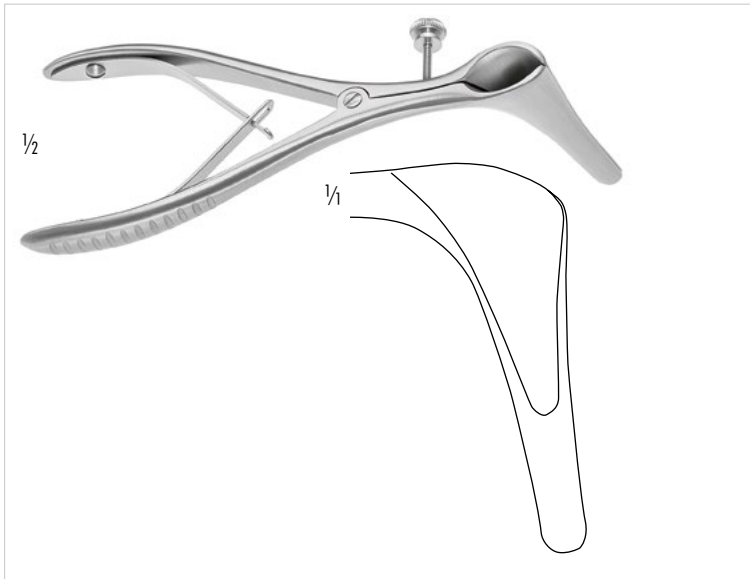

420-134-050 50 x 6 mm

COTTLE

Septumspekulum, leicht spitz zulaufend
Septum specula, slightly tapered blades

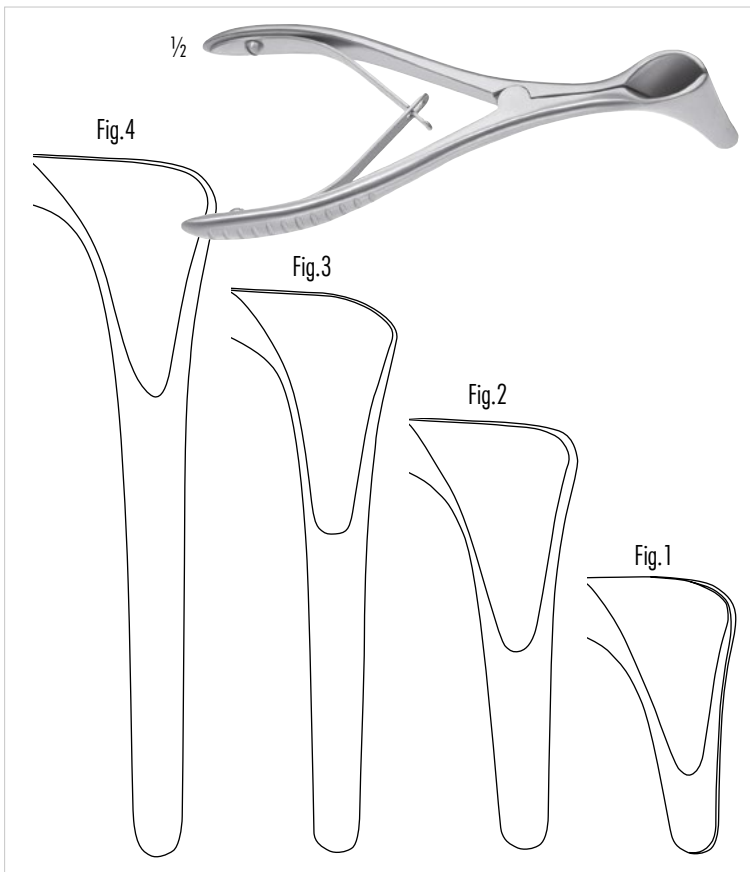

420-145-036	Fig.1	36 x 7 mm
420-145-056	Fig.2	56 x 7 mm
420-145-075	Fig.3	75 x 7 mm
420-145-090	Fig.4	90 x 7 mm

KILLIAN

Nasenspekulum, 145 mm
Septum specula, 5 3/4 inch



420-743-055	55 mm
420-743-075	75 mm
420-743-090	90 mm

KILLIAN

Nasenspekulum, mit abnehmbarem Kaltlichtträger, 140 mm
Nasal specula, with detachable cold light carrier, 5 1/2 inch

420-136-020	Fig.1	30 mm
420-136-035	Fig.2	38 mm
420-136-055	Fig.3	55 mm
420-136-070	Fig.4	70 mm
420-136-080	Fig.5	80 mm
420-136-090	Fig.6	90 mm

COTTLE

Nasenspekula mit Stellschraube, 135 mm
 Nasal specula with setscrew, 5 1/4 inch

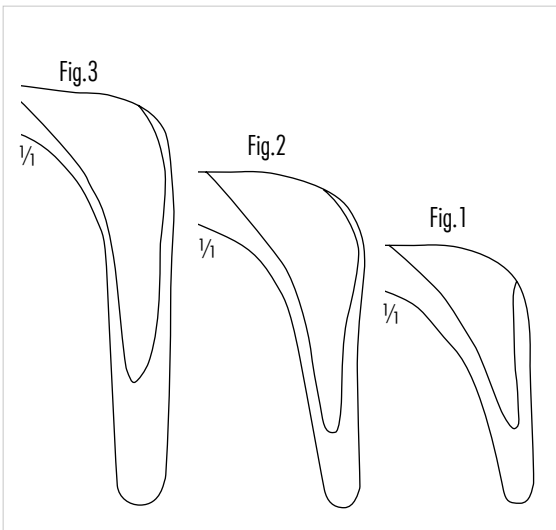
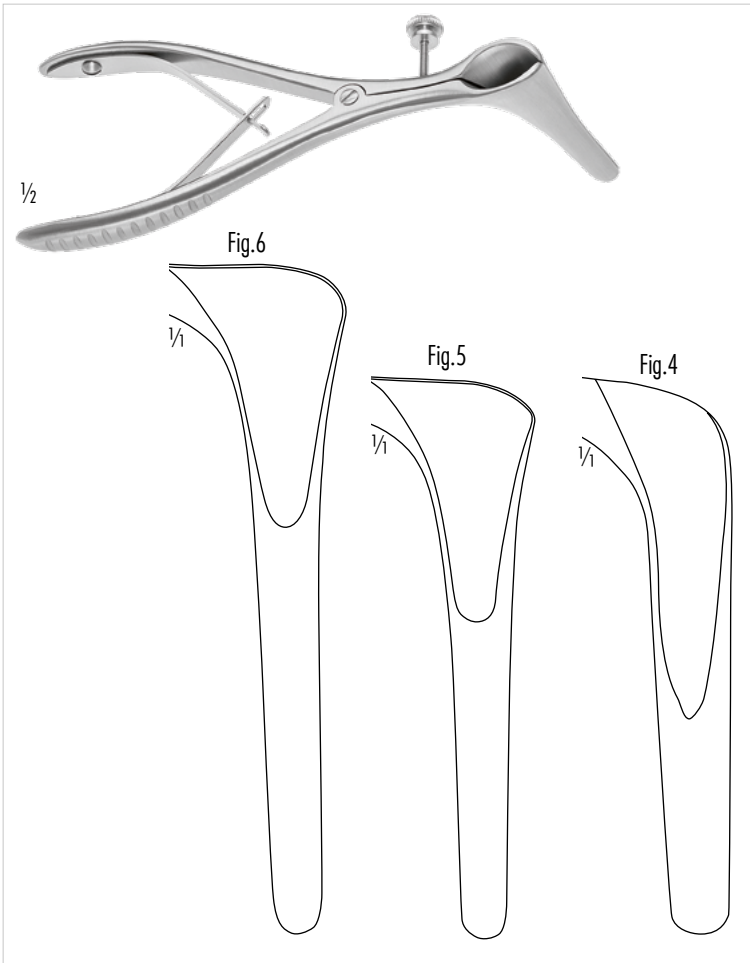

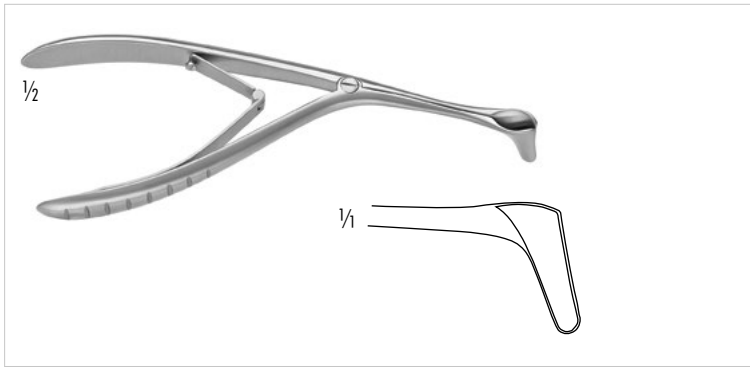

420-147-140

BECKMANN

Nasenspekula, Kindermodell, seitwärts gebogen, 150 mm
Nasal specula, pediatric pattern, curved sidewards, 6 inch

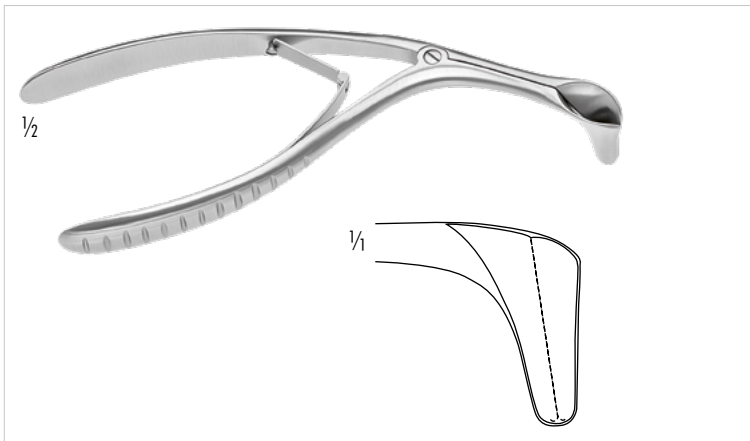

420-148-150

BECKMANN

Nasenspekula, seitwärts gebogen, 150 mm
Nasal specula, curved sidewards, 6 inch



- 420-140-035 35mm Blattlänge/blade length
- 420-140-050 50mm Blattlänge/blade length
- 420-140-075 75mm Blattlänge/blade length
- 420-140-090 90mm Blattlänge/blade length
- 420-140-100 100mm Blattlänge/blade length

COTTLE MASING

Nasenspekula für flexiblen Spannarm, mit Stellschraube
Nasal Specula for flexible arm



- 420-150-001 links/left 55mm, rechts/right 35mm
- 420-150-002 links/left 35mm, rechts/right 55mm
- 420-150-003 links/left 65mm, rechts/right 45mm
- 420-150-004 links/left 45mm, rechts/right 65mm
- 420-150-005 links/left 75mm, rechts/right 35mm
- 420-150-006 links/left 35mm, rechts/right 75mm
- 420-150-007 links/left 75mm, rechts/right 52mm
- 420-150-008 links/left 52mm, rechts/right 75mm

Sinus Spekula zur Verwendung mit flexiblen Spannarm,
mit Zähnen, mit Stellschraube
Sinus Specula for use with flexible arm, with teeth,
with set screw

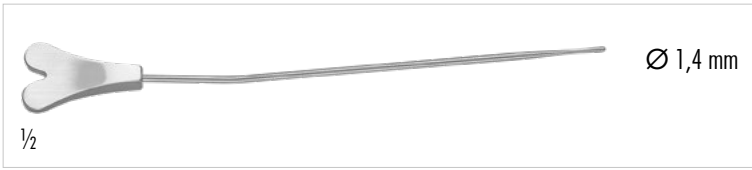

420-150-160
Nasensonde, kniegebogen, 160 mm
Nasal probe, knee angled, 6 1/4 inch



420-150-165
KILLIAN
Nasensonde, leicht gebogen, 165 mm
Nasal probe, slightly curved, 6 1/2 inch

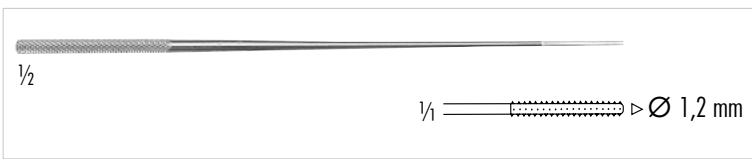

160-426-165 Ø 1,2 mm
LATHBURY-FARRELL
Nasensonde, dreikant gerieft, 160 mm
Nasal applicator, triangular serrated end, 6 1/4 inch

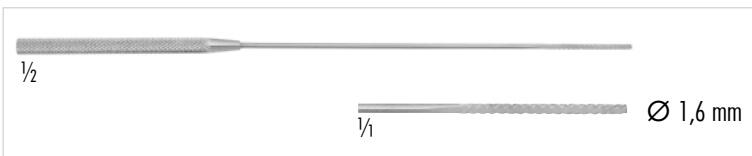

160-426-160 Ø 1,6 mm
Nasensonde, dreikant gerieft, 160 mm
Nasal applicator, triangular serrated end, 6 1/4 inch

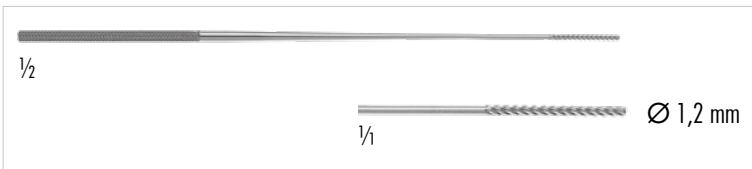

160-420-165 Ø 1,2 mm
FARREL
Nasensonde, spiralförmig gerieft, 160 mm
Nasal applicator, rough spiral end, 6 1/4 inch

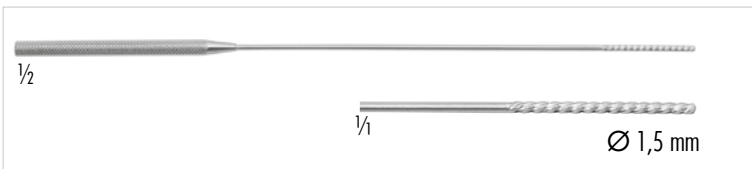

160-412-180 Ø 1,5 mm
Nasensonde, spiralförmig gerieft, 180 mm
Nasal applicator, rough spiral end, 7 inch



420-150-180
SIEBENMANN
Nasensonde, 180 mm
Nasal plugger, 7 inch



420-413-230

LANGE

Choanenhaken, 230 mm
Choana hook, 9 1/2 inch

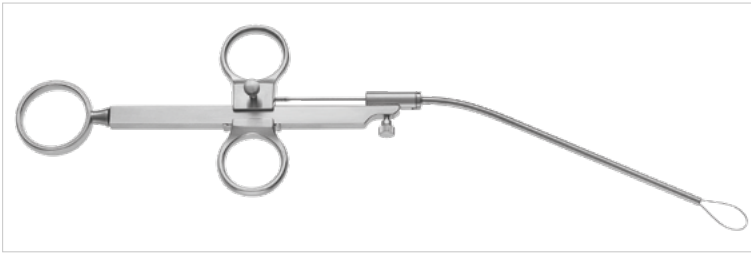

420-201-260

KRAUSE

Nasenpolypenschnürer, kniegebogen, 250 mm
Nasal polypus snare, knee bent, 10 inch

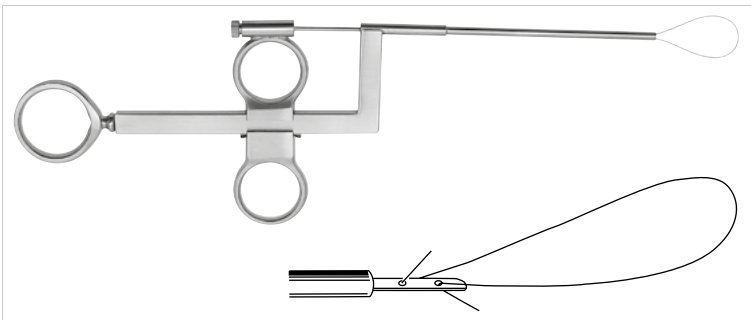

410-270-250

WILDE

Nasenpolypenschnürer, bajonettförmig gebogen, 250 mm
Nasal polypus snare, bayonet shaped, 10 inch



420-210-003 Ø 0,3 mm

Schlingen für Nasenpolypenschnürer,
Bestelleinheit: PH=Packung á 100 Stück
Wire loops for nasal snares,
sales unit: PH=Package of 100 pieces

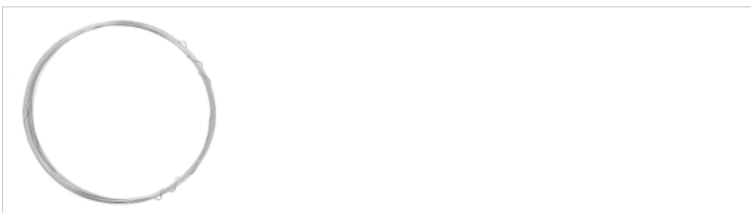

420-210-013 Ø 0,3 mm

Schnürerdrabt in Rollen á 10 m
Snare wire in coils of 10 metres

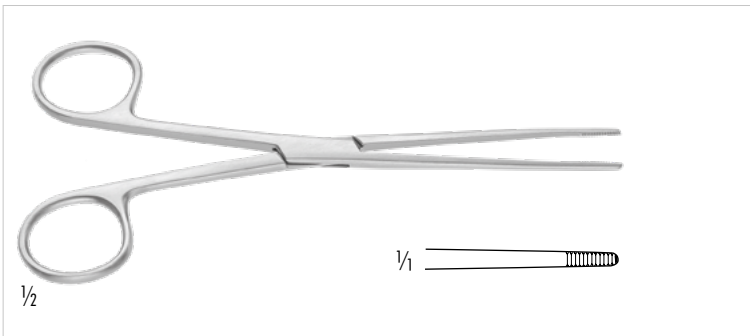

150-080-160 155 mm/6 inch
150-080-180 180 mm/7 inch

LISTER

Tamponzange
Sinus forceps

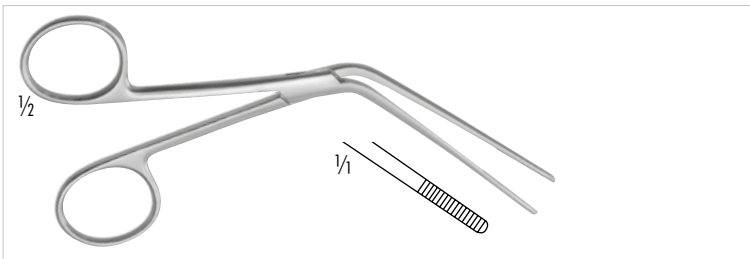

410-232-140

TILLEY

Nasentamponzange, 130 mm
Nasal dressing forceps, 5 1/8 inch

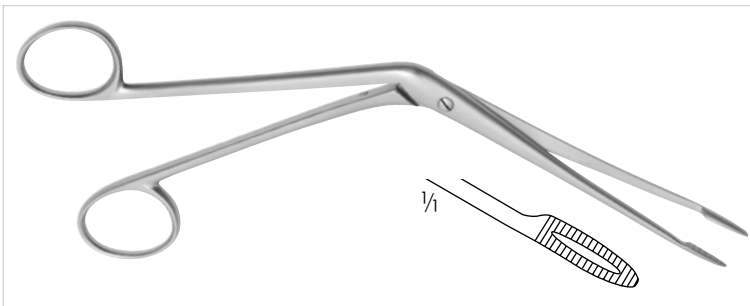

420-211-200

HARTMANN

Nasentamponzange, 215 mm
Nasal dressing forceps, 8 1/4 inch

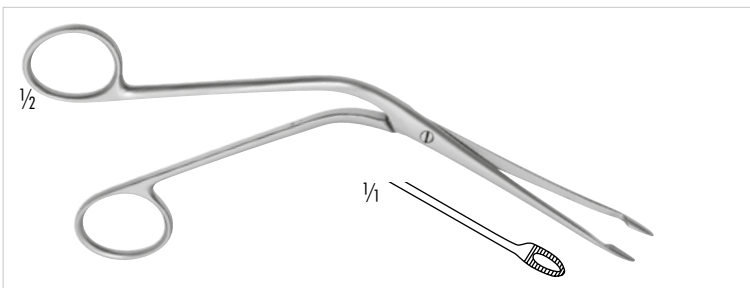

420-211-160

HARTMANN

Nasentamponzange, 175 mm
Nasal dressing forceps, 7 inch

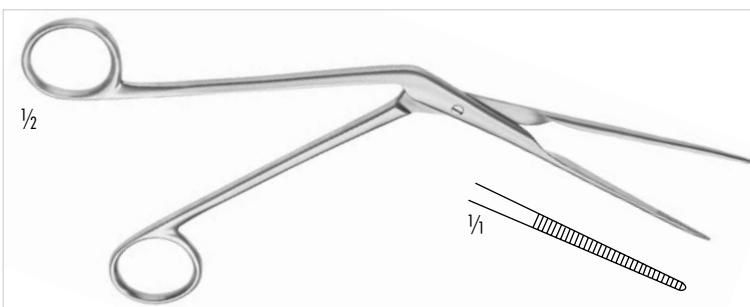

420-411-200

WEST

Nasentamponzange, 200 mm
Nasal dressing forceps, 8 inch

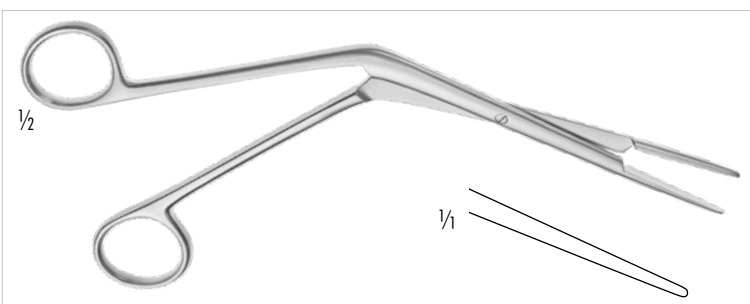

420-210-200

LUBET-BARBON

Nasentamponzange, 200 mm
Nasal dressing forceps, 8 inch

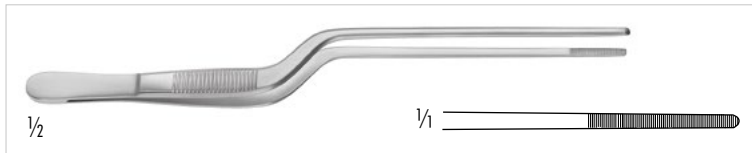

410-389-190

GRUENWALD

Nasenpinzetten, anatomisch, bajonettförmig, 200 mm
Nasal dressing forceps, bayonet shaped, 8 inch

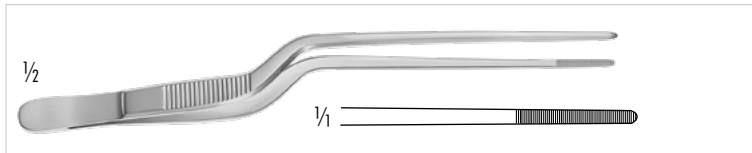

410-395-160

JANSEN

Nasenpinzetten, anatomisch, bajonettförmig, 160 mm
Nasal dressing forceps, bayonet shaped, 6 1/4 inch

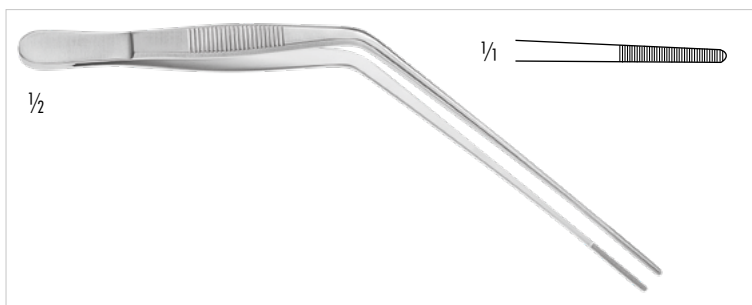

420-375-165

TROELTSCH (WILDE)

Nasenpinzetten, anatomisch, kniegebogen, 170 mm
Nasal dressing forceps, knee bent, 6 3/4 inch



410-228-000

Universal Pulverbläser, mit beweglicher Nasenolive,
Schraubflasche 30 ccm und Halbgebläse
Universal Powder Blower, with adjustable nozzle,
threaded flacon 30 ccm and Rubber Bulb

410-228-100

Halbgebläse allein / Rubber Bulb only

410-228-010

aufsteckbare Nasenolive, allein / Nose guard, only

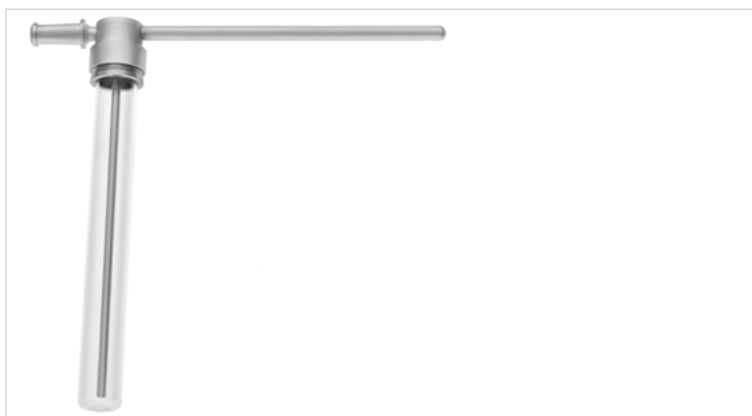

410-229-000

GRUENWALD

Zerstäuber mit gerader Kanüle, 130 mm
Atomizer with straight cannula, 5 1/8 inch

410-229-050

GRUENWALD

Ersatzflacon mit Gewinding
Threaded Spare Bottle only

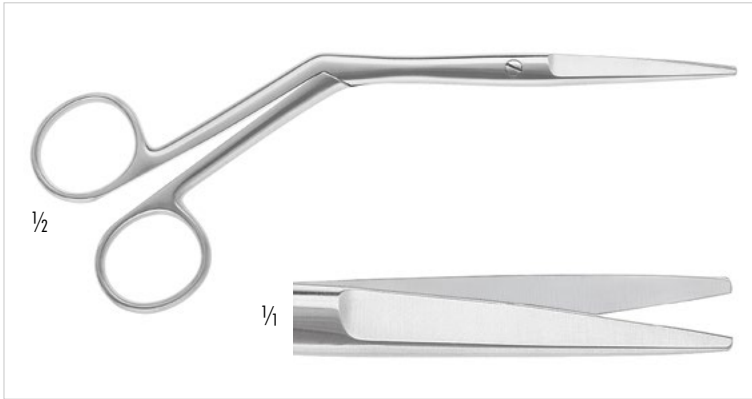

- 120-284-180 gerade/straight
gezahntes oberes Blatt/
serrated upper blade
- 120-287-180 rechts gebogen/right curved
gezahnt/serrated
- 120-285-180 links gebogen/left curved
gezahnt/serrated
- 120-585-180 **TC**, unteres Blatt gezahnt, gerade
TC, lower blade serrated, straight

HEYMANN
Nasenschere, 190 mm,
Nasal scissors, 7 1/2 inch

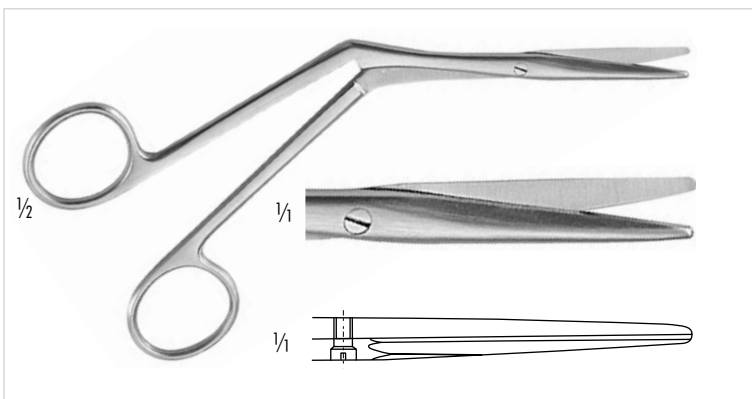

120-283-180
HEYMANN-KNIGHT
Nasenschere, 180 mm
Nasal scissors, 7 inch

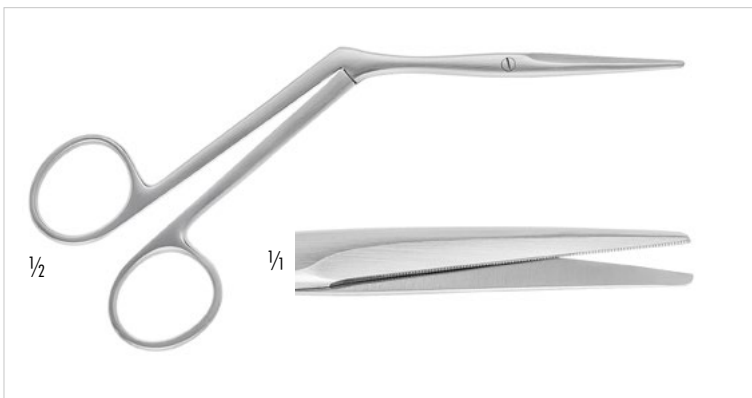

120-285-175
KIRSTEIN
Nasenschere, gezahnt, 180 mm
Nasal scissors, serrated, 7 inch

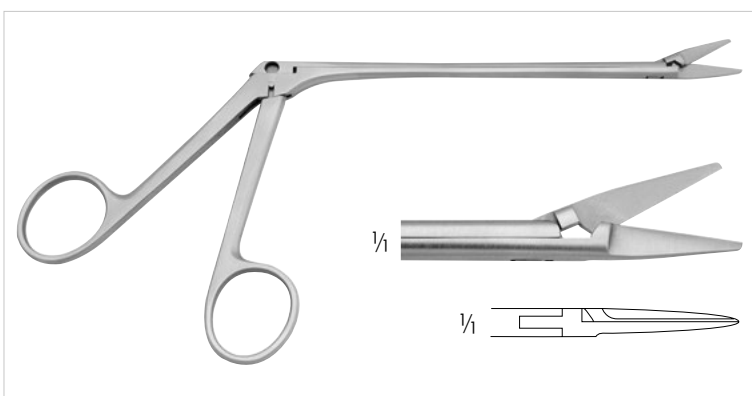

120-208-230
OLIVECRONA
Nasenschere, 230 mm
Nasal scissors, 9 inch

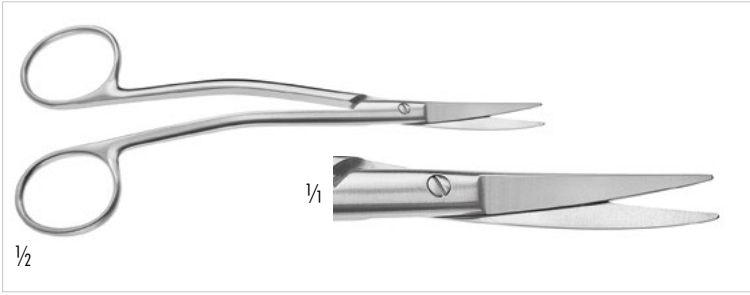

120-306-140
JOSEPH
 Nasenschere, doppelt gebogen, stumpf, 140 mm
 Nasal scissors, double curved, blunt, 5 1/2 inch



420-408-003 3 mm
 420-408-004 4 mm
KRESSNER
 Muschelquetschzangen, 220 mm
 Crushing forceps, 8 3/4 inch

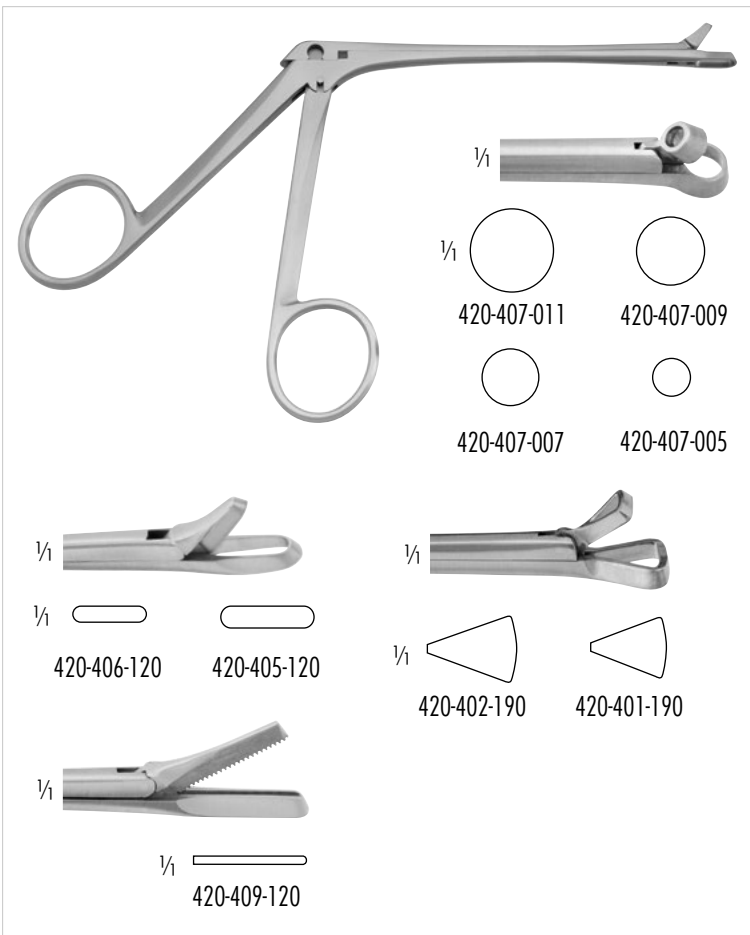

420-407-005 5mm
 420-407-007 7mm
 420-407-009 9mm
 420-407-011 11mm
HARTMANN
 Conchotom, durchschneidend, 120 mm
 Nasal cutting forceps, through cutting, 4 1/2 inch

420-405-120 3,5 x 11mm
 420-406-120 2,0 x 9,5mm

GRUENWALD-HENKE
 Conchotom, durchschneidend
 Nasal cutting forceps, through cutting

420-401-190 Fig. 1
 420-402-190 Fig. 2

SCHMEDEN
 Conchotom, durchschneidend
 Nasal cutting forceps, through cutting

420-409-120
STRUYCKEN
 Conchotom, durchschneidend
 Nasal cutting forceps, through cutting

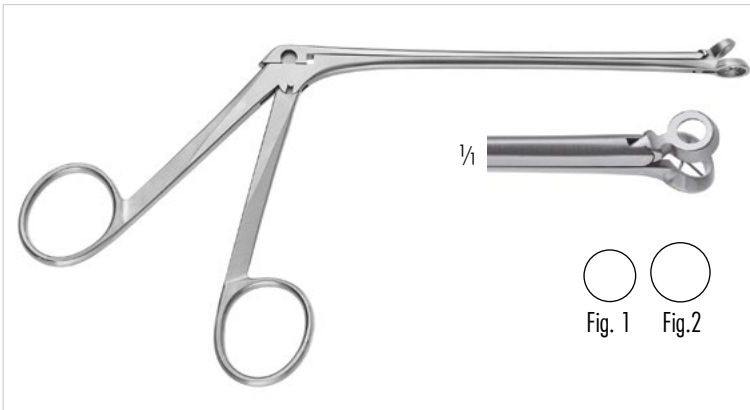

420-401-001 7 mm, Fig.1
420-401-002 8 mm, Fig.2

MELZER

Adenoidzange, durchschneidend, rund, mit Gitter, 140 mm
Adenoid Forceps, through cutting, round, with basket, 140 mm



420-421-001 3 mm Schnitt/3 mm bite Fig.1
420-421-002 3,5 mm Schnitt/3.5 mm bite Fig.2
420-421-003 4 mm Schnitt/4 mm bite Fig.3

GRUENWALD

Nasenzange, durchschneidend, ovaler Schnitt, Arbeitslänge: 115 mm
Nasal Forceps, through cutting, oval bite, Working length: 4 1/2 inch

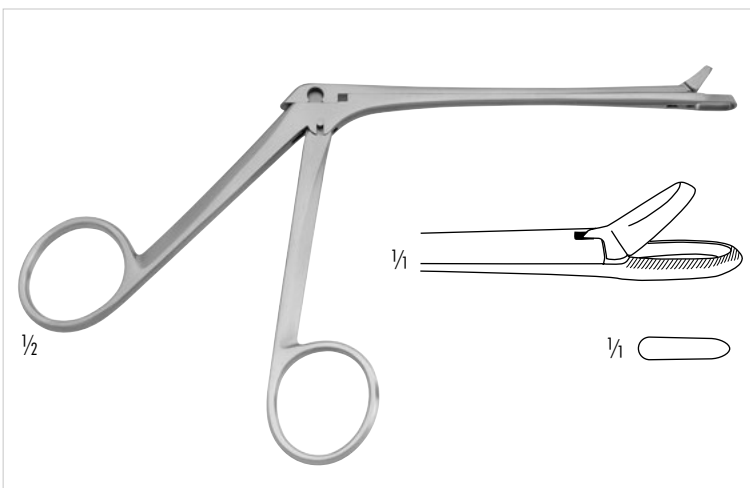

420-410-120

MYLES

Conchotom, durchschneidend, 120 mm
Nasal cutting forceps, through cutting, 4 3/4 inch

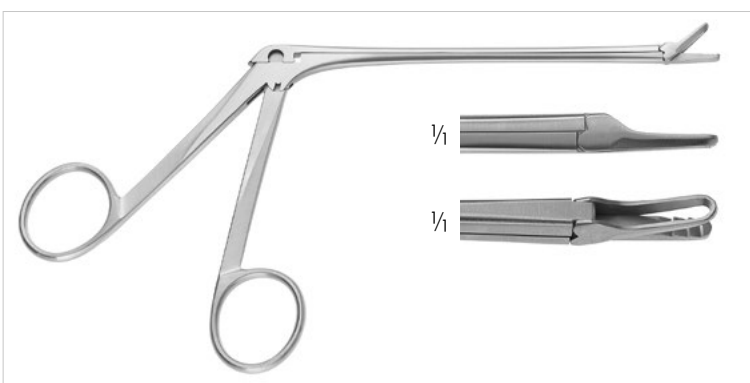

420-410-140

MYLES

Conchotom, durchschneidend, 2,5 x 11,5 mm flaches, gezahntes Maul, Arbeitslänge: 140 mm
Nasal Punch, through cutting, 2.5 x 11.5 mm flat, serrated jaw, Working length: 5 1/2 inch

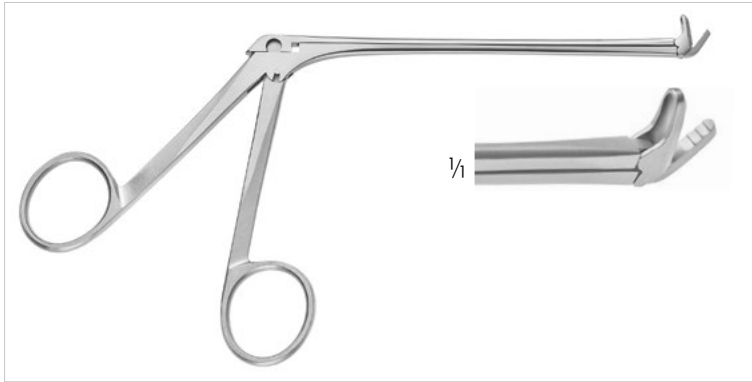

420-413-140

MYLES

Conchotom, durchschneidend, gezahnt, 30° aufgebogen,
Arbeitslänge: 140 mm

Nasal Punch, through cutting, serrated, 30° upcurved shaft,
Working length: 5 1/2 inch

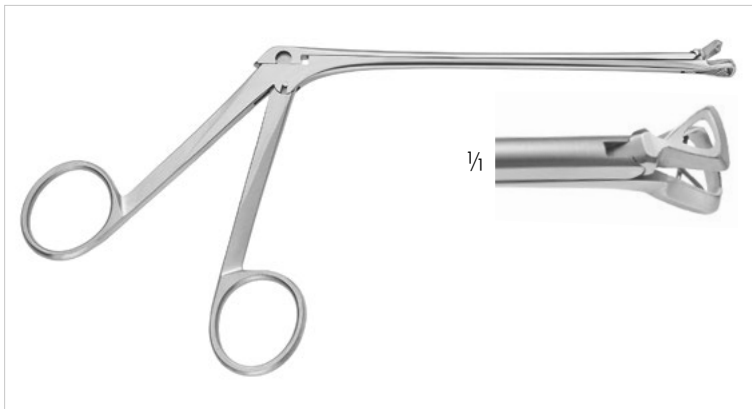

420-401-100 6 mm, Fig.0

420-401-101 7 mm, Fig.1

420-401-102 8 mm, Fig.2

420-401-103 10 mm, Fig.3

MELZER

Adenoidzange, durchschneidend, dreieckig, mit Gitter,
Arbeitslänge: 140 mm

Adenoid Forceps, through cutting, triangular, with basket,
Working length: 5 1/2 inch

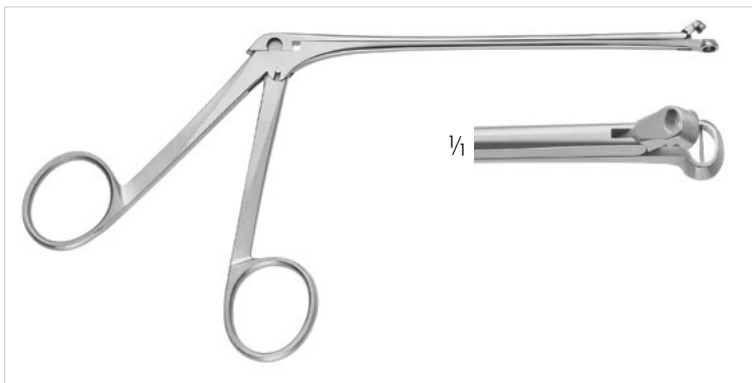

420-401-201 5,2 x 3,2mm Fig.1

MELZER

Adenoidzange, durchschneidend, oval, Arbeitslänge: 140 mm

Adenoid Forceps, through cutting, oval, Working length: 5 1/2 inch



420-414-120 gerade/straight

420-415-120 links gebogen/left curved

420-416-120 rechts gebogen/right curved

Nasenschere, 120 mm

Nasal scissors, 4 3/4 inch

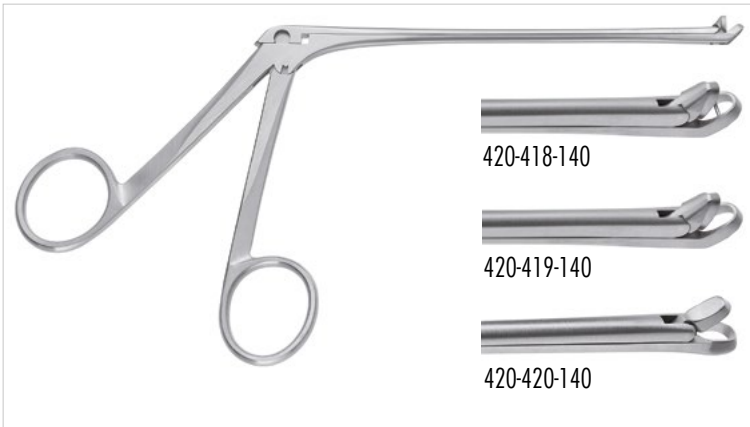

- 420-418-140 Mit Gitter, aufgebogen/
with basket, curved up
- 420-419-140 Ohne Gitter, aufgebogen/
without basket, curved up
- 420-420-140 Ohne Gitter, gerade/
without basket, straight

WATSON-WILLIAMS

Nasenzange, durchschneidend, 3 mm Schnitt,
Arbeitslänge: 140 mm
Nasal Forceps, through cutting, 3 mm bite,
Working length: 5 1/2 inch

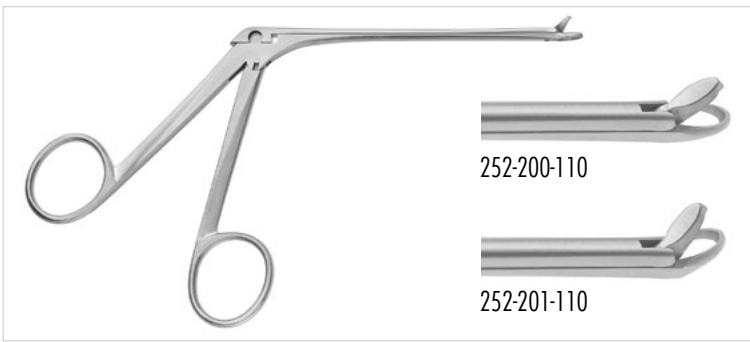

- 252-200-110 2 mm Schnitt, gerade/bite, straight
- 252-200-111 2,5 mm Schnitt, gerade/bite, straight
- 252-200-112 3 mm Schnitt, gerade/bite, straight
- 252-201-110 2 mm Schnitt, aufgebogen/bite, upcurved
- 252-201-111 2,5 mm Schnitt, aufgebogen/bite, upcurved
- 252-201-112 3 mm Schnitt, aufgebogen/bite, upcurved

BLAKESLEY

Nasenzange, durchschneidend, 115 mm
Nasal Forceps, through cutting, 4 1/2 inch

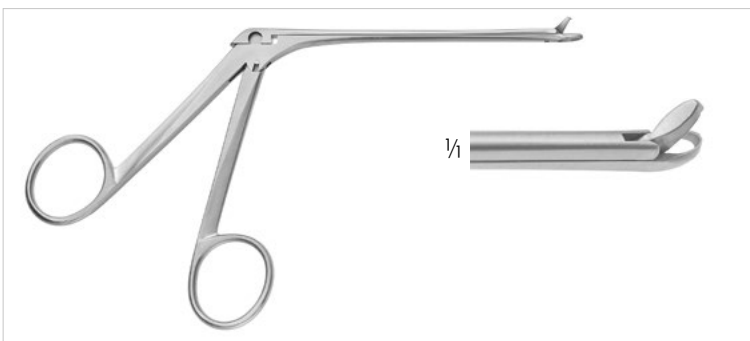

- 252-202-111 Fig.1 links gebogen/left curved jaw
- 252-203-111 Fig.2 rechts gebogen/right curved jaw

BLAKESLEY

Nasenzange, durchschneidend, 2,5mm Schnitt, 115mm
Nasal Forceps, though cutting, 2.5mm cut, 4 1/2 inch



- 252-477-141 rückwärts öffnend/backward cutting
- 252-477-142 links öffnend/left side cutting
- 252-477-143 rechts öffnend/right side cutting

NICOLAI

Stirnhöhlezange 2mm Schnitt, 65° aufgebogen
Antrum Forceps, 2mm bite, 65° angled upwards



252-526-115 **NOYES** gefenstert/fenestrated
1x2 Zähne/teeth

252-527-115 **NOYES** gefenstert/fenestrated

252-528-115 **MORGENSTEIN**

252-529-115 **BLAKESLEY**

252-530-115 **FERRIS-SMITH**

Nasenzange mit Querzähnen, Arbeitslänge: 115 mm

Nasal Forceps with serrated jaws, Working length: 4 1/2 inch

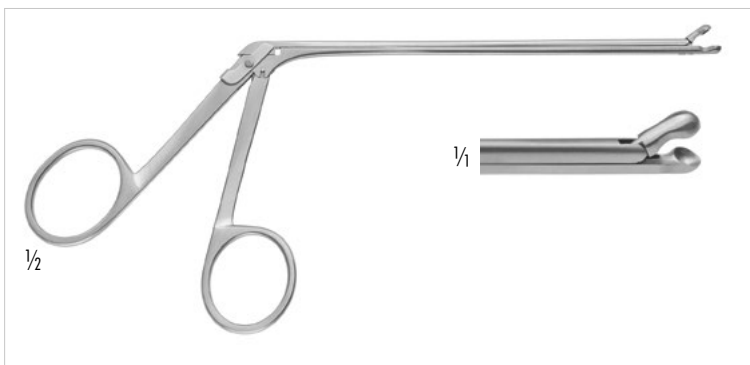

420-223-170

HILDYARD

Löffelzängchen, 3,5 mm Löffel, 120 mm Schaftlänge,
Arbeitslänge: 120 mm

Post-Nasal Biopsy Forceps, 3.5 mm biopsy cup, shaft

Working length: 4 3/4 inch



252-539-115

LEWIS

Nasenzange seitlich links öffnend, Arbeitslänge: 115mm

Nasal Forceps, round grooved jaws, opening to left side,

Working length: 4 1/2 inch

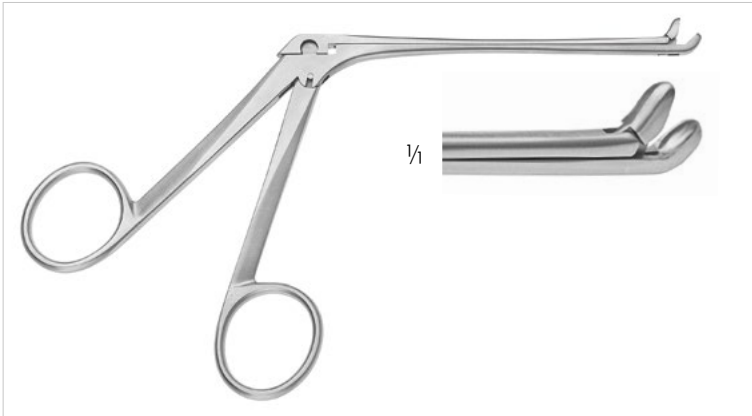

252-425-115

BEAD

Bead Nasenzange mit Löffel, aufgebogen, kleines Modell, Arbeitslänge: 115mm

Nasal Forceps with cup jaws, upturned, small model, Working length: 4 1/2 inch

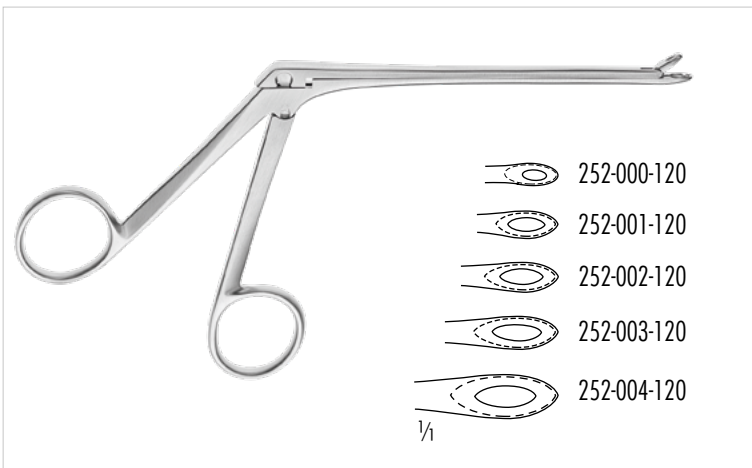

- 252-000-120 Fig.0 3,0 mm
- 252-001-120 Fig.1 3,6 mm
- 252-002-120 Fig.2 4,2 mm
- 252-003-120 Fig.3 4,8 mm
- 252-004-120 Fig.4 5,6 mm

WEIL-BLAKESLEY

Siebbeinzangen, gerade, ovaler Löffel, gefensterter Maul, 120 mm

Ethmoidal forceps, straight, oval, cup-shaped fenestrated jaws, 4 3/4 inch

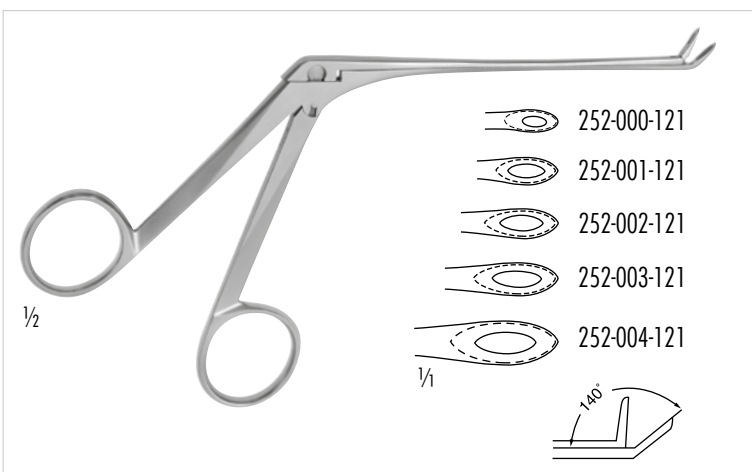

- 252-000-121 Fig.0 3,0 mm
- 252-001-121 Fig.1 3,6 mm
- 252-002-121 Fig.2 4,2 mm
- 252-003-121 Fig.3 4,8 mm
- 252-004-121 Fig.4 5,6 mm

WEIL-BLAKESLEY

Siebbeinzangen, aufgebogen, ovaler Löffel, gefensterter Maul, 110 mm

Ethmoidal forceps, upwards curved, oval cup, fenestrated jaws, 4 1/2 inch



252-000-111

STRUEMPEL-VOSS

Siebbeinzange 45° aufgebogen, besonders fein, 2,5mm
110 mm Schaft

Ethmoidal forceps, 45° upwards curved, oval, very delicate, 2.5mm
110 mm shaft

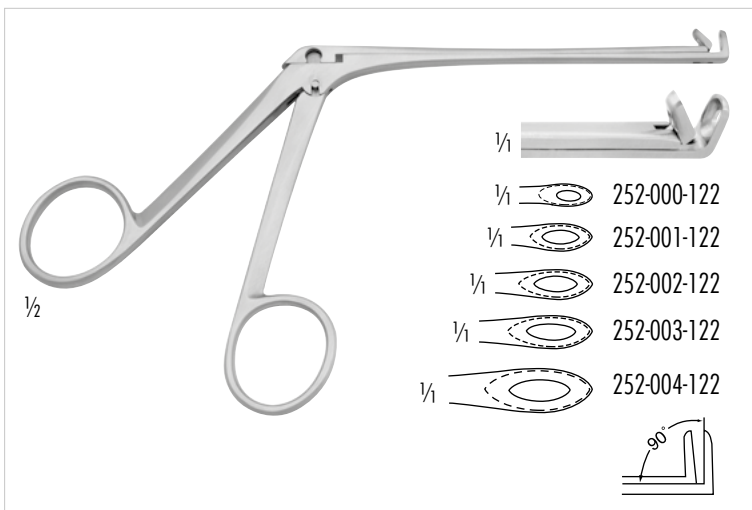

252-000-122 Fig.0 3,0 mm

252-001-122 Fig.1 3,6 mm

252-002-122 Fig.2 4,2 mm

252-003-122 Fig.3 4,8 mm

252-004-122 Fig.4 5,6 mm

WEIL-BLAKESLEY

Siebbeinzange, 90° aufgewinkelt, 110 mm
Ethmoidal forceps, 90° angled up, 4 1/2 inch



0°

252-035-150 Größe/Size 1: 3,5mm

252-040-150 Größe/Size 2: 4,0mm

252-050-150 Größe/Size 3: 5,0mm

45°

252-035-151 Größe/Size 1: 3,5mm

252-040-151 Größe/Size 2: 4,0mm

90°

252-035-152 Größe/Size 1: 3,5mm

252-040-152 Größe/Size 2: 4,0mm

BLAKESLEY

Nasenzange, Arbeitslänge: 150mm Arbeitslänge:
Nasal Forceps, working length: 6 inch

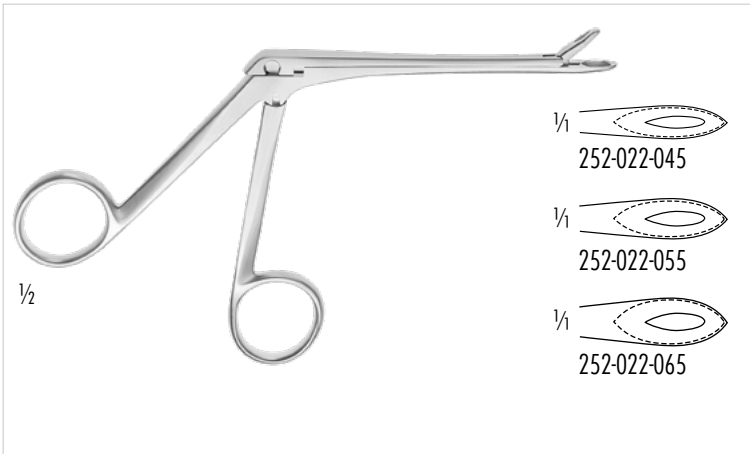

252-022-045 4,5 mm
 252-022-055 5,5 mm
 252-022-065 6,5 mm

TILLEY HENCKEL

Siebbeinzange, gerade, Schaft graduert, 115 mm
 Ethmoidal forceps, straight, shaft graduated, 4 1/2 inch



252-410-130 2 mm, gerade/straight
 252-410-131 3 mm, gerade/straight
 252-413-131 3 mm, aufgebogen/curved up

TAKAHASHI

Siebbeinzange, oval, Löffelmaul, 120 mm
 Ethmoidal forceps, oval, cup-shaped, 4 3/4 inch



252-534-100
 Siebbeinzange, gerade, 140 mm
 Ethmoidal forceps, straight, 5 1/2 inch



252-530-120
WATSON-WILLIAMS
 Schleimhaut Faßzange, gezahnt, gerade, 120 mm
 Ethmoidal mucosa forceps, serrated jaws, straight, 4 3/4 inch

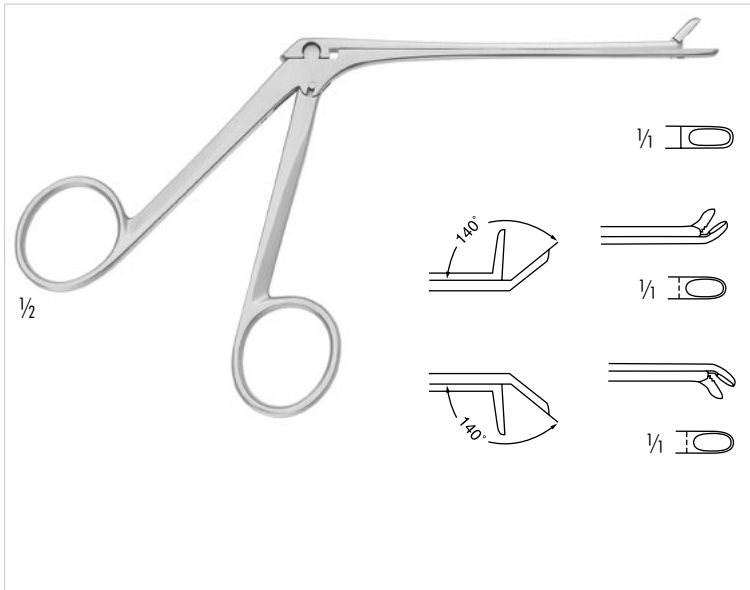

- 252-536-115 gerade/straight
- 252-537-115 aufgebogen/curved up
- 252-538-115 abgebogen/curved down

ST BARTS

Rongeur, 3 mm, 110 mm
 Rongeur, 3 mm, 4 1/3 inch

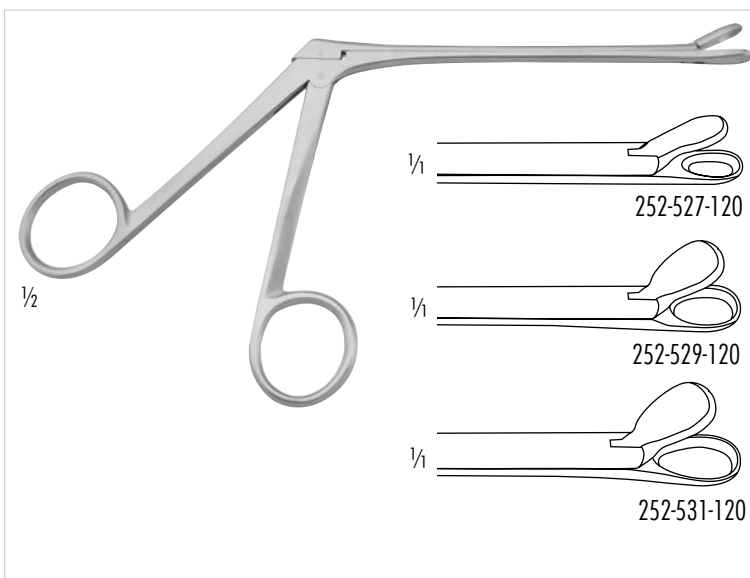

- 252-527-120 Fig.0
- 252-529-120 Fig.1
- 252-531-120 Fig.2

WATSON-WILLIAMS

Siebbeinzange, 115 mm
 Ethmoidal forceps, 4 1/2 inch

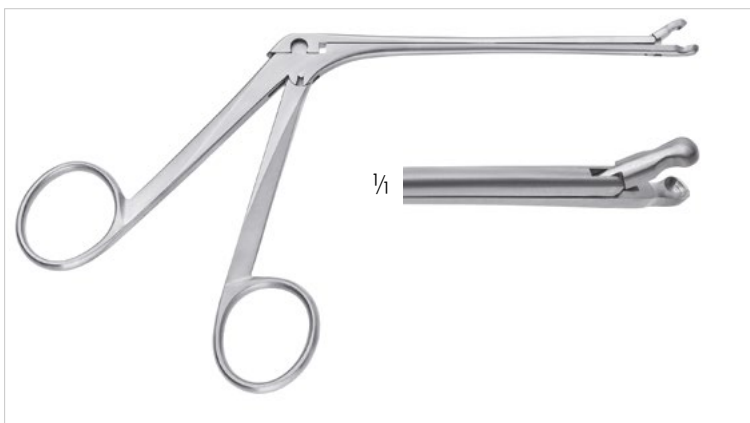

252-426-100 Ø 3.5 mm
 Nasenzange mit rundem Löffel, 115 mm
 Sinus Cup Forceps, 4 1/2 inch

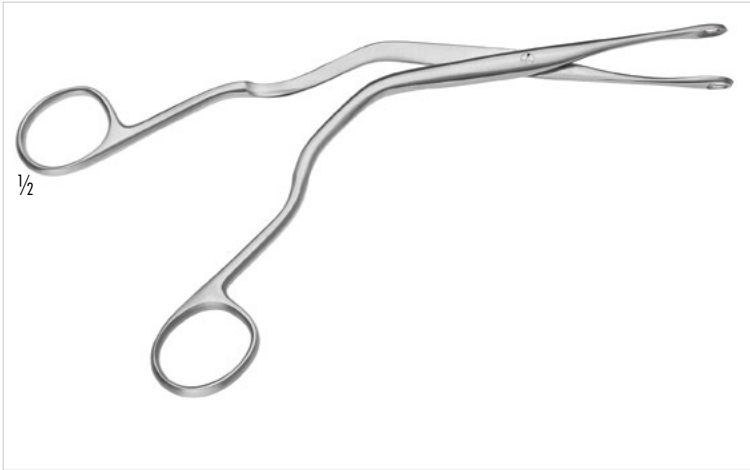

- 420-400-001 6,0 mm
- 420-400-002 7,5 mm
- 420-400-003 9,0 mm

LUC

Septumzange, gefenstert, 190 mm
Septum forceps with fenestrated jaws, 7 1/2 inch

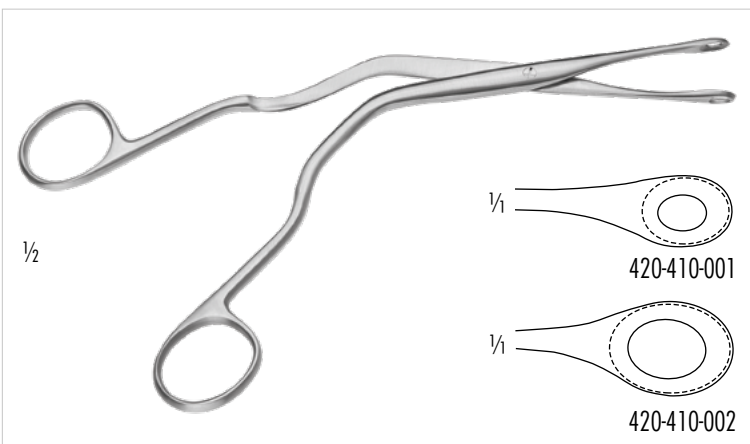

- 420-410-001 Fig. 1
- 420-410-002 Fig. 2

LUC

Septumzange, gefenstert, 200 mm
Septum forceps with fenestrated jaws, 8 inch

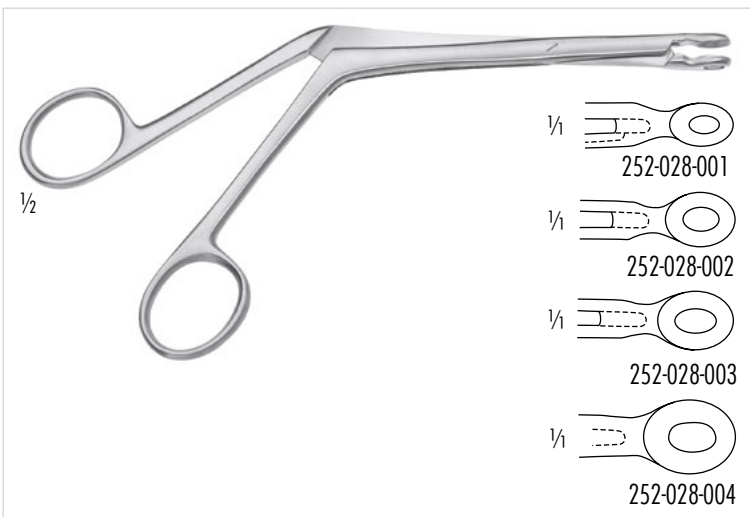

- 252-028-001 Größe/Size 1
- 252-028-002 Größe/Size 2
- 252-028-003 Größe/Size 3
- 252-028-004 Größe/Size 4

BRUENINGS

Septumzange, gefenstert, 190 mm
Septum forceps, fenestrated jaws, 7 1/2 inch



- 252-029-000 6mm

CRAIG

Vormerzange, gerade, scharfer Löffel oval, 165 mm
Septum bone cutting and breaking forceps straight, sharp cup, 6 1/2 inch

- 252-029-165 6mm

CRAIG

Vormerzange mit eckigen Schneidkanten, 165 mm
Septum bone cutting and breaking forceps straight, sharp cup, 6 1/2 inch

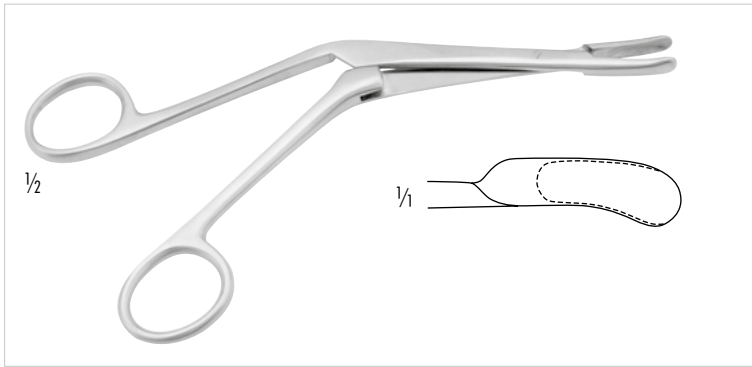

252-029-500

CRAIG-DOMNICK

Vormerzange, linksgebogen, scharfe Löffel, 165 mm
 Septum bone cutting and breaking forceps, curved to the left,
 sharp cup, 6 1/2 inch

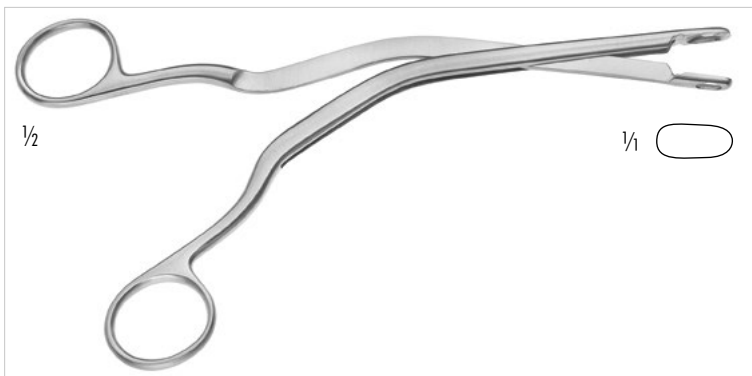

420-412-190

IRWIN MOORE

Septumzange, 190 mm
 Septum forceps, 7 1/2 inch



420-422-190

HEYMANN-KNIGHT

Septumzange, scharfer ovaler Löffel, 190 mm
 Septum forceps, with sharp oval cup, 7 1/2 inch



420-214-180

KNIGHT

Nasenzange, scharf, 180 mm
 Nasal forceps, sharp, 7 inch



252-031-190 4x14 mm großes Modell / large pattern
252-033-190 3x13 mm kleines Modell / small pattern

JANSEN-MIDDLETON

Nasenzange, durchschneidend, 210 mm
Nasal forceps, through cutting, 8 1/4 inch



252-032-190 4x11 mm

JANSEN-MIDDLETON

Nasenzange, Löffelmaul, 170 mm
Nasal forceps, cup-shaped, 6 3/4 inch



420-213-180

BECKER

Septumschere mit Doppelgelenk, gezahnt, 180 mm
Septum scissors, double action, with serrated jaws, 7 inch



120-286-220 gerade Schneide/straight cutting edge

CAPLAN

Nasenschere, 220 mm
Nasal scissors, 8 1/2 inch

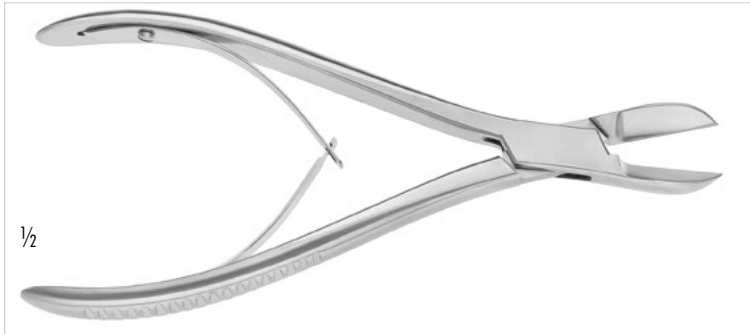

210-845-185

COTTLE-KAZANJIAN

Knochensplitterzange, zum Entfernen eines Nasenhöckers, 180 mm
 Bone cutting forceps, for removal of nasal hump, 7 inch

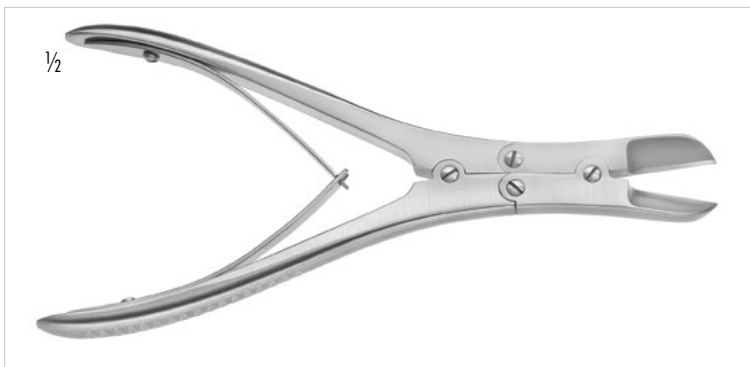

210-855-180

RUSKIN-ROWLAND

Nasenzange mit Doppelgelenk, gerade, 180 mm
 Nasal hump rongeur, double action, straight, 7 inch



420-370-210

RUBIN

Knorpelquetschzange mit Doppelgelenk, gerade, 220 mm
 Septum morcelizer, double action, straight, 8 1/2 inch



420-371-210

RUBIN

Knorpelquetschzange mit Doppelgelenk, abgewinkelt, 220 mm
 Septum morcelizer, double action, angled, 8 1/2 inch

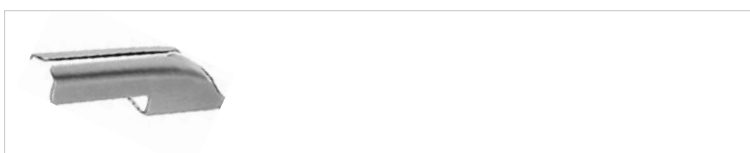

420-370-212

Schutzkappe für RUBIN Quetschzange 420-370-210 + 420-371-210
 Protection cap for RUBIN septum morcelizer
 420-370-210 + 420-371-210

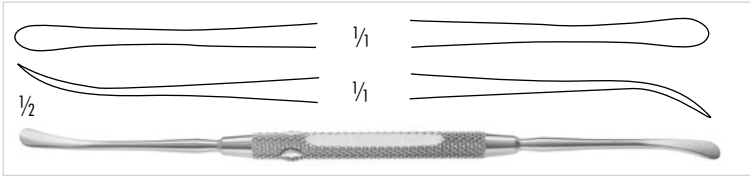

420-546-180 5 mm

FREER

Elevatorium, scharf/stumpf, 185 mm
Elevator, sharp /blunt, 7 1/4 inch

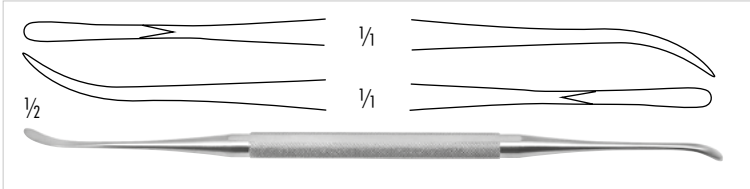

420-548-180

FREER-YASARGIL

Dissektor, scharf, 190 mm
Dissector, sharp, 7 1/2 inch



210-528-240

COHEN

Elevator, doppelendig, 240mm
Elevator, double-ended, 9 1/2 inch



420-556-200

WOODSON

Elevator, 2,4 / 4,0mm Blatt, 200mm
Elevator, 2.4 / 4.0mm blade, 8 inch

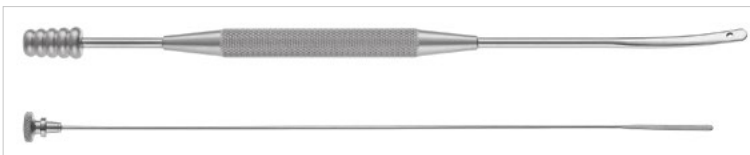

420-395-205 6 mm

NEGUS

Saugdissektor, stumpf 210 mm
Suction dissector, blunt, 8 1/4 inch

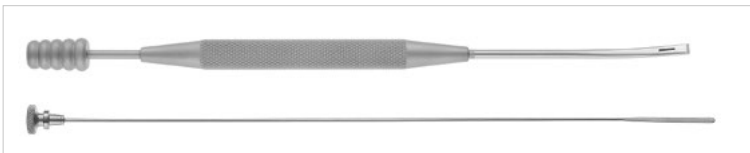

420-253-185 3 mm

GORNEY

Saugraspatorium, halb-scharf 180 mm
Suction raspatory, semi-sharp 7 inch

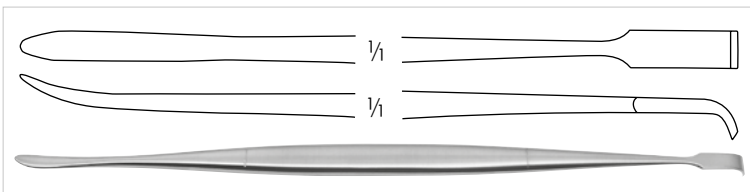

420-552-215

HOWARTH

Doppel-Elevatorium, 215 mm
Elevator, double-ended, 8 1/4 inch

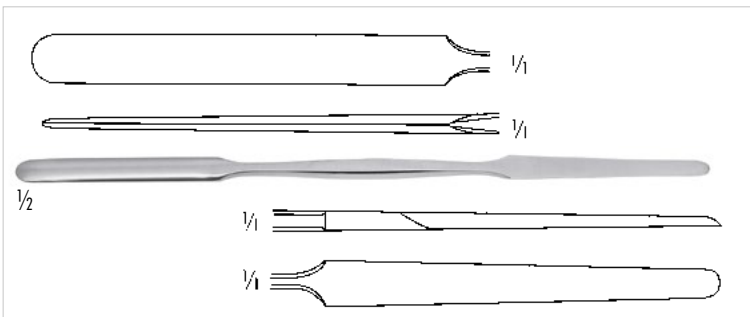

420-541-180

KILLIAN

Doppel-Elevatorium, scharf/stumpf, 185 mm
Elevator, double-ended, sharp/blunt, 7 1/4 inch

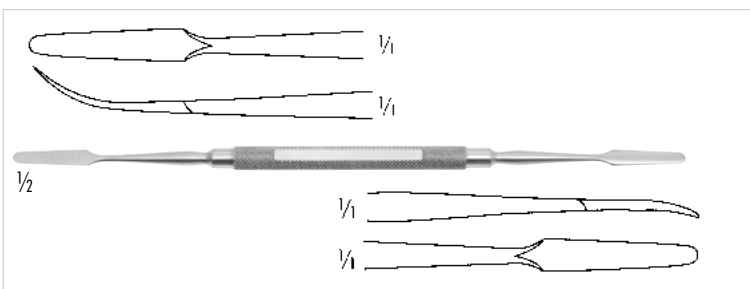

420-540-180

KILLIAN

Doppel-Elevatorium, scharf/stumpf, 180 mm
Elevator, double-ended, sharp/blunt, 7 inch



252-002-180

KILLIAN

Doppel-Elevatorium, schiffenförmig, scharf/stumpf, 180 mm
Septum double-ended elevator, shuffle-shaped, sharp/blunt, 7 inch



252-001-200

FREER

Doppel-Elevatorium, halbscharf/stumpf, 200 mm
Septum double-ended elevator, semi-sharp/blunt, 8 inch

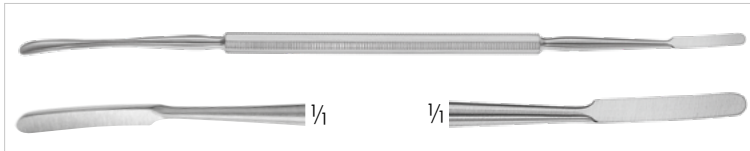

420-555-200

FREER-JOSEPH

Doppel-Elevatorium, 200 mm
Septum double-ended elevator, 8 inch



420-551-200

MASING

Elevatorium, doppelendig, graduert, scharf/stumpf, 200 mm
Elevator, double-ended, graduated, sharp/blunt, 8 inch



420-550-230

COTTLE

Doppel-Elevatorium, graduert, scharf/stumpf, 210 mm
Elevator, double-ended, graduated, sharp/blunt, 8 1/4 inch

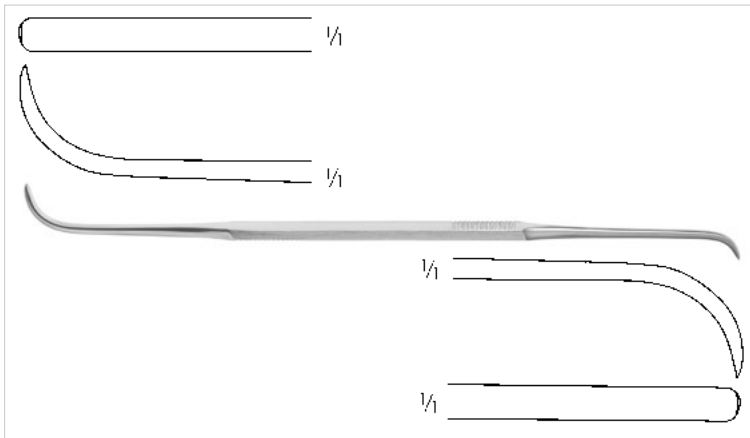

420-552-200

COTTLE

Doppel-Elevatorium, zum Tunnelieren, 220 mm
Elevator, double-ended, for tunneling, 9 inch

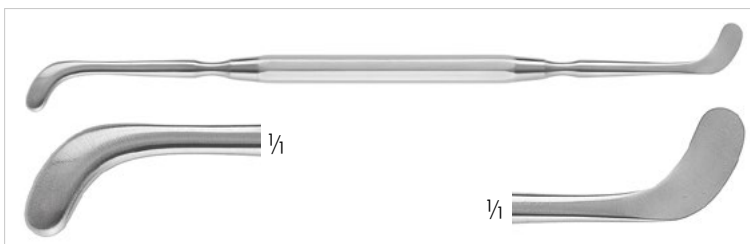

420-543-210

PENNINGTON

Elevatorium, 210 mm
Elevator, 8 1/4 inch



420-551-175

FREER

Raspatorium, doppelendig, scharf, 175 mm
Periosteal elevator, double-ended, sharp, 7 inch

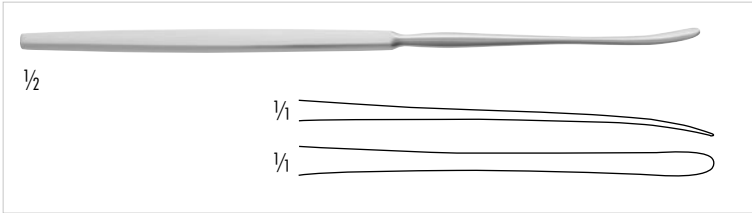

420-544-165 4,0 mm
HALLE
 Elevatorium, stumpf, 180 mm
 Elevator, blunt, 7 inch

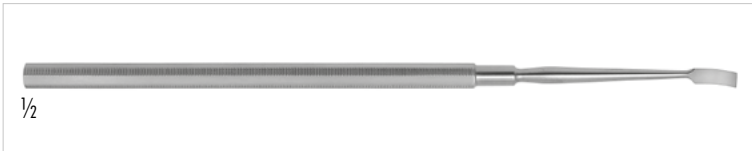

420-551-180 4 mm
FREER
 Raspatorium, 160 mm
 Periosteal elevator, 6 1/2 inch

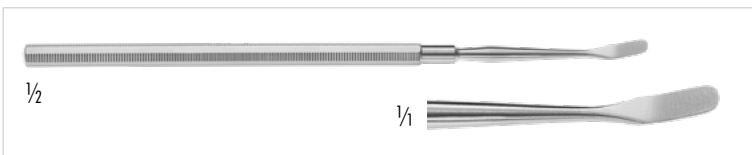

420-557-165 4,0 mm
 Raspatorium, abgewinkelte Spitze, 165 mm
 Periosteal elevator, angled tip, 6 1/2 inch

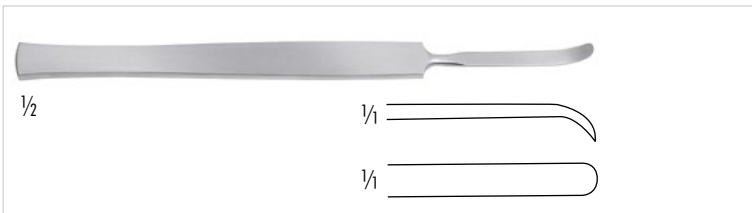

420-547-004 4 mm
 420-547-005 5 mm
MC KENTY
 Septum Elevatorium, gebogen, scharf, 155 mm
 Septum periosteal elevator, curved, sharp, 6 inch



420-547-006
ERLANGEN
 Raspatorium, 6mm breit, leicht gebogen, 175 mm
 Raspatory, 6mm wide, slightly curved, 7 inch

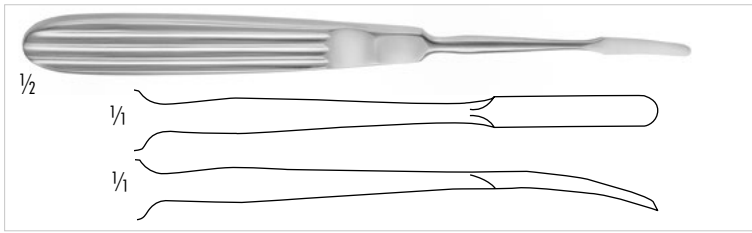

- 420-530-165 2 mm
- 420-531-165 3 mm
- 420-532-165 4 mm
- 420-533-165 5 mm

JOSEPH

Periost-Raspatorium, leicht gebogen, 170 mm
 Periosteal elevator, slightly curved, 6 3/4 inch

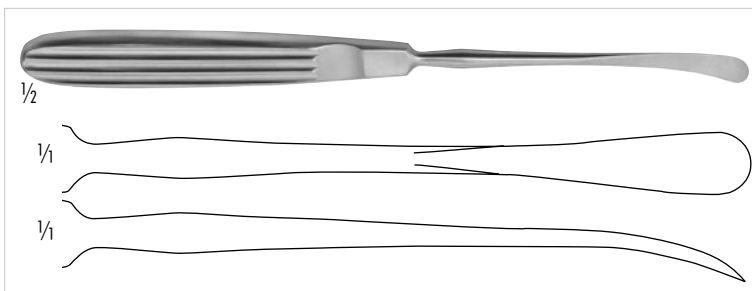

- 210-438-195 8 mm

COTTLE

Elevatorium, gebogen, scharf, 190 mm
 Elevator, curved, sharp, 7 1/2 inch

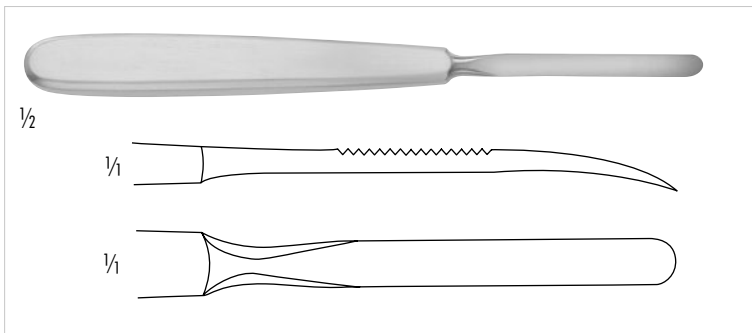

- 210-439-006 6 mm
- 210-439-008 8 mm

Periost-Raspatorium, leicht gebogen, 170 mm
 Periosteal elevator, slightly curved, 6 3/4 inch

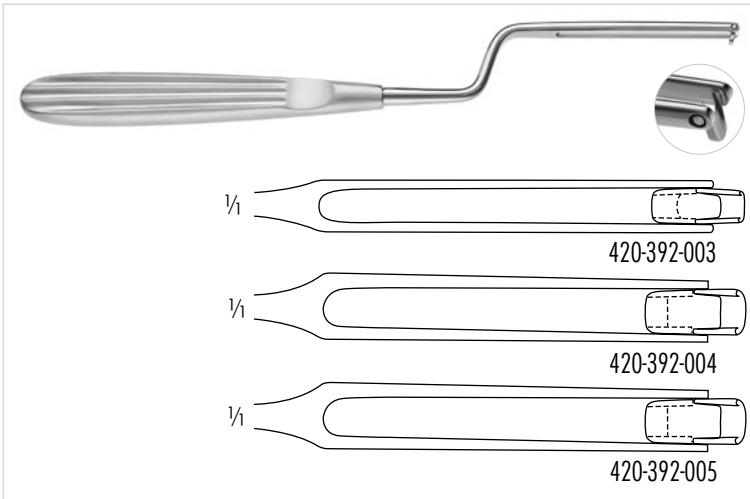

420-392-003 3 mm
 420-392-004 4 mm
 420-392-005 5 mm

BALLENGER

Schwingmesser, bajonettförmig, 210 mm
 Swivel knife, bayonet shaped, 8 ¼ inch

420-393-003 3 mm
 420-393-004 4 mm
 420-393-005 5 mm

BALLENGER

Schwingmesser, gerade, 195 mm
 Swivel knife, straight, 8 inch

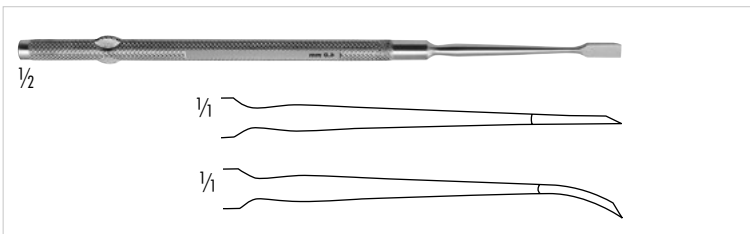

420-590-004 4 mm, gerade/straight
 420-591-004 4 mm, gebogen/curved

FREER

Septum Flachmeissel, 160 mm
 Septum chisel, 6 ¼ inch

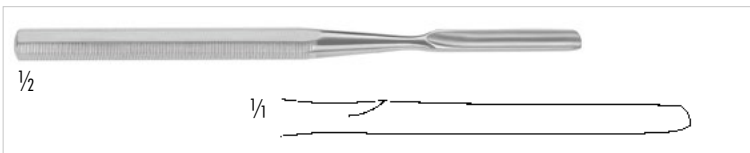

420-550-170 6 mm

FREER

Septum-Hohlmeissel, mit runder Schneide, gerade, 150 mm
 Septum gouge, straight, round cutting edge, 6 inch

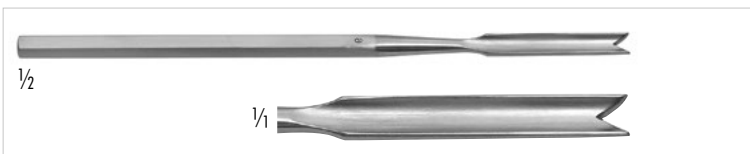

420-595-170 6 mm

BALLENGER

Septum-Hohlmeissel mit Kerbe, gerade, 155 mm
 Septum gouge, with notch and cutting edge, 6 inch

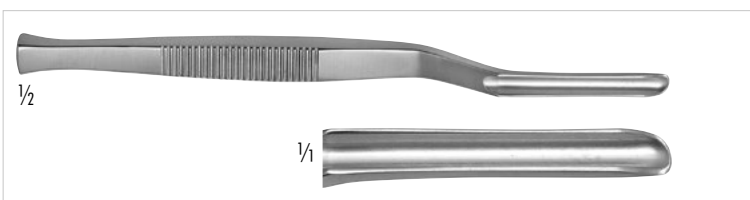

420-552-170 6 mm

KILLIAN

Septum-Hohlmeissel mit runder Schneide, bajonettförmig gebogen, 170 mm
 Septum gouge, round cutting edge, bayonet shaped, 6 ¾ inch

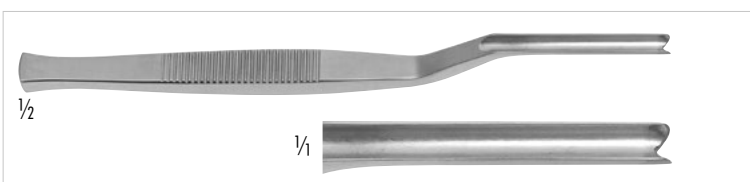

420-551-170 6 mm

KILLIAN-CLAUS

Septum-Hohlmeissel mit Kerbe, bajonettförmig gebogen, 170 mm
 Septum gouge with notch, bayonet shaped, 6 ¾ inch

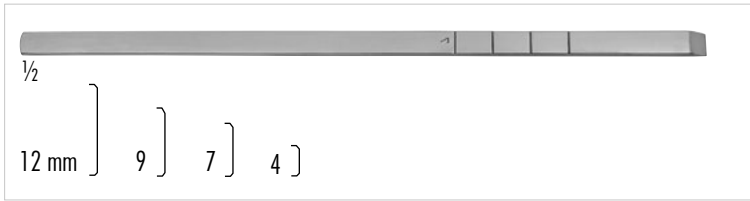

- 210-488-004 4 mm
- 210-488-007 7 mm
- 210-488-009 9 mm
- 210-488-012 12 mm

COTTLE

Flachmeissel, graduiert, 185 mm
Chisel, graduated, 7 1/4 inch

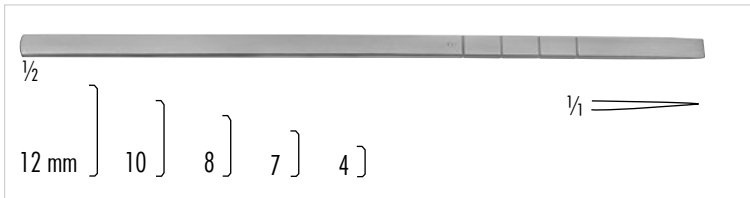

- 210-487-004 4 mm
- 210-487-007 7 mm
- 210-487-008 8 mm
- 210-487-010 10 mm
- 210-487-012 12 mm

COTTLE

Osteotom, graduiert, 180 mm
Osteotome, graduated, 7 inch

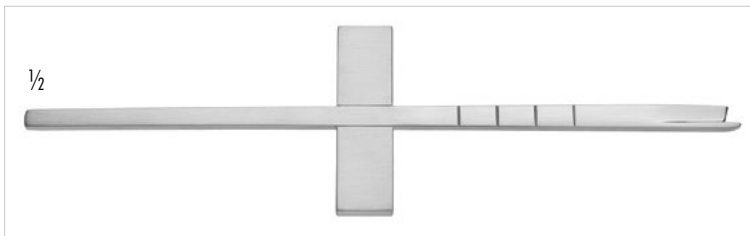

- 210-472-105 5mm

COTTLE

Osteotom mit Schutz und Crossbar, 185m
Osteotome with guard and crossbar, 7 1/4 inch

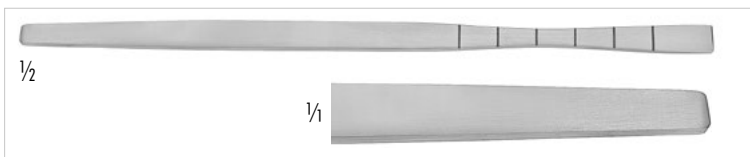

- 210-486-008 8 mm

COTTLE

Fischschwanz Osteotom, verrundete Ecken 180 mm
Fishtail osteotome, with protected ends, double guarded 7 inch



- 210-486-016

COTTLE

Fischschwanz Osteotom, mit Querbalken, 16mm,
runde Schneidkanten, 180mm
Fishtail osteotome, with crossbar, 16mm
with round cutting end, 7 inch

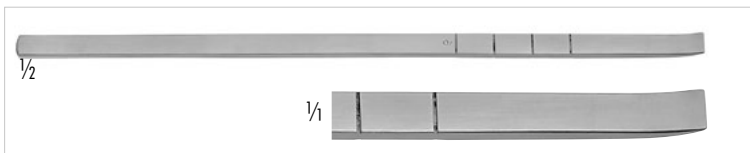

- 210-486-006 6 mm

COTTLE

Flachmeissel, gebogen, graduiert, für transversale Osteotomie, 180 mm
Chisel, curved, graduated, for transverse osteotomies, 7 inch

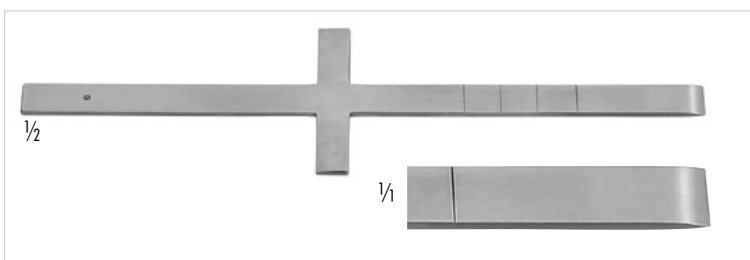

- 210-472-006 6 mm

COTTLE

Osteotom, gerade, 185 mm
Osteotome, straight, 7 1/4 inch

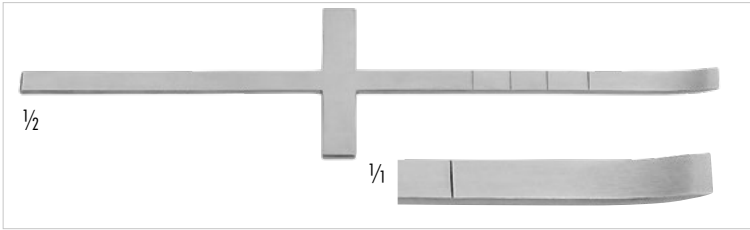

210-473-006 6 mm
COTTLE
 Osteotom, gebogen, 185 mm
 Osteotome, curved, 7 1/4 inch

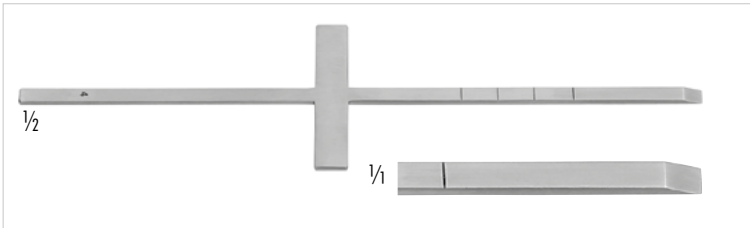

210-474-006
COTTLE
 Meißel, gerade, 6 mm, 185 mm
 Chisel, straight, 6 mm, 7 1/4 inch



420-587-008 8 mm
 420-587-010 10 mm
 420-587-012 12 mm
 420-587-014 14 mm
 420-587-016 16 mm
RUBIN
 Osteotom, 167 mm
 Osteotome, 6²/₃ inch



420-589-008 8 mm
 420-589-010 10 mm
 420-589-012 12 mm
 420-589-014 14 mm
 420-589-016 16 mm
CINELLI
 Osteotom, mit doppelter Führung, gerade, 160 mm
 Osteotome, double guarded, straight, 6 1/4 inch



420-587-177 6,5 mm
PARKES
 Höcker Hohlmeißel, 180 mm
 Hump gouge, 7 inch



420-459-001 gerade/straight
 420-459-002 rechts gebogen/curved right
 420-459-003 links gebogen/curved left
SILVER
 Nasenmeißel, 180mm
 Nasal Chisel, 7 inch



420-460-001 gerade/straight
420-460-002 links/left
420-460-003 rechts/right

SILVER

Osteotom, schmales Modell, 185 mm
Osteotome, slender model, 7 1/4 inch



420-639-001 gerade/straight
420-639-002 rechts gebogen/curved right
420-639-003 links gebogen/curved left

ANDERSON-NEIVERT

Osteotom, 205 mm, 3,5 mm
Osteotome, 8 inch, 3.5 mm



420-641-001 gerade/straight
420-641-002 rechts/right
420-641-003 links/left

GUNTER

Osteotom, 205 mm
Osteotome, 8 inch



420-472-002 links/left
420-472-003 rechts/right

GUASTELLA

Osteotom, 180 mm
Osteotome, 7 inch



420-460-005

SILVER

Osteotom mit V-Spitze, gebogen, 175 mm
Osteotome with V-tip, curved, 6 3/4 inch



420-491-001 links gebogen/curved left
420-491-002 rechts gebogen/curved right
420-491-000 gerade/straight

FRENCHAY

Nasenmeißel, mit Führung, 180 mm
Nasal Chisel, with guard, 7 inch



420-586-004 4mm 420-586-006 6mm
420-586-005 5mm 420-586-007 7mm

FOMON

Meißel, 170 mm
Chisel, 6 3/4 inch



420-458-160

PARKES

Osteotom, mit einseitigem Schutz, 160 mm
Osteotome with single guard, 6 1/3 inch



420-470-001 gerade/straight
420-470-002 rechts gebogen/curved right
420-470-003 links gebogen/curved left

RISTOW

Osteotom, 200 mm
Osteotome, 8 inch

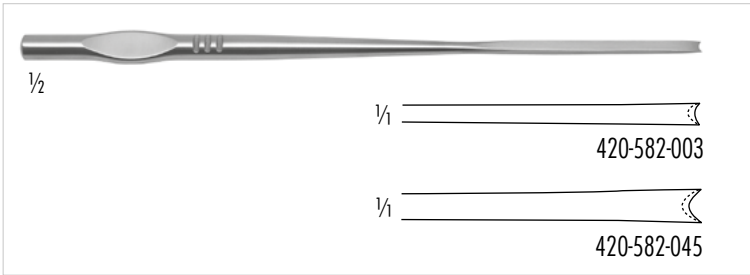

420-582-003 3,0 mm
420-582-045 4,5 mm

WALTER

Flachmeißel mit Hohlkehle, Spitzen verrundet, 190 mm
Chisel with notch, double guarded, 7 1/2 inch

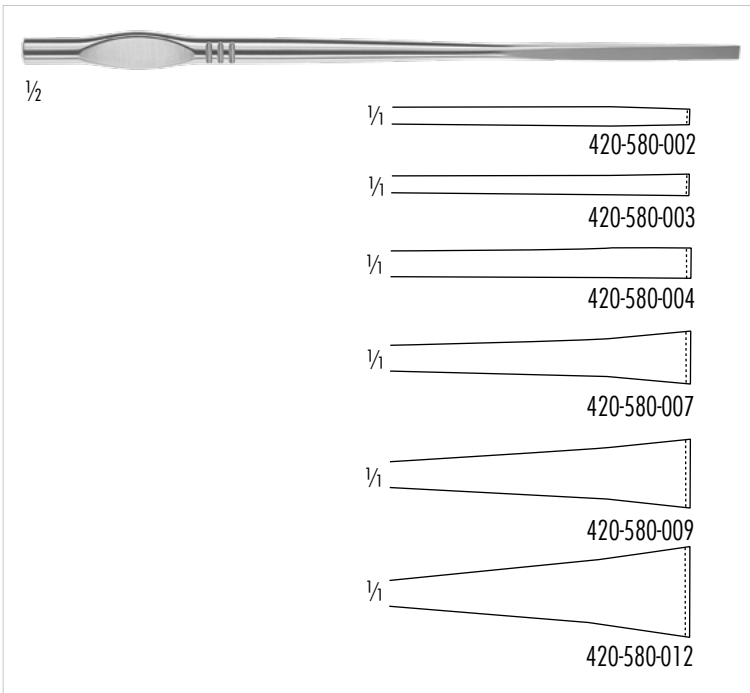

420-580-002 2,0 mm
420-580-003 3,0 mm
420-580-004 4,0 mm
420-580-007 7,0 mm
420-580-009 9,0 mm
420-580-012 12,0 mm

WALTER

Osteotom, 190 mm
Osteotome, 7 1/2 inch



420-568-002 2 mm
420-568-003 3 mm
420-568-004 4 mm
420-568-005 5 mm
420-568-006 6 mm
420-568-008 8 mm
420-568-010 10 mm

RZ-OSTEOTOME

Osteotom, 180 mm
Osteotome, 7 inch



420-572-002 2 mm
420-572-003 3 mm
420-572-004 4 mm
420-572-005 5 mm
420-572-010 10 mm
420-572-011 11 mm
420-572-012 12 mm

CONVERSE

Osteotom mit Stabilisierung, 180 mm
Osteotome with stabilizer, 7 inch



420-573-001 gerade/straight
 420-573-002 links/left
 420-573-003 rechts/right

CONVERSE

Meißel mit Schutz, 190mm
 Chisel with single guard, 7¹/₂ inch



420-500-200 3,0 mm

REES

Osteotom, mit Aluminium Handgriff, 200 mm
 Osteotome, with aluminum handle, 8 inch



420-594-002	2 mm	420-594-007	7 mm
420-594-003	3 mm	420-594-008	8 mm
420-594-004	4 mm	420-594-010	10 mm
420-594-005	5 mm	420-594-012	12 mm
420-594-006	6 mm	420-594-015	15 mm

SHEEHAN

Osteotom, 160 mm
 Osteotome, 6¹/₃ inch



420-596-002	2 mm
420-596-003	3 mm
420-596-004	4 mm
420-596-006	6 mm
420-596-008	8 mm
420-596-010	10 mm
420-596-011	11 mm
420-596-015	15 mm

TARDY

Osteotom, 160 mm
 Osteotome, 6¹/₃ inch



420-496-001	1 mm	420-496-007	7 mm
420-496-002	2 mm	420-496-008	8 mm
420-496-003	3 mm	420-496-009	9 mm
420-496-004	4 mm	420-496-010	10 mm
420-496-005	5 mm	420-496-012	12 mm
420-496-006	6 mm	420-496-015	15 mm

FRENCH PATTERN

Osteotom, 150 mm
 Osteotome, 6 inch

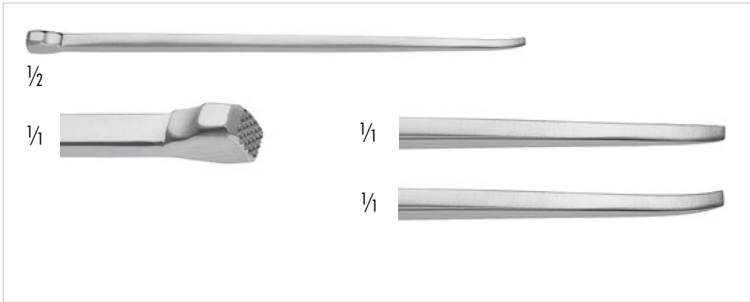

Gerade/straight		Gebogen/curved	
420-570-002	2mm	420-571-002	2mm
420-570-004	4mm	420-571-004	4mm
420-570-006	6mm	420-571-006	6mm
420-570-008	8mm	420-571-008	8mm
420-570-010	10mm	420-571-010	10mm
420-570-012	12mm	420-571-012	12mm
Mini Osteotom, 125 mm			
Mini Osteotome, 5 inch			



420-702-175CC	2mm
420-703-175CC	3mm
420-704-175CC	4mm
420-706-175CC	6mm
Mini Osteotom, CeraCut®, 175mm	
Mini Osteotome, CeraCut®, 7 inch	



210-114-143	3mm
210-114-145	5mm
210-114-147	7mm
210-114-149	9mm
TRAUTMANN	
Meissel, 140 mm	
Chisel, 5 ^{1/2} inch	



210-113-143	3mm
210-113-145	5mm
210-113-147	7mm
210-113-149	9mm
TRAUTMANN	
Hohlmeissel, 140 mm	
Gouge, 5 ^{1/2} inch	



Gerade/straight		Gebogen/curved	
420-502-002	2mm	420-502-102	2mm
420-502-003	3mm	420-502-103	3mm
420-502-005	5mm	420-502-105	5mm
420-502-007	7mm	420-502-107	7mm
420-502-010	10mm	420-502-110	10mm
420-502-014	14mm	420-502-114	14mm
420-502-016	16mm	420-502-116	16mm
420-502-018	18mm	420-502-118	18mm
TESSIER			
Nasen Osteotom, 160 mm			
Nasal Osteotome, 6 ^{1/3} inch			



210-240-180 240 g, Ø 30 mm

COTTLE

Hammer, 1 Seite flach, 1 Seite konvex, 190 mm
Mallet, 1 side plain flat, 1 side convex, 7 1/2 inch



210-264-140 140 g, Ø 25 mm

Hammer, mit auswechselbaren Kunststoffbacken
Mallet, with interchangeable plastic disks

210-265-100

Ersatzbackenpaar, für Hammer 210-264-140
Pair of spare disks, for mallet 210-264-140



210-019-170 117 g, Ø 19 mm

Hammer, mit Kupferkopf, 170 mm
Mallet, with copper head, 6 3/4 inch



110-110-003

Skalpell Griff Nr. 3, 130 mm
Scalpel handle No.3, 5 1/8 inch



110-130-077

Skalpell Griff Nr. 7, 165mm
Scalpel handle No. 7, 6 1/2 inch

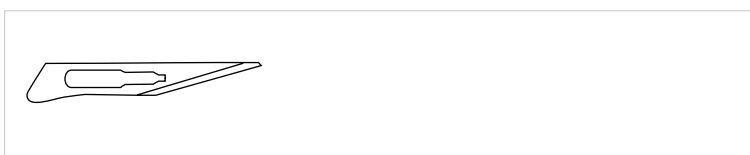

110-201-011

Skalpellklingen Fig 11, 100 Stück
Scalpel blades Fig. 11, 100 pieces

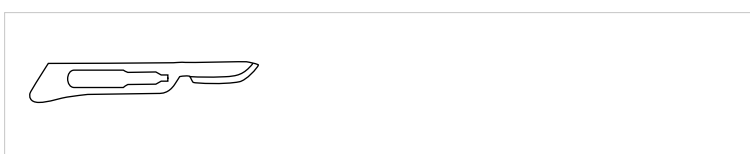

110-201-015

Skalpellklingen Fig. 15, 100 Stück
Scalpel blades Fig. 15, 100 pieces



420-213-140

COTTLE

Septummesser, abgerundete Kanten, 140 mm
Septum knife, stiff blade with rounded edge, 5 1/2 inch

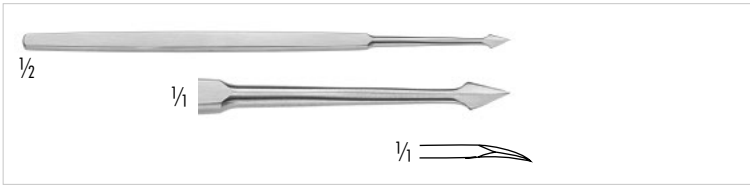

420-552-130

MASING

Knorpelritzmesser, in der Spitze gebogen, 130 mm
Cartilage slitting knife, curved blade, pointed, 5 1/8 inch



420-205-160

JOSEPH

Plastikmesser, gerade, Spitze verrundet, 150 mm
Button-end knife, straight, 6 inch



420-207-160

CONVERSE

Plastikmesser, gebogen, Spitze verrundet, 160 mm
Button-end knife, curved, 6 1/4 inch

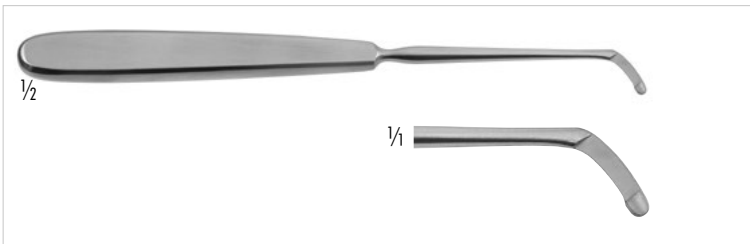

420-209-175

JOSEPH

Zugmesser zum Abtragen von Knorpelvorsprüngen des Septums, 165 mm
Button-end knife, angled for removal of septum cartilage, 6 1/2 inch

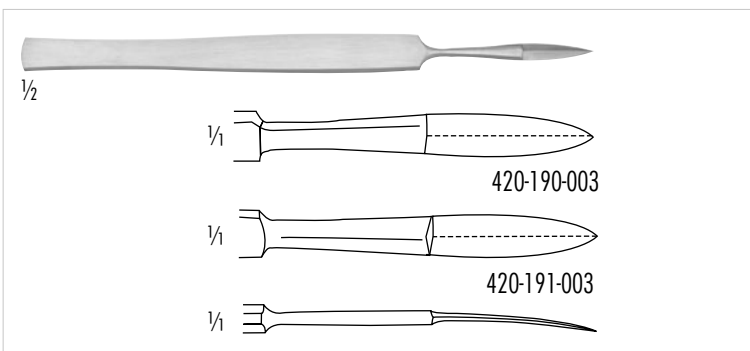

420-190-003 gerade/straight

420-191-003 gebogen/curved

JOSEPH

Plastikmesser mit doppelter Schneide, scharf, 150 mm
Double-edge nasal knife, sharp, 6 inch



420-195-150

FREER

Mukosamesser, 150 mm
Mucosa knife, 6 inch

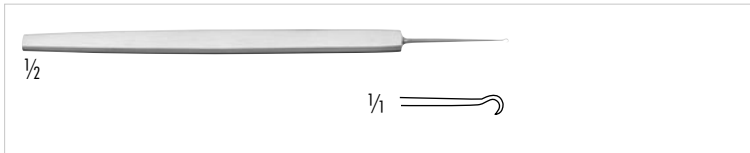

170-010-125
GRAEFE
Hauthäkchen, scharf, 120 mm
Skin hook, sharp, 4 3/4 inch

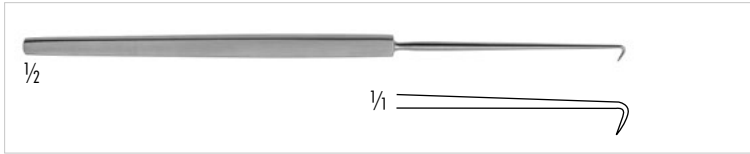

230-285-160
COTTLE
Scharfes Sehnenhäkchen, 120° retrograd gebogen, 168 mm
Tenaculum hook, 120° retrograde curved, 6 2/3 inch

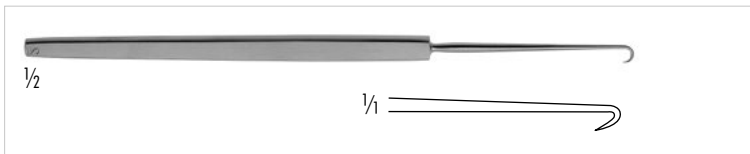

230-286-160
COTTLE
Scharfes Sehnenhäkchen, 180° retrograd gebogen, 168 mm
Tenaculum hook, 180° retrograde curved, 6 2/3 inch

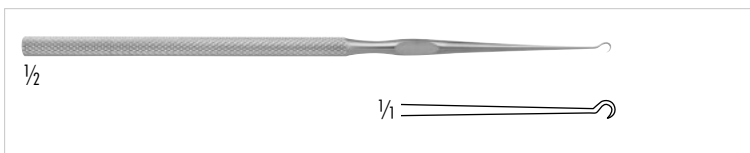

230-203-150
KILNER
Hauthäkchen, scharf, 150 mm
Skin hook, sharp, 6 inch

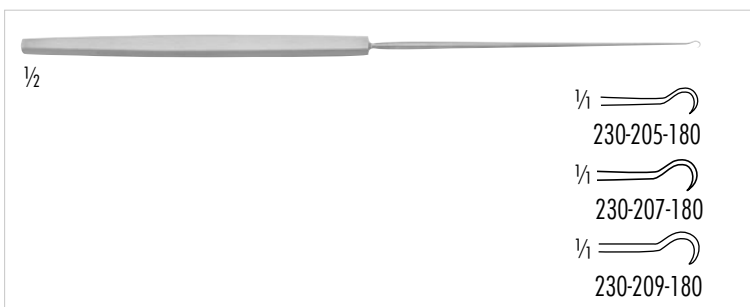

230-205-180 klein/small
230-207-180 mittel/medium
230-209-180 groß/large
GILLIES
Hauthäkchen, scharf, 180 mm
Skin hook, sharp, 7 inch

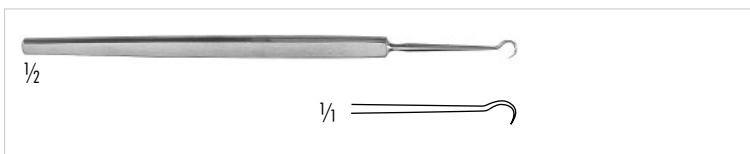

170-013-130 130 mm, 5 1/4 inch
170-013-180 180 mm, 7 inch
FRAZIER
Hauthäkchen, scharf
Skin hook, sharp



250-064-376
FISCH
Hauthäkchen, 90° abgewinkelt, scharf, 190 mm
Skin hook, 90° angled, sharp, 7 1/2 inch



170-060-001 klein/small
170-060-002 groß/large
CUSHING
Stumpfes Häkchen, 190 mm
Buttoned hook, 7 1/2 inch



170-042-130
GUTHRIE
Hauthäkchen, Fig. 1, 120 mm
Skin hook, Fig. 1, 4 3/4 inch

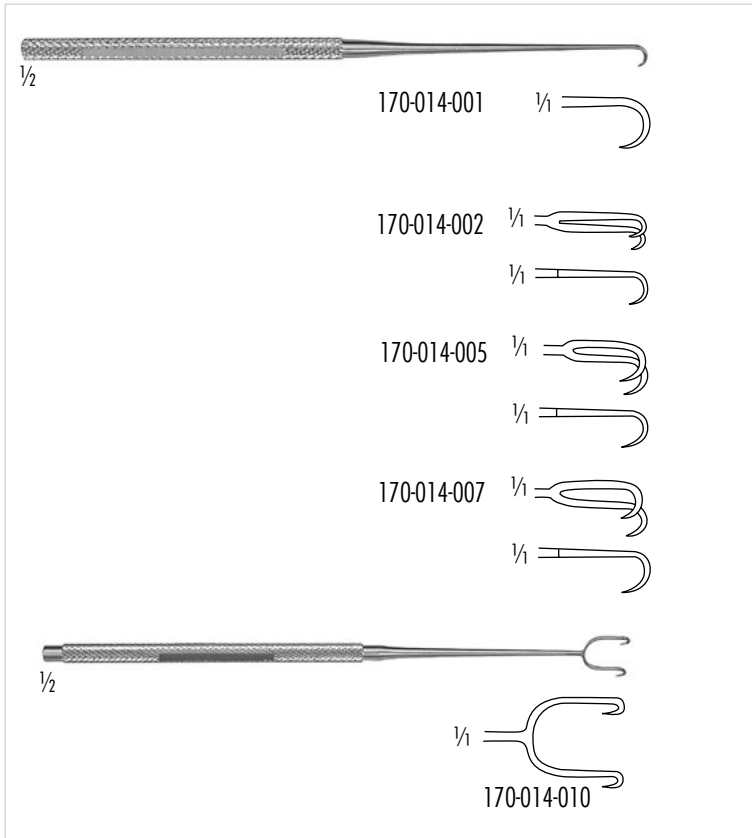

170-014-001

JOSEPH

Hauthäkchen, scharf, 1 Zinken, 150 mm
Skin hook, sharp, single prong, 6 inch

170-014-002 2 mm

170-014-005 5 mm

170-014-007 7 mm

170-014-010 10 mm

JOSEPH

Hauthäkchen, 2 Zinken, scharf, 160 mm
Skin hook, sharp, 2 prongs, 6 1/4 inch

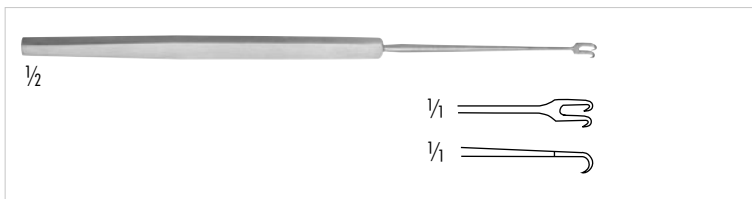

230-220-001

FREER

Hauthäkchen, 2 Zinken, scharf, 150 mm
Skin hook, 2 prongs, sharp, 6 inch

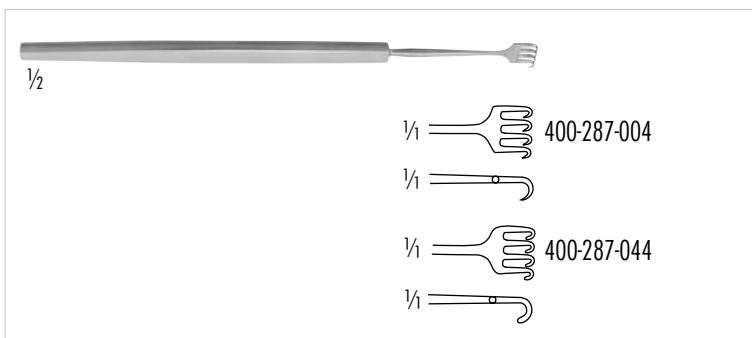

400-287-004 scharf/sharp

400-287-044 stumpf/blunt

ROLLET

Hauthäkchen, 4 Zinken, 135 mm
Skin hook, 4 prongs, 5 1/4 inch

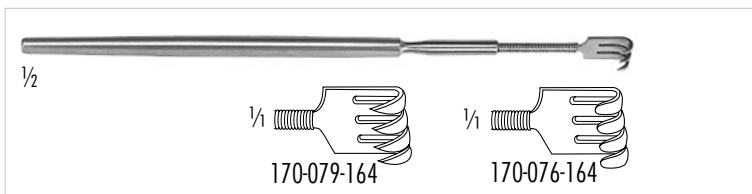

170-079-163 3 Zinken, scharf / 3 prongs, sharp

170-079-164 4 Zinken, scharf / 4 prongs, sharp

170-076-163 3 Zinken, stumpf / 3 prongs, blunt

170-076-164 4 Zinken, stumpf / 3 prongs, blunt

Feine Wundhaken mit flexibler Spitze, 160 mm

Fine hand held retractor with flexible tip, 6 1/4 inch

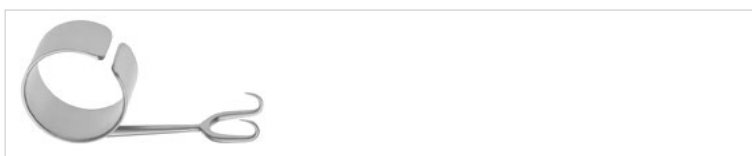

170-008-381

COTTLE

Wundhäkchen mit Ring, Arbeitslänge: 38 mm, scharf, 2-zahlig, 8 mm
Thumb retractor, working length 1 1/2 inch, sharp, double hook, 8 mm wide

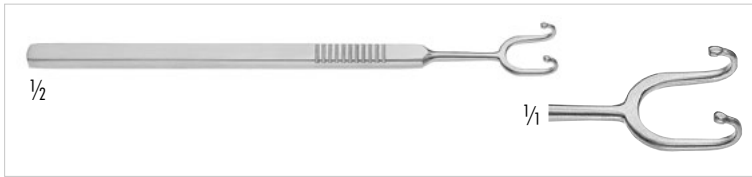

420-186-145
FOMON
Nasenflügelretractor, 2 Zinken, stumpf/stumpf, 140 mm
Alar retractor, 2 prongs, blunt/blunt, 5 1/2 inch



230-281-140 stumpf/spitz, blunt/sharp
230-282-140 spitz/stumpf, sharp/blunt
COTTLE
Nasenflügelretractor, 2 Zinken, 140 mm
Alar retractor, 2 prongs, 5 1/2 inch

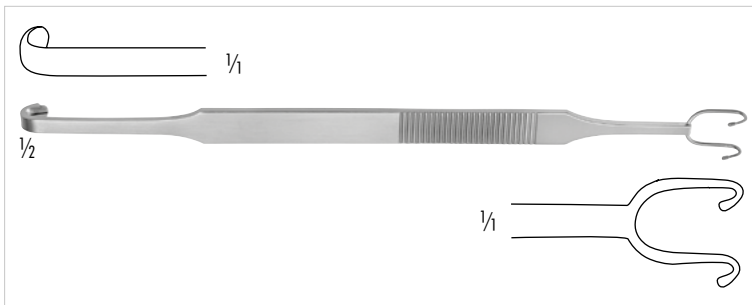

230-260-200
COTTLE-NEIVERT
Nasenflügelretractor, mit Säge- oder Messerführung,
2 Zinken, stumpf, 200 mm
Alar retractor, with saw and knife guide, 2 prongs, blunt, 8 inch

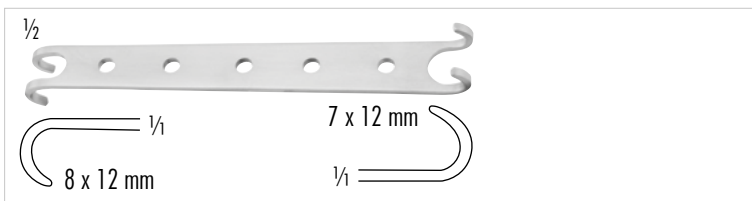

260-501-120
CONVERSE
Alar-Doppelhaken, 2 Zinken, stumpf/stumpf, 120 mm
Alar retractor, double-ended, 2 prongs, blunt/blunt, 4 3/4 inch



420-187-155 sharp
420-187-255 blunt
RUBIN
Haken, 7mm lang, 5,5mm breit
Hook, 7mm length, 5.5mm wide



420-524-150
COTTLE
Alar Retraktor mit Lippe, 150 mm
Alar retractor with lip, 6 inch



420-184-100 spitz/spitz / sharp/sharp
420-185-100 stumpf/stumpf / blunt/blunt
KILNER
Nasenflügelretractor, 2 Zinken, 85 mm
Alar retractor, 2 prongs, 3 1/4 inch

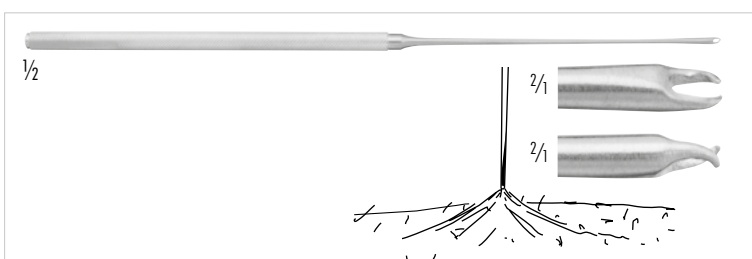

250-064-392 Ø 1,8 mm
Hautkralle mit Schutzkappe, 185 mm
Skin picks with protection cap, 7 1/4 inch

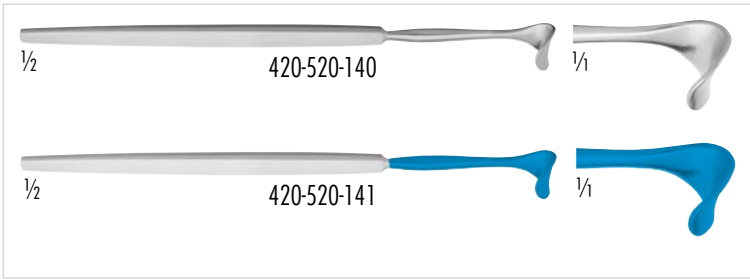

420-520-140 6x12 mm
 420-520-141 6x12 mm, **isoliert/insulated**
MASING
 420-523-140 10x12 mm
 420-523-141 10x12 mm; **isoliert/insulated**
COTTLE

Alar Retraktor, 140 mm
 Alar retractor; 5 1/2 inch



420-256-135
WALTER

Doppelhaken, eine Seite mit 2 stumpfen Haken, eine Seite mit stumpfen Blatt
 Double-ended retractor, one end 2 blunt prongs and one with blade



420-260-005 5mm + 42x7mm
 420-260-008 8mm + 38x7mm
 420-260-013 13mm + 38x7mm
 420-260-113 13mm + 42x10mm

AUFRIECHT
 Doppelendiger Nasenhaken, stumpf
 Double-ended nasal retractor, blunt



420-250-160 10x45 mm Blatt/blade
 420-251-160 10x30 mm Blatt/blade
AUFRIECHT
 Nasenretraktor, 160 mm
 Nasal retractor, 6 1/4 inch

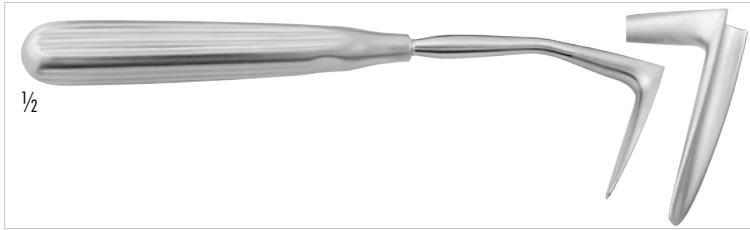

420-057-160

DEVINE-MILLARD-AUFRICHT

Nasenretraktor, 10 x 45 mm Blatt, 180 mm

Nasal retractor, 10 x 45 mm blade, 7 inch

420-257-160

Dito, mit KL-Anschluß

Same, with fibre optic

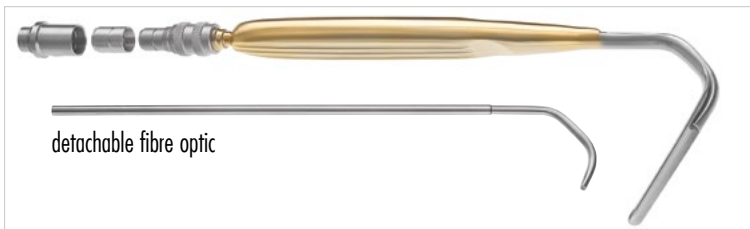

420-255-160

AUFRICHT

Nasenretraktor, mit Kaltlicht, 120°, 45 mm Blatt, 180 mm

Nasal retractor, with fibre optic, 120°, 45 mm blade, 7 inch

detachable fibre optic



420-652-100

420-752-100 mit Kaltlichtträger/with fibre optic light carrier

MALINIAC

Nasenretraktor, 9 x 45 mm, 100 mm

Nasal retractor, 9 x 45 mm, 4 inch



420-236-110 11 x 44 mm

CONVERSE

Nasenretraktor, mit Kaltlicht, 110 mm

Nasal retractor, with fibre optic, 4 1/3 inch



121-188-145 gerade / straight
121-189-145 gebogen / curved

METZENBAUM

Super-Cut Präparierscheren, mit eckigen Ringen, 145 mm
Super-Cut Dissecting scissors, with square rings, 5 3/4 inch



120-967-130 gebogen/curved
120-966-130 gerade/straight

GOLDMAN FOX

TC Sehnschere, eine Schneide gezahnt, 130 mm
TC Tendon scissors, one blade serrated, 5 1/8 inch

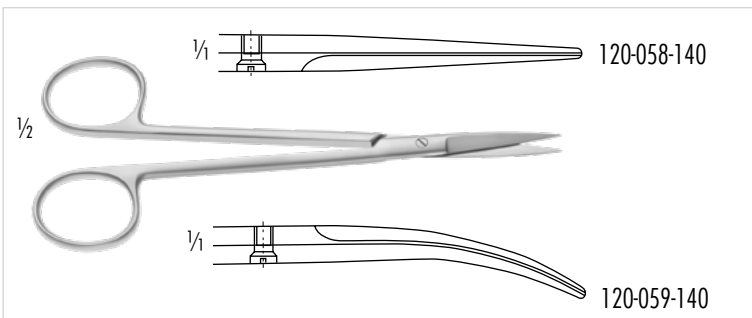

120-058-140 gerade / straight
120-059-140 gebogen / curved

JOSEPH

Plastikschere, spitz/spitz, 145 mm
Plastic scissors, sharp/sharp, 5 3/4 inch

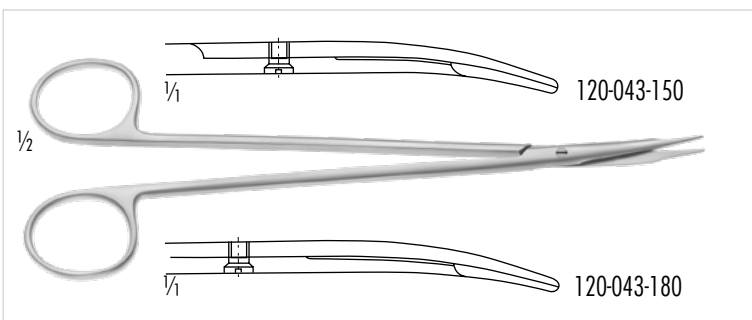

120-043-150 145 mm, 5 3/4 inch
120-043-180 175 mm, 7 inch

REYNOLDS

Präparierschere, delikate, stumpf/stumpf, gebogen
Dissecting scissors, delicate, blunt/blunt, curved

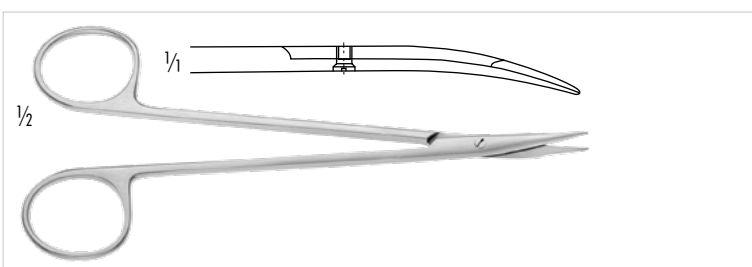

120-315-150

JAMESON

Präparierschere, delikate, stumpf/stumpf, gebogen, 150 mm
Dissecting scissors, delicate, blunt/blunt, curved, 6 inch

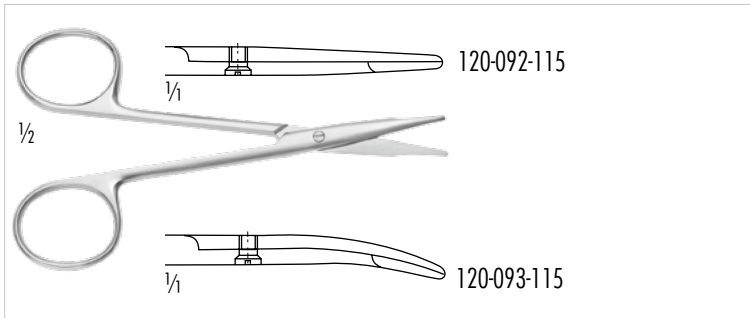

- 120-092-115 gerade, stumpf/stumpf
straight, blunt/blunt
- 120-093-115 gebogen, stumpf/stumpf
curved, blunt/blunt

STEVENS

Gefäß- und Sehenschere, 110 mm
Vessel and tendon scissors, 4 3/8 inch

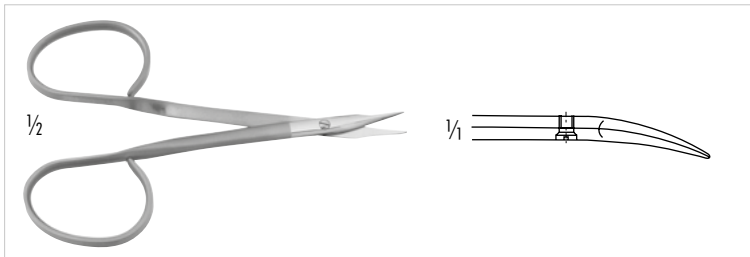

- 120-099-105 gebogen / curved

STEVENS

Gefäß- und Sehenschere, spitz, mit offenem Ring, 100 mm
Vessel and tendon scissors, sharp, with Ribbon handle, 4 inch

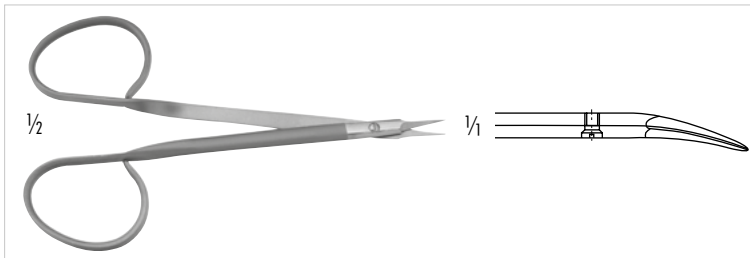

- 120-398-120

STEVENS

Besonders feine Präparierschere, spitz, leichtes Modell mit offenem Ring, 110 mm
Dissecting scissors, delicate, sharp, light pattern with Ribbon handle, 4 3/8 inch

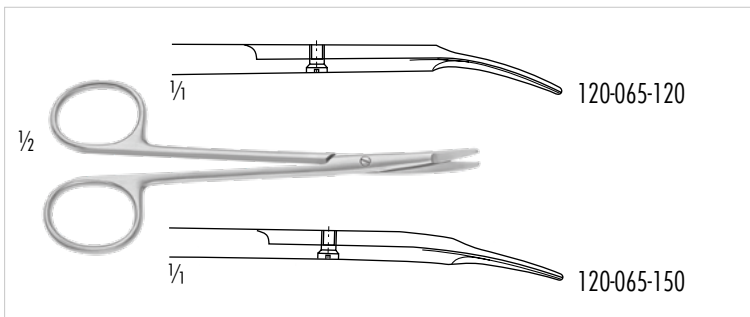

- 120-065-120 125 mm, 5 inch
- 120-065-150 150 mm, 6 inch

KILNER

Präparierschere, mit stark abgeflachten Blättern, gebogen, stumpf/stumpf
Dissecting scissors, with bevelled blade, curved, blunt/blunt

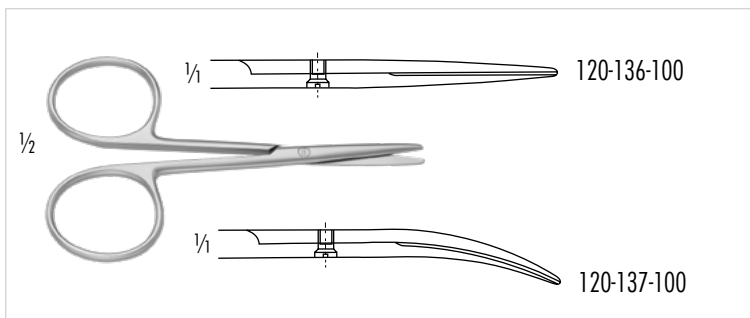

- 120-136-100 gerade / straight
- 120-137-100 gebogen / curved

COTTLE-KNAPP

Plastikschere, stumpf/stumpf, 105 mm
Plastic scissors, blunt/blunt, 4 1/8 inch

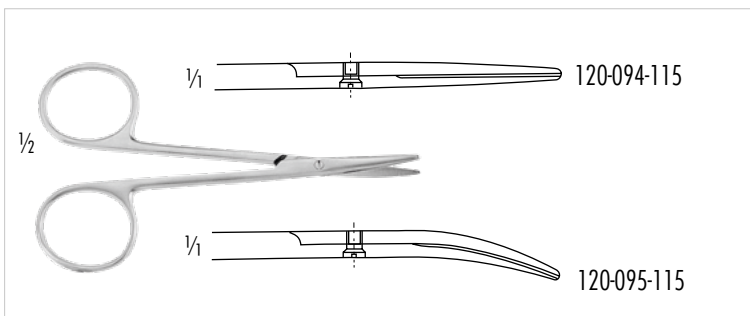

- 120-094-115 gerade / straight
- 120-095-115 gebogen / curved

STRABISMUS

Präparierschere, 115 mm
Dissecting scissors, 4 1/2 inch

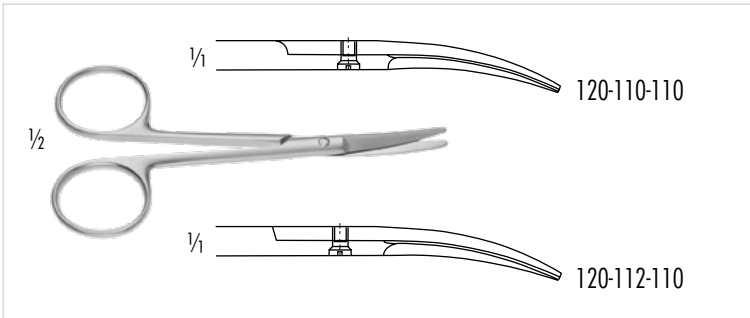

120-110-110 spitz/spitz / sharp/sharp
 120-112-110 stumpf/stumpf / blunt/blunt

COTTLE-MASING

Nasenplastikschere, gebogen, 105 mm
 Nasal plastic scissors, curved, 4 1/8 inch

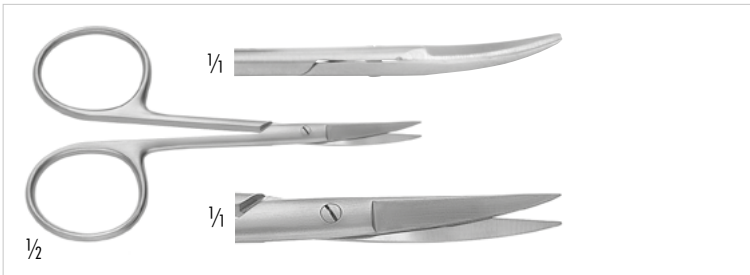

120-081-100

121-081-100 **Super Cut**

Iris Schere, gebogen, mit großen Ringen, 100 mm
 Iris scissors, curved, with large handle, 4 inch

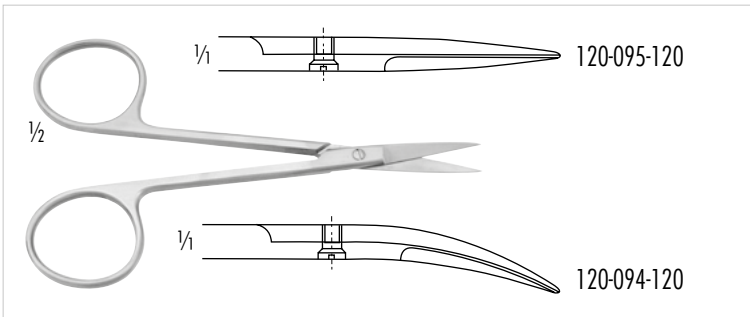

120-095-120 gerade/straight
 120-094-120 gebogen/curved

Feine Schere, 115 mm
 Delicate scissors, 4 1/2 inch

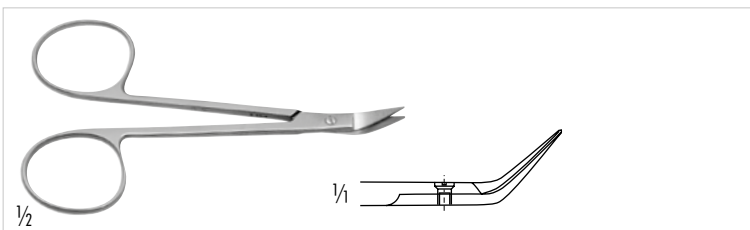

120-411-090

DANIELS

Präparierschere, 40° abgewinkelt, 90 mm
 Dissecting scissors, 40° angled, 3 1/2 inch

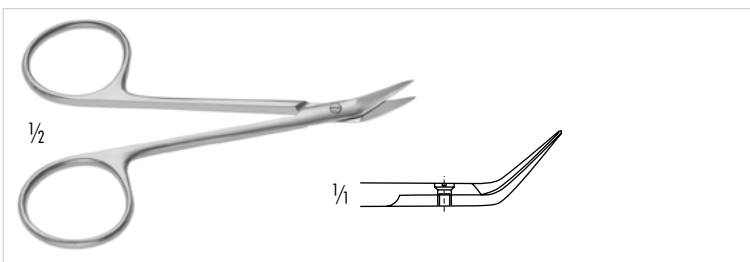

120-411-105

BIRO

Schere, abgewinkelte Schneide, rundes Maul, 105 mm
 Scissors, angled blades, round shape, 4 inch

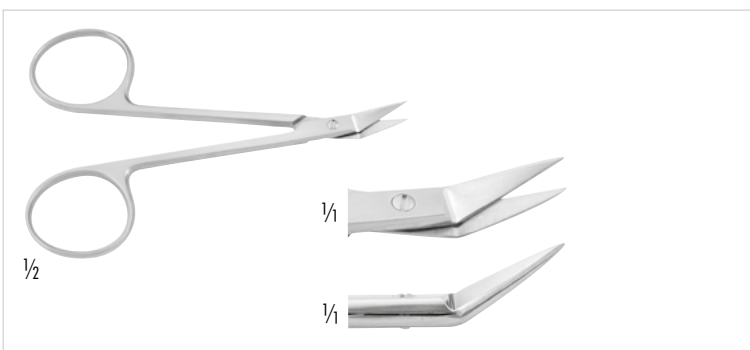

120-511-100

121-511-100 **Super Cut**

CONVERSE

Nasenschere, aufgewinkelte Blätter, spitz/spitz, 104 mm
 Nasal scissors, angled up blades, sharp/sharp, 4 1/8 inch

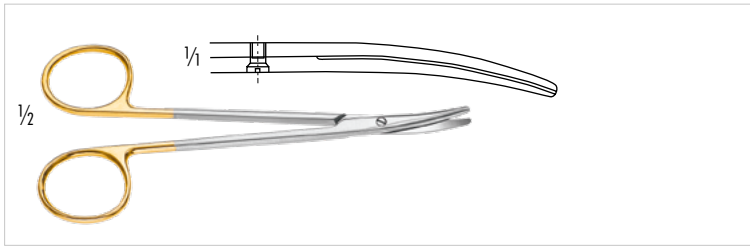

120-595-115
BABY-METZENBAUM
 TC Präparierschere, gebogen, 115 mm
 TC Dissecting scissors, curved, 4 1/2 inch

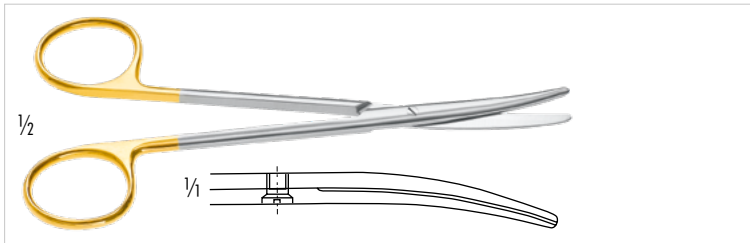

120-511-145
METZENBAUM
 TC Präparierschere, Fig 1, gebogen, 145 mm
 TC Dissecting scissors, Fig. 1, curved, 5 3/4 inch

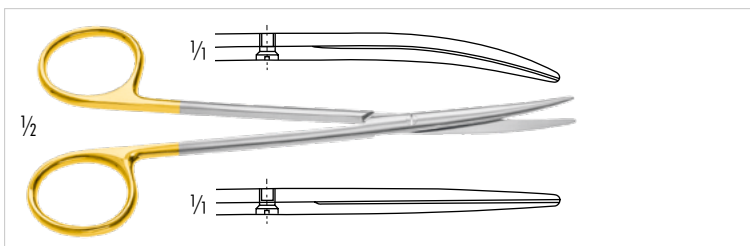

120-521-145 gebogen/curved
 120-520-145 gerade/straight
METZENBAUM-FINO
 TC Präparierschere, stumpf, 145 mm
 TC Dissecting scissors, blunt, 5 3/4 inch

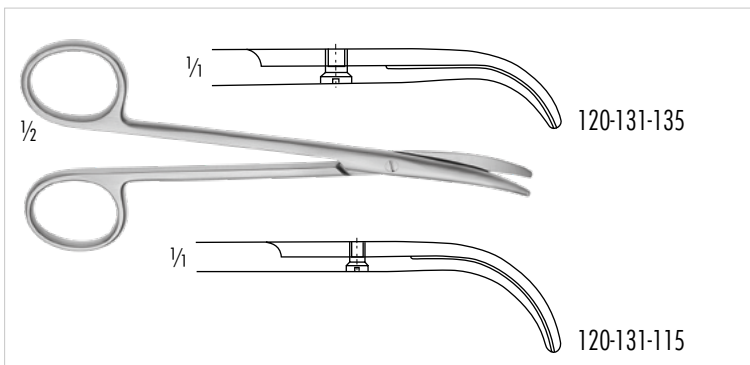

120-131-115 115 mm, 4 1/2 inch
 120-131-135 135 mm, 5 1/4 inch
FOMON
 Nasenflügelschere, stark gebogen
 Lower lateral scissors, strongly curved

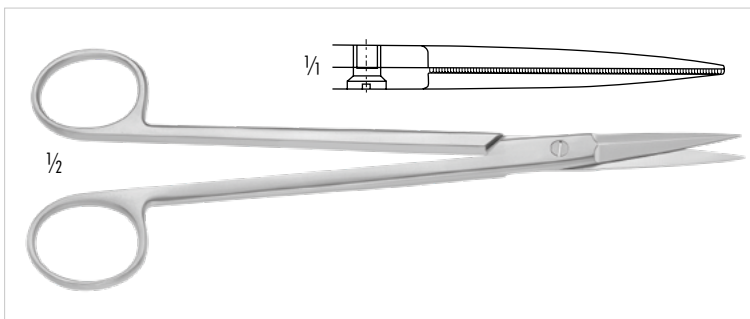

120-190-190
MC INDOE
 Knorpelschere, mit außen schneidenden Blättern,
 spitz/spitz, gerade, gezahnt, 185 mm
 Cartilage scissors, straight, serrated blades. Blades: cutting
 on both sides, sharp/sharp, 7 1/4 inch

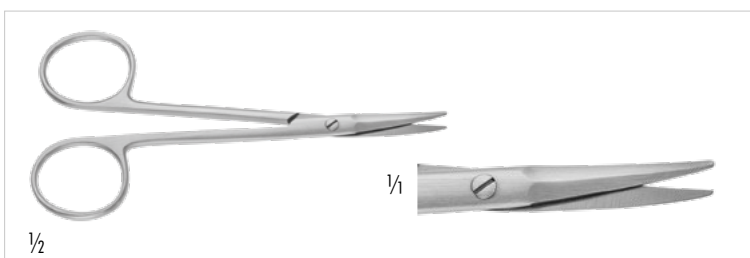

120-281-110 stumpf, 110mm/pointed, 4 3/4 inch
 120-281-130 spitz, 130mm/pointed, 5 inch
BEUSE
 Nasenschere, leicht gebogen
 Nasal Scissors, slightly curved

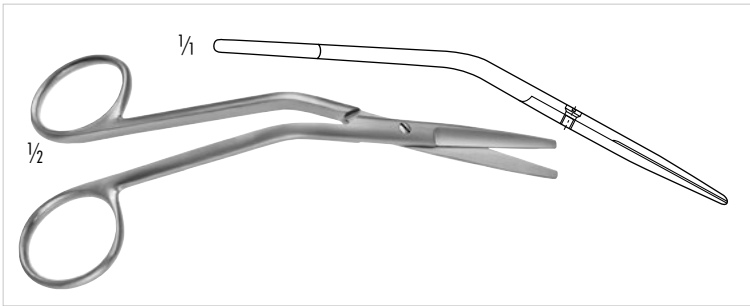

120-280-150

FOMON

Nasenschere, beide Schneiden gezahnt, kniegebogen, stumpf/stumpf, 145 mm

Dorsal scissors, straight, serrated blades, knee bent, blunt/blunt, 5 3/4 inch

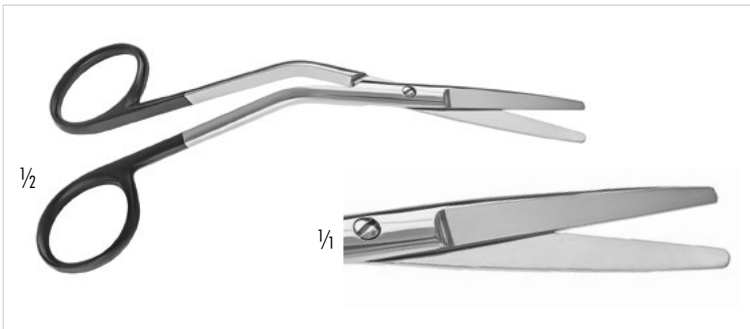

121-280-145

FOMON

SC Nasenschere, kniegebogen, ein gezahntes Blatt, 145 mm

SC Dorsal scissors, knee bent, one serrated blade, 5 3/4 inch



120-281-160

121-281-160 **Super-Cut**

120-581-160 **TC**

COTTLE

Nasenschere, kniegebogen, stumpf/stumpf, 165 mm

Dorsal scissors, straight blades, knee bent, blunt/blunt, 6 1/2 inch



120-585-180

KNIGHT

TC Nasenschere, 180 mm

TC Nasal Scissors, 7 inch

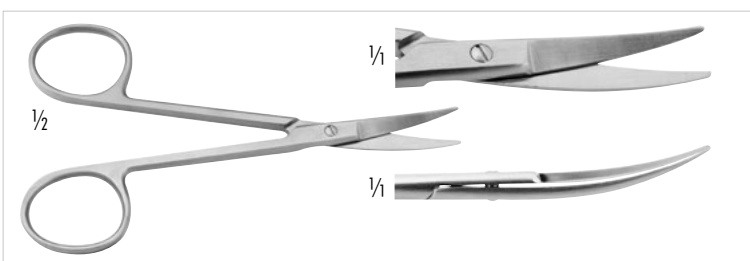

120-379-115

COTTLE

Bulldog-Schere, stumpf/stumpf, 115 mm

Bulldog scissors, blunt/blunt, 4 1/2 inch

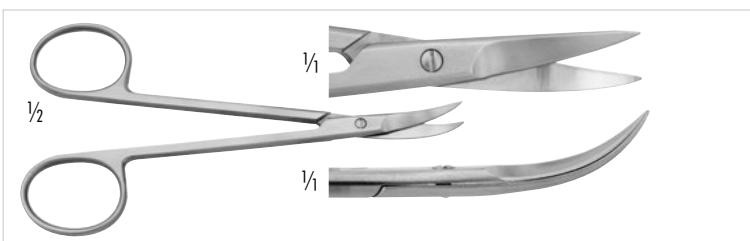

120-053-115

CHADWICK

Schere, gebogen, spitz, 115 mm

Scissors, curved, sharp, 4 1/2 inch



420-730-085

COTTLE

Columella-Pinzette für Kinder, mit Stellschraube
Columella clamp for children, with adjusting screw



420-730-100

COTTLE

Columella-Pinzette, mit feststehenden Fixierrollen und Stellschraube, 100 mm
Columella clamp, with fixation bearings and adjusting screw, 4 inch

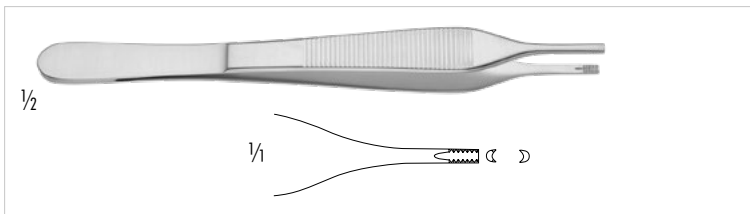

130-552-120 120mm, 4 3/4 inch

130-552-150 150mm, 6 inch

ADSON-BRAUN

Wundrandpinzette, 7x7 Zähne
Tissue forceps, 7x7 teeth

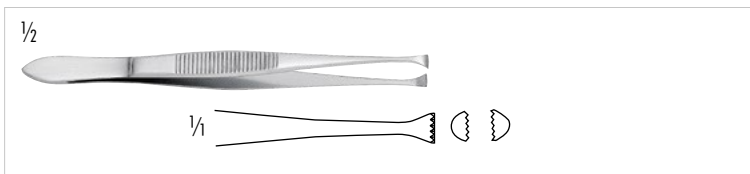

400-025-110

GRAEFFE

Hautfasspinzette, mit scharfen Zähnen, 110 mm
Tissue forceps, with sharp teeth, 4 3/8 inch



130-558-150

GLANZ

Pinzette atraumatisch, 150 mm
Atraumatic tissue forceps, 6 inch

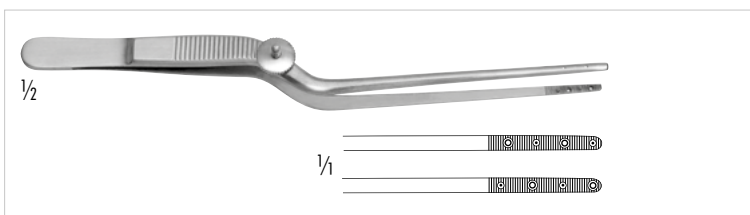

420-732-155

COTTLE

Fixierpinzette, mit Stellschraube, bajonettförmig, gerieft mit Zähnen, 155 mm
Lower lateral forceps, with adjusting screws, bayonet shaped, serrated with teeth, 6 inch



290-552-160

DEBAKEY

Atraumatische Pinzette, gerade, 2 mm Spitze, 160 mm
Atraumatic forceps, straight, 2 mm tip, 6 1/4 inch



410-247-165

SHEEN

Nasenpinzette mit 6mm Löffel, bajonett gebogen, 165mm
Nasal Forceps with 6mm spoon, bayonet shape, 6 1/2 inch

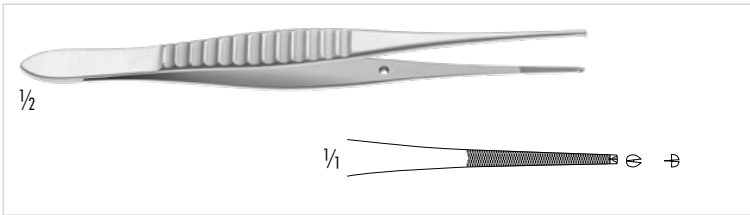

130-120-150

GILLIES

Chirurgische Pinzette, 1 x 2 Zähne, 160 mm
Tissue forceps, 1 x 2 teeth, 6 1/4 inch

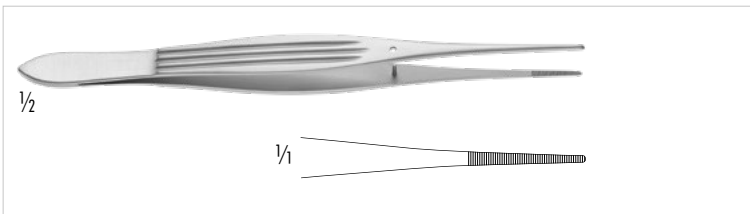

130-028-150

MC INDOE

Anatomische Pinzette, 150 mm
Dissecting forceps, 6 inch



130-500-100 gerade/straight
130-501-100 gebogen/curved

GRAEFE

Feine anatomische Pinzette, 100 mm
Delicate dressing forceps, 4 inch



130-503-100 gerade/straight
130-504-100 gebogen/curved

GRAEFE

Chirurgische Pinzette, 1 x 2 Zähne, 100 mm
Tissue forceps, 1 x 2 teeth, 4 inch



130-144-125

SEMKEN

Anatomische Pinzette, 125 mm
Dressing forceps, 5 inch



130-145-125

SEMKEN

Chirurgische Pinzette, 1 x 2 Zähne, 125 mm
Tissue forceps, 1 x 2 teeth, 5 inch



400-137-050

CASTROVIEJO

Nahtpinzette mit Fadenplatte, 0,5 mm, 1 x 2 Zähne, 100 mm
Suture forceps with tying platform, 0.5 mm, 1 x 2 teeth, 4 inch

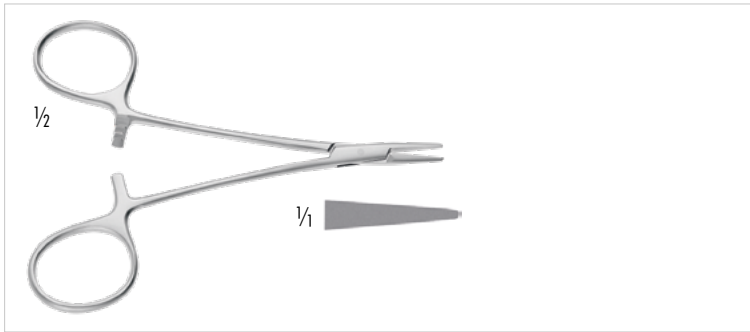

180-318-110
YANG
Nadelhalter, sehr fein, glattes Maul, 110 mm
Needle holder, very delicate, smooth jaw, 4 1/4 inch



180-542-150
BABY-CRILE-WOOD
TC Nadelhalter, 150 mm
TC Needle holder, 6 inch

180-537-130
HALSEY
TC Nadelhalter, 130 mm
TC Needle holder, 5 1/8 inch

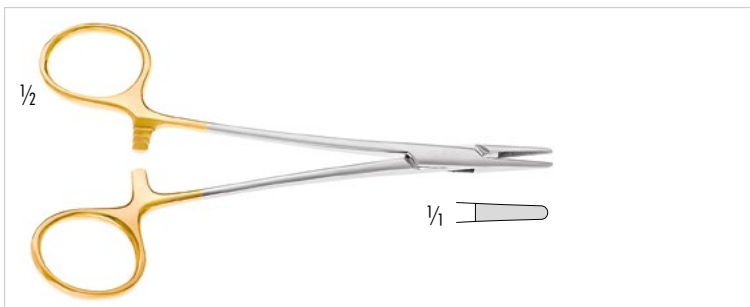

180-533-130
NEIVERT
TC Nadelhalter, 130 mm
TC Needle holder, 5 1/8 inch

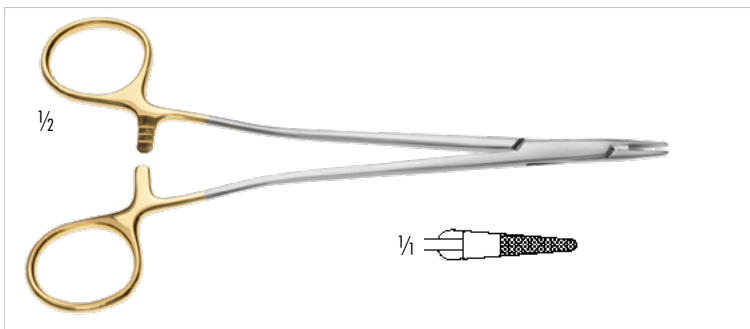

180-531-150 150 mm/6 inch
180-531-170 170 mm/6 3/4 inch
SENNING
TC Nadelhalter, durch seine schlanke Form besonders für tiefe Nähte bei rhinoplastischen Operationen geeignet, 170 mm
TC Needle holder, used for suturing in rhinoplastic surgery, 6 3/4 inch



180-588-150
MINI-GILLIES
TC Nadelhalter, 150 mm
TC Needle holder, 6 inch



250-264-246
JACOBSON
Mikro Nadelhalter, Rundgriff, gerade, mit Sperre, diamantiertes Maul, 185 mm
Micro Needle holder, round handle, straight, with catch, diamond dusted jaws, 7 1/4 inch



420-390-200

Knorpelritzzange mit abnehmbarem einseitigem Schutz für rechts und links sowie ohne Schutz für ein gleichzeitiges Einritzen beider Knorpelseiten, 200 mm

Cartilage morcelizer forceps with removable guard, converts cartilage into a membranous-like structure, permitting repositioning of the septum to midline, 8 inch



420-189-210

GOLDMANN

Nasenfrakturaufrichter, runde Form, 200 mm

Septum elevator, round (displacer), 8 inch



420-557-170

BOIES

Elevator zur Reposition von Nasenbeinbrüchen, 170 mm

Elevator for septum repositioning, 6 ¾ inch

½



420-555-195

BOIES

Nasenfrakturelevator, 9 mm breite Spitze, 195 mm

Nasal fracture elevator, 9 mm wide tip, 7 ¾ inch

½

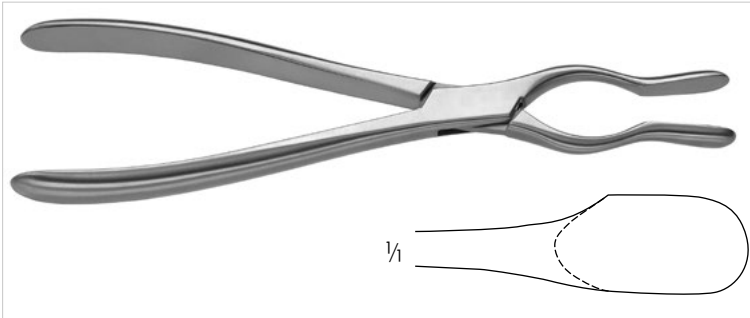

420-450-230
COTTLE-WALSHAM
 Septumrichtzange mit aseptischem Schluß, 220 mm
 Septum straightening forceps, with aseptic lock, 8 3/4 inch

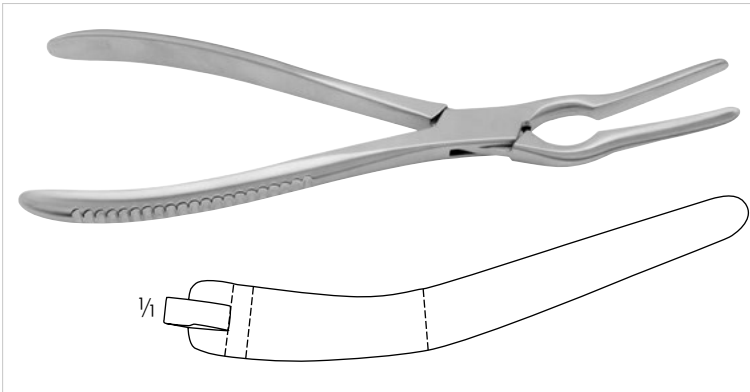

420-455-230
ASH
 Septumrichtzange, 220 mm
 Septum straightening forceps, 8 3/4 inch

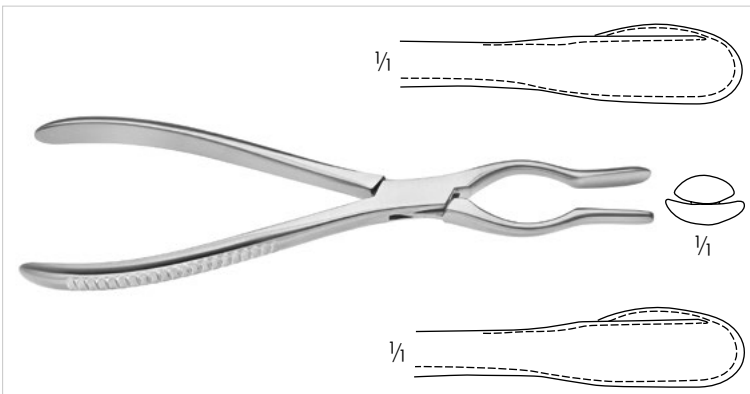

420-452-230 für rechts/right
 420-451-230 für links/left
WALSHAM
 Septumrichtzange, 210 mm
 Septum straightening forceps, 8 1/4 inch



	∅ A	∅ B
410-404-030	3,6 mm	3,0 mm
410-404-035	4,0 mm	3,5 mm
410-404-040	4,5 mm	4,0 mm

MAGILL
 Saugkanülen, 245 mm
 Suction tube, 9 3/4 inch

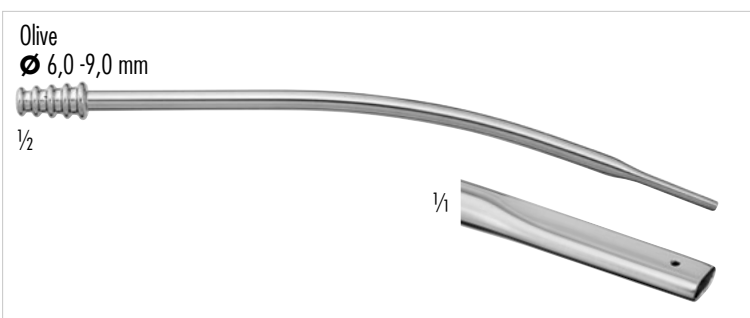

165-064-160 ∅ 5 mm
 Nasensaugrohr, LUER-Bohrung, Spitze 6,5 mm breit, 180 mm
 Nasal suction tube, with LUER, tip 6,5 mm wide, 7 inch

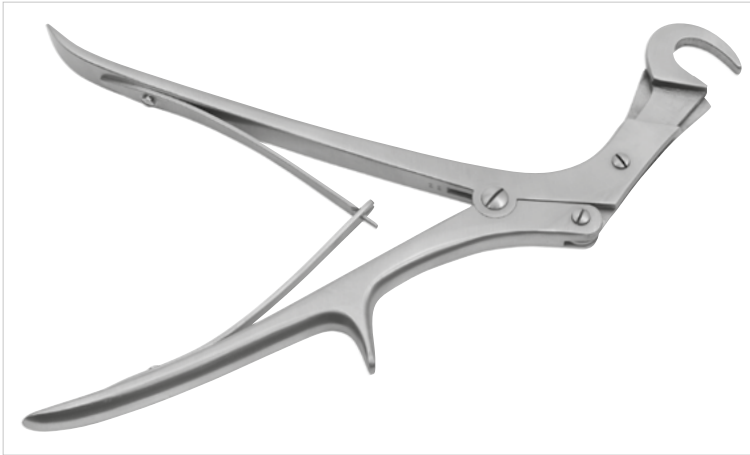

290-137-270

GIERTZ-STILLE

Rippenschere, mit Doppelübersetzung, 250 mm
Rib shear, double action, 10 inch

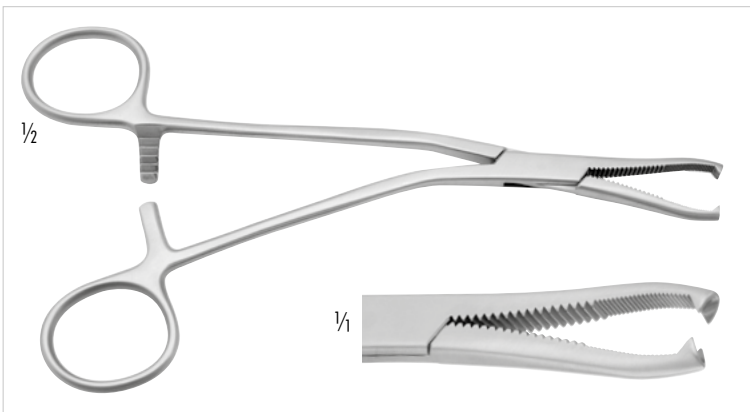

210-626-190

DINGMANN

Knochenhaltezange, 185 mm
Bone holding forceps, 7 1/4 inch



420-365-000 28mm breit/28mm wide

420-365-050 50mm breit/50mm wide

COTTLE

Knochen-Knorpelquetsche mit Metallklammer, zum Entnehmen
der Knochen-Knorpeltrümmer
Bone crusher, for preparation of cartilage implant material,
complete with clamp

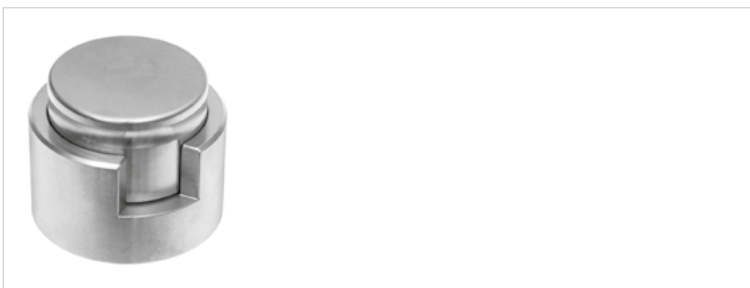

420-366-000

TOLSDORF

Knorpelquetsche, Innenteil gezahnt, Außenteil innen glatt
40mm Innen-Durchmesser
Bone crusher, inner part serrated, outer part bottom plain
40mm inner diameter



420-367-000

85 x 55 mm

Kunststoffplatte, zur Bearbeitung der Knochentransplantate,
dampfsterilisierbar
Plastic plate, for preparation of bone grafts, autoclavable



- 230-202-000 gerade/straight
- 230-202-001 bajonettförmig, links gebogen
bayonet shaped, curved to the left
- 230-202-002 bajonettförmig, rechts gebogen
bayonet shaped, curved to the right

JOSEPH

Nasensäge, 170 mm
Nasal saw, 6 3/4 inch



- 230-211-170 links abgewinkelt/left angled
- 230-210-170 rechts abgewinkelt/right angled

JOSEPH

Nasensäge, 170 mm
Nasal saw, 6 3/4 inch

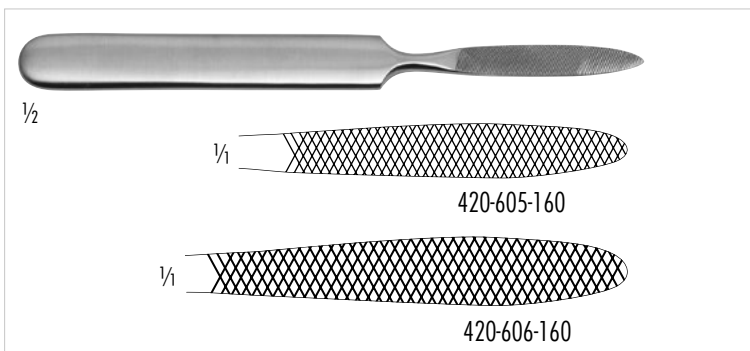

- 420-605-160 fein kariert/fine cross-serrated
- 420-606-160 grob kariert/coarse cross-serrated

JOSEPH

Raspel, zum Füllen von nasalen Knochen, 165 mm
Rasp, for filling nasal bone material, 6 1/2 inch



420-653-180

MALTZ

Nasen-Raspel, 90° quer gerieft, auf Zug schneidend, 180 mm
Nasal rasp, 90° cross-serrated, teeth set to cut on down stroke, 7 inch



420-650-001

AUFRICHT

Nasen-Raspel, 90° quer gerieft, auf Zug schneidend, 220 mm
Nasal rasp, 90° cross-serrated, teeth set to cut on down stroke, 8 3/4 inch

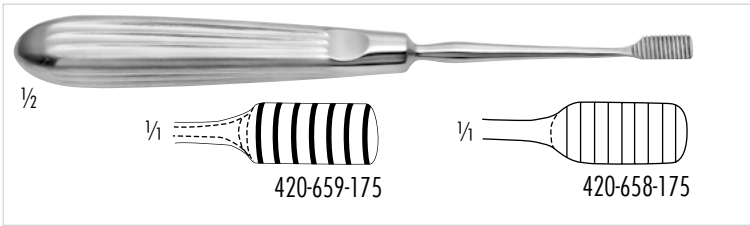

420-658-175

LEWIS

Raspel, 8 mm, 90° quer gerieft, auf Zug schneidend, feine Zahnung
Rasp, 8 mm, 90° cross serrated, set to cut on down stroke, fine teeth



420-658-210 9x25mm

PECK-PARK

Raspel, 16 Zähne, 210mm
Raspatory, 16 teeth, 8 1/4 inch

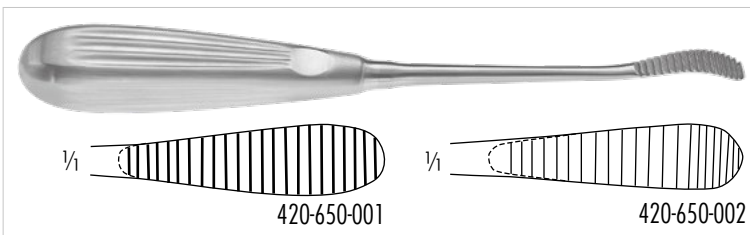

420-650-002

auf Druck schneidend/set to cut on up stroke

420-650-001

auf Zug schneidend/set to cut on down stroke

AUFRICHT

Raspel, 9 mm, 90° quer gerieft, 220 mm
Rasp, 9 mm, 90° cross-serrated, 8 3/4 inch

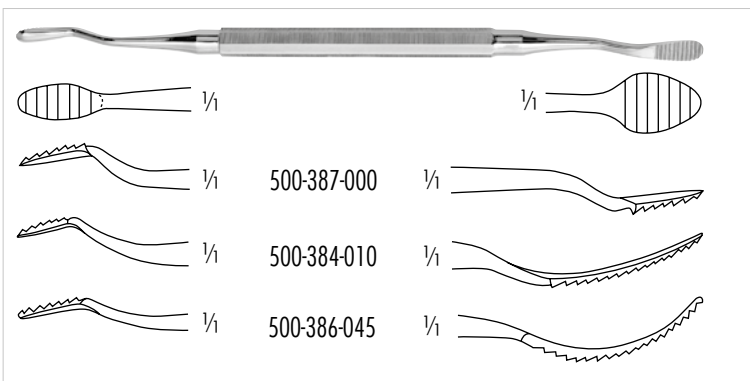

500-387-000

500-384-010

500-386-045

MILLER

Doppelraspel, 90° quer gerieft, auf Zug schneidend, 180 mm
Rasp, double-ended, 90° cross-serrated, set to cut on down stroke, 7 inch

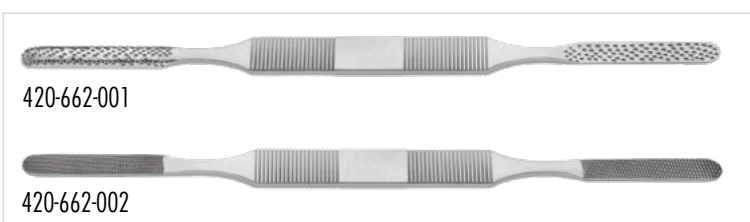

420-662-001

grob/coarse

420-662-002

fein/fine

FOMON

Nasenraspel, sehr leicht
Nasal rasp, lightweight

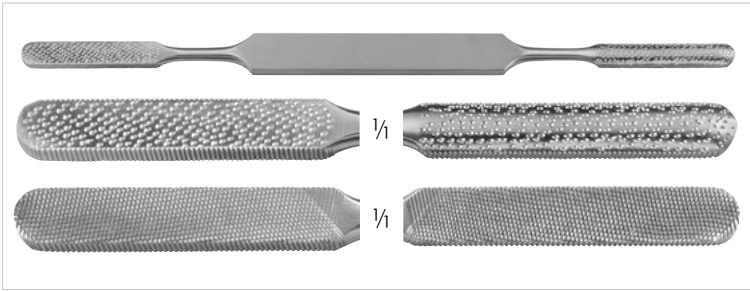

420-661-100

FOMON

Doppelraspel, Vorderseite grob, Rückseite fein, 215 mm
Rasp, double-ended, frontside coarse teeth, backside fine, 8 1/2 inch



420-656-000

KLEINERT-KUTZ

Nasenraspel, doppelendig, 4-seitig, 220mm
Nasal rasp, double-ended, 4-sided, 8 3/4 inch

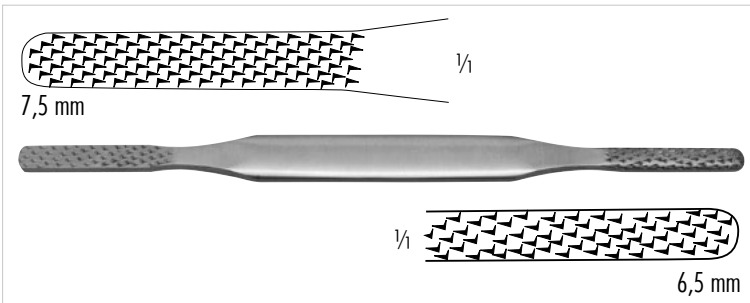

420-660-000

FOMON

Doppelraspel, grobe Zahnung, 215 mm
Rasp, double-ended, coarse teeth, 8 1/2 inch

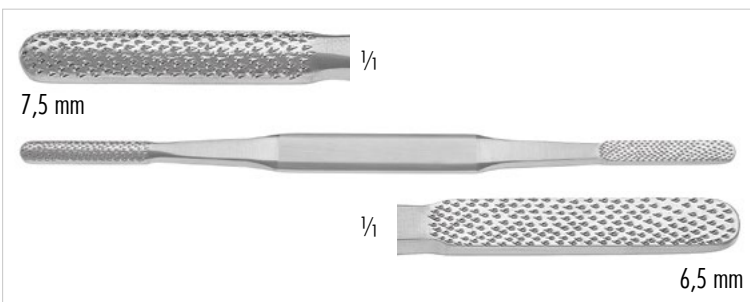

420-661-000

FOMON

Doppelraspel, feine Zahnung, 215 mm
Rasp, double-ended, fine teeth, 8 1/2 inch

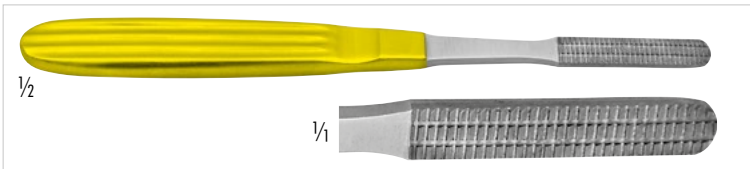
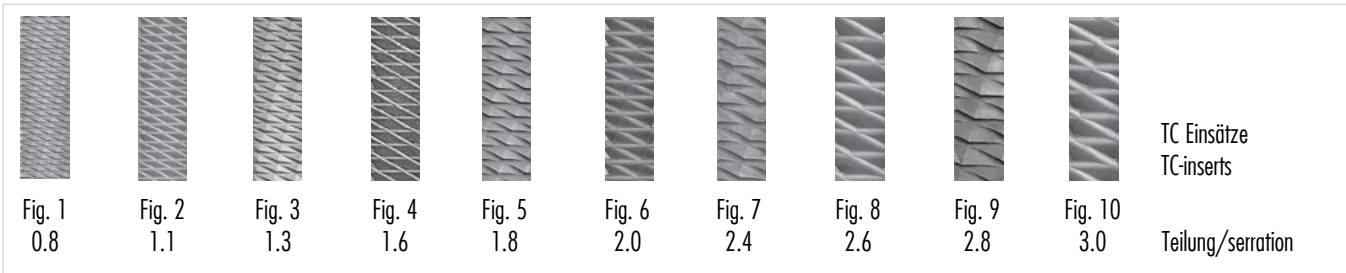

420-672-000

MALTZ

TC Nasenraspel, gerade, auf Zug schneidend, 180 mm

TC Nasal rasp, straight, reverse, 7 inch

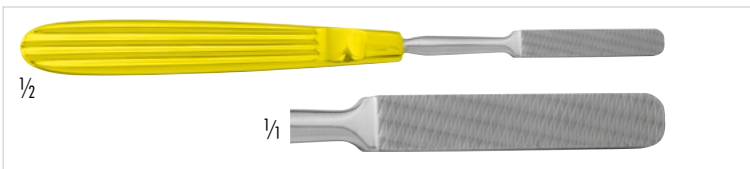

420-492-165 Fig. 2

420-493-165 Fig. 3

MALTZ

TC Nasenraspel, 170 mm

TC Nasal rasp, 6 2/3 inch

420-494-165 Fig. 4

420-495-165 Fig. 5

420-496-165 Fig. 6

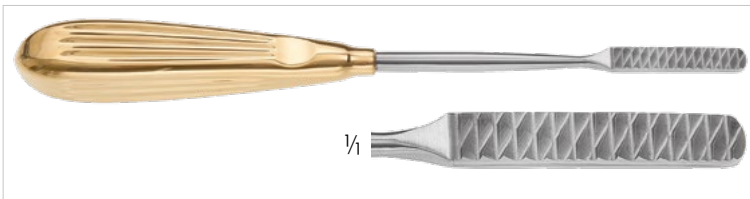

420-490-210 Fig. 1

420-491-210 Fig. 2

420-492-210 Fig. 3

420-493-210 Fig. 4

420-494-210 Fig. 5

PARKES

TC Raspel, 8 x 39 mm, gerade, 210 mm

TC Rasp, 8 x 39 mm, straight, 8 1/4 inch

420-495-210 Fig. 6

420-496-210 Fig. 7

420-497-210 Fig. 8

420-498-210 Fig. 9

420-499-210 Fig. 10

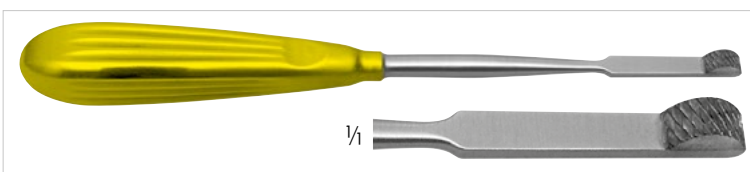

420-669-210

GLABELLA

TC Raspel, mittel, 210 mm

TC Rasp, medium, 8 1/4 inch

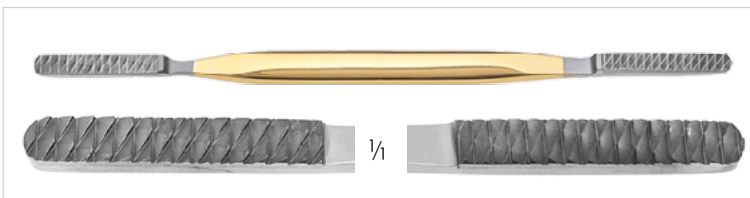

420-660-214 Fig. 3/Fig. 4

420-660-216 Fig. 5/Fig. 6

420-660-218 Fig. 7/Fig. 8

420-660-219 Fig. 1/Fig. 2

420-660-220 Fig. 9/Fig. 10

FOMON

TC Nasenraspel, doppelendig, 7 x 40 mm, 210 mm

TC Nasal Rasp, double ended, 7 x 40 mm, 8 1/4 inch

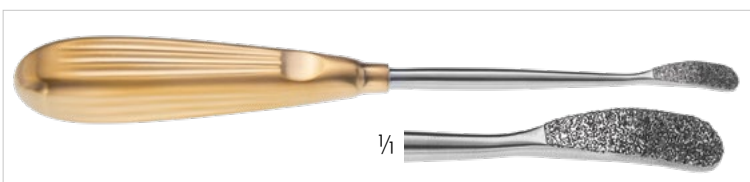

420-650-101

AUFRICHT

Nasenraspel, fein, gebogen, RZ diamantiert, 7 x 25 mm, 200 mm

Rasp, fine, curved, RZ diamond tip, 7 x 25 mm, 8 inch

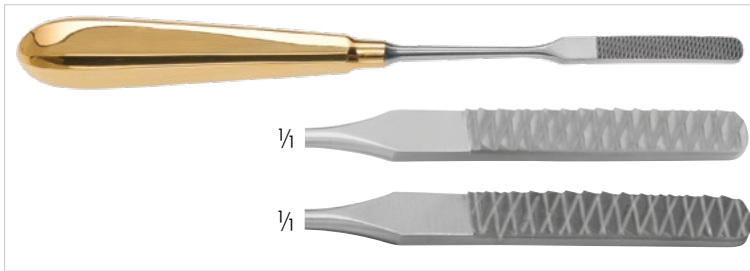

420-480-200 fein
420-488-200 grob

ASTON

Nasenraspel, 200 mm
Nasal rasp, 8 inch



420-650-100

PEET-COTTLE

Nasenraspel, gebogen, RZ diamantiert, 175 mm
Nasal rasp, curved, RZ diamond tip, 7 inch

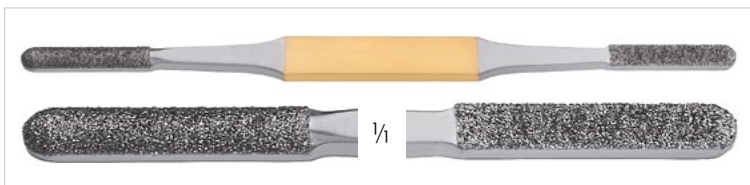

420-653-000

FOMON

Raspel, doppelendig, RZ diamantiert, grob,
convex/flach, 7 x 40 mm, 210 mm
Rasp, double ended, coarse RZ diamond tip,
convex on flat, 7 x 40 mm, 8 1/4 inch

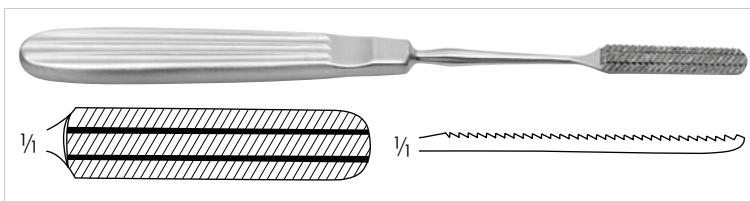

420-628-254

RUBIN

Nasenraspel, 30% schräg, konkav, 200 mm
Nasal rasp, 30% oblique, concave, 8 inch



420-654-180 auf Zug/backward cutting

420-657-180 auf Druck/forward cutting

ORIGINAL MALTZ

Nasenraspel, gerade, 180 mm
Nasal rasp, straight, 7 inch

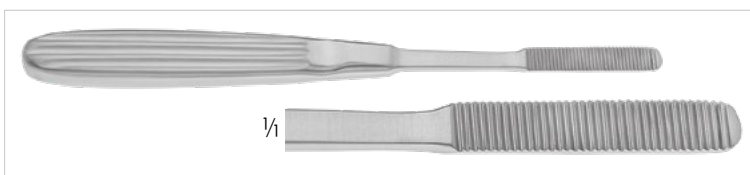

420-655-180

MCINDOE

Nasenraspel, auf Zug, gerade, 180 mm
Nasal rasp, backward cutting, 7 inch



420-756-180

BARSKY-GLABELLA

Nasenraspel, auf Zug, gerade, 175 mm
Nasal rasp, backward cutting, 7 inch



260-500-001

Reinigungsbürste für TC Raspeln
Cleaning brushes for TC rasps



420-700-400
NOLST TRENIÉ
 Glabella Raspel, 8mm breit, 185mm
 Glabella Rasp, 8mm wide, 185mm



420-700-501 medium
 420-700-502 medium/fine
NOLST TRENIÉ
 Nasen Raspel, doppelendig, TC Einsätze, 200mm
 Nasal Rasp, double ended, TC Inserts, 200mm



420-700-001 1 Zahn / 1 prong
 420-700-002 2 Zähne / 2 prongs
NOLST TRENIÉ
 Mikro Hauthäkchen, 155mm
 Micro Skin Hook, 155mm



420-700-210
NOLST TRENIÉ
 Mikro Hauthäkchen, 2 Zähne, 10mm breit
 Micro Skin Hook, 2 prongs, 10mm wide



420-700-200
NOLST TRENIÉ
 Aufricht Nasen Retraktor, 160mm
 Aufricht Nasal Retractor, 160mm



420-700-020 2.0mm
 420-700-025 2.5mm
 420-700-030 3.0mm
 420-700-040 4.0mm
 420-700-060 6.0mm
NOLST TRENIÉ
 Mikro Osteotom
 Micro Osteotome



420-700-022 2.2mm
 420-700-023 3.0mm
 420-700-024 4.0mm

NOLST TRENITÉ

Mikro Osteotom mit Schutz
 Micro Osteotome with guard



420-700-100 10mm
 420-700-120 12mm
 420-700-140 14mm
 420-700-160 16mm
 420-700-180 18mm

NOLST TRENITÉ

Osteotom
 Osteotome

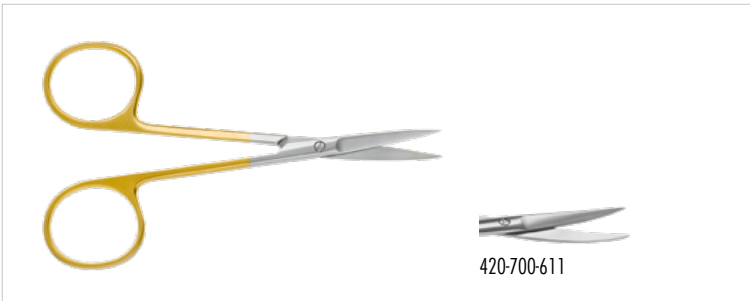

420-700-610 gerade / straight
 420-700-611 gebogen / curved

NOLST TRENITÉ

Rhinoplastik Schere, spitz 100mm
 Rhinoplasty Scissors, sharp, 100mm



420-700-340

NOLST TRENITÉ

Plastik Schere, Kilner Ausführung, 140mm
 Dissecting Scissors, Kilner type, 140mm



420-700-620

NOLST TRENITÉ

Gewinkelte Schere, Walter Ausführung, 100mm
 Angled Scissors, Walter type, 100mm



420-700-630

NOLST TRENITÉ

Chirurgische Pinzette mit seitlichen Zähnen, Adson-Brown Ausführung, 120mm

Tissue Forceps, side grasping teeth, Adson-Brown type, 120mm



420-700-640

NOLST TRENITÉ

Anatomische Pinzette, Adson-Ausführung, 120mm

Dressing Forceps, Adson type, 120mm

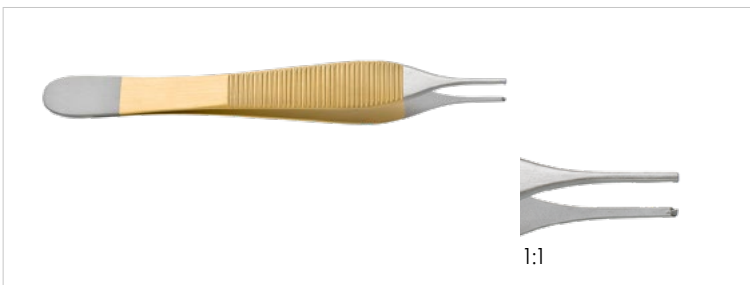

420-700-650

NOLST TRENITÉ

Chirurgische Pinzette, Adson-Ausführung, 120mm

Tissue Forceps, Adson type, 120mm



420-700-330

NOLST TRENITÉ

Nadelhalter mit TC Einsätzen, Hasley Ausführung, 130mm

Needle Holder, TC Inserts, Hasley Type, 130mm



420-700-700

NOLST TRENITÉ

Nasal Forceps, delicate, Blakesley type, 3.5mm, 85mm
Nasenzange, zart, Blakesley-Ausführung, 3,5mm, 85mm



420-700-888

NOLST TRENITÉ

Hammer, Cottle Ausführung
Mallet, Cottle type



420-700-777

NOLST TRENITÉ

Knorpelquetscher, Cottle Ausführung
Cartilage Crusher, Cottle type

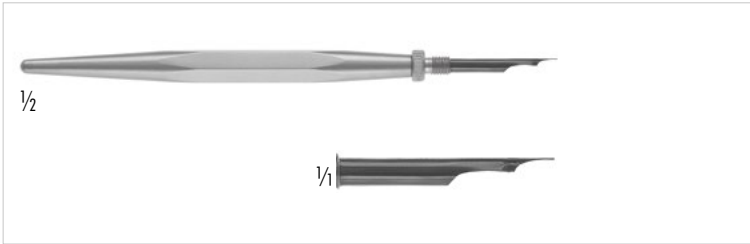

420-832-145

ECKHOFF

Hautmarkierstift, mit versenkbarer Spitze, verchromt, zum Schutz während der Sterilisation
Skin marking pen, with reversible holder for point, chromium plated

420-832-001

Ersatzfeder
Spare nib

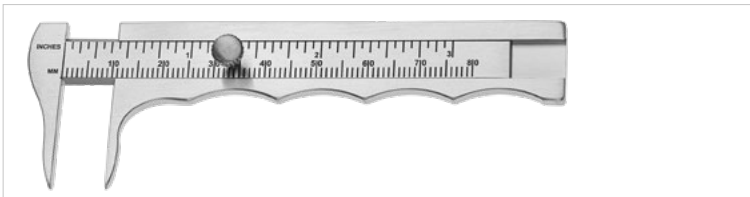

400-421-000

JAMESON

Zirkel mit Schlußschraube, graduert, 0 - 80 mm
Caliper with locking screw, graduated, 0 - 80 mm

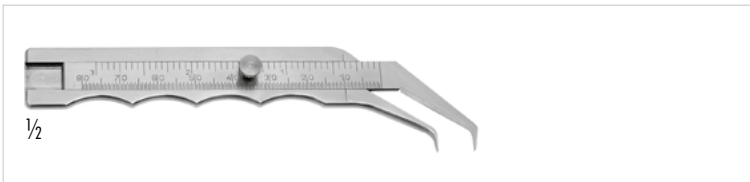

400-420-100

THORPE

Zirkel, mit Schlußschraube, 0-80 mm
Caliper, with locking screw, 0-80 mm



400-583-005

0 - 15 mm, 70mm

400-583-007

0 - 20 mm, 85mm

400-583-008

0 - 40 mm, 180mm

CASTROVIEJO

Hautmeßzirkel
Caliper

400-583-009

CASTROVIEJO

Hautmeßzirkel, Meßbereich 0 - 20 mm, gebogene Spitze, 70mm
Caliper, measuring range 0 - 20 mm, curved tip, 2 3/4 inch

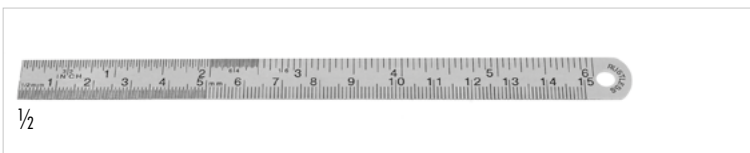

100-418-150

150mm, 6 inch

100-418-200

200mm, 8 inch

Lineal, mit mm und inch Markierung
Ruler, with mm and inch markings

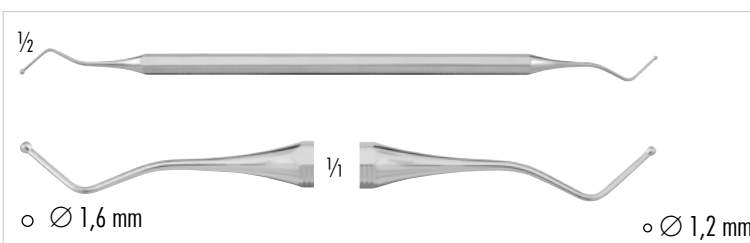

500-270-002

Tamponaden-Stopfer, doppelt, Ø 1,6/1,2 mm, 170 mm
Dressing plugger, double-ended, Ø 1.6/1.2 mm, 6 3/4 inch

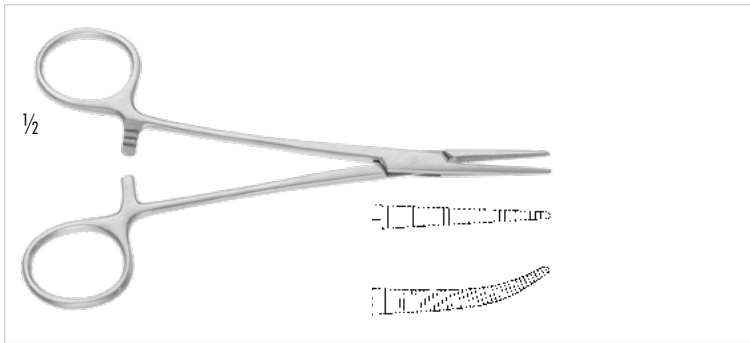

140-254-125 gerade/straight
 140-255-125 gebogen/curved
HALSTED-MOSQUITO
 Arterienklemme, 125 mm
 Hemostatic forceps, 5 inch

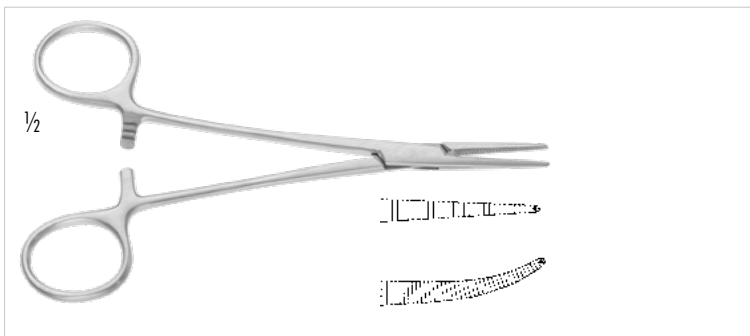

140-256-125 gerade/straight
 140-257-125 gebogen/curved
HALSTED-MOSQUITO
 Arterienklemme, 1 x 2 Zähne, 125 mm
 Hemostatic forceps, 1 x 2 teeth, 5 inch



140-280-140 gerade/straight
 140-281-140 gebogen/curved
KELLY
 Arterienklemme, gerieft, 140 mm
 Hemostatic forceps, serrated, 5 1/2 inch

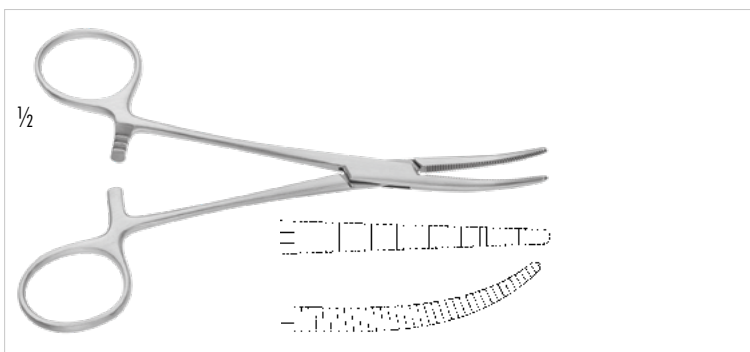

140-290-140 gerade/straight
 140-291-140 gebogen/curved
CRILE (FRASER-KELLY)
 Arterienklemme, 140 mm
 Hemostatic forceps, 5 1/2 inch



165-855-020 3 ml
 165-855-050 5 ml
 165-855-100 10 ml
 Spritze komplett
 Syringe complete



165-856-020 3 ml
 165-856-050 5 ml
 165-856-100 10 ml
 Glaszylinder, allein
 Glas cylinder, only



252-005-170
 Tonsillenkanüle, gerade, mit LUER-Lock-Ansatz, 160 mm
 Tonsil needle, straight, with LUER-lock attachment, 6 1/4 inch



252-003-170
 Septumkanüle, abgewinkelt, mit LUER-Lock Ansatz, 160 mm
 Septum needle, angled, with LUER-lock attachment, 6 1/4 inch



252-004-170
 Tonsillenkanüle, abgewinkelte Spitze, mit LUER-Lock-Ansatz
 Tonsil needle, angled tip, with LUER-lock attachment



252-001-170
 Septumkanüle, bajonettförmig gebogen, mit LUER-Lock Ansatz, 100 mm
 Septum needle, bayonet-shaped, with LUER-lock attachment, 4 inch

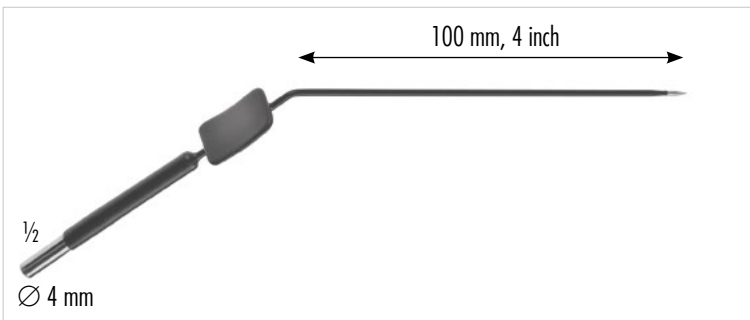

252-204-100
ABBEY
 Resektionsnadel, **isoliert**, mit monopolarem Anschluß
 Sub-mucosal resection needle, **insulated**, with monopolar connector

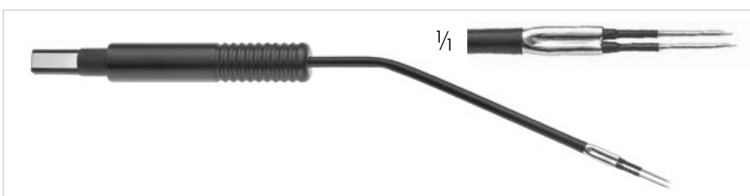

700-420-002
 Bipolare Elektrode für Nase, mit Flachstecker
 Bipolar Electrode for Nose, with flat plug



700-801-165
 Bipolare Pinzette kniegebogen, spitz, Flachstecker 165mm
 Bipolar Forceps angled, pointed, flat-plug square, 6 1/2 inch



SINUSCOPY

Instruments and
Equipment for
Sinuscopy

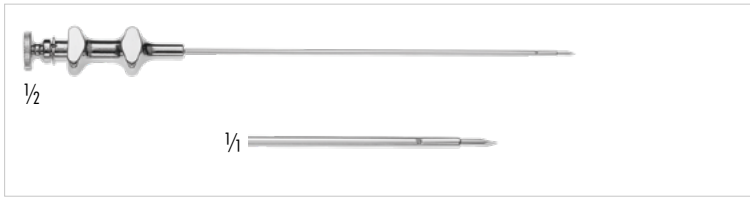

252-015-110 Ø 1,5 mm
252-020-110 Ø 2,0 mm

LICHTWITZ-BIER

Kieferhöhlenpunktionskanüle mit Luer-Ansatz, 100 mm
Antrum trocar needle, Luer attachment, 4 inch

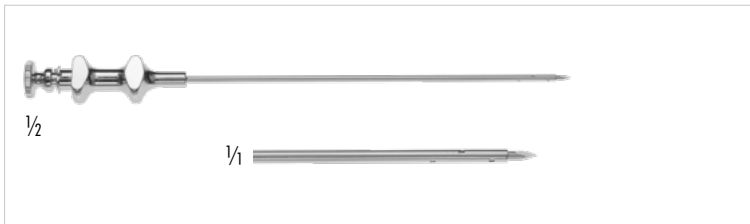

252-115-110 Ø 1,5 mm
252-118-110 Ø 1,8 mm
252-120-110 Ø 2,0 mm
252-125-110 Ø 2,5 mm

EICKEN

Kieferhöhlenpunktionskanüle mit Luer-Ansatz, 105 mm
Antrum trocar needle, Luer attachment, 4 inch

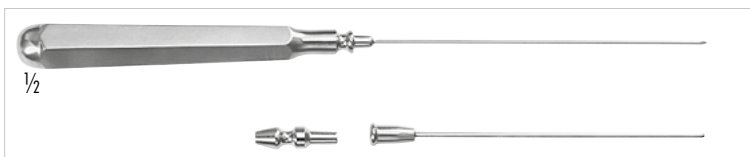

165-052-018

LICHTWITZ

Kieferhöhlentrokar, Ø 1,8 mm, 180 mm, Arbeitslänge: 85 mm
Antrum trocar, Ø 1.8 mm, 7 inch, working length: 3 1/2 inch

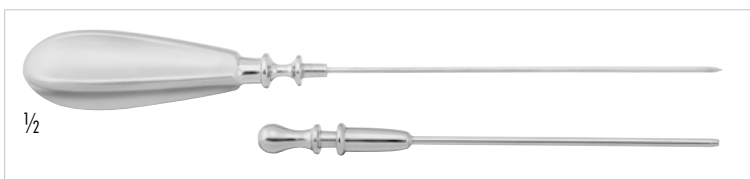

165-152-017 Ø 1,7 mm 165-152-023 Ø 2,3 mm
165-152-020 Ø 2,0 mm 165-152-027 Ø 2,7 mm

TILLEY LICHTWITZ

Kieferhöhlentrokar, 185 mm
Antrum trocar, 7 1/4 inch

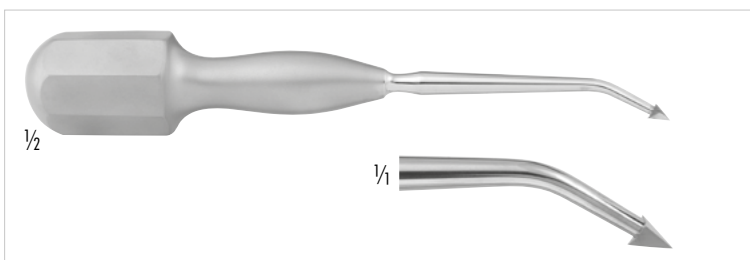

165-059-170 Ø 4 mm

TILLEY

Harpunentrokar, 170 mm
Harpoon trocar, 6 3/4 inch



252-025-150 außen Ø 2,5 mm/outer Ø 2.5 mm
 252-025-151 außen Ø 3,0 mm/outer Ø 3.0 mm
 252-025-152 außen Ø 4,0 mm/outer Ø 4.0 mm

EICKEN

Kiefernhöhlenspülröhrchen, leicht gebogen, mit zentraler Öffnung und Luer-Ansatz, 130 mm
 Irrigating antrum cannula with central opening, slightly curved, Luer attachment, 5 1/8 inch



252-125-150 außen Ø 2,5 mm/outer Ø 2.5 mm
 252-125-151 außen Ø 3,0 mm/outer Ø 3.0 mm
 252-125-152 außen Ø 4,0 mm/outer Ø 4.0 mm

EICKEN

Kiefernhöhlenspülröhrchen, stark gebogen, mit zentraler Öffnung und Luer-Ansatz, 140 mm
 Irrigating antrum cannula with central opening, strong curved, Luer attachment, 5 1/2 inch



252-225-150 außen Ø 2,5 mm/outer Ø 2.5 mm
 252-225-151 außen Ø 3,0 mm/outer Ø 3.0 mm
 252-225-152 außen Ø 4,0 mm/outer Ø 4.0 mm

EICKEN

Antrum Kanüle, stark gebogen, mit Stoploch im Griff, Arbeitslänge: 150 mm
 Antrum Cannula, strong curved, with cut-off hole, working length: 6 inch



252-325-150 außen Ø 2,5 mm/outer Ø 2.5 mm
 252-325-151 außen Ø 3,0 mm/outer Ø 3.0 mm
 252-325-152 außen Ø 4,0 mm/outer Ø 4.0 mm

EICKEN

Antrum Kanüle, leicht gebogen, mit Stoploch im Griff Arbeitslänge: 150 mm
 Antrum Cannula, slightly curved, with cut-off hole, working length: 6 inch



252-425-150 außen Ø 2,5 mm/outer Ø 2.5 mm
 252-425-151 außen Ø 3,0 mm/outer Ø 3.0 mm
 252-425-152 außen Ø 4,0 mm/outer Ø 4.0 mm

EICKEN

Antrum Kanüle, leicht gebogen, biegsam, Arbeitslänge: 150 mm
 Antrum Cannula, slightly curved, malleable, working length: 6 inch



165-072-025 Ø 2,5 mm

SIEBENMANN

Kiefernhöhlenspülröhrchen, mit der Öffnung am äußeren Biegeradius, stumpf, 130 mm

Irrigation antrum cannula, with outside opening, blunt, 5 1/8 inch



165-076-300

Spülschlauch, Silikon, autoklavierbar, komplett mit LUER-Lock Adapter, 300 mm

Irrigation tube, silicone, autoclavable, complete with LUER-Lock attachment, 12 inch

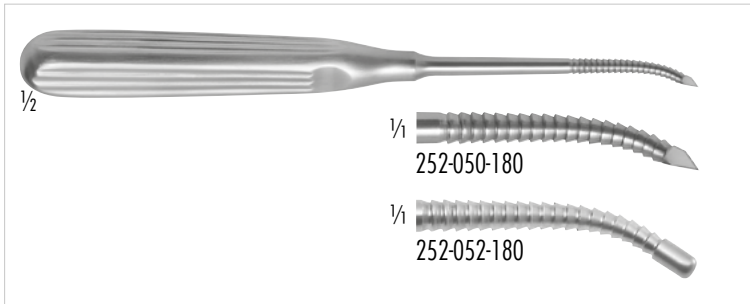

252-050-180 spitz / sharp
 252-052-180 stumpf / blunt
 Kieferhöhlen Trephin, amerikanisches Modell, 180 mm
 Antrum trephine, American pattern, 7 inch



252-053-170
FAULKNER
 Kieferhöhlenmeißel, 170 mm
 Antrum Chisel, 6 3/4 inch

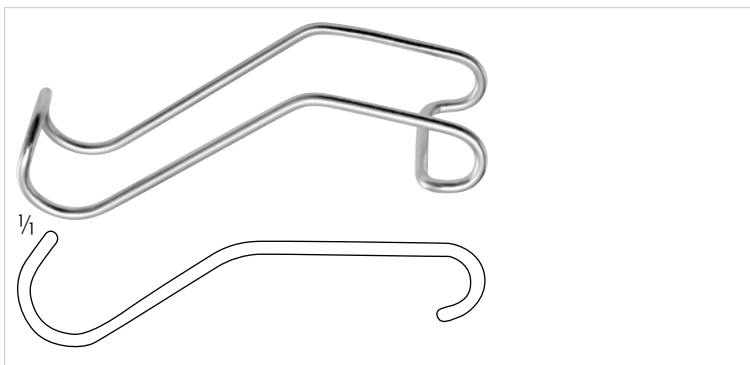

430-301-120 120 mm, 4 3/4 inch
 430-301-130 140 mm, 5 1/2 inch
 430-301-135 160 mm, 6 1/4 inch
STERNBERG
 Wangenhalter
 Cheek retractor

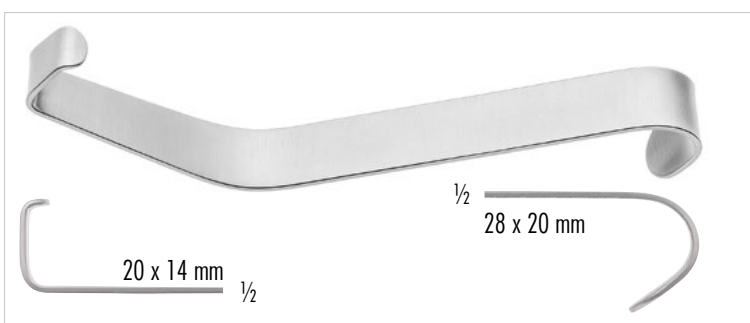

170-285-165
HAJEK
 Wundhaken, 180 mm
 Wound retractor, 7 inch



170-293-001 30 x 11 mm
LANGENBECK
 Wundhaken, 220 mm
 Wound retractor, 8 3/4 inch



252-500-175 3mm Ausschnitt/bite
 252-499-175 2mm Ausschnitt/bite
 Stirnhöhlenstanze, 70° im Schaft aufgebogen,
 40° nach oben vorwärts schneidend, Arbeitslänge: 140mm
 Frontal Sinus Punch Forceps, sheath 70° upturned,
 40° upbiting forward, working length: 5½ inch



252-150-110
 Antrum Stanze, 65° vorwärts schneidend,
 3,5 x 3,7mm Schnitt
 Antrum Punch, 65° forward biting,
 3.5 x 3.7mm bite



252-151-110
 Antrum Stanze, 30° aufgebogen
 Antrum Punch, 30° upwards curved

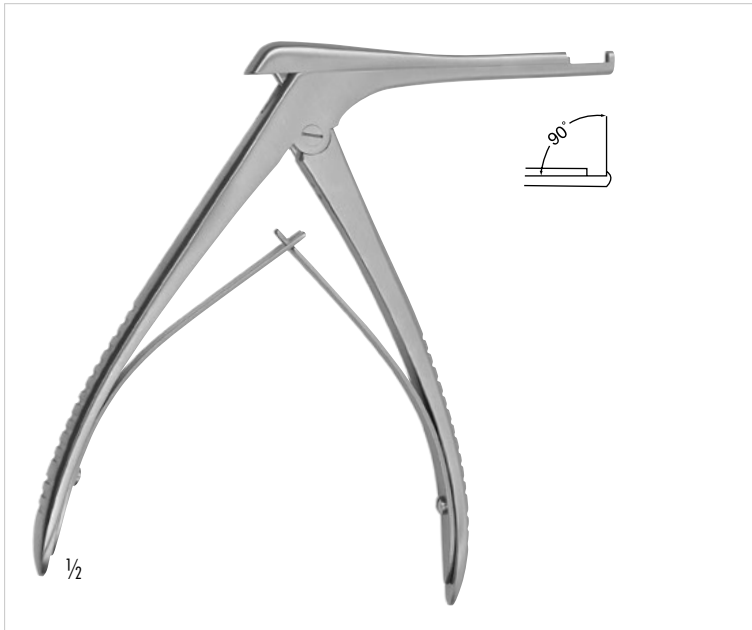

252-200-095 2 mm Schnitt / 2 mm bite
BEYER

Kieferhöhlenstanze, Arbeitslänge: 95 mm
 Antrum Punch, working length: 3 3/4 inch

252-200-195

Dito, retrograd schneidend
 Same, backward cutting

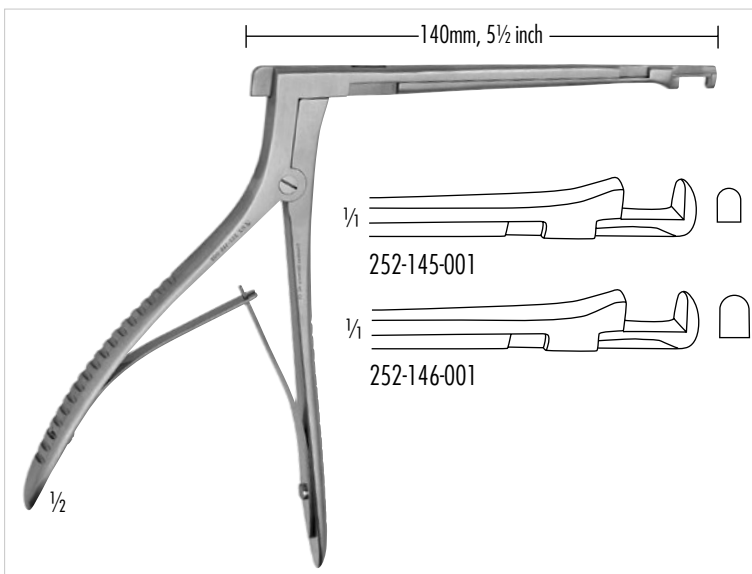

- 252-145-001 nach oben/upbiting
- 252-145-002 nach unten/downbiting
- 252-145-003 nach oben, rückwärts/upbiting, backward
- 252-145-004 nach unten, rückwärts/downbiting, backward
- 252-145-005 nach oben, vorwärts/upbiting, forward
- 252-146-001 nach oben/upbiting, 4.5 x 4.5 mm

HAJEK-KOFLER

Stanze, 3,5 x 3,5 mm, 140 mm
 Punch, 3.5 x 3.5 mm, 5 1/2 inch

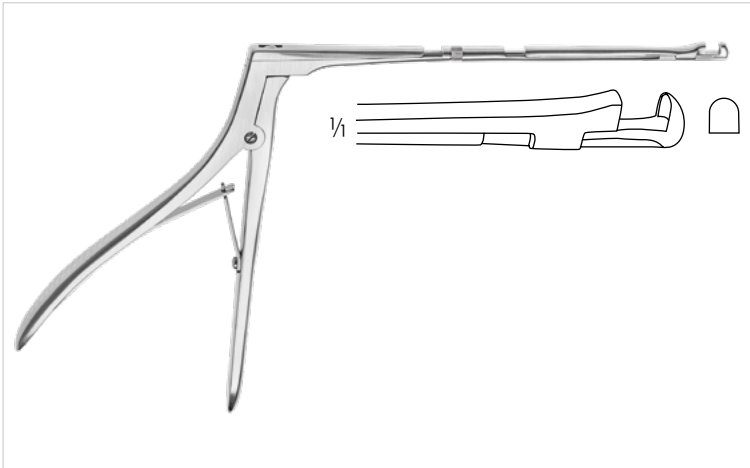

252-535-170 3,5 mm
HAJEK-KOFLER
 Stanze, drehbar 360°, Arbeitslänge: 170 mm
 Punch, rotating 360°, working length: 6 ¾ inch



252-147-170
CITELLI
 Knochenstanze, 1,5 mm, durchschneidend, Arbeitslänge: 170 mm
 Bone punch, 1.5 mm, through cutting, working length: 6 ¾ inch



252-148-170
BEYER
 Knochenstanze, 2,0 mm, durchschneidend, Arbeitslänge: 170 mm
 Bone punch, 2.0 mm, through cutting, working length: 6 ¾ inch



252-149-172 nach oben / upbiting
 252-149-272 nach unten / downbiting
KERRISON
 Knochenstanze, 2,0 mm, Arbeitslänge: 180 mm
 Bone punch, 2.0 mm, working length: 7 inch

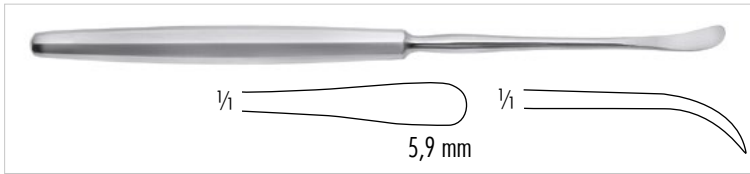

420-549-200 6 mm

SEWALLKieferhöhlen Elevator, stumpf, 200 mm
Antrum elevator blunt, 8 inch

252-009-000 4.5 mm Spitze / tip

252-009-001 6.5 mm Spitze / tip

FREERElevator, doppelendig, scharf/stumpf, 200 mm
Elevator, double-ended, sharp/blunt, 7 3/4 inch

252-025-210

KUHN-BOLGERDoppelinstrument, rechts abgewinkelter Haken, 210 mm
Double-instrument, hook angled to the right, 8 1/4 inch

252-025-190

Doppelinstrument zum Sondieren d. Ostium, kugelförmige
Enden 1,2 mm / 2,0 mm, 210 mm

Ostium probe, double-ended ball probe: 1.2mm / 2.0 mm, 8 1/4 inch



252-205-190 spitz/sharp

252-215-190 stumpf/blunt

Sichelmesser, spitz, 200 mm

Sickle knives, sharp, 7 3/4 inch



252-071-190 Gr. 1

252-082-190 Gr. 2

252-093-190 Gr. 3

Kieferhöhlenlöffel, oval, 200 mm

Antrum spoon, oval, 7 3/4 inch



252-171-190 rund, 45° gebogen/round, 45° curved

252-182-190 oval klein, gebogen/oval small, curved

252-193-190 oval groß, 30° gebogen/oval large, 30° angled

Kieferhöhlenlöffel, 200mm

Antrum spoon, 7 3/4 inch



252-027-190

Doppelkürette, oval, kurz gebogen 45°, halbscharf: 2,2 mm,
andere Seite: 90° lang gebogen, 2,7 mm, 190 mmCurette, double-ended, oval, short curve 45°, semi-sharp: 2.2 mm
Other side: 90° long curve: 2.7 mm, 7 1/2 inch

252-071-220

FAULKNER

Kieferhöhlenkürette, 220 mm

Antrum curette, 8 1/2 inch

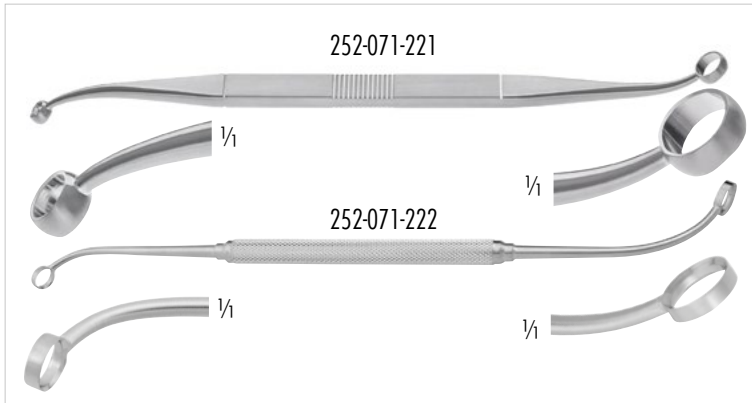

- 252-071-221 klein, Ringgröße 5 x 8 mm
small, ringsize 5 x 8 mm
- 252-071-222 groß, Ringgröße 6 x 9 mm
large, ringsize 6 x 9 mm

FAULKNER

Kieferhöhlenkürette, biegsam, 220 mm
Antrum curette, malleable, 8 3/4 inch

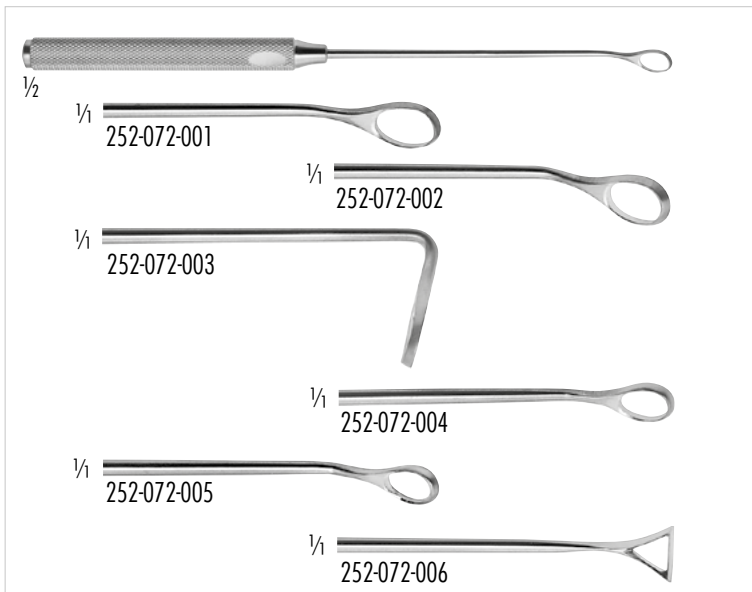

- 252-072-001 Fig. 1
252-072-002 Fig. 2
252-072-003 Fig. 3
252-072-004 Fig. 4
252-072-005 Fig. 5
252-072-006 Fig. 6

COAKLEY

Kieferhöhlenkürette, 170 mm
Antrum curette, rigid shank, 6 3/4 inch

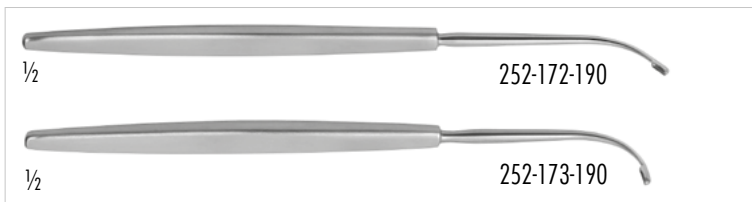

- 252-172-190 55° gebogen/curved
252-173-190 90° gebogen/curved

KUHN-BOLGER

Kieferhöhlenlöffel, 190 mm
Antrum spoon, 7 1/2 inch

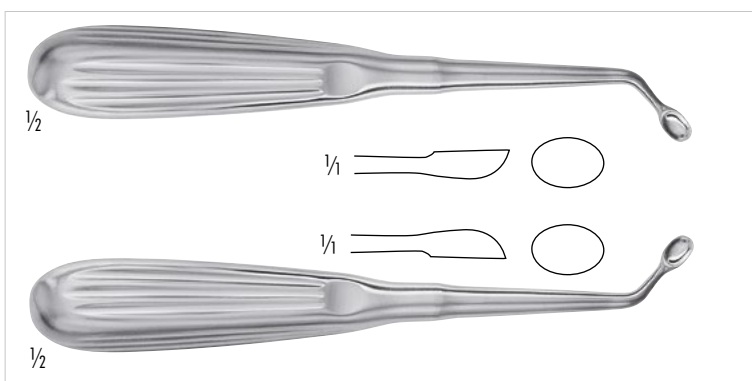

- 210-345-007 rechts gebogen/right curved
210-347-007 links gebogen/left curved

UFFENORDE

Kieferhöhlenlöffel, 170 mm
Antrum spoon, 6 3/4 inch

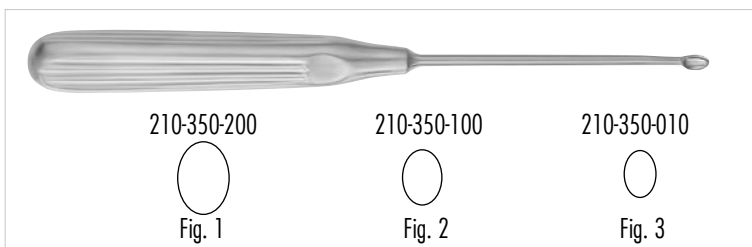

- 210-350-200 4,8 mm Fig. 1
210-350-100 5,8 mm Fig. 2
210-350-010 6,8 mm Fig. 3

HALLE

Scharfe Löffel, biegsam, 210 mm
Antrum spoon, malleable, sharp, 8 1/4 inch

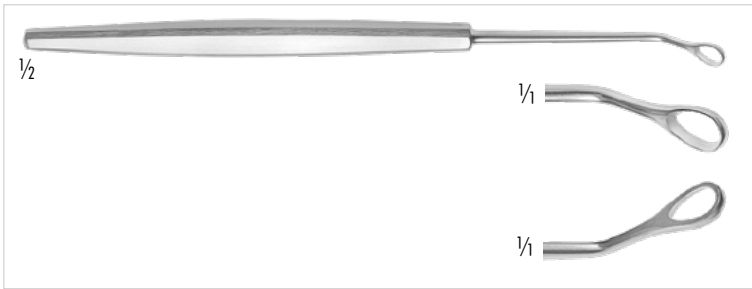

252-113-190 vorwärts schneidend/forward cutting
252-114-190 rückwärts schneidend/backward cutting
COAKLEY

Kieferhöhlenkürette, klein, 200 mm
Antrum curette, small, 7 3/4 inch

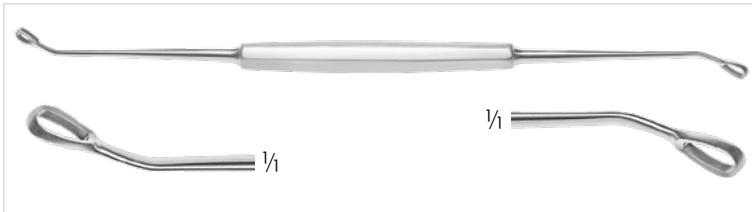

252-072-245

HALLE

Kieferhöhlenkürette, 200 mm
Antrum curette, 7 3/4 inch

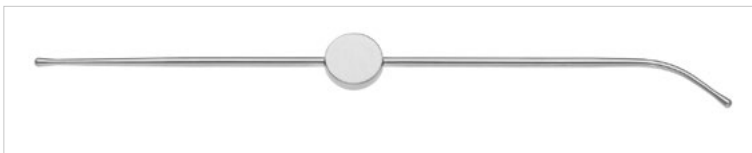

252-073-200

Kieferhöhlensonde, 200 mm
Antrum probe, 7 3/4 inch



252-140-190 4 mm

WEST

Hohlmeißel, 190 mm
Gouge, 7 1/2 inch



252-040-190 4 mm

WEST

Flachmeißel, 190 mm
Chisel, 7 1/2 inch



252-041-012 12 mm

252-041-017 17 mm

Spatel, biegsam, 200 mm
Spatula, malleable, 7 3/4 inch



252-042-235

Orbitalschützer, 235 mm
Orbital protector, 9 1/4 inch



- 252-043-025 Ø 2,5 mm
- 252-043-030 Ø 3,0 mm
- 252-043-040 Ø 4,0 mm
- 252-043-050 Ø 5,0 mm

RITTER

Stirnhöhledilatator, 160 mm
Frontal sinus bougies, 6 1/4 inch



- 165-525-006 6 Charr./Fr.
- 165-525-007 7 Charr./Fr.
- 165-525-008 8 Charr./Fr.
- 165-525-010 10 Charr./Fr.
- 165-525-012 12 Charr./Fr.

FERGUSSON

Saugkanüle, 180 mm
Suction tube, 7 inch



252-025-180

FISCH

Saug-Spülrohr, 2,5 x 2,0 mm, 180 mm
Suction-Irrigation tube, 2.5 x 2.0mm, 7 inch

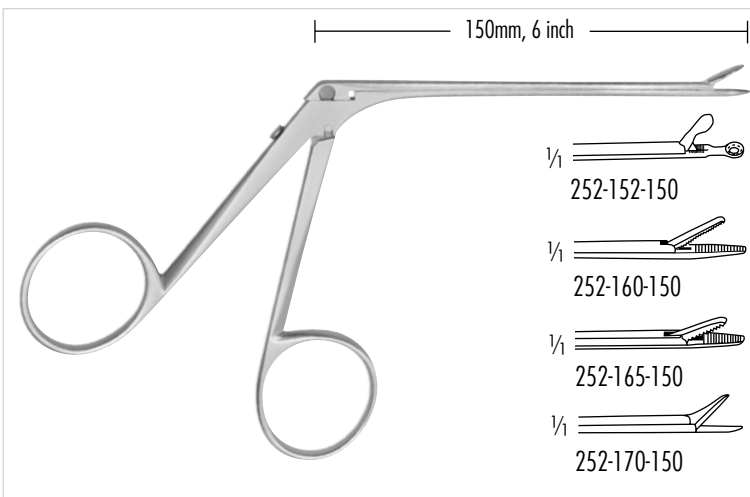

252-152-150 Ø 2,0 mm

Löffelzängchen, runder Löffel
Cupped forceps, round cup

1/1 252-152-150

252-160-150

Faßzängchen, fein gerieft
Grasping forceps, fine serrations

1/1 252-160-150

252-165-150

Faßzängchen, grob gerieft
Grasping forceps, coarse serrations

1/1 252-165-150

252-170-150

Scherchen
Scissors

1/1 252-170-150

FULL HD

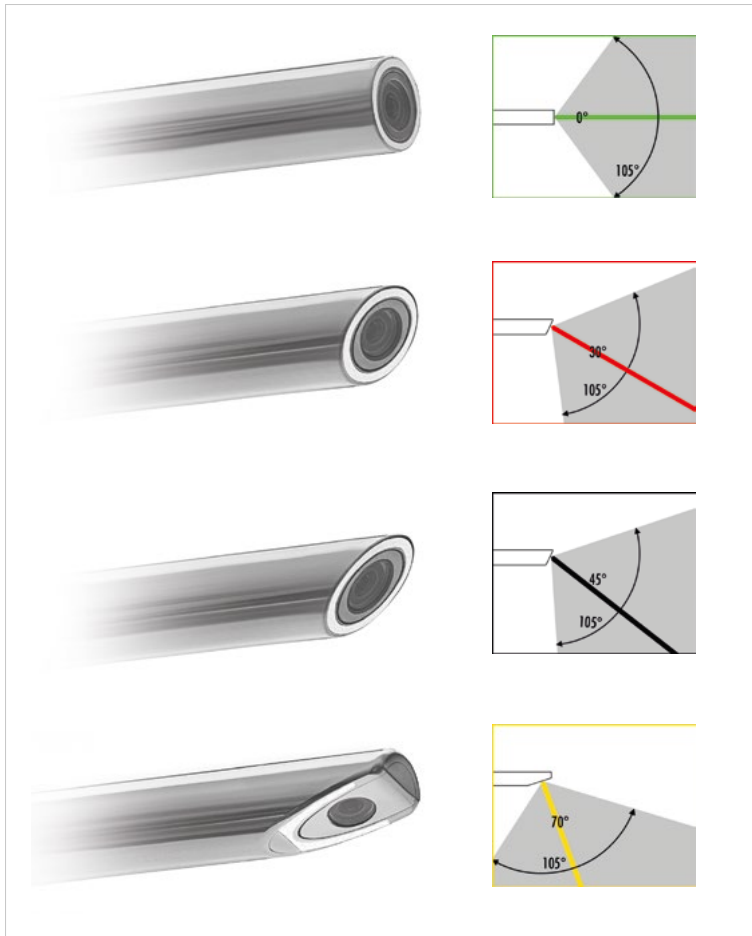

Colour coding of degree:
Farbliche Kennzeichnung der Gradzahl:

- 0°
- 30°
- 45°
- 70°

- Removable eyepiece for C-mount connection or RZ QuickSnap locking
- 3-step light post adaptors to connect the most common light cables directly to the endoscope
- Sapphire glasses ensure highest stability against damages on the lens system
- Optimised glass fibre arrangements ensure an uniform image brightness of highest quality
- Full HD high definition pictures with increased detail-resolution through newest CAD-designed rod-lens systems
- Fully Autoclavable at 134°C and 2.3bar

- Abnehmbares Okular für C-Mount-Anschluss oder RZ QuickSnap-Verschluss
- 3-Stufen-Adapter zum Anschluss der gängigsten Lichtkabel, direkt am Endoskop anschließbar
- Saphirgläser sorgen für höchste Stabilität gegen Beschädigungen am Linsensystem
- Optimierte Glasfaseranordnungen sorgen für eine gleichmäßige Bildhelligkeit von höchster Qualität
- Full HD hochauflösende Bilder mit erhöhter Detailauflösung durch neueste CAD-konstruierte Stablinsensysteme
- Vollständig autoklavierbar bei 134°C und 2,3bar



252-104-200 0°
 252-104-230 30°
 252-104-270 70°
 Sinuskopie-Optiken, Kinder, autoklavierbar, 4,0 mm, 110 mm
 Sinusscopes, pediatric, autoclavable, 4.0 mm, 4 1/3 inch

252-127-200 0°
 252-127-230 30°
 Sinuskopie-Optiken, Kinder, autoklavierbar, 2,7 mm, 110 mm
 Sinusscopes, pediatric, autoclavable, 2.7 mm, 4 1/3 inch



252-104-000 0°
 252-104-030 30°
 252-104-045 45°
 252-104-070 70°
 Sinuskopie-Optiken, autoklavierbar, 4,0 mm, 180 mm
 Sinusscopes, autoclavable, 4.0 mm, 7 inch

252-127-000 0°
 252-127-030 30°
 252-127-070 70°
 Sinuskopie-Optiken, autoklavierbar, 2,7 mm, 180 mm
 Sinusscopes, autoclavable, 2.7 mm, 7 inch



300-090-100

Schutzhülse, für 2,7 mm und 4,0 mm Optiken, 190 mm

Bestelleinheit: PH=Packung á 10 Stück

Protection tube, for 2.7 mm and 4.0 mm telescopes, 7 1/2 inch

Sales unit: PH=Package of 10 pieces



251-104-001 für 4 mm Optik / for 4 mm telescopes

251-127-001 für 2,5 mm Optik / for 2.7 mm telescopes

Optik Handgriff, flach, 120 mm

Telescope handle, flat, 4 3/4 inch



251-104-002 für 4 mm Optik / for 4 mm telescopes

251-127-002 für 2,5 mm Optik / for 2.7 mm telescopes

Optik Handgriff, rund, 120 mm

Telescope handle, round, 4 3/4 inch

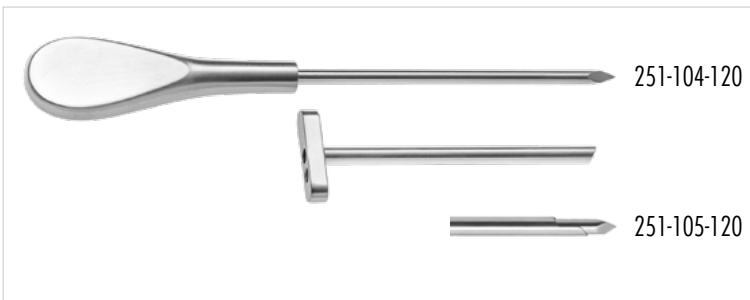

251-104-120 schräges Schaftende/oblique sheath end

251-105-120 Duckbill Schaftende/Duckbill sheath end

251-127-120 für 2,7 mm Optik, 80 mm

for 2.7 mm telescope, 3 1/8 inch

Sinuskopie-Trokar und Trokarhülse für 4,0 mm Optik,

scharfer Trokar Ø 5,2 mm, 80 mm

Sinuscopy Trocar and Trocar sheath for 4.0 mm telescope,

sharp trocar Ø 5,2 mm, 3 1/8 inch



420-121-150 Fig. 1

420-122-150 Fig. 2

420-123-150 Fig. 3

HARTMANN-HALLE

Nasenspekulum, 155 mm

Nasal Specula, 6 inch



420-150-001 links/left 55mm, rechts/right 35mm

420-150-002 links/left 35mm, rechts/right 55mm

420-150-003 links/left 65mm, rechts/right 45mm

420-150-004 links/left 45mm, rechts/right 65mm

420-150-005 links/left 75mm, rechts/right 35mm

420-150-006 links/left 35mm, rechts/right 75mm

420-150-007 links/left 75mm, rechts/right 52mm

420-150-008 links/left 52mm, rechts/right 75mm

Sinus Spekula zur Verwendung mit flexiblen Spannarm,

mit Zähnen, mit Stellschraube

Sinus Specula for use with flexible arm, with teeth,

with set screw

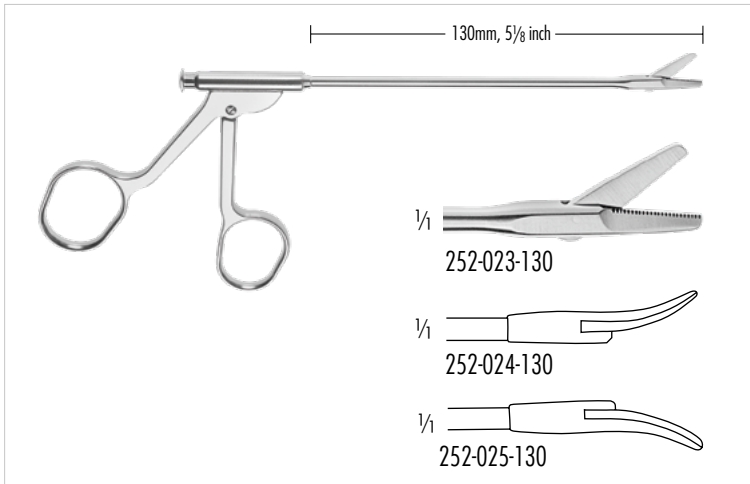

252-023-130 gerade/straight
 252-024-130 links gebogen/curved to left
 252-025-130 rechts gebogen/curved to right
 Nasenschere, 130 mm
 Nasal scissors, 5 1/8 inch

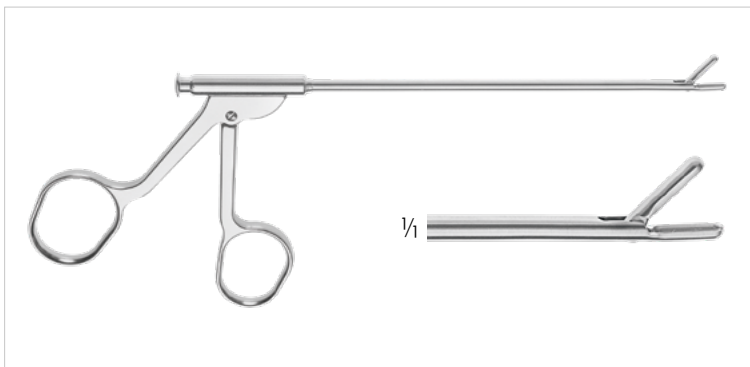

252-002-130
TAKAHASHI
 Siebbeinzange, 3x10 mm, 130 mm
 Ethmoidal forceps, 3x10 mm, 5 1/8 inch

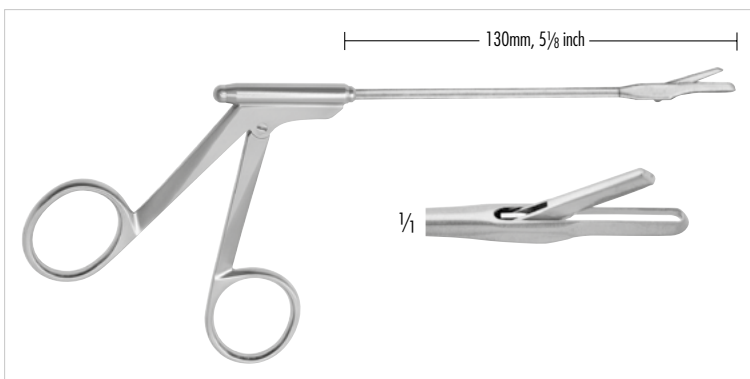

252-003-130
STRUYCKEN
 Siebbeinzange, 130 mm
 Ethmoidal forceps, 5 1/8 inch

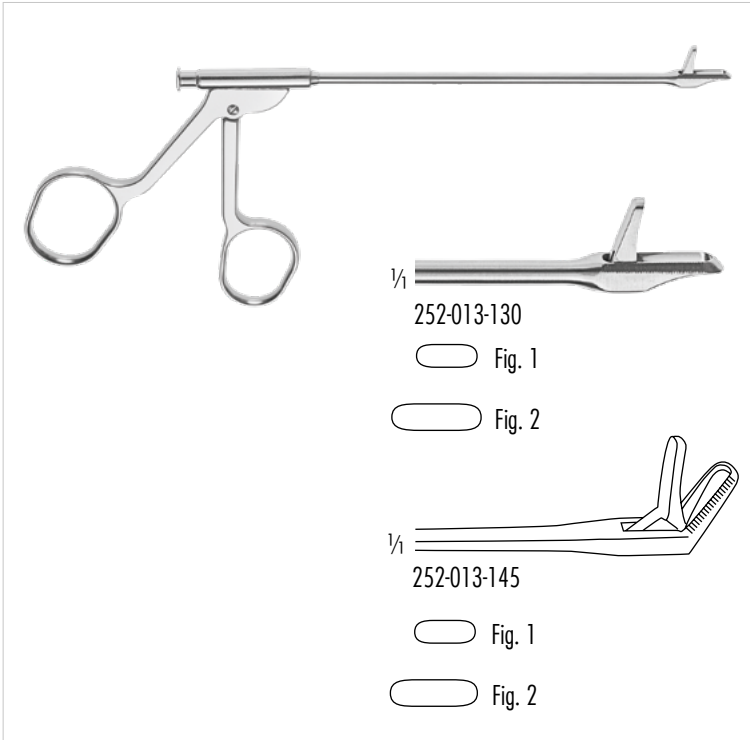

252-013-130 Fig. 1 8 x 3 mm
252-014-135 Fig. 2 11,5 x 3,5 mm

GRUENWALD-HENKE

Scharfe Nasenzange, durchschneidend, für glatten, gewebeschonenden Schnitt, extra zart, Arbeitslänge: 130 mm
Ethmoidal forceps, through cutting for clean soft tissue cut, straight, working length: 5 1/8 inch

252-013-145 Fig. 1 8 x 3 mm
252-014-145 Fig. 2 11,5 x 3,5 mm

GRUENWALD-HENKE

45° aufgebogen
45° upwards



252-206-000 Fig. 0 2 mm Schnitt/2 mm bite
252-206-001 Fig. 1 2,5 mm Schnitt/2.5 mm bite
252-206-002 Fig. 2 3 mm Schnitt/3 mm bite

DUCKBILL

Duckbill Punch, gerade, Arbeitslänge: 130 mm
Duckbill Punch, straight, working length: 5 1/8 inch

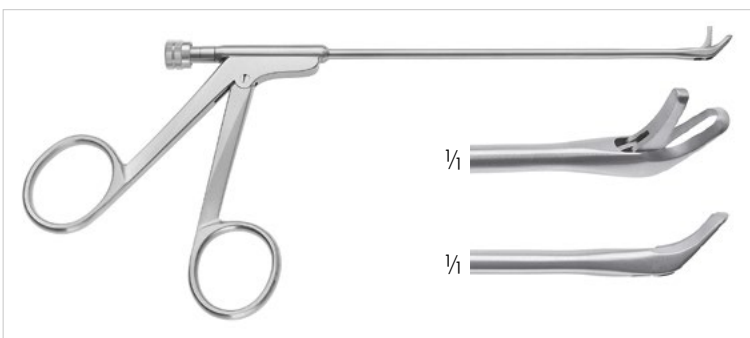

252-207-000 Fig. 0 2 mm Schnitt/2 mm bite
252-207-001 Fig. 1 2,5 mm Schnitt/2.5 mm bite
252-207-002 Fig. 2 3 mm Schnitt/3 mm bite

DUCKBILL

Duckbill Punch, aufwärts, Arbeitslänge: 130 mm
Duckbill Punch, upwards, working length: 5 1/8 inch



252-034-131 Größe 1/size 1 = 3 mm
252-034-132 Größe 2/size 2 = 3.5 mm
252-034-133 Größe 3/size 3 = 4 mm
252-034-134 Größe 4/size 4 = 5 mm
252-034-135 Größe 5/size 5 = 6 mm

BLAKESLEY

Nasenzange, gerade, 130 mm
Ethmoidal forceps, straight, 5 1/8 inch

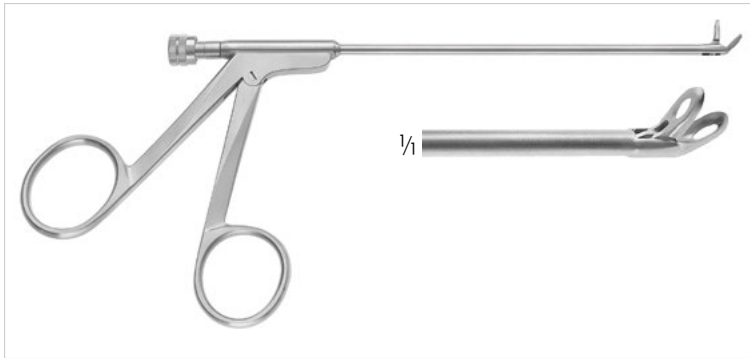

- 252-035-131 Größe 1/size 1 = 3 mm
- 252-035-132 Größe 2/size 2 = 3.5 mm
- 252-035-133 Größe 3/size 3 = 4 mm
- 252-035-134 Größe 4/size 4 = 5 mm
- 252-035-135 Größe 5/size 5 = 6 mm

BLAKESLEY-WILDE

Nasenzange, 45° aufgebogen, 130 mm
Ethmoidal forceps, 45° angled, 5 1/8 inch

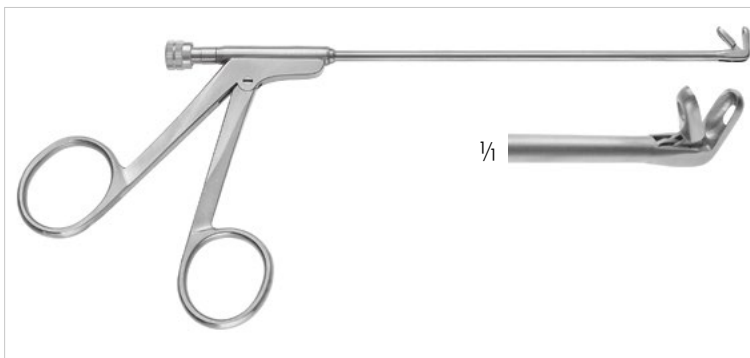

- 252-037-131 Größe 1/size 1 = 3 mm
- 252-037-132 Größe 2/size 2 = 3.5 mm
- 252-037-133 Größe 3/size 3 = 4 mm

BLAKESLEY-WILDE

Nasenzange, 90° aufgebogen, 130 mm
Ethmoidal forceps, 90° angled, 5 1/8 inch

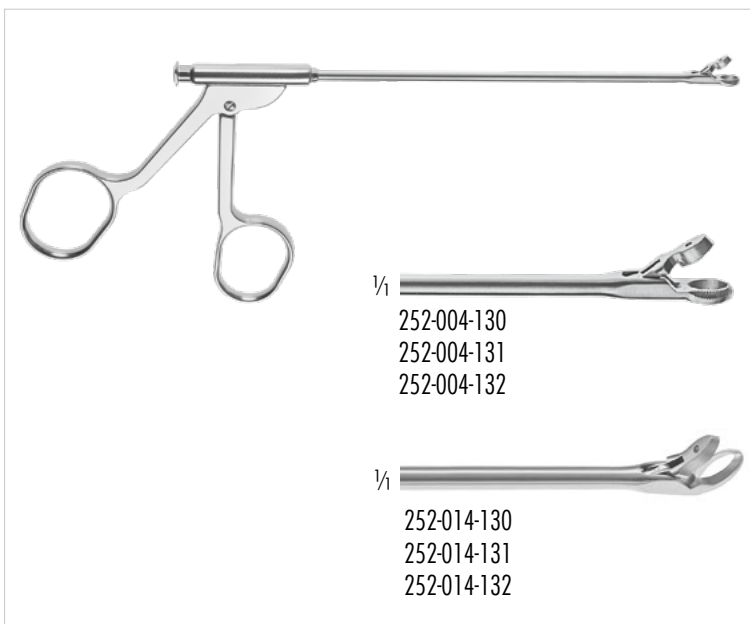

- 252-004-130 Fig. 0 3 mm breit
- 252-004-131 Fig. 1 3,5 mm breit
- 252-004-132 Fig. 2 4,0 mm breit

BLAKESLEY

Scharfe Nasenzange, durchschneidend, für glatten, gewebeschonenden Schnitt, gerade, 130 mm
Ethmoidal forceps, through cutting for clean soft tissue cut, straight, 5 1/8 inch

252-004-130
252-004-131
252-004-132

252-014-130
252-014-131
252-014-132

- 252-014-130 Fig. 0 3 mm breit
- 252-014-131 Fig. 1 3,5 mm breit
- 252-014-132 Fig. 2 4,0 mm breit

BLAKESLEY

45° aufgebogen
45° upwards

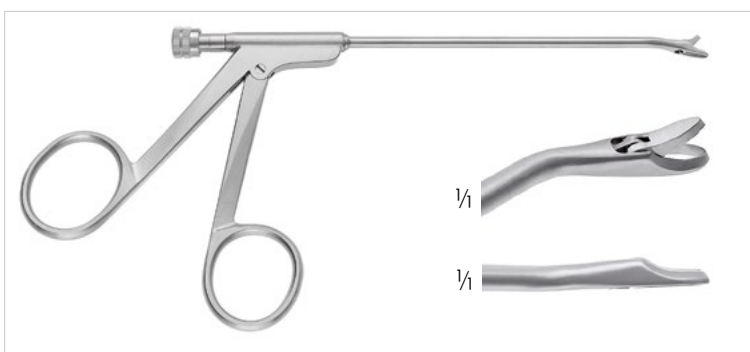

- 252-401-025 30° links gebogen/curved left
- 252-403-025 30° rechts gebogen/curved right

BLAKESLEY

Nasenzange, durchschneidend, 2,5 mm Schnitt, Arbeitslänge: 115 mm
Nasal Forceps, through cutting, 2.5 mm bite, working length: 4 1/2 inch

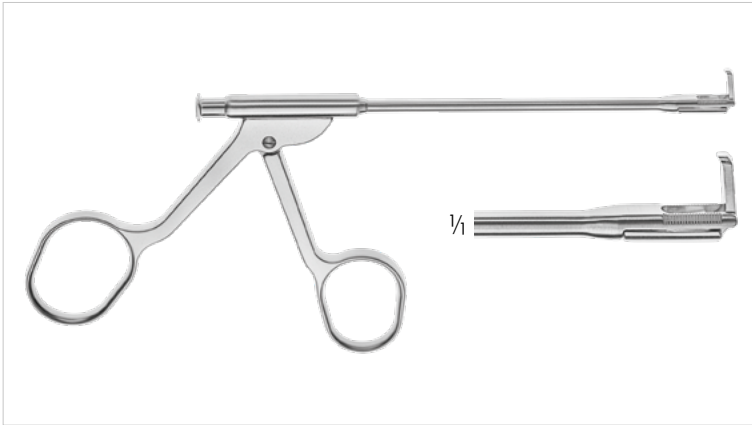

252-015-100 oben/upside
 252-115-100 rechts/right
 252-215-100 links/left

OSTROM

Kieferhöhlenstanze, 2,5 mm Schnitt, rückwärts schneidend,
 Arbeitslänge: 100 mm
 Antrum punch, 2.5 mm cut, backward cutting,
 working length: 4 inch

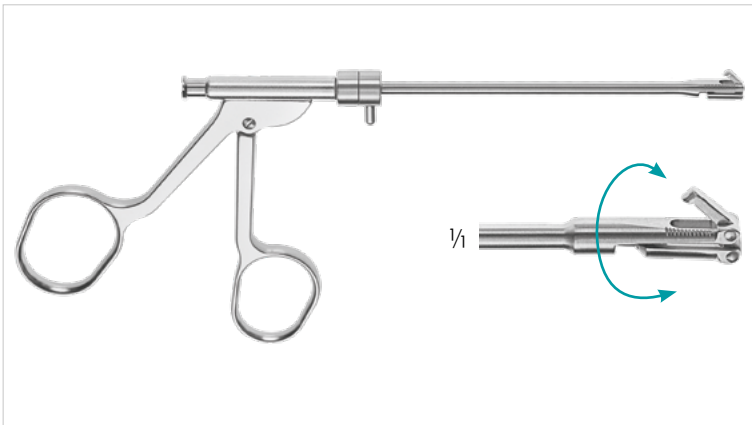

252-315-100 drehbar, 360°/rotating, 360°

OSTROM

Kieferhöhlenstanze, rückwärts schneidend, 2,5 mm Schnitt,
 Arbeitslänge: 100 mm
 Antrum punch, backward cutting, 2.5 mm cut,
 working length: 4 inch



252-010-100 oben/upside
 252-110-100 rechts/right
 252-210-100 links/left

OSTROM

Kieferhöhlenstanze, kleines schlankes Modell, 1,5 mm Schnitt,
 rückwärts schneidend, Arbeitslänge: 100 mm
 Antrum punch, small delicate pattern, 1.5 mm bite, backward cutting,
 working length: 4 inch

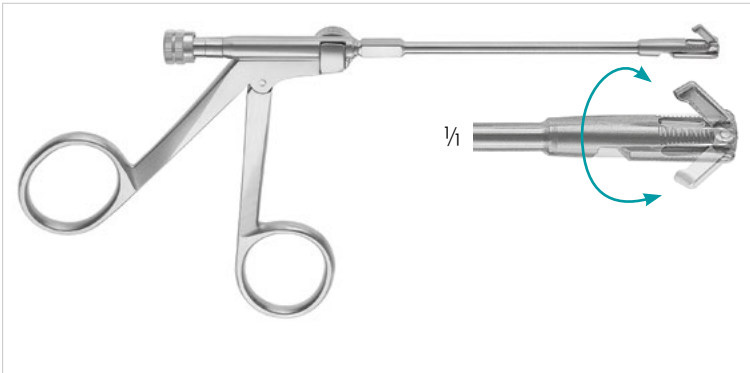

252-310-100 drehbar, 360°/rotating, 360°

OSTROM

Kieferhöhlenstanze, kleines schlankes Modell, 1,5 mm Schnitt
Arbeitslänge: 100 mm
Antrum punch, small delicate pattern, 1.5 mm bite,
working length: 4 inch

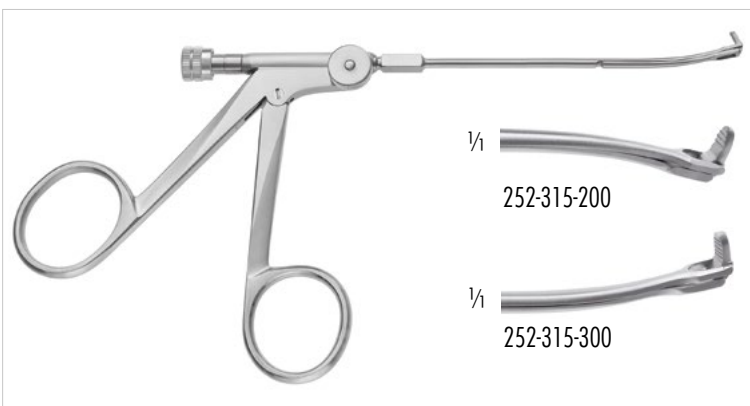

252-315-200 abgebogen/curved down

252-315-300 aufgebogen/curved up

OSTROM

Nasenzange, drehbar, kleiner Schnitt, Arbeitslänge: 100 mm
Ethmoidal forceps, rotating, micro bite, working length: 4 inch

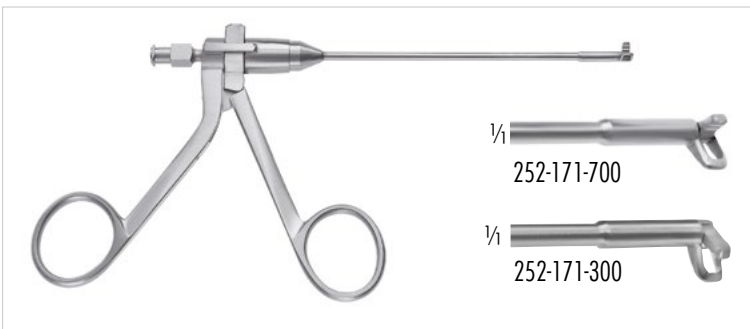

252-173-700 links schneidend/left cutting

252-171-700 rechts schneidend/right cutting

252-171-300 nach rechts unten schneidend/
downward right cutting

252-173-300 nach links unten schneidend/
downward left cutting

SIDECUTTER

Kieferhöhlenstanze, 2,5 mm Schnitt, Arbeitslänge: 100 mm
Antrum Punch, 2.5 mm bite, working length: 4 inch

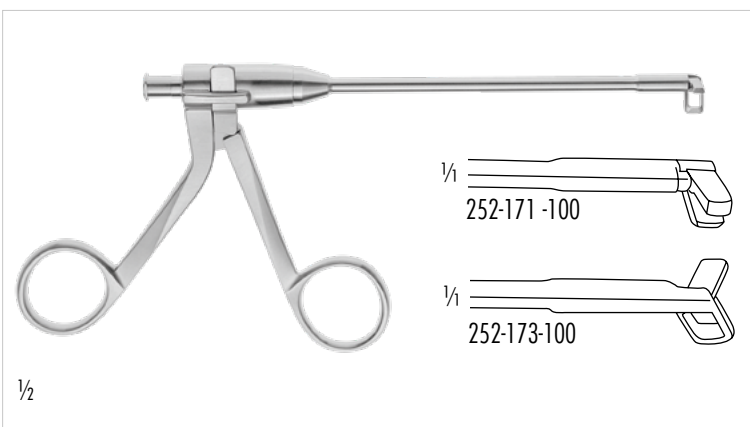

252-171-100 nach rechts unten schneidend
downward right cutting

252-173-100 nach links unten schneidend
downward left cutting

SIDECUTTER

Kieferhöhlenstanze, 3,5mm Schnitt, Arbeitslänge: 100 mm
Antrum punch, 3.5mm cut, working length: 4 inch

1/2

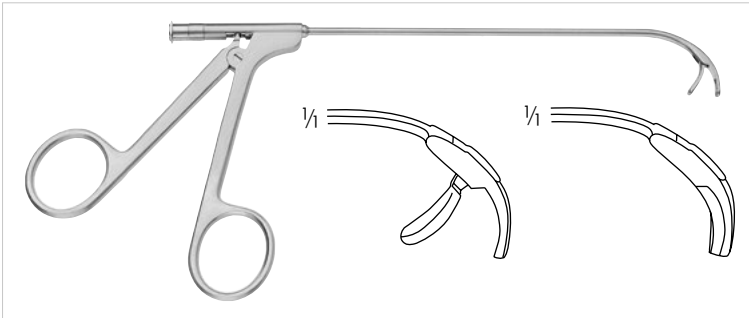

252-410-112

HEUWIESER

Kieferhöhlen-Faßzange, 90° gebogen, bis 120° rückwärts öffnend, Arbeitslänge: 130 mm

Antrum grasping forceps, 90° curved, 120° backward opening, working length: 5 inch

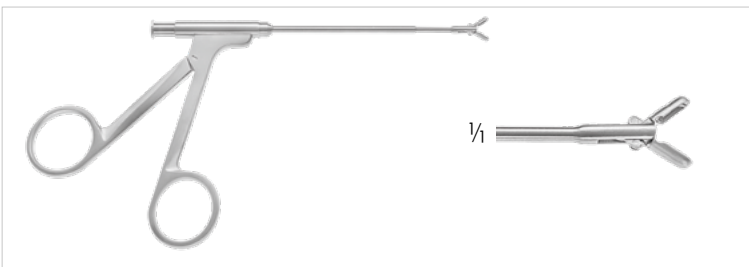

252-503-090

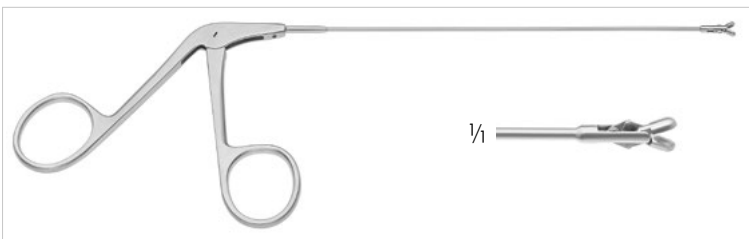
Biopsie- und Fasszange, ovaler Löffel, 3x6mm, 89mm Arbeitslänge
Biopsy and Grasping forceps, 3x6mm oval cup, 89mm working length

252-503-140

Probexcisions- und Faßzange, extra fein, mit ovalem Löffel 3 mm, 140 mm

Biopsy and Grasping forceps, delicate pattern, 3 mm oval cup, 5 1/2 inch

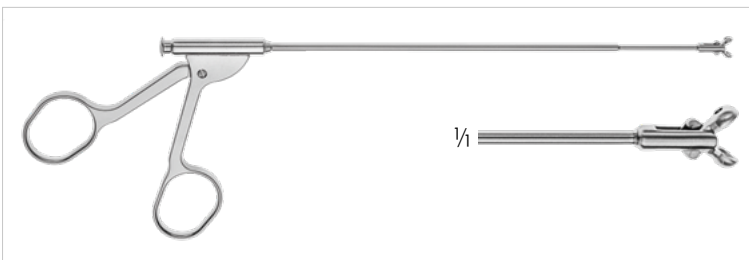

252-174-180

Probexcision- und Fasszange, Schaftende biegsam, 4 mm Löffel, vertikal öffnend, 180 mm

Biopsy and Grasping forceps, malleable shaft, 4 mm biopsy cup, vertical opening, 7 inch

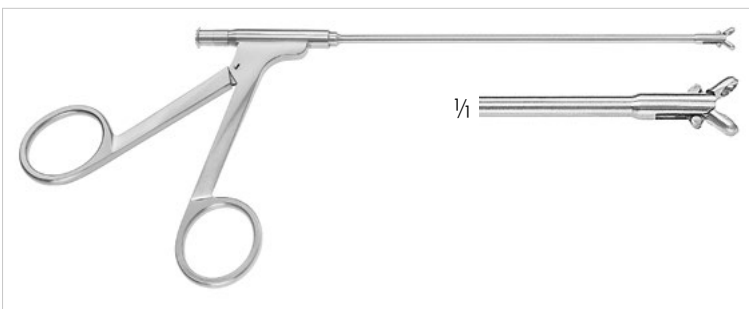

252-503-150

Biopsie- und Faßzange, 3mm Löffel rund, gerade, mit Luer-Lock, 150mm Arbeitslänge

Biopsy and Grasping Forceps, 3mm round cup, straight, with luer-lock, 150mm working length

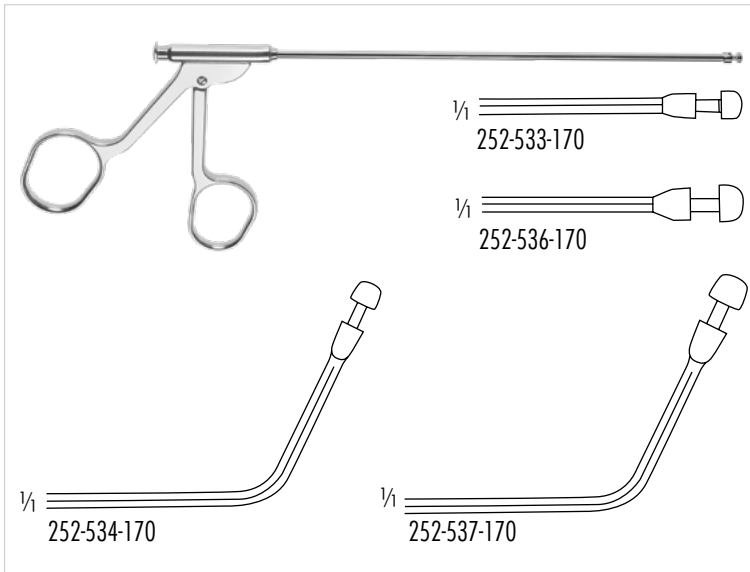

252-533-170 Ø 3,5 mm
252-536-170 Ø 4,5 mm

STAMMBERGER

Zirkular Stanze, gerade, 160 mm
Circular punch, straight, 6 ¼ inch

252-534-170 Ø 3,5 mm
252-537-170 Ø 4,5 mm

STAMMBERGER

Zirkular Stanze, 65° aufgebogen, 160 mm
Circular punch, 65° curved up, 6 ¼ inch

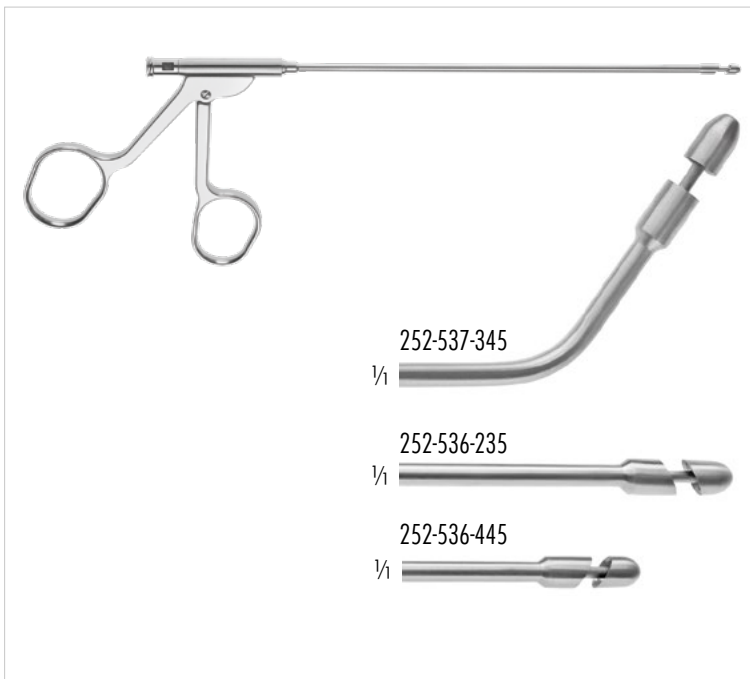

252-537-335 3.5mm Ø
252-537-345 4.5mm Ø

RZ

Circular Stanze, 60° aufgebogener Schaft, eiförmiger Schnitt, Arbeitslänge: 160 mm
Circular Punch, 60° upturned shaft, egg-shaped bite, working length: 6 ¼ inch

252-536-235 3.5mm Ø
252-536-245 4.5mm Ø

RZ

Circular Stanze, 120° schräger Schnitt, Arbeitslänge: 160 mm
Circular Punch, 120° oblique bite, working length: 6 ¼ inch

252-536-435 3.5mm Ø
252-536-445 4.5mm Ø

RZ

Circular Stanze, eiförmige Maulspitze, 60° schräger Schnitt, Arbeitslänge: 160 mm
Circular Punch, egg-shaped tip, 60° oblique bite, working length: 6 ¼ inch

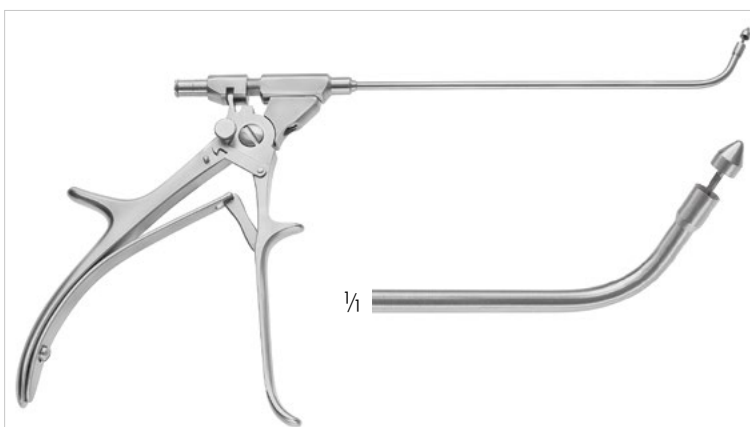

252-534-270 3.5mm Ø
252-537-270 4.5mm Ø

RZ

RZ-Circular Stanze, 70° aufwärts gebogen, mit Luer-Lock, Arbeitslänge: 130 mm
Circular Punch, 70° upturned shaft, with Luer-Lock, working length: 5 inch

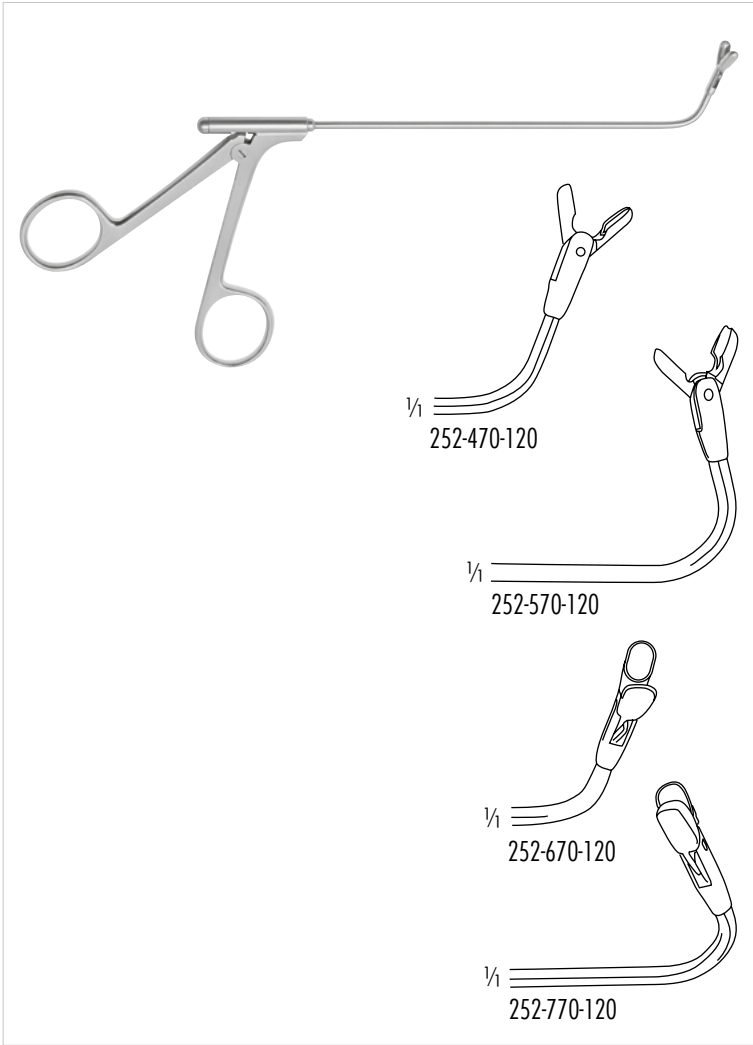

252-470-120 70° aufgebogen
 252-570-120 110° rückwärts gebogen

RZ-GIRAFFE

Doppellöffelzange, vertikal öffnend, Löffel Ø 4x8 mm, 130 mm
 Biopsy forceps, vertical action, Ø 4x8 mm, 5 1/8 inch

252-670-120 70° aufgebogen
 252-770-120 110° rückwärts gebogen

RZ-GIRAFFE

Doppellöffelzange, horizontal öffnend, Löffel Ø 4x8 mm, 130 mm
 Biopsy forceps, horizontal action, Ø 4x8 mm, 5 1/8 inch

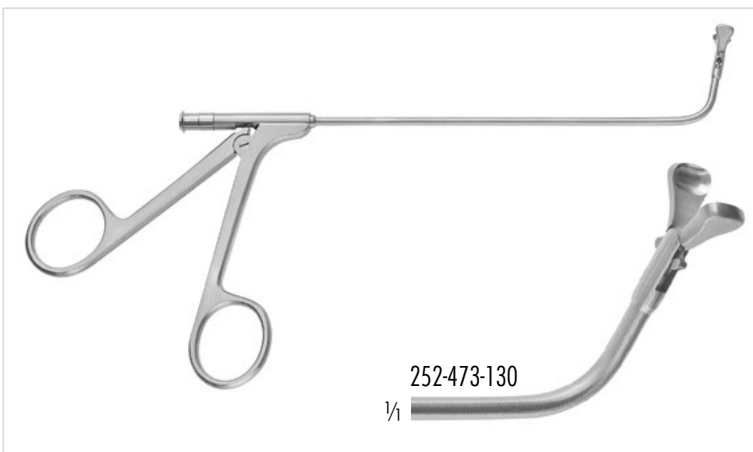

252-473-130 horizontal öffnend/horizontal opening

252-472-130 vertikal öffnend/vertical opening

Doppellöffelzange mit birnenförmigem Maulteil,
 80° aufgebogen, Arbeitslänge: 130 mm

Double action Biopsy Forceps, pear shaped jaws,
 80° angled up, working length: 5 1/8 inch

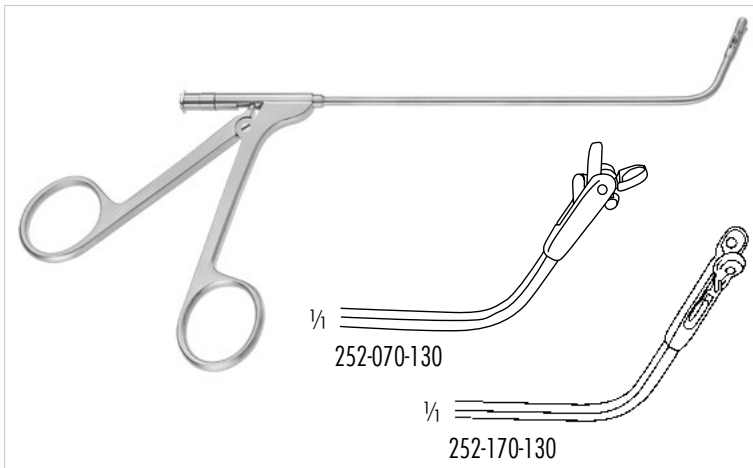

- 252-070-130 vertikal öffnend/vertical action
 252-170-130 horizontal öffnend/horizontal action

RZ-GIRAFFE

Doppellöffelzange, 70° aufgebogen, Löffel Ø 3 mm,
 Arbeitslänge: 130 mm
 Biopsy forceps, 70° angled, cup Ø 3 mm,
 working length 5 1/8 inch

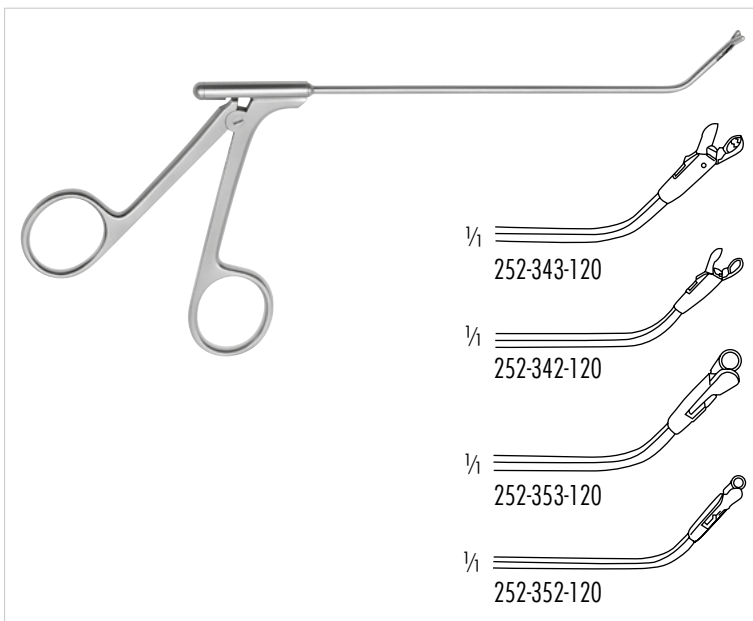

- 252-343-120 vertikal öffnend, 3x6 mm, 70° aufgebogen
 vertical action, 3x6 mm, 70° angled up
 252-342-120 vertikal öffnend, 2x4 mm, 55° aufgebogen
 vertical action, 2x4 mm, 55° angled up
 252-353-120 horizontal öffnend, 3x6 mm, 70° aufgebogen
 horizontal action, 3x6 mm, 70° angled up
 252-352-120 horizontal öffnend, 2x4 mm, 55° aufgebogen
 horizontal action, 2x4 mm, 55° angled up

KUHN-BOLGER

Doppellöffelzange, 130 mm
 Giraffe forceps, 5 1/8 inch

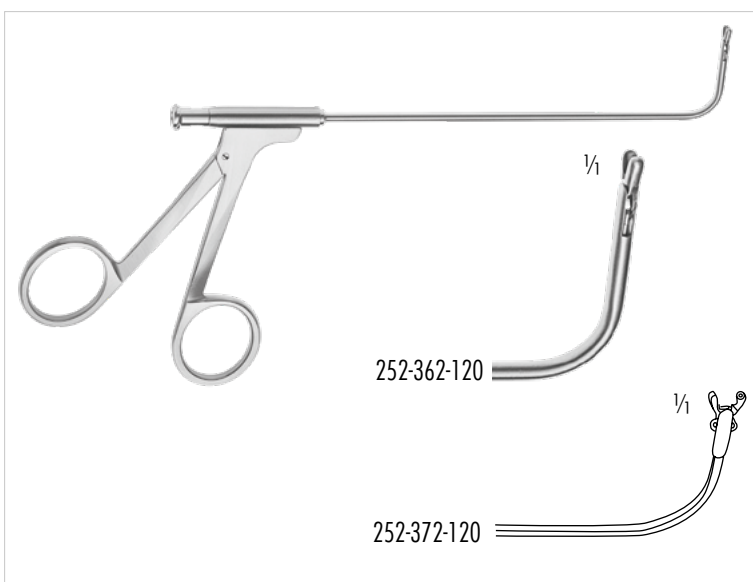

- 252-362-120 horizontal öffnend, 2x4 mm
 horizontal action, 2x4 mm
 252-372-120 vertikal öffnend, 2x4 mm
 vertical action, 2x4 mm

KUHN-BOLGER

Doppellöffelzange, 90° aufgebogen, 130 mm
 Giraffe forceps, 90° angled up, 5 1/8 inch

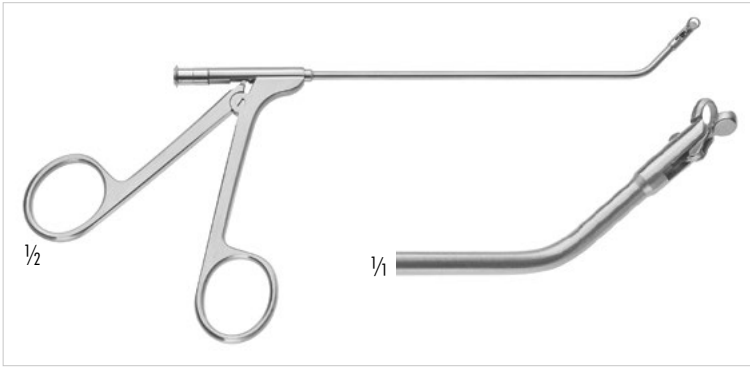

252-606-345 45° aufgebogen/45° upwards curved
 252-606-390 90° aufgebogen/90° upwards curved
 Sinuskopie Stanze, durchschneidend, 3mm runder Schnitt,
 horizontal öffnend, Arbeitslänge: 130 mm
 Sinuscopy Punch, through cutting, 3 mm round bite,
 horizontal opening, working length: 5 1/8 inch

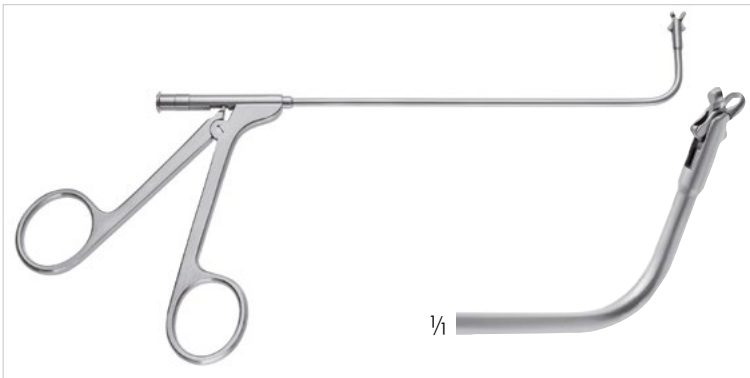

252-605-090 Vertikal öffnend/vertical opening
 252-606-090 Horizontal öffnend/horizontal opening
 Sinuskopie Stanze, durchschneidend, 2 mm runder Schnitt,
 90° aufgebogen, Arbeitslänge: 130 mm
 Sinuscopy Punch, through cutting, 2 mm round bite,
 90° upwards curved, working length: 5 1/8 inch

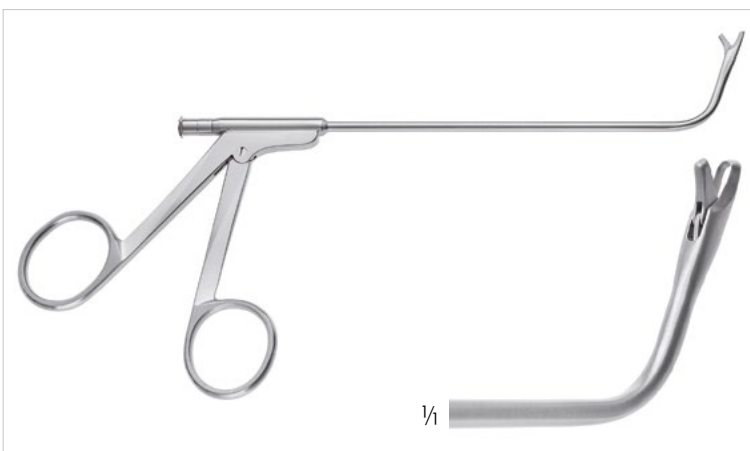

252-600-070 nach oben öffnend/backward opening
 252-601-070 nach rechts öffnend/right side opening
 252-602-070 nach links öffnend/left side opening
GRUENWALD
 Sinuskopie Zange, durchschneidend, 2 mm Schnitt, 70° aufgebogen,
 Arbeitslänge: 130 mm
 Sinuscopy Forceps, through cutting, 2 mm bite, 70° upwards curved,
 working length: 5 1/8 inch

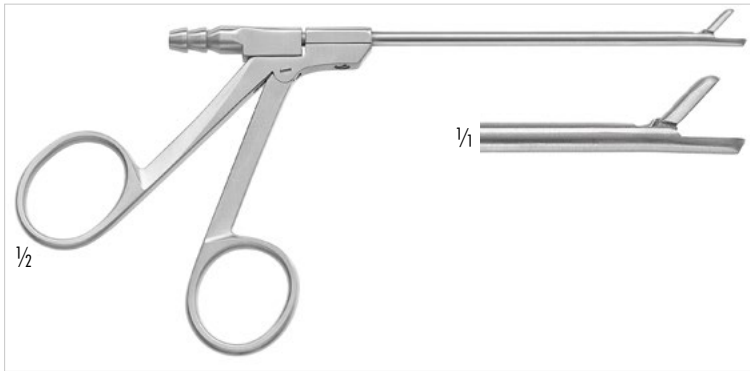

252-021-100 Größe 1/Size 1, 2.5mm
 252-022-100 Größe 2/Size 2, 3.5mm
 252-023-100 Größe 3/Size 3, 4.0mm

BLAKESLEY

Saugstanze, gerade, 100 mm Arbeitslänge, Ø 4mm
 Suction Punch, straight, 4 inch working length, Ø 4mm

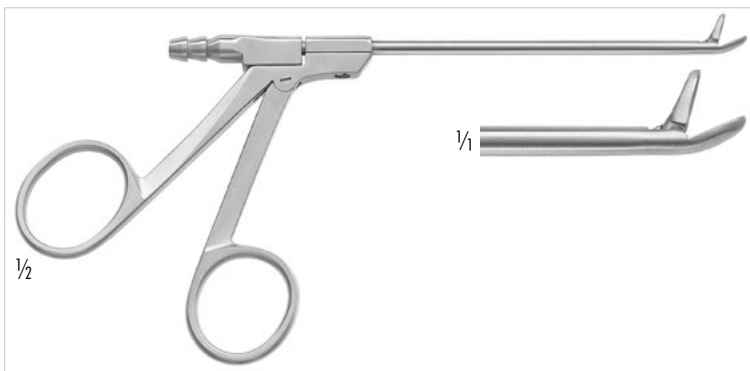

252-121-100 Größe 1/Size 1, 2.5mm
 252-122-100 Größe 2/Size 2, 3.5mm
 252-123-100 Größe 3/Size 3, 4.0mm

BLAKESLEY

Saugstanze, 45° aufgebogen, 100 mm Arbeitslänge, Ø 4mm
 Suction Punch, 45° upcurved, 4 inch working length, Ø 4mm

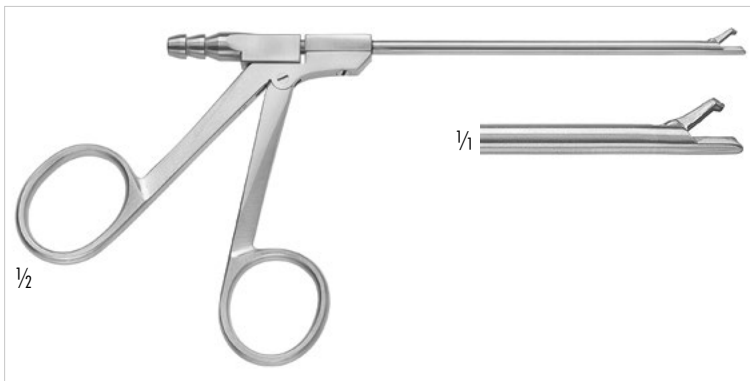
**252-502-100**

Biopsie Zange mit Absaugung, 2mm breit, durchschneidend,
 Arbeitslänge: 100mm

Biopsy Forceps with suction, 2mm wide, thru-cutting,
 working length: 4 mm

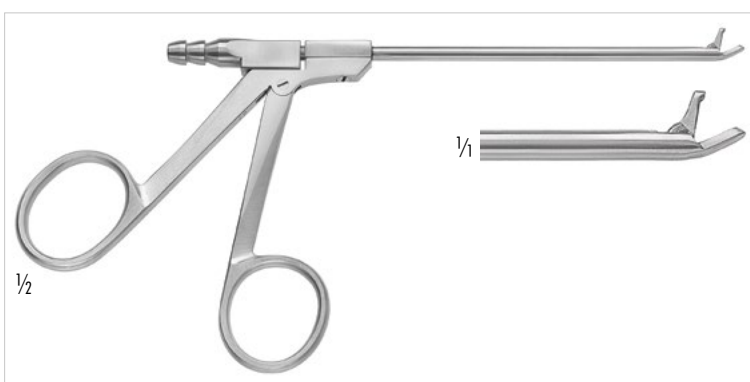
**252-502-145**

Biopsie Zange mit Absaugung, 2mm breit, durchschneidend,
 45° aufwärts gebogen, Arbeitslänge: 100mm

Biopsy Forceps with suction, 2mm wide, through-cutting,
 45° upcurved, working length: 4 inch

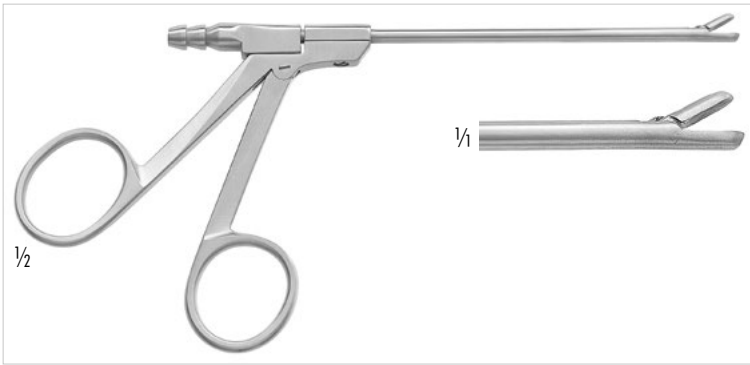

- 252-010-025 2.5mm, gerade/straight
- 252-010-035 3.5mm, gerade/straight
- 252-011-025 2.5mm, 30° aufgebogen/30° upcurved
- 252-011-035 3.5mm, 30° aufgebogen/30° upcurved

TAKAHASHI

Saugstanze für Biopsie und Greifen, Ø 4mm,
Arbeitslänge: 100 mm
Suction Punch for biopsy and grasping, Ø 4mm,
working length: 4 inch

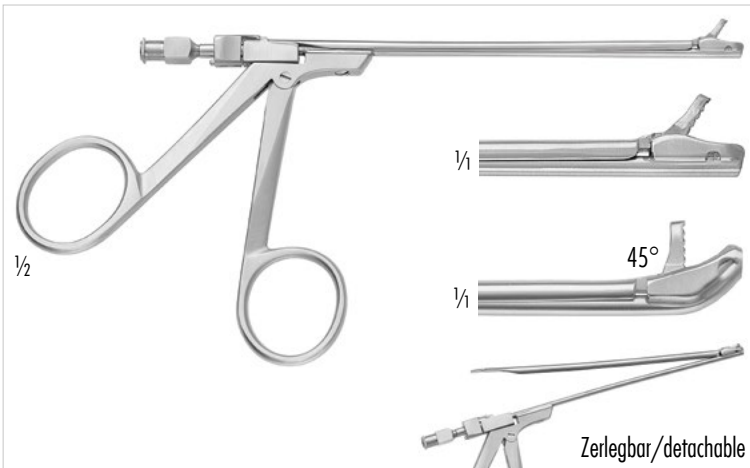

- 252-504-100 gerade/straight
- 252-505-100 45° aufgebogen/45° upcurved

BLAKESLEY

Biopsie Zange mit frontaler Absaugung, 2,5mm breit,
durchschneidend, zerlegbar, Arbeitslänge: 100 mm
Biopsy Forceps with frontal suction channel, 2.5mm wide,
through-cutting, detachable, working length: 4 inch

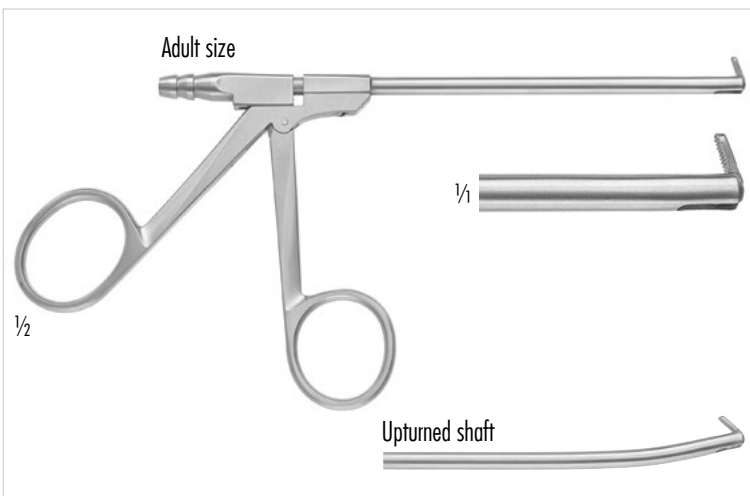

- 252-015-500 Aufwärts/upside
- 252-015-510 Links/left
- 252-015-520 Rechts/right

OSTROM

Saugstanze, gerade, Ø 4mm, rückwärts schneidend, 2,5mm Schnitt,
Arbeitslänge: 100 mm
Suction Punch, straight, backward cutting, Ø 4mm, 2.5mm bite,
working length: 4 inch

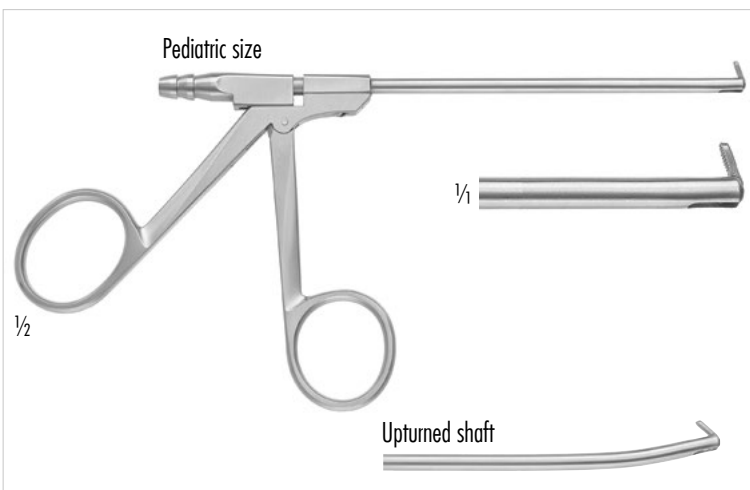

- 252-015-300 Aufwärts/upside
- 252-015-310 Links/left
- 252-015-320 Rechts/right
- 252-015-400 Aufgewinkelter Schaft, aufwärts
Upturned shaft, upside

OSTROM

Saugstanze, Ø 4mm, rückwärts schneidend, 2,0mm Schnitt,
Arbeitslänge: 100 mm
Suction Punch, Ø 4mm, backward cutting, 2.0mm bite,
working length: 4 inch

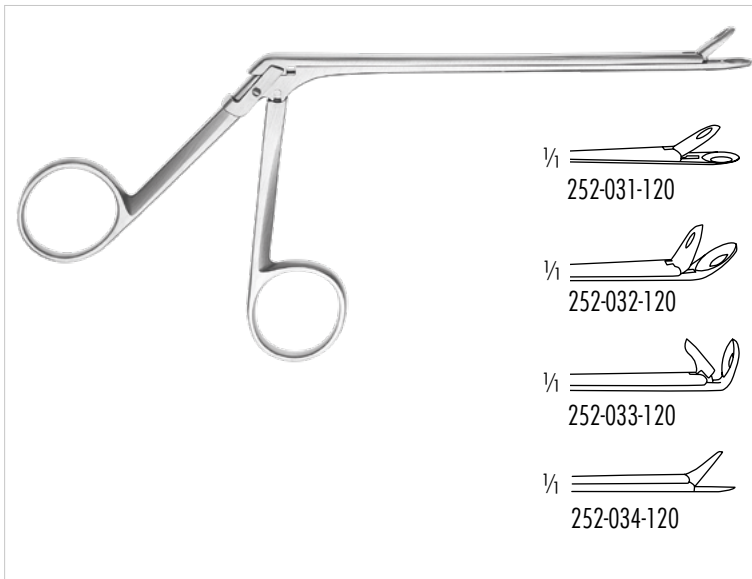

- 252-031-120 gerade/straight
- 252-032-120 45° aufgebogen/45° angled up
- 252-033-120 90° aufgebogen/90° angled up

STRUEMPEL

Nasenzängchen, mit ovalem, gefensterterem Löffelmaul, 120 mm
 Nasal forceps with oval fenestrated cupped jaws, 4 3/4 inch

252-034-120

BELLUCCI

Scherchen, gerade, 100 mm
 Scissors, straight, 4 inch

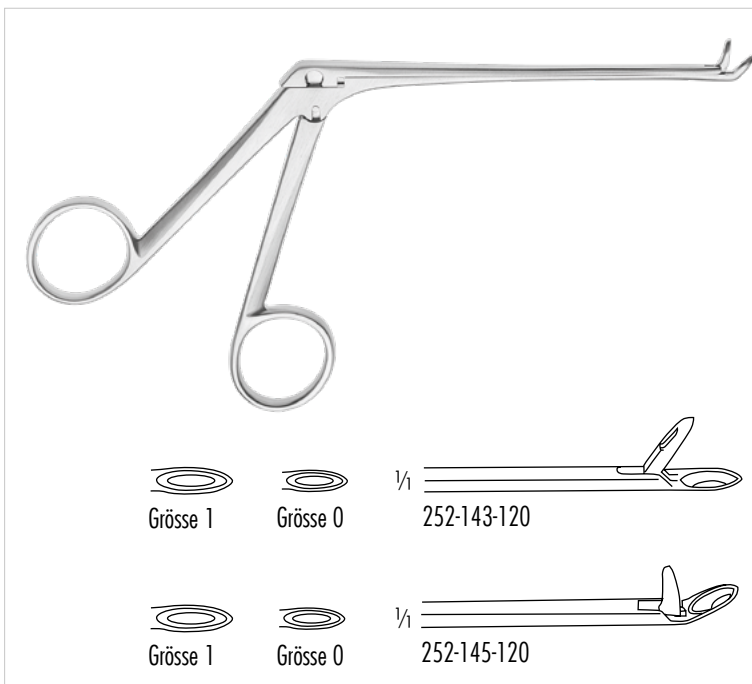

- 252-143-120 Größe/size 0, 2 mm
- 252-144-121 Größe/size 1, 2.5 mm

STRUEMPEL-VOSS

Blakesley Zange, gerade, 120 mm
 Blakesley forceps, straight, 4 3/4 inch

- 252-145-120 Größe/size 0
- 252-146-121 Größe/size 1

STRUEMPEL-VOSS

Nasenzange, fein, 45° aufgebogen, 120 mm
 Nasal forceps, delicate, 45° angled up, 4 3/4 inch

FULL HD CAMERA SYSTEM



Features:

- Full HD camera with 3-chip MOS technology
- Pure Natural Colors technology
- Full HD video recording (F4 only)
- Full HD image saving (F4 only)
- Camera head with 3 programmable buttons
- Boost function
- Freeze function
- 2.5x digital zoom
- 3 USER mode configurations
- Multilingual on screen menu
- Different digital video outputs
- Text generator (optional with keyboard)

- 300-001-800 3 Chip HD-Camera F3
- 300-001-804 3 Chip HD-Camera F4 (with recording function)

FULL HD

Technical data

Line voltage	100-240 VAC
Power input	20W
Image sensor	3 MOS
Resolution	1920 x 1080 pixels (FullHD)
Image resolution	>1000 TV lines, horizontal
Index ratio	16:9
Min. sensitivity	< 3lx (1/1.4)
Shutter speed	1/50 (1/60) to 1/100.000sec

DELIVERY CONTAINS:

- Main Unit
- Camera head
- 2x BNC cable
- HDMI - DVI cable
- HDMI cable
- S-Video cable (F3 only)
- USB Pen Drive (F4 only)
- Mains cable
- Operating manual

Video outputs (F4)	2 x HD SDI 1x HDMI / DVI 2x CVBS 1 x YPbPr / RGB 1 x Y/C (Pal/NTSC) 1x CVBS (Pal/NTSC)
Video outputs (F3)	1 x HDMI / DVI 1 x YPbPr (Component) 1 x Y/C (Pal/NTSC) 1x CVBS (Pal/NTSC)
Dimensions	Control unit: 380 x 120 x 360mm (WxHxD) Weight control unit: 11kg Weight camera head: 145g

Accessories



300-001-802
High-End 3-MOS Camera Head
FullHD (included in the set)



300-001-615
Title generator keyboard, waterproof IP68
US-Layout, cable 1.8m, color: grey,
305x140x15mm, 600gr.



300-001-610
Footswitch for HD Cameras
cable length: 2m

FULL HD CAMERA SYSTEM



Features:

- Full HD camera with 1-chip MOS technology
- Natural color technology
- Full HD video recording (F2 Pro only)
- Full HD image saving (F2 Pro only)
- Camera head with 3 programmable buttons
- Boost function
- Freeze function
- 2.5x digital zoom
- 3 USER mode configurations
- Multilingual on screen menu
- HDMI video outputs
- Text generator (optional with keyboard)

300-001-600 HD-Camera F1
 300-001-601 HD-Camera F2 Pro (with recording function)

FULL HD

DELIVERY CONTAINS:

- Main Unit
- Camera head
- 2x BNC cable
- HDMI - DVI cable
- HDMI cable
- S-Video cable
- USB Pen Drive (F2 Pro only)
- Operating manual
- Mains cable

Technical data

Line voltage	100-240 VAC
Power input	F2 Pro: 30W / F1: 20W
Image sensor	1/3" MOS
Resolution	1920 x 1080 pixels (FullHD)
Image resolution	>1000 TV lines, horizontal
Index ratio	16:9
Min. sensitivity	< 3lx (1/1.4)

Video outputs (F2 Pro)	2 x HD SDI (optional) 1 x HDMI / DVI 1 x Y-Pb-Pr (Component) 1 x Video (PAL/NTSC) 1x S-Video (PAL/NTSC)
Video outputs (F1)	1 x HDMI 1 x YPbPr / RGB 1 x S-Video (Y/C; Pal / NTSC) 1 x Video (CVBS; Pal / NTSC)
Dimensions	Control unit: 380 x 120 x 360mm (WxHxD) Weight control unit: 11kg Weight camera head: 105g

Accessories



300-001-602
 High-End 1/3" MOS Camera Head
 Full HD (included in the set)



300-001-615
 Title generator keyboard, waterproof IP68
 US-Layout, cable 1.8m, color: grey,
 305x140x15mm, 600gr.



300-001-610
 Footswitch for HD Cameras
 cable length: 2m



Features:

- Full HD camera with 1-chip technology
- Bright color technology
- Video and Picture recording (Z2 only)
- Camera head with 3 programmable buttons
- Freeze function
- 2.5x digital zoom
- 3 USER mode configurations
- Multilingual on screen menu

- 300-001-400 Camera Z1
- 300-001-410 Camera Z2 (with recording function)

DELIVERY CONTAINS:

- Main Unit (300-001-410)
- Camera head (300-001-410.1)
- HDMI/DVI Cable ■ HDMI cable
- 4GB USB Pen Drive (Z2 only)
- Mains cable ■ Operating manual

Technical data

Line voltage	100-240 VAC
Image sensor	1/3" MOS
Resolution	1920 x 1080 pixels (FullHD)
Index ratio	16:9
Outputs	1x HDMI
Connections	1x USB, 1x Remote IN 2 x Remote OUT, 2x RJ45

Safety class (EN 60601-1)	I
Classification (EU 2017/745)	I
Application part	BF
Dimensions	Control Unit: 380 x 132 x 378 mm (WxHxD) Camera Head: ∅ 38 x 79mm
Weight	Control Unit: approx. 9kg Camera Head: 180g

Accessories



300-001-410.1
1/3" MOS Camera Head
(included in the set)



300-001-615
Title generator keyboard, waterproof IP68
US-Layout, cable 1.8m, color: grey,
305x140x15mm, 600gr.



300-001-610
Footswitch for HD Cameras
cable length: 2m

TV COUPLER



4K
FULL HD

300-001-823 f=14mm
300-001-824 f=25mm
300-001-825 f=28mm
c-mount, soakable



4K
FULL HD

250-015-030
Zoom-TV-Adapter
f=15 - 30mm
c-mount, soakable

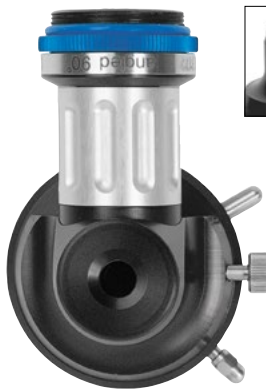

4K
FULL HD

250-020-025 F=25mm (splitting 90/10)
250-020-030 F=30mm (splitting 90/10)
Beamsplitter, allows simultaneous video
and direct views, c-mount, soakable



4K
FULL HD

300-001-813 f=14mm
300-001-814 f=25mm
300-001-815 f=28mm
c-mount, soakable



300-001-168
Endovue 32" HD Monitor

300-001-158
Endovue 24" HD Monitor

Technical data

Screen size	31.5" / 24" diagonal
Resolution	1920 x 1080
Aspect ratio	16:9
Viewing angle	178°
Numbers of colors	16.7 Million (8-bit)
Video Inputs	DVI-D, RGBS/VGA/YPbPr (HD-15 or DVI-I via adapter), S-Video, Composite
Video Outputs	DVI-D
Weight	8.8kg (300-001-168) 6.7kg (300-001-158)



300-001-232
Radiance 32" HD Monitor

300-010-226
Radiance 27" HD Monitor

Technical data

Screen size	32" / 27" diagonal
Resolution	1920 x 1080
Aspect ratio	16:9
Viewing angle	178°
Numbers of colors	1.07 Billion (10-bit)
Video Inputs	DVI-I and 3G-SDI Input/Output
Video Outputs	DVI-D
Weight	11.0kg (300-001-232) 8.9kg (300-010-226)

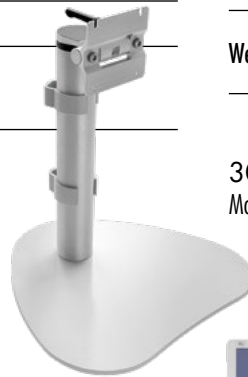

300-001-028
Monitor Table Stand



300-001-031
UHD 4K Monitor, 31"



300-001-055
UHD 4K Monitor, 55"

Technical data

Screen size	31" diagonal
Resolution	4096 x 2160
Aspect ratio	17:9
Viewing angle	178°
Number of colors	1.08 Billion (10-bit)
Video Inputs	1 x HDMI 2.0 1 x DP 1.2 (SST) & 1 x DP 1.2 (MST) 1 x DVI (single link), 4 x SDI (3G)
Video Outputs	1 x DP 1.2 (SST) 1 x DVI (single link), 4 x SDI (3G)
Weight	10.5kg

Technical data

Screen size	55" diagonal
Resolution	3840 x 2160
Aspect ratio	16:9
Viewing angle	178°
Numbers of colors	1.08 Billion (10-bit)
Video Inputs	1 x HDMI 2.0, 2 x DP 1.2 (55T) 1 x DVI (single link), 2 x DVI (dual link) 4 x SOi (3G), 2 x SOi (12G)
Video Outputs	1 x DVI (single link), 1 x DP 1.2 (SST) 4 x SDI (3G), 2x SDI (12G)
Weight	37.35kg

All monitors will be delivered without table stand - need to be ordered separately.

LED LIGHT SOURCE



Features:

- 6500K daylight color temperature
- 375 Watt equivalent output power
- > 20.000 hours lifetime
- Turret connector for the most common light cables (Olympus, Wolf, Gyros ACMI, Storz)
- Manual or automatic light control
- Waterproof touch control panel
- Low heat conduction by improved LED technology
- Boost function: light increase of 20%

300-900-300 LUMEN LED 3 PRO Light Source, 110 - 230V



DELIVERY CONTAINS:

- Main Unit (300-900-300)
- BNC cable (optional)
- Mains cable
- Operating manual

Technical data

Line voltage	100-240 VAC
Video input	1x Video, BNC
Protection class	1 (acc. IEC 60601-1) 1 (acc. MDD 93/42/EEC)
Safety class	BF
Standard	IEC 60601-1-2
Dimensions	380 x 120 x 360mm (WxHxD)
Weight	approx. 11kg



A OLYMPUS

B WOLF

C GYRUS ACMI

D STORZ
KARL STORZ ENDOSKOP

Turret, multi connector

LED LIGHT SOURCE



Features:

- More than 20.000h lamp lifetime
- 180 Watt equivalent power output
- Manual or automatic light control
- Waterproof touch control panel
- Low heat conduction by improved LED technology
- Daylight color temperature 6000 – 6500° K for accurate color representation
- Boost function: light increase of 20%

300-900-180 LUMEN LED 1 Light Source



DELIVERY CONTAINS:

- Main Unit (300-900-180)
- BNC cable
- Mains cable
- Operating manual

Technical data

Line voltage	100-240 VAC
Power consumption	130VA
Video input	1x Video, 1x S-Video (Y/C) (automatic version only)
Protection class	1 (acc. IEC 60601-1) 1 (acc. MDD 93/42/EEC)
Safety class	BF
Dimensions	380 x 120 x 360mm (WxHxD)
Weight	approx. 11kg

HIGH TEMPERATURE LED/XENON LIGHT CABLES



Adaptor pieces to use with **endoscope**



250-042-000
RZ/Storz/Olympus



250-040-000
Wolf



250-041-000
ACMI/British Standard

XENON/LED Light Guide Cables
with melt and bending protection

250-025-230	∅ 2.5 mm, 2300 mm
250-025-300	∅ 2.5 mm, 3000 mm
250-035-180	∅ 3.5 mm, 1800 mm
250-035-230	∅ 3.5 mm, 2300 mm
250-035-300	∅ 3.5 mm, 3000 mm
250-048-180	∅ 4.8 mm, 1800 mm
250-048-230	∅ 4.8 mm, 2300 mm
250-048-300	∅ 4.8 mm, 3000 mm

Adaptor pieces to use with **light source**



250-039-000
RZ/Storz



250-038-000
ACMI/CUDA



250-048-000
Luxtec



250-051-000
Stryker



250-037-000
Wolf



250-044-000
Olympus



250-045-000
Olympus - Standard



250-052-000
Heine



250-059-000
Pentax



COMPATIBILITY NOTE:
A fiber optic cable with a large diameter should not be connected to a smaller diameter scope.
For example: ∅ 4.8mm fiber optic cables connected to a ∅ 2.9mm may risk high temperature at the light entry of the endoscope and may risk patient safety.

ELECTROSURGICAL GENERATOR



Features:

- Monopolar/bipolar cutting and coagulation
- Automatic identification of connected instruments
- Powerstart System simplifies the beginning of cutting process
- Automatic power regulation
- 105 different memory locations in 7 groups
- Various output configuration of the sockets available
- 10" Touchscreen
- Tiltable display
- Footswitch (optional)
- Available with Argon and / or the RZeal
- Real-time output monitoring

700-350-400 230V
 700-350-410 110V
 G400 ElectroSurgical Generator

DELIVERY CONTAINS:

- Main Unit
 - Mains Cable
- (Footswitch not included)

Technical data

Line voltage	110-230 VAC
Power consumption	500W
Generator operation frequency	333kHz
Display	TFT 10"
Defibrillation impulse resistance	acc. to EN 60601-1
NEM system	neutral electrode control optical indication 7 levels required resistance < 240 Ω
Gas type	pure argon 4.8 (99,998%) or higher
Inlet gas pressure	0.25-0.4 [MPa]
Monopolar coagulation / cutting	200W / 400W
Bipolar coagulation / cutting	400W / 400W

Gas outflow	0.1-10 l/min, regulated 0.1 l/min in whole range
Pressure range	reducer (0.4 MPa) on argon cylinder
Vessel sealing system	9 effects/300W
AutoStop	automatic stop of sealing process after achieving the optimal effect
Dimensions	495 x 415 x 225mm (LxWxH)
Weight	12.2kg

Accessories



700-350-405
 2-Button-Footswitch, length: 5m

700-350-402
 3-Button-Footswitch, length: 5m, quick access key



Disposable Neutral Electrode hydrogel, split, for adults or children
 10x5 pcs. per package
 700-503-000 Adults
 700-503-001 Children



Cable for Disposable Neutral Electrode
 5m, RZ compatible only
 700-503-003

ELECTROSURGICAL GENERATOR



Features:

- Monopolar/bipolar cutting and coagulation
- Automatic instrument detection system
- Intuitive Touchscreen
- Automatic power regulation
- Configurable working modes
- Real-time parameter control
- Special endoscopic modes
- Bipolar resection
- Easy software update

700-340-400 230V
 700-340-410 110V
 G44 Electro-surgical Generator

DELIVERY CONTAINS:

- Main Unit
 - Mains Cable
- (Footswitch not included)

Technical data

Line voltage	110-240 VAC
Power consumption	1100VA
Generator operation frequency	333kHz
Display	TFT 7" WVGA
Spectrum result system	automatic power regulation
Monopolar coagulation	max. 200W (200Ω)
Monopolar cutting	max. 400W (100Ω)
Bipolar coagulation	max. 400W (25Ω)
Bipolar cutting	max. 330W (150Ω)

NEM system	neutral electrode control, optical indication, required resistance < 240 Ω
Dimensions	385 x 305 x 141mm (LxWxH)
Weight	7kg

Accessories



700-350-405
 2-Button-Footswitch, length: 5m

700-350-402
 3-Button-Footswitch, length: 5m, quick access key



Disposable Neutral Electrode hydrogel, split, for adults or children
 10x5 pcs. per package
 700-503-000 Adults
 700-503-001 Children



Cable for Disposable Neutral Electrode
 5m, RZ compatible only
 700-503-003



ORAL
Instruments and
Equipment for
Oral and Larynx

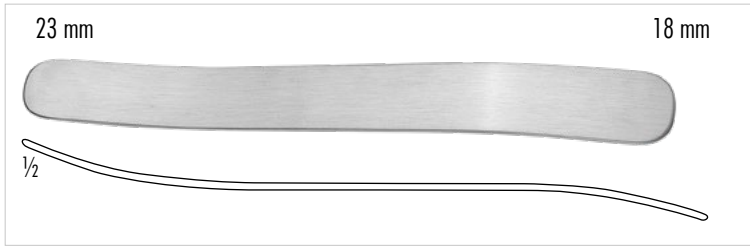

430-361-190
BUCHWALD
Zungenspatel, 180 mm
Tongue depressor, 7 inch



430-362-170
MAYO
Zungenspatel, 170 mm
Tongue depressor, 6 2/3 inch

430-363-170
MAYO
Zungendrucker, s-gebogen, 19 / 23 mm breit, 170 mm
Tongue depressor, s-curved 19 / 23 mm wide, 6 2/3 inch



430-385-190
BRUENINGS
Zungenspatel, 190 mm
Tongue depressor, 7 1/2 inch

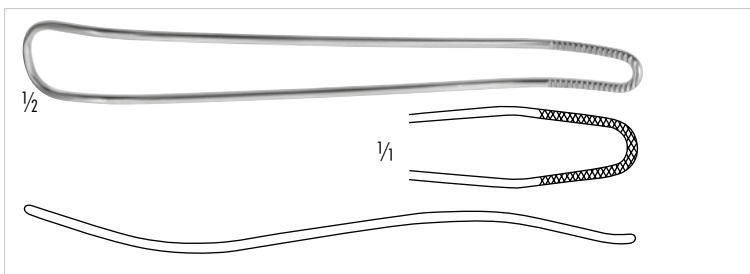

430-396-165
FRENZEL
Zungenspatel, 165 mm
Tongue depressor, 6 1/2 inch

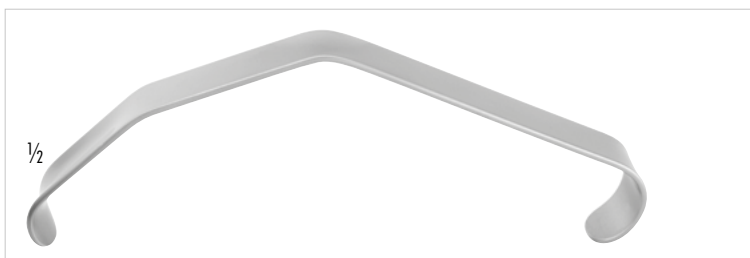

430-518-150 18 mm breit/18 mm wide
430-520-150 20 mm breit/20 mm wide
430-522-150 22 mm breit/22 mm wide
LOVE
Zäpfchen Retraktor, 150 mm
Uvula retractor, 6 inch



430-397-190
MORITZ-SCHMIDT
Zungenspatel, 190 mm
Tongue depressor, 7 1/2 inch

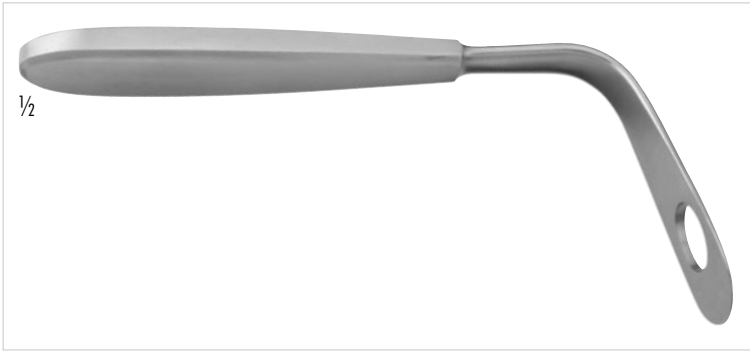

430-298-100
BOSWORTH
Zungendrucker, 145 mm
Tongue depressor, 5 1/2 inch

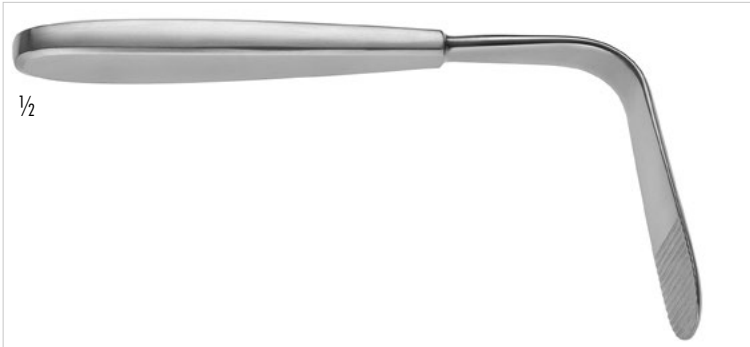

430-349-145
TOBOLD
Zungendrucker, 145 mm
Tongue depressor, 5 1/2 inch

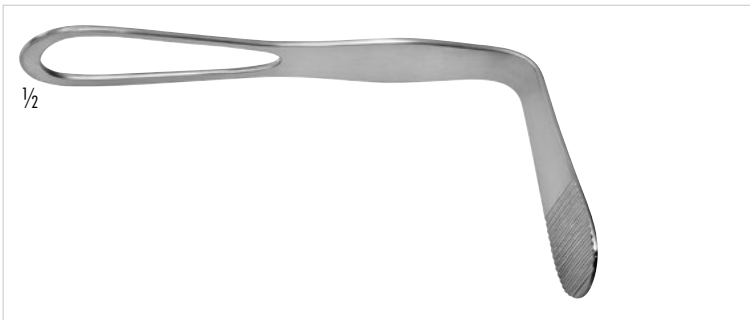

430-271-150
HARTMANN
Zungenspatel mit Gittergriff, 150 mm
Tongue depressor with fenestrated handle, 6 inch

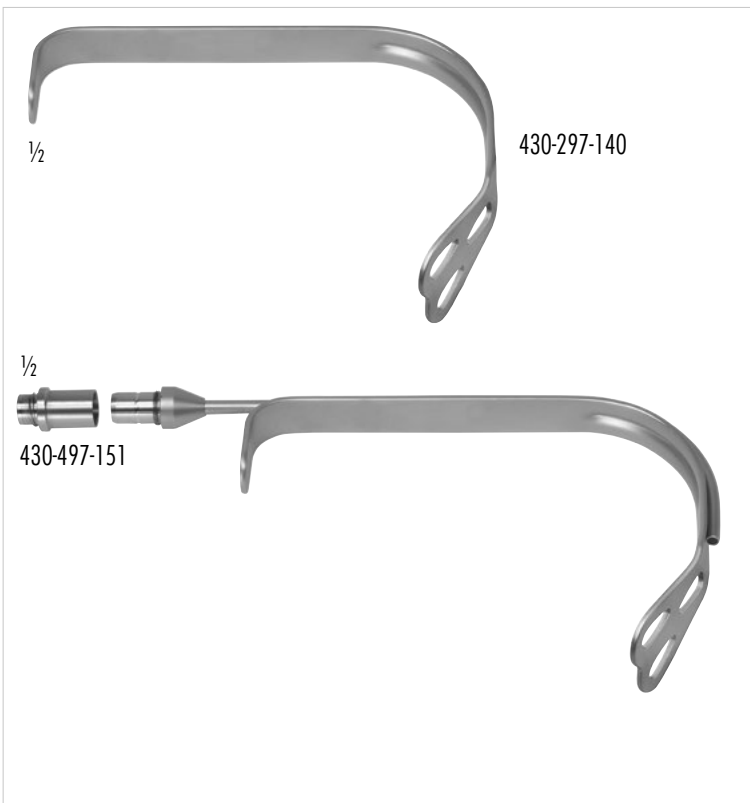

430-297-140 30 mm breites Blatt/30 mm wide blade
430-297-150 36 mm breites Blatt/36 mm wide blade
WIEDER
Zungenspatel, gefensterter Blatt, feine Zahnung, 125 mm
Tongue depressor, fenestrated blade, fine serration, 5 inch

430-497-141 30 mm breites Blatt/30 mm wide blade
430-497-151 36 mm breites Blatt/36 mm wide blade
SCULPO
Dito, mit Kaltlicht, 125mm
Same, with Fiber Optic, 5 inch



430-350-005 55mm
 430-350-007 70mm
 430-350-009 90mm
 430-350-010 100mm

STIERLEN
 Zungendrucker
 Tongue Depressor



430-150-130
HEISTER
 Mundsperrer, 130 mm
 Mouth gags, 5 1/8 inch



430-140-110 children, 120mm
 430-140-110 adults, 140mm
DOYEN-JANSEN (MOLT)
 Mundsperrer,
 Mouth gags, 4 3/4 inch

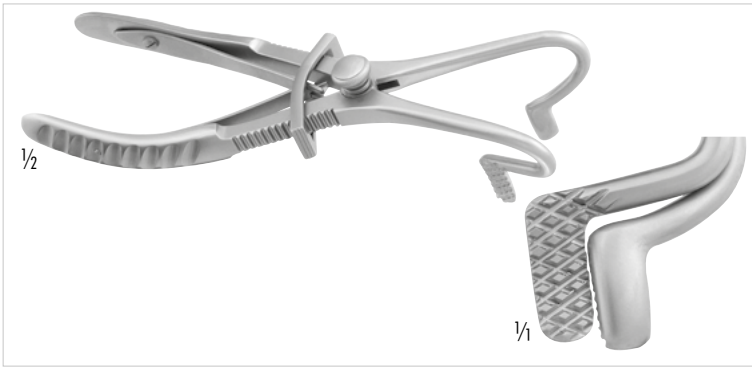

430-145-145
FERGUSON-ACKLAND
 Mundsperrer, 145 mm
 Mouth gags, 5 3/4 inch



430-142-120
DENHARDT
 Mundsperrer, mit Einsätzen aus Silikon, auswechselbar, 120 mm
 Mouth gags, with silicone inserts, interchangeable, 4 3/4 inch



430-144-160 160 mm/6 1/4 inch
ROSER-KOENIG
 Mundsperrer
 Mouth gags

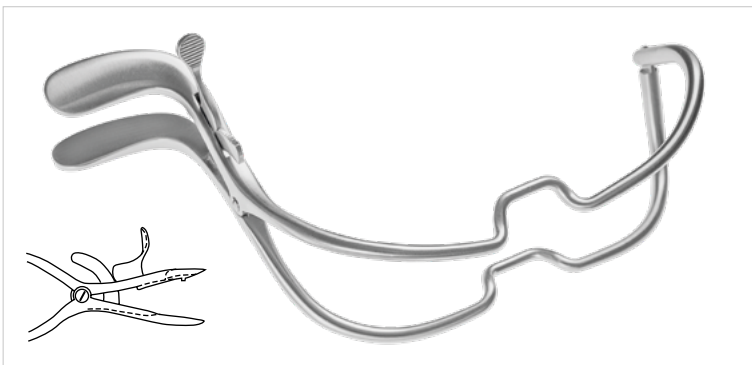

430-250-090 90 mm , 3 1/2 inch
 430-250-110 110 mm , 4 1/2 inch
 430-250-130 130 mm , 5 inch
 430-250-150 150 mm , 6 inch
JENNINGS
 Mundsperrer
 Mouth gags



- 430-261-090 90 mm , 3 1/2 inch
- 430-261-110 110 mm , 4 1/2 inch
- 430-261-130 130 mm , 5 inch
- 430-261-150 150 mm , 6 inch

WHITEHEAD

Mundsperrer
Mouth gags



430-130-500

DAVIS-MEYER

Mundsperrer, Bügel allein, mit 2 Einzelgebissplatten und auswechselbaren Silikoneinlagen, passend für alle Zungenspatel
Mouth gags, frame only, with 2 single bites and interchangeable silicone inserts, suitable for all tongue depressors

430-130-550

Silikoneinlagen allein
Silicone insert only

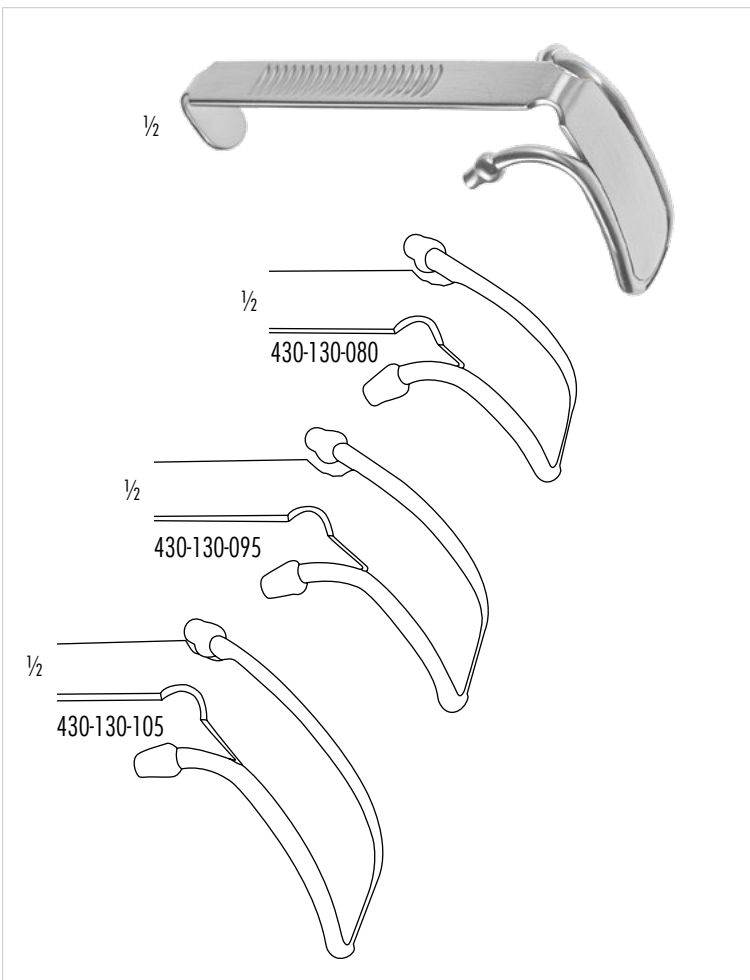

- 430-130-070 29 x 70 mm
- 430-130-075 30 x 75 mm
- 430-130-080 31 x 80 mm
- 430-130-085 32 x 85 mm
- 430-130-095 33 x 95 mm
- 430-130-100 34 x 100 mm
- 430-130-105 34 x 105 mm

DAVIS-MEYER

Zungenspatel, allein, mit Schlauchgarnitur
Tongue blade only, with tubing set for anaesthesia channel

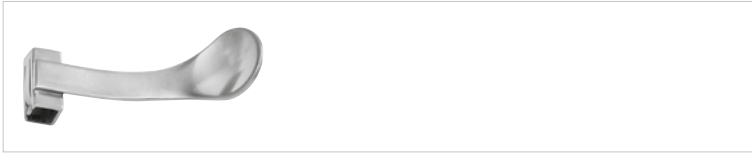

430-130-560
Gaumenplatte zu Bügel 430-130-500, für zahnlose Patienten
Palate blade to be used with 430-130-500, for toothless patients



430-256-010
MC IVOR
Mundsperrer Bügel, allein
Mouth gags frame, only

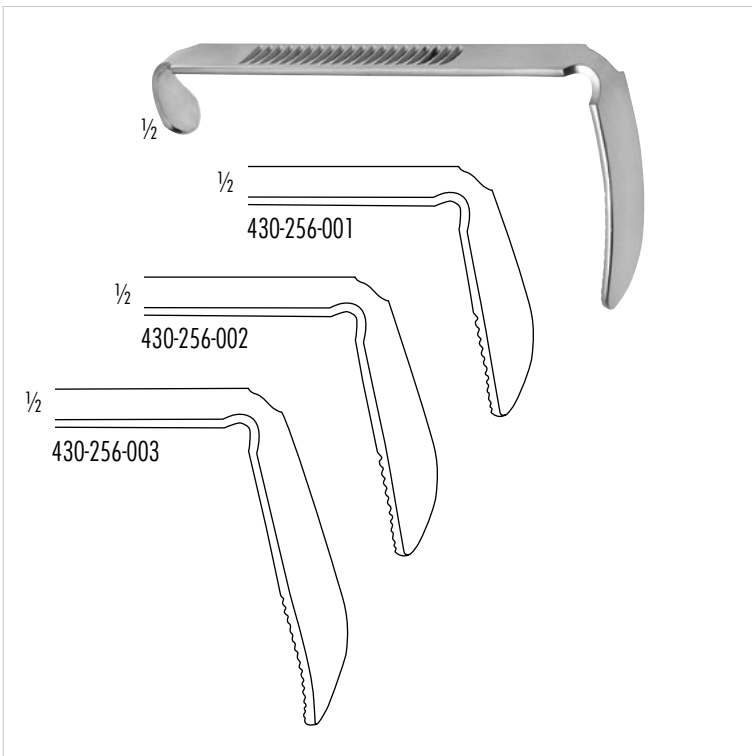

430-256-001 23 x 55 mm
430-256-002 25 x 62 mm
430-256-003 26 x 75 mm
MC IVOR
Zungenspatel, allein
Tongue blade, only

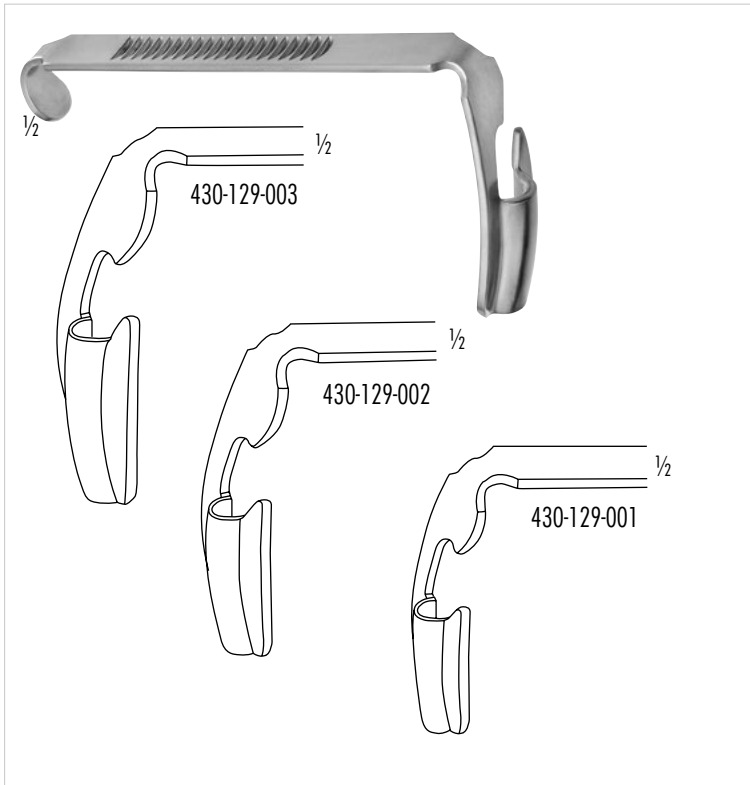

430-129-001	28 x 65 mm
430-129-002	32 x 75 mm
430-129-003	37 x 80 mm

RZ

Zungenspatel, allein, mit Mittelrinne für Intubationstubus und seitlichem Einschnitt

Tongue blade only, with groove for endotracheal tube and lateral slot

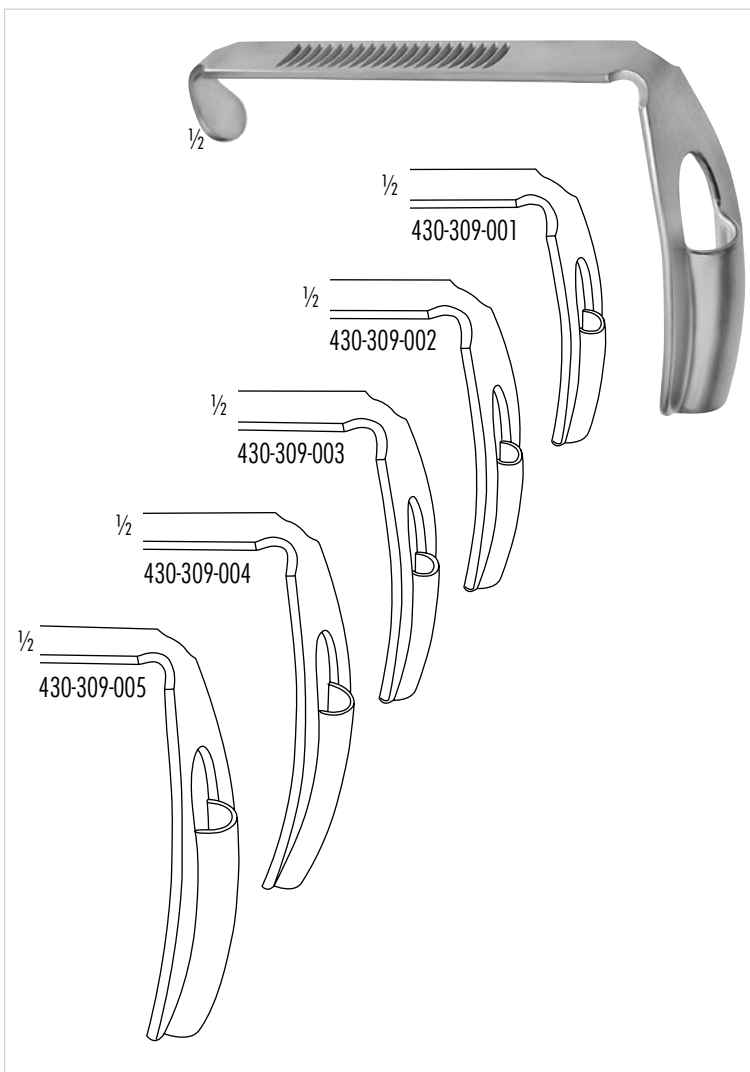

430-309-001	28 x 65 mm
430-309-002	32 x 75 mm
430-309-003	37 x 80 mm
430-309-004	41 x 94 mm
430-309-005	46 x 103 mm

RUSSEL-DAVIS

Zungenspatel, mit Mittelrinne für Intubationstubus

Tongue blade, with groove for the endotracheal tube

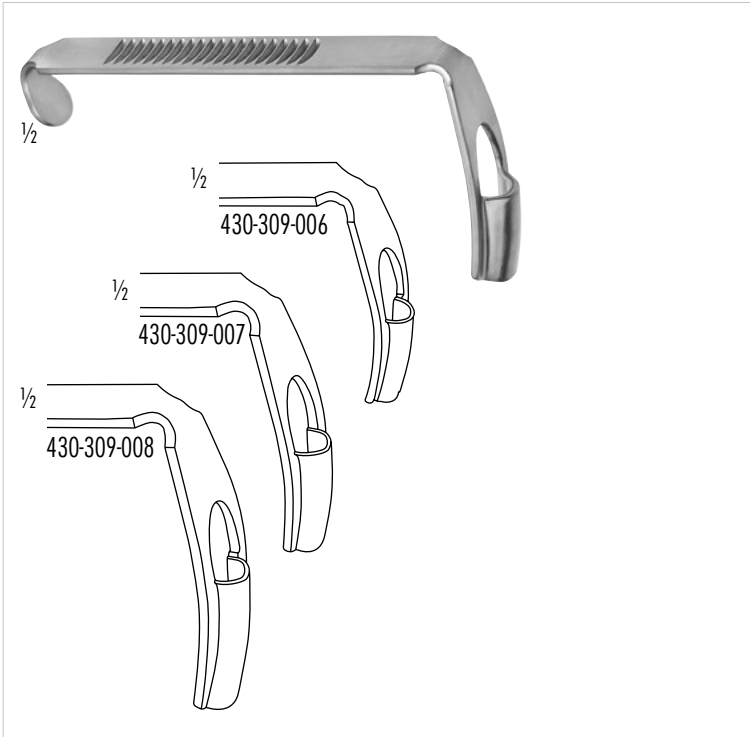

- 430-309-006 18 x 57 mm
- 430-309-007 22 x 67 mm
- 430-309-008 25 x 75 mm

RUSSEL-DAVIS

Zungenspatel allein, extra schmales Modell, mit Mittelrinne für Intubationstubus

Tongue blade, very narrow pattern, with groove for endotracheal tube

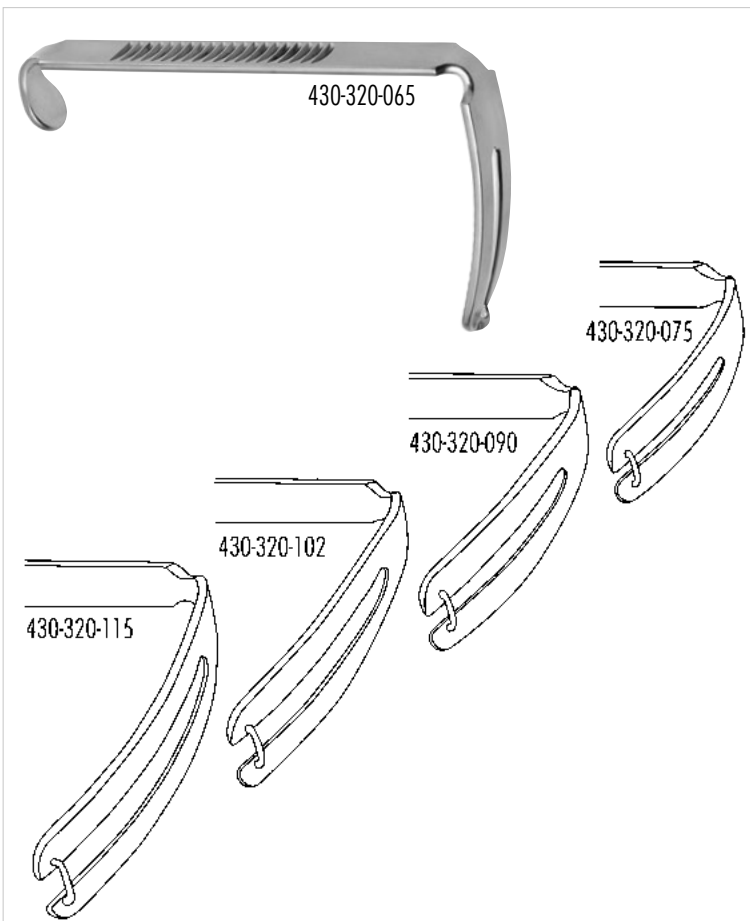

- 430-320-065 23 x 65 mm
- 430-320-075 24 x 80 mm
- 430-320-090 25 x 93 mm
- 430-320-102 26 x 108 mm
- 430-320-115 26 x 114 mm

DOUGHTY

Zungenspatel, mit Mittelrinne für Intubationstubus zur Verwendung mit Davis-Boyle Rahmen

Tongue blade, with slot for endotracheal tubes for use with Davis-Boyle frames

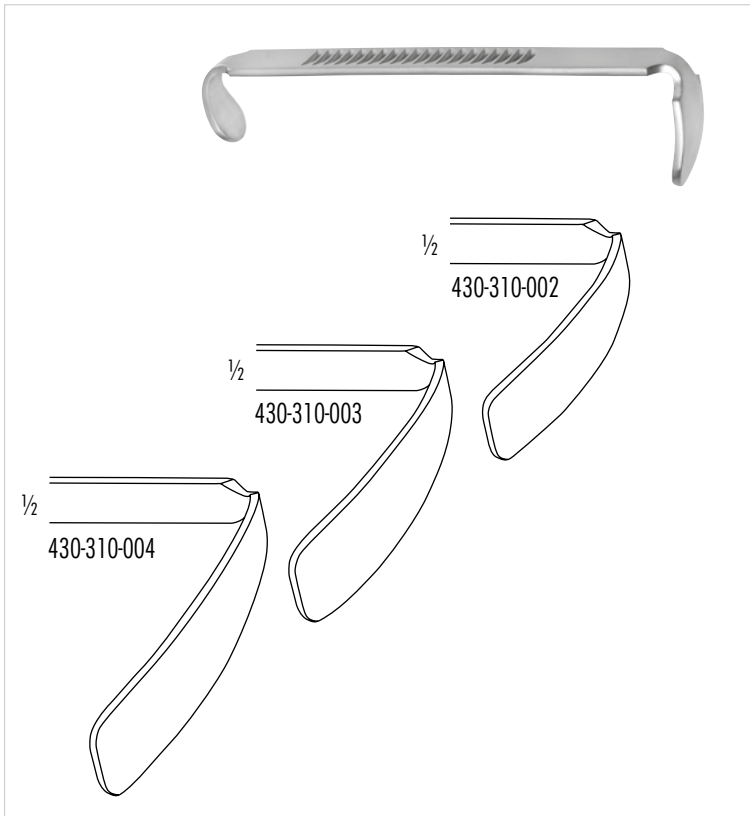

- 430-310-001 65 mm
- 430-310-002 75 mm
- 430-310-003 90 mm
- 430-310-004 102 mm

DAVIS-BOYLE

Zungenspatel, allein
Tongue blade, only



430-315-000

KILNER-DOUGHTY

Mundsperrer, links, mit 3 auswechselb. Blättern #1 bis #3
Mouth gag complete, left with 3 interchang. tongue blades #1 to #3

430-315-010

KILNER-DOUGHTY

Mundsperrer, allein
Mouth gag spreader, only

- 430-315-001 28 x 65 mm
- 430-315-002 32 x 75 mm
- 430-315-003 37 x 80 mm

KILNER-DOUGHTY

Zungenspatel, alleine
Tongue blade, only



430-310-000

DAVIS-BOYLE

Mundsperrer, mit 5 Blättern, Erwachsene
Mouth gag complete, with 5 blades, adult

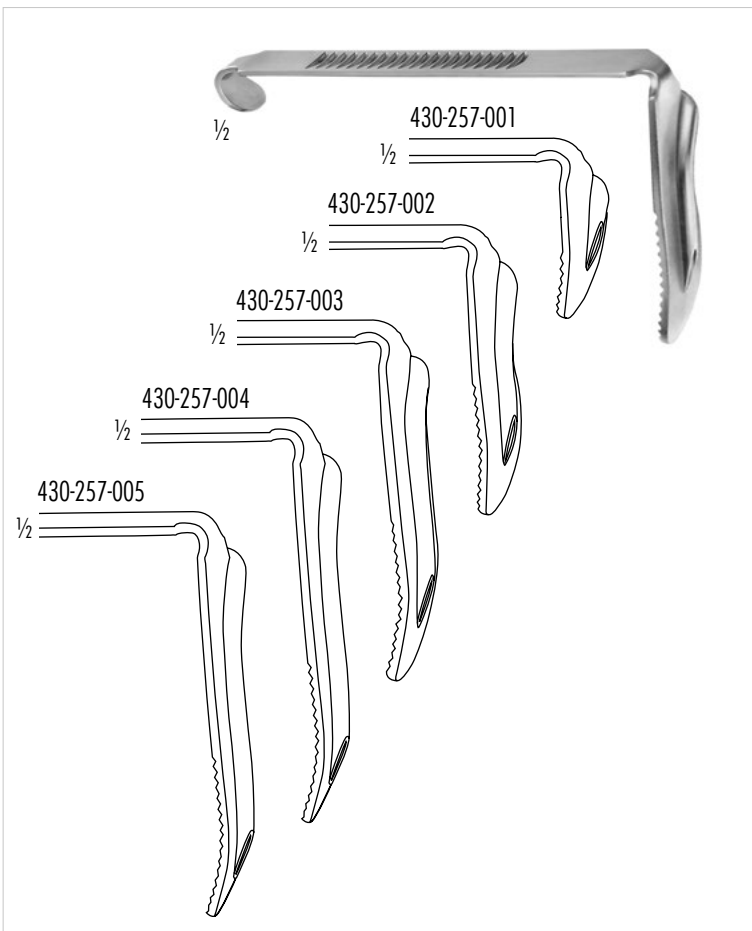

430-257-001

21 x 30 mm

430-257-002

23 x 65 mm

430-257-003

24 x 80 mm

430-257-004

25 x 93 mm

430-257-005

26 x 108 mm

DAVIS-BOYLE

Zungenspatel, allein, mit Intubationsrohr

Tongue blade, only, with anaesthesia channel

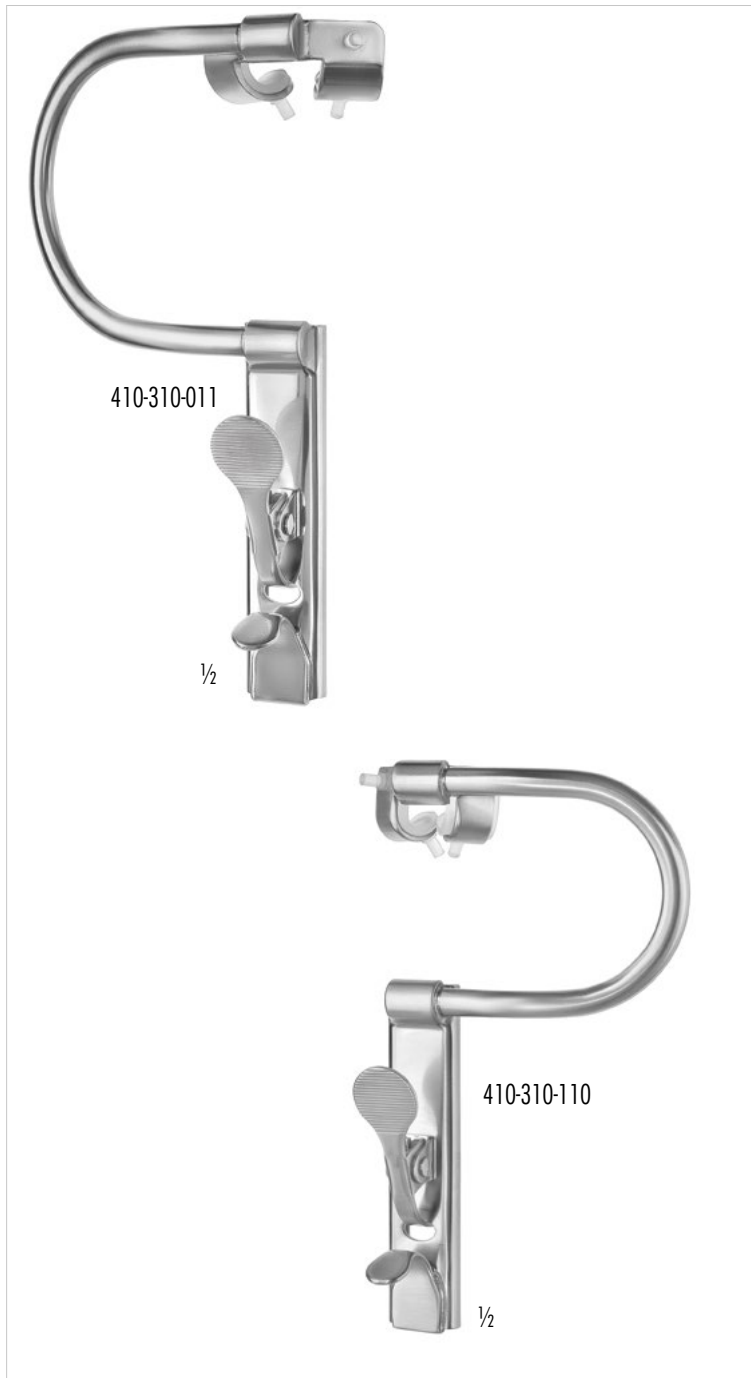

430-310-010 Rahmen links/frame left
 430-310-011 Rahmen rechts/frame right
DAVIS-BOYLE
 Mundsperrer, für Erwachsene
 Mouth gag, for adult

430-310-110
DAVIS-BOYLE
 Mundsperrer, Rahmen für Kinder
 Mouth gag, frame for children



430-327-000
DINGMANN
 Mundsperrer mit Zubehör mit Blatt-Nr.1, 2, 3
 Mouth gag complete with accessories, blade #1, 2 and 3

430-327-004
DINGMANN
 Mundsperrer, allein
 Mouth gag, only

430-327-001 24 x 62 mm
 430-327-002 28 x 65 mm
 430-327-003 31 x 75 mm
DINGMANN
 Zungenspatel, allein
 Tongue blade, only

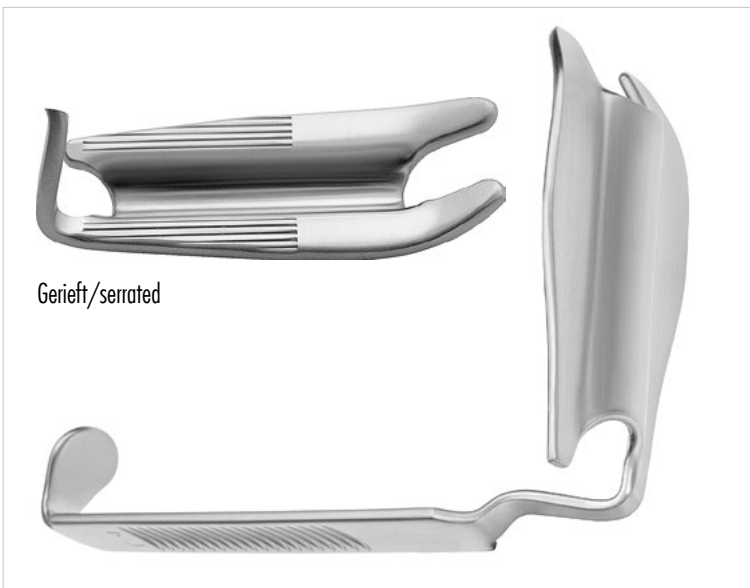

Gerieft/serrated

Links/left
 430-000-002 23 x 58 mm
 430-000-003 27 x 72 mm
 430-000-004 34 x 87 mm
 430-000-005 37 x 95 mm

Rechts/right
 430-010-002 23 x 58 mm
 430-010-003 27 x 72 mm
 430-010-004 34 x 87 mm
 430-010-005 37 x 95 mm

Zungenspatel
 Tongue Spatula

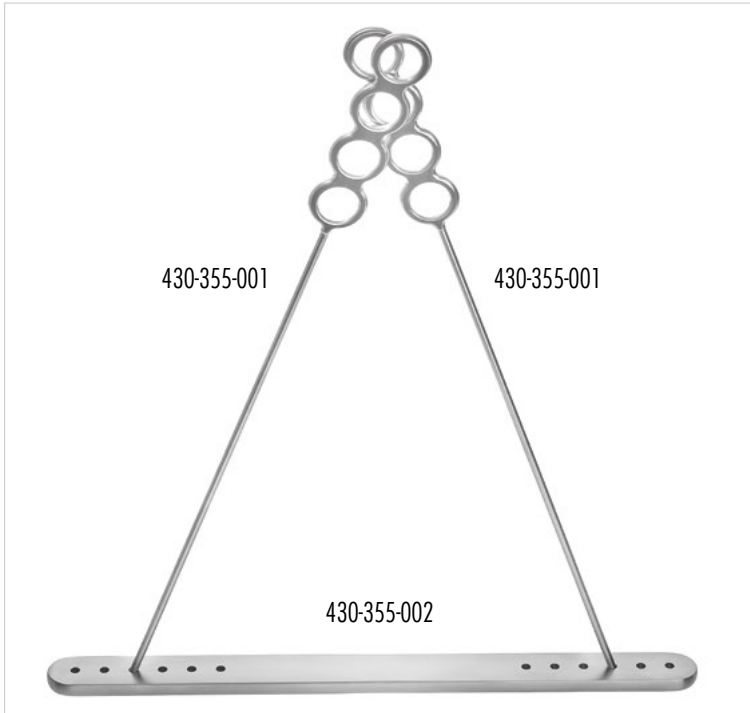

430-355-000

DRAFFIN

Mundsperrer Halter komplett: 2 Stützstangen + Grundplatte für Mundsperrer-Aufhängung

Holder for mouth gag, complete: 2 bars + plate, for mouth gag fixation

430-355-001

Stützstange, paarweise/bar, pair

430-355-002

Grundplatte/Magauran Plate



430-320-000

NEGUS

Bruststütze, zur Verwendung mit Zungenspatel und Mundsperrer

Chest support, for use with tongue blade and mouth gag

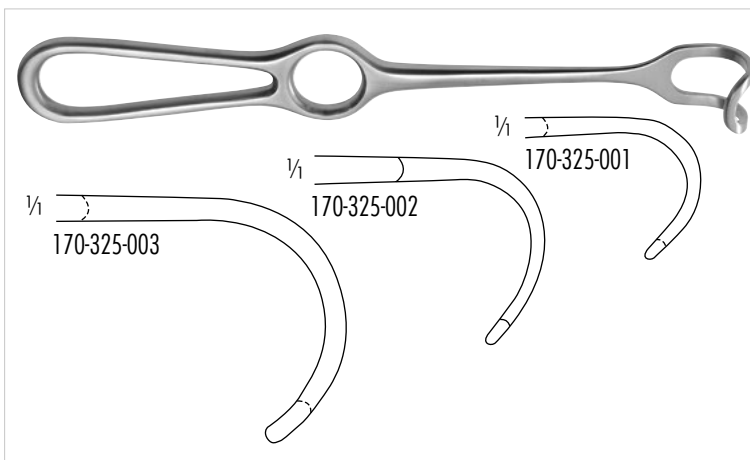

170-325-001

14 x 17 mm, 215 mm, 8 3/4 inch

170-325-002

20 x 22 mm, 220 mm, 8 1/2 inch

170-325-003

26 x 30 mm, 235 mm, 9 1/4 inch

MIDDELDORPF

Wangenhalter

Cheek retractor



440-225-222

GREENE

Thyroid Retraktor, 17x25 mm, gefenstert, 220mm

Thyroid retractor, 17x25 mm, fenestrated, 8 3/4 inch

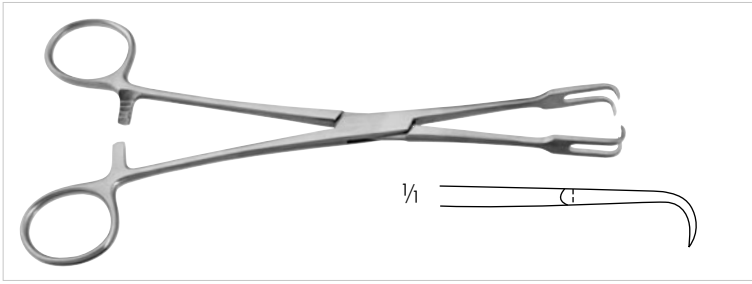

140-602-200
MUSEUX
 Tonsillenenfaßzange, 2x2 Zähne, 200 mm
 Tonsil holding forceps, 2x2 teeth, 8 inch

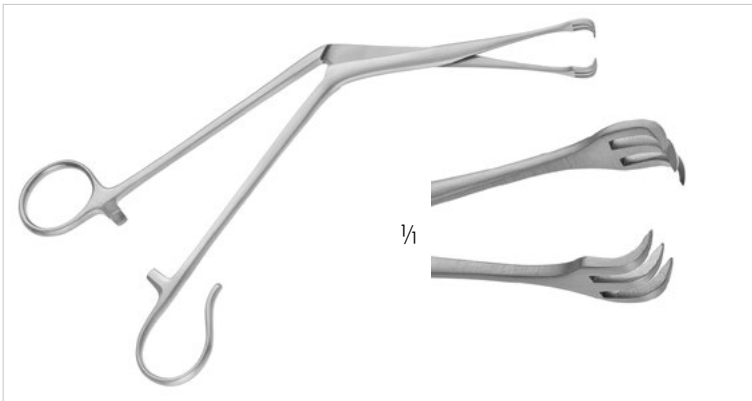

430-631-002
TIVNEN-TYDING
 Tonsillenenfaßzange, 3x3 Zähne, 1 offener Ring, 210 mm
 Tonsil seizing forceps, 3x3 teeth, 1 open ring, 8 1/4 inch



420-427-200
DENIS-BROWNE
 Tonsillenklemme, 10mm, 200mm
 Tonsil holding Forceps, 10mm, 8 inch

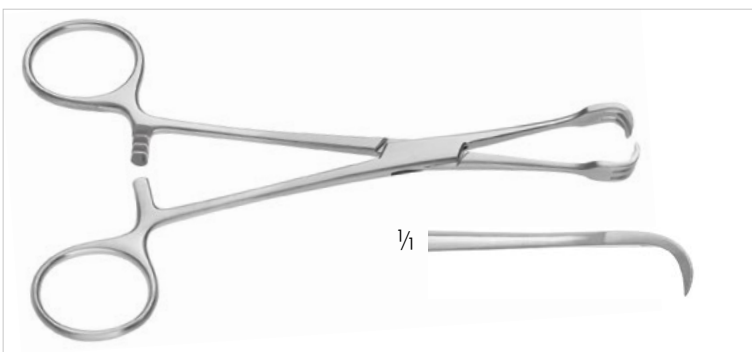

440-030-150 150mm, 6 inch
 440-030-200 200mm, 7 3/4 inch
LAHEY
 Kropfffaßzange
 Goitre Seizing forceps

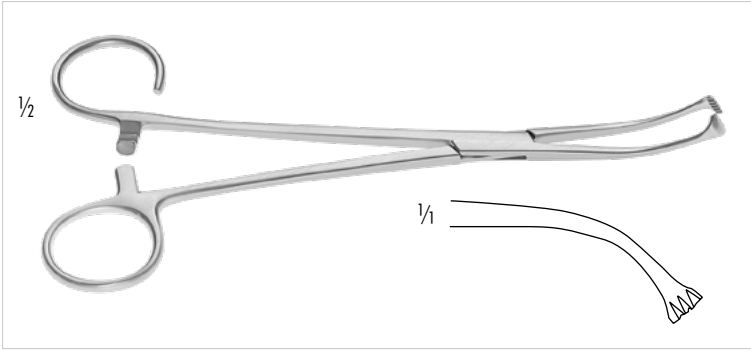

140-620-180 180 mm, 7 inch
 140-620-235 235 mm, 9 1/4 inch

WHITE

Tonsillenfaßzange, 180 mm
 Tonsil holding forceps, 7 inch

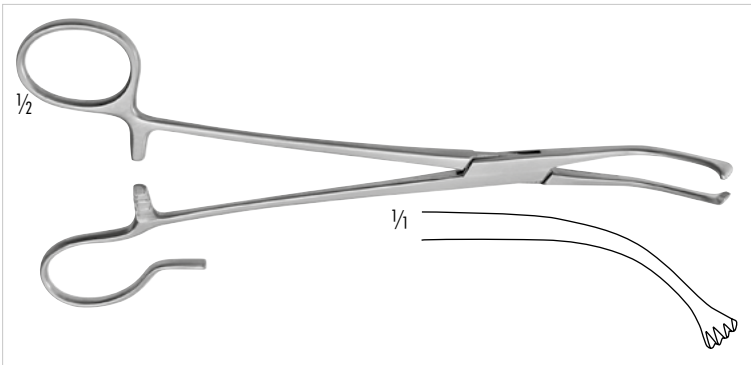

140-626-190

COLVER

Tonsillenklemme, gebogen, 190 mm
 Tonsil seizing forceps, curved, 7 1/2 inch

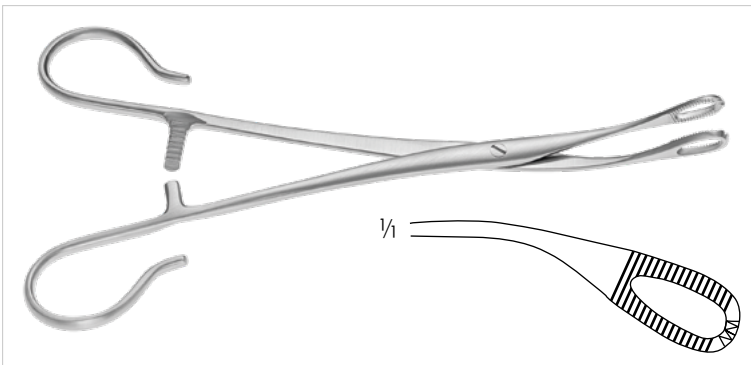

140-625-200

BLOHMKE

Tonsillenfaßzange, 200 mm
 Tonsil holding forceps, 8 inch

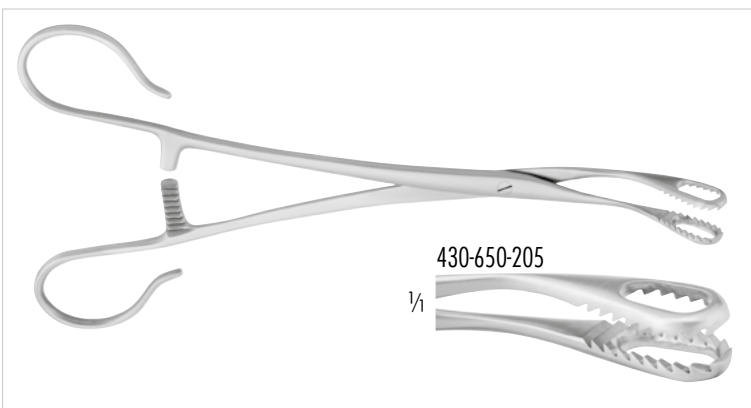

430-650-205

ABRAHAM

Tonsillenfaßzange, 205 mm
 Tonsil holding forceps, 8 inch

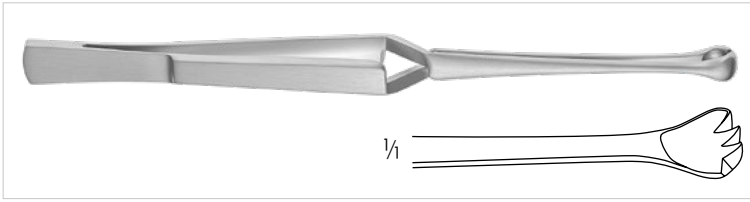

430-620-220
MARSCHIK
 Tonsillenfaßpinzette, 220 mm
 Tonsil grasping forceps, 8 3/4 inch

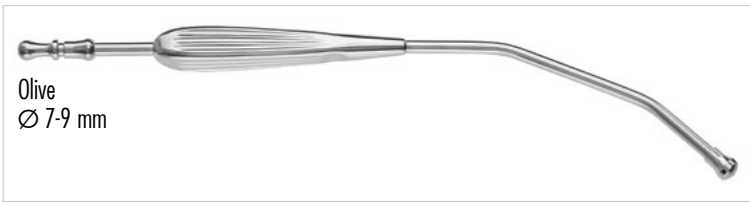

165-543-270 Ø 10 mm
YANKAUER
 Saugrohr mit zentraler Bohrung, 270 mm
 mit Schlaucholive Ø 7-9mm
 Tonsil suction tube, with central drill, 10 3/4 inch
 with olive Ø 7-9mm



430-670-235
LOPEZ-REINKE
 Tonsillendissektor mit Absaugvorrichtung, 235 mm
 Tonsil suction dissector, 8 1/2 inch

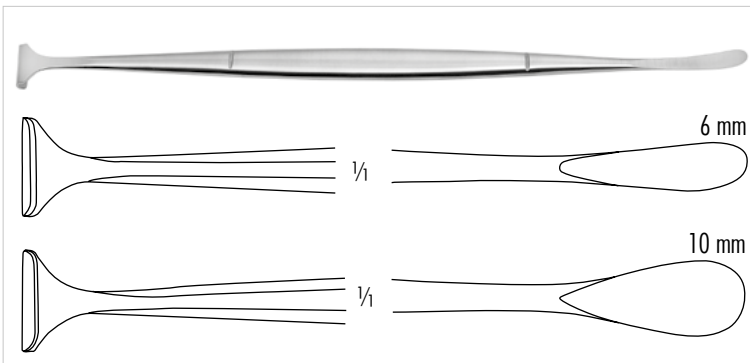

430-600-215 7.5 mm
 430-601-220 10 mm
HURD
 Tonsillendissektor und -retraktor, 215 mm
 Tonsil dissector and pillar retractor, 8 1/2 inch

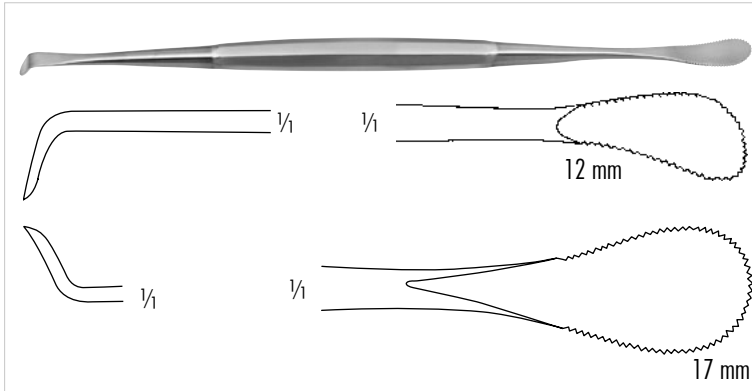

430-600-230 12 mm
430-601-230 17 mm

HENKE

Tonsillendissektor und -retractor, 235 mm
Tonsil dissector and pillar retractor, 9 1/4 inch

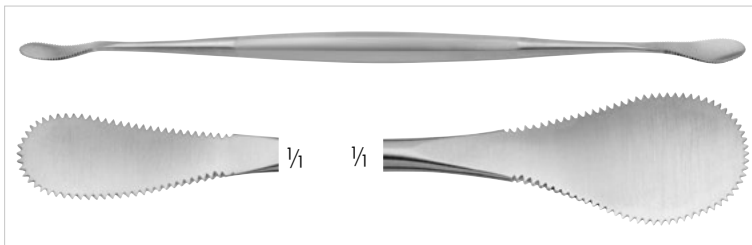

430-602-230 17 mm

HENKE

Tonsillendissektor, doppelendig, 12 mm / 18 mm
gezahntes Blatt, 230 mm
Tonsil dissector, double-ended, 12 mm / 18 mm
serrated blade, 9 inch



430-655-210

MOLLINSON

Tonsillendissektor und -retractor, halb-scharf, 210 mm
Tonsil dissector and pillar retractor, semi-sharp, 8 1/2 inch

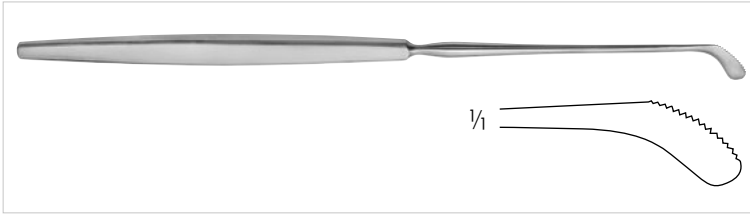

430-656-190
FISCHER
Tonsillennmesser, 225 mm
Tonsil knife, 9 inch

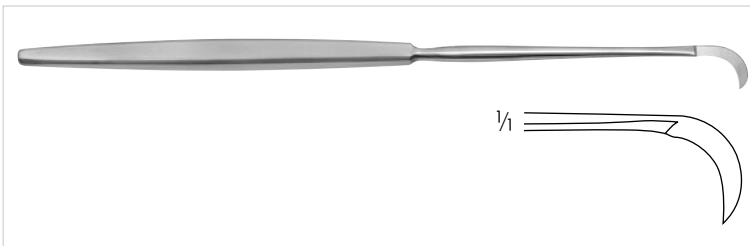

430-652-215
BRUENINGS
Tonsillennmesser, 230 mm
Tonsil knife, 9 inch



430-650-215
ABRAHAM
Tonsillennmesser, spitz 220 mm
Tonsil knife, sharp 8 3/4 inch

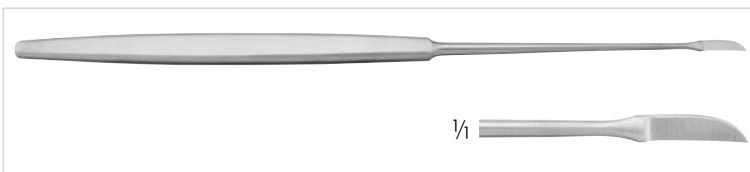

430-654-200
PERWITZSCHKY
Tonsillennmesser, 210 mm
Tonsil knife, 8 1/4 inch

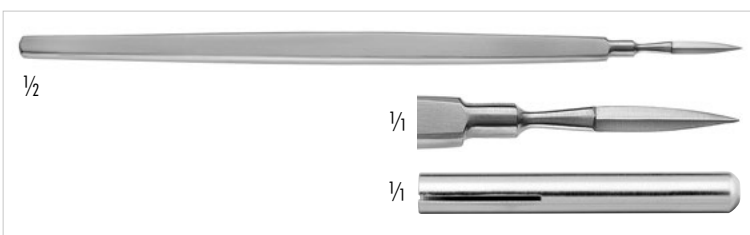

430-656-195
Tonsillennmesser, mit doppelter Schneide, mit Schutzkappe, 175 mm
Tonsil knife, double-edge cutting, with protection cup, 7 inch



110-130-077
Skalpelli Griff, Nr. 7, 165 mm
Scalpel handle, No.7, 6 1/2 inch



110-116-033
Skalpelli Griff, Nr. 3L, 210 mm
Scalpel handle, No. 3L, 8 1/4 inch

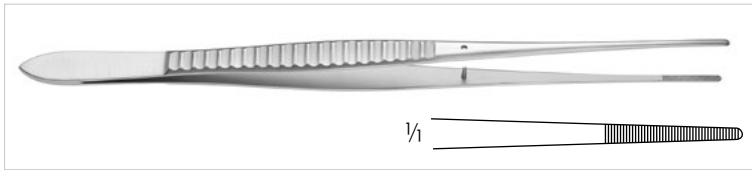

130-038-200
WAUGH
Feine anatomische Pinzette, 200 mm
Delicate dissecting forceps, 8 inch

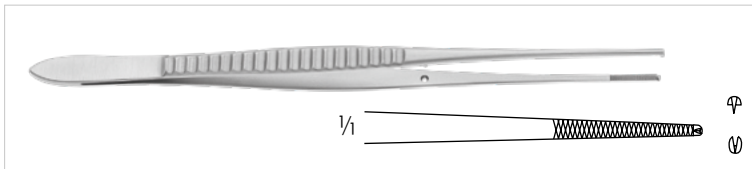

130-160-200
WAUGH
Feine chirurgische Pinzette, 1 x 2 Zähne, 200 mm
Delicate tissue forceps, 1 x 2 teeth, 8 inch

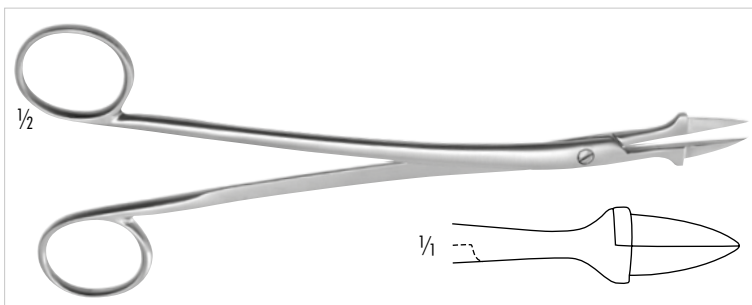

430-605-200
THILENIUS
Tonsillenabszeßzange, 190 mm
Tonsil abscess forceps, 7 1/2 inch

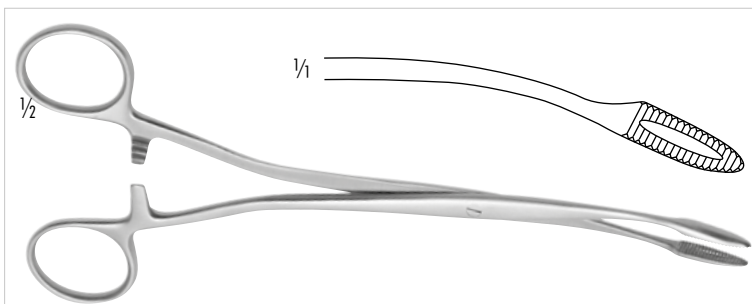

150-130-200 gerade/straight
150-131-200 gebogen/gebogen
DUPLAY
Polypenzange, 200 mm
Dressing forceps, 8 inch

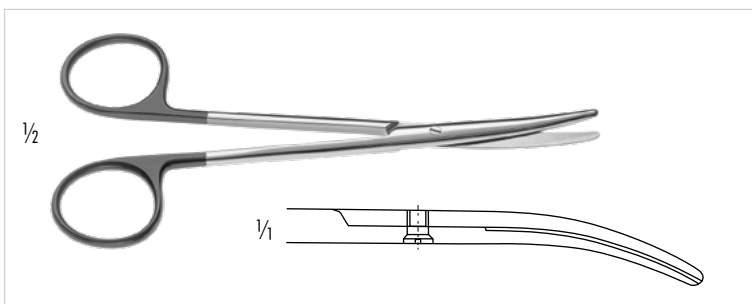

121-111-145 145 mm, 5 3/4 inch
121-111-180 180 mm, 7 inch
121-111-200 200 mm, 8 inch
METZENBAUM
SC Präparierschere, gebogen
SC Dissecting scissors, curved

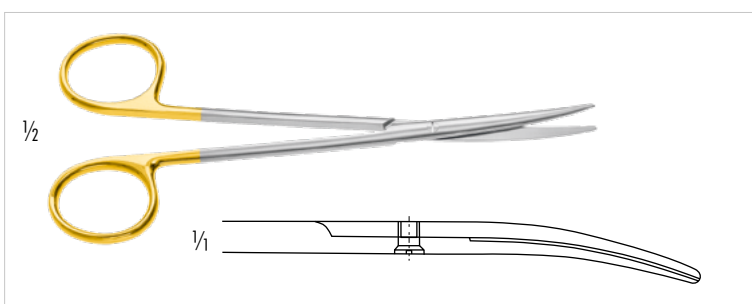

120-521-145 145 mm, 5 3/4 inch
120-521-180 180 mm, 7 inch
120-521-200 200 mm, 8 inch
METZENBAUM
TC Präparierschere, gebogen
TC Dissecting scissors, curved

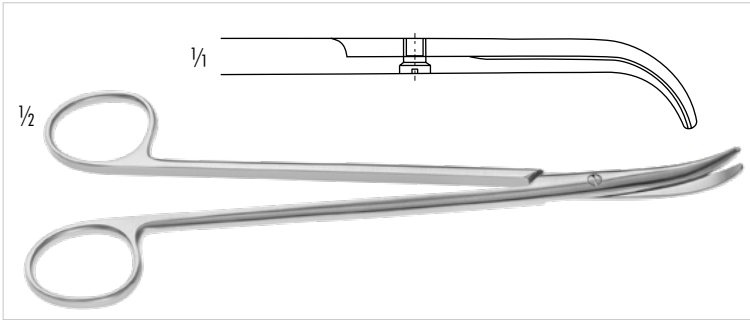

120-133-190

THOREK

Tonsillenschere, stark gebogen, 190 mm
Tonsil scissors, strong curved, 7 1/2 inch

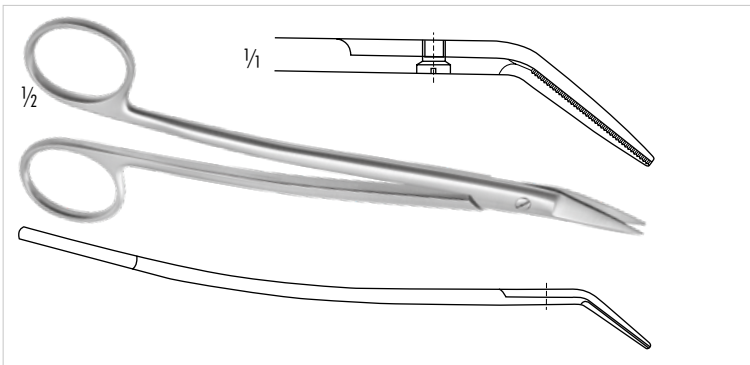

120-213-170

DEAN

Tonsillenschere, aufgebogen, Blätter gezahnt, 170 mm
Tonsil scissors, angled upwards, serrated blades, 6 3/4 inch

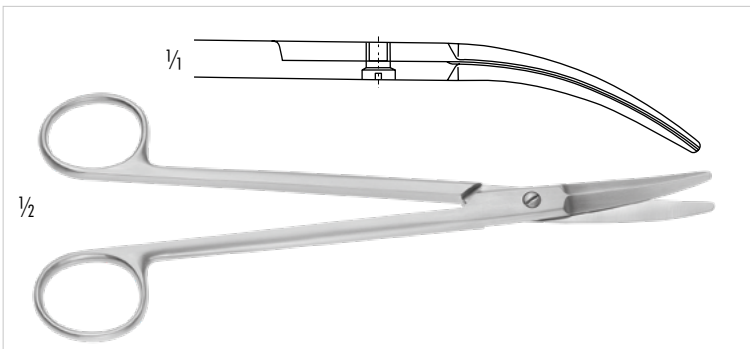

120-209-180

BOETTCHER

Tonsillenschere, gebogen, 180 mm
Tonsil scissors, curved, 7 inch

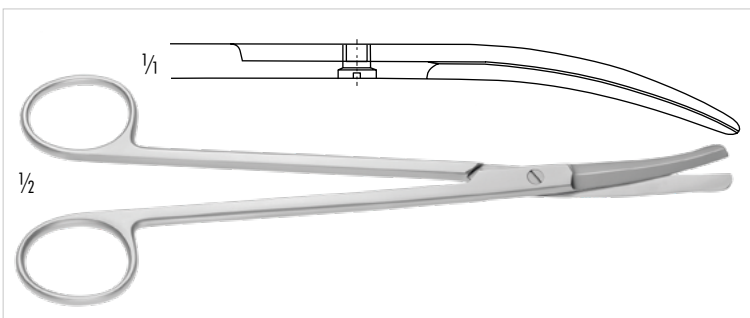

120-217-190

GOOD

Tonsillenschere, 190 mm
Tonsil scissors, 7 1/2 inch

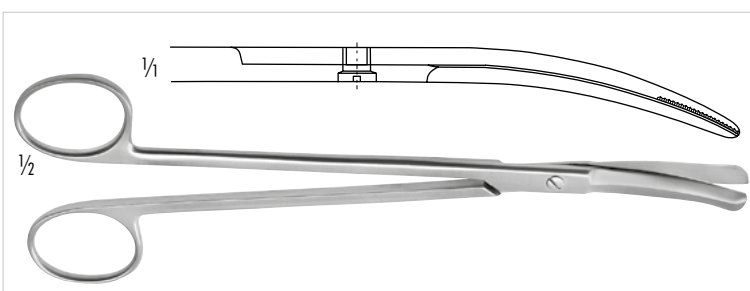

120-218-190

SCHWECKENDIEK

Tonsillenschere, 195 mm
Tonsil scissors, 7 3/4 inch

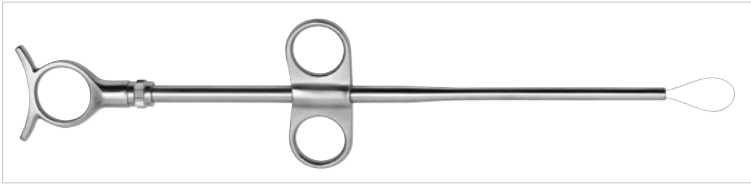

430-603-280
EVES
 Tonsillenschnürer, 285 mm
 Tonsil snare, 11 ¼ inch



430-604-280
EVES
 Tonsillenschnürer, mit Sperre, 285 mm
 Tonsil snare, with ratchet, 11 ¼ inch



430-605-270
BRUENINGS
 Tonsillenschnürer, 270 mm
 Tonsil snare, 10 ½ inch

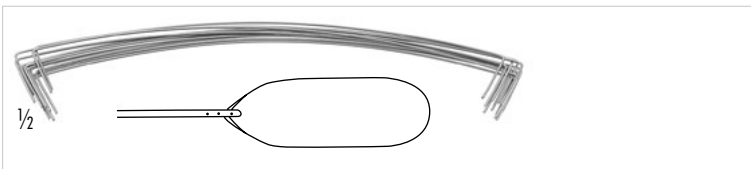

430-606-003 Ø 0,3 mm
430-606-005 Ø 0,5 mm
 Schnürerdrähte, Bestelleinheit: DZ=Packung à 12 Stück
 Snare wires, sales unit: DZ=Package of 12 pieces

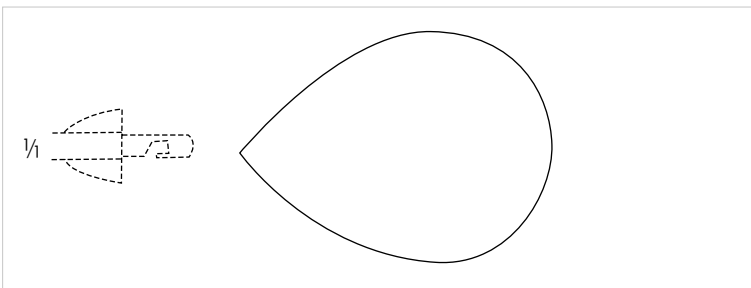

430-606-040 Ø 0,4 mm
 Drahtschlingen, Bestelleinheit: PH=Packung à 100 Stück
 Wire loops, sales unit: PH=Package of 100 pieces

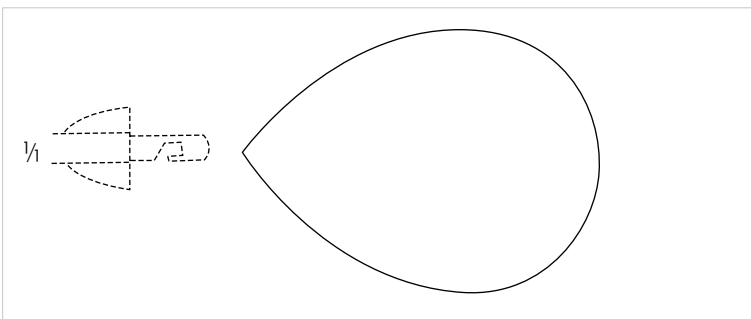

430-607-040 Ø 0,4 mm
 Drahtschlingen, Bestelleinheit: PH=Packung à 100 Stück
 Wire loops, sales unit: PH=Package of 100 pieces

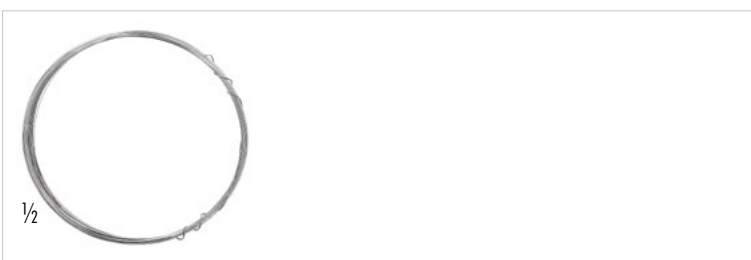

430-607-003 Ø 0,3 mm
 Schnürerdraht, in Rollen à 10 m
 Snare wire in coils of 10 m

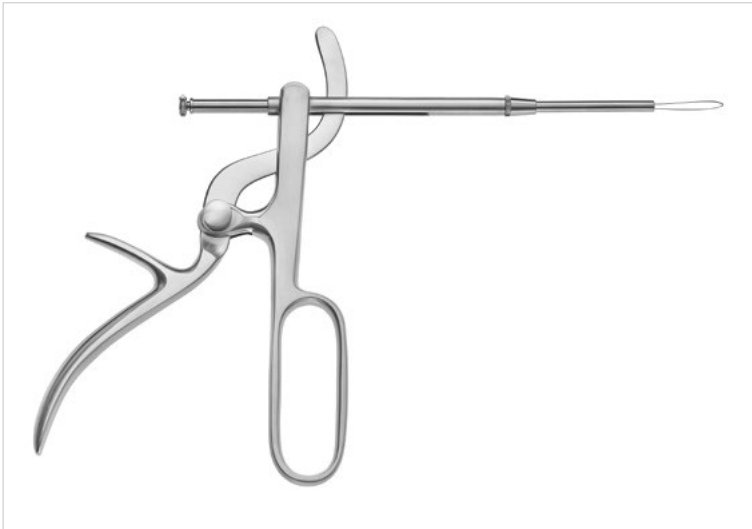

430-620-000

TYDING

Tonsillenschnürer mit abnehmbarem, geradem Aufsatz 430-620-100
Tonsil snare with detachable straight tip 430-620-300



430-620-100

Gerader Aufsatz, allein
Straight tip, only



120-265-120

Drahtschere, eine Schneide gezahnt, 120 mm
Wire cutting scissors, on blade serrated, 4 3/4 inch

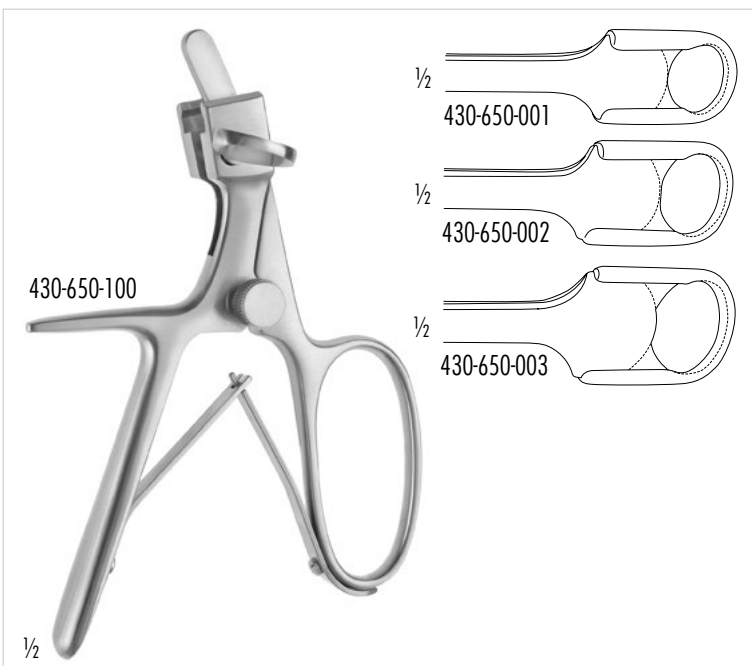

430-650-001 Fig. 1

430-650-002 Fig. 2

430-650-003 Fig. 3

SLUDER-BALLENGER

Aufsätze für Tonsillotomgriff 430-650-100
Blades for tonsillotome handle 430-650-100

430-650-100

Tonsillotomgriff für Aufsätze 430-650-001 - 430-650-003
Tonsillotome handle for blades 430-650-001 - 430-650-003

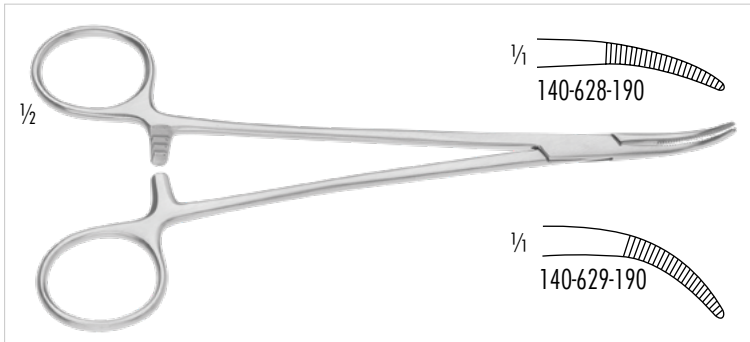

140-628-190 leicht gebogen/slightly curved
 140-629-190 stark gebogen/strongly curved
SCHNIDT
 Tonsillenklemme, 190 mm
 Tonsil artery forceps, 7 1/2 inch

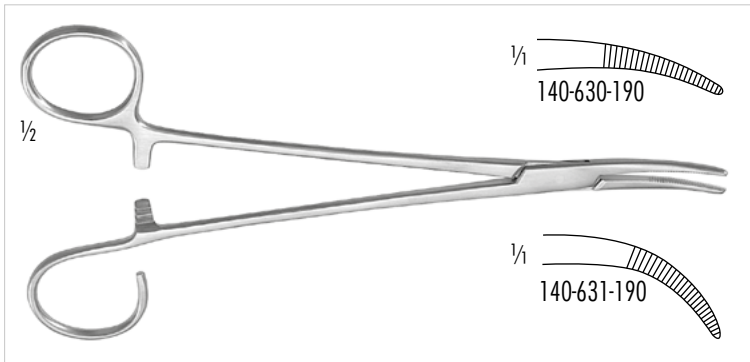

140-630-190 leicht gebogen/slightly curved
 140-631-190 stark gebogen/strongly curved
SCHNIDT
 Tonsillenklemme, mit offenem Ring, 185 mm
 Tonsil artery forceps, with open ring, 7 1/4 inch

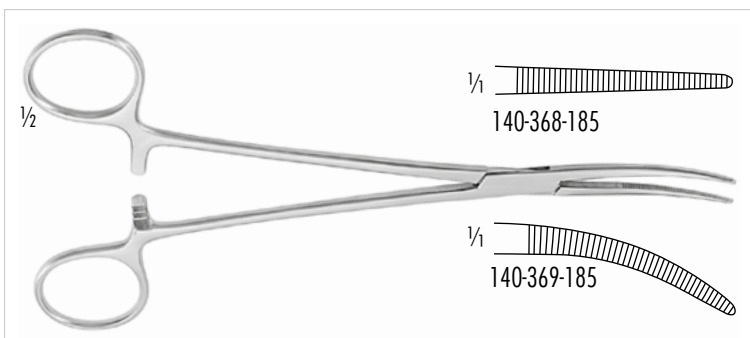

140-368-185 gerade/straight
 140-369-185 gebogen/curved
BIRKETT
 Arterienklemme, 185 mm
 Hemostatic forceps, 7 1/4 inch

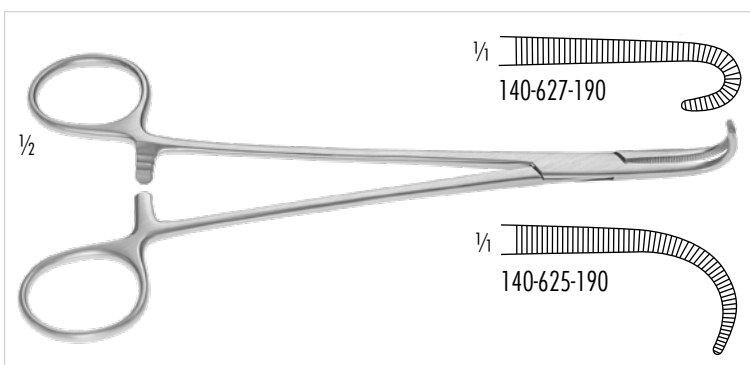

140-625-190 leicht gebogen/slightly curved
 140-627-190 stark gebogen/strongly curved
NEGUS
 Tonsillenklemme, 190 mm
 Tonsil artery forceps, 7 1/2 inch

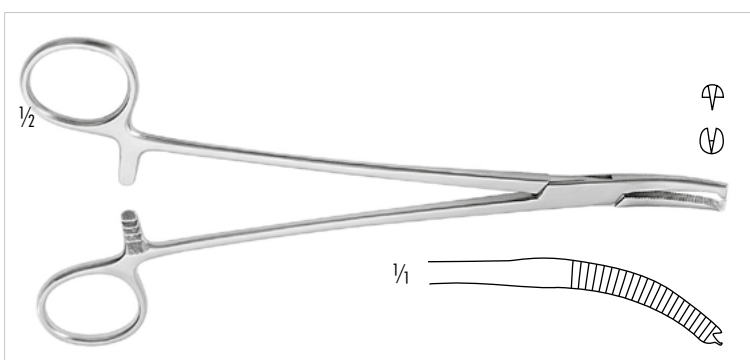

140-549-200
MIKULICZ
 Tonsillenklemme, 1x2 Zähne, 200 mm
 Tonsil artery forceps, 1x2 teeth, 8 inch

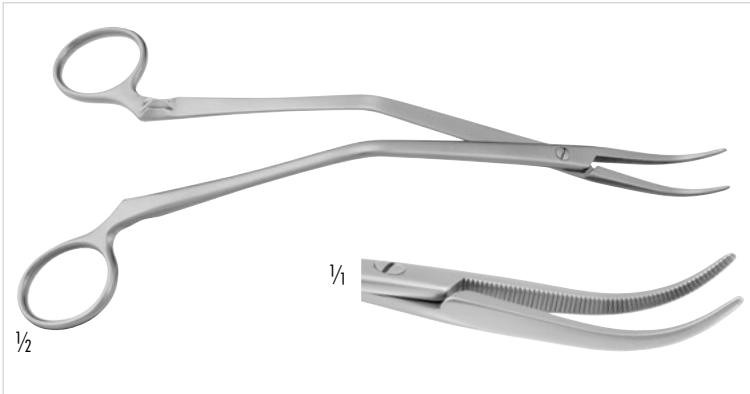

140-639-190
WILSON
 Tonsillenklemmen, sehr fein, 190 mm
 Tonsil artery forceps, very delicate, 7 1/2 inch



180-720-230
CLAUS-EICKEN
 Unterbindungsnaedel, 230 mm
 Ligature needle, 9 inch



180-711-240
NAGER
 Unterbindungsnaedel, 240 mm
 Ligature needle, 9 1/2 inch



180-718-210 links/left
 180-719-210 rechts/right
HURD
 Unterbindungsnaedel, 210 mm
 Ligature needle, 8 1/4 inch

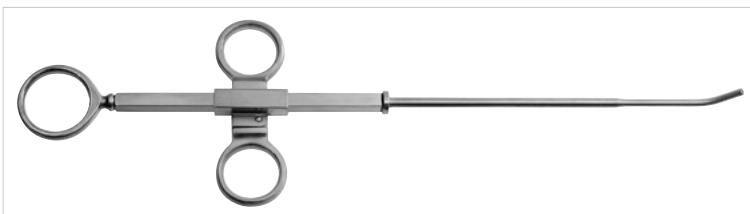

430-500-260
ROEDER
 Ligaturinstrument, 260 mm
 Ligature instrument, 10 1/4 inch



430-505-205
NEGUS
 Fadengabel, 205 mm
 Knot tyer, 8 inch

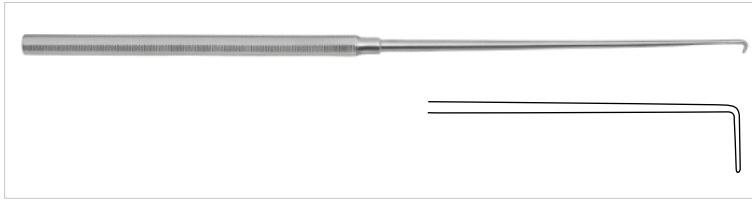

430-506-210
CLAUS-EICKEN
Fadenfänger, 210 mm
Suture hook (catcher), 8 ¼ inch

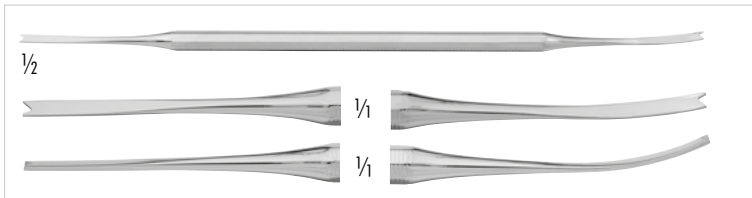

430-602-175
LUNIATSCHEK
Tonsillen Tamponstopfer, 2 mm, 190 mm
Tonsil gauze packers, 2 mm, 7 ½ inch



430-520-230
NAGER
Tonsillenretraktor, 230 mm
Tonsil retractor, 9 inch

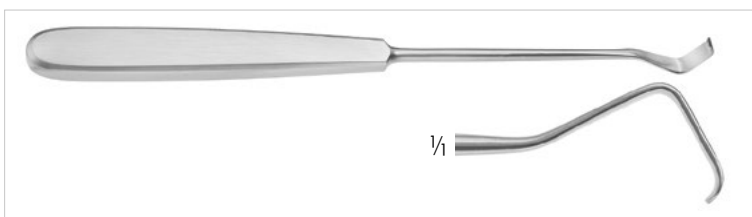

430-245-200
SCHOENBORN
Gaumenhaken, 13 x 6 mm, 210 mm
Uvula hook, 13 x 6 mm, 8 ¼ inch



430-300-230
HOFER
Gaumenretraktor, 240 mm
Uvula retractor, 9 ½ inch



430-522-230
HURD
Elevator, 230 mm
Elevator, 9 inch



430-524-210
NAGER
Gaumenhaken, 210 mm
Uvula retractor, 8 ¼ inch

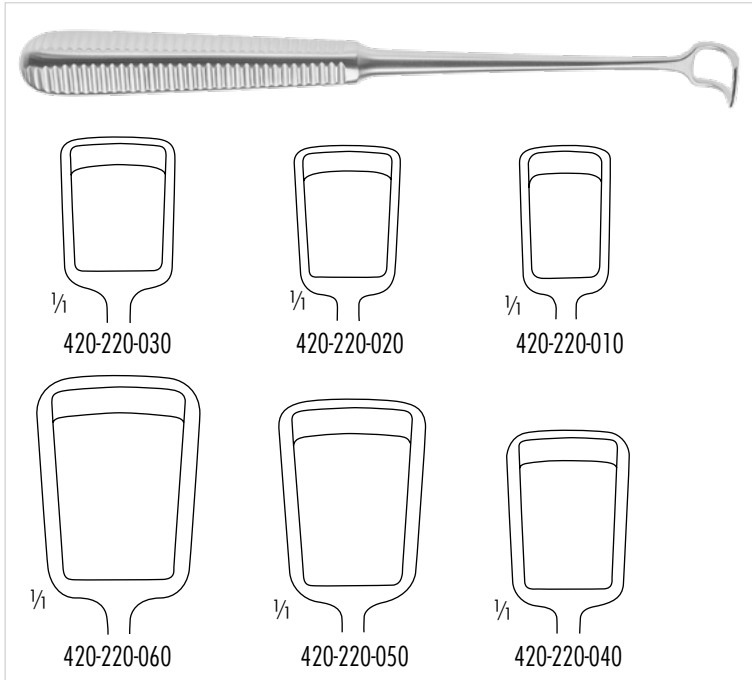

- 420-220-010 8 mm, Fig. 1
- 420-220-020 10 mm, Fig. 2
- 420-220-030 12 mm, Fig. 3
- 420-220-040 14 mm, Fig. 4
- 420-220-050 16 mm, Fig. 5
- 420-220-060 18 mm, Fig. 6
- 420-220-070 19.5 mm, Fig. 7

BECKMANN

Ringmesser, 220 mm
Adenoid curette, 8 3/4 inch

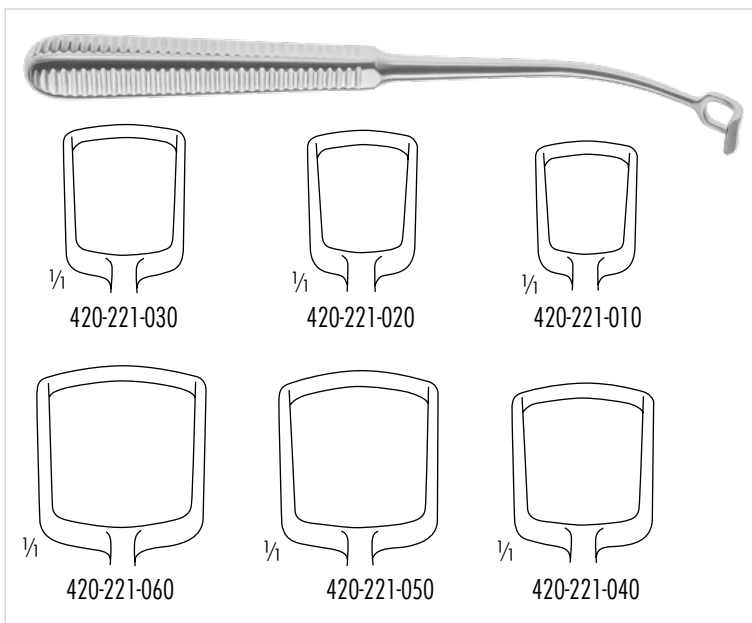

- 420-221-010 8 mm, Fig. 1
- 420-221-020 10 mm, Fig. 2
- 420-221-030 12 mm, Fig. 3
- 420-221-040 14 mm, Fig. 4
- 420-221-050 16 mm, Fig. 5
- 420-221-060 18 mm, Fig. 6
- 420-221-070 19.5 mm, Fig. 7

BECKMANN

Ringmesser, gebogen 220 mm
Adenoid curette, curved 8 3/4 inch

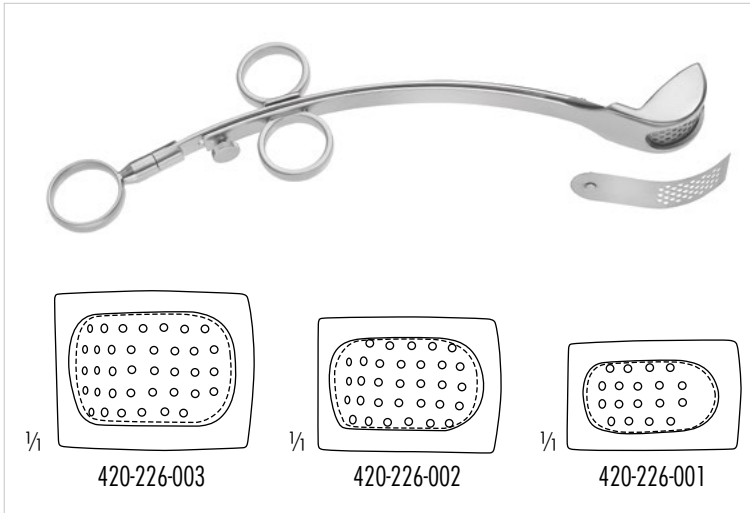

- 420-226-001 12 mm
- 420-226-002 16 mm
- 420-226-003 18 mm

LA FORCE

Pharynx Tonsillotom, 230 mm
Adenotomes, 9 inch

- 420-226-101
- 420-226-102
- 420-226-103

LA FORCE

Eratzklingen, allein, gelocht, passend für 420-226-001 - 420-226-003
Spare blades only, perforated, suitable for 420-226-001 - 420-226-003

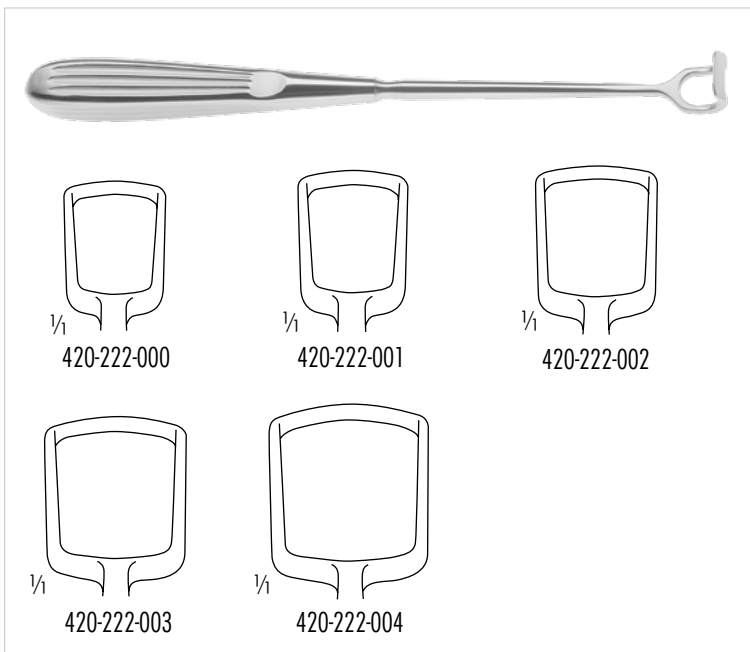

- 420-222-000 Fig. 0
- 420-222-001 Fig. 1
- 420-222-002 Fig. 2
- 420-222-003 Fig. 3
- 420-222-004 Fig. 4

BARNHILL

Ringmesser, 220 mm
Adenoid curette, 8 3/4 inch



420-395-240
JATHO
 Nasenrachenraumzange, 240 mm
 Nasopharynx forceps, 9 1/2 inch

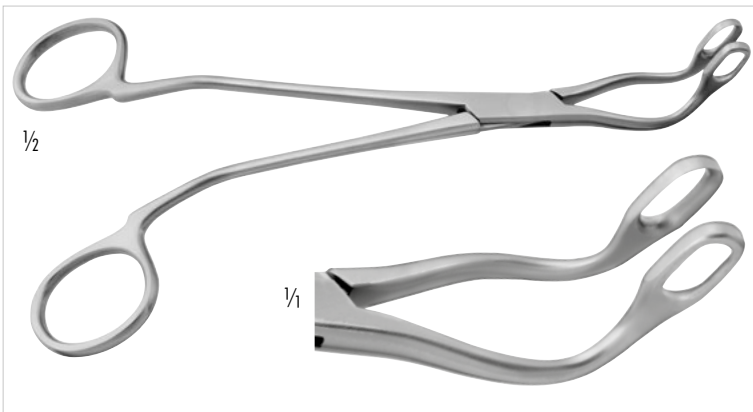

420-396-190
JURASZ
 Nasenrachenzange für Kinder, 190 mm
 Adenoid cutting forceps for children, 7 1/2 inch

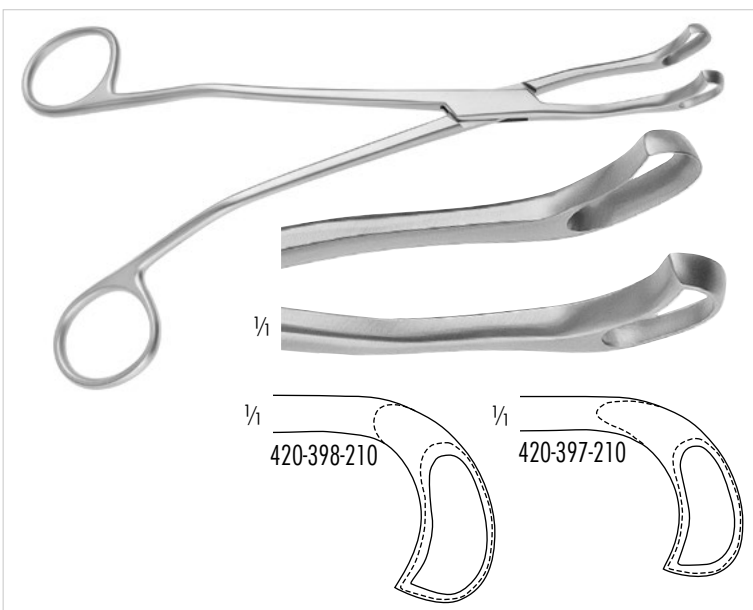

420-397-210 Fig. 1
 420-398-210 Fig. 2
JURASZ
 Nasenrachenzange, 210 mm
 Adenoid cutting forceps, 8 1/4 inch

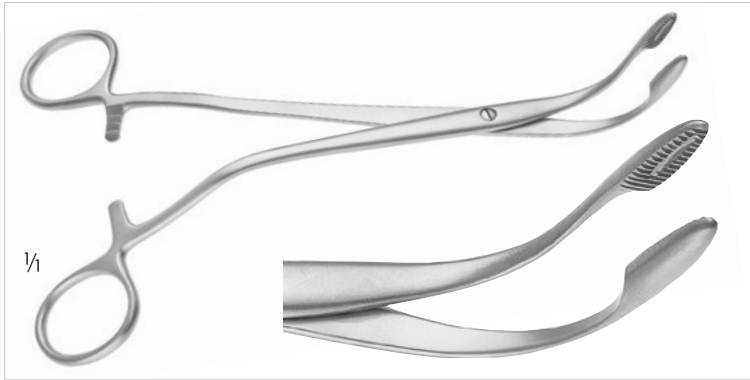

420-398-190

DUPLAY

Nasenrachenraum Tupferzange, s-förmig gebogen, 190 mm
Nasopharyngeal sponge holding forceps, s-shaped, 7 1/2 inch

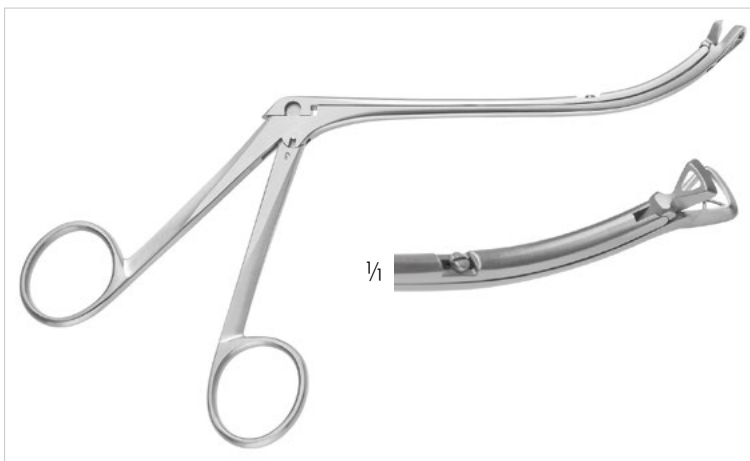

420-391-000 Fig.0 6 mm

420-391-001 Fig.1 7 mm

420-391-002 Fig.2 8 mm

RONIS

Adenoidzange, durchschneidend, Schaft aufgebogen,
dreieckig, Arbeitslänge: 130 mm

Adenoid Forceps, through cutting, upcurved shaft,
triangular bite, working length: 5 inch



420-391-115

KING

Adenoidzange, durchschneidend, Schaft abgebogen,
dreieckig, Fig. 1, 7mm Schnitt, 130mm

Adenoid Forceps, through cutting, downcurved shaft,
triangular bite, Fig. 1, 7 mm bite, 5 inch

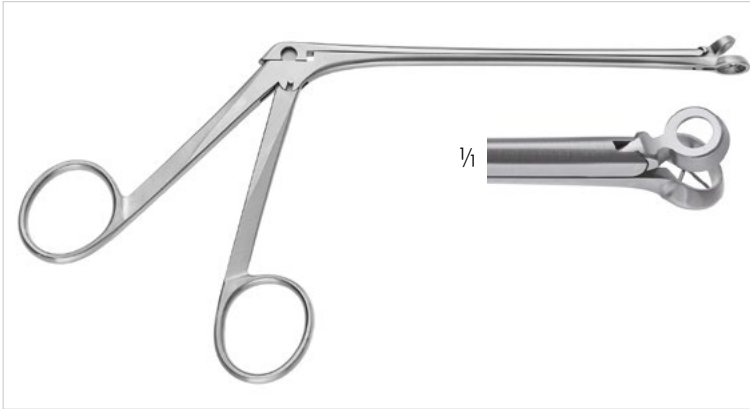

420-401-001 7 mm, Fig.1
420-401-002 8 mm, Fig.2

MELZER
Adenoidzange, durchschneidend, rund, mit Gitter, 140 mm
Adenoid Forceps, through cutting, round, with basket, 5 1/2 inch

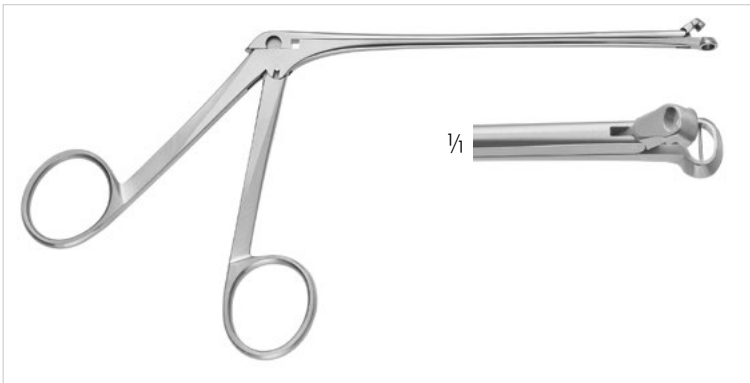

420-401-201 Fig.1

MELZER
Adenoidzange, durchschneidend, oval, 5,2x 3,2mm Schnitt,
Arbeitslänge: 140 mm
Adenoid Forceps, through cutting, oval, 5.2 x 3.2mm bite,
working length: 5 1/2 inch

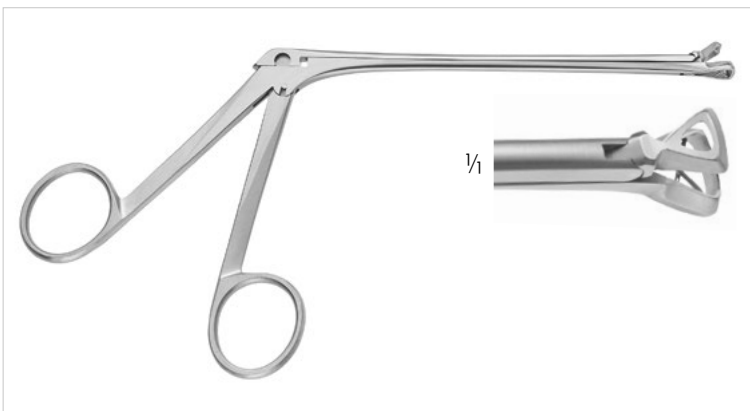

420-401-100 6 mm, Fig.0
420-401-101 7 mm, Fig.1
420-401-102 8 mm, Fig.2
420-401-103 10 mm, Fig.3

MELZER
Adenoidzange, durchschneidend, dreieckig, mit Gitter, 140 mm
Adenoid Forceps, through cutting, triangular, with basket, 5 1/2 inch



420-131-190
YANKAUER
Nasenrachenraum Spekulum, 190 mm
Nasopharyngeal speculum, 7 1/2 inch

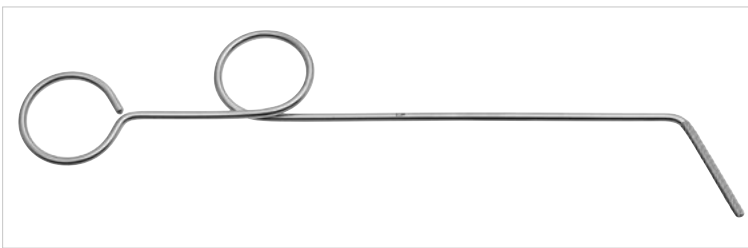

160-481-200 Ø 2.3 mm
HARTMANN
Watteträger, spiralförmig gerieft, 220 mm
Postnasal applicator, spiral end, 8 1/2 inch



410-046-180 Ø 1,0 mm
RZ
Speichelgangsonde, aus Silber, 180 mm
Salival duct probe, silver plated, 7 inch

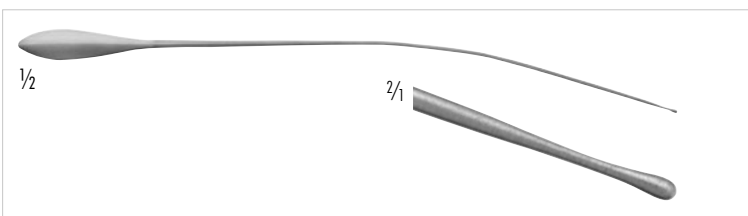

410-045-180 Ø 1,0 mm
SEIFFERT
Speichelgangsonde, aus Silber, 180 mm
Salival duct probe, silver plated, 7 inch

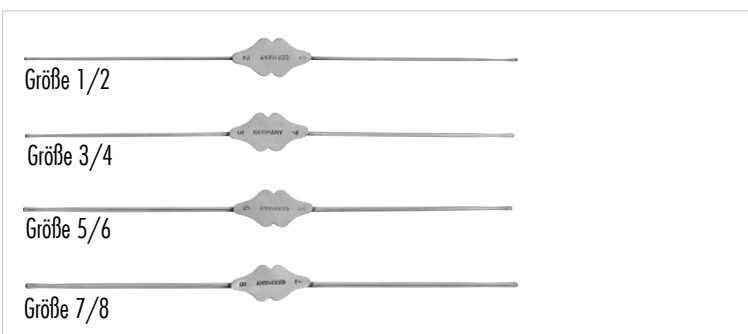

400-310-001 Fig. 1/2
400-310-002 Fig. 00/0
400-310-003 Fig. 3/4
400-310-004 Fig. 0000/000
400-310-005 Fig. 5/6
400-310-006 Fig. 000/00
400-310-007 Fig. 7/8

BOWMAN
Sonden, silber
Lacrimal probes, silver plated

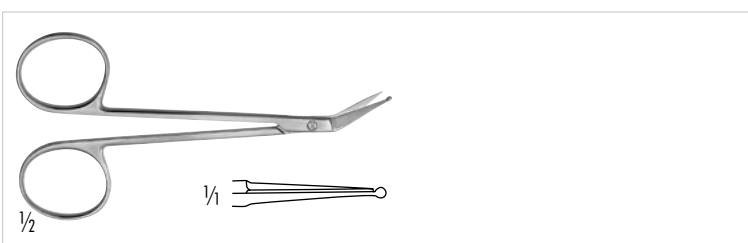

420-100-100
PERWITZSCHKY
Speichelgangschere, 100 mm
Salival scissors, 4 1/2 inch



252-005-170
Tonsillenanüle, gerade, mit LUER-Lock-Ansatz
Tonsil needle, straight, with Luer-lock attachment



252-004-170
Tonsillenanüle, gebogen, mit LUER-Lock-Ansatz
Tonsil needle, strongly curved, with LUER-lock attachment



252-003-170
Septumkanüle, abgewinkelt, mit LUER-Lock Ansatz
Septum needle, angled, with Luer-lock attachment



252-001-170
Septumkanüle, bajonettförmig gebogen, mit LUER-Lock Ansatz
Septum needle, bayonet-shaped, with LUER-lock attachment



165-855-020 3 ml
165-855-050 5 ml
165-855-100 10 ml
Spritze, komplett
Syringe, complete



165-856-020 3 ml
165-856-050 5 ml
165-856-100 10 ml
Glaszylinder, allein
Glas cylinder, only

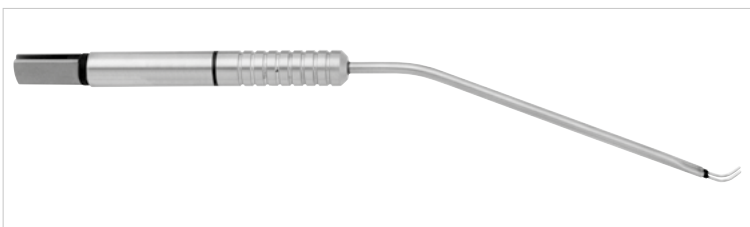

100-866-230
Tonsillen Bipolare Elektrode, stumpf, Nutzlänge 230 mm
Tonsil bipolar electrode, blunt, working length 9 inch

Bipolare Anschlußkabel/Bipolar Cables



2-Bananen-Stecker 2-banana-pin *	Erbe	Martin, Berchtold, Aesculap GK55 + GK60	Valleylab, Lamidey, EMC

Flachstecker/flat-plug

	3 m	700-350-030	700-101-001	700-287-030	700-351-031
	5 m	700-350-050	700-101-000	700-287-050	700-351-051

Flachstecker, Vierkant/flat-plug, square

	3 m	700-350-130	700-101-130	700-287-130	700-351-131
	5 m	700-350-150	700-101-150	700-287-150	700-351-151

* Innerhalb Europas nicht mit CE-Markierung erhältlich
Not available with CE marking within Europe



LARYNGOSCOPY

Instruments and
Equipment for
Laryngoscopy



230-329-006 - 230-329-030
Kehlkopfspiegel, 120 mm
Laryngeal mirror, 4 1/2 inch



230-330-006 - 230-330-030
Kehlkopfspiegel mit Sechskantgriff, 180 mm
Laryngeal mirror with hexagonal handle, 7 inch

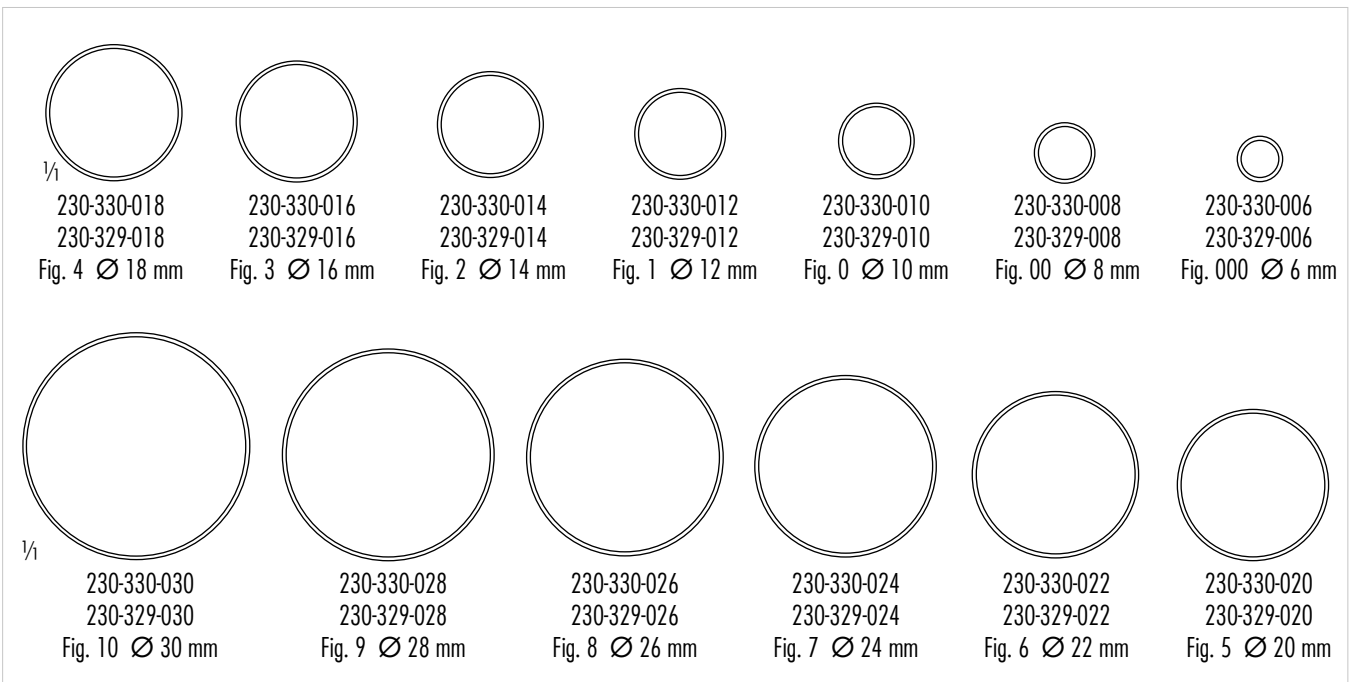

230-332-105
Spiegelgriff, 110 mm
Mirror handle, 4 3/8 inch



230-331-110
Spiegelgriff mit Feststellschraube, 110 mm
Mirror handle with set screw, 4 3/8 inch

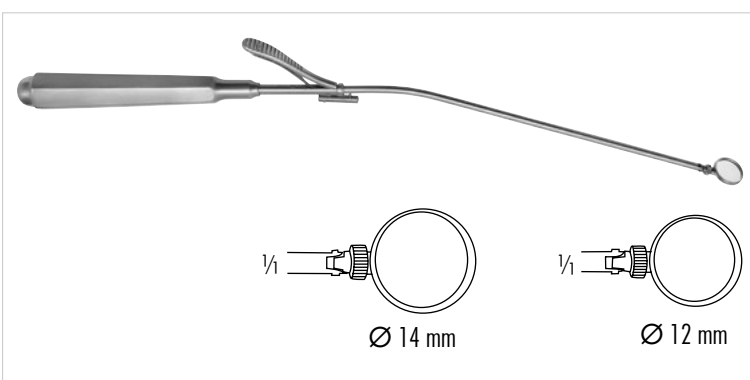

430-788-012 Ø 12 mm 430-788-016 Ø 16 mm
430-788-014 Ø 14 mm 430-788-018 Ø 18 mm

MICHEL
Nasenspiegel mit austauschbaren Spiegelaufsätzen, 250 mm
Rhinoscopic mirror with interchangeable mirror inserts, 10 inch



430-800-100
Kehlkopf-Zerstäuber mit Glaszylinder, 12 ml
Laryngeal-Atomizer with glass barrel, 12 ml



430-803-230
REICHERT
Kehldeckelhalter, 240 mm
Epiglottis retractor, 9 1/2 inch



430-805-250
KILLIAN
Watteträger, 250 mm
Laryngeal applicator, 10 inch

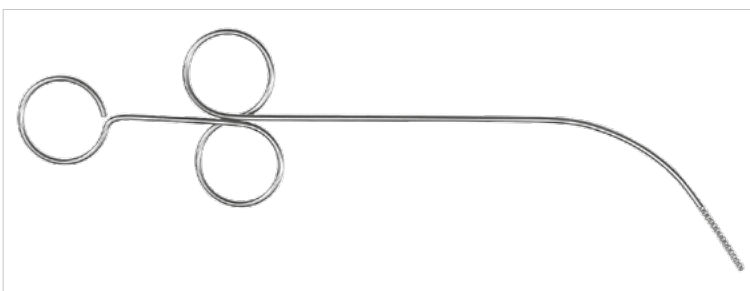

160-495-280
FEIN
Watteträger, 280 mm
Laryngeal applicator, 11 inch

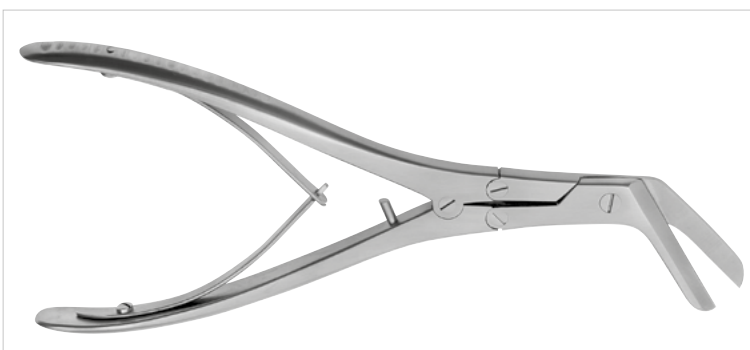

430-813-060
KILLIAN
Laryngo-Fissuren-Schere, 220 mm
Laryngectomy scissors, double action, 8 inch

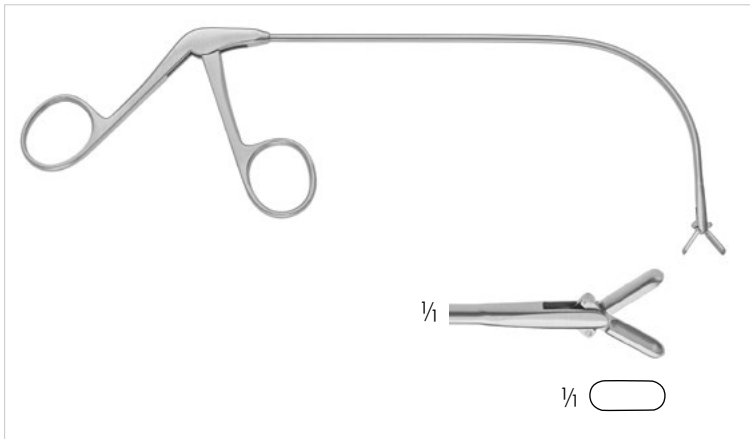

430-813-050

FRAENKEL

Kehlkopfzange, doppelseitig öffnend, länglich ovales Maul, 170 mm
Laryngeal forceps, both sides opening, longitudinal oval jaws, 6 $\frac{3}{4}$ inch

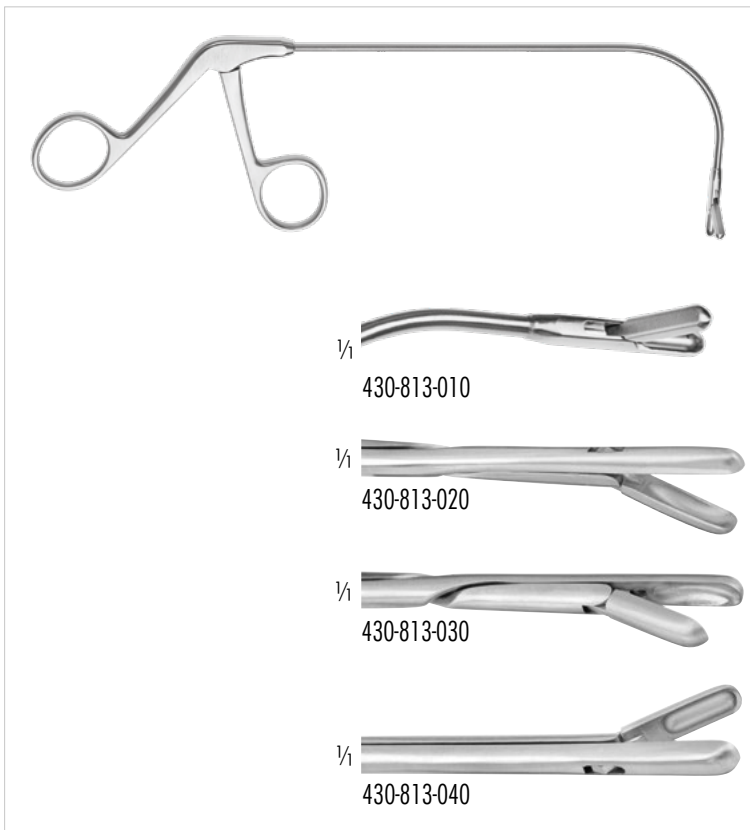

430-813-010 nach rechts öffnend/opening to the right

430-813-020 nach links öffnend/opening to the left

430-813-030 nach unten öffnend/opening downwards

430-813-040 nach oben öffnend/opening upwards

JURASZ

Kehlkopfpolypenzange, 220 mm

Laryngeal polypus forceps, 8 $\frac{1}{2}$ inch

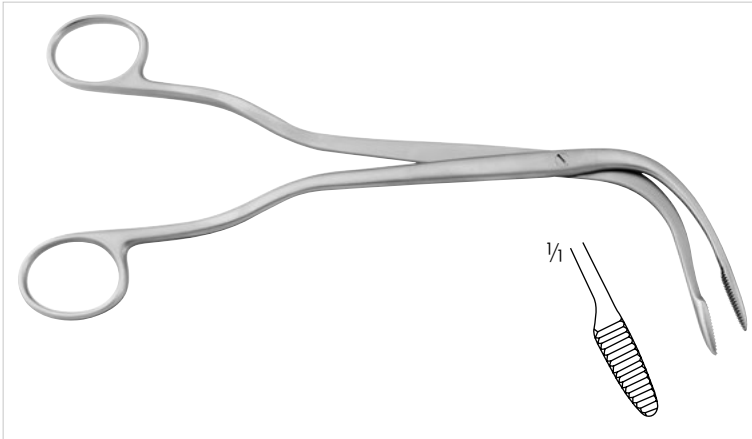

430-815-220
FRAENKEL
Kehlkopfpolypenzange, 220 mm
Laryngeal polypus forceps, 8 3/4 inch



440-120-120
TROUSSEAU
Trachealdilatator, 120 mm
Tracheal dilator, 4 3/4 inch



440-130-140
LABORDE
Trachealdilatator, 140 mm
Tracheal dilator, 5 1/2 inch



170-002-165
BOSE
Trachealhäkchen, rechts, für die linke Hand, 160 mm
Tracheal ligature hook, right, for the left hand, 6 1/4 inch



170-003-165
BOSE
Trachealhäkchen, links, für die rechte Hand, 160 mm
Tracheal ligature hook, left, for the right hand, 6 1/4 inch

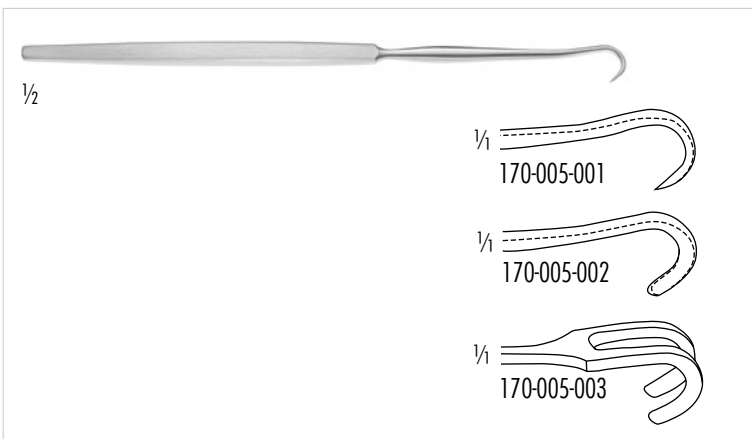

170-005-001
Trachealhaken, scharf, 160 mm
Tracheal retractor, sharp, 6 1/4 inch

170-005-002
Trachealhaken, stumpf, 160 mm
Tracheal hook, blunt, 6 1/4 inch

170-005-003
Trachealhaken, 2 Zähne, stumpf, 160 mm
Tracheal hook, 2 prongs, blunt, 6 1/4 inch



440-221-160
KOCHER
Kropf Sonde, mit Loch, 160 mm
Goitre director, with hole, 6 inch



440-020-130 Ø 9,0 mm
440-021-130 Ø 7,5 mm
UCKERMANN
Trachealtrokar, 130 mm
Tracheal trocar, 5 inch

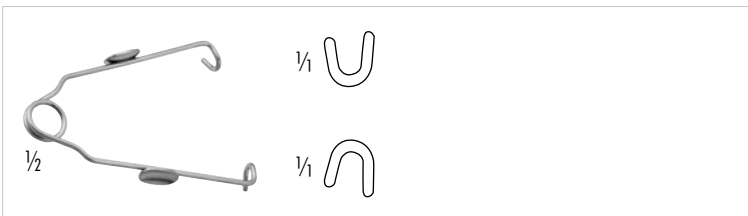

170-700-060
BOSE
Wundspreizer, 60 mm
Tracheal retractor, 2 3/8 inch

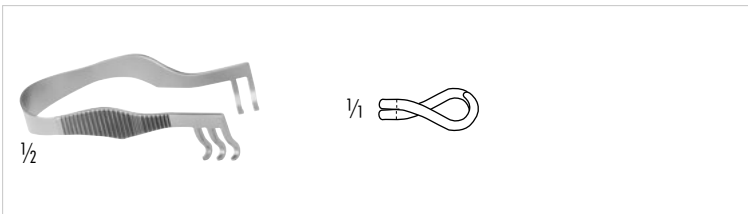

170-701-050
FINSEN
Wundspreizer, 2 x 3 Zähne, stumpf, 50 mm
Tracheal retractor, 2 x 3 teeth, blunt, 2 inch

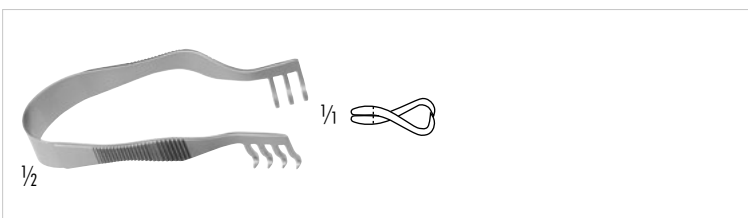

170-702-070 scharf/sharp
170-703-070 stumpf/blunt
FINSEN
Wundspreizer, 3 x 4 Zähne, scharf, 70 mm
Tracheal retractor, 3 x 4 teeth, sharp, 2 3/4 inch

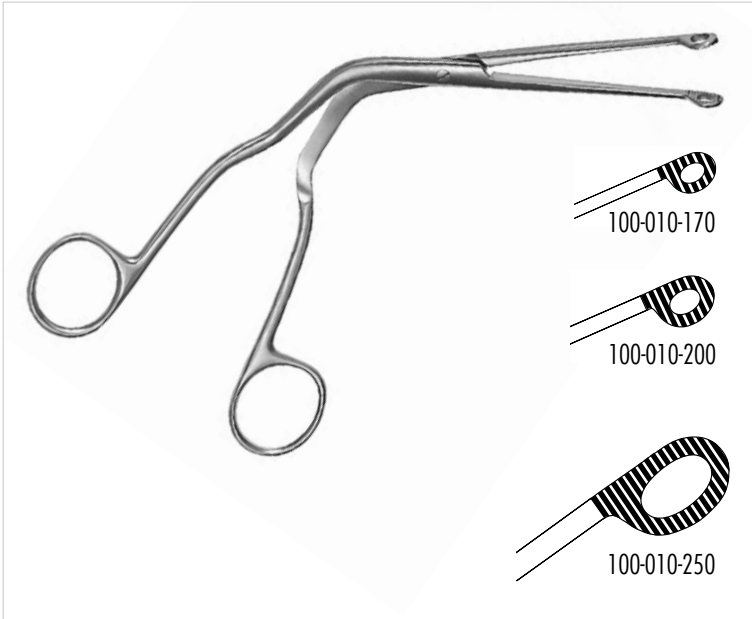

100-010-170
MAGILL
 Kleinkinder, 170 cm
 Small children, 6 ¼ inch

100-010-200
MAGILL
 Kinder, 200 cm
 Children, 8 inch

100-010-250
MAGILL
 Erwachsene, 250 cm
 Adult, 10 inch

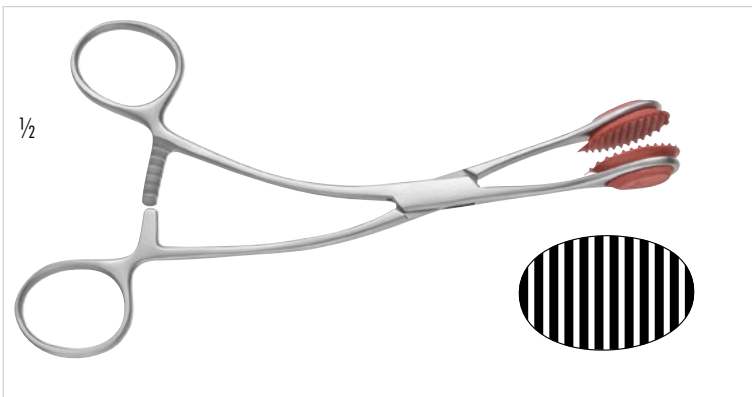

430-467-170
YOUNG
 170 cm
 6 ¼ inch

430-468-000
 Ersatz-Gummi Einsatz, 1 Paar
 Spare rubber inserts, 1 pair



430-465-160 160 mm/6 ½ inch
 430-465-170 170 mm/6 ¾ inch
 430-465-190 190 mm/7 ½ inch
COLLIN
 Zungenzange
 Tongue holding forceps



- 100-210-000 67 mm, Fig. 00
- 100-210-001 75 mm, Fig. 0
- 100-210-002 90 mm, Fig. 1
- 100-210-003 110 mm, Fig. 2
- 100-210-004 130 mm, Fig. 3
- 100-210-005 150 mm, Fig. 4
- 100-210-006 170 mm, Fig. 5

MC INTOSH (English Model)

Warmlicht Layngoskopspatel
Warm-light laryngoscope blade



- 100-212-000 67 mm, Fig. 00
- 100-212-001 75 mm, Fig. 0
- 100-212-002 100 mm, Fig. 1
- 100-212-003 155 mm, Fig. 2
- 100-212-004 195 mm, Fig. 3
- 100-212-005 205 mm, Fig. 4

MILLER

Warmlicht Layngoskopspatel
Warm-light laryngoscope blade



- 100-214-000 75 mm, Fig. 00
- 100-214-001 92 mm, Fig. 0
- 100-214-002 115 mm, Fig. 1
- 100-214-003 130 mm, Fig. 2
- 100-214-004 160 mm, Fig. 3
- 100-214-005 190 mm, Fig. 4

FOREGGER

Warmlicht Layngoskopspatel
Warm-light laryngoscope blade



100-300-002 Für/for Fig. 00 bis 0
 100-300-001 Für/for Fig. 1 bis 5
 Ersatzlämpchen für Spatel
 Spare Lamps for blades

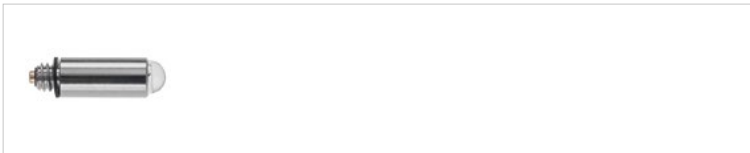

100-260-000
 Halogen Ersatzlampe für Kaltlichtgriff
 Halogen-Lamp for Cold-Light Handle



100-250-000
 Warmlichtgriff, groß, mit Glühbirne, ohne Batterien
 Warm-light handle, large, with bulb, without batteries

100-251-000
 Warmlichtgriff, klein mit Glühbirne, ohne Batterien
 Warm-light handle, small, with bulb, without batteries

100-250-002
 Warmlichtgriff, groß, mit Glühbirne, ohne Batterien,
 Trafo-Anschluss für aufladbare Batterien
 Warm-light handle, large, with bulb, without batteries
 Trafo-connection for rechargeable battery



100-211-010
 Kaltlichtgriff, groß, mit Xenon Lampe, ohne Batterien,
 Trafo-Anschluss für aufladbare Batterien
 Cold-Light handle, large, with Xenon bulb, without batteries
 Trafo-connection for rechargeable battery

100-211-011
 Kaltlichtgriff, Ø18mm, mit Xenon Lampe, ohne Batterien
 Cold-Light handle, Ø18mm, with Xenon bulb, without batteries

100-211-012
 Kaltlichtgriff, Ø30mm, mit Xenon Lampe, ohne Batterien
 Cold-Light handle, Ø30mm, with Xenon bulb, without batteries

100-211-014
 Kaltlichtgriff, Ø 30mm, 2,5V LED-Beleuchtung,
 ohne Trafoanschluss
 Cold-light handle, Ø 30mm, 2.5V LED illumination,



- 100-211-000 50 mm, Fig. 00
- 100-211-001 75 mm, Fig. 0
- 100-211-002 90 mm, Fig. 1
- 100-211-003 110 mm, Fig. 2
- 100-211-004 130 mm, Fig. 3
- 100-211-005 150 mm, Fig. 4

MC INTOSH

Fiberoptik Kaltlicht Laryngoskopspatel
Fiberoptic cold-light laryngoscope blade



- 100-213-000 67 mm, Fig. 00
- 100-213-001 75 mm, Fig. 0
- 100-213-002 100 mm, Fig. 1
- 100-213-003 155 mm, Fig. 2
- 100-213-004 195 mm, Fig. 3
- 100-213-005 205 mm, Fig. 4

MILLER

Fiberoptik Kaltlicht Laryngoskopspatel
Fiberoptic cold-light laryngoscope blade

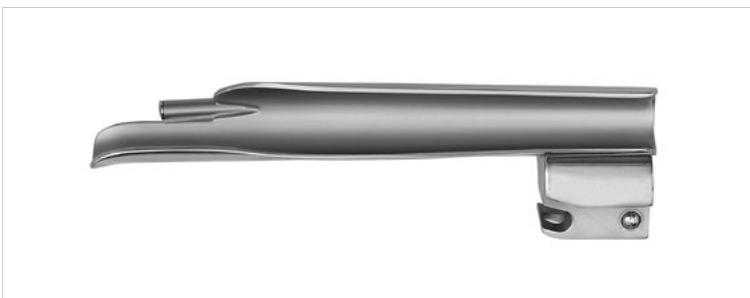

- 100-215-001 92 mm, Fig. 0
- 100-215-002 115 mm, Fig. 1
- 100-215-003 130 mm, Fig. 2
- 100-215-004 160 mm, Fig. 3
- 100-215-005 190 mm, Fig. 4

FOREGGER

Kaltlicht Laryngoskopspatel
Cold-light laryngoscope blade



- 100-218-003 170 mm, Fig. 3
- 100-218-004 190 mm, Fig. 4

MC INTOSH

Kaltlicht Laryngoskopspatel mit flexibler Spitze
Cold-light laryngoscope blade with flexible tip



A Warmlicht Laryngoskop Set im Etui, mit Griff 100-250-000
Warm-light laryngoscope set in Case, with Handle 100-250-000

MC INTOSH (English Model)

100-210-300	5 Spatel/blades, Fig. 0 - 4
100-210-200	4 Spatel/blades, Fig. 1 - 4
100-210-100	3 Spatel/blades, Fig. 1 - 3

MILLER

100-212-300	5 Spatel/blades, Fig. 0 - 4
100-212-200	4 Spatel/blades, Fig. 1 - 4
100-212-100	3 Spatel/blades, Fig. 2 - 4

FOREGGER

100-214-200	5 Spatel/blades, Fig. 0 - 4
100-214-100	4 Spatel/blades, Fig. 1 - 4

B Kaltlicht Laryngoskop Set im Etui, mit Griff 100-211-010
Cold-light laryngoscope set in Case, with Handle 100-211-010

MC INTOSH (English Model)

100-211-300	5 Spatel/blades, Fig. 0 - 4
100-211-200	4 Spatel/blades, Fig. 1 - 4
100-211-100	3 Spatel/blades, Fig. 1 - 3

MILLER

100-213-300	5 Spatel/blades, Fig. 0 - 4
100-213-200	4 Spatel/blades, Fig. 1 - 4
100-213-100	3 Spatel/blades, Fig. 2 - 4

FOREGGER

100-215-200	5 Spatel/blades, Fig. 0 - 4
100-215-100	4 Spatel/blades, Fig. 1 - 4





HOLINGER

Complete with light carrier

90mm, 3"	Newborn	small	100-510-000
120mm, 5"	Babies	small	100-510-001
170mm, 6 ³ / ₄ "	Children	large	100-510-002
180mm, 7"	Adult	large	100-510-003

HOLINGER

Spare light carrier

Newborn	100-510-100
Babies	100-510-101
Children	100-510-102
Adult	100-510-103



JACKSON

Complete with light carrier

90mm, 3"	Newborn	small	100-505-000
125mm, 5"	Babies	small	100-505-001
170mm, 6 ³ / ₄ "	Children	large	100-505-002
180mm, 7"	Adult	large	100-505-003

JACKSON

Spare light carrier

Newborn	100-505-100
Babies	100-505-101
Children	100-505-102
Adult	100-505-103

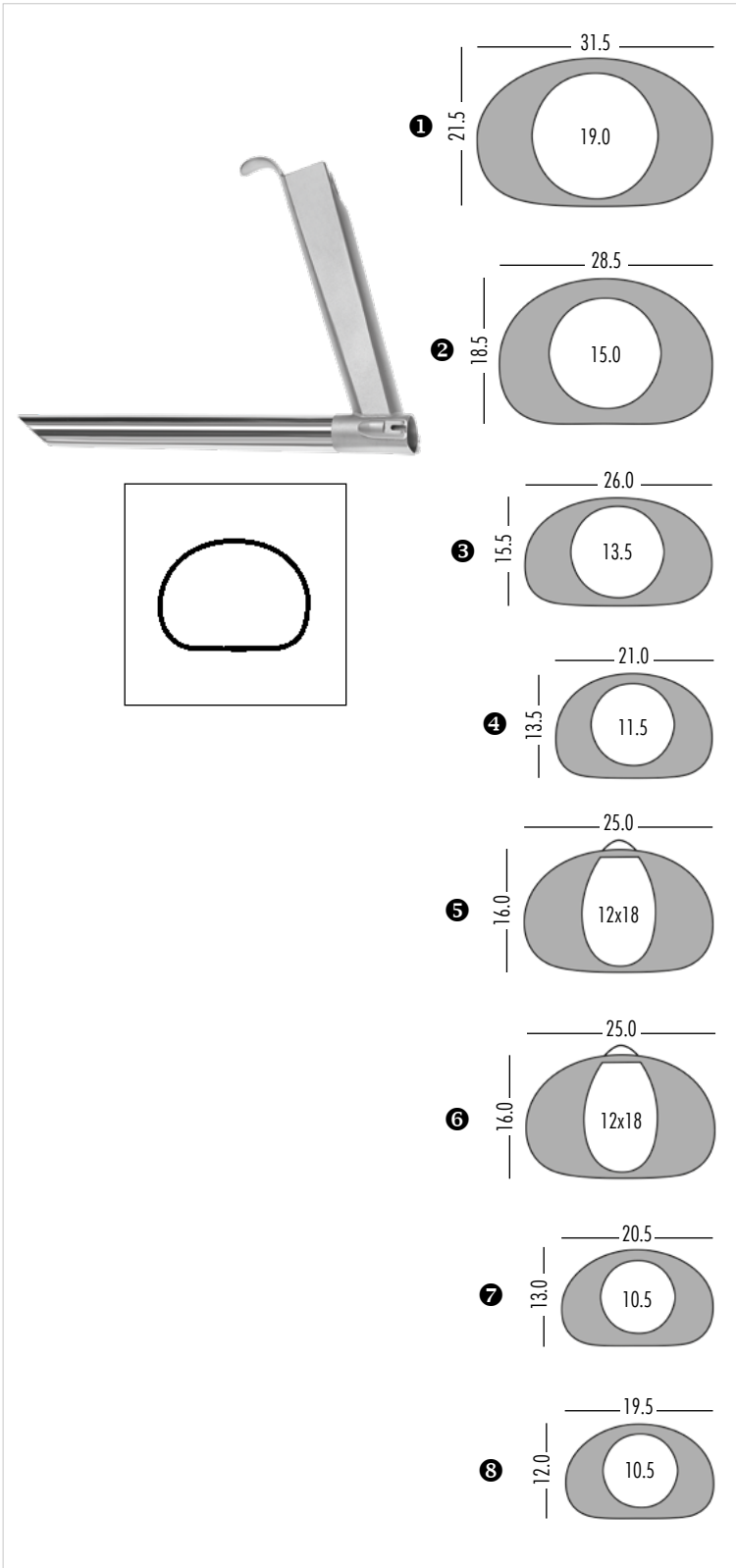

- 1** Adults, extra large

 170mm, 6³/₄" 100-500-008
- 2** Adults, extra large

 170mm, 6³/₄" 100-500-005
- 3** Adults, medium

 170mm, 6³/₄" 100-500-004
- 4** Adults, small

 180mm, 7" 100-500-003
- 5** Adults, medium, anterior

 180mm, 7" 100-500-006
- 6** Adults, medium, long neck

 220mm, 9³/₄" 100-500-007
- 7** Children, small

 150mm, 6" 100-500-002
- 8** Infant, small

 130mm, 5" 100-500-001

KLEINSASSER
 Operationslaryngoskop
 Operation Laryngoscope

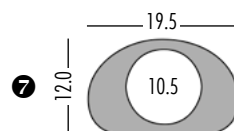
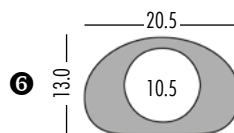
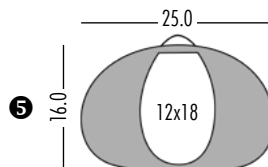
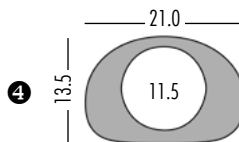
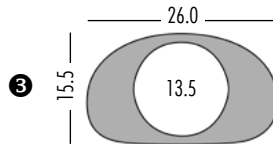
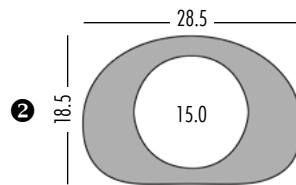
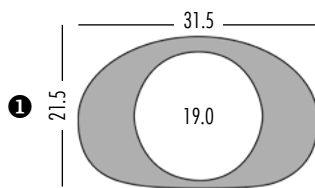
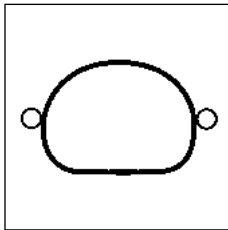

➊ Adults, extra large

170mm, 6³/₄" 100-500-537

➋ Adults, extra large

170mm, 6³/₄" 100-500-536

➌ Adults, medium

170mm, 6³/₄" 100-500-535

➍ Adults, small

180mm, 7" 100-500-534

➎ Adults, medium, anterior

180mm, 7" 100-500-533

➏ Children, small

150mm, 6" 100-500-532

➐ Infant, small

130mm, 5" 100-500-531

KLEINSASSER-LASER

Operationslaryngoskop

Operation Laryngoscope

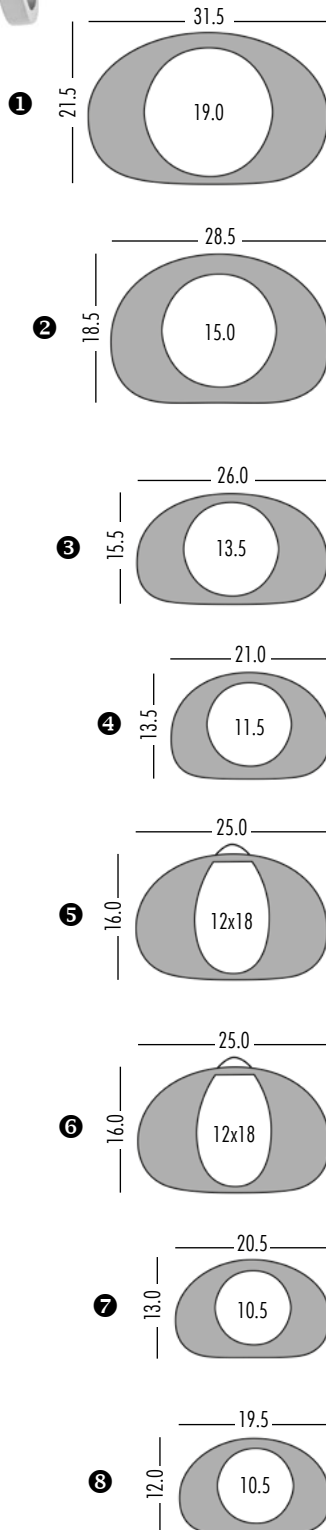
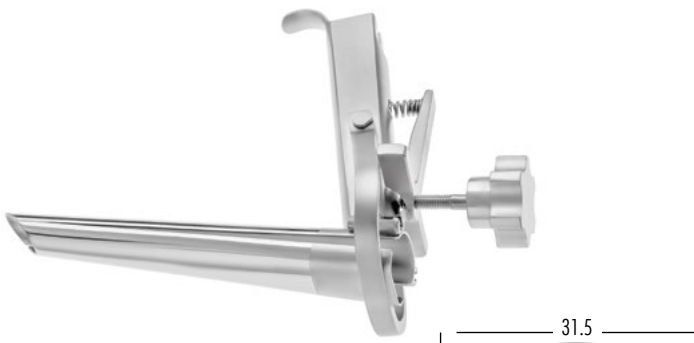

1 Adults, extra large

170mm, 6³/₄" 100-500-208

2 Adults, extra large

170mm, 6³/₄" 100-500-205

2 Adults, medium

170mm, 6³/₄" 100-500-204

4 Adults, small

180mm, 7" 100-500-203

5 Adults, medium, anterior

180mm, 7" 100-500-206

6 Adults, medium, long neck

220mm, 9³/₄" 100-500-207

7 Children, small

150mm, 6" 100-500-202

8 Infant, small

130mm, 5" 100-500-201

Operationslaryngoskop, spreizbar
Operation Laryngoscope, spreadable



① Adults, extra large

180mm, 7" 100-500-583

② Adolescent/adults

180mm, 7" 100-500-582

③ Children, small

135mm, 5 1/3" 100-500-581

Operationslaryngoskop, spreizbar
Operation Laryngoscope, spreadable

PROXIMAL

DISTAL

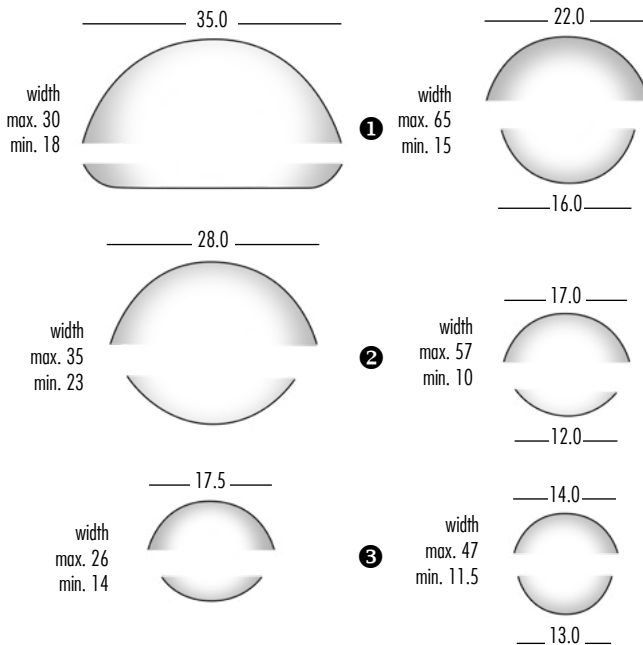

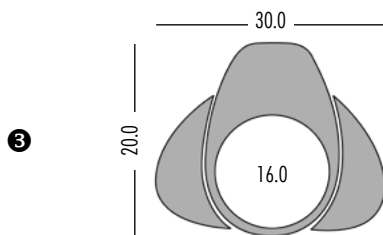
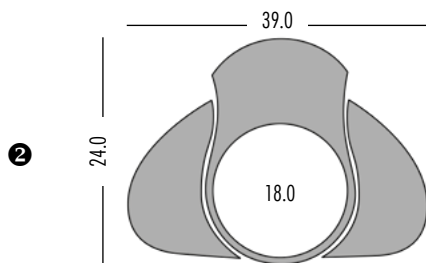
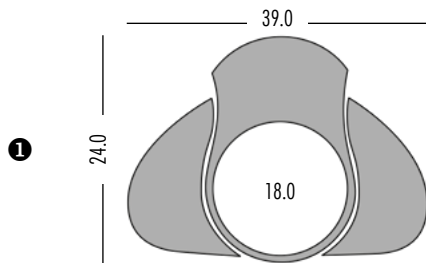

① Adults, large

150mm, 6" 100-500-555

② Adults, large

170mm, 6³/₄" 100-500-554

③ Children, small

110mm, 4¹/₄" 100-500-553

KLEINSASSER, L.

Operationslaryngoskop

Operation Laryngoscope

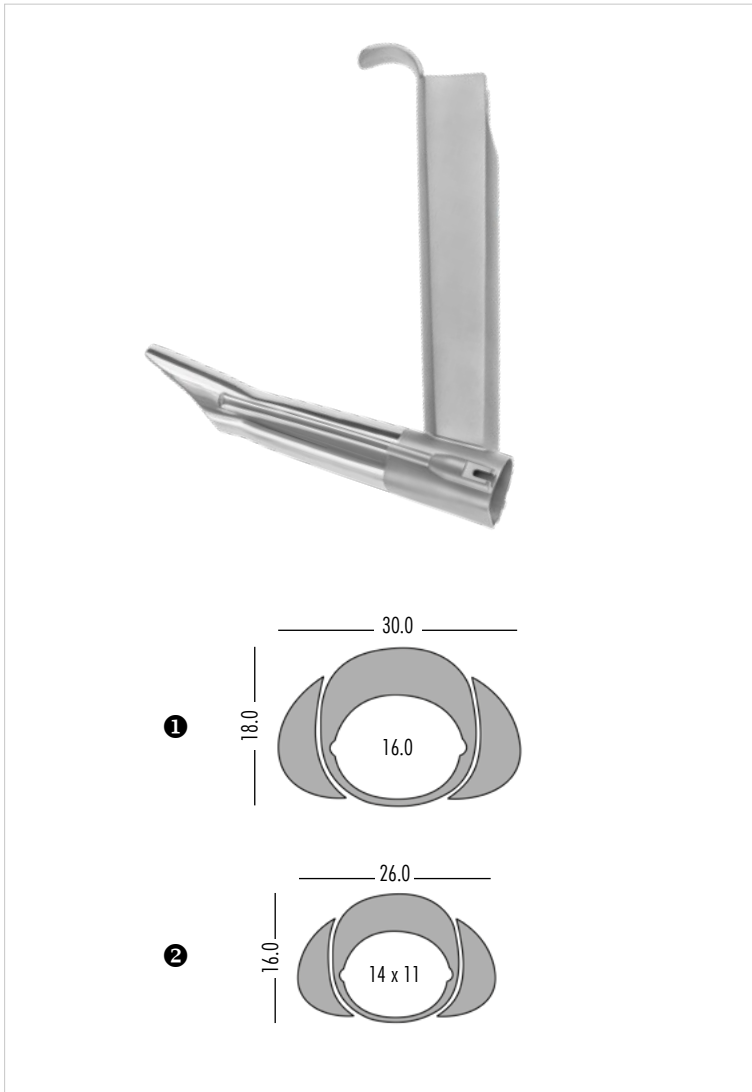

① Children

115mm, 4¹/₂" 100-500-552

② Infant

95mm, 3³/₄" 100-500-551

KLEINSASSER, B-L.

Operationslaryngoskop
Operation Laryngoscope

KLEINSASSER, B.



KLEINSASSER, B.-P.

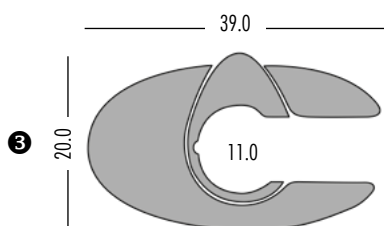
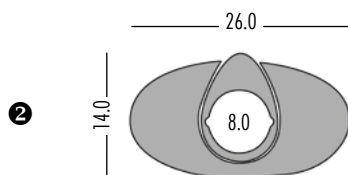
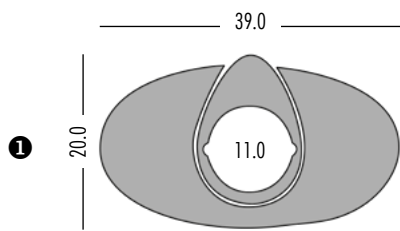

❶ Kleinsasser, B., children, medium
150mm, 6" 100-500-564

❷ Kleinsasser, B., children, small
115mm, 4 1/2" 100-500-563

❸ Kleinsasser, B.-P., children, medium
150mm, 6" 100-500-562

KLEINSASSER, B.
KLEINSASSER, B.-P.
Operationslaryngoskop
Operation Laryngoscope

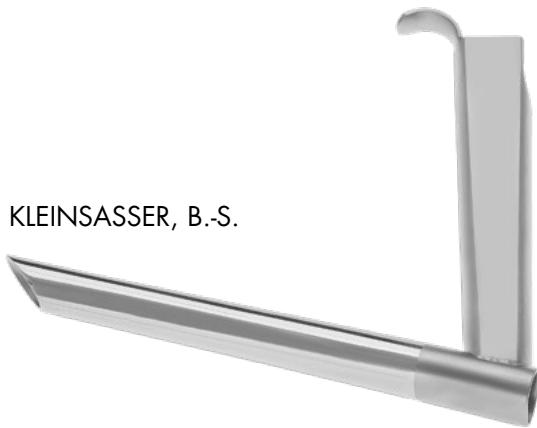

KLEINSASSER, B.-S.



KLEINSASSER, B.-P.-S.

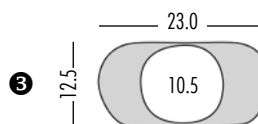
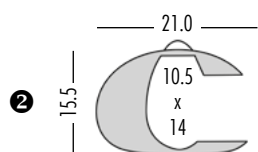
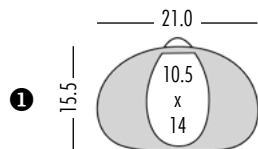

① Kleinsasser, B.-S., adult, slender
170mm, 6³/₄" 100-500-573

② Kleinsasser, B.-P.-S., adult, slender
170mm, 6³/₄" 100-500-572

③ Kleinsasser, B.-S., adult, extra-slender
170mm, 6³/₄" 100-500-571

KLEINSASSER, B.-S.
KLEINSASSER, B.-P.-S.
Operationslaryngoskop
Operation Laryngoscope



75mm/3" working length for 100-500-001/100-500-002 100-500-201/100-500-202	100-500-019
140mm/5 1/2" working length for 100-500-003 - 100-500-008 100-500-203 - 100-500-208	100-500-020

Lichtträger
Fiber Optic Light Carrier



120mm/4 3/4" working length for 100-500-531	100-500-538
140mm/5 1/2" working length for 100-500-532	100-500-539
160mm/6 1/4" working length for 100-500-533 - 100-500-537	100-500-540

Lichtträger
Fiber Optic Light Carrier



120mm/4 3/4" working length for 100-500-583 / 100-500-582	100-500-584
100mm/4" working length for 100-500-581	100-500-585

Lichtträger
Fiber Optic Light Carrier



65mm/2 1/2" working length for 100-500-563	100-500-556
75mm/3" working length for 100-500-553 - 100-500-555	100-500-557
120mm/4 3/4" working length for 100-500-562 / 100-500-564	100-500-538

Lichtträger
Fiber Optic Light Carrier

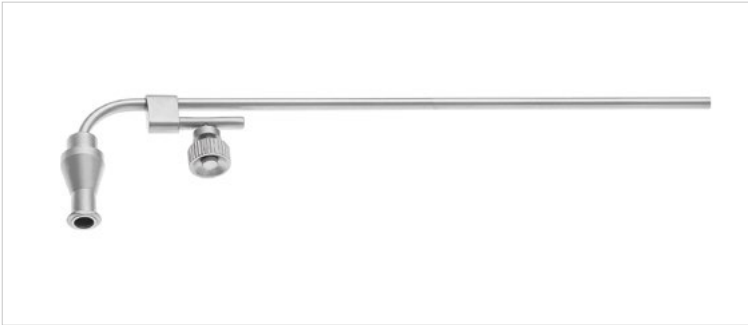

90mm/3 ¹ / ₂ " working length for 100-500-001/100-500-002	100-500-080
125mm/5" working length for 100-500-003/100-500-008	100-500-075

Saugrohr, Ø 3mm
Suction Tube Ø 3mm



120mm/4 ³ / ₄ " working length for 100-500-531	100-500-541
140mm/5 ¹ / ₂ " working length for 100-500-532	100-500-542
160mm/6 ¹ / ₄ " working length for 100-500-533 - 100-500-537	100-500-543

Saugrohr
Suction Tube



100mm/4" working length for 100-500-583 / 100-500-582	100-500-586
120mm/4 ³ / ₄ " working length for 100-500-581	100-500-587

Saugrohr
Suction Tube

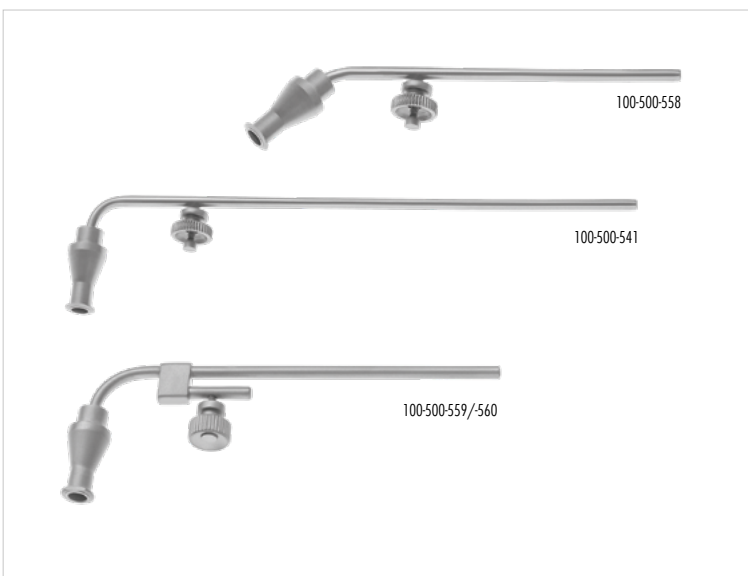

65mm/2 ¹ / ₂ " working length for 100-500-552 / 100-500-551	100-500-558
70mm/2 ³ / ₄ " working length for 100-500-553	100-500-559
85mm/3 ¹ / ₄ " working length for 100-500-555 / 100-500-554	100-500-560
120mm/4 ³ / ₄ " working length for 100-500-562 / 100-500-564	100-500-541

Saugrohr
Suction Tube



85mm/3 ¹ / ₄ " working length for 100-500-001 - 100-500-008 100-500-201 - 100-500-208	100-500-050
---	-------------

Injektionskanüle
Injection Cannula

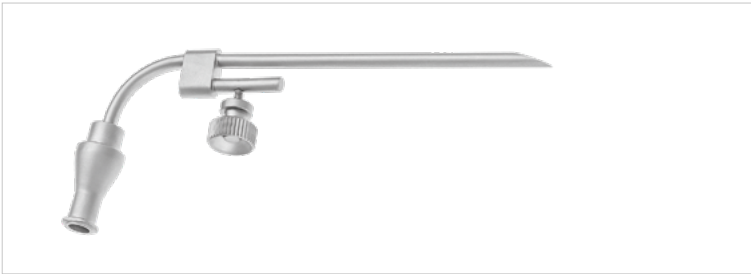

70mm/2 ³ / ₄ " working length 100-500-583 / 100-500-582	100-500-588
--	-------------

Injektionskanüle
Injection Cannula



85mm/3 ¹ / ₄ " working length for 100-500-553 - 100-500-555	100-500-561
--	-------------

Injektionskanüle
Injection Cannula



135mm/5 ¹ / ₄ " working length Ø 2mm	100-500-574
135mm/5 ¹ / ₄ " working length Ø 3mm	100-500-575

Injektionskanüle, biegsam
Injection Cannula, malleable



	100-500-576
--	-------------

Licht Clip
Light Clip



Chest Support, complete, for Operating Laryngoscopes

240mm, 9 ¹ / ₂ "	Ø95mm	Children	100-500-101
340mm, 13 ¹ / ₂ "	Ø95mm	Adult	100-500-100



Support Rod, with ring

240mm, 9 ¹ / ₂ "	Ø95mm	Children	100-500-111
340mm, 13 ¹ / ₂ "	Ø95mm	Adult	100-500-113



Joint for Chest Support

100-500-110

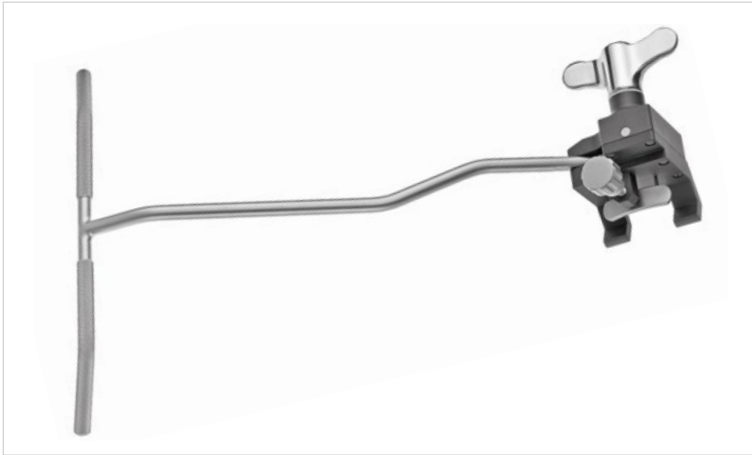
**LEWY**

Chest Support, for Operating Laryngoscopes

340mm, 13 $\frac{1}{2}$ "

Adult

100-500-102



Supporting Table for Chest Support, complete set

100-500-150

Laryngoscope Handle, detachable, for LEWY Chest Support
and Operating Laryngoscopes

100-512-000



Chest Support, complete, for Operating Laryngoscopes

340mm, 13¹/₂" Ø90mm 100-500-200



Support rod only, for Operating Laryngoscopes

340mm, 13¹/₂" Ø90mm 100-500-210



Chest Support, complete with 2 lateral screws,
for Operating Laryngoscopes

340mm, 13¹/₂" ∅120mm

100-500-400



Support rod

340mm, 13¹/₂" ∅120mm

100-500-410



Joint for Breast Support

100-500-420



100-500-310

Rhino-Pharyngoskop
mit Quarzglasbildbündelsystem,
ca 2-3 µm Pixelgröße, 18000 Pixel

Parameter/Technische Daten:

- hohe Auflösung
- hervorragende Bedienungseigenschaften
- größere Helligkeit

Arbeitslänge	max. 300 mm
∅ im Bereich der Arbeitslänge	3,8 mm
2-fach abgewinkelbare Spitze	auf 160° ab 160°
Länge der abwinkelbaren Spitze	20 mm
minimaler Biegeradius	30 mm
Blickrichtung	0°
Bildwinkel	85°
Fokussierung	3 - 60 mm
im Koffer mit Zubehör, u.a. Manometer	

Rhino-Pharyngoscope
with fused silica image guide system,
ca. 2-3 µm pixel size, 18000 pixels

Parameter/Technical Data:

- high resolution
- excellent pushing characteristics
- higher illumination

working length	max. 300 mm
outer ∅	3.7 mm
2-way tip-deflection	up 160°, down 160°
length of movable tip-section	20 mm
minimal bending radius	30 mm
viewing direction	0°
field of view	85°
focussion	3 - 60 mm
in case with accessories a.o. Manometer	

Vollständig gassterilisierbar (ETO/Formaldehyd) und in Desinfektionsmittel einlegbar.
Fully soakable, ETO, gas sterilizable



100-500-380

Rhino-Pharyngoskop
mit konventionellem Bildbündelsystem
12.000 Pixel, 10 µm-Fasern

Parameter/Technische Daten:

- kontrastreiches Bild
- hohe Flexibilität
- einfache Fokussierung

Arbeitslänge	max. 300 mm
∅ im Bereich der Arbeitslänge	3,4 mm
2-fach abwinkelbare Spitze	auf 125° ab 125°
Länge der abwinkelbaren Spitze	25 mm
minimaler Biegeradius	30 mm
Blickrichtung	0°
Bildwinkel	Weitwinkel
Fokussierung	3 mm bis unendlich
im Koffer mit Zubehör, u.a. Manometer	

Rhino-Pharyngoscope
with conventional image guide system,
12.000 pixels, 10 µm-fibres

Parameter/Technical Data:

- high-contrast image
- high flexibility
- easy to focus

working length	max. 300 mm
outer ∅	3.4 mm
2-way tip-deflection	up 125°, down 125°
length of movable tip-section	25 mm
minimal bending radius	30 mm
viewing direction	0°
field of view	wide angle
focussion	3 mm to infinity
in case with accessories a.o. Manometer	



100-500-385

Die Rhino-Pharyngoskope der neuen Generation sind intuitiv bedienbar und ergonomisch optimal geformt, entwickelt für die notwendige Feinfühligkeit im täglichen Routineeinsatz und ein ermüdungsfreies Handling. Hochwertige Bildleiter und ein leistungsfähiges optisches System liefern große und helle Bilder bester Auflösung – die Voraussetzung für eine sichere Diagnose und Therapie.

Dank solider Verarbeitung und konsequenter Verwendung moderner Hochleistungswerkstoffe sind Rhino-Pharyngoskope robuster und langlebiger – trotz steigender Belastung durch moderne Aufbereitungsverfahren. Funktionelles Design für ein entspanntes, angenehmes Handling, feinfühlig aber robuste Steuerung.

Optimale Flexibilität und Torsionssteifigkeit des Einführschachts, leistungsfähiges optisches System, größere, hellere, schärfere Bilder.

Geeignete Wiederaufbereitungsverfahren:

- einlegbar in Reinigungs- und Desinfektionslösung
- STERRAD®
- STERIS®
- ETO
- maschinelle Aufbereitung (RDG-E)

Rhino-Pharyngoskop **mit Arbeitskanal** und ETO-Ventil
14000 pixel

Einführschlauch:	3,8 mm
Arbeitslänge:	300 mm
Abwinklung:	auf/ab 160°
Blickfeld:	85°
Tiefenschärfe:	1-50 mm

Zubehör:

ETO-Kappe
Dichtigkeitstester
Adapter Storz/Olympus
Adapter Wolf

The Rhino-Pharyngoscopes of the new generation allow an intuitive handling: They have been developed in order to meet the required sensitivity in the daily use.

High-quality fibres and a powerful optical system provide great and bright pictures of best resolution – the main condition for a save diagnosis and therapy.

Thanks to the stable manufacture out of modern high-standard material, our Rhino-Pharyngoscopes are very robust and durable – despite growing imposition through modern preparation methods. The functional design offers a relaxed, comfortable handling due to its ergonomic shape under a sensitive but robust control.

Optimal flexibility and torsion rigidity of the sheath.

Suitable preparation methods:

- Solution for cleaning or disinfection
- STERRAD®
- STERIS®
- ETO
- Automatic preparation (RDG-E)

Rhino-Pharyngoscope **with working channel** and ETO valve
14000 pixel

Insertion tube:	3.8 mm
Working length:	11 7/8"
Max bending:	up/down 160°
Field of view:	85°
Depth of field:	1-50 mm

Accessories:

ETO valve
Leakage tester
Adaptor Storz/Olympus
Adaptor Wolf

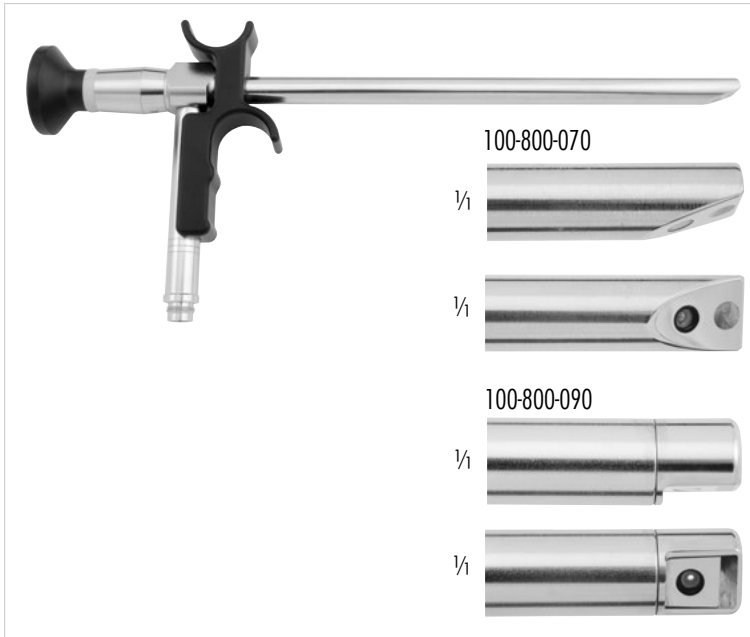

100-800-070 70°
 100-800-090 90°
 Laryngo-Pharyngoskop, autoklavierbar, Ø 10 mm,
 160 mm Arbeitslänge, 270mm Gesamtlänge
 Laryngo-Pharyngoscope, autoclavable, Ø 10 mm,
 6 1/4 inch working length, 10 2/3 inch overall length

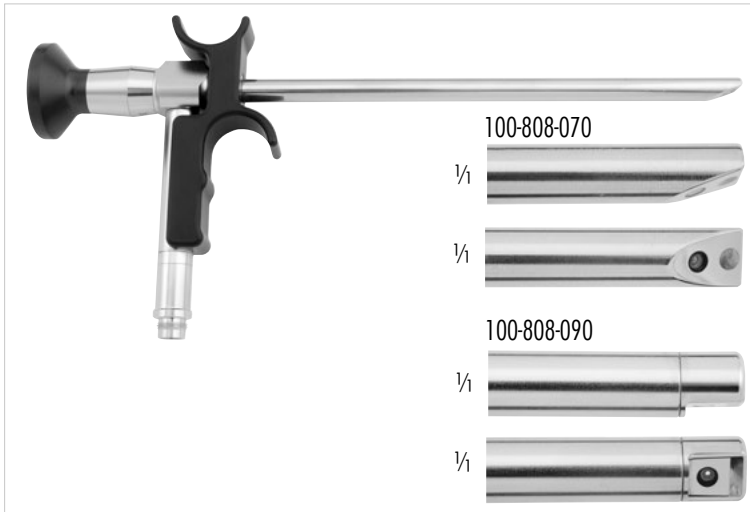

100-808-070 70°
 100-808-090 90°
 Laryngo-Pharyngoskop, autoklavierbar, Ø 8 mm, 190 mm
 Laryngo-Pharyngoscope, autoclavable, Ø 8 mm, 7 1/2 inch

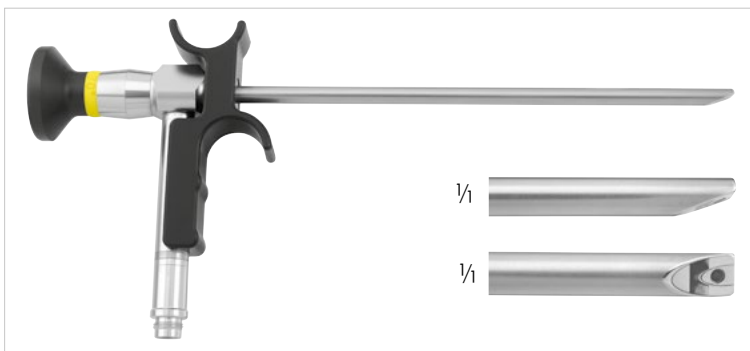

100-805-070 Ø 5 mm
 100-806-070 Ø 6 mm
 Zoom-Laryngo-Pharyngoskop, autoklavierbar, 70°, 190 mm
 Zoom-Laryngo-Pharyngoscope, autoclavable, 70°, 7 1/2 inch



- 250-025-230 Ø 2.5 mm, 2300 mm
- 250-025-300 Ø 2.5 mm, 3000 mm
- 250-035-180 Ø 3.5 mm, 1800 mm
- 250-035-230 Ø 3.5 mm, 2300 mm
- 250-035-300 Ø 3.5 mm, 3000 mm
- 250-048-180 Ø 4.8 mm, 1800 mm
- 250-048-230 Ø 4.8 mm, 2300 mm
- 250-048-300 Ø 4.8 mm, 3000 mm

RZ

Hochentwickeltes Xenon Lichtleiterkabel mit eingebautem Glasstab für hohe Temperaturwiderstandsfähigkeit
Advanced High Temperature Xenon Light cable with built-in glass rod

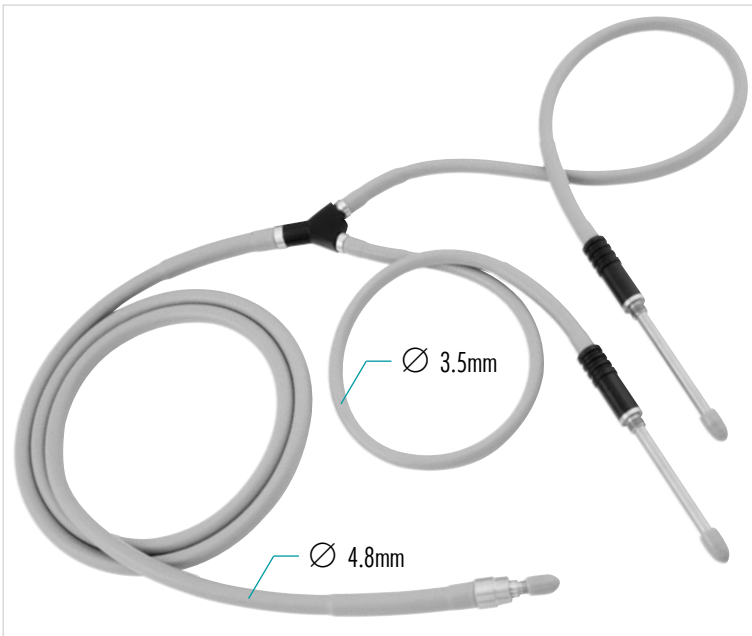

- 250-053-180 Ø 3.5 mm, 1800 mm
- 250-053-230 Ø 3.5 mm, 2300 mm

RZ

Kaltlichtleitkabel, mit 2 Lichteingängen und 1 Lichtausgang, ohne Adapter (Seite 30)
Cold light cable, with 2 light inputs and 1 light output, without adaptor pieces (page 30)

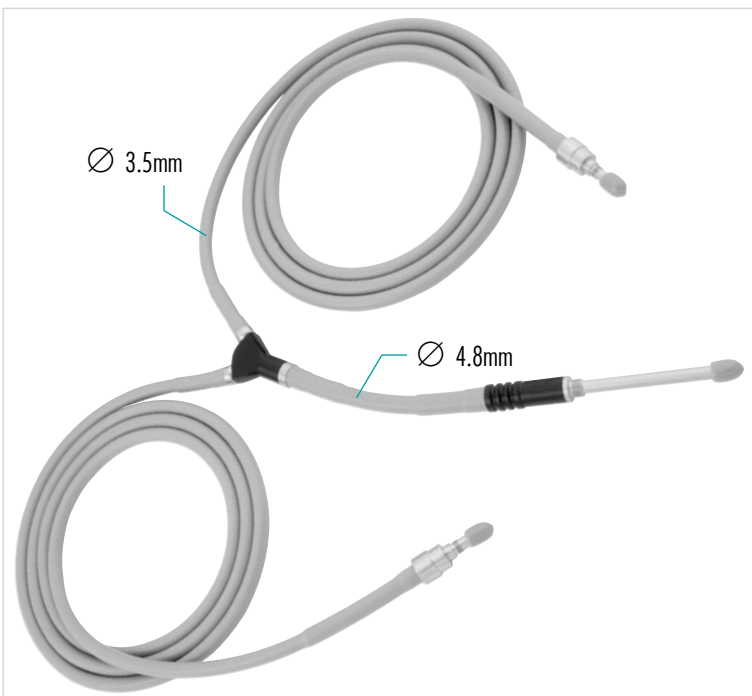

- 250-054-180 Ø 3.5 mm, 1800 mm
- 250-054-230 Ø 3.5 mm, 2300 mm

RZ

Kaltlichtleitkabel, mit 1 Lichteingang und 2 Lichtausgängen, ohne Adapter (Seite 30)
Cold light cable, with 1 light input and 2 light outputs, without adaptor pieces (page 30)



Adaptor pieces to use with **endoscope**



250-042-000
RZ/Storz/Olympus



250-040-000
Wolf



250-041-000
ACMI/British Standard

XENON/LED Light Guide Cables
with melt and bending protection

250-025-230 Ø 2.5 mm, 2300 mm

250-025-300 Ø 2.5 mm, 3000 mm

250-035-180 Ø 3.5 mm, 1800 mm

250-035-230 Ø 3.5 mm, 2300 mm

250-035-300 Ø 3.5 mm, 3000 mm

250-048-180 Ø 4.8 mm, 1800 mm

250-048-230 Ø 4.8 mm, 2300 mm

250-048-300 Ø 4.8 mm, 3000 mm

Adaptor pieces to use with **light source**



250-039-000
RZ/Storz



250-038-000
ACMI/CUDA



250-048-000
Luxtac



250-051-000
Stryker



250-037-000
Wolf



250-044-000
Olympus



250-045-000
Olympus - Standard



250-052-000
Heine



250-059-000
Pentax



COMPATIBILITY NOTE:

A fiber optic cable with a large diameter should not be connected to a smaller diameter scope.
For example: Ø 4.8mm fiber optic cables connected to a Ø 2.9mm may risk high temperature at the light entry of the endoscope and may risk patient safety.



Löffelzängchen, 2 mm und 4 mm, Standardmodell, konischer Rohrschaft, Arbeitslänge: 230 mm
Cupped forceps with round 2 mm and 4 mm cupped, jaws, conical tubular shaft, working length: 9 inch

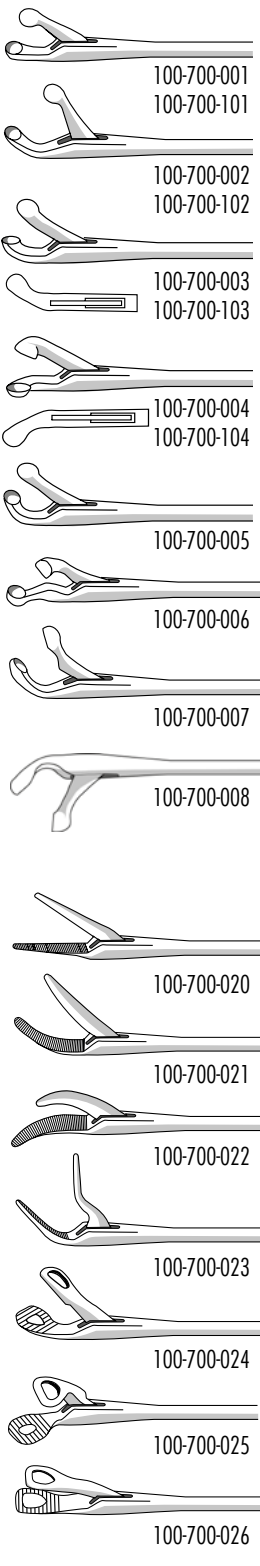

2 mm

- 100-700-001 gerade/straight
- 100-700-002 aufgebogen/curved upwards
- 100-700-003 rechts gebogen/curved right
- 100-700-004 links gebogen/curved left
- 100-700-005 rechts aufgebogen/curved upwards right
- 100-700-006 links aufgebogen/curved upwards left
- 100-700-007 horizontal, nach rechts öffnend/horizontal curved right opening
- 100-700-008 horizontal, nach links öffnend/horizontal curved left opening

4 mm

- 100-700-101 gerade, straight
- 100-700-102 aufgebogen/curved upwards
- 100-700-103 rechts gebogen/curved right
- 100-700-104 links gebogen/curved left

Faßzängchen, Standardmodell, konischer Rohrschaft 2 mm, Nutzlänge 230mm
Alligator forceps, standard model, conical tubular shaft 2 mm, working length 9 inch

- 100-700-020 gerieft, gerade/serrated, straight
- 100-700-021 nach rechts gebogen/curved right
- 100-700-022 nach links gebogen/curved left
- 100-700-023 aufgebogen/curved upwards
- 100-700-024 mit dreieckigem Maul, nach rechts aufgebogen/with triangular jaws, curved upwards right
- 100-700-025 mit dreieckigem Maul, nach links aufgebogen/with triangular jaws, curved upwards left
- 100-700-026 mit dreieckigem Maul, gerade/with triangular jaws, straight

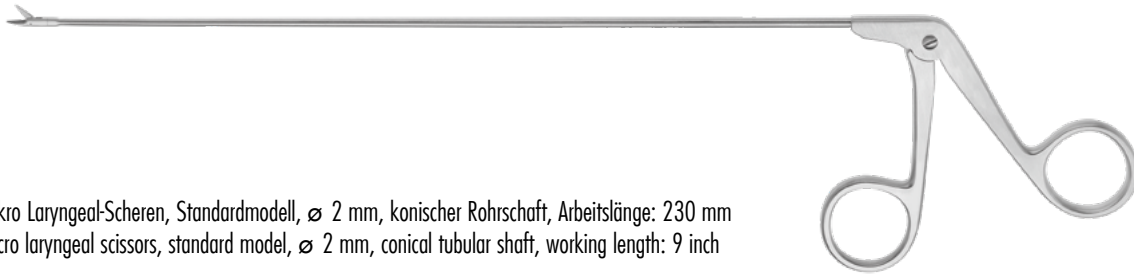

Mikro Laryngeal-Scheren, Standardmodell, \varnothing 2 mm, konischer Rohrschaft, Arbeitslänge: 230 mm
Micro laryngeal scissors, standard model, \varnothing 2 mm, conical tubular shaft, working length: 9 inch



100-700-050 gerade/straight



100-700-051 45° aufgebogen/upcurved

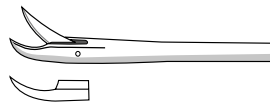

100-700-052 rechts gebogen/curved right

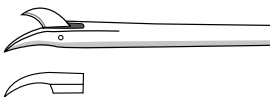

100-700-053 links gebogen/curved left



100-700-054 gerade, horizontal schneidend/straight, horizontal cutting

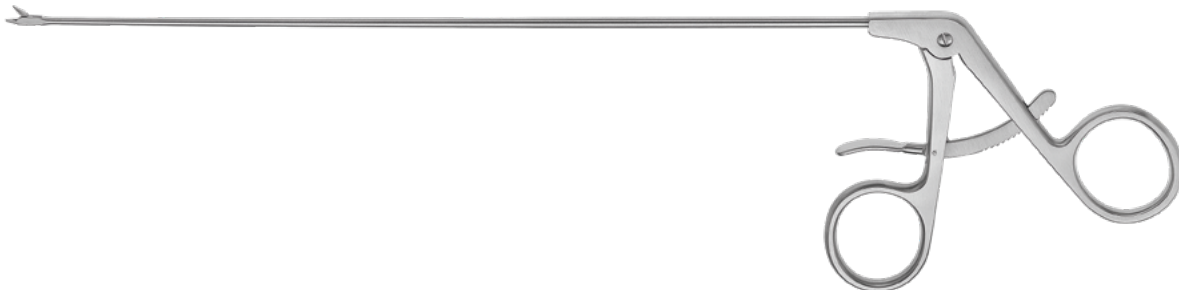

100-700-200 Nadelhalter mit Sperre, konischer Rohrschaft, Nutzlänge 230 mm
Needle holder with ratchet, conical tubular shaft, working length 9 inch

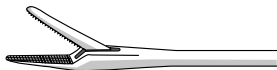

100-700-210 Nadelhalter mit Sperre, konischer Rohrschaft, mit diamantiertem Maulteil, Nutzlänge 230 mm
Needle holder with ratchet, conical tubular shaft, with diamond dusted jaw, working length 9 inch

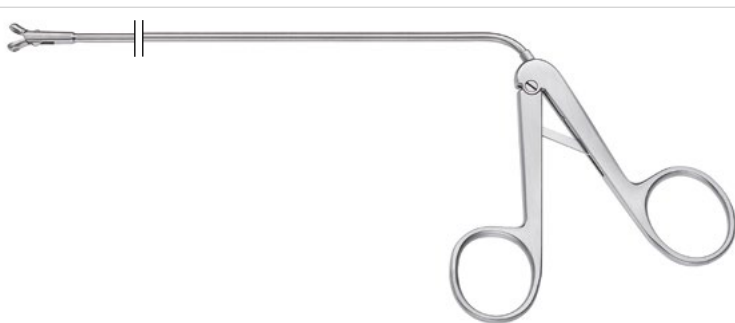

100-700-030

Laryngoskopie-Biopsiezange, schweres Modell, 5mm Löffelmaul,
gerade, doppelbeweglich, 230mm
Laryngoscopic-Biopsyforceps heavy, with round 5mm cupped jaws,
double action, 9 inch

100-704-230

Laryngoskopie-Biopsiezange, schweres Modell, 3x4mm Löffelmaul,
gerade, einfach beweglich, 230mm
Laryngoscopic-Biopsyforceps heavy, with 3x4mm cupped jaws,
single action, 9 inch



Löffelzängchen/Cupped Forceps



100-712-001 2 mm, gerade/straight

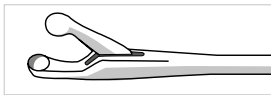

100-712-002 3 mm, gerade/straight



100-712-003 2 mm, aufgebogen/curved upwards

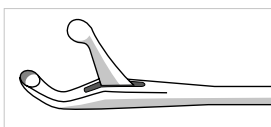

100-712-004 3 mm, aufgebogen/curved upwards

Alligator Zange, gerieft/Alligator Forceps, serrated

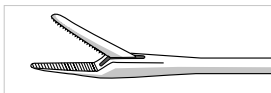

100-712-005 gerade/straight



100-712-013 aufgebogen/curved upwards

Schere/Scissors

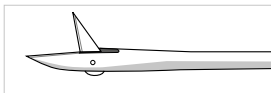

100-712-006 gerade/straight

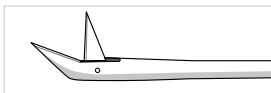

100-712-007 45° abgewinkelt/45° angled

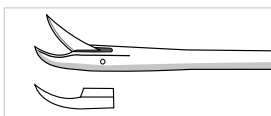

100-712-008 rechts gebogen/curved right

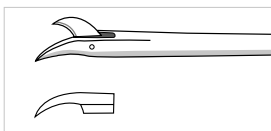

100-712-009 links gebogen/curved left

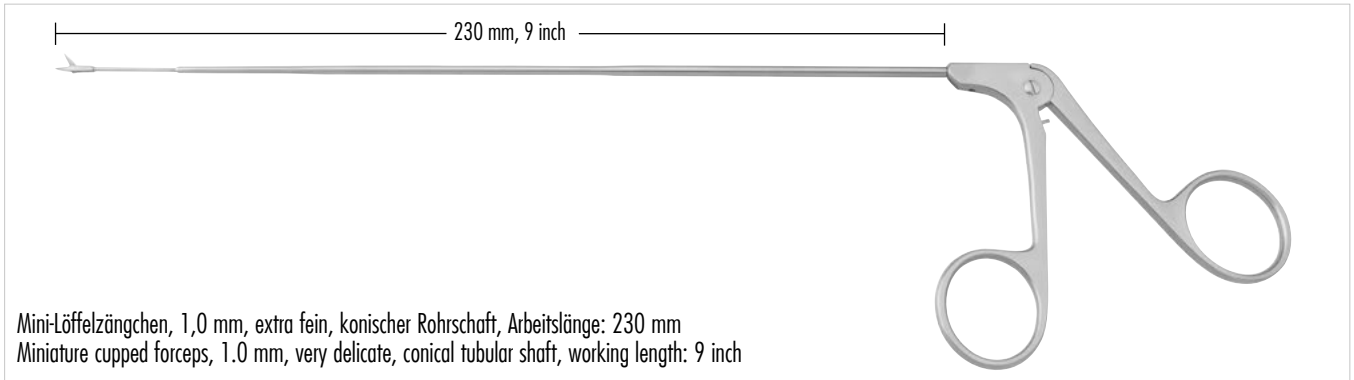

100-710-001 gerade/straight



100-710-002 aufgebogen/curved upwards



100-710-003 nach rechts gebogen/curved right

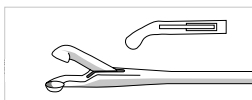

100-710-004 nach links gebogen/curved left

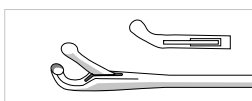

100-710-005 nach rechts aufgebogen/curved upwards right



100-710-006 nach links aufgebogen/curved upwards left

Mini-Faßzängchen, gerieft, extra fein, konischer Rohrschaft, Arbeitslänge: 230 mm
Miniature forceps, serrated, very delicate, conical tubular shaft, working length: 9 inch



100-710-020 gerade/straight



100-710-021 nach rechts gebogen/curved right

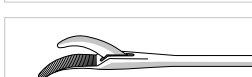

100-710-022 nach links gebogen/curved left



100-710-023 aufgebogen/curved upwards

Mini-Scherchen, extra fein, konischer Rohrschaft, Nutzlänge 230 mm
Miniature Scissors, very delicate, conical tubular shaft, working length 9 inch



100-710-050 gerade/straight

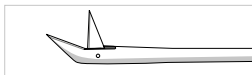

100-710-051 45° aufgebogen/angled 45°

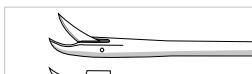

100-710-052 nach rechts gebogen/curved right



100-710-053 nach links gebogen/curved left

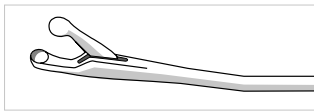
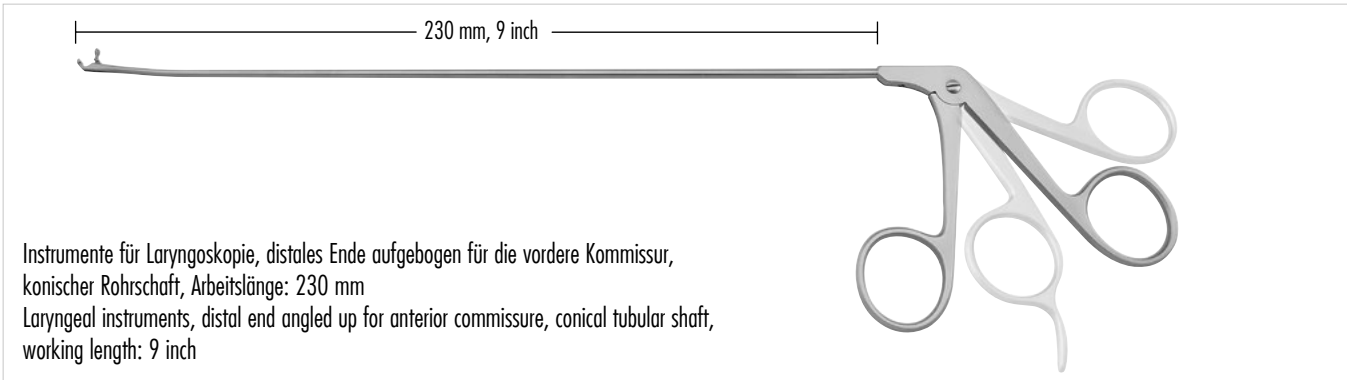

Löffelzängchen/cupped forceps, \varnothing 2.0 mm

100-715-001 gerade/straight
100-725-001 gerade, Daumenkontrolle/straight, thumb control

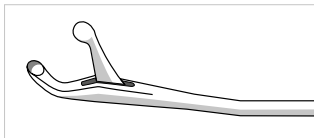

100-715-002 aufgebogen/curved upwards
100-725-002 aufgebogen, Daumenkontrolle/curved upwards, thumb control

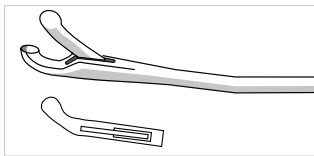

100-715-003 nach rechts gebogen/curved right
100-725-003 nach rechts gebogen, Daumenkontrolle/curved right, thumb control

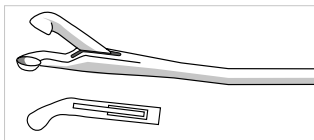

100-715-004 nach links gebogen/curved left
100-725-004 nach links gebogen, Daumenkontrolle/curved left, thumb control

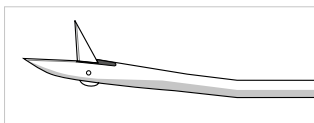

Schere/Scissors

100-715-005 gerade/straight
100-725-005 gerade, Daumenkontrolle/straight, thumb control

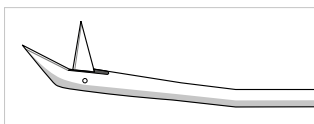

100-715-006 45° aufgebogen/45° angled upwards
100-725-006 45° aufgebogen, Daumenkontrolle/45° angled upwards, thumb control

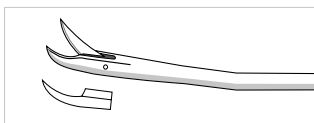

100-715-007 nach rechts gebogen/curved right
100-725-007 nach rechts gebogen, Daumenkontrolle/curved right, thumb control

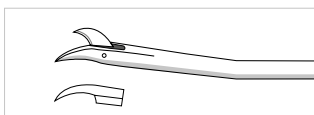

100-715-008 nach links gebogen/curved left
100-725-008 nach links gebogen, Daumenkontrolle/curved left, thumb control

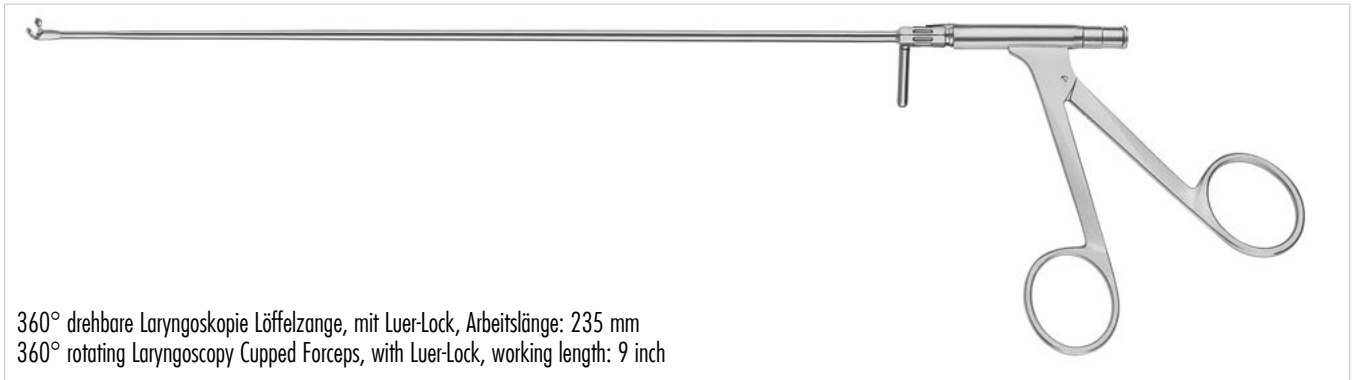

100-700-501 2mm
gerade/straight

100-700-511 1mm
gerade/straight



100-700-502 2mm
aufgebogen/curved upwards

100-700-512 1mm
aufgebogen/curved upwards

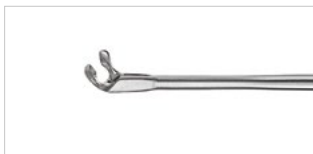

100-700-503 2mm
rechts gebogen/curved right

100-700-513 1mm
rechts gebogen/curved right



100-700-504 2mm
links gebogen/curved left

100-700-514 1mm
links gebogen/curved left

360° drehbare Laryngoskopie Fasszange, mit Luer-Lock, Arbeitslänge: 235 mm
360° rotating Laryngoscopy Grasping Forceps, with Luer-Lock, working length: 9 inch



100-700-520
gerade/straight



100-700-523
aufgebogen/curved upwards



100-700-521
rechts gebogen/curved right



100-700-524
aufgebogen/curved upwards



100-700-522
links gebogen/curved left

360° drehbare Laryngoskopie Schere, mit Luer-Lock, Arbeitslänge: 235 mm
360° rotating Laryngoscopy Scissors, with Luer-Lock, working length: 9 inch



100-700-550
gerade/straight



100-700-551
aufgebogen/curved upwards



100-700-552
rechts gebogen/curved right



100-700-553
links gebogen/curved left

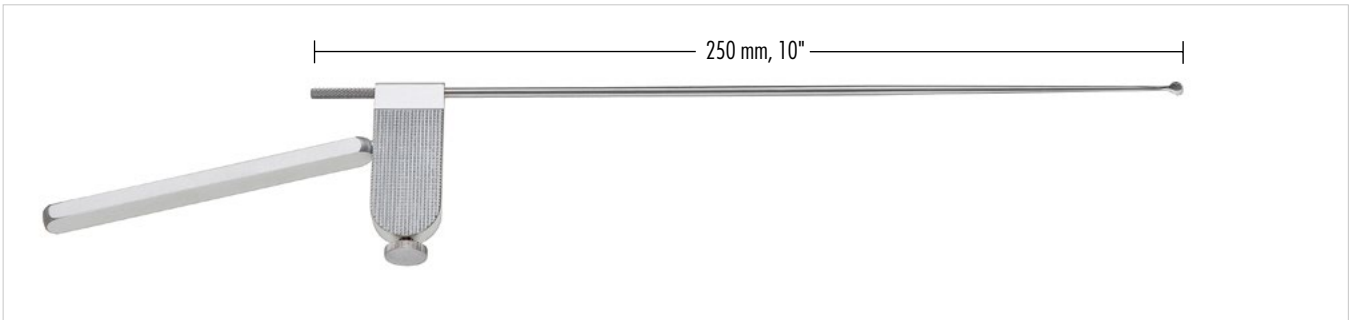

100-850-001 - 100-850-012

Instrumente zur endolaryngealen Mikrochirurgie, Gesamtlänge: 250 mm

Laryngeal Instruments for Microsurgery, total length: 10"



100-850-000
Handgriff, alleine
Handle, only



100-850-001 Messer, rund, \varnothing 2,5 mm, 45° abgewinkelt
Knife, round, \varnothing 2.5 mm, 45° angled



100-850-002 Messer, rund, vertikal schneidend
Knife, round, vertical cutting



100-850-003 Messer, oval, gerade
Knife, oval, straight



100-850-004 Messer, sichelförmig
Knife, sickle shaped



100-850-005 Messer, golfstockförmig
Knife, golfstick shaped



100-850-006 Häkchen, stumpf, mit Sondenknopf
Hook, blunt, with probe end



100-850-007 Häkchen, scharf
Hook, sharp



100-850-008 Unterbindungsnaedel, nach rechts gebogen
Ligature Needle, curved to right



100-850-009 Unterbindungsnaedel, nach links gebogen
Ligature Needle, curved to left



100-850-010 Saugellevator
Elevator with suction channel



100-850-011 Knotenführer
Knot guide



100-850-012 Häkchen, 90°, mit Sondenknopf
Hook with probe end, 90° angled

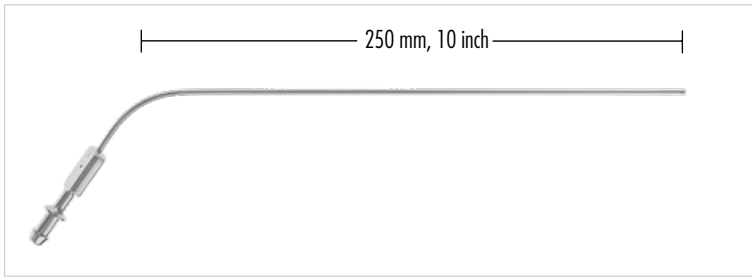

100-860-020 ø 2.0 mm
 100-860-025 ø 2.5 mm
 100-860-030 ø 3.0 mm
 Saugrohr, Arbeitslänge: 250 mm
 Suction tube, working length: 10 inch

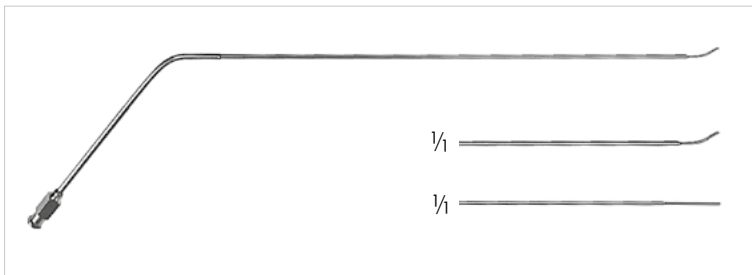

100-861-001 gebogene Spitze/curved tip
 100-861-002 gerade Spitze/straight tip
 Injektionsnadel, mit Luer-Lock
 Injection needle, with Luer-Lock

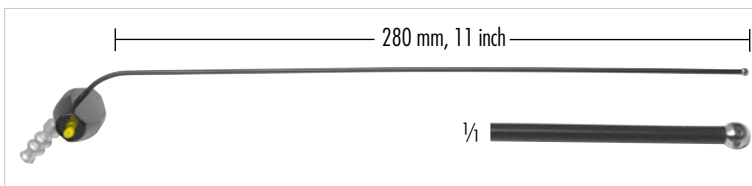

100-862-030 2,5 mm, 280 mm, 11 inch
 100-864-030 5,0 mm, 270 mm, 10 1/2 inch
 Saug- und Koagulationsrohr, **isoliert**, mit monopolarem Anschluß, abgewinkelt
 Insulated cannula for suction and coagulation, **insulated**, with monopolar connection, angled



100-870-000 Fig. 0, für Kinder/ for children
 100-870-001 Fig. 1
 100-870-002 Fig. 2
 100-870-003 Fig. 3
 Zahnschutz aus Metall
 Teeth protector, metal



100-870-100
 Zahnschutz aus Silikon, autoklavierbar
 Teeth protector, silicone, autoclavable

BIPOLAR CABLES



2-banana-pin *



Erbe



Martin, Berchtold,
Aesculap GK55 + sGK60



Valleylab, Lamidey, EMC



3m	700-350-030	700-101-001	700-287-030	700-351-031
5m	700-350-050	700-101-000	700-287-050	700-351-051

3m	700-350-130	700-101-130	700-287-130	700-351-131
5m	700-350-150	700-101-150	700-287-150	700-351-151

MONOPOLAR CABLES



1 banana pin 4mm



Martin, Berchtold,
Aesculap GK55 + sGK60



Erbe



Valleylab, Lamidey,
EMC



RZ HF Unit
Standard Plug



round-plug 4mm (instrument side)

3m	700-280-030	700-285-030	700-101-030	700-360-031	700-501-303
5m	700-280-050	700-285-050	700-101-050	700-360-051	700-501-503

* Innerhalb Europas nicht mit CE-Markierung erhältlich
Not available with CE marking within Europe

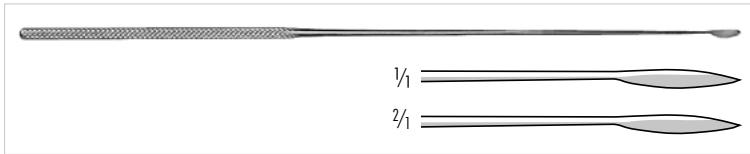

100-853-295

JAKO-TYPE

Laryngeal Messer, gerades Blatt, Klingenlänge: 8 mm, 295 mm
 Laryngeal knife, straight blade, blade length: 8 mm, 11 3/4 inch

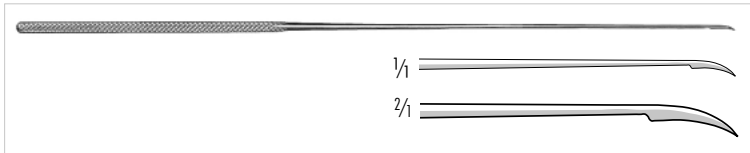

100-854-295

JAKO-TYPE

Laryngeal Sichelmesser, Klingenlänge: 8 mm, 295 mm
 Laryngeal sickle knife, blade length: 8 mm, 11 3/4 inch

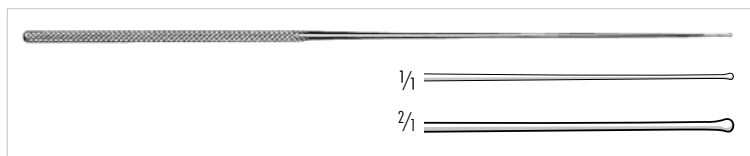

100-855-300

JAKO-TYPE

Laryngeal Sonde, gerade, Arbeitslänge: 220 mm, 295 mm
 Laryngeal probe, straight, working length: 8 1/2 inch, 11 3/4 inch

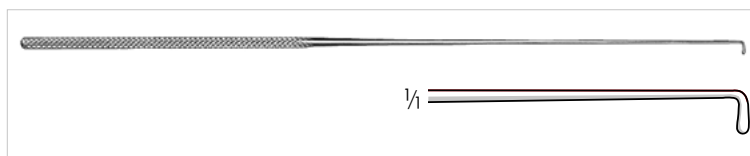

100-856-300

JAKO-TYPE

Laryngeal Sonde, 90° abgewinkelt, Arbeitslänge: 220 mm, 295 mm
 Laryngeal probe, 90° angled, working length: 8 1/2 inch, 11 3/4 inch

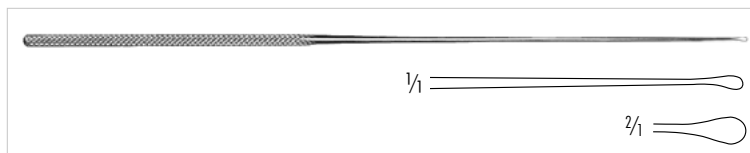

100-857-300

JAKO-TYPE

Mikro Dissektor, stumpf, 4 mm breit, Gesamtlänge: 295 mm
 Micro dissector, blunt, 4 mm wide, 11 3/4 inch



100-860-300

JAKO-TYPE

Mikro Laryngeal Haken mit Daumengriff, 90° abgewinkelt, 4 mm lang, 295 mm
 Micro laryngeal probe with thumbhandle, 90° angled, 4 mm long, 11 3/4 inch



BRONCHOSCOPY

Instruments and
Equipment for
Bronchoscopy

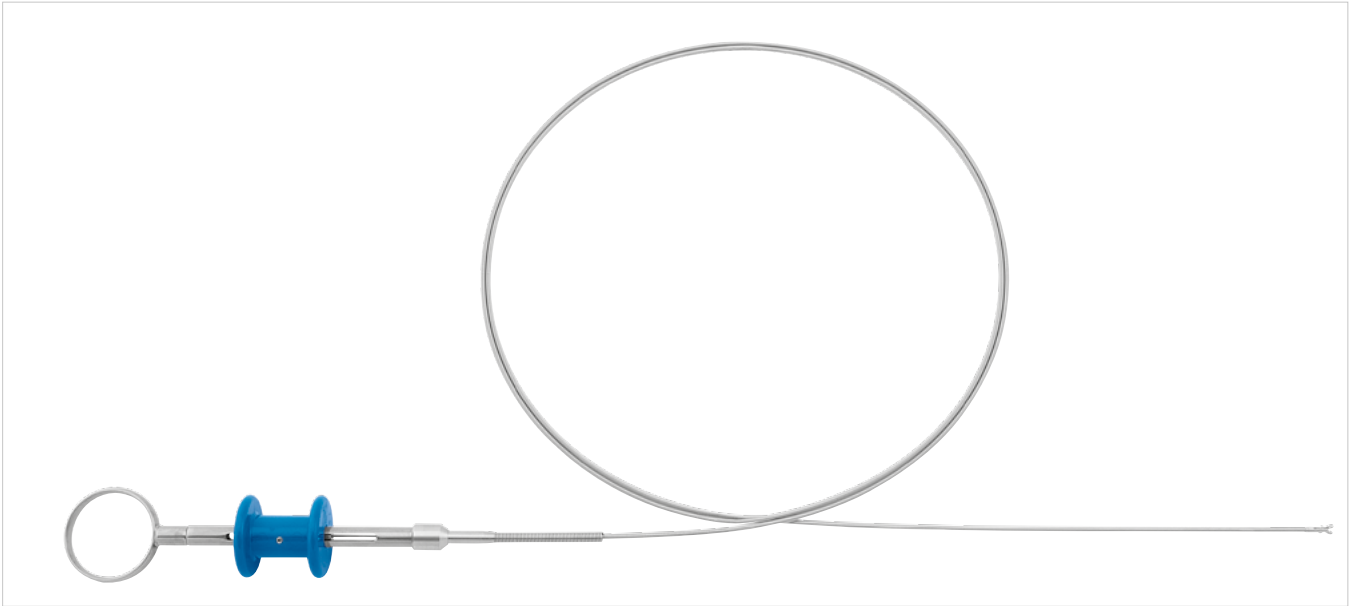

100-518-090 - 100-723-090

Flexible Biopsie- und Faßzangen, für flexible Endoskope, doppelbewegliche Maulteile, voll sterilisierbar

Flexible Biopsy- and Grasping forceps, for flexible Endoscopes, double-action jaws, totally autoclavable

Biopsiezange, runder Löffel/Biopsy forceps, round cup

Biopsiezange, ovaler Löffel/Biopsy forceps, oval cup

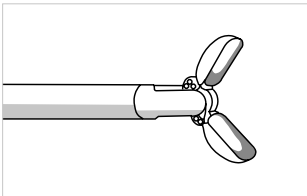

- 100-601-075 750 mm, 1,0 mm \varnothing
- 100-618-090 900 mm, 1,8 mm \varnothing
- 100-623-090 900 mm, 2,3 mm \varnothing
- 100-618-120 1200 mm, 1,8 mm \varnothing
- 100-623-120 1200 mm, 2,3 mm \varnothing

Faßzange mit Hechtm Maul/Alligator grasping forceps

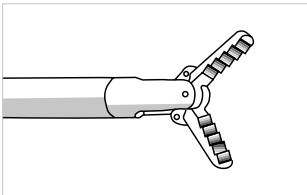

- 100-701-075 750 mm, 1,0 mm \varnothing
- 100-718-090 900 mm, 1,8 mm \varnothing
- 100-723-090 900 mm, 2,3 mm \varnothing
- 100-718-120 1200 mm, 1,8 mm \varnothing
- 100-723-120 1200 mm, 2,3 mm \varnothing

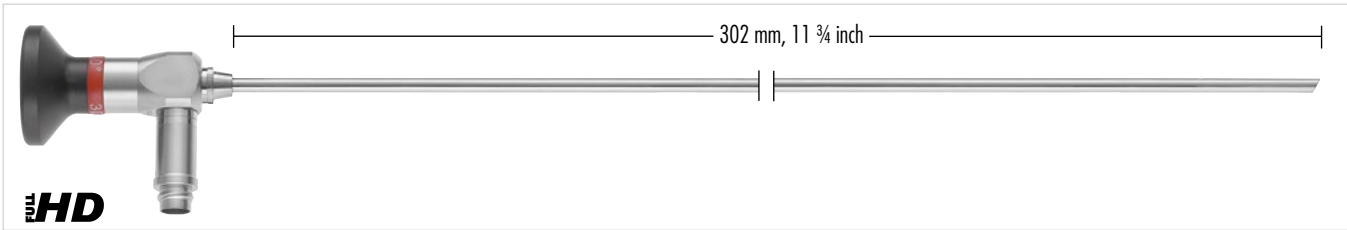

100-604-000

Bronchoskop, starr, 0°, ø 4 mm, autoklavierbar, Nutzlänge 302 mm
Bronchoscope, rigid, 0°, ø 4 mm, autoclavable, working length 11 ¾ inch

100-604-030

Bronchoskop, starr, 30°, 4 mm ø, autoklavierbar, Nutzlänge 302 mm
Bronchoscope, rigid, 30°, 4 mm ø, autoclavable, working length 11 ¾ inch

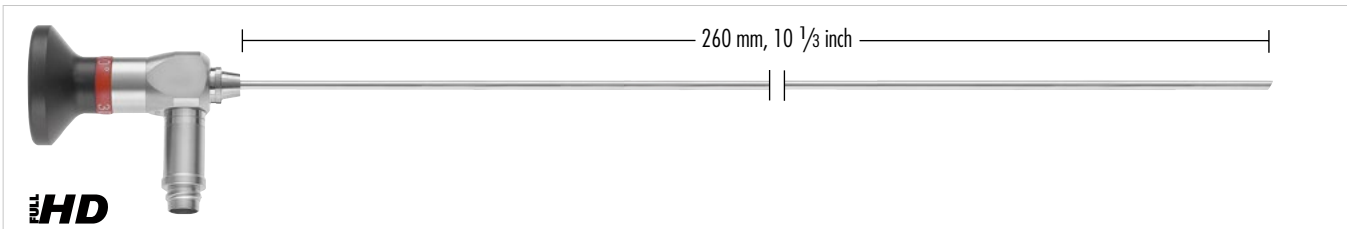

100-627-000

Bronchoskop, starr, 0°, ø 2,7 mm, autoklavierbar, Nutzlänge 260 mm
Bronchoscope, rigid, 0°, ø 2.7 mm, autoclavable, working length 10 ⅓ inch

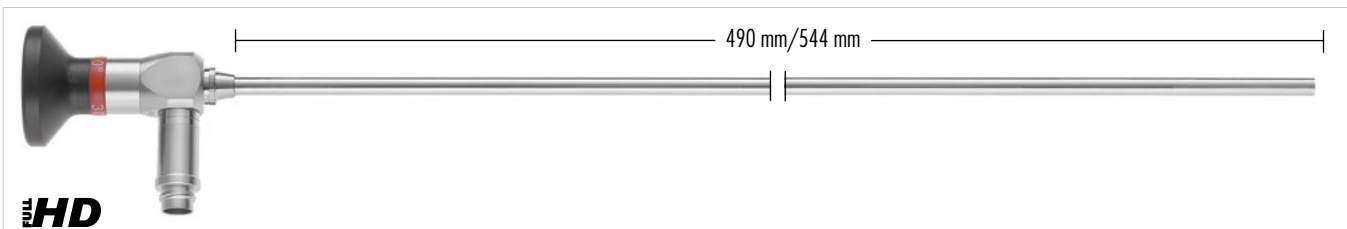

100-655-000 Nutzlänge 490 mm/working length 19 ⅓ inch

100-655-100 Nutzlänge 544 mm/working length 21 ⅓ inch

Bronchoskop, starr, 0°, ø 5,5 mm, autoklavierbar
Bronchoscope, rigid, 0°, ø 5.5 mm, autoclavable

100-655-030 Nutzlänge 490 mm/working length 19 ⅓ inch

100-655-130 Nutzlänge 544 mm/working length 21 ⅓ inch

Bronchoskop, starr, 30°, ø 5,5 mm, autoklavierbar
Bronchoscope, rigid, 30°, ø 5.5 mm, autoclavable



100-610-001	Erwachsene/adult 400 mm/15 3/4 inch	Ø 10 mm
100-610-002	Erwachsene, klein/adult, small 400 mm/15 3/4 inch	Ø 9.0 mm
100-610-003	Jugendliche/adolescent 400 mm/15 3/4 inch	Ø 8.0 mm
100-610-006	Kinder/children 300 mm/11 3/4 inch	Ø 7.0 mm
100-610-007	Kinder/children 300 mm/11 3/4 inch	Ø 6.5 mm
100-610-008	Kleinkinder/little children 275 mm/10 3/4 inch	Ø 5.4 mm
100-610-009	Säugling/Baby 275 mm/10 3/4 inch	Ø 4.1 mm
100-610-013	Säugling, Baby 275 mm/10 3/4 inch	Ø 3.7 mm
100-610-014	Säugling, Baby 180 mm/7 inch	Ø 3.7 mm

NEGUS

Bronchoskop, rostfreier Stahl
Bronchoscope, stainless steel



100-610-025

NEGUS

Kaltlichtträger für Bronchoskope, 400 mm
Fibre optic light carrier for bronchoscope, 15 3/4 inch



100-610-026

NEGUS

Kaltlichtträger für Bronchoskope, 300 mm
Fibre optic light carrier for bronchoscope, 12 inch

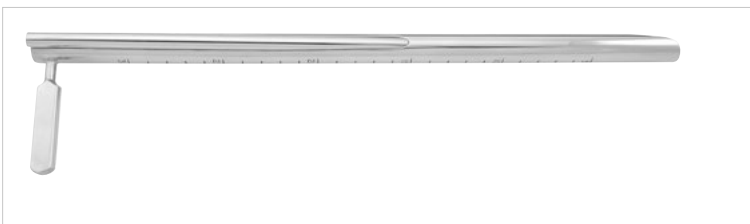

100-610-012	8.0 x 10 mm, 350 mm/13 3/4 inch
100-610-019	8.0 x 10 mm, 250 mm/10 inch
100-610-023	9.6 x 11.6 mm, 350 mm/13 3/4 inch
100-610-024	9.6 x 11.6 mm, 250 mm/10 inch

NEGUS

Oesophagoskop, Kinder, rostfreier Stahl
Oesophagoscope, children, stainless steel

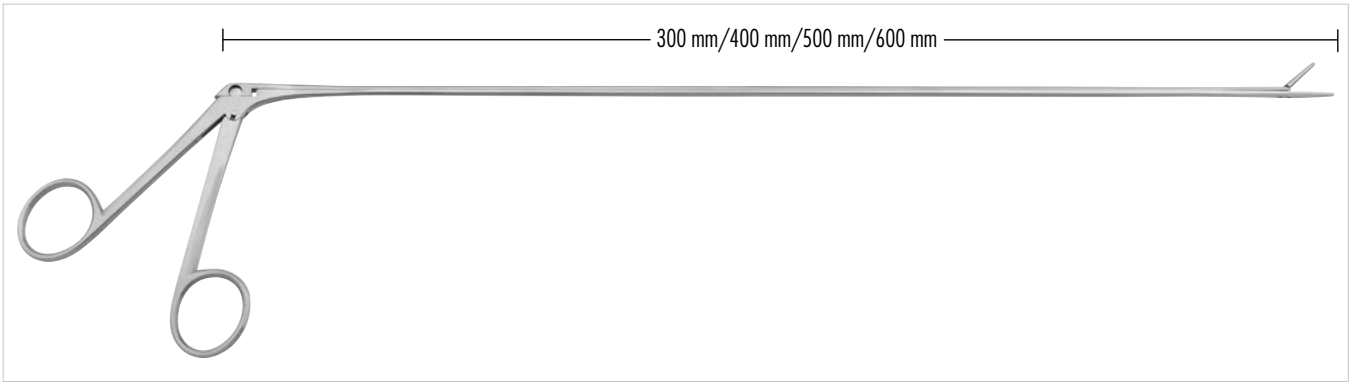

JACKSON





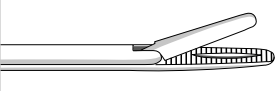
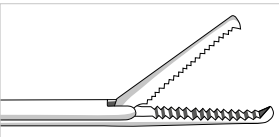
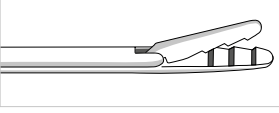
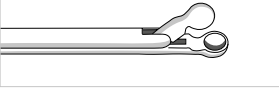
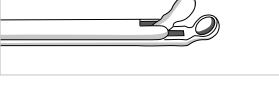
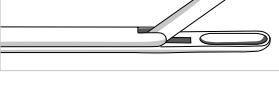
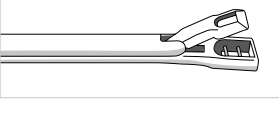
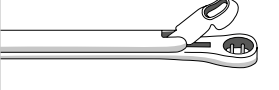

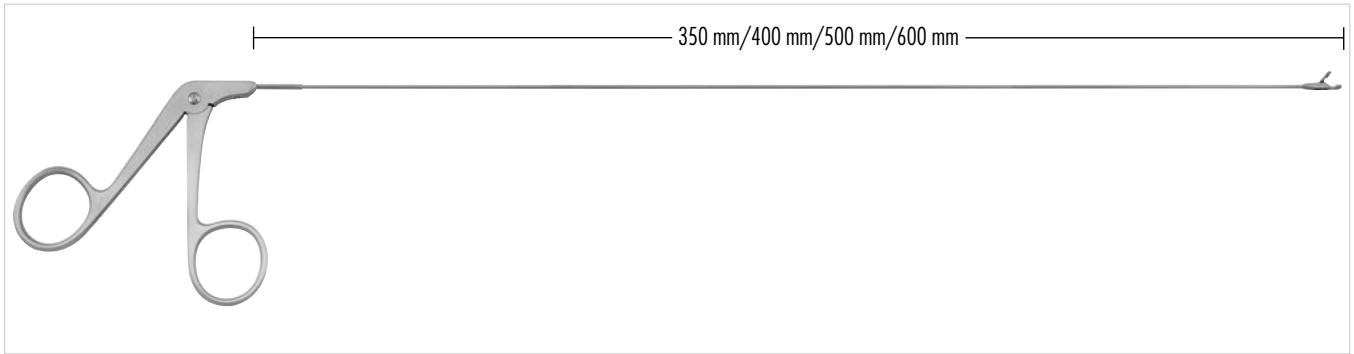



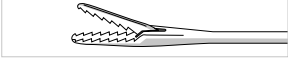

Broncho-Oesophagoskopie-Zangen und Biopsiezangen mit **Schieberschaft**, obere Maulteile beweglich
 Broncho-oesophagoscopic forceps and Biopsy forceps with **sliding-shaft**, upper jaws moveable

Schaftlänge/shaft-length

		300 mm/12 inch	400 mm/15 ¾ inch	500 mm/19 ½ inch	600 mm/23 ½ inch
	gerieft/ serrated	100-750-301	100-750-401	100-750-501	100-750-601
	1x2 Zähne 1x2 teeth	100-750-302	100-750-402	100-750-502	100-750-602
	Alligator Zähne Alligator teeth	100-750-303	100-750-403	100-750-503	100-750-603
	Löffelmaul gerade Cupped jaws, straight	∅ 2 mm 100-750-304 ∅ 4 mm 100-750-305	100-750-404 100-750-405	100-750-504 100-750-505	100-750-604 100-750-605
	Löffelmaul aufgebogen Cupped jaws, upcurved	∅ 2 mm 100-750-306 ∅ 4 mm 100-750-307	100-750-406 100-750-407	100-750-506 100-750-507	100-750-606 100-750-607
	Löffelmaul, länglich, gerade Löffelmaul, oblong, straight	100-750-308	100-750-408	100-750-508	100-750-608
	Stanzenmaul, eckig Punch jaw, angular	100-750-309	100-750-409	100-750-509	100-750-609
	Stanzenmaul, rund Punch jaw, round	100-750-310	100-750-410	100-750-510	100-750-610







Laryngo-Broncho-Oesophagoskopiezangen, mit **Rohrschaft**
Broncho-Oesophagoscopic forceps, with **tubular shaft**

	Schafflänge/shaft-length	Schaffstärke/shaft ø 2.5 mm			Kinder/children ø 1.5 mm
		400 mm/15 ¾ inch	500 mm/19 ½ inch	600 mm/23 ½ inch	350 mm/13 ¾ inch
	Stanzmaul/Punch jaw	100-720-401	100-720-501	100-720-601	100-720-301
	Fasszange, gerieft Grasping Forceps, serrated	100-720-402	100-720-502	100-720-602	100-720-302
	Fasszange, gerieft, gefenestert Grasping Forceps, serrated, fenestrated	100-720-403	100-720-503	100-720-603	100-720-303
	Alligator Zähne Alligator teeth	100-720-404	100-720-504	100-720-604	100-720-304
	Löffelmaul, gerade Cupped Forceps, straight	100-720-405	100-720-505	100-720-605	100-720-305
	Löffelmaul, horizontal aufgebogen Cupped Forceps, horizontal upcurved	100-720-406	100-720-506	100-720-606	100-720-306
	Löffelmaul, vertikal aufgebogen Cupped Forceps, vertical upcurved	100-720-407	100-720-507	100-720-607	100-720-307
	Löffelmaul, rechts gebogen Cupped Forceps, right curved	100-720-408	100-720-508	100-720-608	100-720-308
	Löffelmaul, links gebogen Cupped Forceps, left curved	100-720-409	100-720-509	100-720-609	100-720-309
	Löffelmaul, länglich, gerade Cupped Forceps, oblong, straight	100-720-410	100-720-510	100-720-610	
	Löffelmaul, oval, gerade Cupped Forceps, oval, straight	100-720-411	100-720-511	100-720-611	
	Löffelmaul, oval, gerade Cupped Forceps, oval, straight	100-720-412	100-720-512	100-720-612	100-720-312
	Löffelmaul, oval, gezahnt gerade Cupped Forceps, oval, serrated, straight	100-720-413	100-720-513	100-720-613	100-720-313

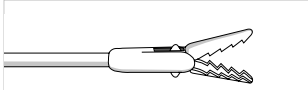
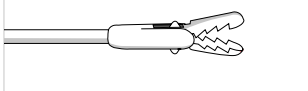
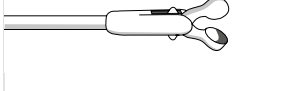
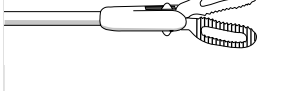
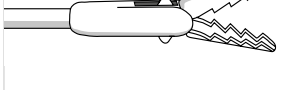

100-720-001 - 100-720-034

Bronchoskopiezangen, **Rohrschaft**, beide Maulteile beweglich
 Bronchoscopy forceps, **tubular shaft**, double-action jaws

	Schaft Ø/shaft Ø		Schaftlänge/shaft-length	
	250 mm/10 inch	350 mm/13 ¾ inch	500 mm/19 ¾ inch	
 <p>Fremdkörperzange mit Hechtmaul Foreign body Forceps alligator jaws</p>	2,0 mm	100-720-001	100-720-011	—
 <p>Universal Biopsie- und Faßzange Universal biopsy and grasping forceps</p>	2,0 mm	100-720-002	100-720-012	—
 <p>Löffelzange, rund, gerade Biopsy cup forceps, straight, round cup</p>	2,0 mm	100-720-003	100-720-013	—
 <p>Faßzange mit gefenestertem Maul Grasping forceps with fenestrated jaws</p>	2,0 mm	100-720-004	100-720-014	—
 <p>Fremdkörperzange mit Hechtmaul Foreign body Forceps alligator jaws</p>	2,5 mm	—	100-720-021	100-720-031
 <p>Universal Biopsie- und Faßzange Universal biopsy and grasping forceps</p>	2,5 mm	—	100-720-022	100-720-032
 <p>Löffelzange, rund, gerade Biopsy cup forceps, straight, round cup</p>	2,5 mm	—	100-720-023	100-720-033
 <p>Faßzange mit gefenestertem Maul Grasping forceps with fenestrated jaws</p>	2,5 mm	—	100-720-024	100-720-034

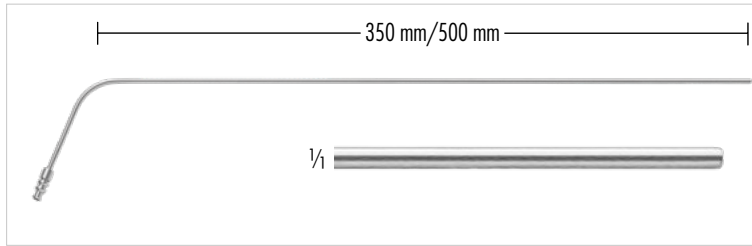

100-850-350 350mm/13 3/4 inch
 100-850-500 500mm/19 3/4 inch
 Saugrohr
 Rigid suction tube

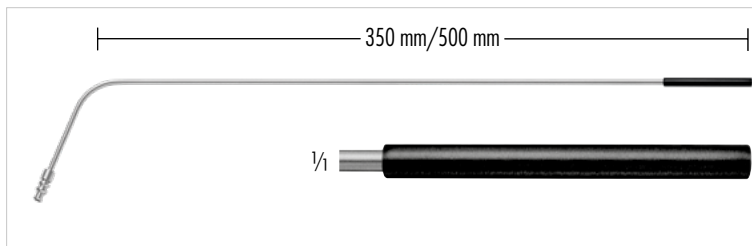

100-852-350
 Saugrohr, mit flexibler Gummispitze, 350 mm lang
 Rigid suction tube, with flexible rubber tip, 13 3/4 inch long

100-852-500
 Saugrohr, mit flexibler Gummispitze, 500 mm lang
 Rigid suction tube, with flexible rubber tip, 19 3/4 inch long

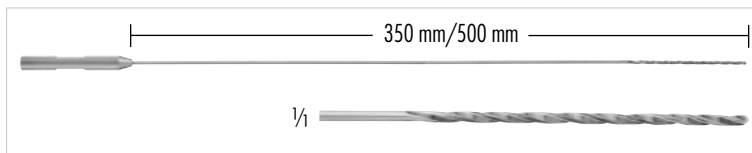

100-854-350
 Watteträger, Nutzlänge 350 mm
 Cotton carrier, working length 13 3/4 inch

100-854-500
 Watteträger, Nutzlänge 500 mm
 Cotton carrier, working length 19 3/4 inch

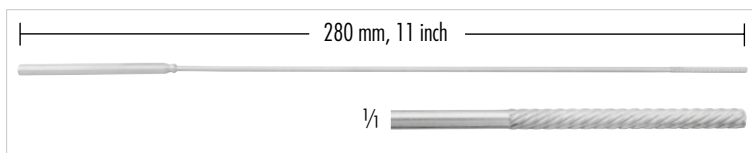

100-864-280
 Watteträger, spiralförmig gerieft, ø 2,5 mm, Länge 280 mm
 Cotton applicator, twist end serrated, ø 2.5 mm, length 11 inch

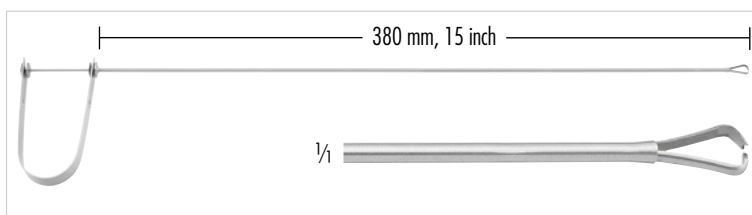

100-856-380
 Tupferhalter, 1 x 2 Zähne, Arbeitslänge: 380 mm
 Sponge holder, 1 x 2 treeth, working length: 15 inch

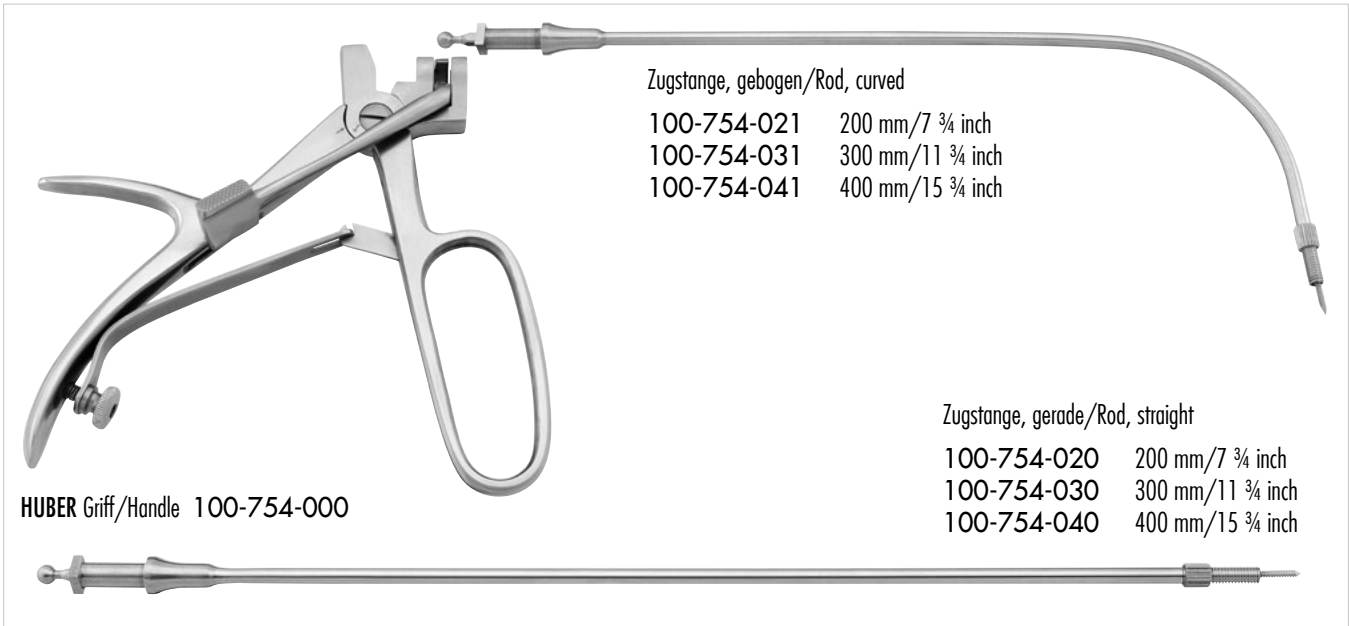

HUBER Griff/Handle 100-754-000

Zugstange, gebogen/Rod, curved

- 100-754-021 200 mm/7 ¾ inch
- 100-754-031 300 mm/11 ¾ inch
- 100-754-041 400 mm/15 ¾ inch

Zugstange, gerade/Rod, straight

- 100-754-020 200 mm/7 ¾ inch
- 100-754-030 300 mm/11 ¾ inch
- 100-754-040 400 mm/15 ¾ inch

Aufsätze/Jaw tip



BARICANI
100-754-016 Faßzange/Grasping Forceps



LANGE Löffelzange/Cupped Forceps
100-754-009 Size 1
100-754-018 Size 2
100-754-005 Size 3



100-754-003 Faßzange mit Alligator Zähnen
Grasping Forceps with alligator teeth



FRAENKEL
100-754-017 Löffelzange, länglicher Löffel
Cupped Forceps, long cups



BRUENINGS Löffelzange, rund
Cupped Forceps, round
100-754-014 Size 1
100-754-004 Size 2
100-754-024 Size 3



SCHEINMANN
100-754-019 Löffelzange, abgewinkelt
Cupped Forceps, angled



KRAUSE Biopsie Stanze, oval, durchschneidend
Biopsy punch, oval, through cutting
100-754-008 Size 1
100-754-026 Size 2
100-754-027 eckig/angular, Size 1
100-754-007 eckig/angular, Size 2



SCHUHMACHER
100-754-028 Biopsie Stanze, dreieckig,
mit ziehendem Schnitt
Biopsy punch, triangular,
with pull cutting



CORDES Stanze/Punch
100-754-029 rund/round
100-754-032 eckig/angular

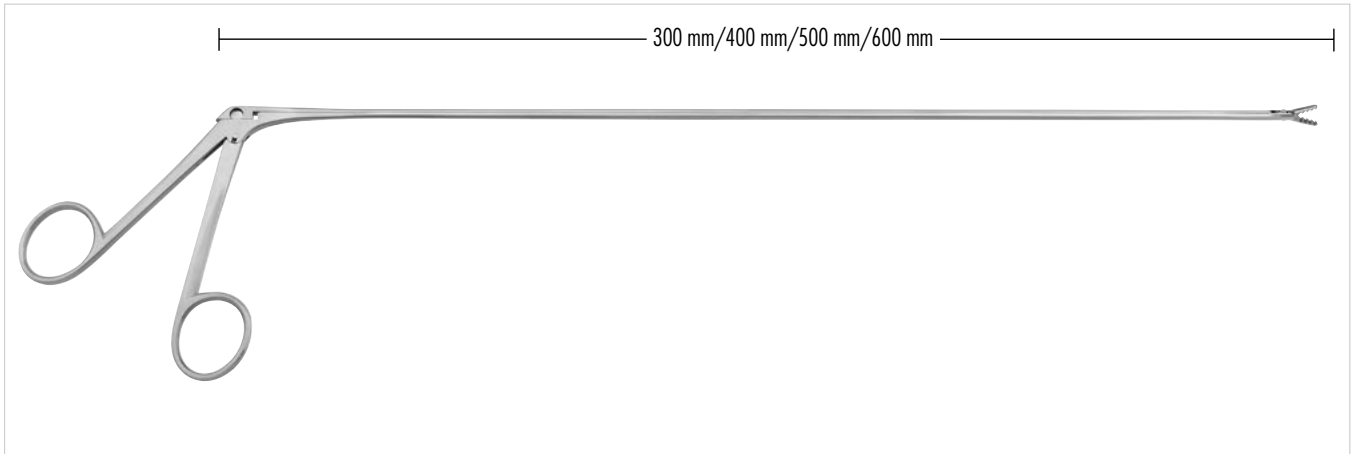

CHEVALIER-JACKSON

Bronchoskopie Zangen, Schieberschaft, doppelbewegliche Maulteile
 Bronchoscopy forceps, sliding-shaft, double-moving jaws

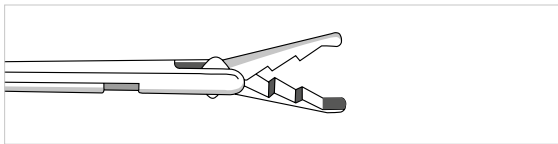

Hechtmaul/Alligator jaw

Länge/Length

100-755-305

300 mm/11 3/4 inch

100-755-405

400 mm/15 3/4 inch

100-755-505

500 mm/19 3/4 inch

100-755-605

600 mm/23 2/3 inch

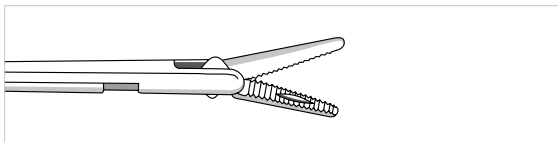

Faßzange, gerieftes Maul/Grasping forceps, serrated jaw

100-755-304

300 mm/11 3/4 inch

100-755-404

400 mm/15 3/4 inch

100-755-504

500 mm/19 3/4 inch

100-755-604

600 mm/23 2/3 inch

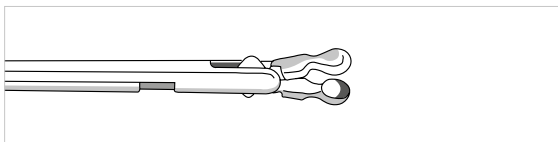

Löffelzange/Cupped forceps

100-755-310

300 mm/11 3/4 inch

100-755-410

400 mm/15 3/4 inch

100-755-510

500 mm/19 3/4 inch

100-755-610

600 mm/23 2/3 inch



Optische Bronchoskopie Zangen für Bronchoskope 8,5 - 7,5mm
Optical Bronchoscopy forceps for Bronchoscopes 8.5 - 7.5mm



100-655-100 Nutzlänge 540 mm/working length 21 1/3 inch
Bronchoskop, starr, 0°, ø 5,5 mm, autoklavierbar
Bronchoscope, rigid, 0°, ø 5.5 mm, autoclavable

100-655-130 Nutzlänge 540 mm/working length 21 1/3 inch
Bronchoskop, starr, 30°, ø 5,5 mm, autoklavierbar
Bronchoscope, rigid, 30°, ø 5.5 mm, autoclavable



100-900-223 Mini Probeexcisionszange, ovaler Löffel 2,3mm
Mini Biopsy Cut Forceps, oval Spoon 2.3mm



100-900-225 Schere, doppelbeweglich
Scissors, double action



100-900-228 Fasszange
Grasping Forceps

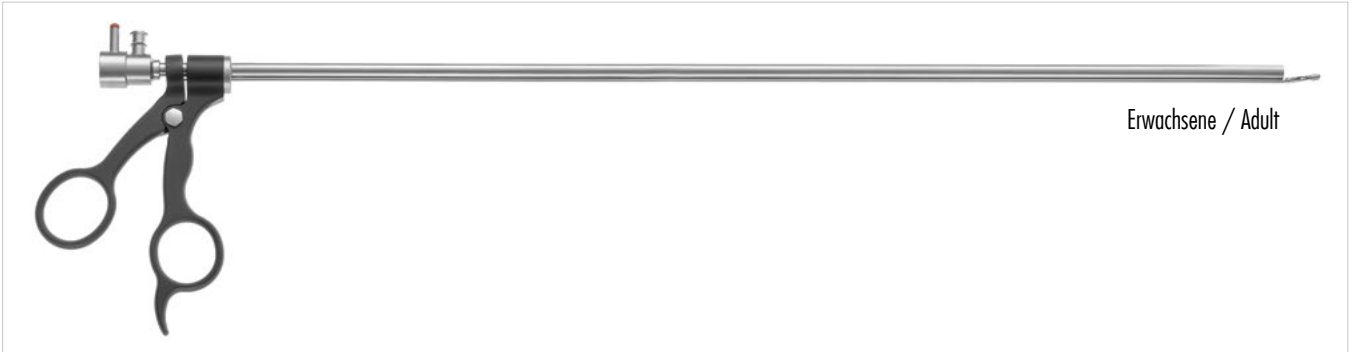

Optische Bronchoskopie Zangen für Bronchoskope 8,5 - 7,5mm
Optical Bronchoscopy forceps for Bronchoscopes 8.5 - 7.5mm



100-655-000 Nutzlänge 490 mm/working length 19 1/3 inch
Bronchoskop, starr, 0°, ø 5,5 mm, autoklavierbar
Bronchoscope, rigid, 0°, ø 5.5 mm, autoclavable

100-655-030 Nutzlänge 490 mm/working length 19 1/3 inch
Bronchoskop, starr, 30°, ø 5,5 mm, autoklavierbar
Bronchoscope, rigid, 30°, ø 5.5 mm, autoclavable



100-900-203 Mini Probeexcisionszange, ovaler Löffel 2,3mm
Mini Biopsy Cut Forceps, oval Spoon 2.3mm



100-900-207 Fremdkörperzange
Foreignbody Forceps

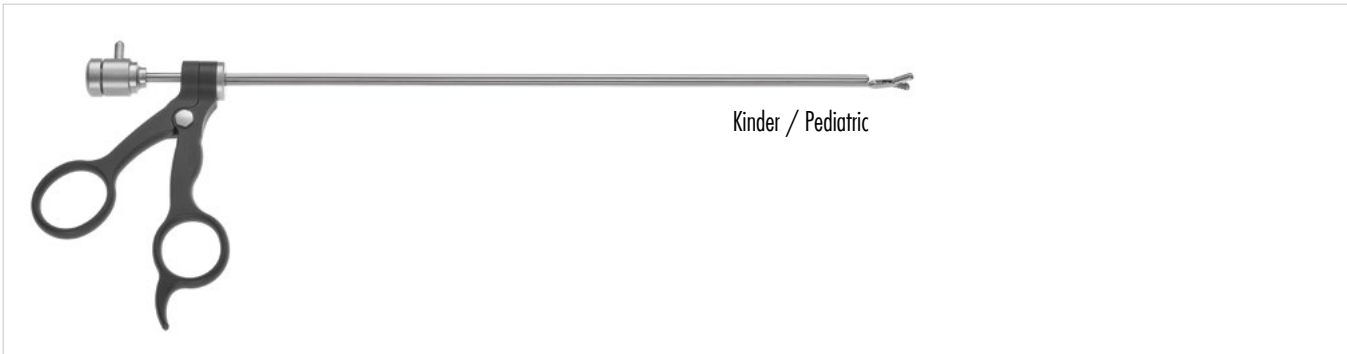

Kinder / Pediatric

Optische Bronchoskopie Zangen für Bronchoskope 6 - 3,5 mm
 Optical Bronchoscopy forceps for Bronchoscopes 6 - 3.5 mm

**HD**

100-629-000 Nutzlänge 300 mm/working length 12 inch
 Bronchoskop, starr, 0°, ø 2,9 mm, autoklavierbar
 Bronchoscope, rigid, 0°, ø 2.9 mm, autoclavable



100-900-213 Mini Probeexcisionszange, ovaler Löffel 2,3mm
 Mini Biopsy Cut Forceps, oval Spoon 2.3mm



100-900-215 Schere, doppelbeweglich
 Scissors, double action



100-900-217 Fremdkörperzange
 Foreignbody Forceps

100-010-170	206	100-212-300	210	100-500-075	221
100-010-200	206	100-213-000	209	100-500-080	221
100-010-250	206	100-213-001	209	100-500-100	223
100-100-002	3	100-213-002	209	100-500-101	223
100-100-003	3	100-213-003	209	100-500-102	224
100-100-006	3	100-213-004	209	100-500-110	223
100-102-100	2	100-213-005	209	100-500-111	223
100-103-100	2	100-213-100	210	100-500-113	223
100-103-120	3	100-213-200	210	100-500-150	224
100-103-400	3	100-213-300	210	100-500-200	225
100-104-000	2	100-214-000	207	100-500-201	214, 220, 222
100-104-001	2	100-214-001	207	100-500-202	214, 220
100-104-002	2	100-214-002	207	100-500-203	214, 220
100-104-006	2	100-214-003	207	100-500-204	214
100-105-010	3	100-214-004	207	100-500-205	214
100-210-000	207	100-214-005	207	100-500-206	214
100-210-001	207	100-214-100	210	100-500-207	214
100-210-002	207	100-214-200	210	100-500-208	214, 220, 222
100-210-003	207	100-215-001	209	100-500-210	225
100-210-004	207	100-215-002	209	100-500-310	227
100-210-005	207	100-215-003	209	100-500-380	227
100-210-006	207	100-215-004	209	100-500-385	228
100-210-100	210	100-215-005	209	100-500-400	226
100-210-200	210	100-215-100	210	100-500-410	226
100-210-300	210	100-215-200	210	100-500-420	226
100-211-000	209	100-218-003	209	100-500-531	213, 220, 221
100-211-001	209	100-218-004	209	100-500-532	213, 220, 221
100-211-002	209	100-250-000	208, 210	100-500-533	213, 220, 221
100-211-003	209	100-250-002	208	100-500-534	213
100-211-004	209	100-251-000	208	100-500-535	213
100-211-005	209	100-260-000	208	100-500-536	213
100-211-010	208, 210	100-300-001	208	100-500-537	213, 220, 221
100-211-011	208	100-300-002	208	100-500-538	220
100-211-012	208	100-418-150	126	100-500-539	220
100-211-014	208	100-418-200	126	100-500-540	220
100-211-100	210	100-500-001	212, 220 - 222	100-500-541	221
100-211-200	210	100-500-002	212, 220, 221	100-500-542	221
100-211-300	210	100-500-003	212, 220, 221	100-500-543	221
100-212-000	207	100-500-004	212	100-500-551	217, 221
100-212-001	207	100-500-005	212	100-500-552	217, 221
100-212-002	207	100-500-006	212	100-500-553	216, 220 - 222
100-212-003	207	100-500-007	212	100-500-554	216, 221
100-212-004	207	100-500-008	212, 220 - 222	100-500-555	216, 220 - 222
100-212-005	207	100-500-019	220	100-500-556	220
100-212-100	210	100-500-020	220	100-500-557	220
100-212-200	210	100-500-050	222	100-500-558	221

100-500-559	221	100-610-008	245	100-700-200	233
100-500-560	221	100-610-009	245	100-700-210	233
100-500-561	222	100-610-012	245	100-700-501	237
100-500-562	218, 220, 221	100-610-013	245	100-700-502	237
100-500-563	218, 220	100-610-014	245	100-700-503	237
100-500-564	218, 220, 221	100-610-019	245	100-700-504	237
100-500-571	219	100-610-023	245	100-700-511	237
100-500-572	219	100-610-024	245	100-700-512	237
100-500-573	219	100-610-025	245	100-700-513	237
100-500-574	222	100-610-026	245	100-700-514	237
100-500-575	222	100-610-100	5	100-700-520	237
100-500-576	222	100-618-090	243	100-700-521	237
100-500-581	215, 220, 221	100-618-120	243	100-700-522	237
100-500-582	215, 220 - 222	100-623-090	243	100-700-523	237
100-500-583	215, 220 - 222	100-623-120	243	100-700-524	237
100-500-584	220	100-627-000	244	100-700-550	237
100-500-585	220	100-629-000	254	100-700-551	237
100-500-586	221	100-655-000	244, 253	100-700-552	237
100-500-587	221	100-655-030	244, 253	100-700-553	237
100-500-588	222	100-655-100	244, 252	100-701-075	243
100-505-000	211	100-655-130	244, 252	100-704-230	233
100-505-001	211	100-700-001	232	100-710-001	235
100-505-002	211	100-700-002	232	100-710-002	235
100-505-003	211	100-700-003	232	100-710-003	235
100-505-100	211	100-700-004	232	100-710-004	235
100-505-101	211	100-700-005	232	100-710-005	235
100-505-102	211	100-700-006	232	100-710-006	235
100-505-103	211	100-700-007	232	100-710-020	235
100-510-000	211	100-700-008	232	100-710-021	235
100-510-001	211	100-700-020	232	100-710-022	235
100-510-002	211	100-700-021	232	100-710-023	235
100-510-003	211	100-700-022	232	100-710-050	235
100-510-100	211	100-700-023	232	100-710-051	235
100-510-101	211	100-700-024	232	100-710-052	235
100-510-102	211	100-700-025	232	100-710-053	235
100-510-103	211	100-700-026	232	100-712-001	234
100-512-000	224	100-700-030	233	100-712-002	234
100-518-090	243	100-700-050	233	100-712-003	234
100-601-075	243	100-700-051	233	100-712-004	234
100-604-000	244	100-700-052	233	100-712-005	234
100-604-030	244	100-700-053	233	100-712-006	234
100-610-001	245	100-700-054	233	100-712-007	234
100-610-002	245	100-700-101	232	100-712-008	234
100-610-003	245	100-700-102	232	100-712-009	234
100-610-006	245	100-700-103	232	100-712-013	234
100-610-007	245	100-700-104	232	100-715-001	236

100-715-002	236	100-720-411	247	100-750-308	246
100-715-003	236	100-720-412	247	100-750-309	246
100-715-004	236	100-720-413	247	100-750-310	246
100-715-005	236	100-720-501	247	100-750-401	246
100-715-006	236	100-720-502	247	100-750-402	246
100-715-007	236	100-720-503	247	100-750-403	246
100-715-008	236	100-720-504	247	100-750-404	246
100-718-090	243	100-720-505	247	100-750-405	246
100-718-120	243	100-720-506	247	100-750-406	246
100-720-001	248	100-720-507	247	100-750-407	246
100-720-002	248	100-720-508	247	100-750-408	246
100-720-003	248	100-720-509	247	100-750-409	246
100-720-004	248	100-720-510	247	100-750-410	246
100-720-011	248	100-720-511	247	100-750-501	246
100-720-012	248	100-720-512	247	100-750-502	246
100-720-013	248	100-720-513	247	100-750-503	246
100-720-014	248	100-720-601	247	100-750-504	246
100-720-021	248	100-720-602	247	100-750-505	246
100-720-022	248	100-720-603	247	100-750-506	246
100-720-023	248	100-720-604	247	100-750-507	246
100-720-024	248	100-720-605	247	100-750-508	246
100-720-031	248	100-720-606	247	100-750-509	246
100-720-032	248	100-720-607	247	100-750-510	246
100-720-033	248	100-720-608	247	100-750-601	246
100-720-034	248	100-720-609	247	100-750-602	246
100-720-301	247	100-720-610	247	100-750-603	246
100-720-302	247	100-720-611	247	100-750-604	246
100-720-303	247	100-720-612	247	100-750-605	246
100-720-304	247	100-720-613	247	100-750-606	246
100-720-305	247	100-723-090	243	100-750-607	246
100-720-306	247	100-723-120	243	100-750-608	246
100-720-307	247	100-725-001	236	100-750-609	246
100-720-308	247	100-725-002	236	100-750-610	246
100-720-309	247	100-725-003	236	100-754-000	250
100-720-312	247	100-725-004	236	100-754-003	250
100-720-313	247	100-725-005	236	100-754-004	250
100-720-401	247	100-725-006	236	100-754-005	250
100-720-402	247	100-725-007	236	100-754-007	250
100-720-403	247	100-725-008	236	100-754-008	250
100-720-404	247	100-750-301	246	100-754-009	250
100-720-405	247	100-750-302	246	100-754-014	250
100-720-406	247	100-750-303	246	100-754-016	250
100-720-407	247	100-750-304	246	100-754-017	250
100-720-408	247	100-750-305	246	100-754-018	250
100-720-409	247	100-750-306	246	100-754-019	250
100-720-410	247	100-750-307	246	100-754-020	250

100-754-021	250	100-853-295	241	120-053-115	110
100-754-024	250	100-854-295	241	120-057-140	41
100-754-026	250	100-854-350	249	120-058-140	106
100-754-027	250	100-854-500	249	120-059-140	106
100-754-028	250	100-855-300	241	120-065-120	107
100-754-029	250	100-856-300	241	120-065-150	107
100-754-030	250	100-856-380	249	120-071-105	41
100-754-031	250	100-857-300	241	120-081-100	108
100-754-032	250	100-860-020	239	120-092-115	107
100-754-040	250	100-860-025	239	120-093-115	107
100-754-041	250	100-860-030	239	120-094-115	107
100-755-304	251	100-860-300	241	120-094-120	108
100-755-305	251	100-861-001	239	120-095-115	107
100-755-310	251	100-861-002	239	120-095-120	108
100-755-404	251	100-862-030	239	120-099-105	107
100-755-405	251	100-864-030	239	120-110-110	108
100-755-410	251	100-864-280	249	120-112-110	108
100-755-504	251	100-866-230	198	120-131-115	109
100-755-505	251	100-870-000	239	120-131-135	109
100-755-510	251	100-870-001	239	120-133-190	186
100-755-604	251	100-870-002	239	120-136-100	107
100-755-605	251	100-870-003	239	120-137-100	107
100-755-610	251	100-870-100	239	120-190-190	109
100-800-070	229	100-900-203	253	120-208-230	74
100-800-090	229	100-900-207	253	120-209-180	186
100-805-070	229	100-900-213	254	120-213-170	186
100-806-070	229	100-900-215	254	120-217-190	186
100-808-070	229	100-900-217	254	120-218-190	186
100-808-090	229	100-900-223	252	120-265-120	188
100-850-000	238	100-900-225	252	120-280-150	110
100-850-001	238	100-900-228	252	120-281-110	109
100-850-002	238	110-110-003	40, 99	120-281-130	109
100-850-003	238	110-114-003	40	120-281-160	110
100-850-004	238	110-116-033	184	120-283-180	74
100-850-005	238	110-130-007	40	120-284-180	74
100-850-006	238	110-130-077	40, 99, 184	120-285-175	74
100-850-007	238	110-201-010	40	120-285-180	74
100-850-008	238	110-201-011	40, 99	120-286-220	86
100-850-009	238	110-201-012	40	120-287-180	74
100-850-010	238	110-201-013	40	120-306-140	75
100-850-011	238	110-201-015	40, 99	120-315-150	106
100-850-012	238	110-201-112	40	120-379-115	110
100-850-350	249	110-201-115	40	120-398-120	107
100-850-500	249	120-043-150	106	120-411-090	108
100-852-350	249	120-043-180	106	120-411-105	108
100-852-500	249	120-047-120	41	120-511-100	108

120-511-145	109	140-549-200	189	165-152-027	130
120-520-145	109	140-602-200	180	165-525-005	39
120-521-145	109, 185	140-620-180	181	165-525-006	39, 140
120-521-180	185	140-620-235	181	165-525-007	140
120-521-200	185	140-625-190	189	165-525-008	39, 140
120-581-160	110	140-625-200	181	165-525-010	39, 140
120-585-180	74, 110	140-626-190	181	165-525-012	39, 140
120-595-115	109	140-627-190	189	165-525-015	39
120-966-130	106	140-628-190	189	165-536-006	39
120-967-130	106	140-629-190	189	165-536-007	39
121-081-100	108	140-630-190	189	165-536-009	39
121-111-145	185	140-631-190	189	165-536-010	39
121-111-180	185	140-639-190	190	165-538-003	39
121-111-200	185	150-080-160	72	165-538-005	39
121-188-145	106	150-080-180	72	165-538-007	39
121-189-145	106	150-130-200	185	165-539-003	39
121-280-145	110	150-131-200	185	165-539-005	39
121-281-160	110	160-010-140	18	165-539-007	39
121-511-100	108	160-012-140	18	165-543-270	182
130-028-150	112	160-131-105	17	165-625-005	39
130-038-200	185	160-131-140	17	165-625-006	39
130-120-150	112	160-255-140	18	165-625-008	39
130-144-125	112	160-255-180	18	165-625-010	39
130-144-150	42	160-410-120	17	165-625-012	39
130-145-125	42, 112	160-412-180	70	165-625-015	39
130-145-150	42	160-420-110	17	165-725-008	39
130-160-200	185	160-420-165	70	165-725-010	39
130-500-100	42, 112	160-421-110	17	165-725-012	39
130-501-100	42, 112	160-422-110	17	165-725-015	39
130-503-100	42, 112	160-422-140	17	165-855-020	128, 198
130-504-100	42, 112	160-423-110	18	165-855-050	128, 198
130-548-120	42	160-423-140	18	165-855-100	128, 198
130-550-120	42	160-426-120	18	165-856-020	128, 198
130-552-120	111	160-426-140	18	165-856-050	128, 198
130-552-150	111	160-426-160	70	165-856-100	128, 198
130-558-150	111	160-426-165	70	170-002-165	204
140-254-125	127	160-481-200	197	170-003-165	204
140-255-125	127	160-495-280	202	170-005-001	204
140-256-125	127	165-052-018	130	170-005-002	204
140-257-125	127	165-059-170	130	170-005-003	204
140-280-140	127	165-064-160	115	170-008-381	102
140-281-140	127	165-072-025	132	170-010-125	101
140-290-140	127	165-076-300	132	170-013-130	101
140-291-140	127	165-152-017	130	170-013-180	101
140-368-185	189	165-152-020	130	170-014-001	102
140-369-185	189	165-152-023	130	170-014-002	102

170-014-005	102	180-531-150	113	210-265-000	29
170-014-007	102	180-531-170	113	210-265-100	99
170-014-010	102	180-533-130	113	210-303-135	28
170-042-130	101	180-537-130	113	210-303-165	27
170-060-001	101	180-542-150	113	210-304-010	29
170-060-002	101	180-588-150	113	210-304-020	29
170-076-163	102	180-711-240	190	210-304-030	29
170-076-164	102	180-718-210	190	210-304-040	29
170-079-163	102	180-719-210	190	210-304-050	29
170-079-164	102	180-720-230	190	210-304-060	29
170-234-120	33	210-019-170	99	210-304-100	29
170-235-120	33	210-100-162	28	210-304-135	28
170-285-165	133	210-100-163	28	210-304-200	29
170-293-001	133	210-100-164	28	210-304-300	29
170-325-001	179	210-102-162	28	210-304-400	29
170-325-002	179	210-102-163	28	210-304-500	30
170-325-003	179	210-102-164	28	210-305-135	28
170-700-060	205	210-103-160	28	210-305-400	30
170-701-050	205	210-105-160	28	210-306-135	28
170-702-070	205	210-109-002	28	210-307-135	28
170-703-070	205	210-109-004	28	210-311-150	27
170-720-100	33	210-109-005	28	210-325-120	28
170-723-100	33	210-109-006	28	210-335-120	28
170-723-105	33	210-109-007	28	210-345-007	138
170-735-110	32	210-113-143	98	210-347-007	138
170-735-130	32	210-113-145	98	210-348-000	29
170-736-110	32	210-113-147	98	210-348-001	29
170-736-130	32	210-113-149	98	210-348-010	29
170-752-130	32	210-114-143	98	210-348-200	29
170-753-130	32	210-114-145	98	210-348-300	29
170-754-110	31	210-114-147	98	210-350-010	138
170-754-155	32	210-114-149	98	210-350-100	138
170-755-110	31	210-160-004	28	210-350-200	138
170-757-110	31	210-160-006	28	210-394-150	27
170-758-110	31	210-160-104	28	210-395-130	27
170-760-110	31	210-160-106	28	210-395-175	27
170-761-110	31	210-204-160	28	210-396-160	27
170-762-130	31	210-206-160	28	210-397-185	27
170-763-130	31	210-213-140	30	210-438-195	91
170-765-110	31	210-216-001	30	210-439-006	40, 91
170-780-165	33	210-216-150	30	210-439-008	40, 91
170-780-170	32	210-218-012	30	210-472-006	93
170-781-165	33	210-224-180	29	210-472-105	93
170-783-165	33	210-240-180	29, 99	210-473-006	94
170-784-165	33	210-244-220	29	210-474-006	94
180-318-110	113	210-264-140	29, 99	210-486-006	93

210-486-008	93	230-329-008	201	250-048-180	163, 230, 231
210-486-016	93	230-329-010	201	250-048-230	163, 230, 231
210-487-004	93	230-329-012	201	250-048-300	163, 230, 231
210-487-007	93	230-329-014	201	250-051-000	4, 163, 231
210-487-008	93	230-329-016	201	250-052-000	4, 163, 231
210-487-010	93	230-329-018	201	250-053-180	230
210-487-012	93	230-329-020	201	250-053-230	230
210-488-004	93	230-329-022	201	250-054-180	230
210-488-007	93	230-329-024	201	250-054-230	230
210-488-009	93	230-329-026	201	250-059-000	4, 163, 231
210-488-012	93	230-329-028	201	250-064-021	41
210-528-240	88	230-329-030	201	250-064-079	41
210-626-190	116	230-330-006	201	250-064-376	101
210-640-140	34	230-330-008	201	250-064-392	103
210-789-150	35	230-330-010	201	250-066-275	10
210-790-150	35	230-330-012	201	250-264-246	113
210-790-180	35	230-330-014	201	251-010-000	11
210-791-180	35	230-330-016	201	251-010-100	11
210-815-165	34	230-330-018	201	251-010-200	10
210-826-180	34	230-330-020	201	251-010-300	10
210-829-170	34	230-330-022	201	251-010-400	10
210-829-180	34	230-330-024	201	251-104-001	142
210-832-185	34	230-330-026	201	251-104-002	142
210-833-185	34	230-330-028	201	251-104-120	142
210-845-170	35	230-330-030	201	251-105-120	142
210-845-185	87	230-331-110	201	251-127-001	142
210-846-150	35	230-332-105	201	251-127-002	142
210-855-180	87	250-015-030	159	251-127-120	142
210-880-175	35	250-020-025	159	251-613-110	41
210-890-150	35	250-020-030	159	252-000-111	81
230-202-000	117	250-024-260	41	252-000-120	80
230-202-001	117	250-024-261	41	252-000-121	80
230-202-002	117	250-025-230	163, 230, 231	252-000-122	81
230-203-150	101	250-025-300	163, 230, 231	252-001-120	80
230-205-180	101	250-035-180	163, 230, 231	252-001-121	80
230-207-180	101	250-035-230	163, 230, 231	252-001-122	81
230-209-180	101	250-035-300	163, 230, 231	252-001-170	128, 198
230-210-170	117	250-037-000	4, 163, 231	252-001-200	89
230-211-170	117	250-038-000	4, 163, 231	252-002-120	80
230-220-001	102	250-039-000	4, 163, 231	252-002-121	80
230-260-200	103	250-040-000	163, 231	252-002-122	81
230-281-140	103	250-041-000	163, 231	252-002-130	143
230-282-140	103	250-042-000	163, 231	252-002-180	89
230-285-160	101	250-044-000	4, 163, 231	252-003-120	80
230-286-160	101	250-045-000	4, 163, 231	252-003-121	80
230-329-006	201	250-048-000	4, 163, 231	252-003-122	81

<u>252-003-130</u>	143	<u>252-025-180</u>	140	<u>252-050-180</u>	133
<u>252-003-170</u>	128, 198	<u>252-025-190</u>	137	<u>252-052-180</u>	133
<u>252-004-120</u>	80	<u>252-025-210</u>	137	<u>252-053-170</u>	133
<u>252-004-121</u>	80	<u>252-027-190</u>	137	<u>252-070-130</u>	151
<u>252-004-122</u>	81	<u>252-028-001</u>	84	<u>252-071-190</u>	137
<u>252-004-130</u>	145	<u>252-028-002</u>	84	<u>252-071-220</u>	137
<u>252-004-131</u>	145	<u>252-028-003</u>	84	<u>252-071-221</u>	138
<u>252-004-132</u>	145	<u>252-028-004</u>	84	<u>252-071-222</u>	138
<u>252-004-170</u>	128, 198	<u>252-029-000</u>	84	<u>252-072-001</u>	138
<u>252-005-170</u>	128, 198	<u>252-029-165</u>	84	<u>252-072-002</u>	138
<u>252-009-000</u>	137	<u>252-029-500</u>	85	<u>252-072-003</u>	138
<u>252-009-001</u>	137	<u>252-031-120</u>	155	<u>252-072-004</u>	138
<u>252-010-025</u>	154	<u>252-031-190</u>	86	<u>252-072-005</u>	138
<u>252-010-035</u>	154	<u>252-032-120</u>	155	<u>252-072-006</u>	138
<u>252-010-100</u>	146	<u>252-032-190</u>	86	<u>252-072-245</u>	139
<u>252-011-025</u>	154	<u>252-033-120</u>	155	<u>252-073-200</u>	139
<u>252-011-035</u>	154	<u>252-033-190</u>	86	<u>252-082-190</u>	137
<u>252-013-130</u>	144	<u>252-034-120</u>	155	<u>252-093-190</u>	137
<u>252-013-145</u>	144	<u>252-034-131</u>	144	<u>252-104-000</u>	141
<u>252-014-130</u>	145	<u>252-034-132</u>	144	<u>252-104-030</u>	141
<u>252-014-131</u>	145	<u>252-034-133</u>	144	<u>252-104-045</u>	141
<u>252-014-132</u>	145	<u>252-034-134</u>	144	<u>252-104-070</u>	141
<u>252-014-135</u>	144	<u>252-034-135</u>	144	<u>252-104-200</u>	141
<u>252-014-145</u>	144	<u>252-035-131</u>	145	<u>252-104-230</u>	141
<u>252-015-100</u>	146	<u>252-035-132</u>	145	<u>252-104-270</u>	141
<u>252-015-110</u>	130	<u>252-035-133</u>	145	<u>252-110-100</u>	146
<u>252-015-300</u>	154	<u>252-035-134</u>	145	<u>252-113-190</u>	139
<u>252-015-310</u>	154	<u>252-035-135</u>	145	<u>252-114-190</u>	139
<u>252-015-320</u>	154	<u>252-035-150</u>	81	<u>252-115-100</u>	146
<u>252-015-400</u>	154	<u>252-035-151</u>	81	<u>252-115-110</u>	130
<u>252-015-500</u>	154	<u>252-035-152</u>	81	<u>252-118-110</u>	130
<u>252-015-510</u>	154	<u>252-037-131</u>	145	<u>252-120-110</u>	130
<u>252-015-520</u>	154	<u>252-037-132</u>	145	<u>252-121-100</u>	153
<u>252-020-110</u>	130	<u>252-037-133</u>	145	<u>252-122-100</u>	153
<u>252-021-100</u>	153	<u>252-040-150</u>	81	<u>252-123-100</u>	153
<u>252-022-045</u>	82	<u>252-040-151</u>	81	<u>252-125-110</u>	130
<u>252-022-055</u>	82	<u>252-040-152</u>	81	<u>252-125-150</u>	131
<u>252-022-065</u>	82	<u>252-040-190</u>	139	<u>252-125-151</u>	131
<u>252-022-100</u>	153	<u>252-041-012</u>	139	<u>252-125-152</u>	131
<u>252-023-100</u>	153	<u>252-041-017</u>	139	<u>252-127-000</u>	141
<u>252-023-130</u>	143	<u>252-042-235</u>	139	<u>252-127-030</u>	141
<u>252-024-130</u>	143	<u>252-043-025</u>	140	<u>252-127-070</u>	141
<u>252-025-130</u>	143	<u>252-043-030</u>	140	<u>252-127-200</u>	141
<u>252-025-150</u>	131	<u>252-043-040</u>	140	<u>252-127-230</u>	141
<u>252-025-151</u>	131	<u>252-043-050</u>	140	<u>252-140-003</u>	39
<u>252-025-152</u>	131	<u>252-050-150</u>	81	<u>252-140-004</u>	39

252-140-005	39	252-205-190	137	252-502-145	153
252-140-190	139	252-206-000	144	252-503-090	148
252-143-120	155	252-206-001	144	252-503-140	148
252-144-121	155	252-206-002	144	252-503-150	148
252-145-001	135	252-207-000	144	252-504-100	154
252-145-002	135	252-207-001	144	252-505-100	154
252-145-003	135	252-207-002	144	252-526-115	79
252-145-004	135	252-210-100	146	252-527-115	79
252-145-005	135	252-215-100	146	252-527-120	83
252-145-120	155	252-215-190	137	252-528-115	79
252-146-001	135	252-225-150	131	252-529-115	79
252-146-121	155	252-225-151	131	252-529-120	83
252-147-170	136	252-225-152	131	252-530-115	79
252-148-170	136	252-310-100	147	252-530-120	82
252-149-172	136	252-315-100	146	252-531-120	83
252-149-272	136	252-315-200	147	252-533-170	149
252-150-110	134	252-315-300	147	252-534-100	82
252-151-110	134	252-325-150	131	252-534-170	149
252-152-150	140	252-325-151	131	252-534-270	149
252-160-150	140	252-325-152	131	252-535-170	136
252-165-150	140	252-342-120	151	252-536-115	83
252-170-130	151	252-343-120	151	252-536-170	149
252-170-150	140	252-352-120	151	252-536-235	149
252-171-100	147	252-353-120	151	252-536-245	149
252-171-190	137	252-362-120	151	252-536-435	149
252-171-300	147	252-372-120	151	252-536-445	149
252-171-700	147	252-401-025	145	252-537-115	83
252-172-190	138	252-403-025	145	252-537-170	149
252-173-100	147	252-410-112	148	252-537-270	149
252-173-190	138	252-410-130	82	252-537-335	149
252-173-300	147	252-410-131	82	252-537-345	149
252-173-700	147	252-413-131	82	252-538-115	83
252-174-180	148	252-425-115	80	252-539-115	79
252-182-190	137	252-425-150	131	252-570-120	150
252-193-190	137	252-425-151	131	252-600-070	152
252-200-095	135	252-425-152	131	252-601-070	152
252-200-110	78	252-426-100	83	252-602-070	152
252-200-111	78	252-470-120	150	252-605-090	152
252-200-112	78	252-472-130	150	252-606-090	152
252-200-195	135	252-473-130	150	252-606-345	152
252-201-110	78	252-477-141	78	252-606-390	152
252-201-111	78	252-477-142	78	252-670-120	150
252-201-112	78	252-477-143	78	252-770-120	150
252-202-111	78	252-499-175	134	260-500-001	121
252-203-111	78	252-500-175	134	260-501-120	103
252-204-100	128	252-502-100	153	290-137-270	116

290-552-160	111	410-009-003	6	410-021-009	8
300-001-028	160	410-009-004	6	410-022-000	8
300-001-031	160	410-009-005	6	410-022-001	8
300-001-055	160	410-009-006	6	410-022-002	8
300-001-158	160	410-009-100	6	410-022-003	8
300-001-168	160	410-011-001	6	410-022-004	8
300-001-232	160	410-011-002	6	410-022-005	8
300-001-400	158	410-011-003	6	410-022-006	8
300-001-410	158	410-011-004	6	410-022-007	8
300-001-600	157	410-011-005	6	410-022-008	8
300-001-601	157	410-011-100	6	410-022-009	8
300-001-602	157	410-014-004	6	410-023-000	8
300-001-610	156, 157, 158	410-014-005	6	410-023-001	8
300-001-615	156, 157, 158	410-014-006	6	410-023-002	8
300-001-800	156	410-014-007	6	410-023-003	8
300-001-802	156	410-014-100	6	410-023-004	8
300-001-804	156	410-016-001	7	410-023-005	8
300-001-813	159	410-016-002	7	410-023-006	8
300-001-814	159	410-016-003	7	410-023-007	8
300-001-815	159	410-016-004	7	410-023-008	8
300-001-823	159	410-016-005	7	410-023-009	8
300-001-824	159	410-018-004	7	410-024-001	9
300-001-825	159	410-018-005	7	410-024-002	9
300-010-226	160	410-018-006	7	410-024-003	9
300-090-100	142	410-018-007	7	410-024-004	9
300-900-180	162	410-018-008	7	410-024-005	9
300-900-300	161	410-018-009	7	410-024-006	9
400-025-110	111	410-018-010	7	410-024-007	9
400-137-050	112	410-018-085	7	410-027-000	12
400-287-004	102	410-019-003	7	410-027-030	12
400-287-044	102	410-019-004	7	410-027-070	12
400-310-001	197	410-019-005	7	410-030-160	26
400-310-002	197	410-019-030	7	410-031-140	26
400-310-003	197	410-019-040	7	410-031-180	25
400-310-004	197	410-019-050	7	410-032-050	9
400-310-005	197	410-019-060	7	410-032-060	9
400-310-006	197	410-019-075	7	410-032-070	9
400-310-007	197	410-021-000	8	410-032-160	26
400-420-100	126	410-021-001	8	410-032-175	26
400-421-000	126	410-021-002	8	410-032-180	25
400-583-005	126	410-021-003	8	410-032-181	25
400-583-007	126	410-021-004	8	410-032-182	25
400-583-008	126	410-021-005	8	410-033-160	26
400-583-009	126	410-021-006	8	410-033-180	25
410-004-000	12	410-021-007	8	410-044-001	49
410-004-030	12	410-021-008	8	410-044-002	49

410-044-003	49	410-110-160	43	410-132-002	9
410-044-004	49	410-111-155	43	410-132-003	9
410-044-150	49	410-112-155	43	410-132-004	9
410-045-180	197	410-113-155	45	410-132-005	9
410-046-160	49	410-114-155	43	410-132-006	9
410-046-180	197	410-115-003	43	410-132-160	39
410-047-160	49	410-115-006	43	410-133-160	39
410-089-001	49	410-115-010	43	410-134-006	38
410-089-002	49	410-115-153	45	410-134-007	38
410-090-010	37	410-116-103	45	410-134-009	38
410-090-015	37	410-116-105	45	410-134-012	38
410-090-020	37	410-116-110	45	410-134-016	38
410-090-030	37	410-116-155	43	410-134-116	37
410-090-040	37	410-116-205	45	410-134-120	37
410-090-050	37	410-116-210	45	410-134-216	37
410-092-001	50	410-116-305	45	410-134-220	37
410-093-160	50	410-116-310	45	410-134-316	37
410-100-000	20	410-117-002	43	410-134-320	37
410-100-001	20	410-117-003	43	410-135-000	38
410-100-002	20	410-117-004	43	410-135-048	51
410-100-003	20	410-117-006	43	410-135-050	51
410-100-004	20	410-117-008	43	410-135-051	51
410-100-160	50	410-117-010	43	410-135-060	46
410-100-300	20	410-117-012	43	410-135-061	46
410-101-000	20	410-117-015	43	410-135-062	46
410-101-001	20	410-117-020	43	410-135-063	46
410-101-002	20	410-117-025	43	410-135-160	39
410-101-003	20	410-118-010	50	410-137-004	46
410-101-004	20	410-118-012	50	410-137-006	46
410-101-160	50	410-118-015	50	410-137-008	46
410-101-300	20	410-118-016	50	410-137-013	46
410-102-000	20	410-118-020	50	410-137-014	46
410-102-001	20	410-118-023	50	410-137-015	46
410-102-002	20	410-118-026	50	410-137-016	46
410-102-003	20	410-118-028	50	410-142-135	46
410-102-004	20	410-118-030	50	410-142-140	46
410-102-300	20	410-119-010	44	410-142-145	46
410-103-000	20	410-119-011	44	410-142-150	46
410-103-001	20	410-119-015	51	410-142-166	46
410-103-002	20	410-119-020	51	410-143-000	47
410-103-003	20	410-119-025	51	410-144-007	48
410-103-004	20	410-119-030	51	410-144-010	48
410-103-160	50	410-119-110	44	410-144-015	48
410-103-300	20	410-120-020	44	410-144-017	48
410-109-170	50	410-124-160	50	410-144-030	48
410-110-155	43	410-132-001	9	410-144-100	48

410-144-200	48	410-200-000	16	410-228-000	73
410-145-000	48	410-205-000	16	410-228-010	73
410-145-175	18	410-205-001	16	410-228-100	73
410-146-175	18	410-205-002	16	410-229-000	73
410-147-145	18	410-205-100	16	410-229-050	73
410-147-175	18	410-208-100	55	410-230-120	23
410-148-175	18	410-210-002	43	410-230-140	23
410-150-015	37	410-210-003	43	410-230-170	44
410-150-017	37	410-210-004	43	410-231-050	23
410-150-020	37	410-210-006	43	410-231-085	23
410-154-130	51	410-210-008	43	410-231-140	23
410-154-180	51	410-210-010	43	410-232-140	72
410-155-180	51	410-210-012	43	410-240-170	44
410-155-800	47	410-210-015	43	410-241-035	36
410-156-180	51	410-210-020	43	410-242-018	36
410-157-001	46	410-210-025	43	410-245-001	36
410-157-002	46	410-210-085	21	410-245-002	36
410-157-003	46	410-210-203	45	410-247-165	111
410-157-004	46	410-210-206	45	410-250-001	59
410-157-005	46	410-210-210	45	410-250-002	59
410-157-006	46	410-210-303	45	410-267-004	38
410-165-030	37	410-210-306	45	410-267-006	38
410-165-035	37	410-210-310	45	410-267-007	38
410-174-102	13	410-211-085	21	410-267-009	38
410-174-128	13	410-215-085	21	410-267-012	38
410-174-204	13	410-216-003	45	410-267-100	38
410-174-256	13	410-216-004	44	410-270-250	71
410-174-512	13	410-216-005	45	410-276-072	16
410-175-128	13	410-216-006	44	410-276-074	16
410-180-010	13	410-216-007	44	410-276-076	16
410-180-020	13	410-216-008	44	410-276-078	16
410-180-030	13	410-216-009	44	410-276-080	16
410-180-040	13	410-216-010	45	410-290-170	44
410-180-125	13	410-216-045	45	410-300-000	62
410-185-010	13	410-216-160	45	410-301-000	62
410-185-110	13	410-216-165	45	410-302-000	59
410-185-200	14	410-216-180	30	410-302-010	59
410-185-210	13, 14	410-217-003	45	410-302-020	59
410-185-310	13, 14	410-217-006	45	410-302-030	59
410-185-410	13, 14	410-217-010	45	410-302-040	59
410-185-510	13, 14	410-217-103	45	410-302-050	59
410-190-440	13	410-217-106	45	410-302-060	59
410-195-000	14	410-217-110	45	410-303-000	59
410-195-010	13, 14	410-223-010	57	410-303-010	59
410-195-045	37	410-225-003	37	410-303-020	59
410-195-110	13, 14	410-227-000	14	410-303-030	59

410-303-040	59	410-341-100	60	410-344-500	55
410-303-050	59	410-341-200	60	410-344-800	56
410-310-011	177	410-341-300	60	410-345-000	53
410-310-110	177	410-341-400	60	410-345-080	22
410-321-000	52	410-341-500	55	410-346-000	53
410-327-165	40	410-341-800	56	410-346-080	22
410-328-165	40	410-342-000	53	410-347-080	22
410-329-000	62	410-342-100	61	410-347-500	55
410-329-160	40	410-342-110	61	410-348-000	53
410-330-000	52	410-342-120	61	410-349-000	62
410-330-090	21	410-342-130	61	410-350-000	54
410-330-160	40	410-342-140	61	410-350-132	57
410-330-200	52	410-342-200	61	410-350-150	25
410-330-800	55	410-342-210	61	410-350-500	57
410-332-000	52	410-342-220	61	410-350-700	56
410-334-000	62	410-342-230	61	410-351-010	58
410-335-000	52	410-342-240	61	410-351-020	58
410-335-700	55	410-342-500	55	410-351-030	58
410-335-800	55	410-342-800	56	410-351-040	58
410-338-000	52	410-343-000	53	410-351-050	58
410-338-132	21	410-343-100	60	410-351-060	58
410-338-133	21	410-343-110	61	410-351-500	57
410-338-134	21	410-343-120	61	410-352-000	54
410-338-135	22	410-343-130	61	410-352-010	58
410-338-136	22	410-343-140	61	410-352-020	58
410-338-137	21	410-343-200	60	410-352-030	58
410-338-138	21	410-343-210	61	410-352-040	58
410-338-139	21	410-343-220	61	410-352-050	58
410-338-140	22	410-343-230	61	410-352-060	58
410-338-141	22	410-343-240	61	410-352-170	25
410-338-142	22	410-343-310	61	410-352-500	57
410-339-000	52	410-343-320	61	410-352-700	56
410-340-080	57	410-343-330	61	410-353-000	54
410-340-100	60	410-343-340	61	410-353-500	57
410-340-110	60	410-343-410	61	410-353-700	56
410-340-120	60	410-343-420	61	410-354-000	62
410-340-130	60	410-343-430	61	410-354-180	25
410-340-140	60	410-343-440	61	410-355-000	54
410-340-200	60	410-343-500	55	410-355-180	25
410-340-210	60	410-343-510	61	410-356-080	58
410-340-220	60	410-343-520	61	410-356-180	25
410-340-230	60	410-343-530	61	410-357-080	58
410-340-240	60	410-343-540	61	410-357-180	25
410-340-300	60	410-343-800	56	410-358-180	25
410-340-400	60	410-344-000	53	410-359-000	54
410-341-000	53	410-344-080	22	410-359-180	25

410-359-500	57	410-586-143	19	420-136-080	68
410-360-000	54	410-797-050	15	420-136-090	68
410-360-500	57	410-797-100	15	420-140-035	69
410-361-080	57	410-798-100	15	420-140-050	69
410-365-080	56	410-800-000	15	420-140-075	69
410-366-080	56	410-800-010	15	420-140-090	69
410-370-081	55	410-800-020	15	420-140-100	69
410-370-082	55	410-800-030	15	420-140-135	66
410-375-100	24	410-800-040	15	420-142-135	66
410-375-120	24	410-800-050	15	420-145-036	67
410-377-120	24	410-800-100	15	420-145-056	67
410-381-130	24	420-050-001	65	420-145-075	67
410-383-120	42	420-050-002	65	420-145-090	67
410-389-190	73	420-050-003	65	420-147-140	69
410-391-140	24	420-050-004	65	420-148-150	69
410-395-160	73	420-050-005	65	420-150-001	69, 142
410-404-030	115	420-050-006	65	420-150-002	69, 142
410-404-035	115	420-050-007	65	420-150-003	69, 142
410-404-040	115	420-050-101	65	420-150-004	69, 142
410-410-160	24	420-050-102	65	420-150-005	69, 142
410-411-100	24	420-050-103	65	420-150-006	69, 142
410-423-000	62	420-050-104	65	420-150-007	69, 142
410-424-000	62	420-050-105	65	420-150-008	69, 142
410-580-001	20	420-050-106	65	420-150-160	70
410-580-002	20	420-050-107	65	420-150-165	70
410-580-003	20	420-052-001	65	420-150-180	70
410-580-130	20	420-052-002	65	420-184-100	103
410-580-161	20	420-052-003	65	420-185-100	103
410-580-162	20	420-052-004	65	420-186-145	103
410-580-163	20	420-057-160	105	420-187-155	103
410-581-160	19	420-100-001	66	420-187-255	103
410-583-150	19	420-100-002	66	420-189-210	114
410-583-160	19	420-100-003	66	420-190-003	100
410-584-001	19	420-100-100	197	420-191-003	100
410-584-002	19	420-119-001	66	420-195-000	38
410-584-160	19	420-119-002	66	420-195-150	100
410-584-180	19	420-119-003	66	420-196-000	38
410-585-001	19	420-121-150	66, 142	420-196-006	38
410-585-002	19	420-122-150	66, 142	420-196-008	38
410-585-003	19	420-123-150	66, 142	420-196-010	38
410-585-004	19	420-131-190	197	420-196-012	38
410-585-005	19	420-134-050	67	420-196-015	38
410-585-006	19	420-136-020	68	420-196-018	38
410-585-007	19	420-136-035	68	420-196-020	38
410-586-141	19	420-136-055	68	420-196-022	38
410-586-142	19	420-136-070	68	420-196-025	38

420-196-030	38	420-260-005	104	420-407-011	75
420-201-260	71	420-260-008	104	420-408-003	75
420-205-160	100	420-260-013	104	420-408-004	75
420-207-160	100	420-260-113	104	420-409-120	75
420-209-175	100	420-365-000	116	420-410-001	84
420-210-003	71	420-365-050	116	420-410-002	84
420-210-013	71	420-366-000	116	420-410-120	76
420-210-200	72	420-367-000	116	420-410-140	76
420-211-160	72	420-370-210	87	420-411-200	72
420-211-200	72	420-370-212	87	420-412-190	85
420-213-140	100	420-371-210	87	420-413-140	77
420-213-180	86	420-375-165	73	420-413-230	71
420-214-180	85	420-390-200	114	420-414-120	77
420-220-010	192	420-391-000	195	420-415-120	77
420-220-020	192	420-391-001	195	420-416-120	77
420-220-030	192	420-391-002	195	420-418-140	78
420-220-040	192	420-391-115	195	420-419-140	78
420-220-050	192	420-392-003	92	420-420-140	78
420-220-060	192	420-392-004	92	420-421-001	76
420-220-070	192	420-392-005	92	420-421-002	76
420-221-010	192	420-393-003	92	420-421-003	76
420-221-020	192	420-393-004	92	420-422-190	85
420-221-030	192	420-393-005	92	420-427-200	180
420-221-040	192	420-395-205	88	420-450-230	115
420-221-050	192	420-395-240	194	420-451-230	115
420-221-060	192	420-396-190	194	420-452-230	115
420-221-070	192	420-397-210	194	420-455-230	115
420-222-000	193	420-398-190	195	420-458-160	95
420-222-001	193	420-398-210	194	420-459-001	94
420-222-002	193	420-400-001	84	420-459-002	94
420-222-003	193	420-400-002	84	420-459-003	94
420-222-004	193	420-400-003	84	420-460-001	95
420-223-170	79	420-401-001	76, 196	420-460-002	95
420-226-001	193	420-401-002	76, 196	420-460-003	95
420-226-002	193	420-401-100	77, 196	420-460-005	95
420-226-003	193	420-401-101	77, 196	420-470-001	95
420-226-101	193	420-401-102	77, 196	420-470-002	95
420-226-102	193	420-401-103	77, 196	420-470-003	95
420-226-103	193	420-401-190	75	420-472-002	95
420-236-110	105	420-401-201	77, 196	420-472-003	95
420-250-160	104	420-402-190	75	420-480-200	121
420-251-160	104	420-405-120	75	420-488-200	121
420-253-185	88	420-406-120	75	420-490-210	120
420-255-160	105	420-407-005	75	420-491-000	95
420-256-135	104	420-407-007	75	420-491-001	95
420-257-160	105	420-407-009	75	420-491-002	95

420-491-210	120	420-523-141	104	420-571-006	98
420-492-165	120	420-524-150	103	420-571-008	98
420-492-210	120	420-530-165	27, 91	420-571-010	98
420-493-165	120	420-531-165	27, 91	420-571-012	98
420-493-210	120	420-532-165	27, 91	420-572-002	96
420-494-165	120	420-533-165	91	420-572-003	96
420-494-210	120	420-540-180	88	420-572-004	96
420-495-165	120	420-541-180	88	420-572-005	96
420-495-210	120	420-543-210	89	420-572-010	96
420-496-001	97	420-544-165	90	420-572-011	96
420-496-002	97	420-546-180	88	420-572-012	96
420-496-003	97	420-547-004	90	420-573-001	97
420-496-004	97	420-547-005	90	420-573-002	97
420-496-005	97	420-547-006	90	420-573-003	97
420-496-006	97	420-548-180	88	420-580-002	96
420-496-007	97	420-549-200	137	420-580-003	96
420-496-008	97	420-550-170	92	420-580-004	96
420-496-009	97	420-550-230	89	420-580-007	96
420-496-010	97	420-551-170	92	420-580-009	96
420-496-012	97	420-551-175	89	420-580-012	96
420-496-015	97	420-551-180	90	420-582-003	96
420-496-165	120	420-551-200	89	420-582-045	96
420-496-210	120	420-552-130	100	420-586-004	95
420-497-210	120	420-552-170	92	420-586-005	95
420-498-210	120	420-552-200	89	420-586-006	95
420-499-210	120	420-552-215	88	420-586-007	95
420-500-200	97	420-555-195	114	420-587-008	94
420-502-002	98	420-555-200	89	420-587-010	94
420-502-003	98	420-556-200	88	420-587-012	94
420-502-005	98	420-557-165	90	420-587-014	94
420-502-007	98	420-557-170	114	420-587-016	94
420-502-010	98	420-568-002	96	420-587-177	94
420-502-014	98	420-568-003	96	420-589-008	94
420-502-016	98	420-568-004	96	420-589-010	94
420-502-018	98	420-568-005	96	420-589-012	94
420-502-102	98	420-568-006	96	420-589-014	94
420-502-103	98	420-568-008	96	420-589-016	94
420-502-105	98	420-568-010	96	420-590-004	92
420-502-107	98	420-570-002	98	420-591-004	92
420-502-110	98	420-570-004	98	420-594-002	97
420-502-114	98	420-570-006	98	420-594-003	97
420-502-116	98	420-570-008	98	420-594-004	97
420-502-118	98	420-570-010	98	420-594-005	97
420-520-140	104	420-570-012	98	420-594-006	97
420-520-141	104	420-571-002	98	420-594-007	97
420-523-140	104	420-571-004	98	420-594-008	97

420-594-010	97	420-672-000	120	430-000-002	178
420-594-012	97	420-700-001	122	430-000-003	178
420-594-015	97	420-700-002	122	430-000-004	178
420-595-170	92	420-700-020	122	430-000-005	178
420-596-002	97	420-700-022	123	430-010-002	178
420-596-003	97	420-700-023	123	430-010-003	178
420-596-004	97	420-700-024	123	430-010-004	178
420-596-006	97	420-700-025	122	430-010-005	178
420-596-008	97	420-700-030	122	430-129-001	173
420-596-010	97	420-700-040	122	430-129-002	173
420-596-011	97	420-700-060	122	430-129-003	173
420-596-015	97	420-700-100	123	430-130-070	171
420-605-160	117	420-700-120	123	430-130-075	171
420-606-160	117	420-700-140	123	430-130-080	171
420-628-254	121	420-700-160	123	430-130-085	171
420-639-001	95	420-700-180	123	430-130-095	171
420-639-002	95	420-700-200	122	430-130-100	171
420-639-003	95	420-700-210	122	430-130-105	171
420-641-001	95	420-700-330	124	430-130-500	171, 172
420-641-002	95	420-700-340	123	430-130-550	171
420-641-003	95	420-700-400	122	430-130-560	172
420-650-001	117, 118	420-700-501	122	430-140-110	169
420-650-002	118	420-700-502	122	430-142-120	170
420-650-100	121	420-700-610	123	430-144-160	170
420-650-101	120	420-700-611	123	430-145-145	170
420-652-100	105	420-700-620	123	430-150-130	169
420-653-000	121	420-700-630	124	430-245-200	191
420-653-180	117	420-700-640	124	430-250-090	170
420-654-180	121	420-700-650	124	430-250-110	170
420-655-180	121	420-700-700	125	430-250-130	170
420-656-000	119	420-700-777	125	430-250-150	170
420-657-180	121	420-700-888	125	430-256-001	172
420-658-175	118	420-702-175	98	430-256-002	172
420-658-210	118	420-703-175	98	430-256-003	172
420-659-175	118	420-704-175	98	430-256-010	172
420-660-000	119	420-706-175	98	430-257-001	176
420-660-214	120	420-730-085	111	430-257-002	176
420-660-216	120	420-730-100	111	430-257-003	176
420-660-218	120	420-732-155	111	430-257-004	176
420-660-219	120	420-743-055	67	430-257-005	176
420-660-220	120	420-743-075	67	430-261-090	171
420-661-000	119	420-743-090	67	430-261-110	171
420-661-100	119	420-752-100	105	430-261-130	171
420-662-001	118	420-756-180	121	430-261-150	171
420-662-002	118	420-832-001	126	430-271-150	168
420-669-210	120	420-832-145	126	430-297-140	168

430-297-150	168	430-361-190	167	430-650-205	181
430-298-100	168	430-362-170	167	430-650-215	184
430-300-230	191	430-363-170	167	430-652-215	184
430-301-120	133	430-385-190	167	430-654-200	184
430-301-130	133	430-396-165	167	430-655-210	183
430-301-135	133	430-397-190	167	430-656-190	184
430-309-001	173	430-465-160	206	430-656-195	184
430-309-002	173	430-465-170	206	430-670-235	182
430-309-003	173	430-465-190	206	430-788-012	201
430-309-004	173	430-467-170	206	430-788-014	201
430-309-005	173	430-468-000	206	430-788-016	201
430-309-006	174	430-497-141	168	430-788-018	201
430-309-007	174	430-497-151	168	430-800-100	202
430-309-008	174	430-500-260	190	430-803-230	202
430-310-000	176	430-505-205	190	430-805-250	202
430-310-001	175	430-506-210	191	430-813-010	203
430-310-002	175	430-518-150	167	430-813-020	203
430-310-003	175	430-520-150	167	430-813-030	203
430-310-004	175	430-520-230	191	430-813-040	203
430-310-010	177	430-522-150	167	430-813-050	203
430-310-011	177	430-522-230	191	430-813-060	202
430-310-110	177	430-524-210	191	430-815-220	204
430-315-000	175	430-600-215	182	431-630-006	27
430-315-001	175	430-600-230	183	431-630-007	27
430-315-002	175	430-601-220	182	431-630-009	27
430-315-003	175	430-601-230	183	431-630-011	27
430-315-010	175	430-602-175	191	440-020-130	205
430-320-000	179	430-602-230	183	440-021-130	205
430-320-065	174	430-603-280	187	440-030-150	180
430-320-075	174	430-604-280	187	440-030-200	180
430-320-090	174	430-605-200	185	440-120-120	204
430-320-102	174	430-605-270	187	440-130-140	204
430-320-115	174	430-606-003	187	440-221-160	205
430-327-000	178	430-606-005	187	440-225-222	179
430-327-001	178	430-606-040	187	500-270-002	126
430-327-002	178	430-607-003	187	500-384-010	118
430-327-003	178	430-607-040	187	500-386-045	118
430-327-004	178	430-620-000	188	500-387-000	118
430-349-145	168	430-620-100	188	600-400-230	63
430-350-005	169	430-620-220	182	600-400-300	63
430-350-007	169	430-620-300	188	600-402-140	63
430-350-009	169	430-631-002	180	600-402-195	63
430-350-010	169	430-650-001	188	600-402-255	63
430-355-000	179	430-650-002	188	600-402-260	63
430-355-001	179	430-650-003	188	600-405-300	63
430-355-002	179	430-650-100	188	600-405-420	63

700-101-000	199, 240
700-101-001	199, 240
700-101-030	240
700-101-050	240
700-101-130	199, 240
700-101-150	199, 240
700-280-030	240
700-280-050	240
700-285-030	240
700-285-050	240
700-287-030	199, 240
700-287-050	199, 240
700-287-130	199, 240
700-287-150	199, 240
700-340-400	165
700-340-410	165
700-350-030	199, 240
700-350-050	199, 240
700-350-130	199, 240
700-350-150	199, 240
700-350-400	164
700-350-402	164, 165
700-350-405	164, 165
700-350-410	164
700-351-031	199, 240
700-351-051	199, 240
700-351-131	199, 240
700-351-151	199, 240
700-360-031	240
700-360-051	240
700-420-002	128
700-501-303	240
700-501-503	240
700-503-000	164, 165
700-503-001	164, 165
700-503-003	164, 165
700-801-165	128

