

HF SURGERY & ACCESSORIES



HF SURGERY

High frequency surgery is one of the most common procedures and present in nearly every operating room all over the world. Surgeons in small doctor's offices and even in grand hospitals use it for procedures in every medical field of application. There are a variety of electro-surgical instruments available for open and laparoscopic surgeries.

We offer our G44 and G400 HF Units as well as the most common fitting accessory parts. Instruments for special procedures like arthroscopy, urology, hysteroscopy and laparoscopy surgery can be found in our corresponding catalogues.



Trade Product Symbol

Products marked with this TradeProduct-Symbol are not available with RZ-Marking and not with the CE-number of RZ.



ELECTROSURGICAL GENERATORS

4 - 13

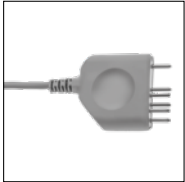

HF CABLES

14 - 19



HANDLES WITH HF CABLES

20 - 21

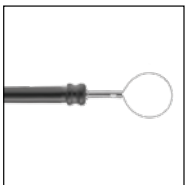

MONOPOLAR ELECTRODES

22 - 25



ARGON ELECTRODES

26



BIPOLAR FORCEPS AND SCISSORS

27 - 31



theRZeal INSTRUMENTS

32



FURTHER HF INSTRUMENTS

43 - 41



Electrosurgical Generator G400

- Automatic power regulation
- Detects and identifies connected instrument, and selects the appropriate program automatically (SDS plug only)
- Powerstart System eases the beginning of cutting process
- 105 various automatic programmes in 7 groups
- Real-time monitoring of output parameters
- For bipolar TUR-B/P and monopolar TUR-P



10" Touchscreen



Easy readable interface design



Tilttable display

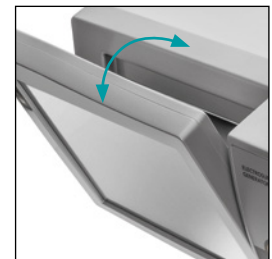

Instrument detecting sockets



700-350-400	Electrosurgical Generator G400, 230V
700-350-410	Electrosurgical Generator G400, 110V
700-350-420	with Argon, 230V
700-350-430	with Argon, 110V
700-350-460	with the RZeal, 230V
700-350-470	with the RZeal, 110V
700-350-440	with the RZeal and Argon, 230V
700-350-450	with the RZeal and Argon, 110V



Electrosurgical Generator G400 Technical Data

SAFETY FEATURES

Class / Grade	I / CF
Low-frequency leakage currents	acc. to IEC 60601-1
High-frequency leakage currents	cc. to IEC 60601-2-2
Generator operation frequency	333 kHz
Defibrillation impulse resistance	cc. to EN60601-1
NEM System	neutral electrode control optical indication 7 levels required resistance < 240 Ω

GENERAL

Supply voltage	230 V +/- 10% 50 Hz or 110 V +/- 10% 60 Hz
Rated power input	1350 VA
Weight	12.2kg
Dimensions	495 x 415 x 225mm (LxWxH)

ARGON*

Gas type	pure argon 4.8 (99,998%) or higher
Inlet gas pressure	0.25 - 0.4 [MPa]
Gas outflow	0.1-10 l/min, regulated 0.1 l/min in whole range
Pressure range	reducer (0.4 MPa) on argon cylinder

theRZeal**

Vessel sealing system	9 effects / 300W
AutoStop	automatic stop of sealing process after achieving the optimal effect

MONOPOLAR CUTTING

Mono Cut	9 effects / 350W
Precise Cut	9 effects / 50W
Mixed Cut	9 effects / 150W
Polipo Cut**	9 levels
Papillo Cut**	9 levels
Arthro Cut**	9 levels
Uro Cut**	9 levels
Hystero Cut**	9 levels
Argon Cut**	9 effects / 350W

BIPOLAR CUTTING

Bi-Cut	9 effects / 120W
Uro Bi-Cut**	9 levels
Arthro Bi-Cut**	9 levels

MONOPOLAR COAGULATION

Soft Coag	9 effects / 200W
Forced Coag	9 effects / 200W
Spray Coag	80W
Hybrid Coag	9 effects / 200W
Standard Argon*	80W
Endo Argon*	40W
Pulse Argon*	40W
Uro Coag**	9 levels
Athro Coag**	9 levels
Hystero Coag**	9 levels

BIPOLAR COAGULATION

Soft Bi-Coag	9 effects / 120W AutoStart / AutoStop
Forced Bi-Coag	9 effects / 120W AutoStop
Uro Bi-Coag**	9 levels
Arthro Bi-Coag**	9 levels
Sciss Bi-Coag**	9 levels



YouTube setup and operation Video on the RZ YouTube Channel:
<https://youtu.be/MhNzO1LMn-k>

* available only in Argon-Version

** available only in theRZeal + Argon-Version



Electrosurgical Generator G44

- Intelligent Instrument detection system
- Intuitive Touchscreen
- Automatic power regulation
- Configurable working modes
- Real-time parameter control
- Special endoscopic modes
- Bipolar resection
- Easy software update



7" Touchscreen



Real-time parameter control

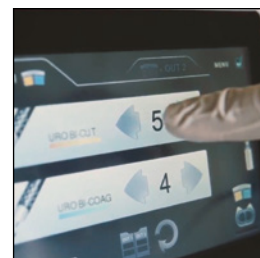

Instrument detecting sockets



700-340-400	Electrosurgical Generator G44, 230V (for Urology / Hysteroscopy)
700-340-410	Electrosurgical Generator G44, 110V (for Urology / Hysteroscopy)
700-340-430	Electrosurgical Generator G44, 230V (for Arthroscopy)
700-340-420	Electrosurgical Generator G44, 110V (for Arthroscopy)



Electrosurgical Generator G44 Technical Data

SAFETY FEATURES

Protection against electric shock	I / CF
Low-frequency leakage currents	acc. to IEC 60601-1
High-frequency leakage currents	cc. to IEC 60601-2-2
Generator operation frequency	333 kHz
Defibrillation impulse resistance	cc. to IEC 60601-1
NEM System	neutral electrode control, optical indication, required resistance < 240 Ω

GENERAL

Supply voltage	230 V +/- 10% 50 Hz or 110 V +/- 10% 60 Hz
Rated power input	1350 VA
Weight	7kg
Dimensions	385 x 305 x 141mm (LxWxH)

MONOPOLAR CUTTING max. 400W (100 Ω)

Mono Cut	
Precise Cut	
Mixed Cut	9 effects
Uro Cut	
Hystero Cut	

BIPOLAR CUTTING max. 330W (150 Ω)

Bi-Cut	9 effects
Uro Bi-Cut	9 effects

MONOPOLAR COAGULATION max. 200W (200 Ω)

Soft Coag	9 effects
Forced Coag	9 effects
Spray Coag	80 effects / 80W
Hybrid Coag	9 effects
Uro Coag	9 effects
Hystero Coag	9 effects

BIPOLAR COAGULATION max. 400W (25 Ω)

Soft Bi-Coag	9 effects AutoStart / AutoStop
Forced Bi-Coag	9 effects AutoStop
Uro Bi-Coag	9 effects
Sciss Bi-Coag	9 effects



YouTube setup and operation Video on the RZ YouTube Channel:
<https://youtu.be/Pr-1Er1EO8M>

HF SURGERY



wireless

700-350-401

3-Button-Footswitch and
1 Vario-Switch-Button*
Wireless (for G400 Generator)

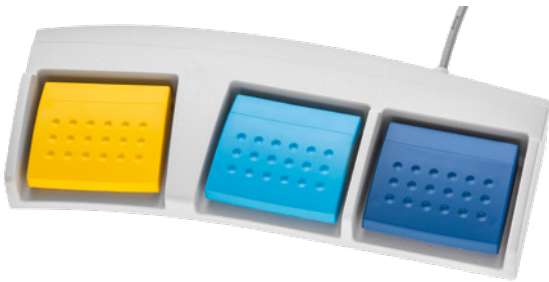

6-pin plug

700-350-306

3-Button-Footswitch, cable length: 5m,
(for G400 Generator)



wireless

700-350-403

2-Button-Footswitch and
1 Vario-Switch-Button*
Wireless



6-pin plug

700-350-402

2-Button-Footswitch and
1 Vario-Switch-Button*, length: 5m



6-pin plug

700-350-405

2-Button-Footswitch , length: 5m

***VARIO SWITCH BUTTON:**

Allows remote changing of the settings with a single press of the button (only G400 Generator).



300-001-700

RZ Trolley for HF devices
with drawer, two shelves
861 x 614 x 625mm (H x W x D)



300-001-982

CO2 Gas bottle holder for 20 - 50 L
with shelf/holder

HF SURGERY

CALES FOR UROLOGY

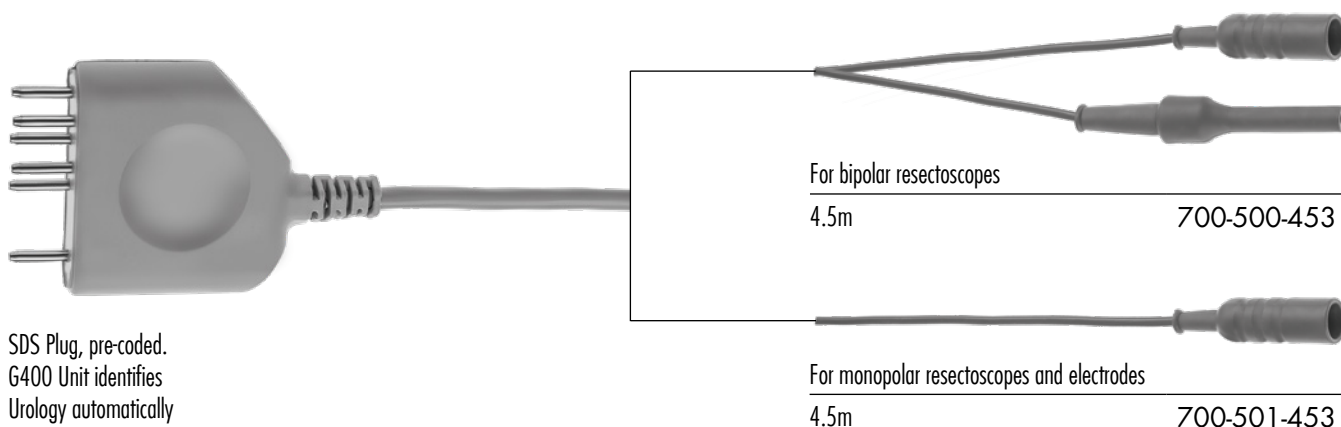

CABLES FOR HYSTEROSCOPY

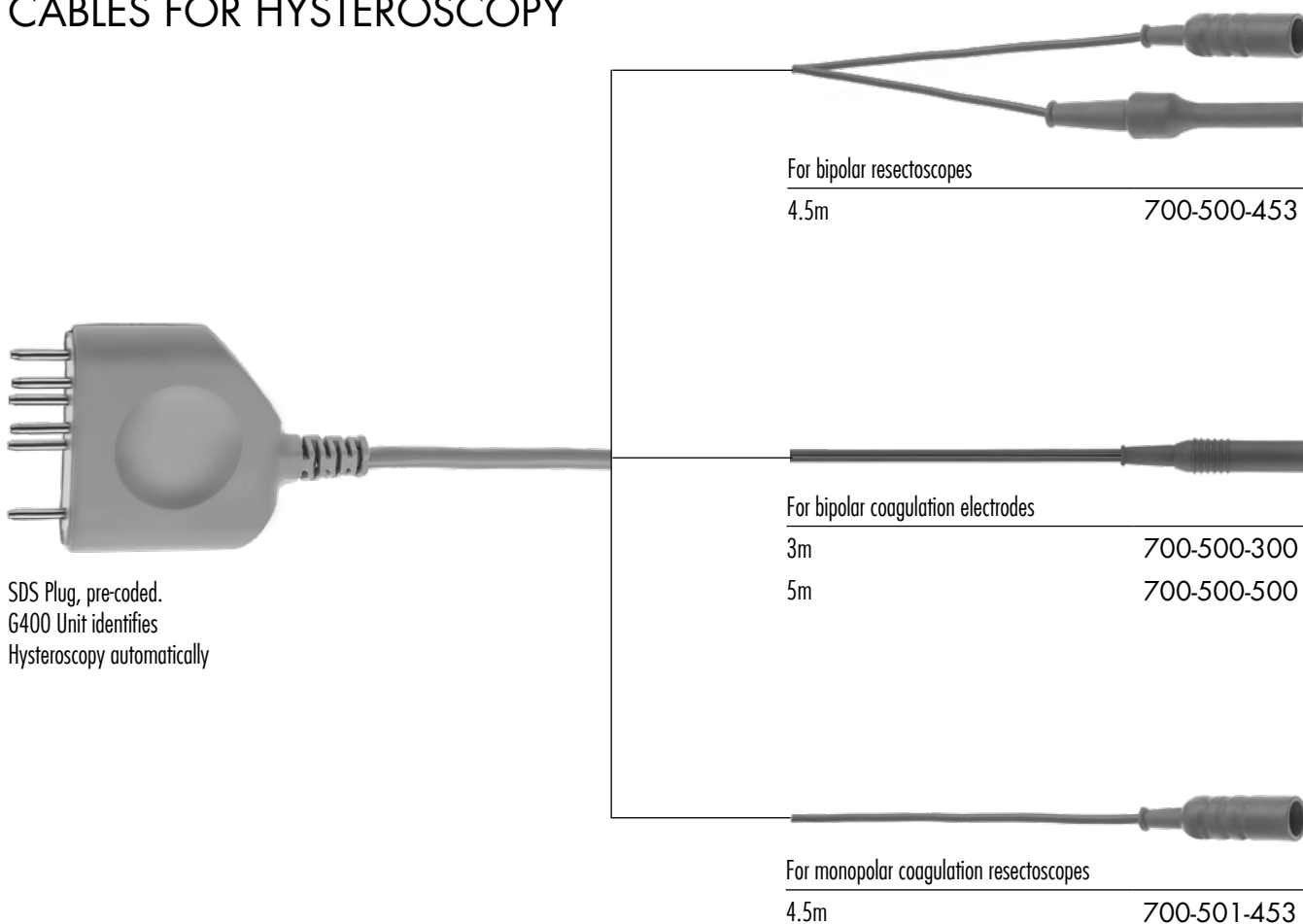

CABLES FOR ARTHROSCOPY

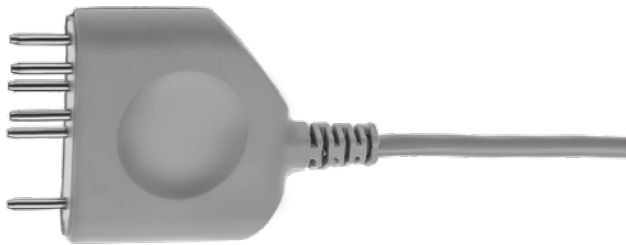

SDS Plug, pre-coded.
G400 Unit identifies
Arthroscopy automatically

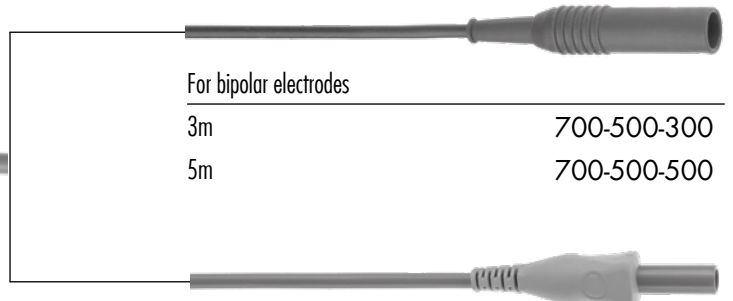

For bipolar electrodes

3m 700-500-300

5m 700-500-500

For monopolar electrodes

3m 700-501-300

5m 700-501-500

CABLES FOR LAPAROSCOPY

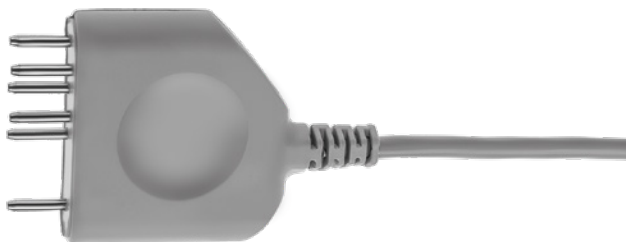

SDS Plug, pre-coded.
G400 Unit identifies
Laparoscopy automatically

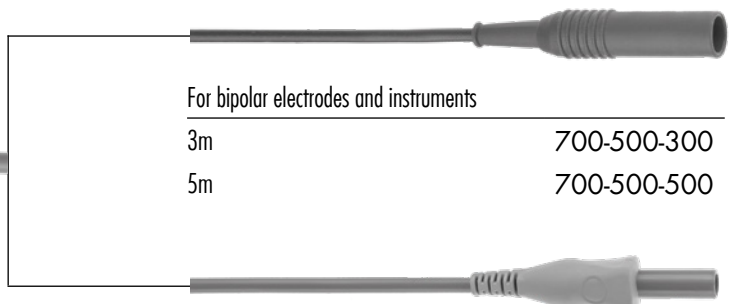

For bipolar electrodes and instruments

3m 700-500-300

5m 700-500-500

For monopolar electrodes and instruments

3m 700-501-300

5m 700-501-500

CABLES FOR BIPOLAR SCISSORS

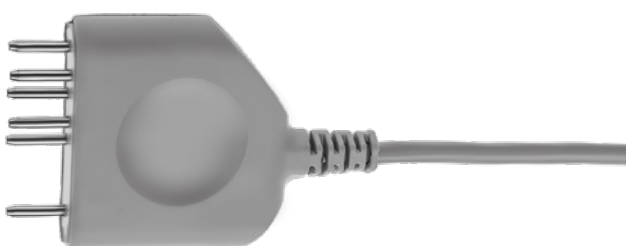

SDS Plug, pre-coded.
G400 Unit identifies
Instrument automatically



For bipolar scissors

3m 700-500-305

HF SURGERY

CABLES FOR LAPAROSCOPY / ENT / ARTHROSCOPY UROLOGY & HYSTEROSCOPY

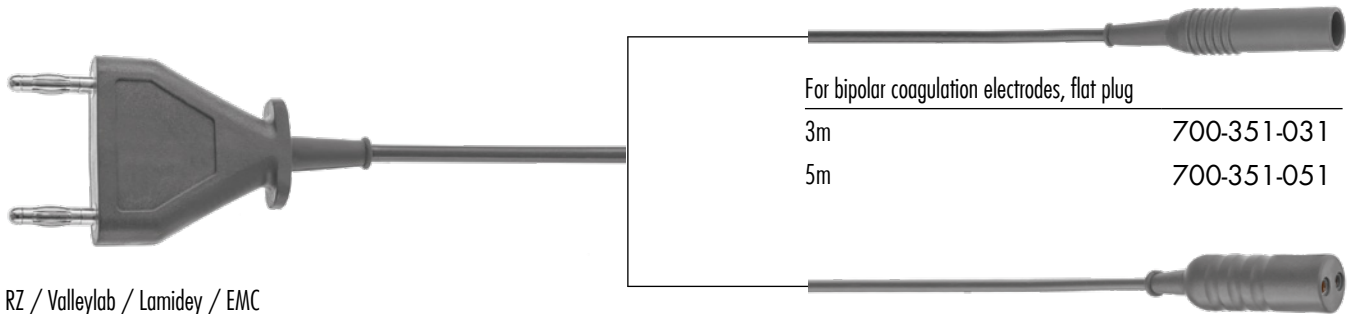

RZ / Valleylab / Lamidey / EMC

For bipolar coagulation electrodes, flat plug	
3m	700-351-031
5m	700-351-051

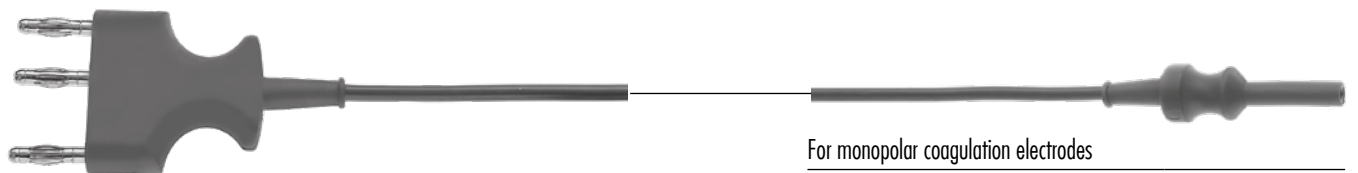

RZ HF Unit Standard Plug

For bipolar coagulation electrodes, 2-pin plug	
3m	700-300-203
5m	700-300-205

CABLES FOR UROLOGY & HYSTEROSCOPY

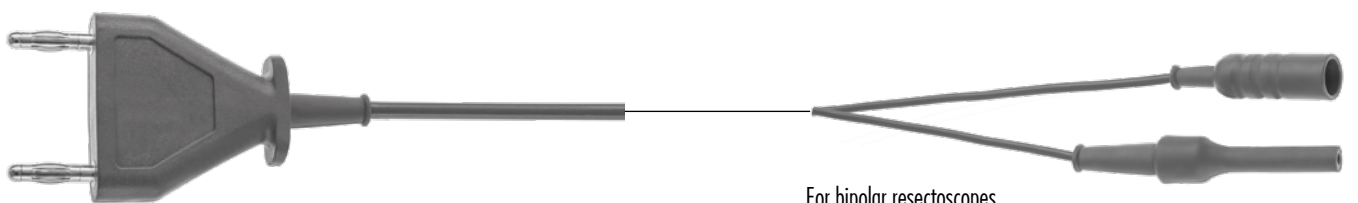

RZ / Valleylab / Lamidey / EMC

For bipolar resectoscopes	
4.5m	253-400-603

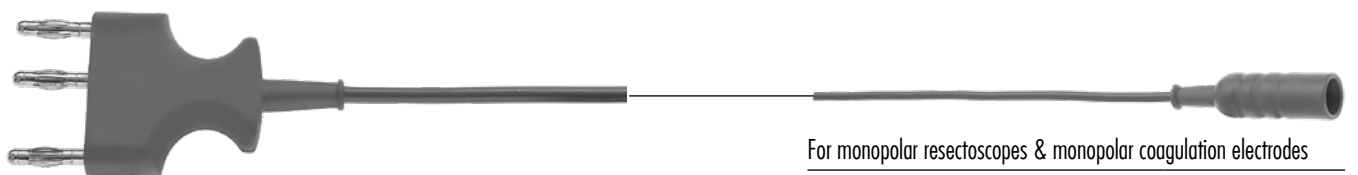

RZ HF Unit Standard Plug

For monopolar resectoscopes & monopolar coagulation electrodes	
4.5m	700-501-045

NEUTRAL ELECTRODES & CABLES



Neutral Electrode, single use, pack of 50pcs.



Adult 700-503-000

Children 700-503-001



RZ / Valleylab /
Erbe / Conmed

4.5m



700-503-003
(for single use neutral electrode)



700-700-005
260 x 150mm



700-700-003
160 x 80mm



Erbe / Integra /
KLS Martin

4.5m



700-503-013
(for single use neutral electrode)













700-700-006
260 x 150mm



700-700-004
160 x 80mm

HF SURGERY

BIPOLAR CABLES

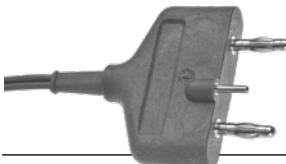
					
		Flat plug	Flat plug, angled	Flat plug, square	2-pin plug
	RZ HF Unit SDS Plug, programmable	3m 700-500-300			
		5m 700-500-500			
	2-Banana*	3m 700-350-030	300-860-100	700-350-130	700-351-030
		5m 700-350-050	300-860-111	700-350-150	700-351-050
	Erbe	3m 700-101-001	700-100-130	700-101-130	700-100-102
		5m 700-100-101	700-100-150	700-101-150	700-100-103
	Martin, Aesculap Berchtold	3m 700-287-030	700-200-130	700-287-130	700-200-132
		5m 700-287-050	700-200-150	700-287-150	700-200-152
	RZ, Valleylab, Lamidey, EMC	3m 700-351-031	700-300-003	700-351-131	700-300-203
		5m 700-351-051	700-300-005	700-351-151	700-300-205
	Erbe EMC/Dolley	3m 700-400-050	700-400-003	700-400-103	700-400-203
		5m 700-400-055		700-400-105	
	Valleylab autobipolar	3m 700-400-030		700-400-130	
		5m			

* Not available with CE marking within Europe



2-pin plug, angled

2-pin plug, angled

Round plug

R. Wolf plug

Karl Storz plug

Ethicon Scissors plug

Aesculap Plug

700-345-403

700-345-003

700-739-003

700-630-003

700-351-047

700-351-053

700-200-030

700-345-405

700-345-005

700-739-005

700-351-048

700-351-055

700-200-050

700-101-230

700-100-202

700-100-104

700-100-302

700-100-402

700-100-502

700-101-250

700-100-303

700-100-105

700-100-305

700-100-405

700-100-505

700-287-230

700-200-232

700-390-030

700-200-332

700-200-432

700-200-532

700-287-250

700-200-252

700-390-050

700-200-352

700-200-452

700-200-552

700-351-231

700-300-403

700-736-003

700-300-503

700-300-603

700-300-703

700-351-251

700-300-405

700-736-005

700-300-505

700-300-705

700-300-805

700-400-303

700-400-403

700-400-503

700-400-603

700-400-205

HF SURGERY



HF PENCIL HANDLES WITH INTEGRATED CABLES

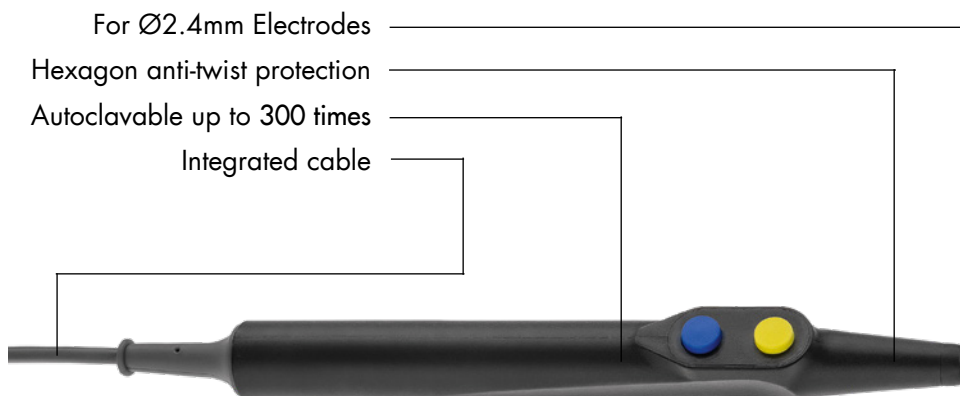

1 Handle with integrated cable, 2 Buttons

1pc.

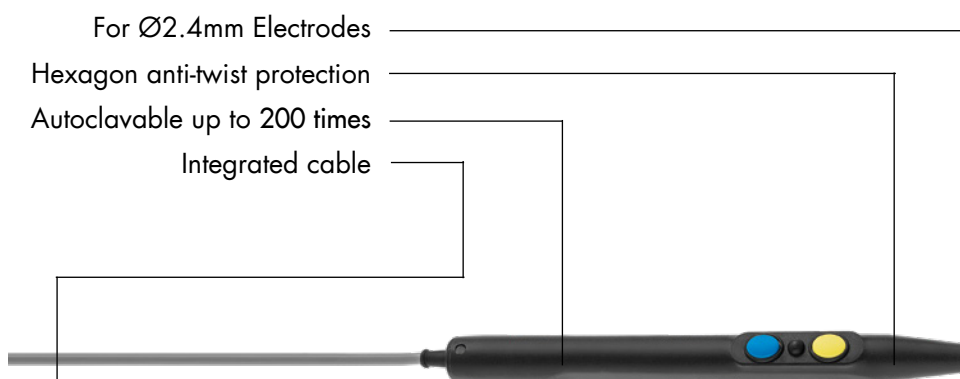

2 Handle with integrated cable, 2 Buttons

1pc.



Generator end for **2**

Erbe / Storz
4m 700-700-025

Martin
4m 700-700-023

Valleylab / RZ
4m 700-700-120

Generator end for **2**

Valleylab / RZ
4m 700-700-020

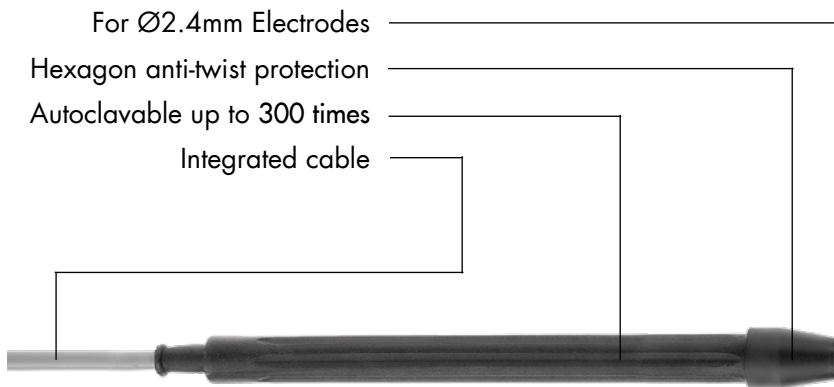

Handle with integrated cable, without buttons

 1pc.



Generator end

 4mm

 5m 700-700-018 

HF SURGERY



ACTIVE MONOPOLAR ELECTRODES

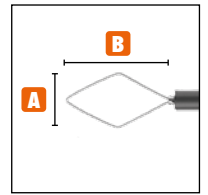
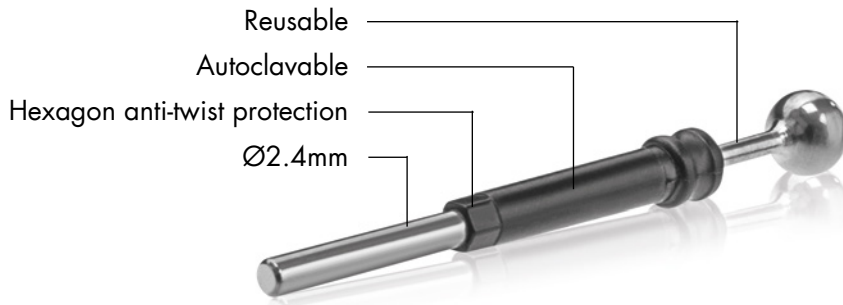

Needle
20mm / Ø 0.7mm 5 pcs. 700-700-057 **P**



Tungsten
20mm / Ø 0.5mm 5 pcs. 700-700-056



Tungsten, angled
20mm / Ø 0.5mm 5 pcs. 700-700-055 **P**



Tungsten, with ceramic isolation
25mm / Ø 0.5mm 1 pc. 700-700-054 **P**



Wire loop, triangular, flexible
A 9mm, Ø 0.2mm 5 pcs. 700-700-049



Wire loop, triangular, flexible
A 7mm, Ø 0.2mm 5 pcs. 700-700-048



Wire loop, flexible
Ø 5mm, Ø 0.2mm 5 pcs. 700-700-043



Wire loop, rhombus, flexible
A 6mm, **B** 10mm 5 pcs. 700-700-050



Ball, flexible
Ø 1mm 5 pcs. 700-700-045



Wire loop, flexible
Ø 8mm, Ø 0.2mm 5 pcs. 700-700-044



Ball, flexible
Ø 3mm 5 pcs. 700-700-046

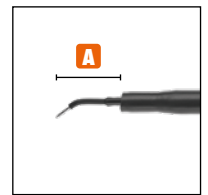
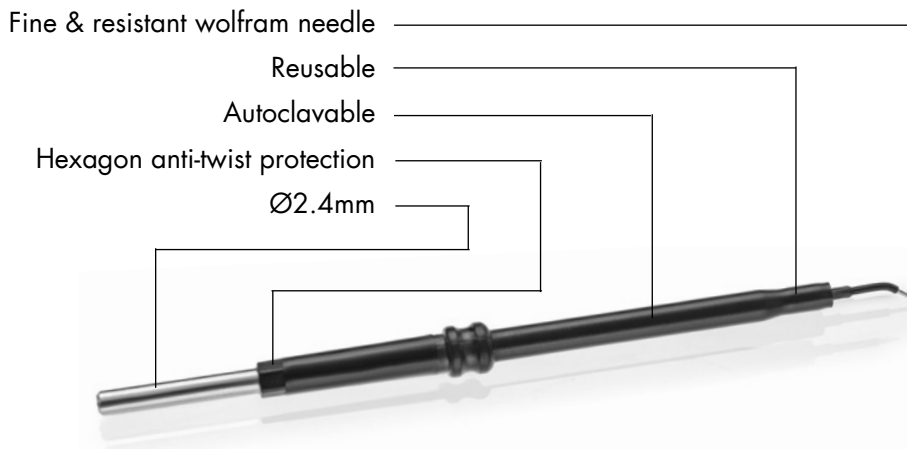

Needle

A 5mm / Ø 0.4mm 5 pcs. 700-700-030 **P**



Needle

A 20mm / Ø 0.5mm 1 pc. 700-700-031 **P**



Needle, angled

A 20mm / Ø 0.5mm 1 pc. 700-700-032 **P**



Needle

A 40mm / Ø 0.4mm 1 pc. 700-700-033 **P**



Needle, angled

A 40mm / Ø 0.4mm 1 pc. 700-700-034 **P**

HF SURGERY



ACTIVE MONOPOLAR ELECTRODES

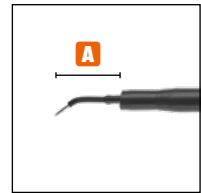
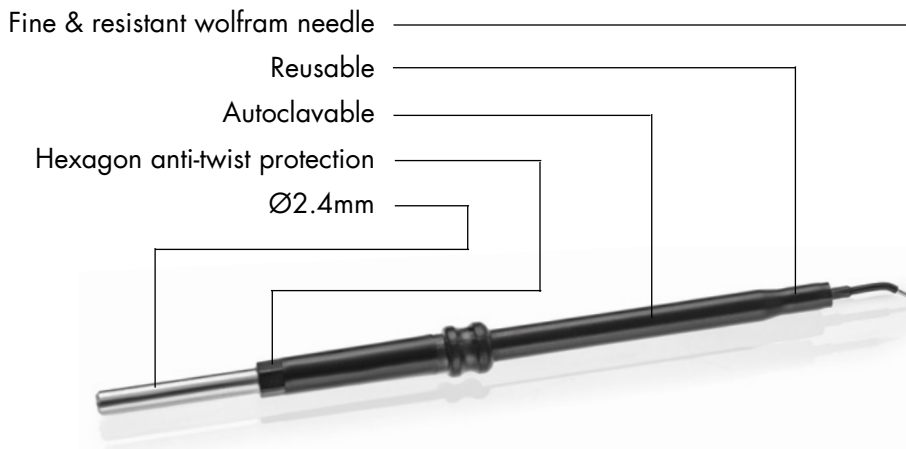

Needle

A 75mm / Ø 0.4mm 1 pc. 700-700-026



Needle, angled

A 75mm / Ø 0.4mm 1 pc. 700-700-027



Needle, straight

A 110mm / Ø 0.4mm 1 pc. 700-700-028



Needle, angled

A 110mm / Ø 0.4mm 1 pc. 700-700-029



ARGON ELECTRODES

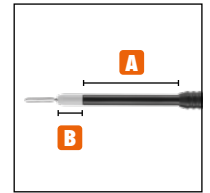
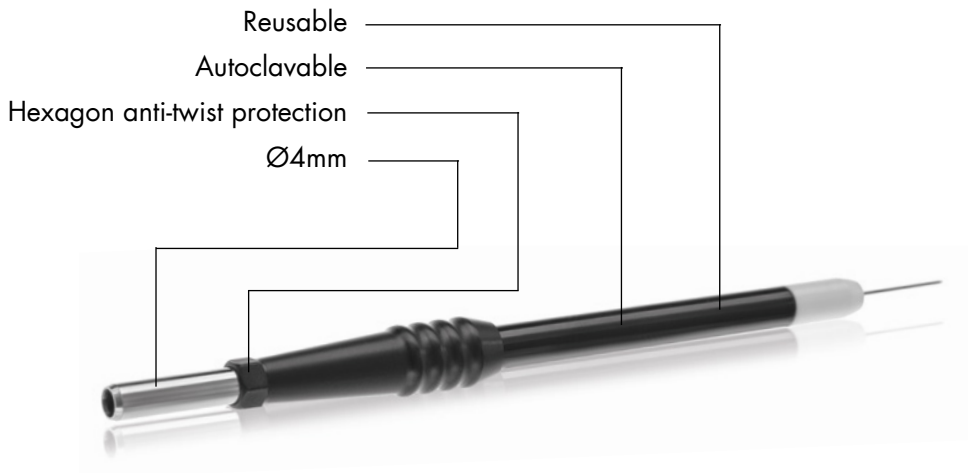

Monopolar Argon Electrode



- A** 75mm 1 pc. 700-557-075
- A** 150mm 1 pc. 700-557-150
- A** 350mm 1 pc. 700-557-350



Monopolar Argon Electrode with Needle



- A** 100mm **B** 14mm / Ø 0.4mm 1 pc. 700-557-100
- A** 180mm **B** 14mm / Ø 0.4mm 1 pc. 700-557-180



Monopolar Argon Electrode with Knife



- A** 100mm **B** 14mm / Ø 0.4mm 1 pc. 700-557-200
- A** 180mm **B** 14mm / Ø 0.4mm 1 pc. 700-557-210



Electrode container stainless steel
for storage or during sterilization



Sterilization Container for
Ø 4mm Electrodes

8 Electrodes holding capacity 1 pc. 700-700-002

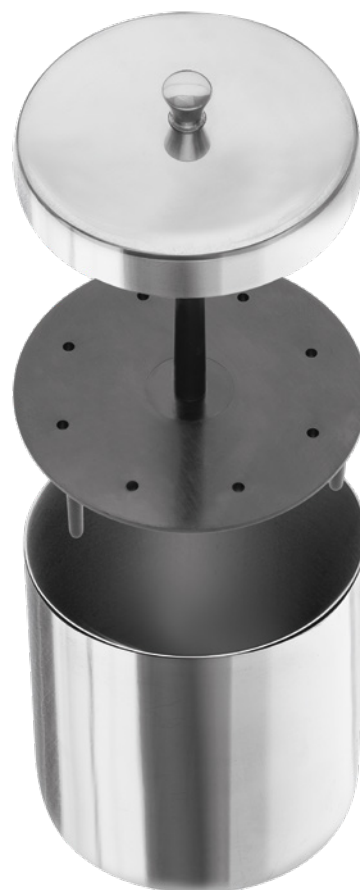

Sterilization Container for
Ø 2.4mm Electrodes

8 Electrodes holding capacity 1 pc. 700-700-001

NON-STICK FORCEPS

By using a polished noble material with excellent thermal properties for the forcep's tip, the undesired effect of sticking tissue is now completely eliminated and non-stop working is ensured.



Straight		150mm		180mm		200mm	220mm
		straight tips	angeld tips	straight tips	angeld tips	straight tips	straight tips
0.3mm tip (point)	flat plug	700-610-150	700-611-150	700-610-180	700-611-180	700-610-200	700-610-220
	2-pin	700-612-150	700-613-150	700-612-180	700-613-180	700-612-200	700-620-220
0.6mm tip (blunt)	flat plug	700-620-150	700-621-150	700-620-180	700-621-180	700-620-200	700-620-220
	2-pin	700-622-150	700-623-150	700-622-180	700-623-180	700-622-200	700-622-220
1.0mm tip (blunt)	flat plug	700-630-150	700-631-150	700-630-180	700-631-180	700-630-200	700-630-220
	2-pin	700-632-150	700-633-150	700-632-180	700-633-180	700-632-200	700-632-220
2.0mm tip (blunt)	flat plug	700-640-150	700-641-150	700-640-180	700-641-180	700-640-200	700-640-220
	2-pin	700-642-150	700-643-150	700-642-180	700-643-180	700-642-200	700-642-220



JEWELER TYPE		110mm	
		straight tips	angeld tips
0.25mm tip (point)	flat plug	700-601-710	700-601-730
	2-pin	700-601-711	700-601-731
0.6mm tip (blunt)	flat plug	700-601-712	700-601-732
	2-pin	700-601-713	700-601-733
1.0mm tip (blunt)	flat plug	700-601-714	700-601-734
	2-pin	700-601-715	700-601-735



straight tips

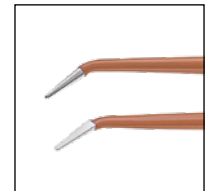

angled tips

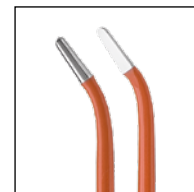

angled down tips

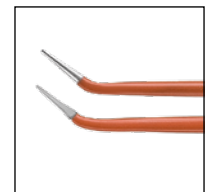

angled up tips

HF SURGERY



		180mm straight tips	200mm straight tips
Bayonet			
0.3mm tip (point)	flat plug	700-050-180	700-050-200
	2-pin	700-052-180	700-052-200
0.6mm tip (blunt)	flat plug	700-060-180	700-060-200
	2-pin	700-062-180	700-062-200
1.0mm tip (blunt)	flat plug	700-070-180	700-072-200
	2-pin	700-072-180	700-072-200
2.0mm tip (blunt)	flat plug	700-080-180	700-082-200
	2-pin	700-082-180	700-082-200
		225mm straight tips	250mm straight tips
Bayonet			
0.3mm tip (point)	flat plug	700-050-220	700-050-250
	2-pin	700-052-220	700-052-250
0.6mm tip (blunt)	flat plug	700-060-220	700-060-250
	2-pin	700-062-220	700-062-250
1.0mm tip (blunt)	flat plug	700-070-220	700-070-250
	2-pin	700-072-220	700-072-250
2.0mm tip (blunt)	flat plug	700-080-220	700-080-250
	2-pin	700-082-220	700-082-250



straight tips



Bayonet Shape		180mm straight tips	200mm straight tips	220mm straight tips	240mm straight tips
0.3mm tip (point)	flat plug	700-650-180	700-650-200	700-650-220	700-650-240
	2-pin	700-652-180	700-652-200	700-652-220	700-652-240
0.6mm tip (blunt)	flat plug	700-660-180	700-660-200	700-660-220	700-660-240
	2-pin	700-622-180	700-662-200	700-622-220	700-662-240
1.0mm tip (blunt)	flat plug	700-670-180	700-670-200	700-670-220	700-670-240
	2-pin	700-672-180	700-672-200	700-672-220	700-672-240
2.0mm tip (blunt)	flat plug	700-680-180	700-680-200	700-680-220	700-680-240
	2-pin	700-682-180	700-682-200	700-682-220	700-682-240

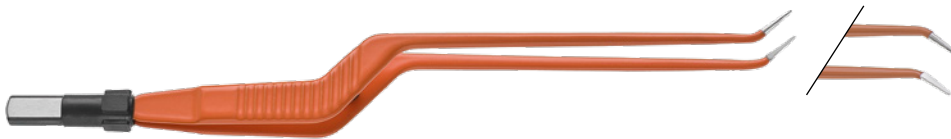

Bayonet Shape, angled up/angled down		200mm angled up tips	220mm angled up tips	200mm angled down tips	220mm angled down tips
1.0mm tip (blunt)	flat plug	700-670-201	700-670-221	700-670-203	700-670-223
	2-pin	700-672-201	700-672-221	700-672-203	700-670-223

HF SURGERY

BIPOLAR MICRO SCISSORS

RZ Micro Scissors are especially made for precise cutting when it comes to highly delicate surgery. Its thin scissors blades area major advantage e.g. for plastic and reconstructive surgery.



Short Scissors, curved, slim and thin blades

130mm

120-742-130



Medium Scissors, curved, slim and thin blades

140mm

120-742-140

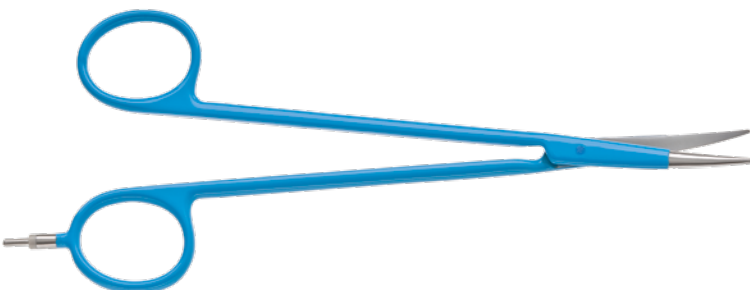

Long Scissors, curved, slim and thin blades

175mm

120-742-175

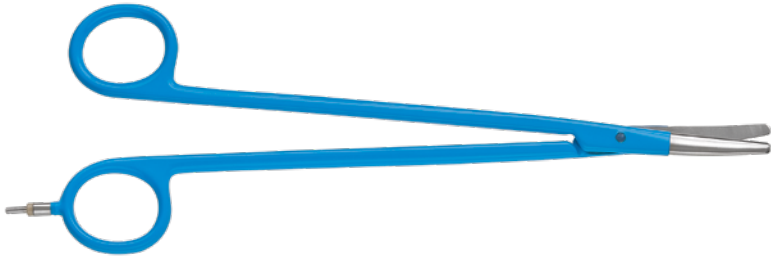

curved blades

Bipolar Scissors, curved blades

180mm	120-740-180
210mm	120-740-210
230mm	120-740-230
280mm	120-740-280

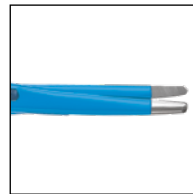

slim curved blades

Bipolar Scissors, **slim** curved blades

180mm	120-741-180
210mm	120-741-210
230mm	120-741-230
280mm	120-741-280

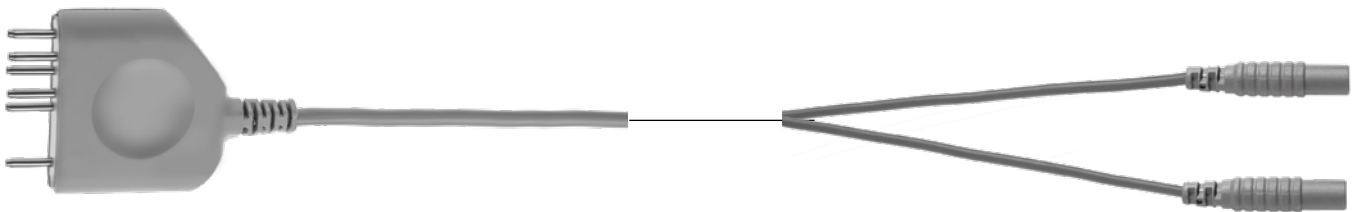

SDS Plug, pre-coded.
G400 Unit identifies
Instrument automatically

For bipolar Scissors-Forceps

3m

700-500-302

TheRZeal INSTRUMENTS

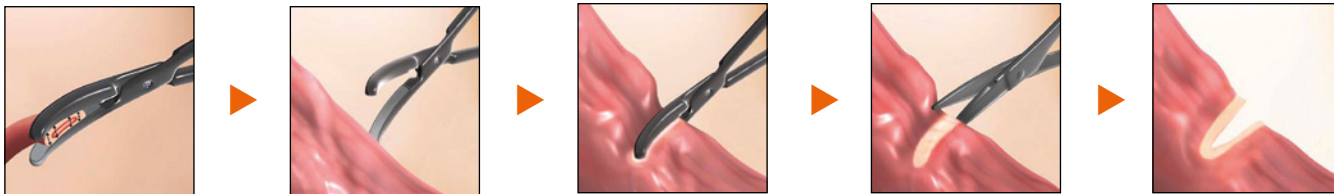

This special bipolar forceps is a combination of a thermal effect, obtained due to the use of especially modulated high frequency current with a mechanical pressure of the clamps. The result is a permanent sealing of the vessel membranes and tissue structures.

The vessel can easily be cut with the use of surgical scissors without the risk of bleeding. Vessels closed with the use of the RZ system are capable of withholding significant pressure. The safety of the closure with the use of the RZ system is comparable to the one obtained with the use of other mechanical methods.



Bipolar „TheRZeal“ Clamp, curved jaws

230mm

700-730-230

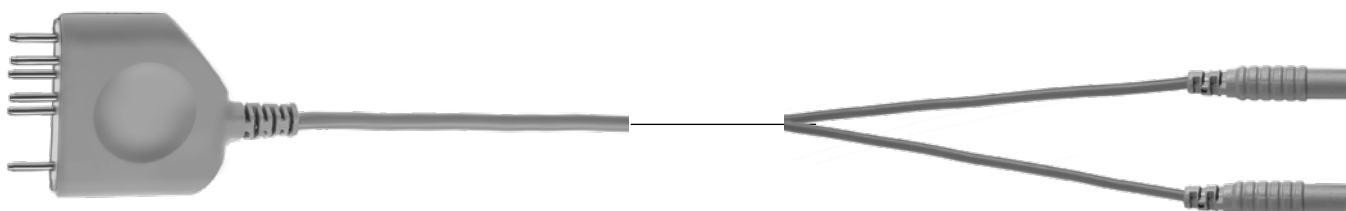

SDS Plug, pre-coded.
G400 Unit identifies
Instrument automatically

For bipolar Scissors-Forceps

3m

700-500-302

BIPOLAR BALL ELECTRODES

- Specially designed for coagulation even in smallest cavities at diffusely bleeding areas (e.g. nose)
- Shaft Diameter only 2mm, coagulation area approx. 2.5mm, depth approx. 0.5mm
- Two electrical poles form a divided cupola on the working tip
- Very low generator power necessary (approx. 10 Watts), thermal tissue damage is strongly reduced
- Standard flat plug design for use with all common bipolar cables and generators
- Completely reusable, autoclavable, no dismantling necessary, cost-efficient usage
- Three shapes available, one malleable to bent individually for any anatomical incident



Bipolar Coagulation Electrode, Bayonet shape

130mm working length

700-770-130



Bipolar Coagulation Electrode, straight, malleable

140mm working length

700-770-140

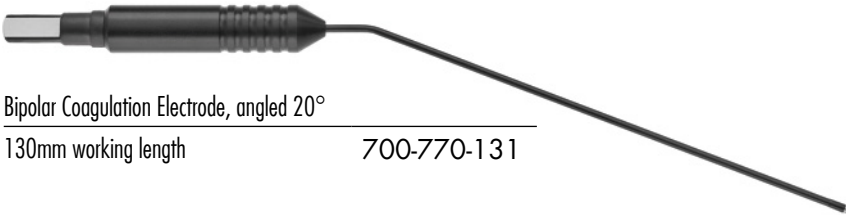

Bipolar Coagulation Electrode, angled 20°

130mm working length

700-770-131

BIPOLAR ENT ELECTRODES

RZ ENT electrodes are available for different applications; the slim and anatomical shape of these instruments as well as an atraumatic tip design offer a real alternative to forceps or monopolar electrodes in ENT.

High technology materials make the electrodes reusable and autoclavable.



Bipolar ENT Electrode, for tonsils

130mm working length

700-420-001

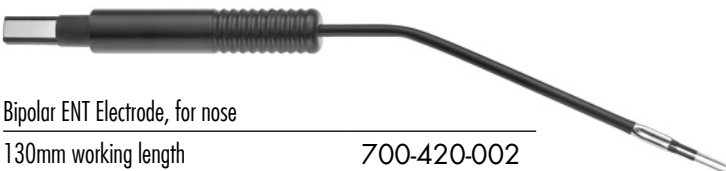

Bipolar ENT Electrode, for nose

130mm working length

700-420-002

HF SURGERY

DETACHABLE BIPOLAR FORCEPS

- 360° rotatable
- Consists of forceps body & shaft - without electrode

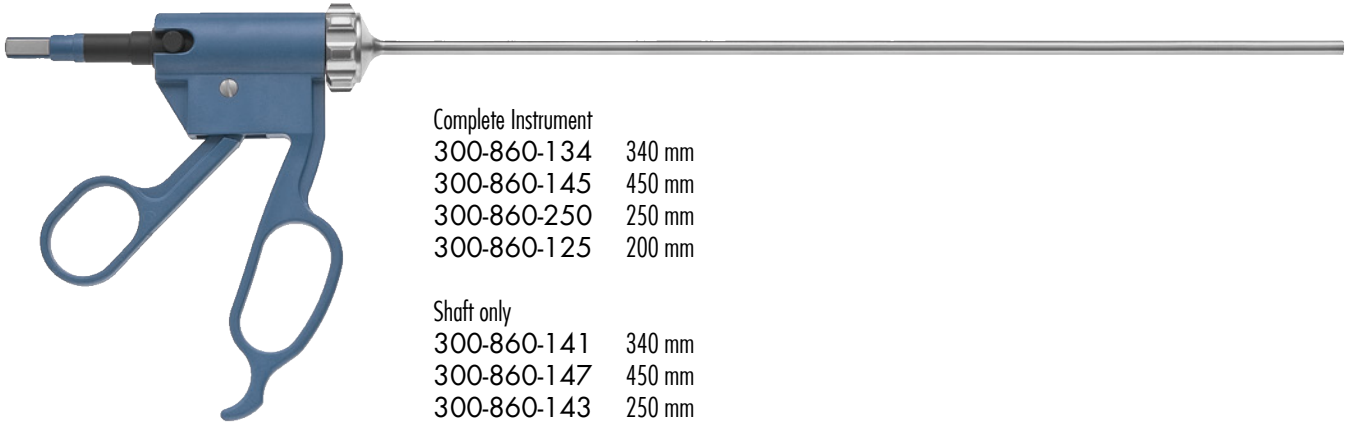

Complete Instrument	
300-860-134	340 mm
300-860-145	450 mm
300-860-250	250 mm
300-860-125	200 mm

Shaft only	
300-860-141	340 mm
300-860-147	450 mm
300-860-143	250 mm
300-860-142	200 mm

Handle only	
300-860-140	

DETACHABLE 720° ROTATABLE BIPOLAR FORCEPS

- 720° rotatable, independently of the shaft
- Consists of forceps body & shaft - without electrode

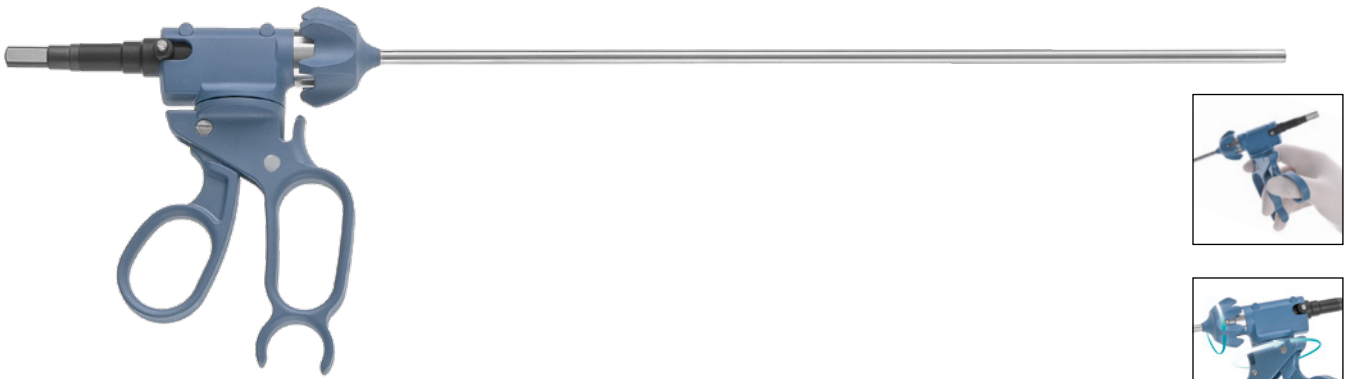









Complete Instrument	
300-860-534	340 mm
300-860-545	450 mm

Shaft only	
300-560-535	340 mm
300-560-546	450 mm

Handle only, with adjustment (rotating stop)	
300-860-500	

POWERGRIP BIPOLAR ELECTRODE INSERTS

- Insulated up to the end of the working zone
- Ø 5mm

	Grasping Forceps, fenestrated jaws, curved	300-860-009	340 mm
	Grasping Forceps, fenestrated jaws, serrated	300-860-013 300-860-023 300-860-063	340 mm 450 mm 200 mm
	Grasping Forceps, slightly curved	300-860-011 300-860-021 300-860-061	340 mm 450 mm 250 mm
	Powergrip Bipolar Forceps, 2x3 teeth	300-860-012	340 mm
	Delta Grasping Forceps, double action	300-860-014 300-860-024	340 mm 450mm
	Grasping Forceps, curved	300-860-015 300-860-025 300-860-065	340 mm 450 mm 200 mm
	Duckbill Forceps	300-860-016 300-860-026	340 mm 450 mm
	TC-Metzenbaum Scissors	300-860-018 300-860-028 300-860-068	340 mm 450 mm 200 mm
	Maryland Insert	300-860-019* 300-860-029 300-860-069	340 mm 450 mm 200 mm

HF SURGERY

POWERGRIP PREMIUM BIPOLAR ELECTRODE INSERTS



- Joint mechanism stays in place
- Insulated up to the end of the working zone
- Ø 5mm

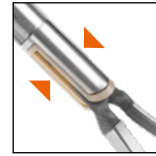

Premium model -
joint mechanism
stays in place



Standard model -
joint mechanism
exposes

	Grasping Forceps, fenestrated jaws, curved	300-860-009	340 mm
		300-860-032	340 mm
		300-860-033	340 mm
		300-860-035	340 mm
		300-860-037	340 mm
		300-860-040	340 mm

3mm DETACHABLE BIPOLAR FORCEPS

- Small diameter, equal performance
- One-finger control of the 360° rotation wheel
- Overload protection and direct force transmission
- Flat plug for common bipolar cables

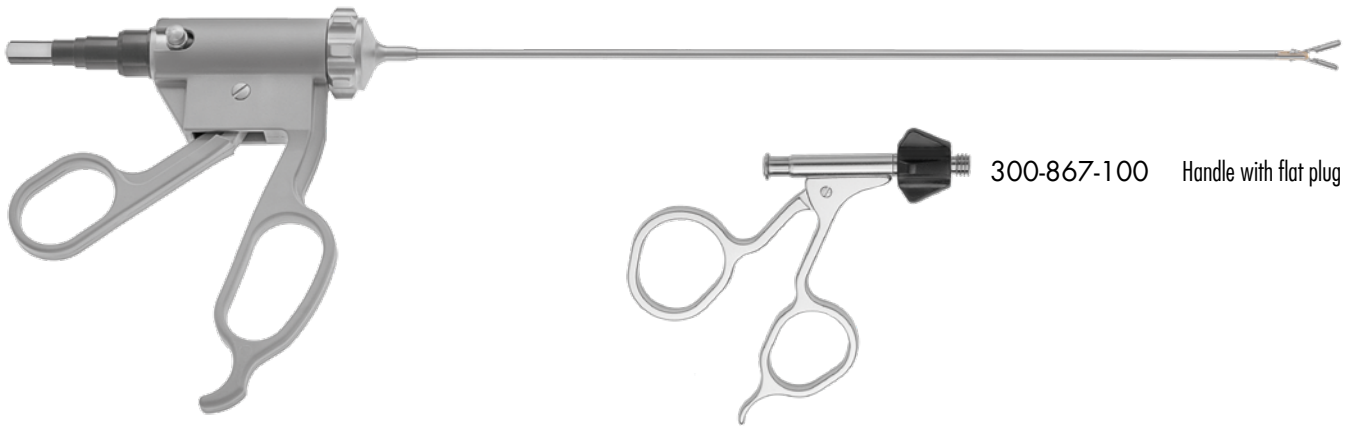

Shaft, \varnothing 3mm
 300-867-129 290mm
 300-867-120 200mm



Grasping Forceps, fenestrated

300-867-529 290mm
 300-867-520 200mm



Maryland Forceps, curved

300-867-929 290 mm
 300-867-620 200 mm



Micro Forceps

300-867-729 290 mm
 300-867-720 200 mm

HF SURGERY

BIPOLAR FORCEPS SYSTEM, Ø 5mm

- Detachable
- Consists of forceps body, inner & outer tube - without electrode

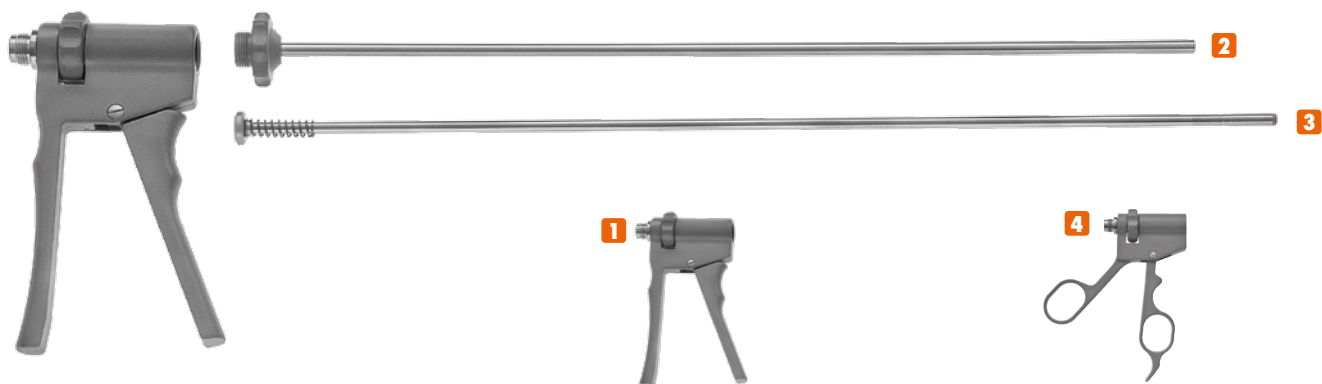

With standard handle **1**

300-855-034	340 mm
300-855-045	450 mm
300-855-020	200 mm

With ring handle **4**

300-855-134	340 mm
300-855-145	450 mm
300-855-120	200 mm

1



Forceps body standard
300-855-001

4



Forceps body ring handle
300-855-101

3

Outer Tube **2**

300-855-007	340 mm
300-855-052	450 mm
300-855-003	200 mm

Inner tube **3**

300-855-006	340 mm
300-855-051	450 mm
300-855-002	200 mm



Bipolar Cables, length: 3m
2 banana plug 300-855-100
Valleylab plug 300-855-105
Martin plug 300-855-102
Erbe plug 300-855-103



Adapter for bipolar cable
300-855-400 with flat plug
300-855-401 with 2-pin-plug

Electrodes / Inserts

	Tubal ligation	300-855-010	340 mm
		300-855-022	450 mm
		300-855-060	200 mm
	Micro jaw, 1 mm	300-855-011	340 mm
		300-855-021	450 mm
		300-855-061	200 mm
	Grasping forceps, 3 mm	300-855-015	340 mm
		300-855-025	450 mm
		300-855-065	200 mm
	Scissors, curved	300-855-017	340 mm
		300-855-027	450 mm
		300-855-067	200 mm
	Kleppinger, serrated	300-855-013	340 mm
		300-855-023	450 mm
		300-855-063	200 mm
	Scissors with TC blades, curved	300-855-018	340 mm
		300-855-028	450 mm
	Dissector Maryland, curved	300-855-019	340 mm
		300-855-029	450 mm
		300-855-069	200 mm

MICRO BIPOLAR SYSTEM, Ø 3mm

- Suits for all operations in Laparoscopy
- Especially for fine coagulation of tissue and small vessels
- Easy detachable for cleaning purposes



300-857-100 Bipolar Micro Coagulation Forceps, Ø 3mm

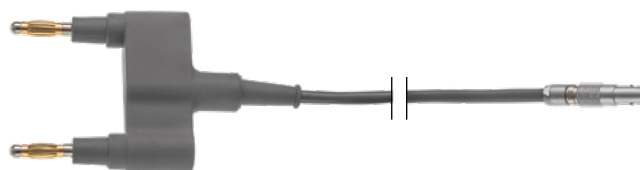

300-857-205
Cable only for 300-857-100

Electrode Inserts



Micro Electrode, rippled bar

300-857-111



Micro Electrode, fluted tip, 1mm

300-857-112



Bipolar Micro Electrodes, 3 mm



Bipolar L-Hook

300-857-301



Bipolar V-Hook

300-857-302



Bipolar Needle

300-857-303



RZ Medizintechnik GmbH

Unter Hasslen 20
78532 Tuttlingen, Germany

Phone: +49 (0)7462/9470-0
Fax: +49 (0)7462/9470-50

sales@rz-medizintechnik.com
www.rz-medizintechnik.com

