

INDEX

Sets	2 - 20
Cystoscopy	21 - 38
Resectoscopy	39 - 64
Laser Enucleation	65 - 77
Urethrotome	78 - 82
Lithotripsy	83 - 87
Nephroscopy	88 - 96
Uretero - Renoscopy	97 - 102
Pediatric	103 - 112
Devices and Flexible Instruments	113 - 115
Accessories	116 - 121
Cleaning	122 - 130
Equipment	131 - 146



Products marked with this symbol are not available with RZ-marking, and not the CE sign/CE number of RZ.



RZ-Topseller products

All products marked with this green star are available on stock.

CONFIGURATIONS by RZ Cystoscope Set for adults

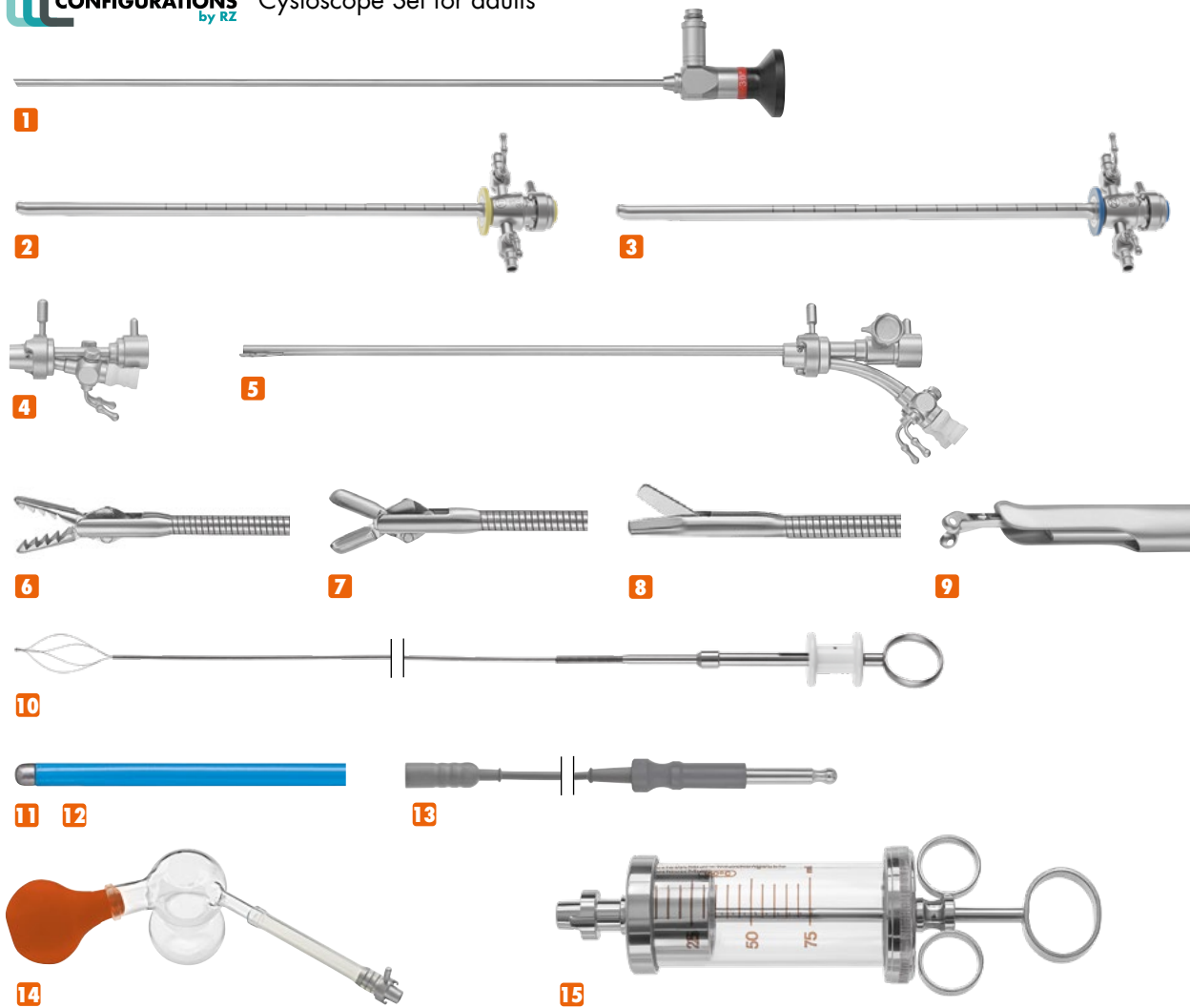

253-900-900 Cystoscope Set for adults

1	RZ Cystoscope, 30°, Ø 4.0mm	253-804-030	1 pc.
2	Cysto-Urethroscope Sheath 17 Charr.	253-300-017	1 pc.
3	Cysto-Urethroscope Sheath 22 Charr.	253-300-022	1 pc.
4	Bridge with 2 channels for 1 instrument with max. 12 Charr. or 2 instruments with max. 8 Charr.	253-000-102	1 pc.
5	Albarran deflecting mechanism with 2 working channels and ratchet	253-000-105	1 pc.
6	Flexible Grasping Forceps, serrated jaws, double action	351-114-107	1 pc.
7	Biopsy Forceps, oval cup, serrated jaws, double action	351-120-107	1 pc.
8	Scissors, single action	351-100-105	1 pc.
9	Spoon Biopsy Forceps with round cup, double action	253-420-100	1 pc.
10	Dormia Metal Stone Basket, flexible, 4 wires, 600mm working length, 5 Charr.	253-585-005	1 pc.
11	Ball Electrode 530mm working length, 5 Charr.	253-370-005	1 pc.
12	Ball Electrode 530mm working length, 7 Charr.	253-370-007	1 pc.
13	Monopolar Cable with 8 mm plug for Valleylab HF-unit	253-610-003	1 pc.
14	Elik Evacuator with turn lock connection	253-500-000	1 pc.
15	Bladder Syringe, 150cc	253-000-950	1 pc.

CONFIGURATIONS by RZ Cystoscope Set for children

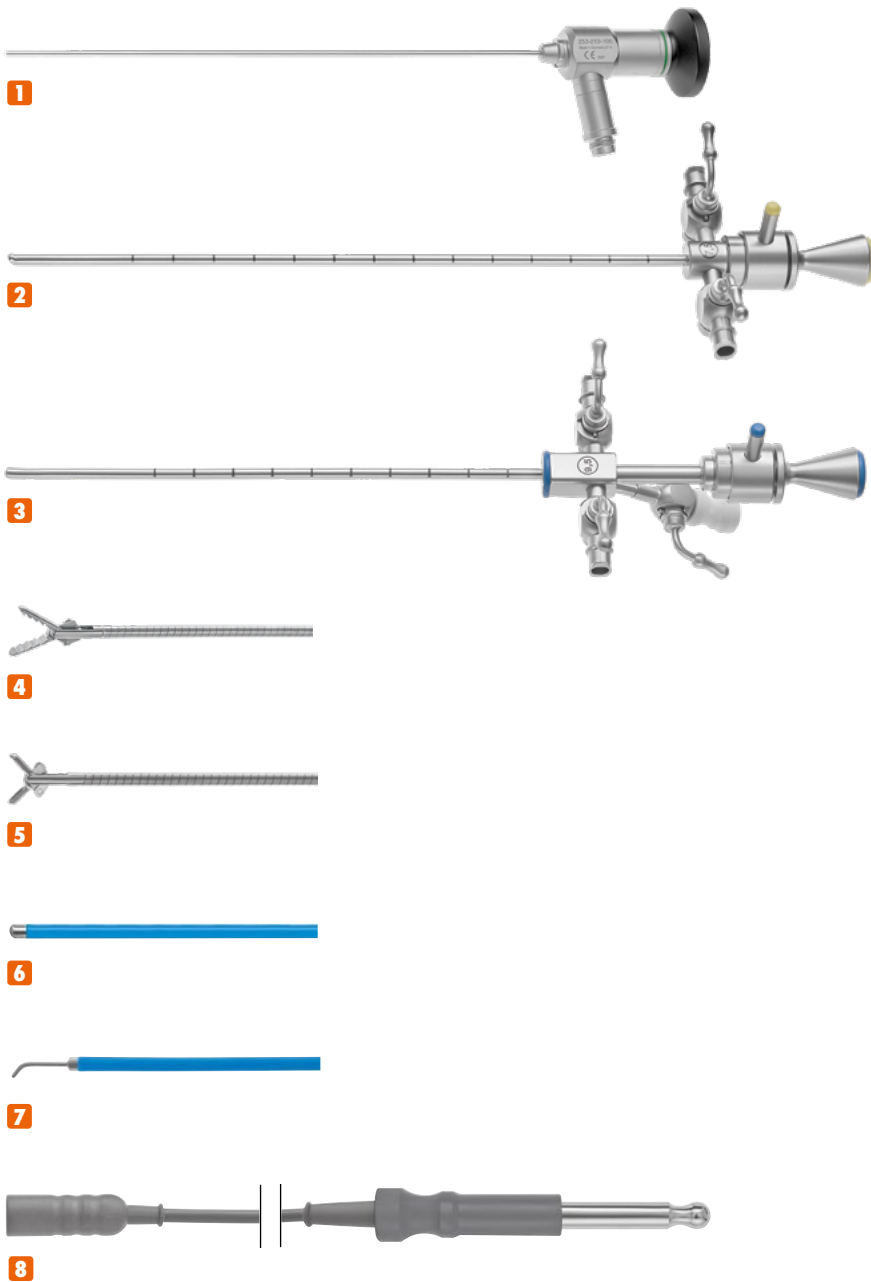

253-900-918 Cystoscope Set for children

1	RZ Pediatric Fiber Cystoscope, 30°, Ø 2.0mm	253-219-130	1 pc.
2	Pediatric Cystoscope Sheath 7.5 Charr.	253-200-075	1 pc.
3	Pediatric Cystoscope Sheath 9.5 Charr.	253-200-095	1 pc.
4	Alligator grasping forceps, 28cm length, 3 Charr.	253-202-003	1 pc.
5	Biopsy forceps, 28cm length, 3 Charr.	253-204-003	1 pc.
6	Ball electrode, 25cm length, 3 Charr.	253-370-253	1 pc.
7	Needle electrode, 25cm length, 3 Charr.	253-371-253	1 pc.
8	Monopolar Cable with 8 mm plug for Valleylab HF-unit	253-610-003	1 pc.

CONFIGURATIONS by RZ Cystoscope Set for (newborn) babies

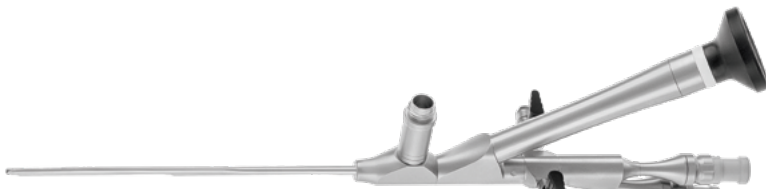

1



2



3



4



5



6



7



8

253-900-919 Cystoscope Set for (newborn) Babies

1	Operating Cysto-Urethrotome 4.5 Charr., 5° direction of view	253-200-600	1 pc.
2	Stone Grasping Forceps, double action, 3 Charr.	253-203-128	1 pc.
3	Biopsy Forceps, double action, 3 Charr.	253-203-328	1 pc.
4	Scissors, single action, 3 Charr.	253-203-428	1 pc.
5	Ball Electrode, 3 Charr.	253-370-253	1 pc.
6	Needle electrode, 3 Charr.	253-371-253	1 pc.
7	Hook Knife, 3 Charr.	253-200-200	1 pc.
8	Injection Cannula, 3 Charr.	253-200-210	1 pc.

CONFIGURATIONS by RZ 26 Charr. Monopolar Resectoscope Set for adults

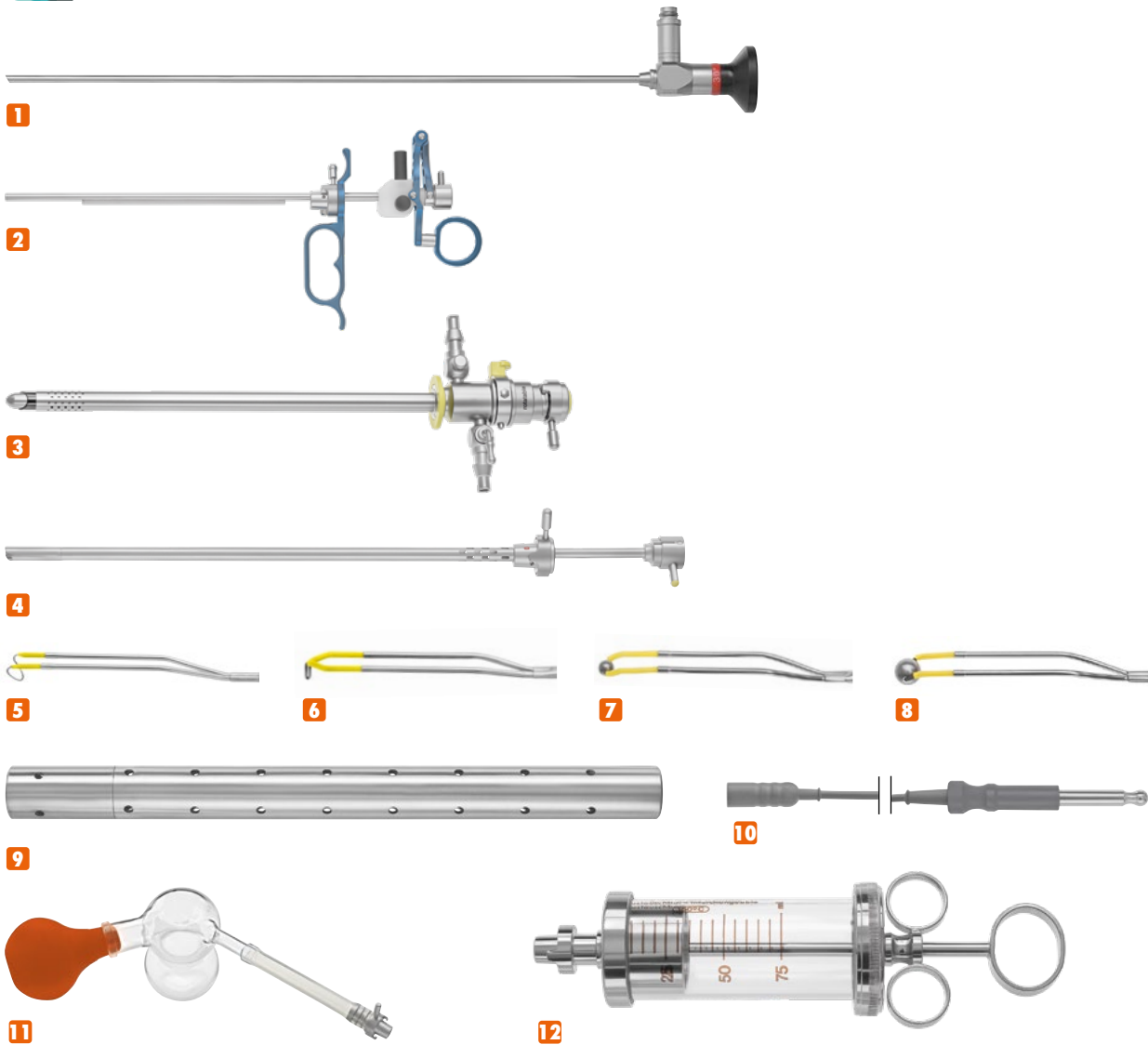

253-900-901 26 Charr. Monopolar Resectoscope Set for adults

1	RZ Cystoscope, 30°, Ø 4.0mm	253-804-030	1 pc.
2	Passive Titanium working element	253-000-200	1 pc.
3	Continuous Flow Resectoscope Sheath, 26 Charr., with obturator	253-000-256	1 pc.
4	Visual Obturator for 4mm RZ Cystoscopes	253-000-084	1 pc.
5	Cutting Loop, angled, for 12°/30° telescope	253-300-201	1 pc.
6	Coagulation Electrode, pointed	253-300-203	1 pc.
7	Coagulation Electrode, ball shape, Ø 3mm	253-300-205	1 pc.
8	Coagulation Electrode, ball shape, Ø 5mm	253-300-206	1 pc.
9	Sterilization tubes for electrodes	253-300-999	1 pc.
10	Monopolar Cable with 8 mm plug for Valleylab HF-unit	253-610-003	1 pc.
11	Ellik Evacuator with turn lock connection	253-500-000	1 pc.
12	Bladder Syringe, 150cc	253-000-950	1 pc.



Monopolar Resectoscope Set for children

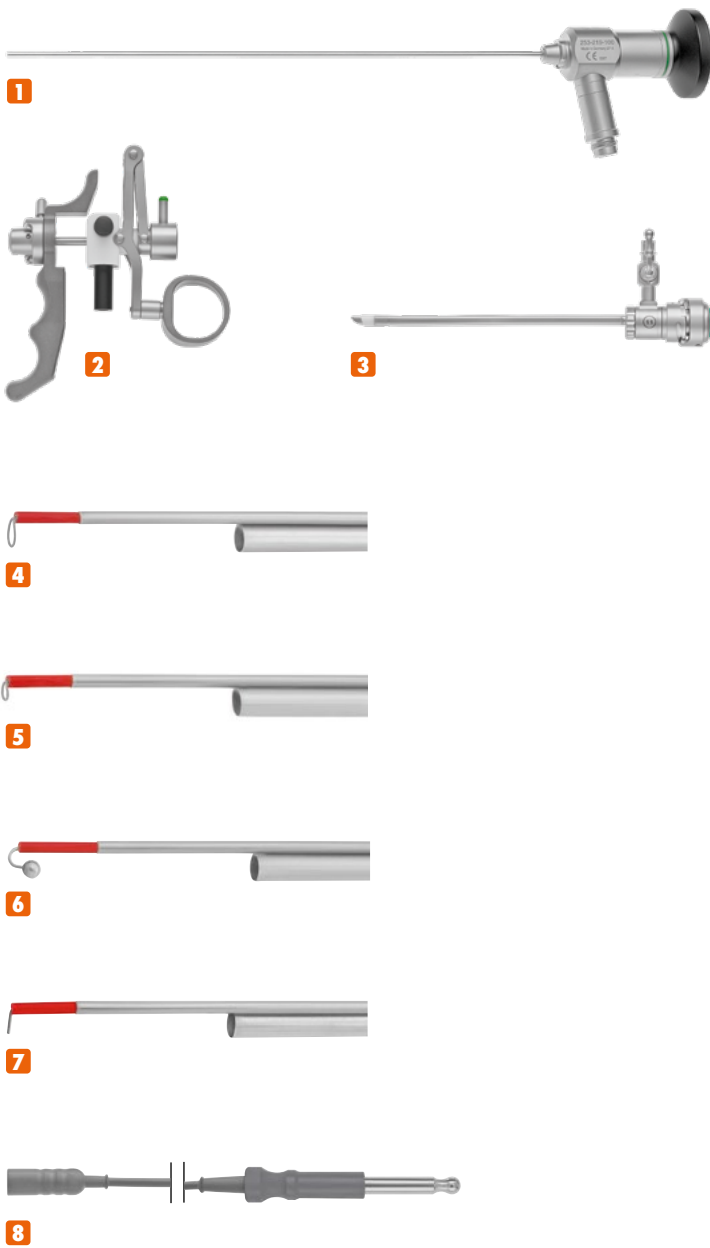

253-900-905 Monopolar Resectoscope Set for children

1	RZ Pediatric Fiber Cystoscope, 0°, Ø 2.0mm	253-219-100	1 pc.
2	Passive Titanium working element	253-250-200	1 pc.
3	Resectoscope Sheath 11 Charr. with obturator	253-250-211	1 pc.
4	Cutting Loop Electrode, 11 Charr.	253-251-111	1 pc.
5	Coagulation Electrode, 11 Charr.	253-251-112	1 pc.
6	Hook Electrode with ball, 11 Charr.	253-251-113	1 pc.
7	Needle Electrode, pointed, 11 Charr.	253-251-115	1 pc.
8	Monopolar Cable with 8 mm plug for Valleylab HF-unit	253-610-003	1 pc.

CONFIGURATIONS by RZ 26 Charr. Bipolar (HYBRID) Resectoscope Set for adults

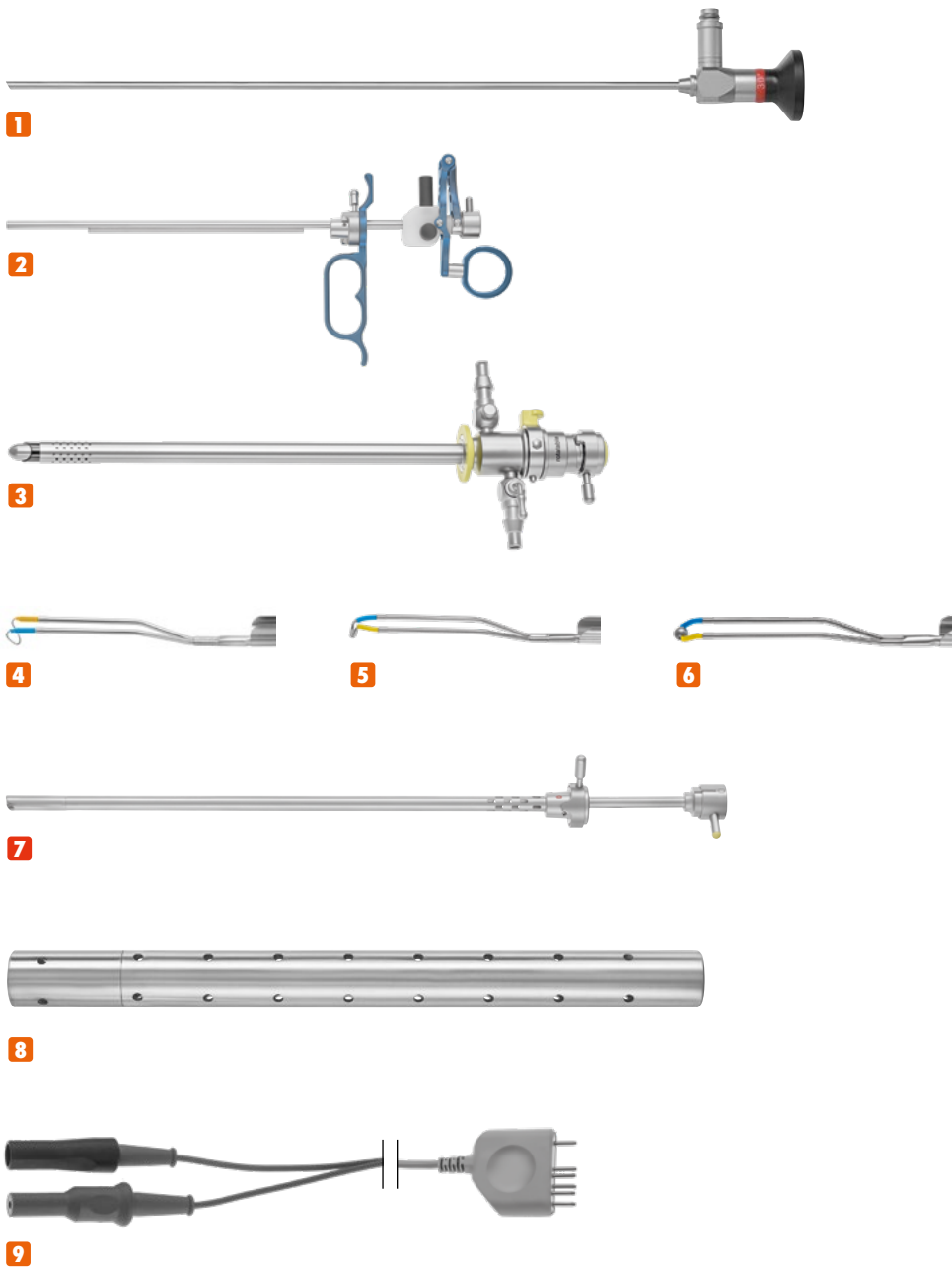

253-900-911 26 Charr. Bipolar (HYBRID) Resectoscope Set for adults

1	RZ Cystoscope, 30°, Ø 4mm	253-804-030	1 pc.
2	Passive HYBRID working element	253-000-400	1 pc.
3	Continuous Flow Resectoscope Sheath, 26 Charr.	253-000-256	1 pc.
4	Cutting Electrode	253-400-201	1 pc.
5	Collins Coagulation Electrode	253-400-203	1 pc.
6	Ball Electrode	253-400-205	1 pc.
7	Visual Obturator, with 6 Charr. working channel	253-000-094	1 pc.
8	Sterilization tube for electrodes	253-300-999	1 pc.
9	SDS Cable, 4.5m, bipolar	700-500-453	1 pc.

CONFIGURATIONS by RZ 22 Charr. Bipolar (HYBRID) Resectoscope Set

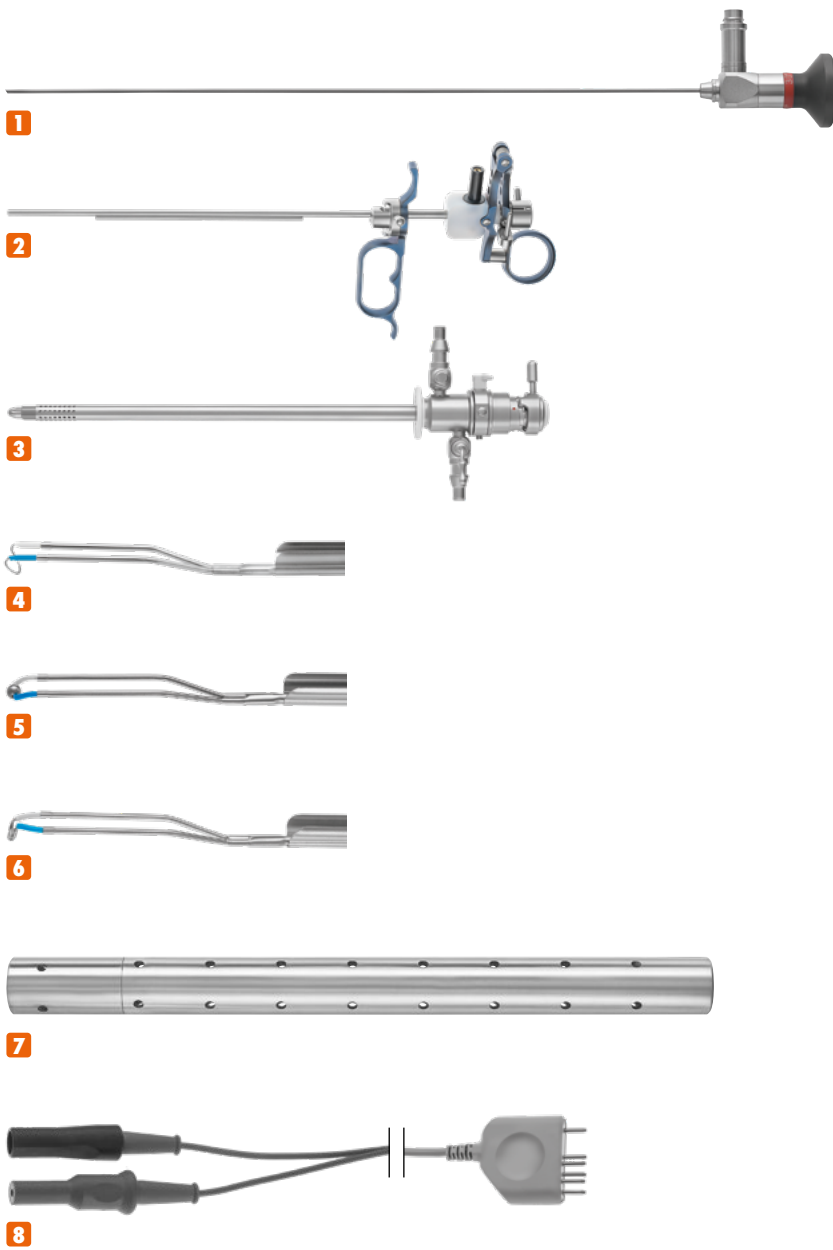

22 Charr. Hybrid Resectoscope Set

1	RZ Rod Lens Cystoscope, 30°, Ø 2.9mm	351-829-030	1 pc.
2	Passive Titanium Working Element	253-000-410	1 pc.
3	Resectoscope Sheath, 22 Charr., rotating inner tube, for continuous suction / irrigation	253-000-352	1 pc.
4	Loop Electrode, 30° angled	253-000-541	1 pc.
5	Ball Electrode	253-000-545	1 pc.
6	Knife Electrode	253-000-543	1 pc.
7	Storage container for knives and electrodes, metal, perforated	253-300-999	1 pc.
8	SDS Cable, 4.5m, bipolar	700-500-453	1 pc.



18.5 Charr. Bipolar (HYBRID) Resectoscope Set

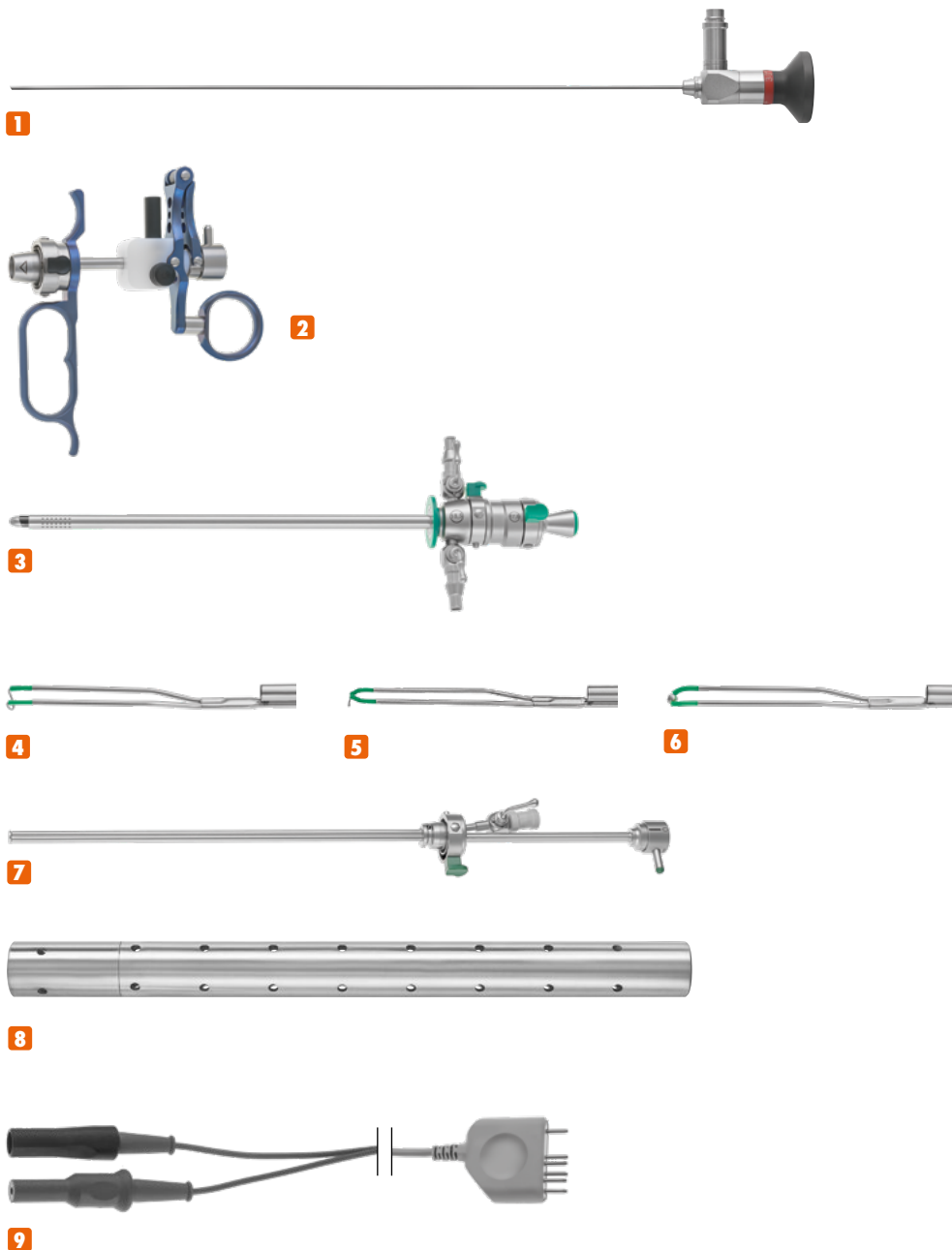

253-900-921 18.5 Charr. Bipolar (HYBRID) Resectoscope Set for adults and adolescents

1	RZ Cystoscope, 30°, Ø 2.9mm	253-829-030	1 pc.
2	Passive HYBRID working element	351-400-200	1 pc.
3	Continuous Flow Resectoscope Sheath, 18.5 Charr.	351-000-185	1 pc.
4	Loop Electrode	351-000-201	1 pc.
5	Knife Electrode	351-000-203	1 pc.
6	Ball Electrode	351-000-205	1 pc.
7	Visual Obturator, with 5 Charr. working channel	351-000-180	1 pc.
8	Sterilization tube for electrodes	253-300-999	1 pc.
9	SDS Cable, 4.5m, bipolar	700-500-453	1 pc.



HoLEP Laser Resectoscope Set according to Dr. Felipe C. A. de Figueiredo

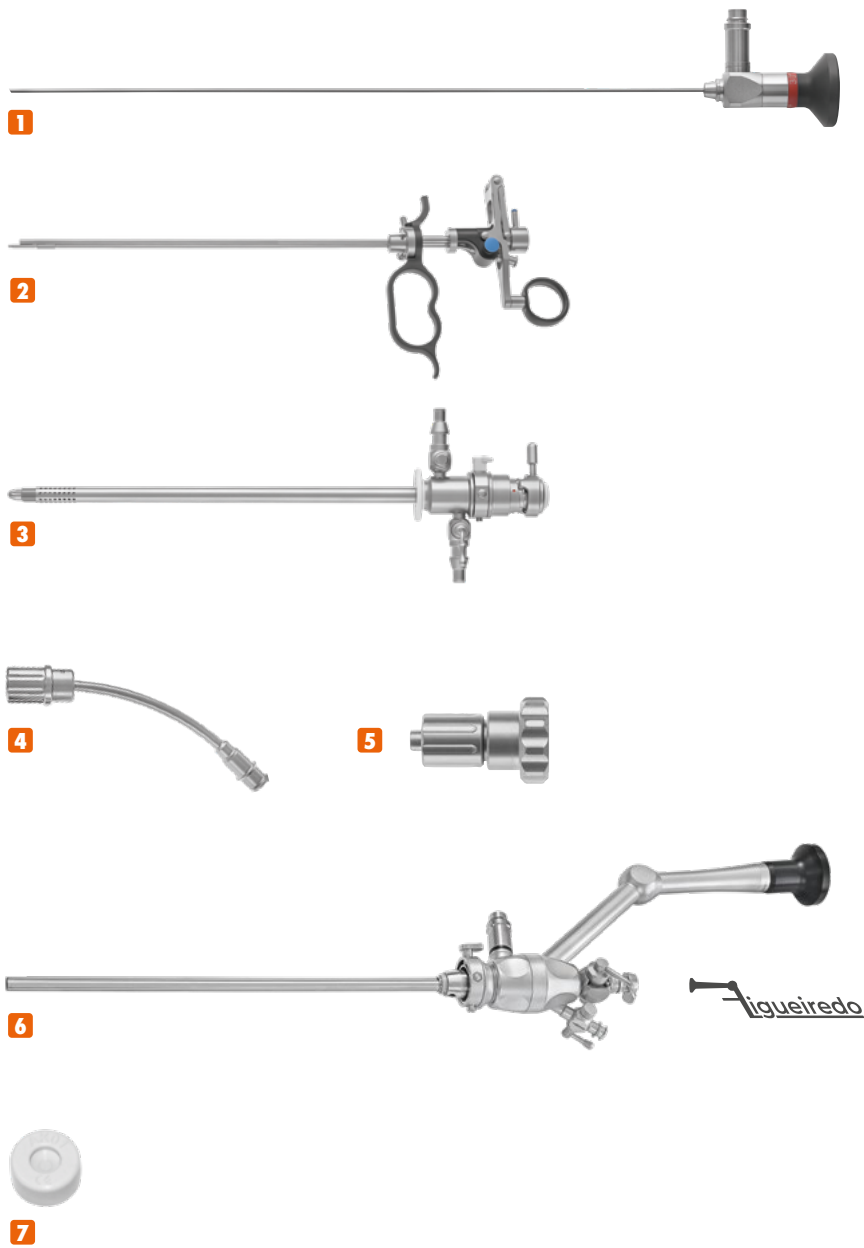

Laser Resectoscope Set according to Dr. Felipe C. A. de Figueiredo

1	RZ Rod Lens Cystoscope, 30°, Ø 2.9mm	351-829-030	1 pc.
2	RZ Laser Working Element, passive, for fibres up to 0.8mm	253-000-319	1 pc.
3	Resectoscope Sheath, 22 Charr., rotating inner tube, for continuous suction / irrigation	253-000-352	1 pc.
4	RZ LL-Connection, rotatable, for use with Laser Probe, short	253-000-301	1 pc.
5	Luer-Lock Tuohy Borst Adapter (Ø 0.6 - 1.4mm)	300-011-184	1 pc.
6	Morcescope, 22 Charr., 220mm working length, 5mm working channel	253-905-220	1 pc.
7	Sealing Cap for Morcescope, package of 10 pieces	253-904-220	1 pc.

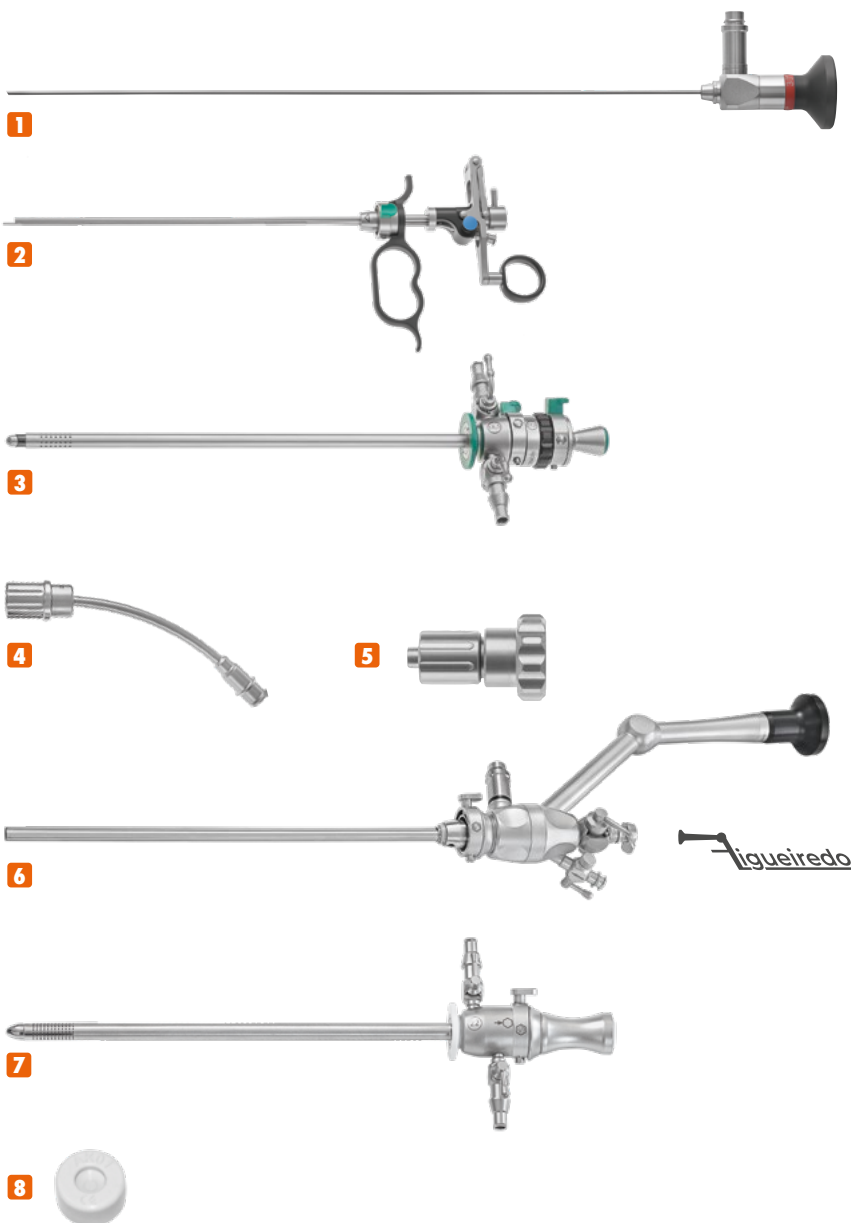

Laser Resectoscope Set according to Dr. Felipe C. A. de Figueiredo

1	RZ Rod Lens Cystoscope, 30°, Ø 2.9mm	351-829-030	1 pc.
2	RZ Laser Working Element, passive, for fibres up to 0.8mm, with push button	253-000-318	1 pc.
3	Resectoscope Continuous Flow Sheath, 18.5 Charr.	351-000-185	1 pc.
4	RZ LL-Connection, rotatable, for use with Laser Probe, short	253-000-301	1 pc.
5	Luer-Lock Tuohy Borst Adapter (Ø 0.6 - 1.4mm)	300-011-184	1 pc.
6	Morcescope, 22 Charr., 220mm working length, 5mm working channel	253-905-220	1 pc.
7	Continuous Flow Sheath, 22 Charr.	253-901-220	1 pc.
8	Sealing Cap for Morcescope, package of 10 pieces	253-904-220	1 pc.



HoLEP Set

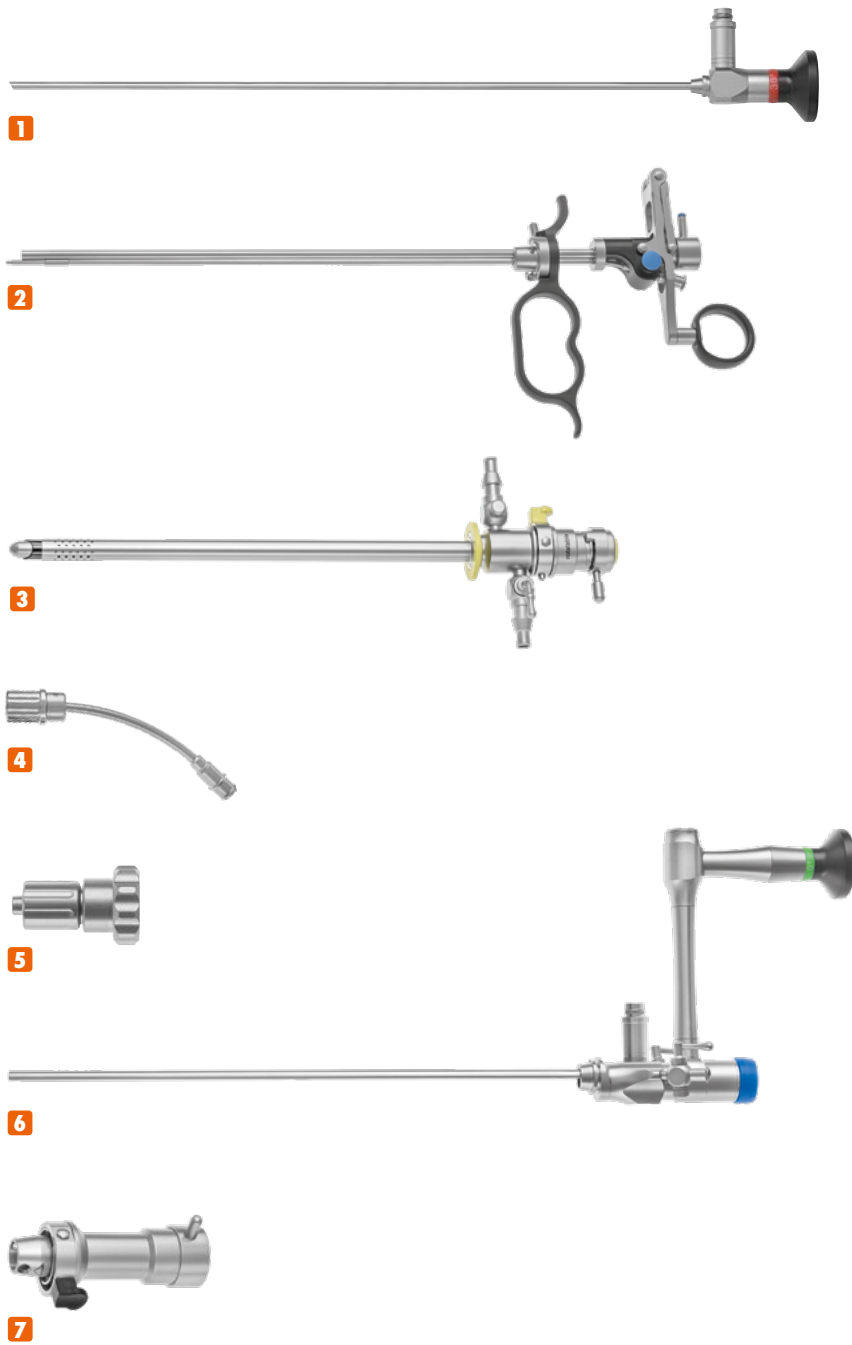

253-900-920 HoLEP Set

1	RZ Cystoscope, 30°, Ø 4.0mm	253-804-030	1 pc.
2	RZ Laser Working Element, passive, for laser-probes	253-000-312	1 pc.
3	Continuous Flow Resectoscope Sheath, 26 Charr.	253-000-256	1 pc.
4	RZ LL-Connection	253-000-302	1 pc.
5	Luer-Lock Tuohy Borst Adapter	300-011-184	1 pc.
6	Nephroscope 6°	253-900-121	1 pc.
7	Adapter for Resectoscope outer sheath 253-000-256	253-428-100	1 pc.

CONFIGURATIONS by RZ Urethrotome Set for adults

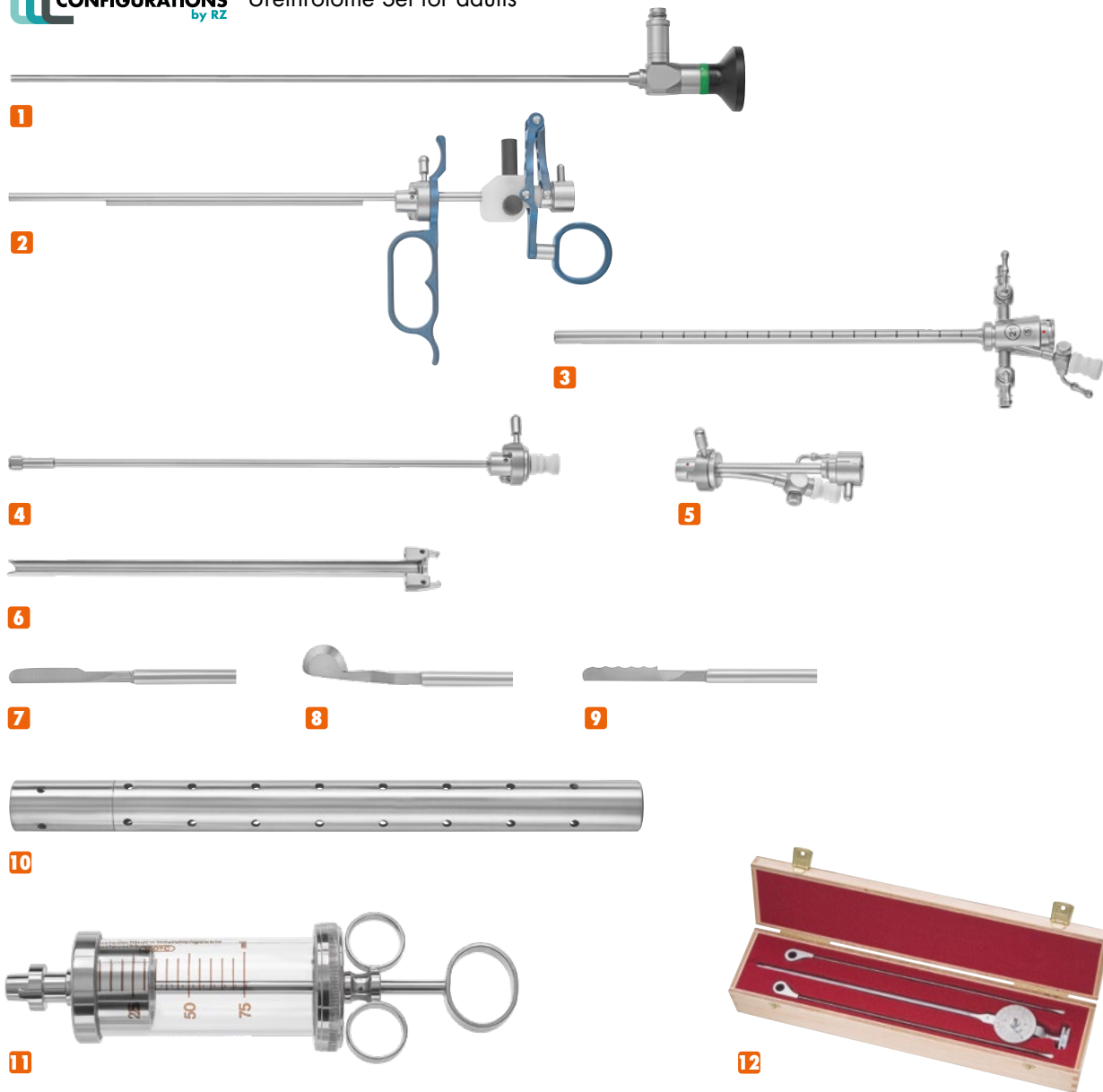

253-900-902 Urethrotome Set for adults

1	RZ Cystoscope, 0°, Ø 4.0mm	253-804-000	1 pc.
2	Passive Titanium Working Element	253-000-200	1 pc.
3	Urethrotome Sheath oval shape, 21 Charr.	253-500-221	1 pc.
4	Hollow Obturator with channel for guide wires	253-500-321	1 pc.
5	Bridge with channel for 5 Charr. accessories	253-500-325	1 pc.
6	Supplementary Sheath, half round	253-500-230	1 pc.
7	Sachse knife, straight	253-500-561	3 pcs.
8	Half round knife, 180° cutting	253-500-563	2 pcs.
9	WaveCut knife, straight	253-500-564	1 pc.
10	Sterilization tube for electrodes	253-300-999	1 pc.
11	Bladder Syringe, 150cc	253-000-950	1 pc.
12	OTIS Dilation Urethrotome, complete	253-500-100	1 pc.



Urethrotome Set for children

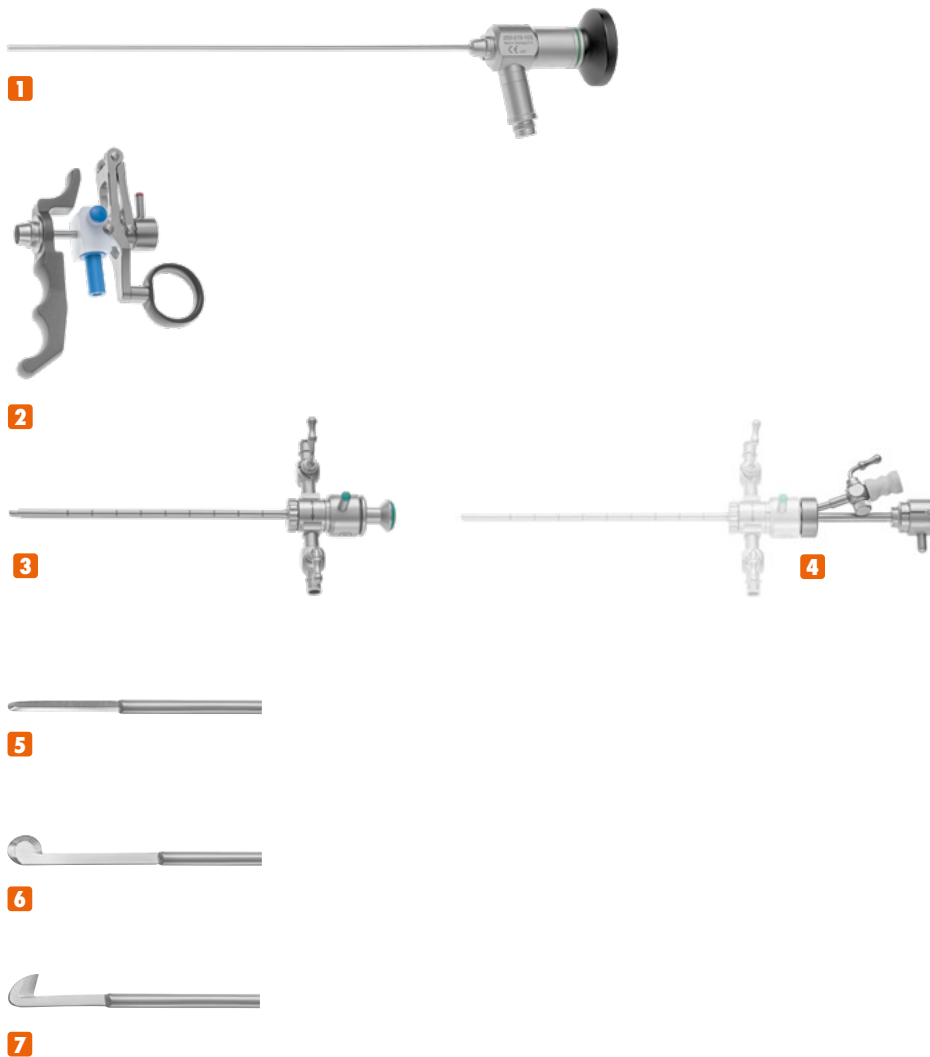

253-900-922 Urethrotome Set for children

1	RZ Pediatric Fiber Cystoscope, 0°, Ø 2.0mm	253-219-100	1 pc.
2	Passive Working Element	253-250-200	1 pc.
3	Pediatric Urethrotome sheath, 10 Charr.	253-265-010	1 pc.
4	Bridge with 1 channel	253-255-001	1 pc.
5	Knife with straight cutting edge	253-265-101	1 pc.
6	Round Knife	253-265-102	1 pc.
7	Hook Knife	253-265-104	1 pc.

CONFIGURATIONS Uretero-Renoscope Set
by RZ

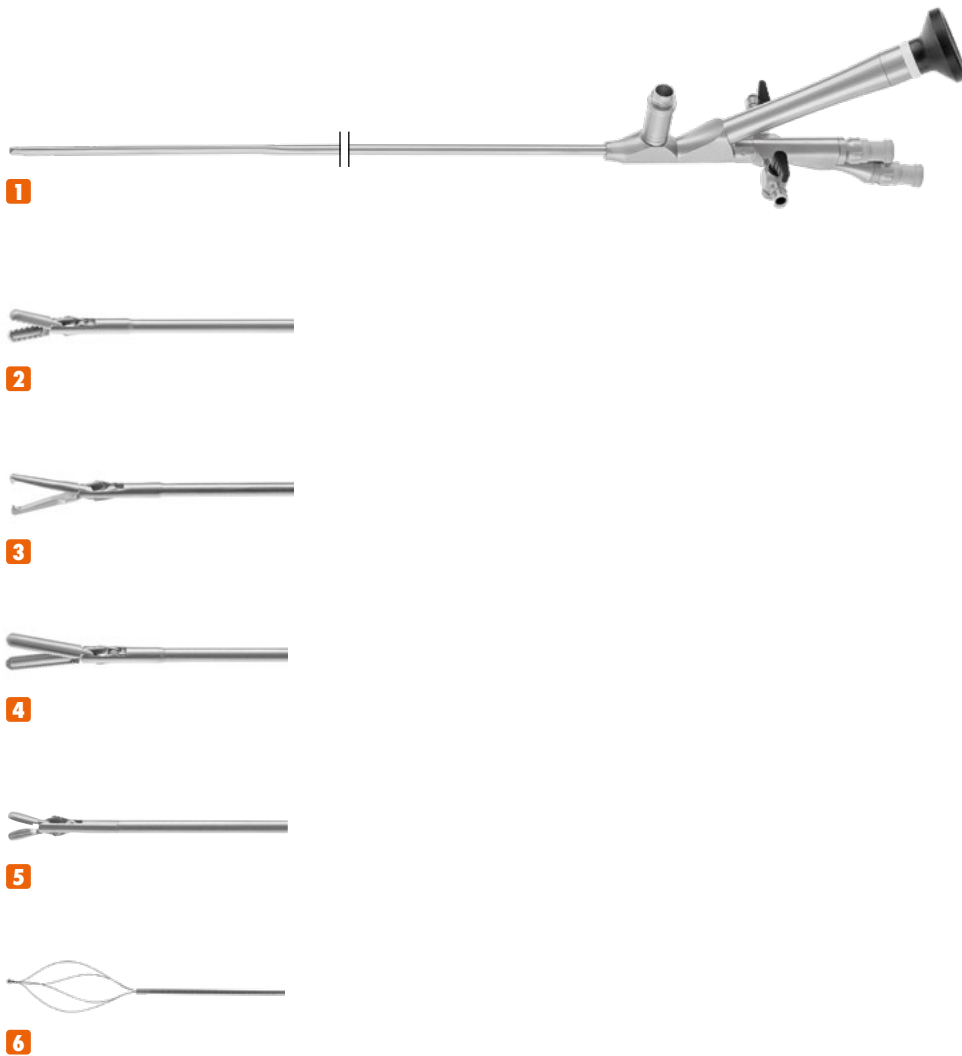

253-900-903 Uretero-Renoscope Set

1	Advanced Semi-Rigid Uretero-Renoscope	253-905-540	1 pc.
2	Stone Grasping Forceps	253-950-005	1 pc.
3	Stone Grasping Forceps for large stones	253-952-005	1 pc.
4	HAMADA Long Stone Grasping Forceps	253-954-005	1 pc.
5	Biopsy Forceps	253-956-005	1 pc.
6	Dormia Metal Stone Basket, flexible	253-585-005	1 pc.



Nephroscope Set, Mini PCNL

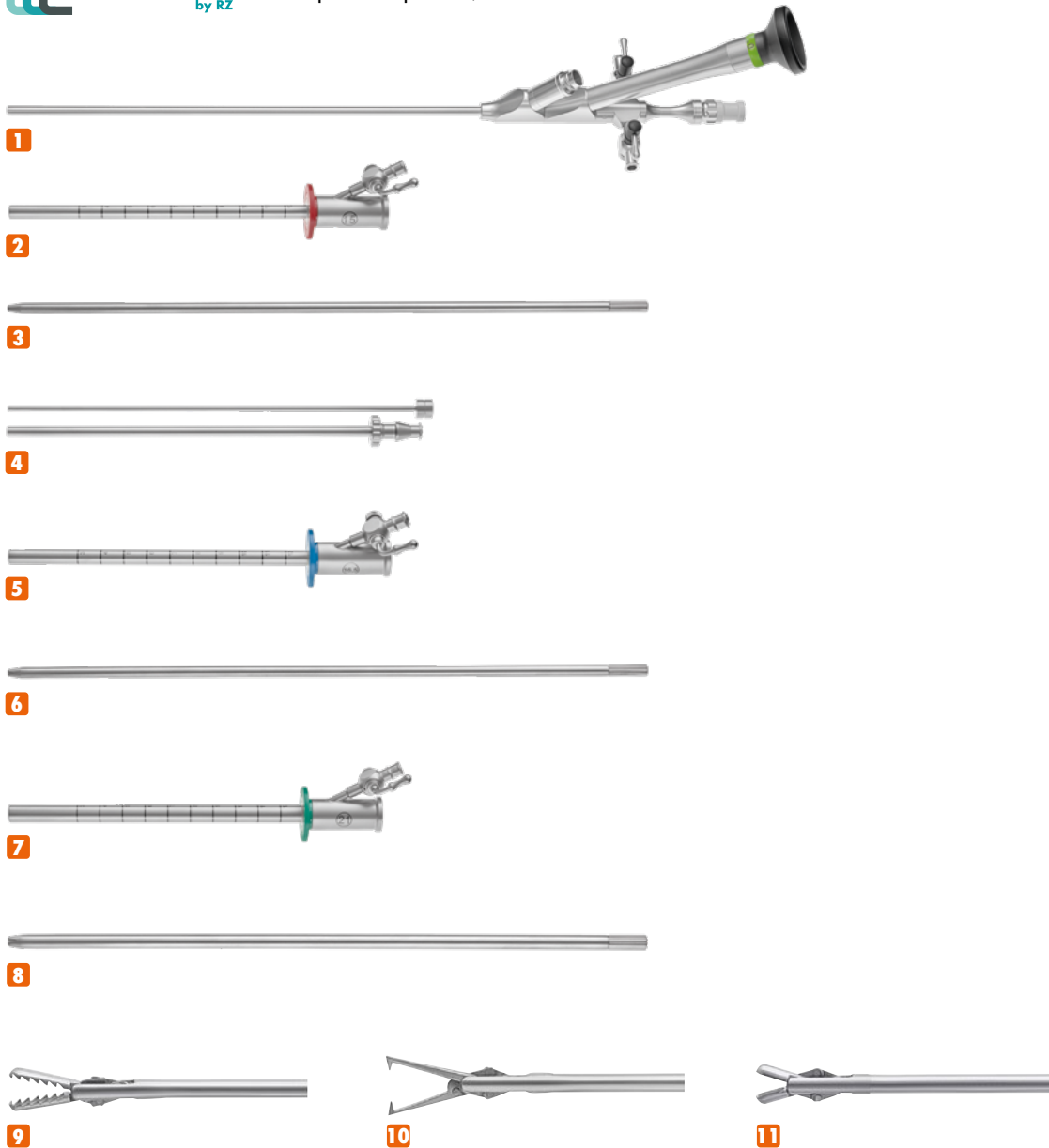

253-900-909 Nephroscope Set, Mini PCNL

1	Mini Nephroscope, 12°	253-900-140	1 pc.
2	15 Charr. Nephroscope Sheath	253-900-141	1 pc.
3	One-Step Dilator	253-900-146	1 pc.
4	2-piece Sealing Adapter	253-900-145	1 pc.
5	16.5 Charr. Nephroscope Sheath	253-900-142	1 pc.
6	One-Step Dilator	253-900-147	1 pc.
7	21 Charr. Nephroscope Sheath	253-900-143	3 pcs.
8	One-step Dilator	253-900-148	3 pcs.
9	Stone Grasping forceps	253-950-455	1 pc.
10	Stone Grasping Forceps for large stones	253-952-455	1 pc.
11	Biopsy Forceps	253-956-455	1 pc.

CONFIGURATIONS by RZ Nephroscope Set, Compact PCNL

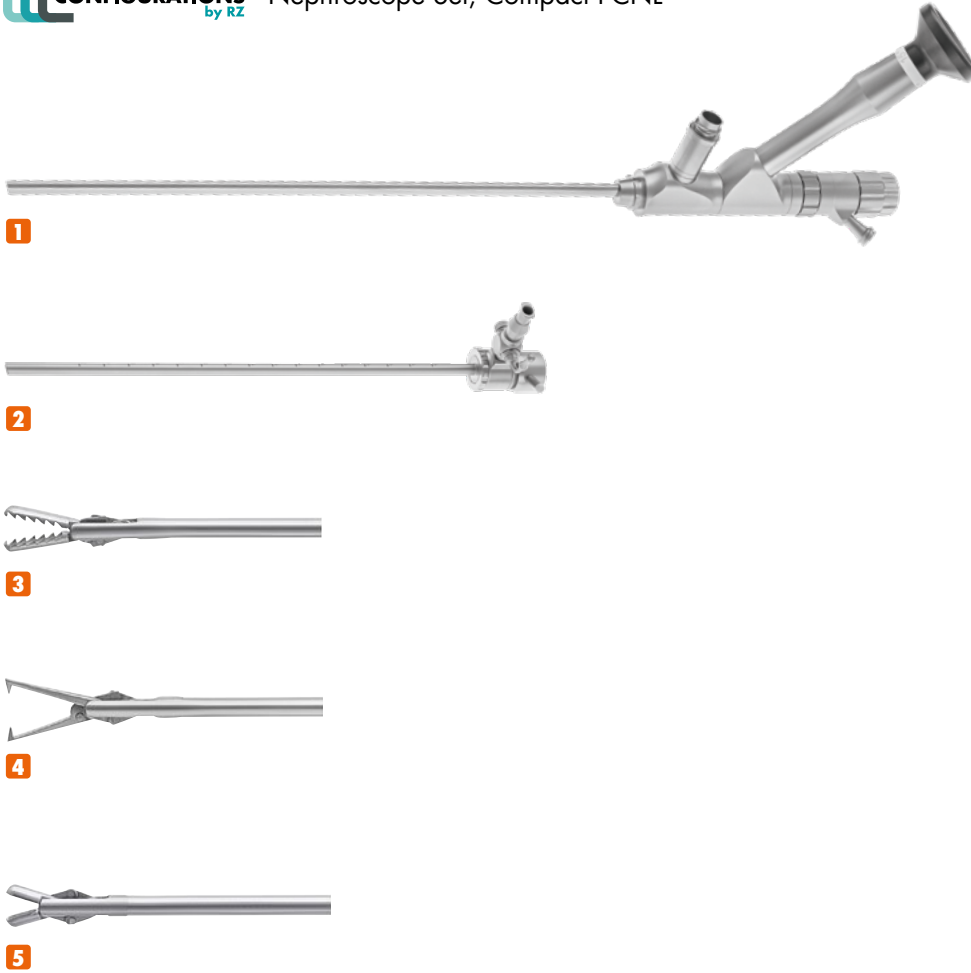

253-900-923 Nephroscope Set, Compact PCNL

1	Compact Nephroscope	253-900-830	1 pc.
2	Shaft with Obturator	253-900-888	1 pc.
3	Stone Grasping forceps	253-950-455	1 pc.
4	Stone Grasping Forceps for large stones	253-952-455	1 pc.
5	Biopsy Forceps	253-956-455	1 pc.



Nephroscope Set, Standard PCNL

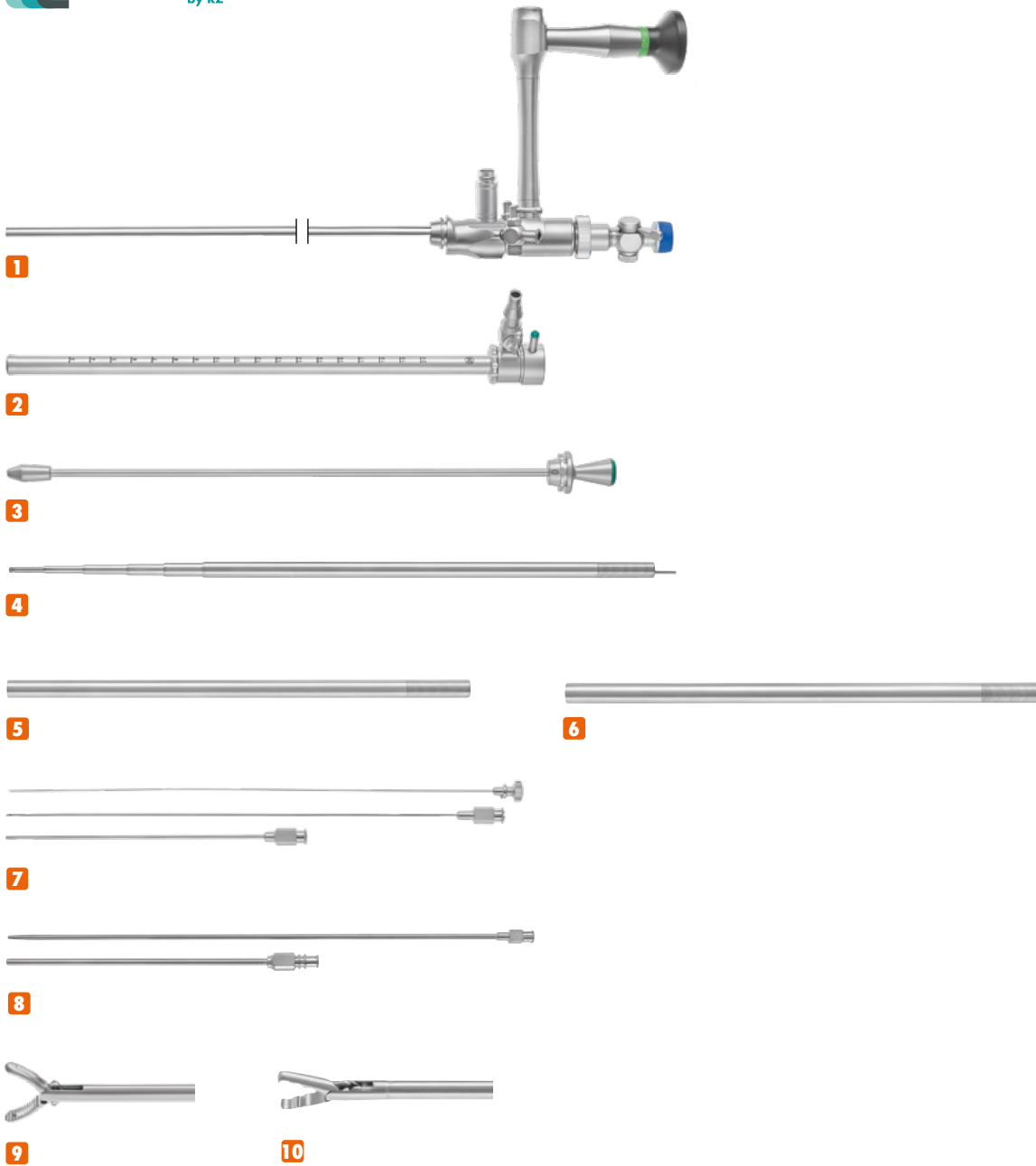

253-900-924 Nephroscope Set, Standard PCNL

1	Nephroscope, 6°	253-900-121	1 pc.
2	Operating Sheath 26 Charr.	253-900-130	1 pc.
3	Hollow Obturator 26 Charr.	253-900-135	1 pc.
4	Amplatz metal Dilator Set	253-900-155	1 pc.
5	Amplatz metal Dilator 27 Charr.	253-900-156	1 pc.
6	Amplatz metal Dilator 30 Charr.	253-900-157	1 pc.
7	Puncture Cannula with inner and outer cannula	253-900-201	3 pcs.
8	Dilation Cannula, Ø 3mm	253-900-202	3 pcs.
9	Stone Grasping Forceps, fenestrated	253-900-250	1 pc.
10	Stone Grasping Forceps, coarse serrated	253-900-252	1 pc.

CONFIGURATIONS by RZ Lithotripsy Set, mechanical

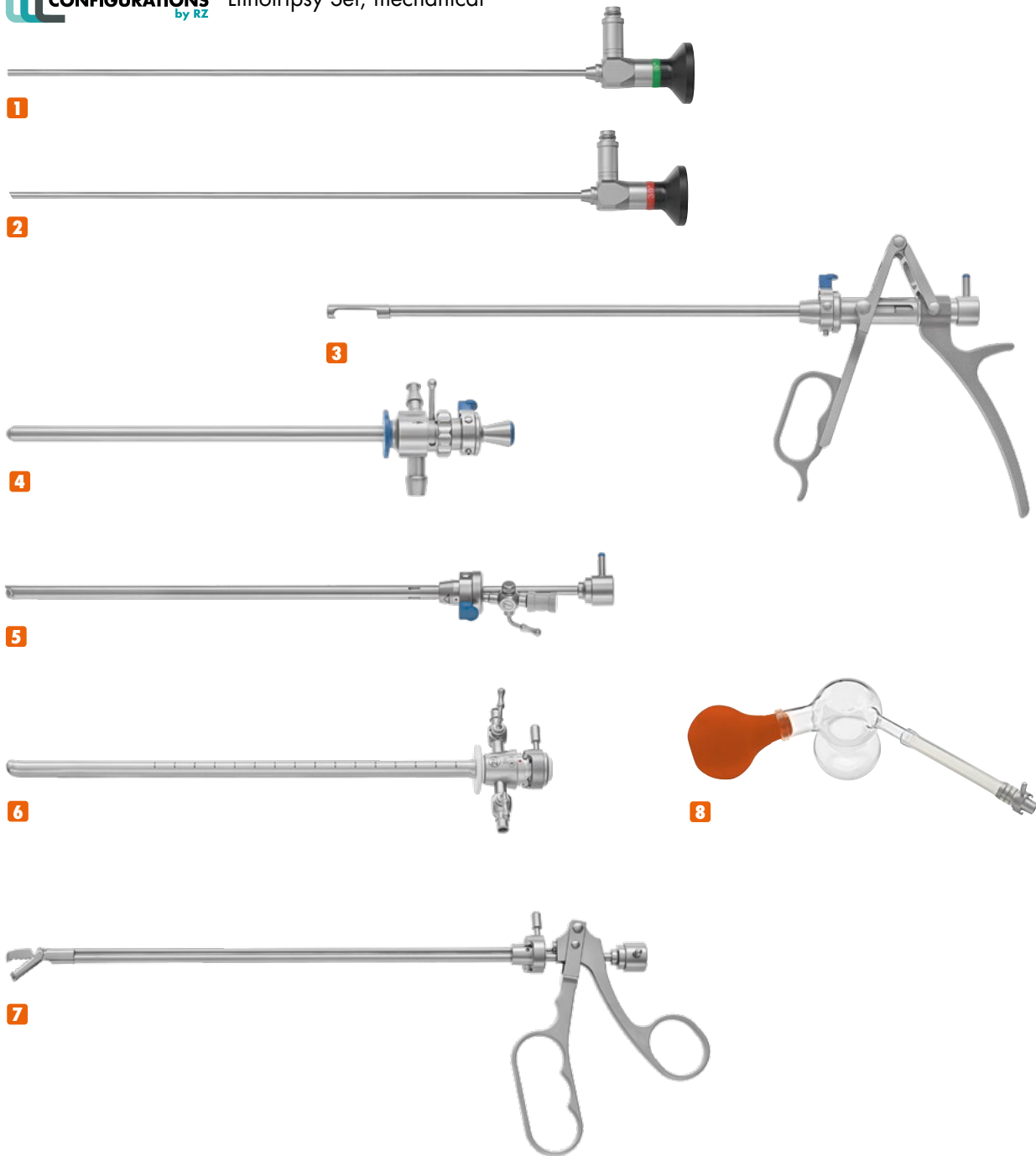

253-900-925 Lithotripsy Set, mechanical

1	RZ Cystoscope, 0°, Ø 4.0mm	253-804-000	1 pc.
2	RZ Cystoscope, 30°, Ø 4.0mm	253-804-030	1 pc.
3	Mauermayer Stone Punch	253-755-010	1 pc.
4	Punch Sheath with Central Valve, 24 Charr.	253-755-020	1 pc.
5	Visual Obturator with 7 Charr. working channel	253-755-030	1 pc.
6	Cysto-Urethroscope Sheath 25 Charr.	253-300-025	1 pc.
7	Stone Crushing Forceps for small stones, single action	253-760-000	1 pc.
8	Elik Evacuator with turn lock connection	253-500-000	1 pc.



Lithotripsy Set, electro-pneumatic



1



2



3



4 - 9

253-900-926 Lithotripsy Set, electro-pneumatic

1	L 100 Lithotripter	253-750-100	1 pc.
2	Pneumatic Footswitch	253-750-150	1 pc.
3	Hand piece, anodised	253-750-200	1 pc.
4	Litho Probe, 0.6mm	253-850-006	2 pcs.
5	Litho Probe, 0.8mm	253-850-008	2 pcs.
6	Litho Probe, 1.0mm	253-850-010	2 pcs.
7	Litho Probe, 1.2mm	253-850-012	2 pcs.
8	Litho Probe, 1.6mm	253-850-016	2 pcs.
9	Litho Probe, 2.0mm	253-850-020	2 pcs.

CYSTOSCOPY

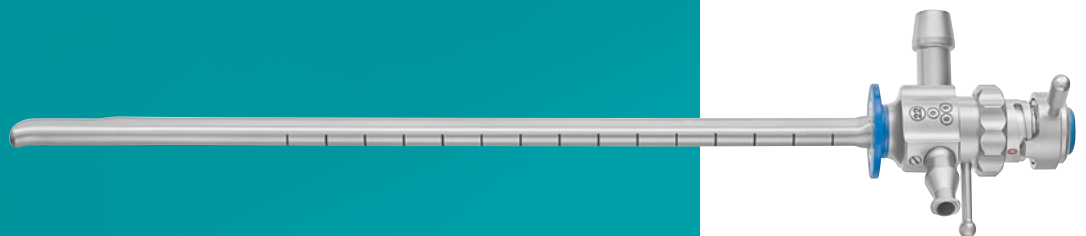

4K UHD CYSTOSCOPES

- 4K Ultra High Definition resolution
- Ø 4mm, 302mm working length
- Available in 0°, 12°, 30° and 70° direction of view
- Autoclavable
- Made in Germany



RZ 4K Cystoscope, Ø 4mm, 302mm working length, 362mm overall length

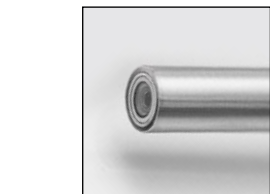

0°

253-804-400

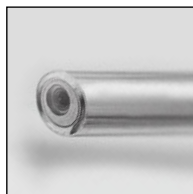
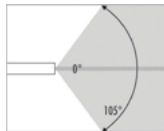

12°

253-804-412

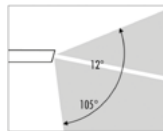

30°

253-804-430

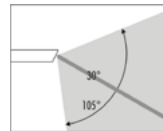

70°

253-804-470

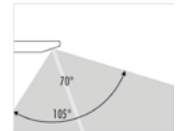

FULL HD CYSTOSCOPES

- Colour coded rings identify the direction of view
- Ø 4mm, 302mm working length
- 3-step light post adapters for the most common light cables
- Sapphire glasses to protect lens system
- Optimized glass fibre arrangements for an uniform image brightness
- Fully autoclavable at 134°C and 2.3bar

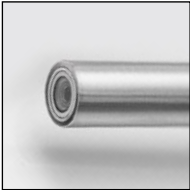
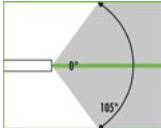
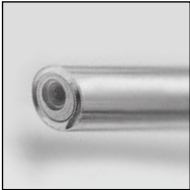
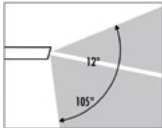
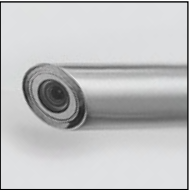
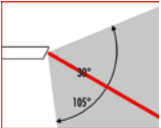
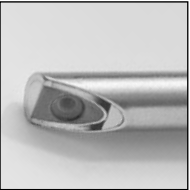
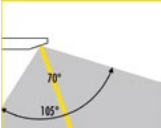

RZ Cystoscope, Ø 4mm, 302mm working length, 356mm overall length

 0° ■ 253-804-000* 	 12° □ 253-804-012* 	 30° ■ 253-804-030* 	 70° ■ 253-804-070* 
---	---	--	---



Sheaths for use with \varnothing 4mm Cystoscopes

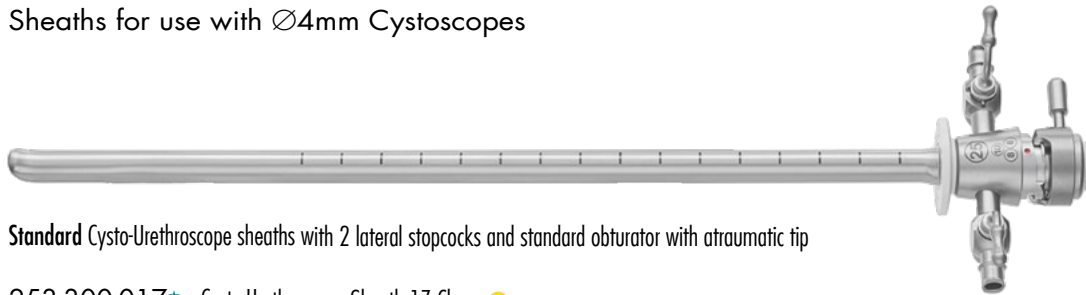

Standard Cysto-Urethroscope sheaths with 2 lateral stopcocks and standard obturator with atraumatic tip

- 253-300-017* Cysto-Urethroscope Sheath 17 Charr. ●
- 253-300-019* Cysto-Urethroscope Sheath 19 Charr. ●
- 253-300-020* Cysto-Urethroscope Sheath 20 Charr. ●
- 253-300-022* Cysto-Urethroscope Sheath 22 Charr. ●
- 253-300-025* Cysto-Urethroscope Sheath 25 Charr. ○

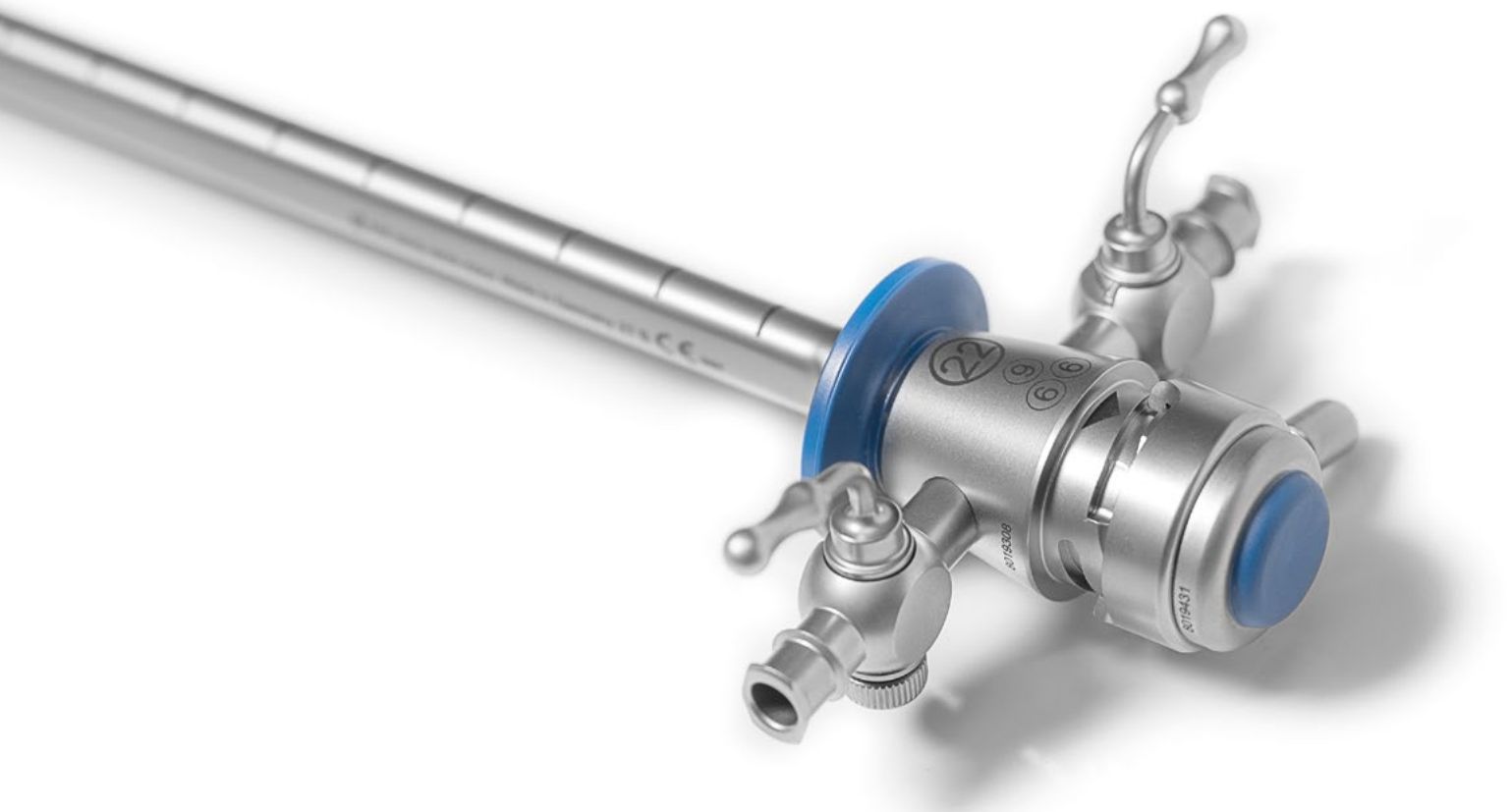

Obturator for use with Cystoscope sheaths



Standard Obturators with atraumatic tip and locking mechanism for all RZ Cysto-Urethroscope sheaths

- 253-000-117 Obturator 17 Charr. ●
- 253-000-119 Obturator 19 Charr. ●
- 253-000-120 Obturator 21 Charr. ●
- 253-000-122 Obturator 23 Charr. ●
- 253-000-125 Obturator 25 Charr. ○



Visual Obturators with locking mechanism for all 4mm RZ Cystoscopes

- 253-000-217 Obturator 17 Charr. ●
- 253-000-219 Obturator 19 Charr. ●
- 253-000-220 Obturator 20 Charr. ●
- 253-000-222 Obturator 22 Charr. ●
- 253-000-225 Obturator 25 Charr. ○



253-315-000
Hamada Cystoscope Adapter for use with RZ Cystoscope sheath

Cystoscope Bridge for use with Cysto-Urethroscope sheaths

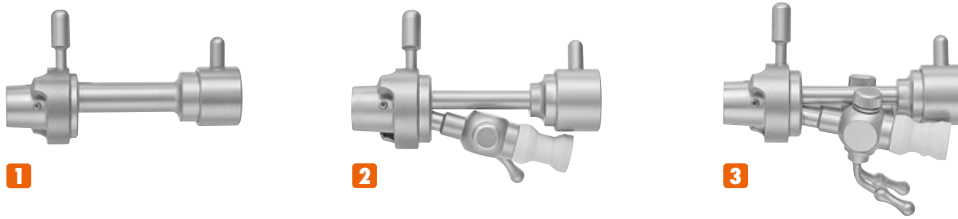

- 1** 253-000-100* without channel
- 2** 253-000-101* with 1 channel for 1 instrument with max. 12 Charr.
- 3** 253-000-102* with 2 channels for 1 instrument with max. 12 Charr. or 2 instruments with max. 8 Charr.

Albarran deflecting mechanism for use with 19-25 Charr. RZ Cysto-Urethroscope sheaths

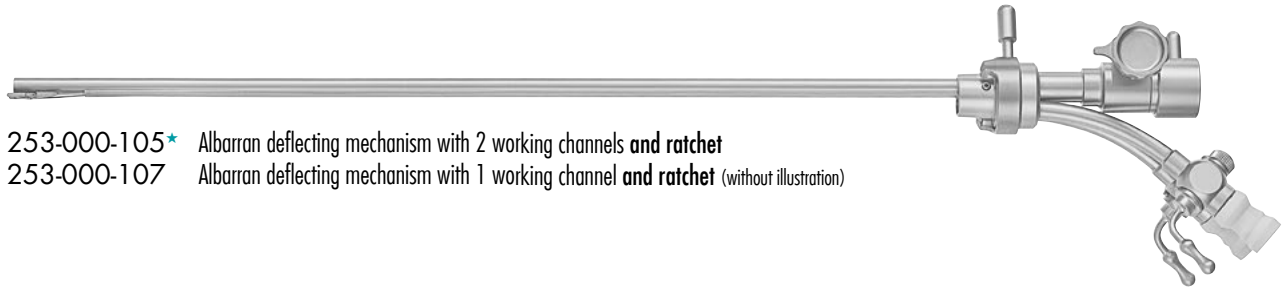

- 253-000-105* Albarran deflecting mechanism with 2 working channels **and ratchet**
- 253-000-107 Albarran deflecting mechanism with 1 working channel **and ratchet** (without illustration)

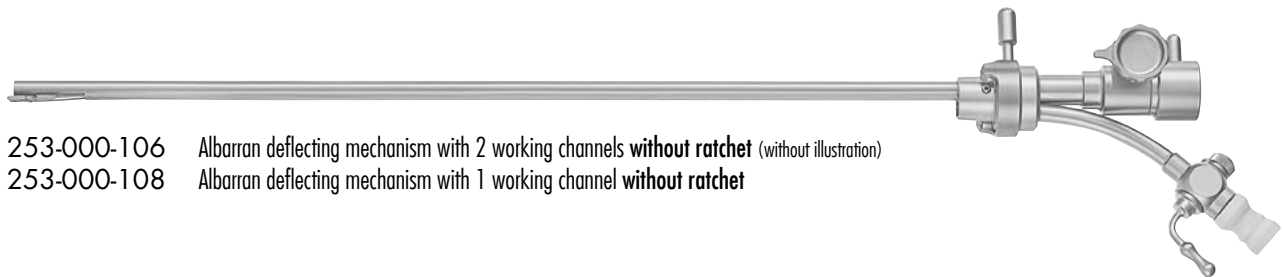

- 253-000-106 Albarran deflecting mechanism with 2 working channels **without ratchet** (without illustration)
- 253-000-108 Albarran deflecting mechanism with 1 working channel **without ratchet**

Sheath - Instrument combinations

SHEATHS	COLOR	ALBARRAN		BRIDGE	
		1 working channel	2 working channels	1 working channel	2 working channels
25 Charr.	○	1 x 10 Charr.	2 x 8 Charr.	1 x 12 Charr.	2 x 8 Charr.
22 Charr.	●	1 x 9 Charr.	2 x 6 Charr.	1 x 10 Charr.	2 x 7 Charr.
20 Charr.	●	1 x 6 Charr.	2 x 5 Charr.	1 x 7 Charr.	2 x 6 Charr.
19 Charr.	●	1 x 5 Charr.	2 x 4 Charr.	1 x 6 Charr.	2 x 5 Charr.
17 Charr.	●	-	-	1 x 5 Charr.	-

Flexible Instruments for use with cystoscopes

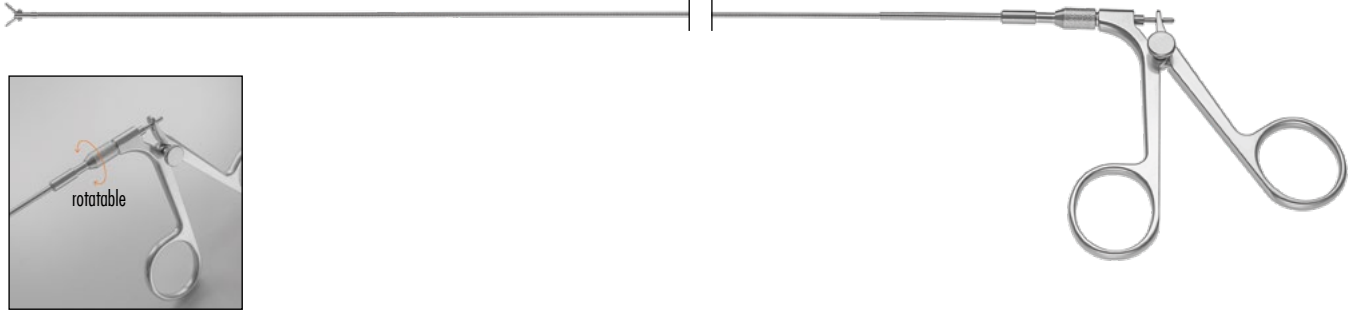

Working length: 400mm
Rotatable and detachable



Grasping Forceps, serrated jaws,
double action

351-114-105* 5 Charr.
351-114-107* 7 Charr.
351-114-109 9 Charr.



Biopsy Forceps, oval cup,
double action

351-120-105* 5 Charr.
351-120-107* 7 Charr.
351-120-109 9 Charr.



Serrated Biopsy Forceps, oval cup
with aggressive serration, double action

351-124-107 7 Charr.



Scissors, single action

351-100-105* 5 Charr.
351-100-107 7 Charr.
351-100-109 9 Charr.



DJ Forceps, double action

351-107-107 7 Charr.
351-107-109 9 Charr.



Grasping Forceps, serrated jaw,
double action, 730mm working length

253-958-105 5 Charr.



Biopsy Forceps, double action,
730mm working length

253-957-105 5 Charr.



The next generation instruments in Endo-Urology

- ▼ Detachable – one handle for all inserts
- ▼ Color code – the easy identification of the tip
- ▼ Two handles – self holding and standard
- ▼ Easy connection – the reliable ball tip technique
- ▼ Light weight handle – the perfect fit for your fingers
- ▼ Make cleaning easy – flushing port for the complete instrument
- ▼ 360° rotation - just with your finger tip
- ▼ All parts can be ordered separately



PATENTED
10 2022 107 371.8





Multiple tips design



Color coded inserts

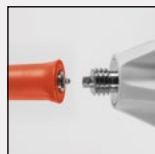

Unique, detachable system



Flushing port for easy cleaning



Two handles - multiple options

FORCEPS & PUNCHES



- ▶ Automatic self-holding
- ▶ Black color coded

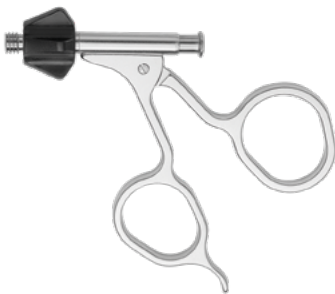

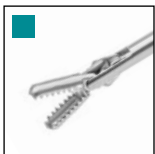

351-100-500 Self-holding handle for forceps and punches (recommended handle)



Grasping Forceps with toothed cup, double action, 600mm working length

Insert only

Complete instrument

		Insert only	Complete instrument
 semi-rigid	3 Charr., Ø 1.0mm	253-950-503	253-950-003
	4 Charr., Ø 1.3mm	253-950-504	253-950-004
	5 Charr., Ø 1.6mm	253-950-505	253-950-005
 flexible	3 Charr., Ø 1.0mm	253-951-503	253-951-003
	4 Charr., Ø 1.3mm	253-951-504	253-951-004
	5 Charr., Ø 1.6mm	253-951-505	253-951-005



Stone Grasping Forceps for large stones,
double action jaws, 600mm working length

Insert only

Complete instrument



semi-rigid

3 Charr., Ø 1.0mm

253-952-503

253-952-003

4 Charr., Ø 1.3mm

253-952-504

253-952-004

5 Charr., Ø 1.6mm

253-952-505

253-952-005



flexible

3 Charr., Ø 1.0mm

253-953-503

253-953-003

4 Charr., Ø 1.3mm

253-953-504

253-953-004

5 Charr., Ø 1.6mm

253-953-505

253-953-005

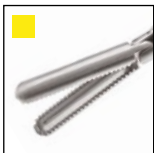

HAMADA long Stone Grasping Forceps,
double action jaws, 600mm working length

Insert only

Complete instrument



semi-rigid

3 Charr., Ø 1.0mm

253-954-503

253-954-003

4 Charr., Ø 1.3mm

253-954-504

253-954-004

5 Charr., Ø 1.6mm

253-954-505

253-954-005



flexible

3 Charr., Ø 1.0mm

253-955-503

253-955-003

4 Charr., Ø 1.3mm

253-955-504

253-955-004

5 Charr., Ø 1.6mm

253-955-505

253-955-005



Biopsy Forceps, 600mm working length

Insert only

Complete instrument



semi-rigid

3 Charr., Ø 1.0mm

253-956-503

253-956-003

4 Charr., Ø 1.3mm

253-956-504

253-956-004

5 Charr., Ø 1.6mm

253-956-505

253-956-005



flexible

3 Charr., Ø 1.0mm

253-957-503

253-957-003

4 Charr., Ø 1.3mm

253-957-504

253-957-004

5 Charr., Ø 1.6mm

253-957-505

253-957-005

SCISSORS





- ▼ Standard handle
- ▼ White color coded



351-100-550 Standard handle for scissors
(recommended handle)



Scissors, single action, 600mm working length		Insert only	Complete instrument
 semi-rigid	3 Charr., Ø 1.0mm	253-958-503	253-958-003
	4 Charr., Ø 1.3mm	253-958-504	253-958-004
	5 Charr., Ø 1.6mm	253-958-505	253-958-005
 flexible	3 Charr., Ø 1.0mm	253-959-503	253-959-003
	4 Charr., Ø 1.3mm	253-959-504	253-959-004
	5 Charr., Ø 1.6mm	253-959-505	253-959-005

ASSEMBLY

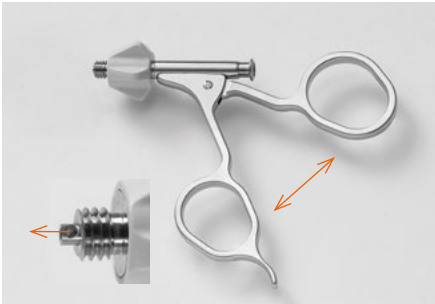

STEP 1

Open the handle.
The ball socket pushes out.

Keep the handle open.

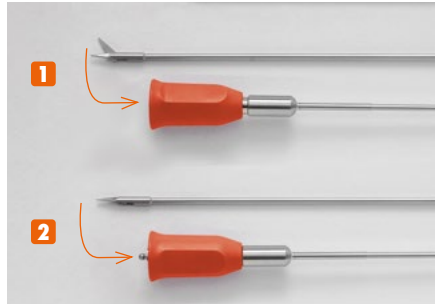

STEP 2

1 Opened jaw

2 Close the jaw - the ball head pushes out. Keep the jaw closed.



STEP 3

Push back the locking nut.

With both opened handle and jaws, connect the ball head and ball socket.

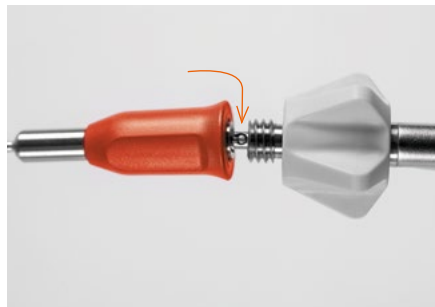

STEP 4

Insert the ball head into the socket.

Keep the handle opened.

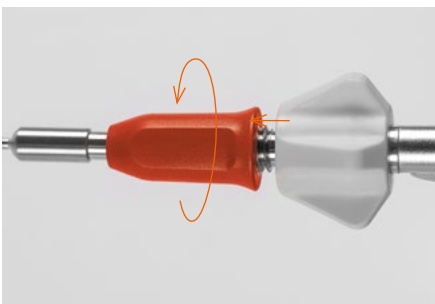

STEP 5

Close the handle. Shaft and insert will be retracted.
Keep the handle closed.

Screw the locking nut onto the handle.



DONE

Check the connection for being tight.

The knob rotates 360° and the handle as well as the jaw opens and closes.

OPTICAL FORCEPS

■ for use with Ø 4mm Cystoscopes

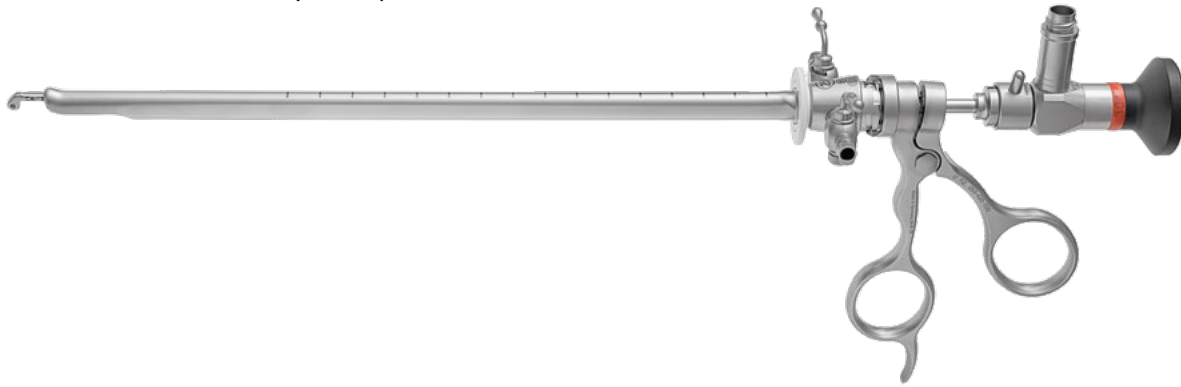

Scope is **below** forceps



Scope is **above** Forceps



253-420-100*
Spoon Biopsy Forceps with round cup,
double action



253-421-100
Grasping Forceps with serrated jaws,
double action



253-422-100
Biopsy Punch Forceps, thru-cutting,
double action



253-423-100
Scissors, hook type blades,
double action



253-426-100*
Mini Biopsy forceps with oval cup,
double action
for use with 0° cystoscope



253-431-100*
Biopsy forceps with **large** oval cup,
double action
for use with 30° cystoscope



253-425-100
Biopsy forceps with mini oval cup,
double action
for use with 4mm, 70° cystoscope



253-427-100*
Stent Grasping forceps
with serrated jaws, double action
for removal of stents

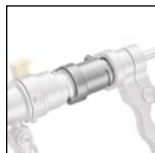

253-429-100* Adapter for use of optical forceps with resectoscope sheaths

FLEXIBLE INSTRUMENTS

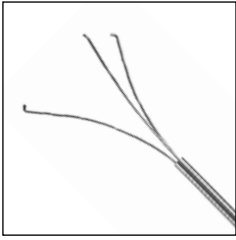

253-940-005 3-Prongs Grasper, flexible, 600mm working length, 5 Charr.

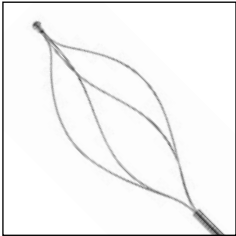

253-585-005 Dormia Metal Stone Basket, flexible, 4 wires, 600mm working length, 5 Charr.

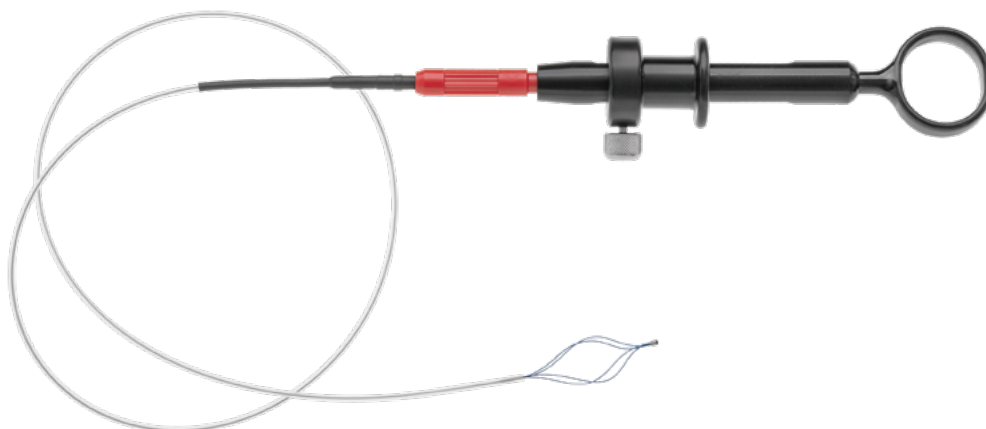

Dormia Nitinol Stone Basket, 600mm working length, 5 Charr.

- 253-581-045 with 4 wires, complete with handle
- 253-582-045 Spare Basket only, 4 wires
- 253-582-055 Spare Basket only, 5 wires
- 253-582-065 Spare Basket only, 6 wires

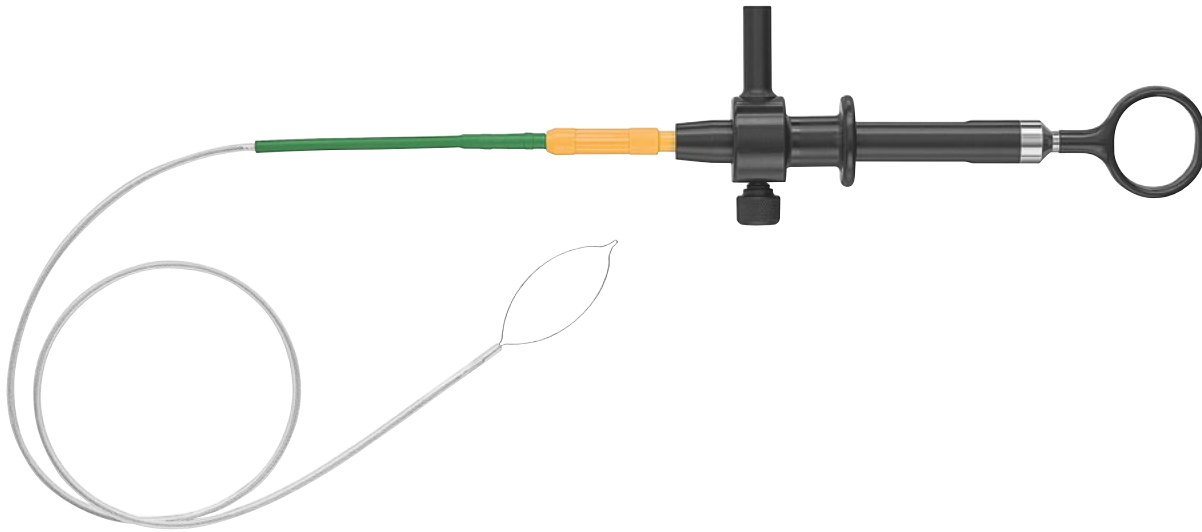

Polyp Snare with teflon tube, 500mm working length with HF connection, 7 Charr.

253-580-007 with handle, complete
 253-581-007 Spare Snare only

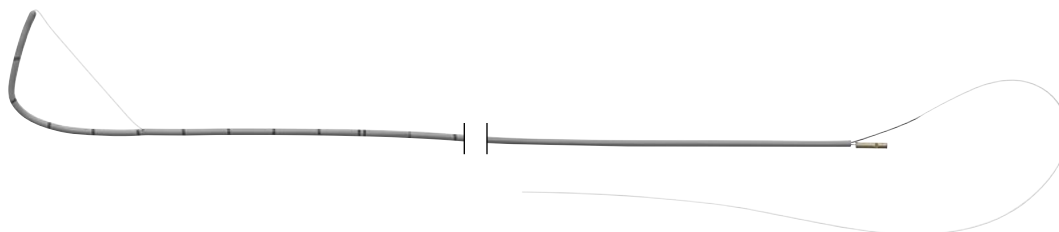





253-584-005 Zeiss Loop Catheter, package with 5 pieces, sterile, single use, 5 Charr.



FLEXIBLE ELECTRODES AND HF CABLES

Ball Electrode, 530mm working length

	253-370-003	3 Charr.
	253-370-103	3 Charr., 115mm working length
	253-370-005*	5 Charr.
	253-370-007	7 Charr.
	253-370-010	10 Charr.

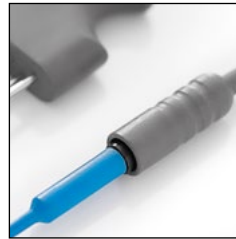

Needle Electrode, 530mm working length

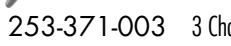
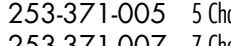
	253-371-003	3 Charr.
	253-371-005	5 Charr.
	253-371-007	7 Charr.

Loop Electrode 530mm working length

	253-372-005	5 Charr.
	253-372-007	7 Charr.



Monopolar High Frequency cables, 4,5mm length

253-610-001*	with 5 mm plug for Erbe HF-unit
253-610-002*	with 4 mm plug for Martin HF-unit
253-610-003*	with 8 mm plug for Valleylab HF-unit
253-610-004*	with 4 mm plug for older HF-units
700-501-453*	SDS plug

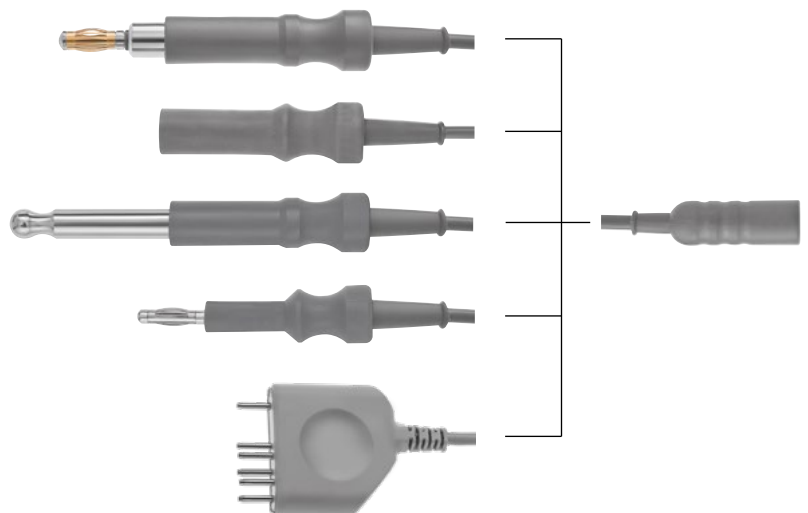

CYSTOSCOPY ACCESSORIES



301-701-100* Grey rubber cap for use on all working channels

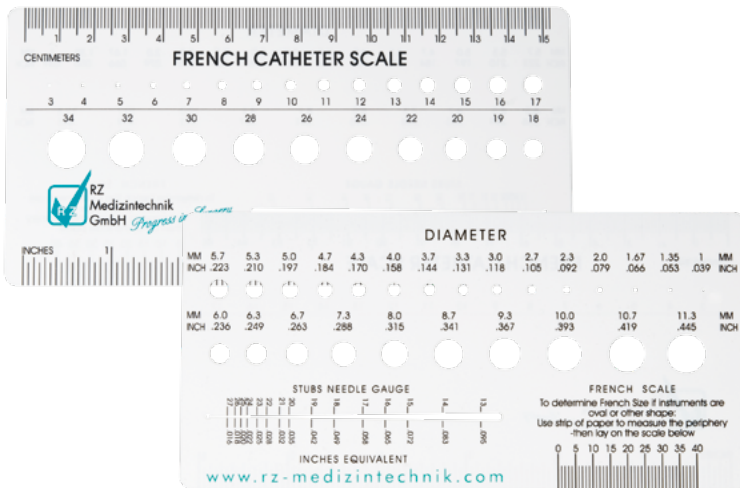

253-990-800 French Catheter Scale



Cleaning Brush, flexible

253-961-103 \varnothing 3mm, 100mm length,
for use in 2.0 - 2.6mm working channels

253-961-102 \varnothing 2.5mm, 120mm length,
for 5 Charr. working channels



300-215-000

Cleaning Brush, \varnothing 13mm, 60mm brush length, 230mm overall length

RESECTOSCOPY

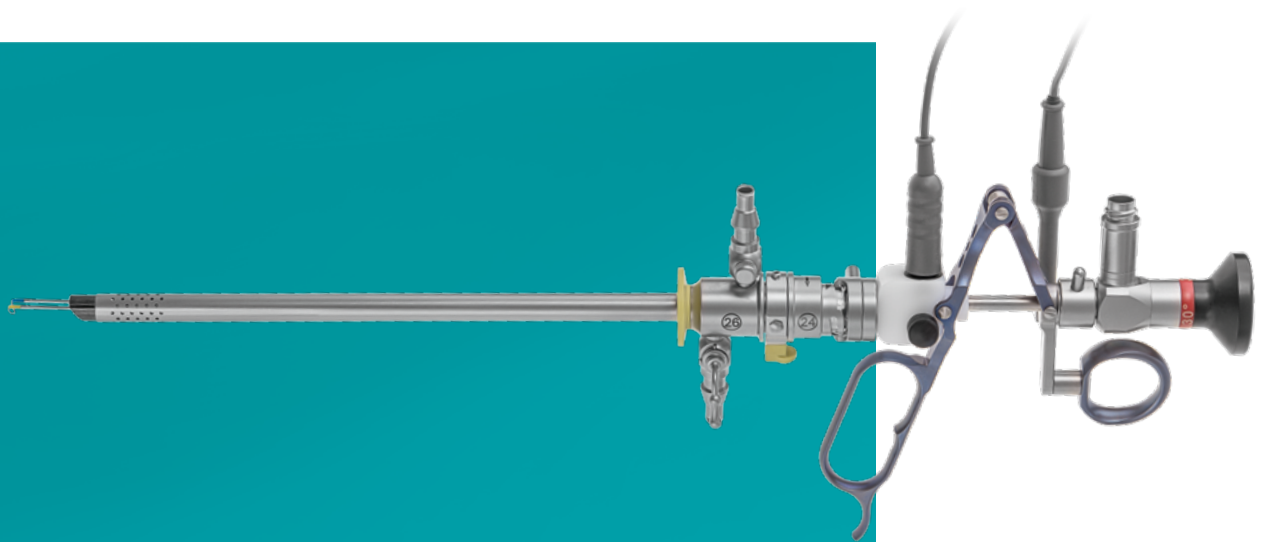

RZ RESECTOSCOPY SETS

Transurethral resection of the prostate (TURP) is a common surgery for BPH (Benign Prostate Hyperplasia). During TURP, the prostate is visualized through the urethra and tissue is removed using electric current. A monopolar or bipolar resectoscope is inserted transurethral and the enlarged prostatic tissue is removed with cutting and sealing electrodes.

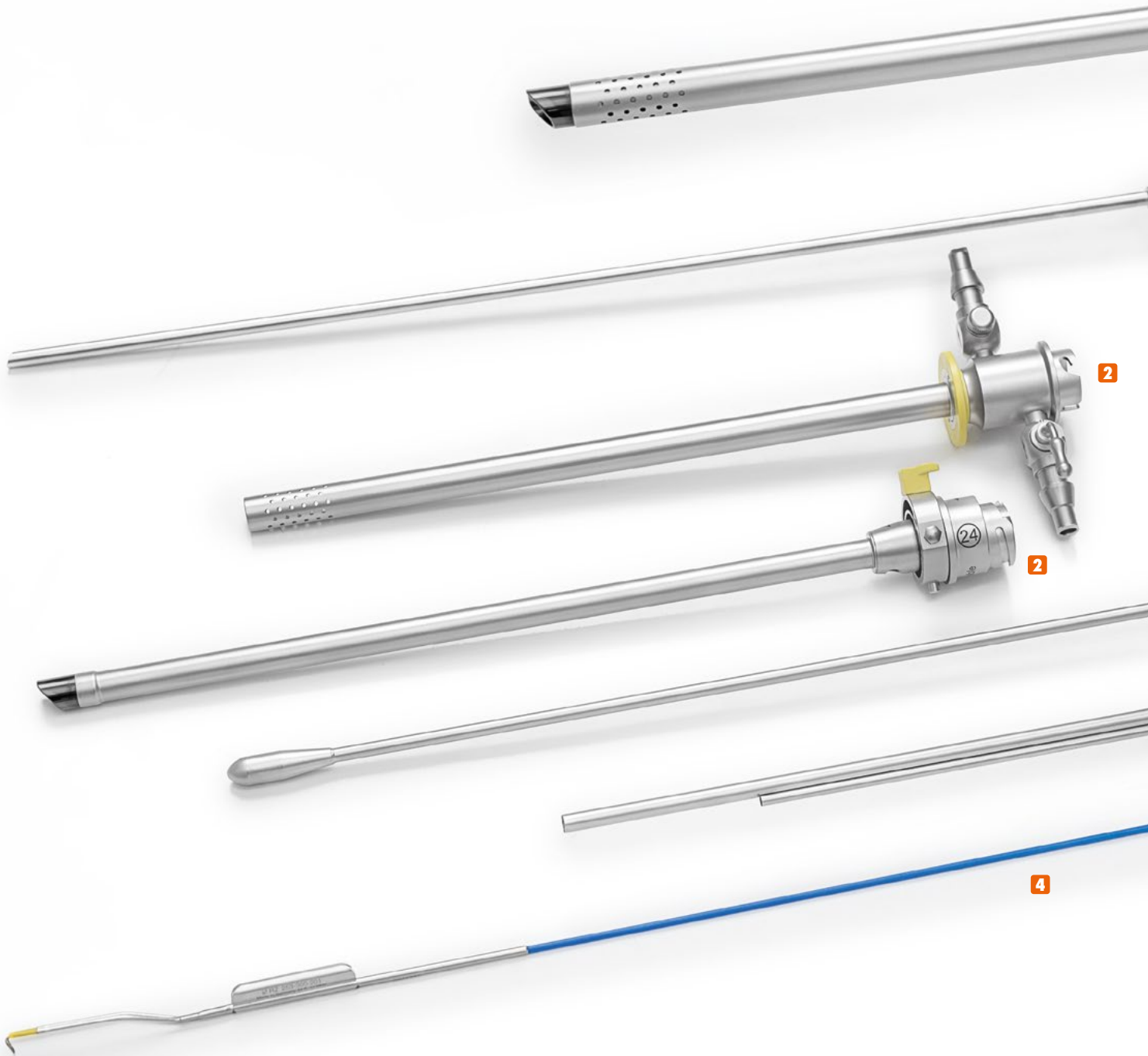

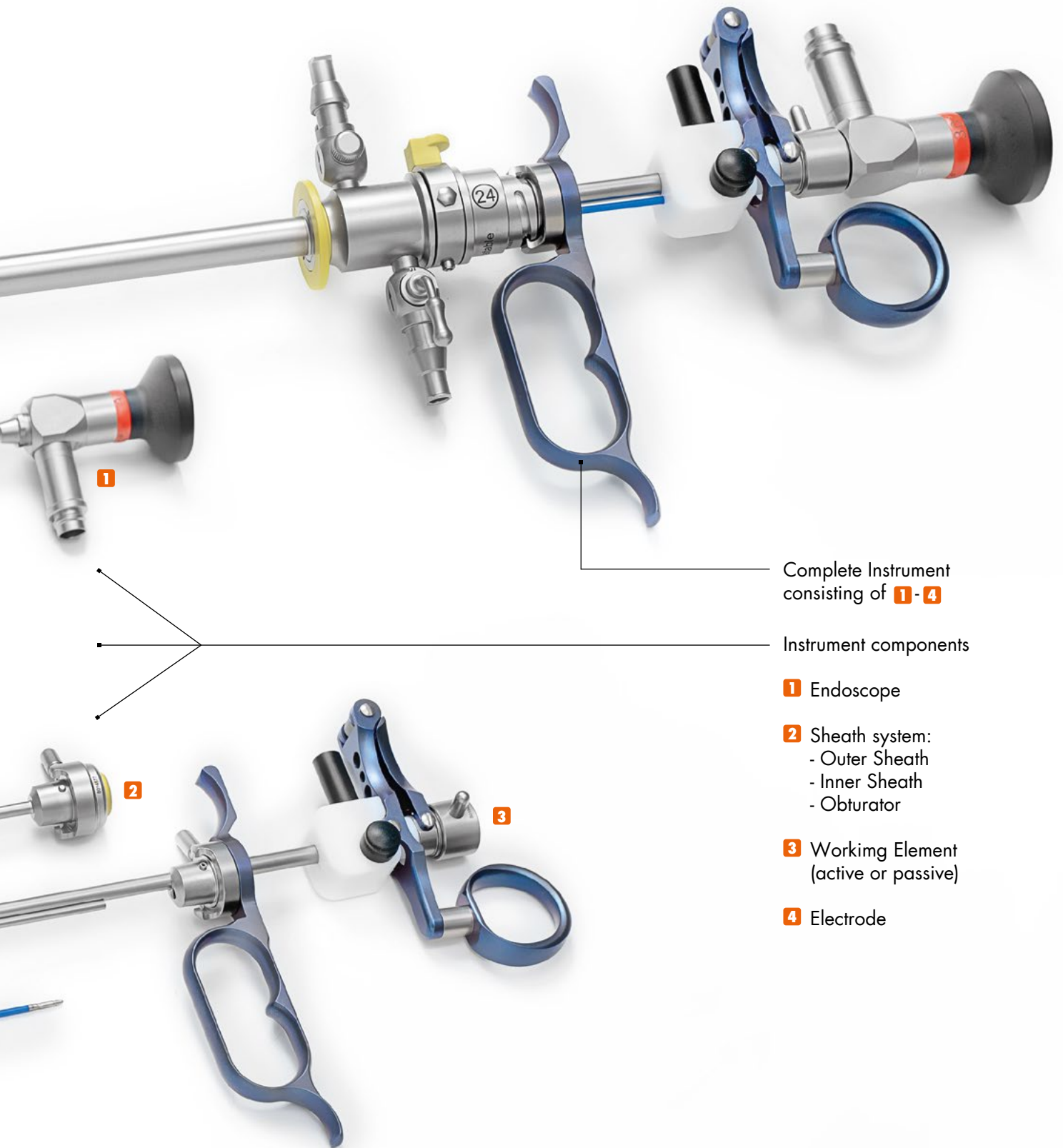

Complete Instrument consisting of **1-4**

Instrument components

- 1** Endoscope
- 2** Sheath system:
 - Outer Sheath
 - Inner Sheath
 - Obturator
- 3** Working Element (active or passive)
- 4** Electrode



RZ **HYBRID** RESECTOSCOPY SYSTEM

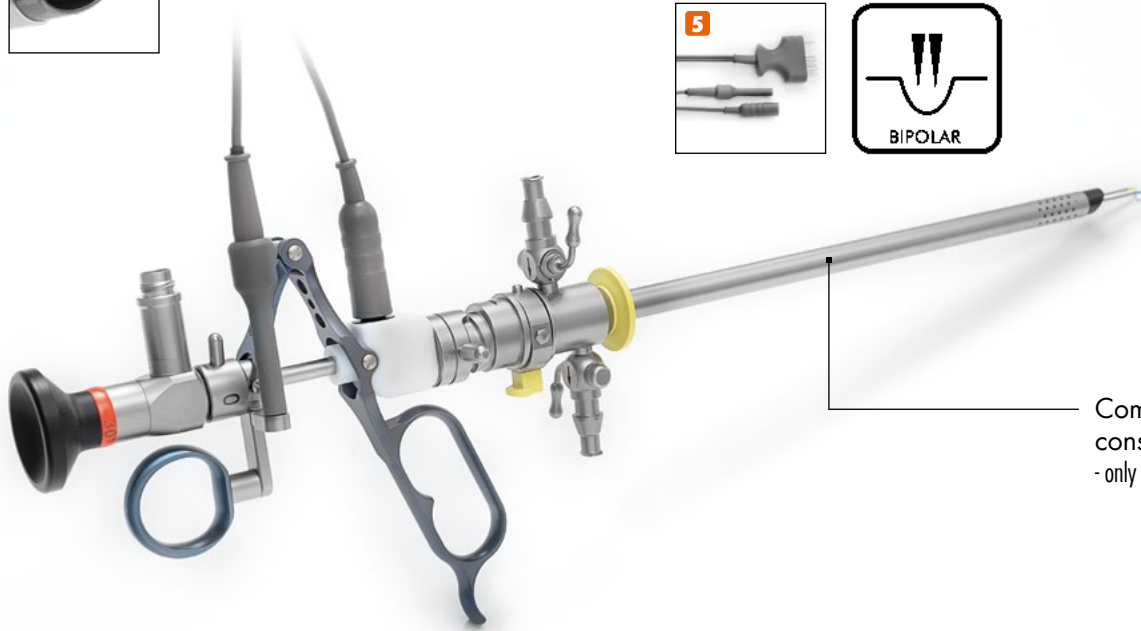
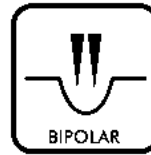
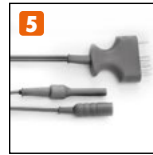

Complete Instrument consisting of **1** - **5**
- only cable needs to be changed

Instrument components

- 1** Endoscope
- 2** Hybrid Electrode
- 3** Sheath system:
 - Outer Sheath
 - Inner Sheath
 - Obturator
- 4** Working Element (active or passive)
- 5** Monopolar / Bipolar Cable



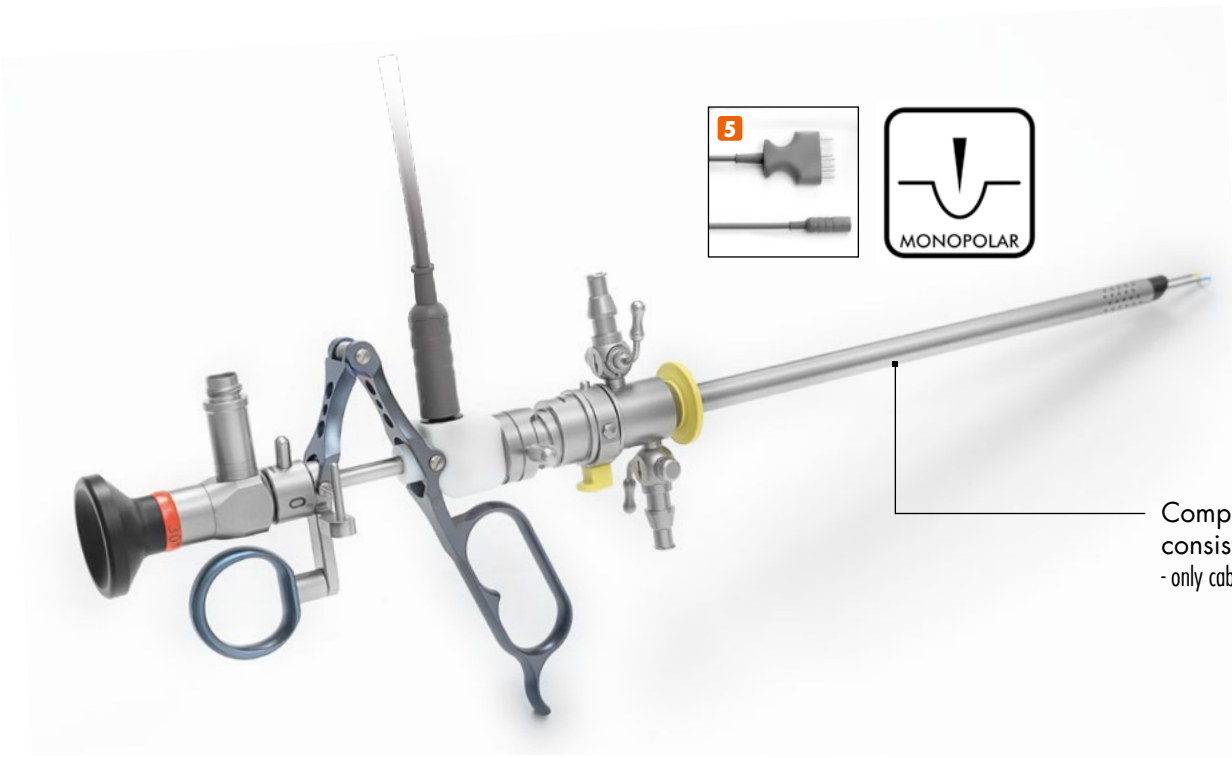

Complete Instrument consisting of **1-5**
- only cable needs to be changed

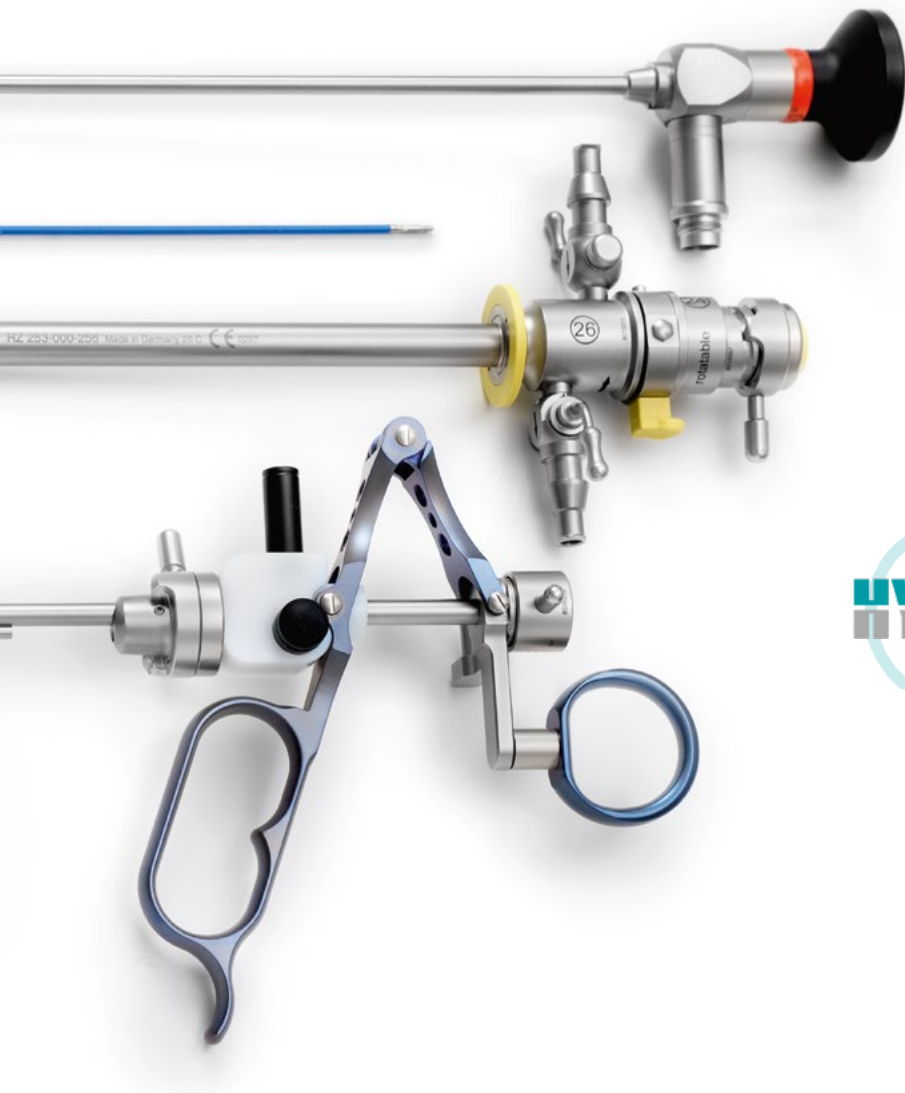

ONE set
TWO techniques

24
CHARR.

Endoscopes, suitable for 24 Charr. System



∅
4 mm

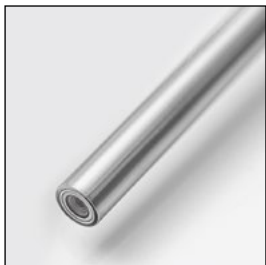

0° DIRECTION OF VIEW

300mm working length
356mm overall length 253-804-000*



12° DIRECTION OF VIEW

300mm working length
356mm overall length 253-804-012*



30° DIRECTION OF VIEW

300mm working length
356mm overall length 253-804-030*



Monopolar working elements suitable for 24 Charr. System

- Lightweight, titanium handle parts
- Ergonomic handle design with finger rest and rotating titanium thumb ring

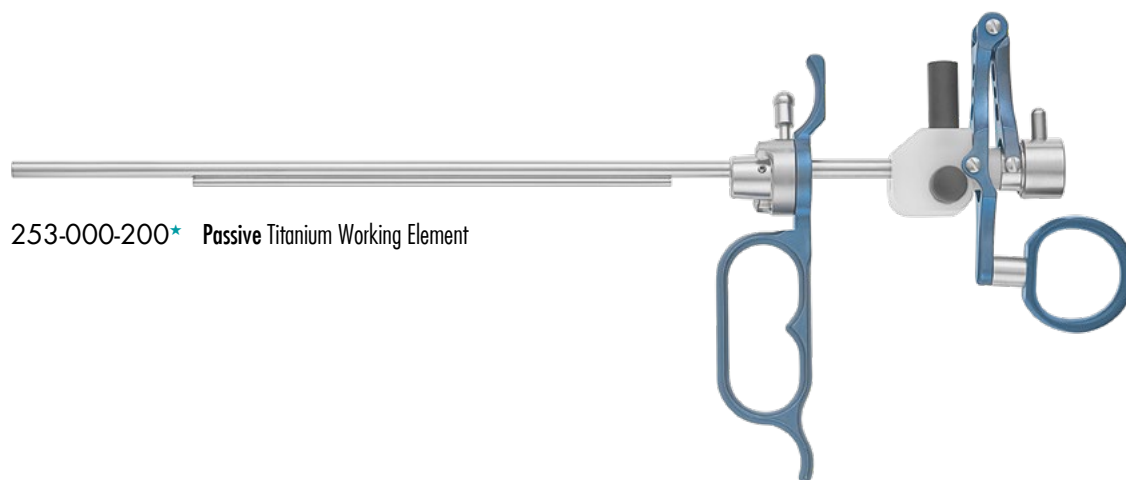

253-000-200* **Passive** Titanium Working Element

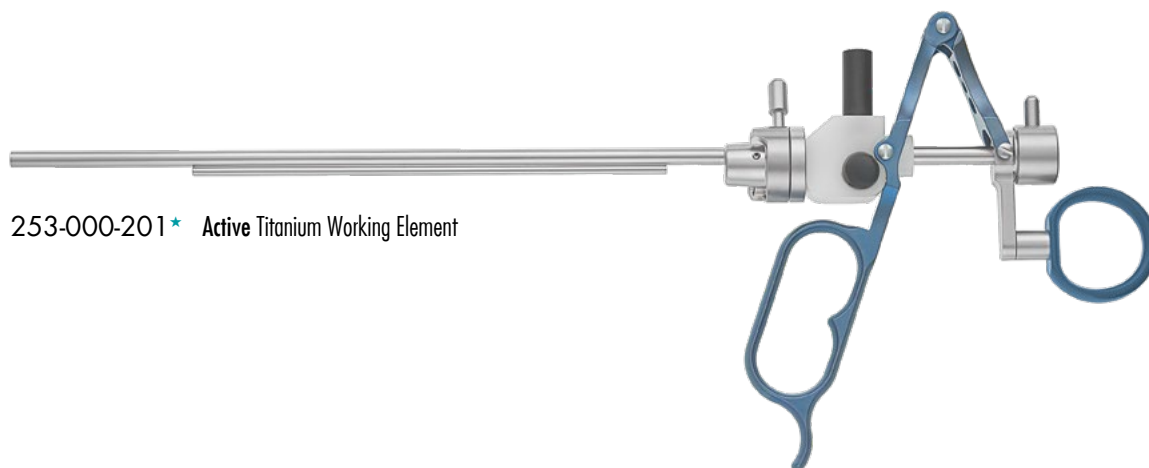

253-000-201* **Active** Titanium Working Element

24
CHARR.

HYBRID
HYBRID



Working elements suitable for HYBRID 24 Charr. system
with bipolar and monopolar cable connection

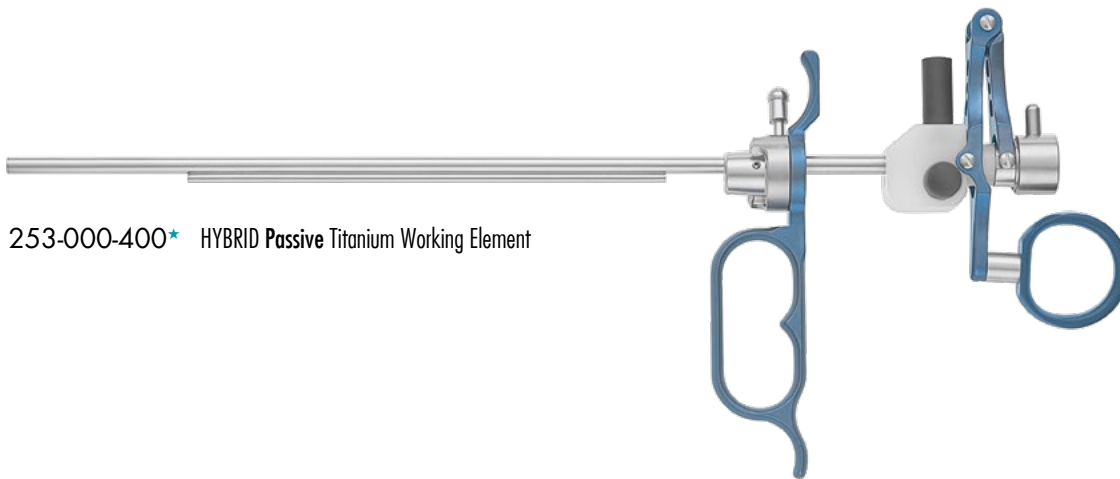

253-000-400* HYBRID Passive Titanium Working Element

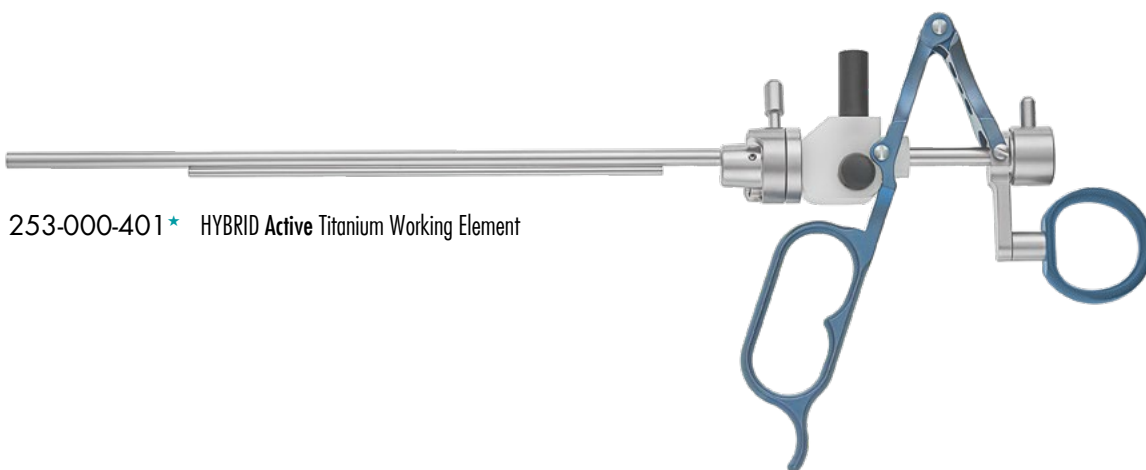

253-000-401* HYBRID Active Titanium Working Element

24
CHARR.

HYBRID



Sheaths, to be used with 24 Charr. system,
monopolar and HYBRID

253-000-256* Continuous Flow Resectoscope Sheath
Rotating inner sheath for 360° TURP/TURB.
Inner shaft with non reflecting, oblique ceramic tip.
RZ QuickLock mechanism, with Obturator

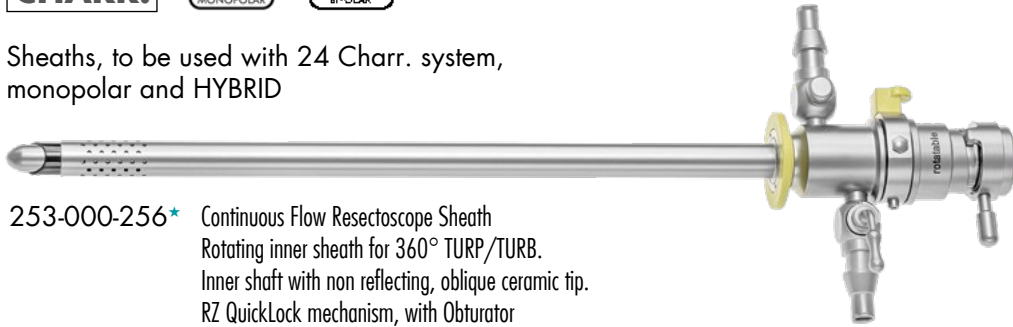

253-000-266 Inner Shaft, 24 Charr., with oblique ceramic tip for 253-000-256



253-000-356 Continuous Flow Resectoscope Sheath, fixed,
inner sheath with non reflecting, oblique ceramic tip.
RZ QuickLock mechanism, with obturator

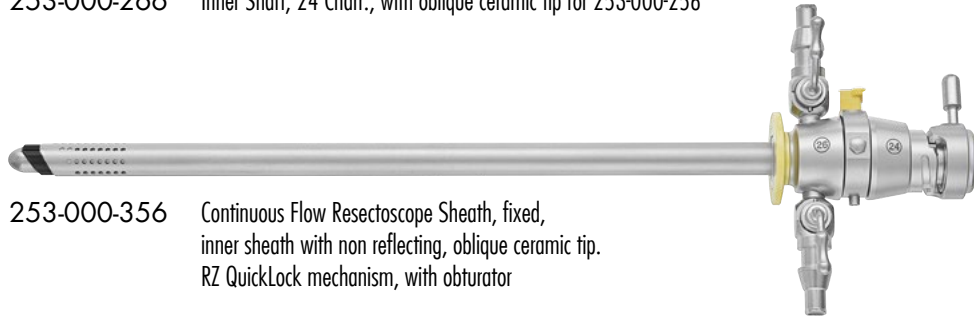

253-000-366 Inner Shaft with oblique ceramic tip, for 253-000-356



253-000-724 Central Valve Resectoscope Sheath, 24 Charr.,
oblique ceramic tip, with obturator

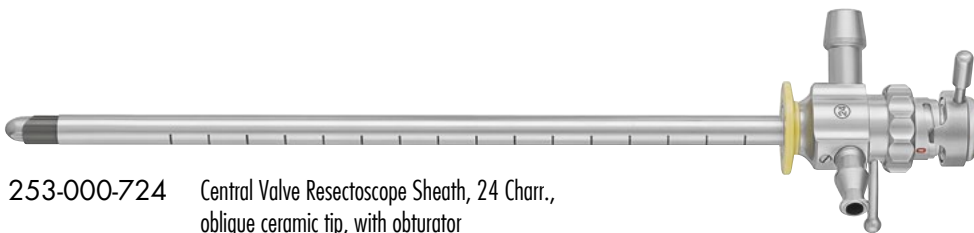

253-000-524 Resectoscope Sheath, 24 Charr.
oblique ceramic tip, with obturator

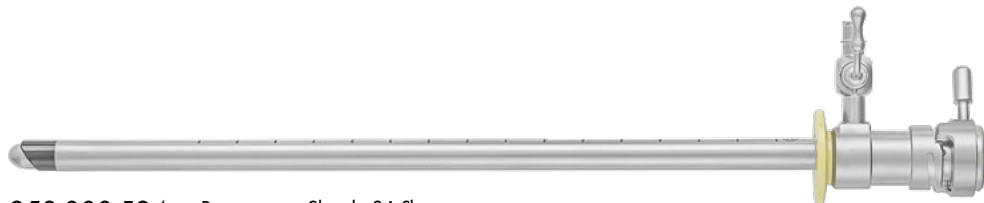

253-428-500 Adapter for resectoscope outer sheaths
253-000-256 and -356
and Elik or bladder syringes



24
CHARR.

HYBRID
HYBRID



Obturator, to be used with 24 Charr. system,
monopolar and HYBRID



253-000-044* Standard Obturator, for 24/26 Charr. resectoscope sheaths



253-000-054* Deflecting Obturator, for 24/26 Charr. resectoscope sheaths



253-000-084* Visual Obturator for 4mm RZ Cystoscopes,
for 24/26 Charr. resectoscope sheaths



253-000-094* Visual Obturator with 5 Charr. working channel,
for 4mm RZ Cystoscopes, for 24/26 Charr. resectoscope sheaths

24
CHARR.



Electrodes, to be used with
24 Charr. system



Cutting Loop, angled, for 12°/30° telescope

253-300-201*



Cutting Loop, 90° angled, for 0° telescope

253-300-222



Cutting Loop, straight in longitudinal direction

253-300-202



Coagulation Electrode, pointed

253-300-203*



Coagulation Electrode, conical

253-300-204



Coagulation Electrode, ball shape, Ø 3mm

253-300-205*



Coagulation Electrode, ball shape, Ø 5mm

253-300-206*



Coagulation Electrode, roller shape, Ø 3mm

253-300-207











Coagulation Electrode, roller shape, Ø 5mm

253-300-208



Electrodes, to be used with
24 Charr. system

	Spike Electrode, Ø 3mm		253-300-210
	Spike Electrode, Ø 5mm		253-300-209
	Roller-Electrode, Ø 3mm		253-300-212
	Roller-Electrode, Ø 5mm		253-300-211
	Band Vapor Electrode, 1.2 mm width		253-300-213
	Band Vapor Electrode, 90° angled		253-300-214
	Band Vapor Electrode		253-300-215
	Curette, sharp, for use without HF		253-300-218
	Needle Electrode		253-300-219

24
CHARR.



Sterile disposable Electrodes,
to be used with 24 Charr. system



STERILE EO

Sales unit: package with 6 pieces,
each individually sterile packed.



Cutting Loop, angled, for 12°/30° telescope

253-300-201S*



Collins knife electrode

253-300-203S*



Ball electrode, Ø 3mm

253-300-205S*



Ball electrode, Ø 5mm

253-300-206S*

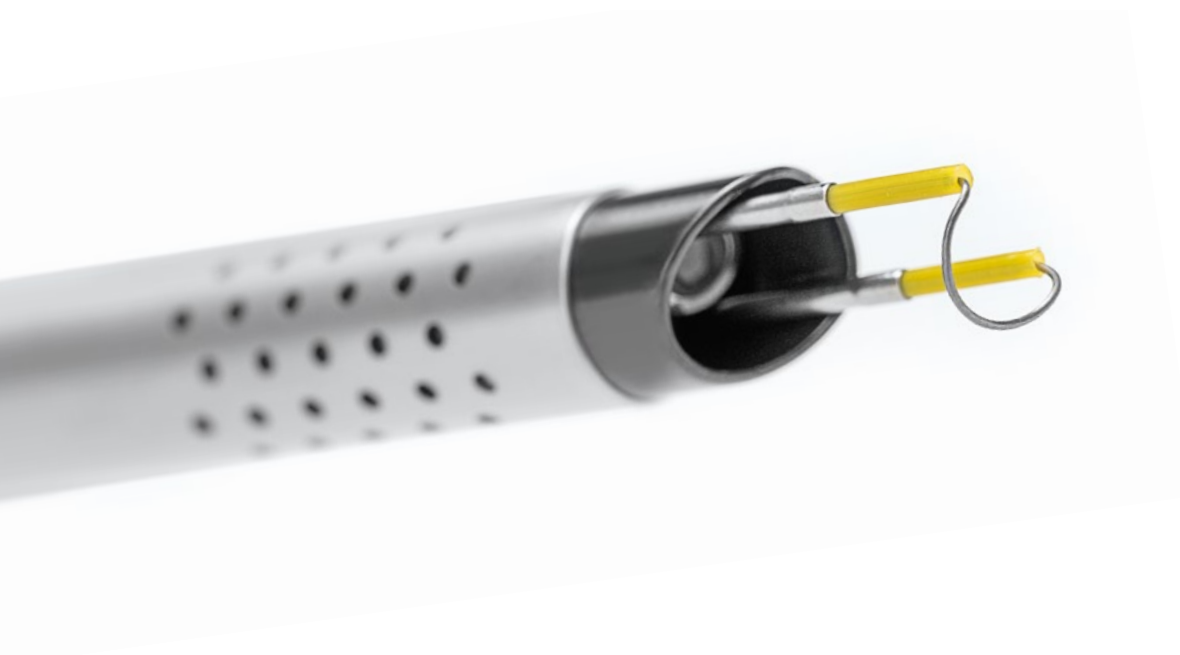

24
CHARR.

HYBRID
HYBRID



HYBRID Electrodes, to be used with 24 Charr. system

- Works in bipolar and monopolar mode
- Made of a standard wire of \varnothing 0.35mm



Cutting Loop, angled, for 12°/30° telescope

253-400-200



Cutting Loop, angled, for 12°/30° telescope

253-400-201*



Cutting Loop, thick wire, angled, for 12°/30° telescope

253-400-202



Collins Coagulation Electrode, pointed

253-400-203*



Coagulation Electrode, conical

253-400-204



Coagulation Electrode, ball shape, \varnothing 3mm

253-400-205*



Roller-Electrode, \varnothing 3mm

253-400-211



Cutting Loop, 90° angled, for 0° telescope

253-400-222



Coagulation Electrode, ball shape, \varnothing 5mm

253-400-206

24
CHARR.

HYBRID
HYBRID



HYBRID „Mushroom“ Electrodes, to be used with 24 Charr. system, only for bipolar use with NaCl



„Mushroom“ Electrode, blunt/flat

253-400-701

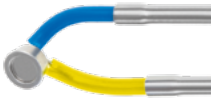

„Mushroom“ Electrode, blunt with slot, concave

253-400-702

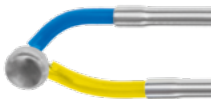

„Mushroom“ Electrode,
half-round (convex), Ø 3mm, length 1.9mm

253-400-703

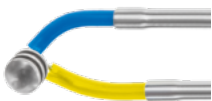

„Mushroom“ Electrode,
half-round (convex), Ø 3mm, length 2.5mm

253-400-704

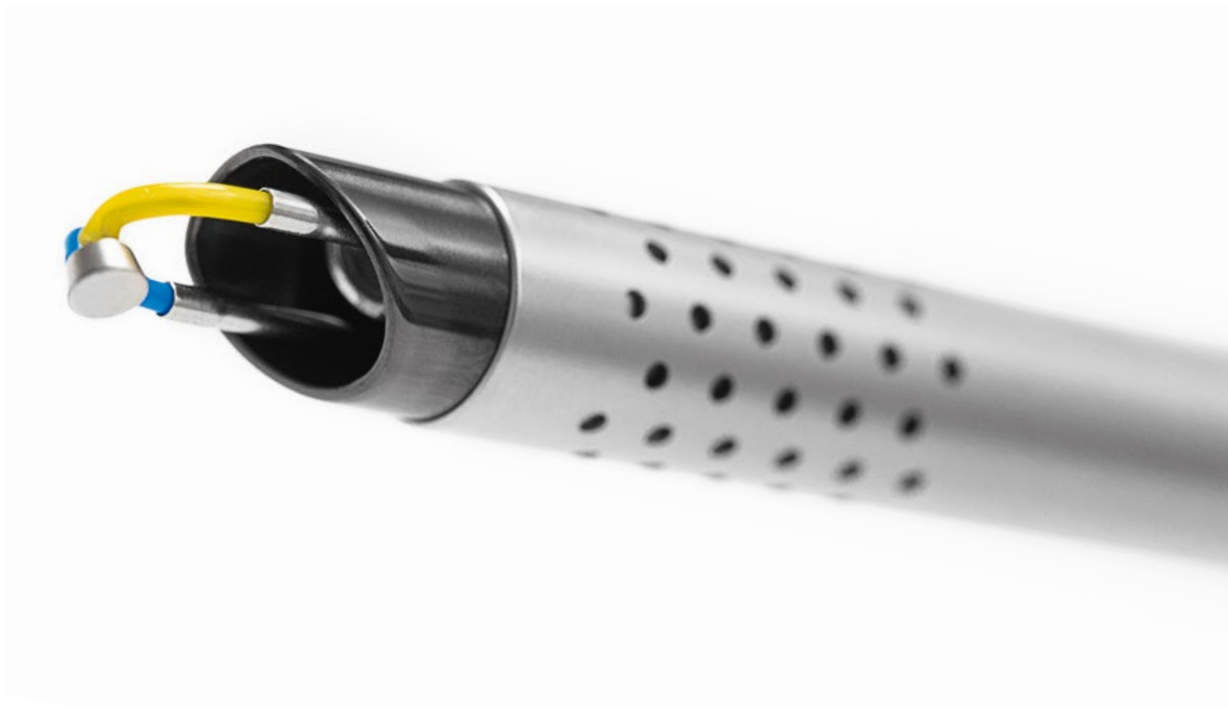



XL RESECTOSCOPE

◀ 245mm working length ▶



253-804-530 XL Cystoscope, Ø 4mm, 30° direction of view, 365mm length



253-000-251 XL active working element, Titanium, for use with 253-804-530 and 253-000-666

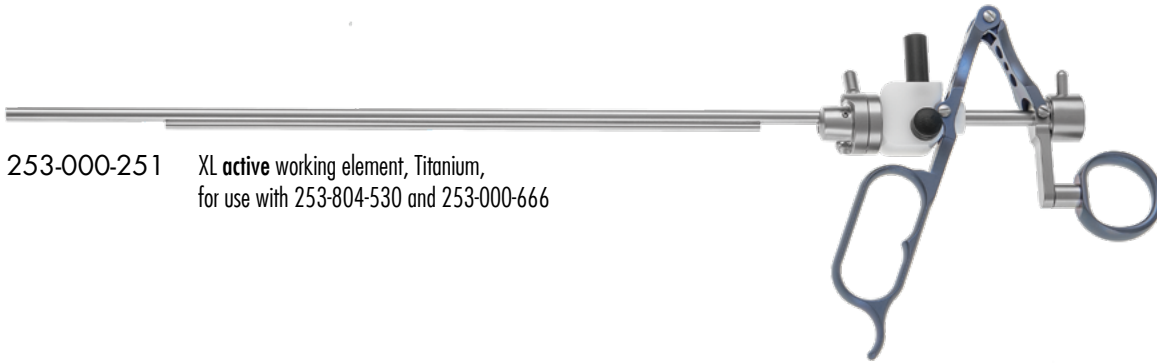

253-000-250 XL passive working element, Titanium, for use with 253-804-530 and 253-000-666

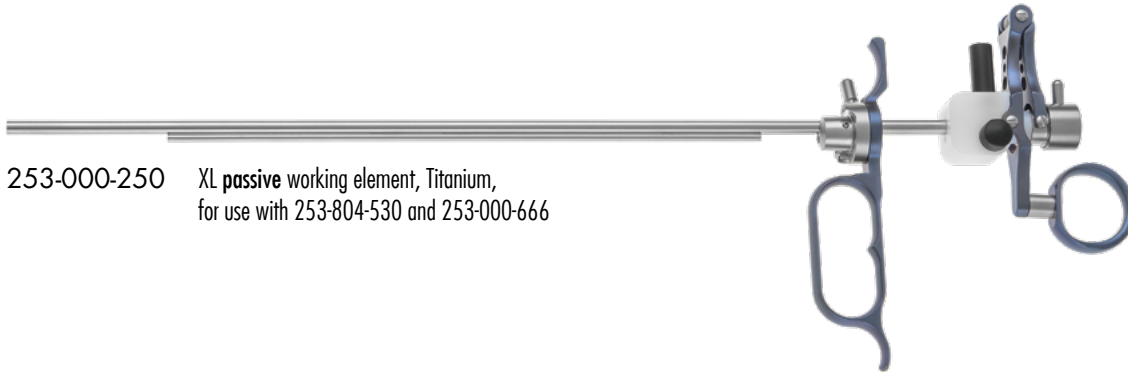

253-000-666 XL Resectoscope Sheath, continuous flow, rotating, for use with 253-000-251/-250 and 253-804-530

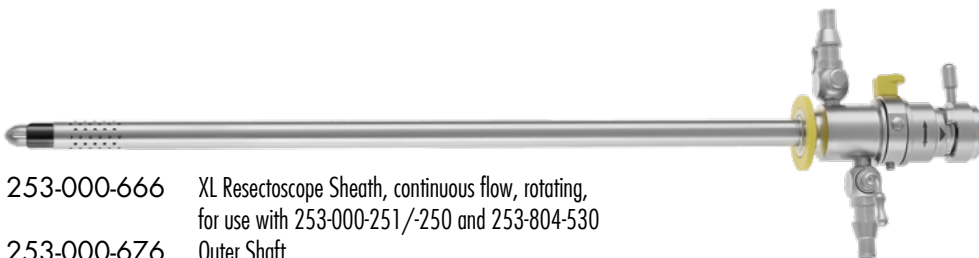







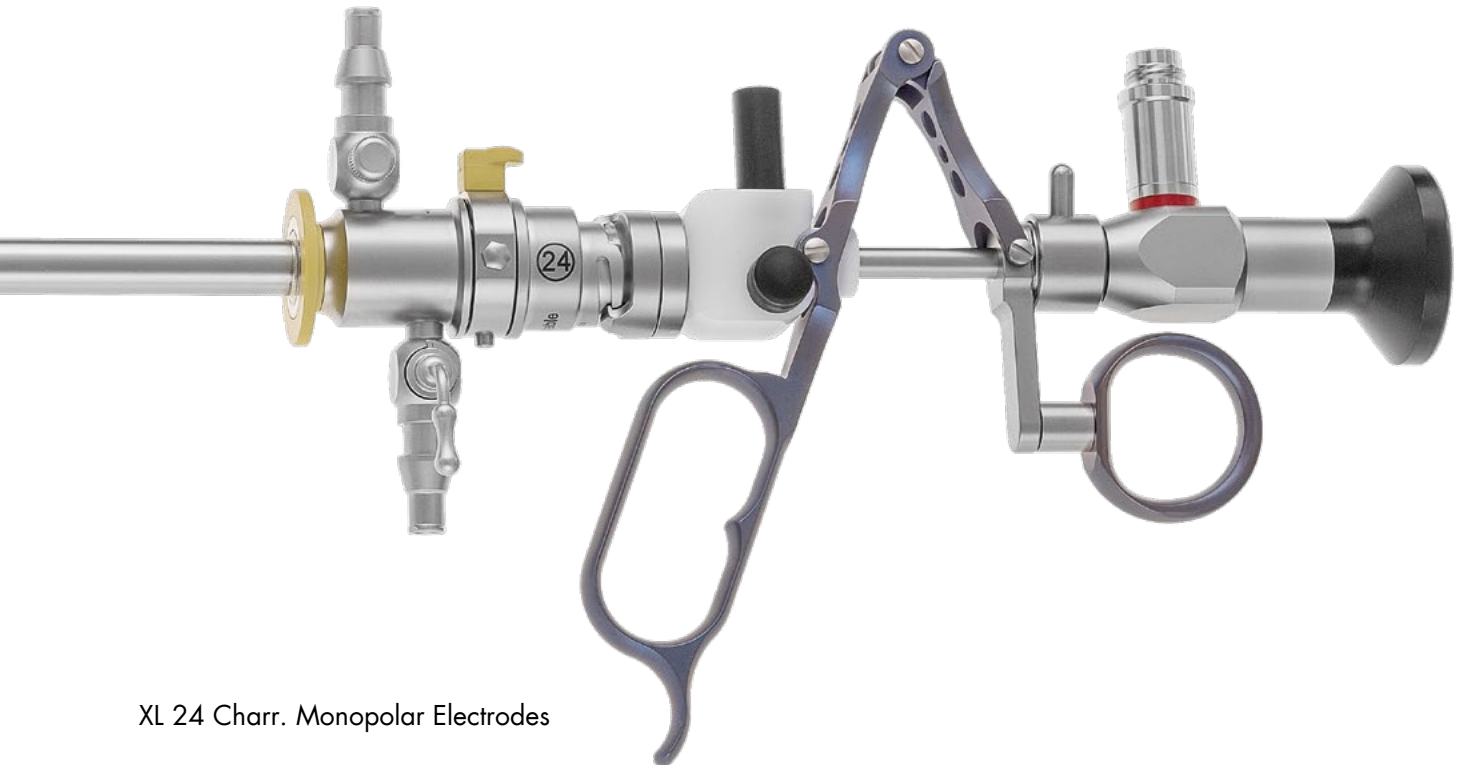

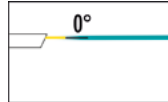

253-000-676 Outer Shaft

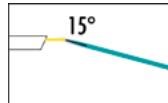
253-000-677 Inner Shaft

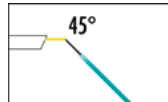
253-000-678 Obturator

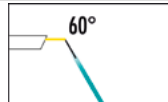

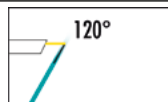
XL 24 Charr. Monopolar Electrodes

	Cutting Loop, straight		253-300-252
	Cutting Loop, 15° angled		253-300-253
	Cutting Loop, 45° angled		253-300-255
	Cutting Loop, 60° angled		253-300-256
	Cutting Loop, 120° angled		253-300-251
	Roller Electrode		253-300-258
	Kife Electrode		253-300-259

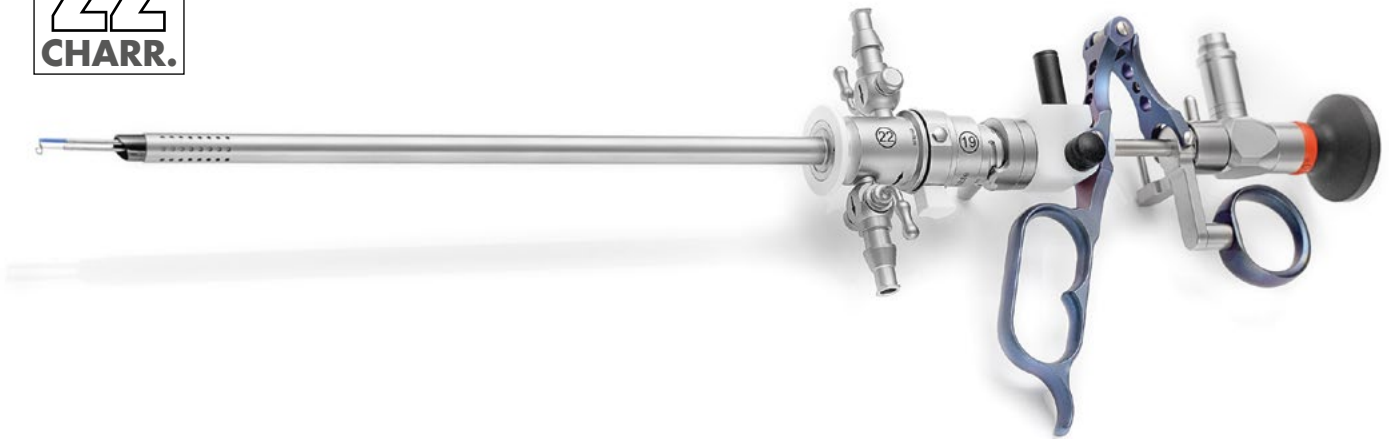

Endoscopes, suitable for HYBRID 22 Charr. System

∅
2.9 mm

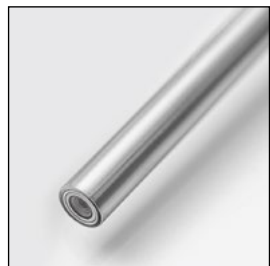

0° DIRECTION OF VIEW

300mm working length
356mm overall length 351-829-000



12° DIRECTION OF VIEW

300mm working length
356mm overall length 351-829-012



30° DIRECTION OF VIEW

300mm working length
356mm overall length 351-829-030



Monopolar Working Elements

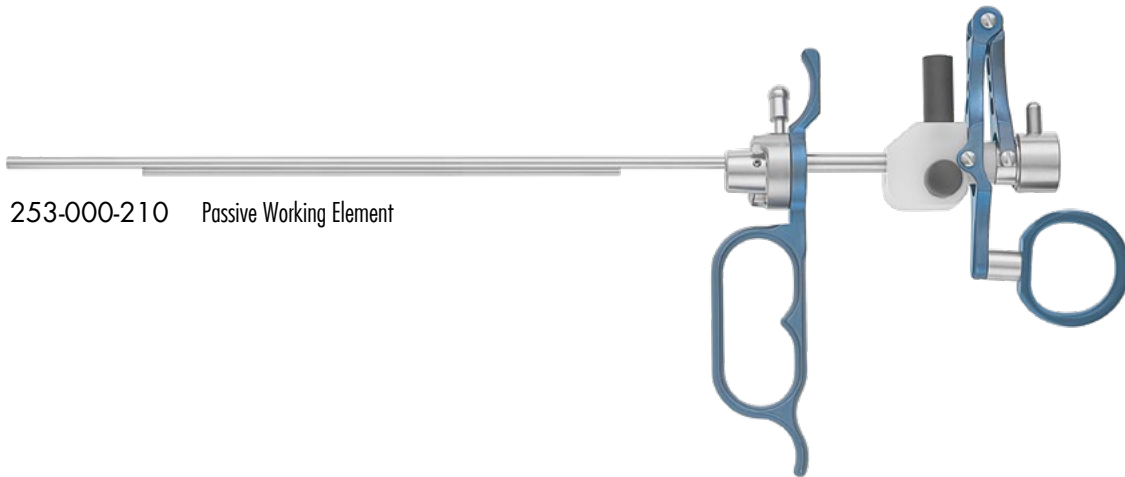

253-000-210 Passive Working Element

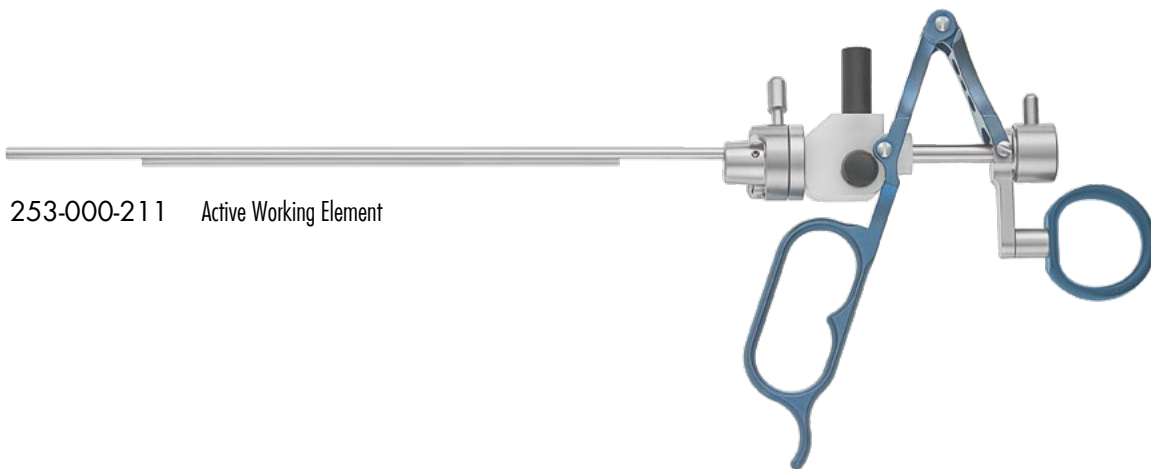

253-000-211 Active Working Element

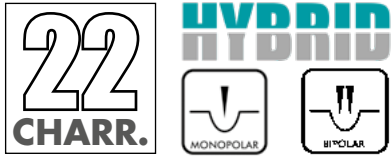

Hybrid Working Elements and Sheath suitable for HYBRID 22 Charr. System

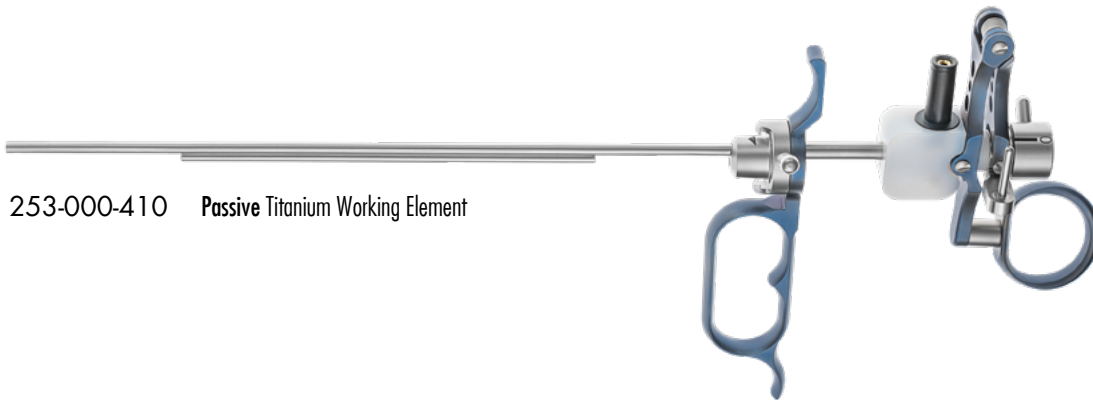

253-000-410 **Passive** Titanium Working Element

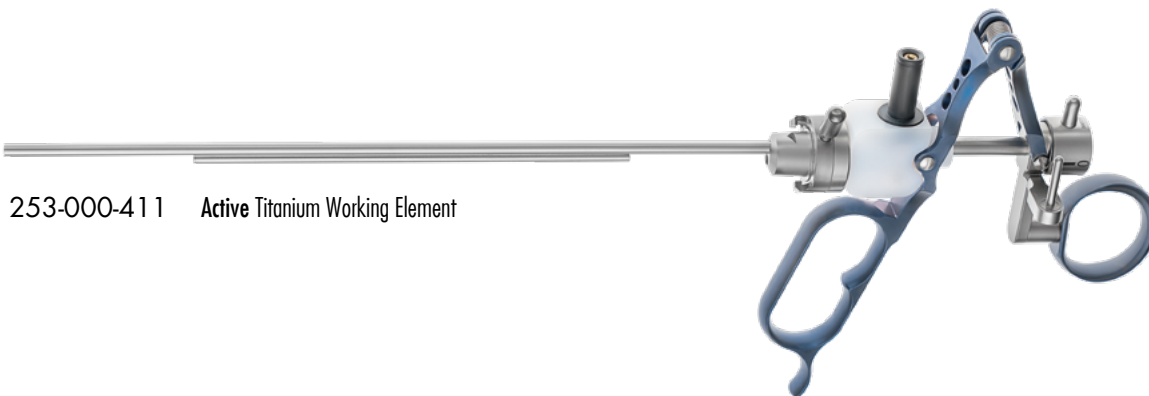

253-000-411 **Active** Titanium Working Element

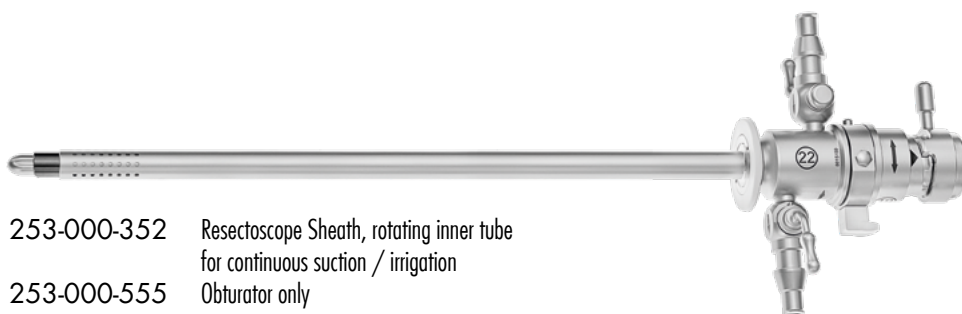





253-000-352 Resectoscope Sheath, rotating inner tube for continuous suction / irrigation







253-000-555 Obturator only



Monopolar Electrodes, suitable for HYBRID 22 Charr. System

	Cutting Loop, angled	253-000-501
	Cutting Loop, straight	253-000-502
	Coagulation Electrode, Knife	253-000-503
	Coagulation Electrode, Ball	253-000-505
	Coagulation Electrode, Roller	253-000-507

Electrodes, suitable for HYBRID 22 Charr. System

		
	Cutting Loop, 30° angled	253-000-541
	Cutting loop, straight	253-000-542
	Knife Electrode	253-000-543
	Ball Electrode	253-000-545
	Roller Electrode, Ø 3mm	253-000-547

18.5
CHARR.

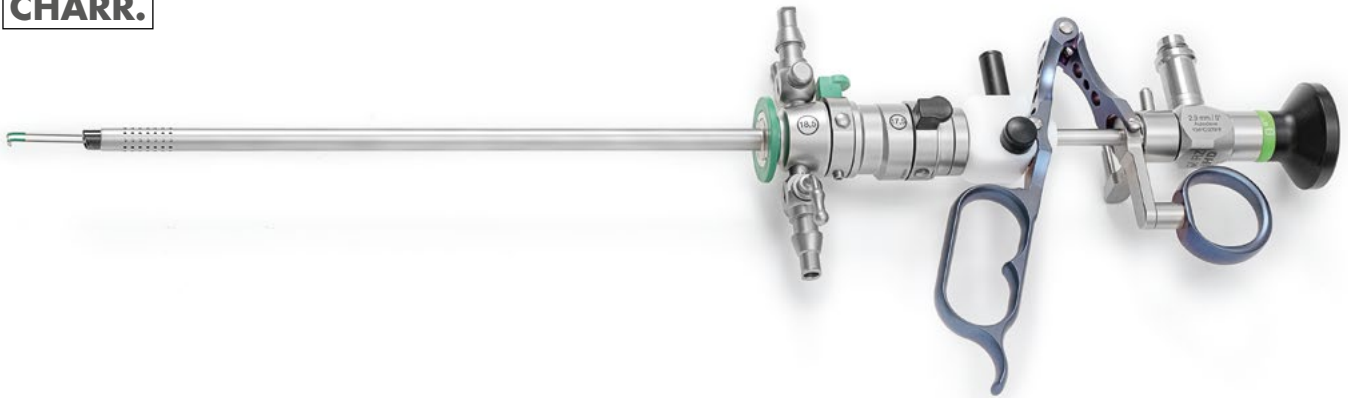

Endoscopes, suitable for HYBRID 18.5 Charr. System

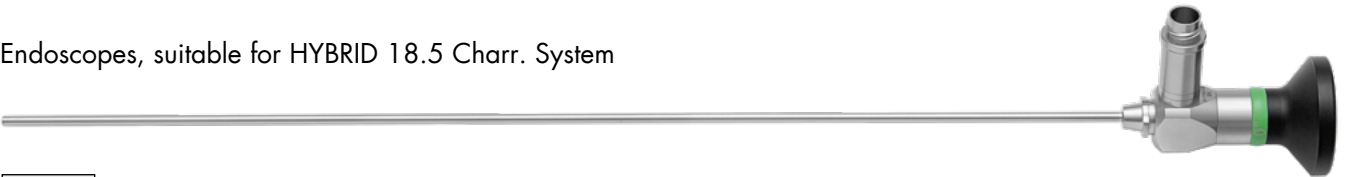

∅
2.9 mm



0° DIRECTION OF VIEW

300mm working length
356mm overall length 351-829-000



12° DIRECTION OF VIEW

300mm working length
356mm overall length 351-829-012



30° DIRECTION OF VIEW

300mm working length
356mm overall length 351-829-030



Working Elements and Sheaths,
suitable for HYBRID 18.5 Charr. System



351-400-200 Passive Titanium Working Element

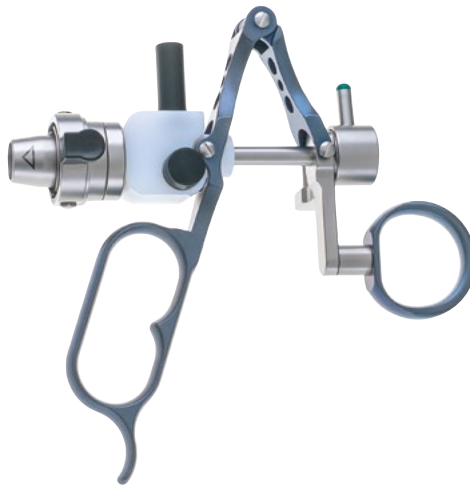

351-400-201 Active Titanium Working Element

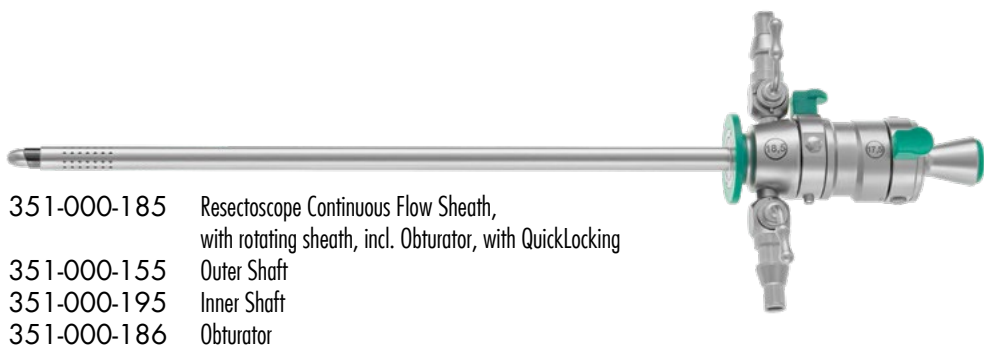

- 351-000-185 Resectoscope Continuous Flow Sheath,
with rotating sheath, incl. Obturator, with QuickLocking
- 351-000-155 Outer Shaft
- 351-000-195 Inner Shaft
- 351-000-186 Obturator

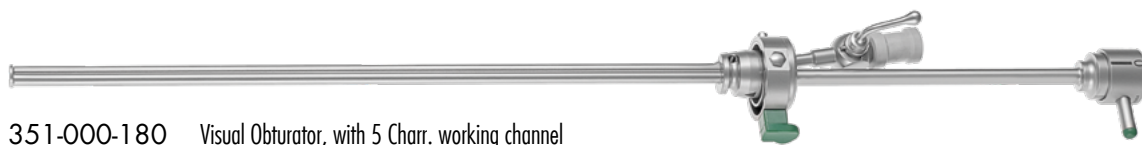

351-000-180 Visual Obturator, with 5 Charr. working channel



Electrodes, 16 Charr., suitable for HYBRID 18.5 Charr. System



Cutting Loop

351-000-201



Cutting loop, straight

351-000-202



Cutting loop, straight

351-000-203



Ball Electrode

351-000-205



Roller Electrode, 2mm

351-000-206



HIGH FREQUENCY CABLES for RZ resectoscope systems, 4.5m length



253-610-001* with 5 mm plug for Erbe HF-unit

253-610-002* with 4 mm plug for Martin HF-unit

253-610-003* with 8 mm plug for Valleylab HF-unit

253-610-004* with 4 mm plug for older HF-units

700-501-453* SDS plug

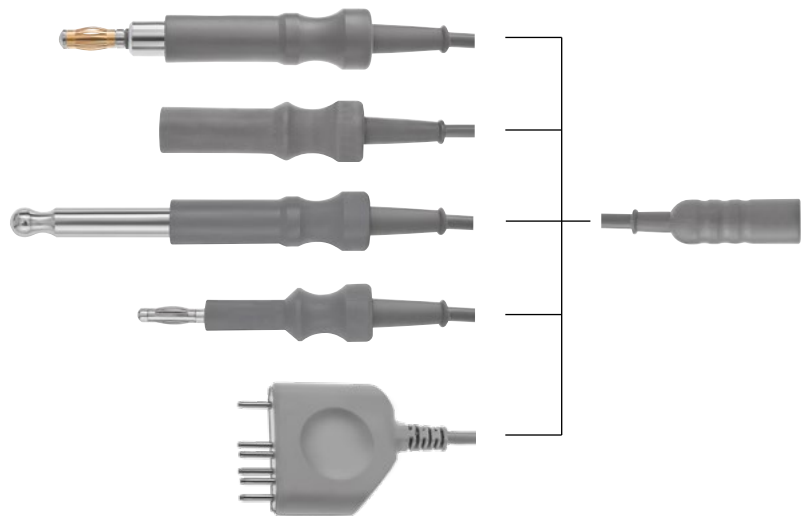

253-400-601 for Erbe HF-unit

253-400-602 for Martin HF-unit

700-500-453 SDS plug

253-400-606 for BOWA

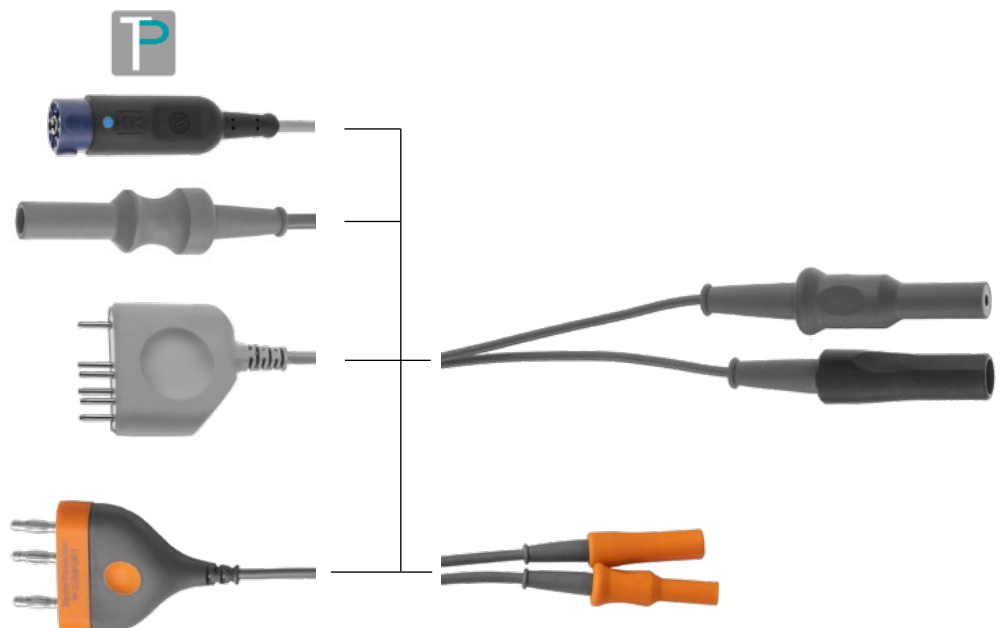

SUPRAPUBIC TROCAR SET

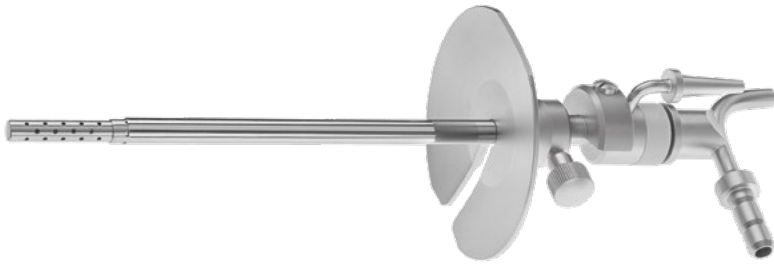

253-400-501 Trocar Sheath, 16 Charr., with pressure channel and spare silicone sealings



253-400-503 Suprapubic Trocar with pyramidal tip



253-400-504 Suprapubic Trocar with cannula tip



253-400-505 Aspiration Cannula



253-400-506 Overflow Cannula



253-400-508 Trocar guide sheath, lateral open

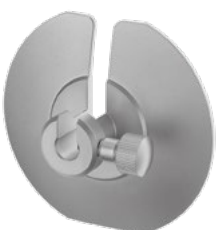

253-400-502 Suprapubic Trocar Stabilizing Plate, lateral open

LASER ENUCLEATION

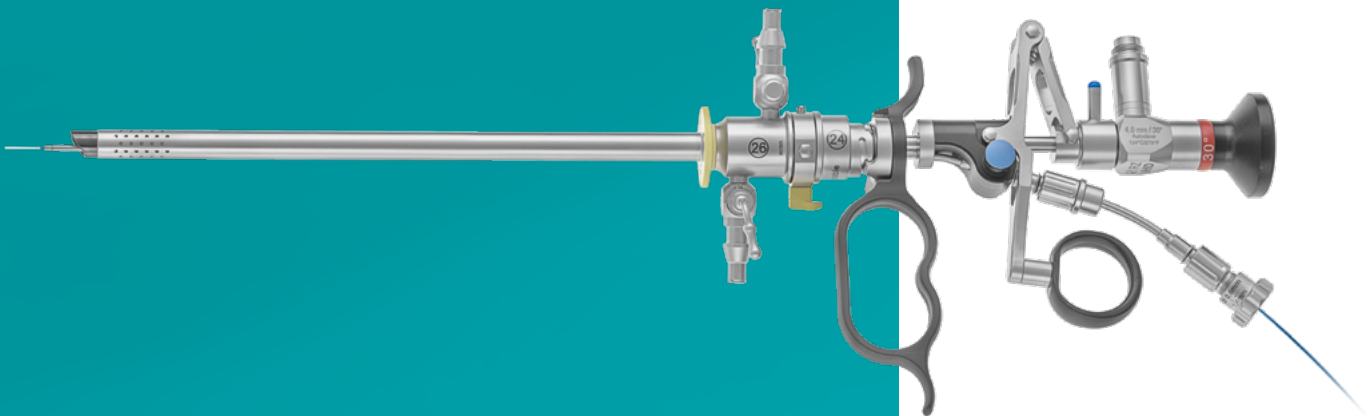

LASER ENUCLEATION

Holmium laser prostate surgery is a minimally invasive treatment for Benign Prostate Hyperplasia (BPH). Laser enucleation of the prostate uses a laser resectoscope to enucleate the prostate tissue that is blocking urine flow. A morcellator which passes through the morcescope is then used to cut the prostate and remove the adenoma.

As with other types of prostate laser surgery, Laser enucleation can offer faster recovery, less risk of bleeding and transfusion and better symptom relief compared to traditional prostate surgery.

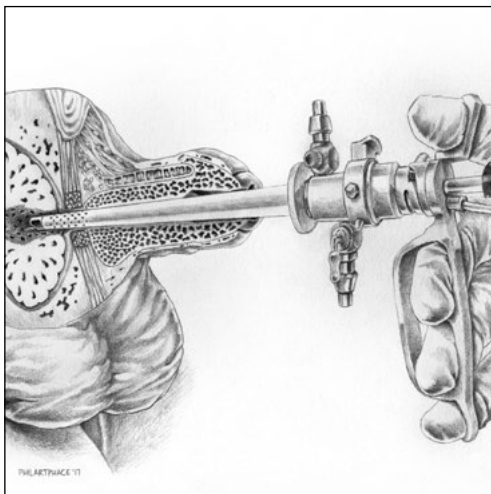

Sheaths for Laser applications
from 26 to 18.5 Charr.



Front Fire Laser resection



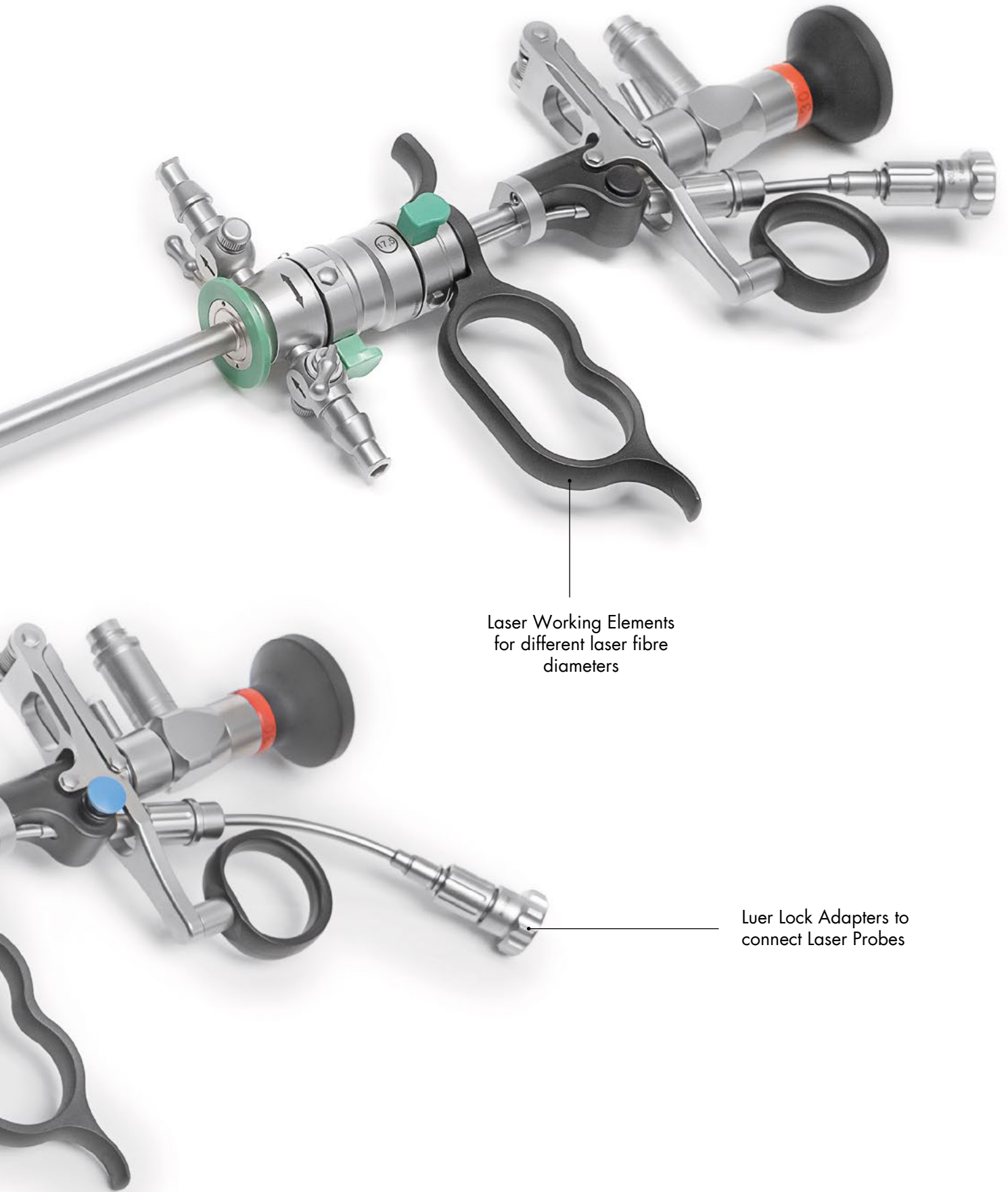

Laser Working Elements
for different laser fibre
diameters

Luer Lock Adapters to
connect Laser Probes

LASER ENUCLEATION SETS FRONT FIRE

HoLEP / ThuLEP / Overview

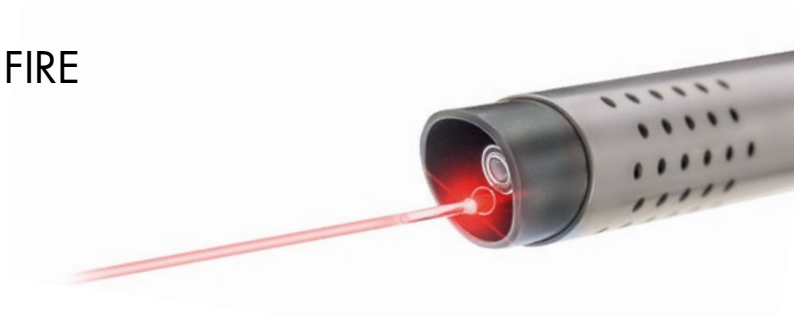

24
CHARR.

22
CHARR.

18.5
CHARR.



253-804-000 0°
253-804-012 12°
253-804-030 30°



351-829-000 0°
351-829-012 12°
351-829-030 30°



351-829-000 0°
351-829-012 12°
351-829-030 30°

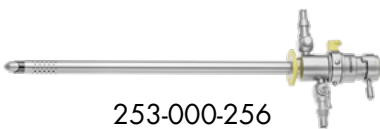

253-000-256

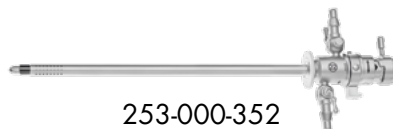

253-000-352

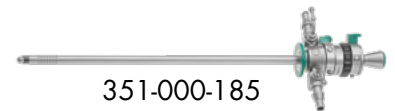

351-000-185

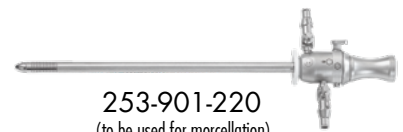

253-901-220
(to be used for morcellation)



253-000-300 fibers up to 0.8mm
253-000-312 fibers up to 1.2mm



253-000-319 fibers up to 0.8mm
253-000-316 fibers up to 1.2mm



253-000-318 fibers up to 0.8mm



253-000-305



253-900-121



253-905-220



253-905-220

24
CHARR.

HoLEP Set

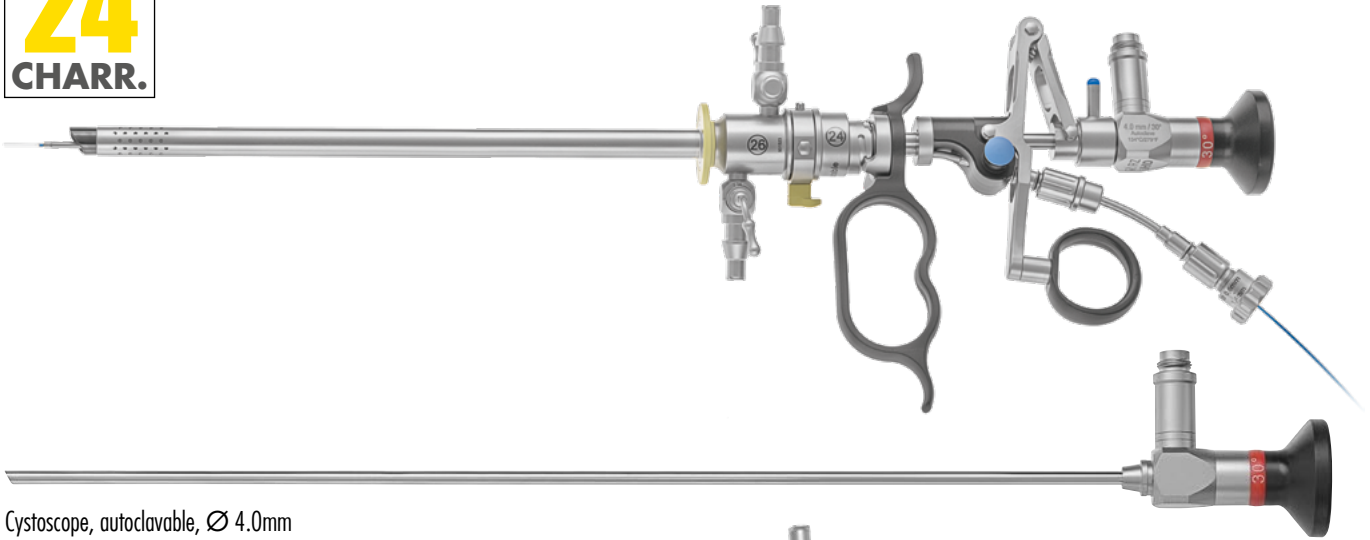

Cystoscope, autoclavable, Ø 4.0mm
 253-804-030 30° direction of view
 253-804-012 12° direction of view

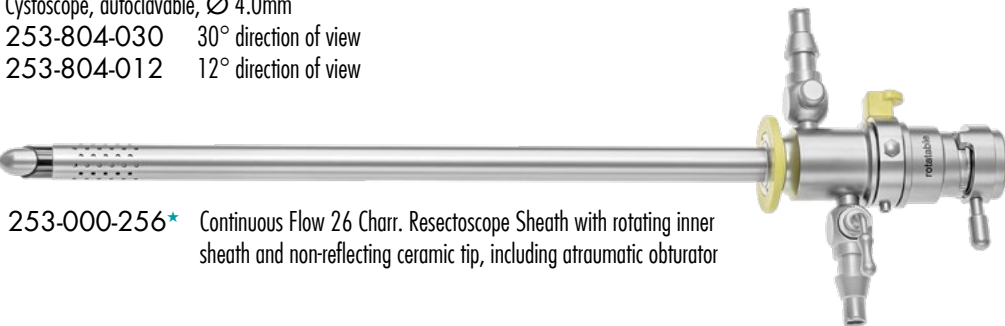

253-000-256* Continuous Flow 26 Charr. Resectoscope Sheath with rotating inner sheath and non-reflecting ceramic tip, including atraumatic obturator



253-000-266 Inner shaft, 24Charr., with oblique ceramic tip for 253-000-256

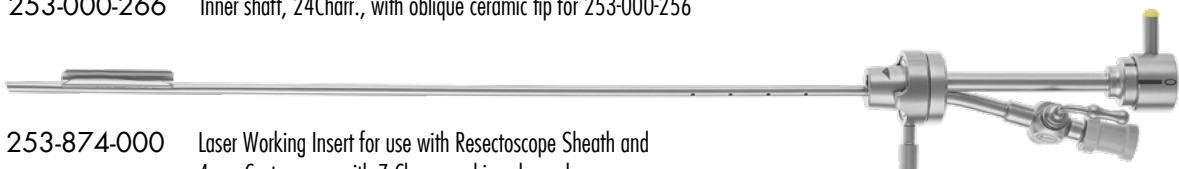

253-874-000 Laser Working Insert for use with Resectoscope Sheath and 4mm Cystoscope, with 7 Charr. working channel



RZ Laser Working Element, passive, for laser-probes
 253-000-300 for fibres up to 0.8mm
 253-000-312* for fibres up to 1.2mm



300-011-184* Luer-Lock Tuohy Borst Adapter (Ø 0.6 - 1.4mm)



RZ LL-Connection, rotatable for use with Laser Probe
 253-000-301* short
 253-000-302 long

24
CHARR.

HoLEP Set

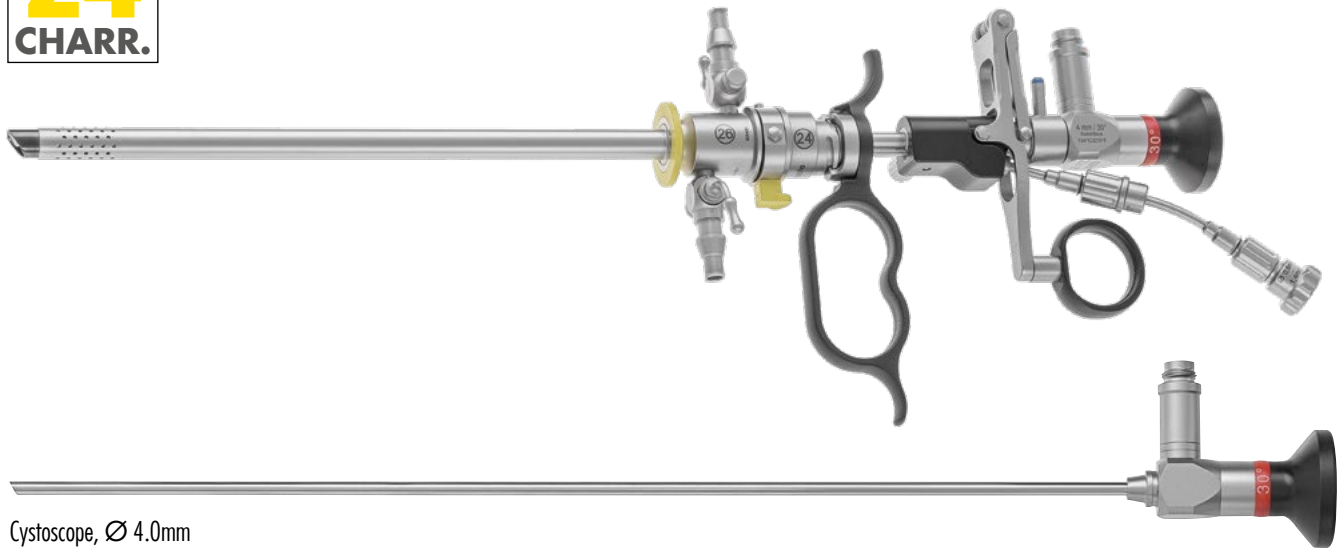

Cystoscope, Ø 4.0mm

253-804-030 30° direction of view

253-804-012 12° direction of view

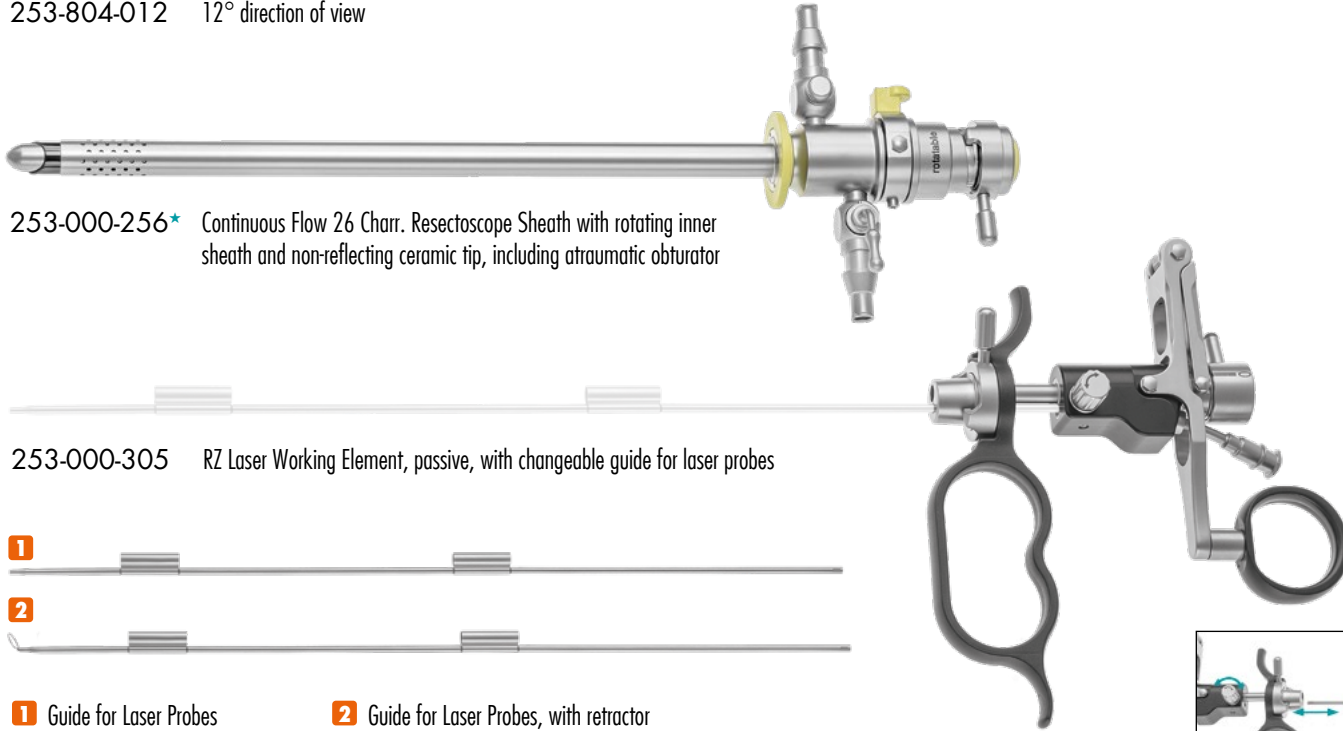

253-000-256* Continuous Flow 26 Charr. Resectoscope Sheath with rotating inner sheath and non-reflecting ceramic tip, including atraumatic obturator

253-000-305 RZ Laser Working Element, passive, with changeable guide for laser probes

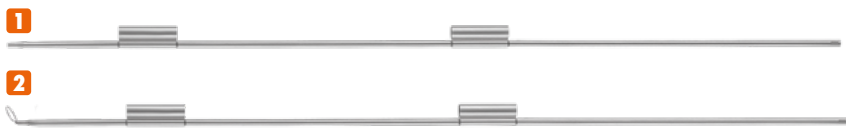

1 Guide for Laser Probes

- 253-000-320 0.8mm
- 253-000-321 1.0mm
- 253-000-322 1.2mm
- 253-000-323 1.4mm

2 Guide for Laser Probes, with retractor

- 253-000-330 0.8mm
- 253-000-331 1.0mm
- 253-000-332 1.2mm
- 253-000-333 1.4mm

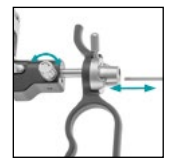

detachable



300-011-184* Luer-Lock Tuohy Borst Adapter (Ø 0.6 - 1.4mm)

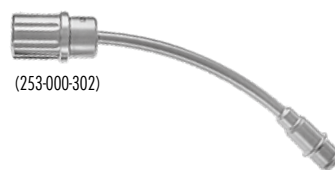

(253-000-302)

RZ LL-Connection, rotatable for use with Laser Probe
253-000-301* short
253-000-302 long

24
CHARR.

XL Laser Resection

◀ 245mm working length ▶

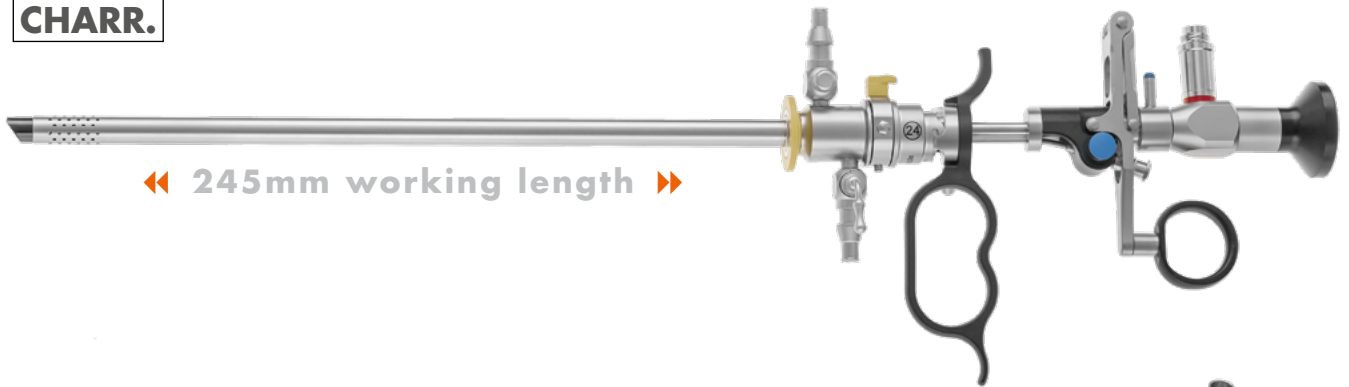

253-804-530 XL Cystoscope, Ø 4mm, 30° direction of view, 365mm length



253-000-666 XL Resectoscope Sheath, continuous flow, rotating, for use with 253-000-251/-250 and 253-804-530

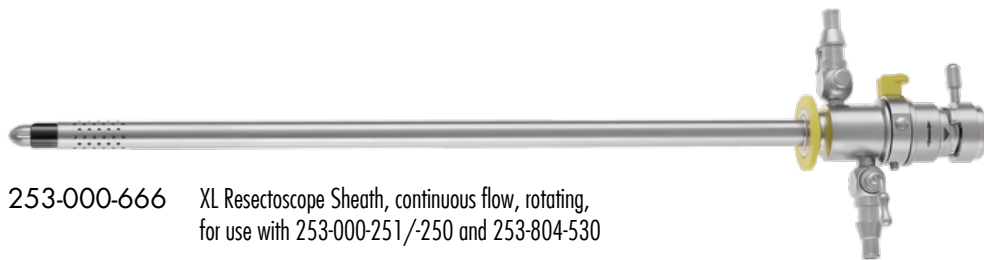

253-000-350 XL Laser Working Element for fibers Ø1.2mm, passive

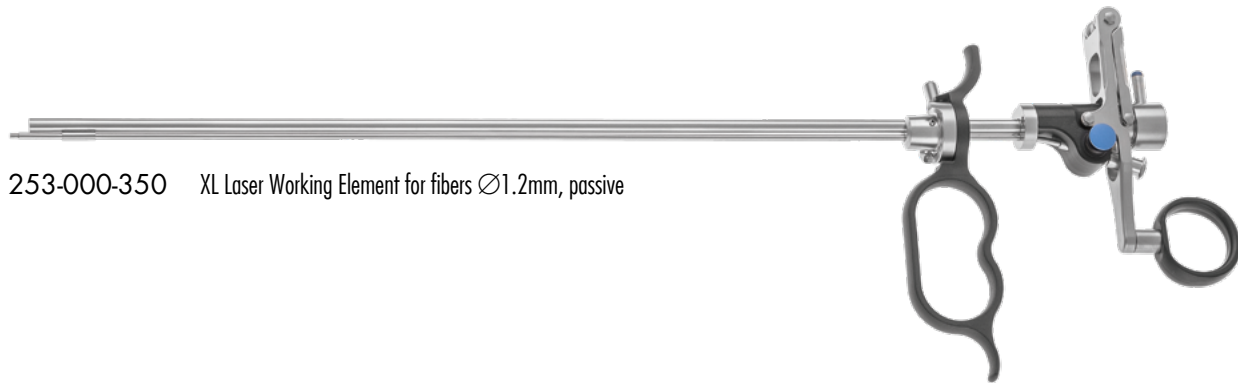



HoLEP MiLEP Set acc. Dr. Felipe C. A. de Figueiredo



Cystoscope, Ø 2.9mm
 253-829-030 30° direction of view
 253-829-012 12° direction of view

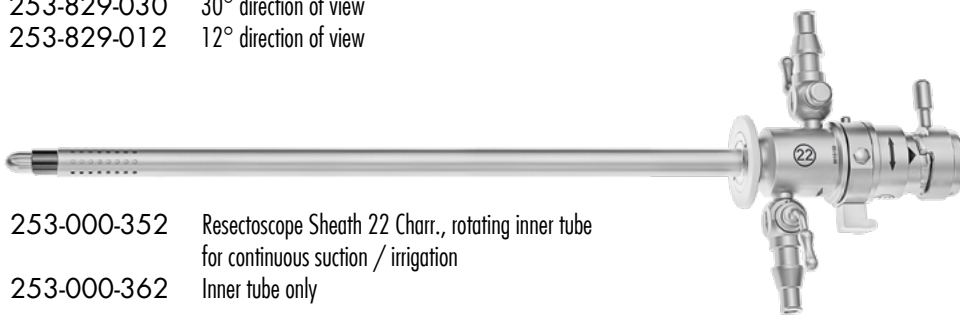

253-000-352 Resectoscope Sheath 22 Charr., rotating inner tube
 for continuous suction / irrigation
 253-000-362 Inner tube only



253-000-082 Visual Obturator, 22 Charr.



RZ Laser Working Element, passive, for laser-probes
 253-000-319 for fibres up to 0.8mm
 253-000-316 for fibres up to 1.2mm



300-011-184* Luer-Lock Tuohy Borst Adapter (Ø 0.6 - 1.4mm)

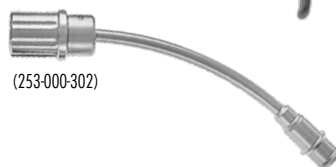

(253-000-302)

RZ LL-Connection, rotatable
 for use with Laser Probe
 253-000-301* short
 253-000-302 long

18.5
CHARR.

HoLEP
Figueiredo

MiLEP Set acc. Dr. Felipe C. A. de Figueiredo

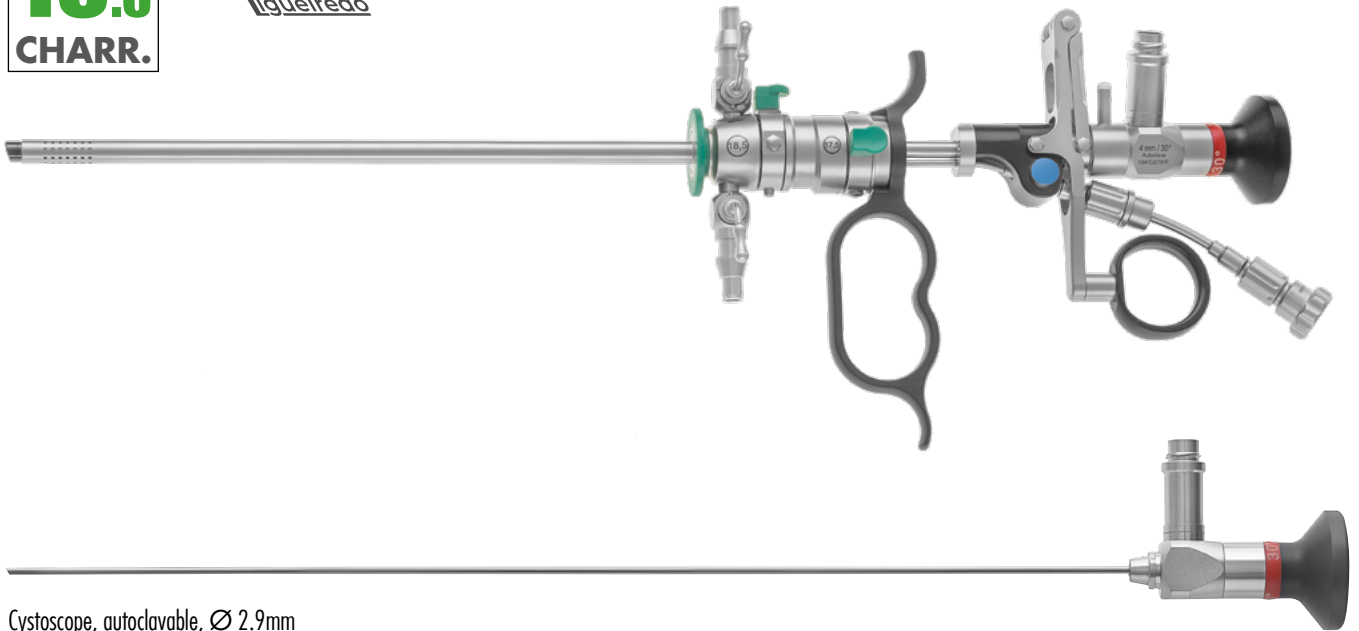

Cystoscope, autoclavable, Ø 2.9mm
253-829-030 30° direction of view
253-829-012 12° direction of view

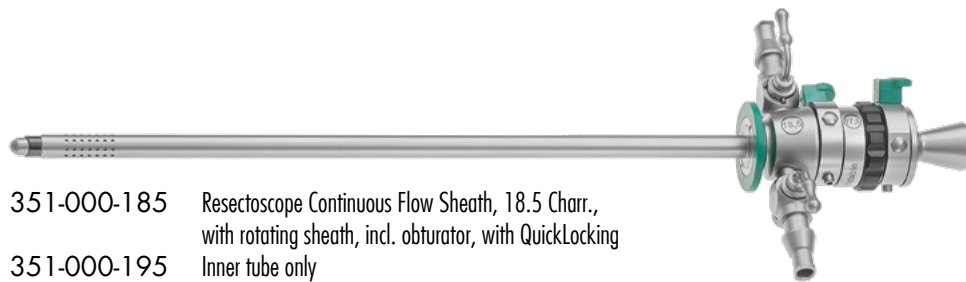

351-000-185 Resectoscope Continuous Flow Sheath, 18.5 Charr.,
with rotating sheath, incl. obturator, with QuickLocking
351-000-195 Inner tube only



253-000-318 RZ Laser Working Element, passive,
for laser-probes with fibres up to 0.8mm



300-011-184* Luer-Lock Tuohy Borst Adapter (Ø 0.6 - 1.4mm)



(253-000-302)

RZ LL-Connection, rotatable
for use with Laser Probe
253-000-301* short
253-000-302 long

24
CHARR.

TISSUE MORCELLATION

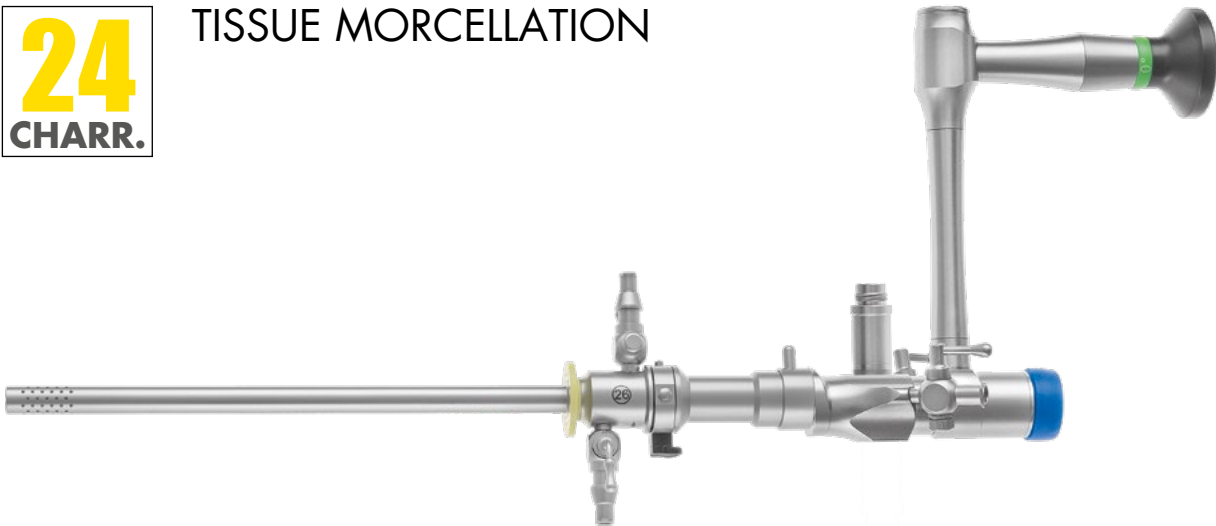

253-900-121* Nephroscope 6°, oval instrument channel, parallel eye piece, 250mm working length

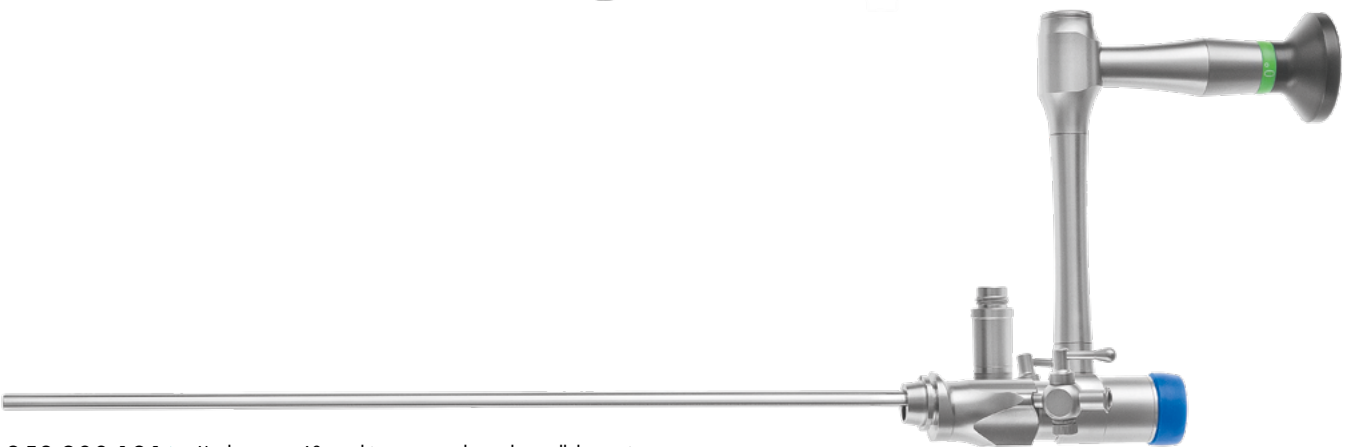

253-000-256* Continuous Flow 26 Charr. Resectoscope Sheath with rotating inner sheath and non-reflecting ceramic tip, including atraumatic obturator

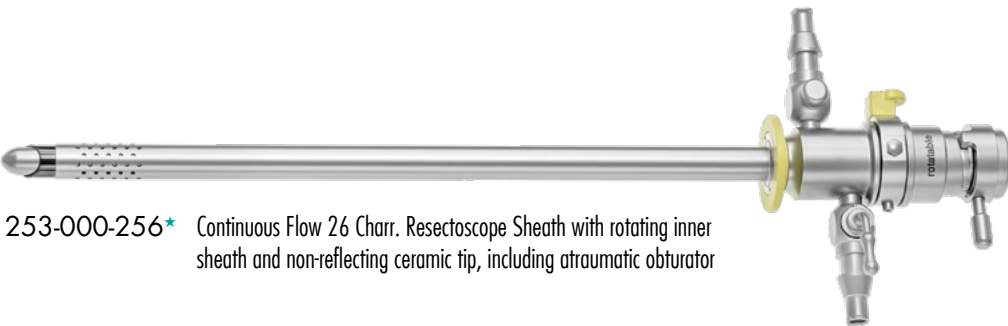

253-428-100* Adapter for use with RZ Nephroscopes and Resectoscope Outer sheaths 253-000-356/-256

22
CHARR.

HoLEP_K Morcescope

acc. Dr. Felipe C. A. de Figueiredo

Figueiredo

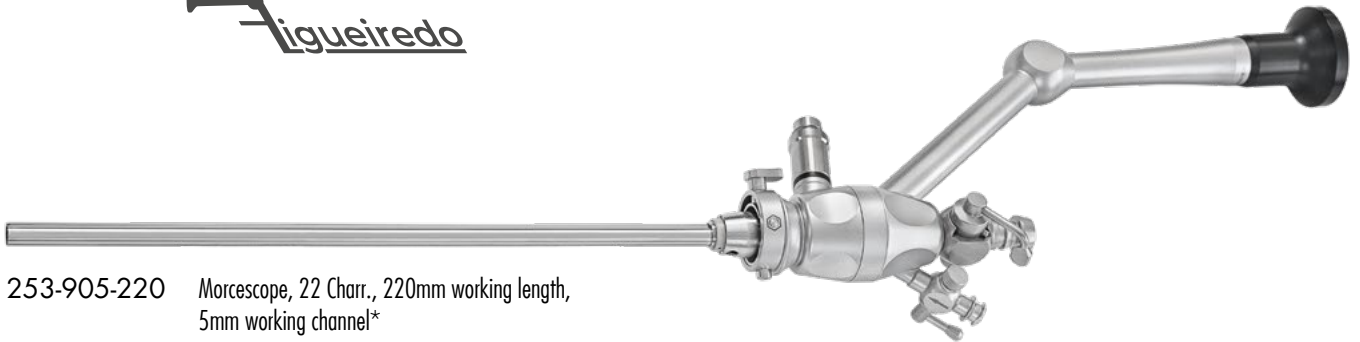

253-905-220 Morcescope, 22 Charr., 220mm working length, 5mm working channel*

18.5
CHARR.

* to be used for morcellation after laser enucleation with 18.5 Charr. Resectoscope

HoLEP_K

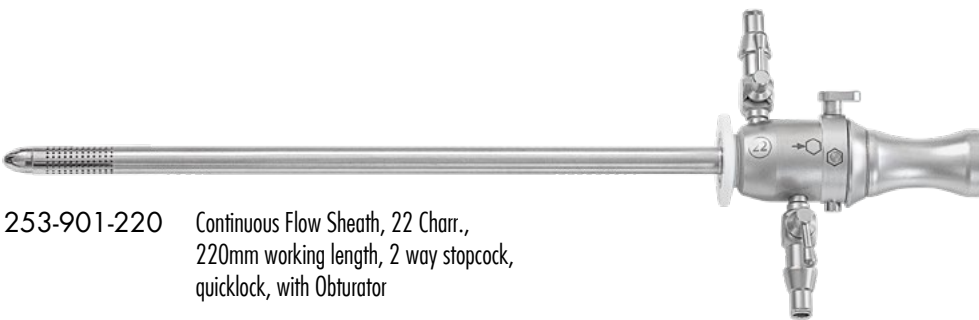

253-901-220 Continuous Flow Sheath, 22 Charr., 220mm working length, 2 way stopcock, quicklock, with Obturator



253-904-220 Sealing Cap for Morcescope, with membrane to puncture through, package of 10 pieces

Suitable sterilization trays can be found on page 120



UNIVERSAL LASER CYSTOSCOPE SET

Side fire, compatible with all laser fibres up to 2.5mm
for PVP, HoLEP & ThuVAP

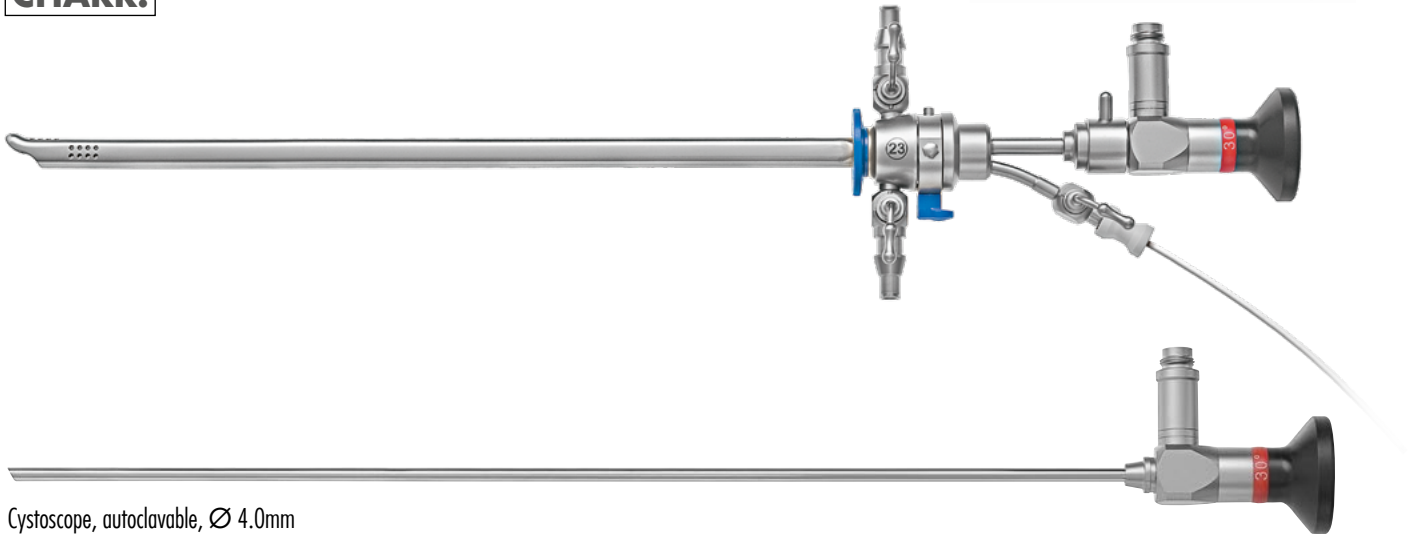

Cystoscope, autoclavable, Ø 4.0mm
253-804-030 30° direction of view
253-804-012 12° direction of view

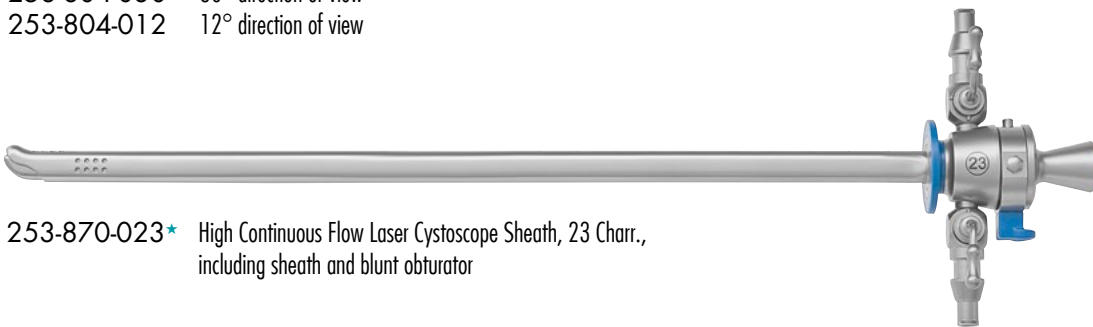

253-870-023* High Continuous Flow Laser Cystoscope Sheath, 23 Charr., including sheath and blunt obturator

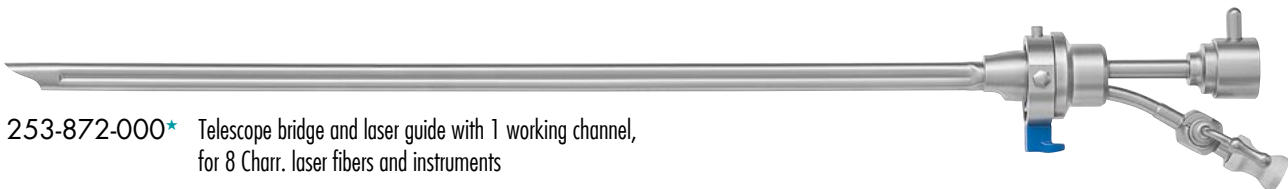

253-872-000* Telescope bridge and laser guide with 1 working channel, for 8 Charr. laser fibers and instruments

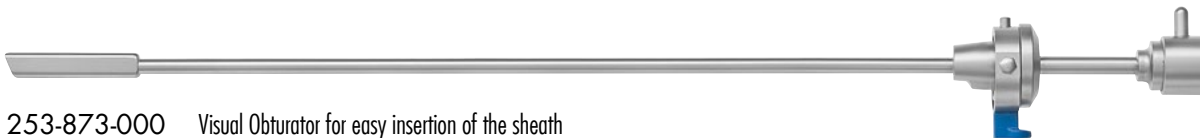

253-873-000 Visual Obturator for easy insertion of the sheath into the urethra and bladder

24
CHARR.

LASER RESECTION SET for PVP, HoLEP & ThuVAP

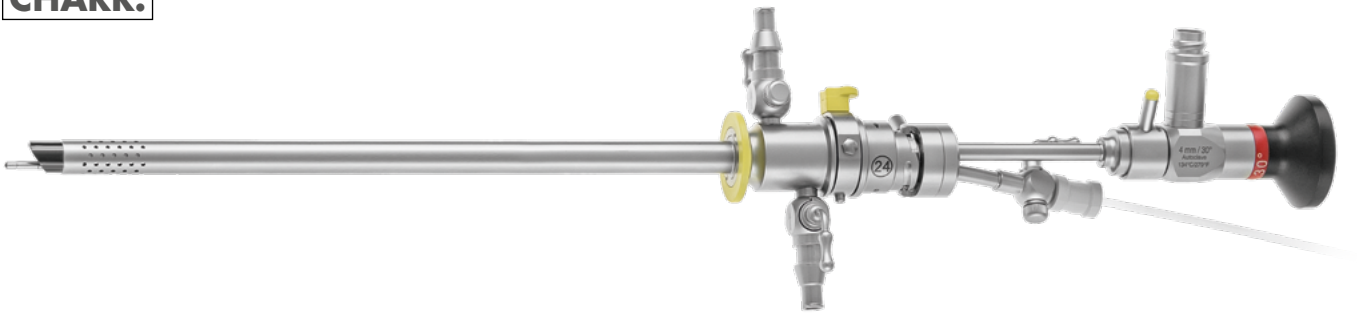

Cystoscope, autoclavable, Ø 4.0mm
253-804-030 30° direction of view
253-804-012 12° direction of view

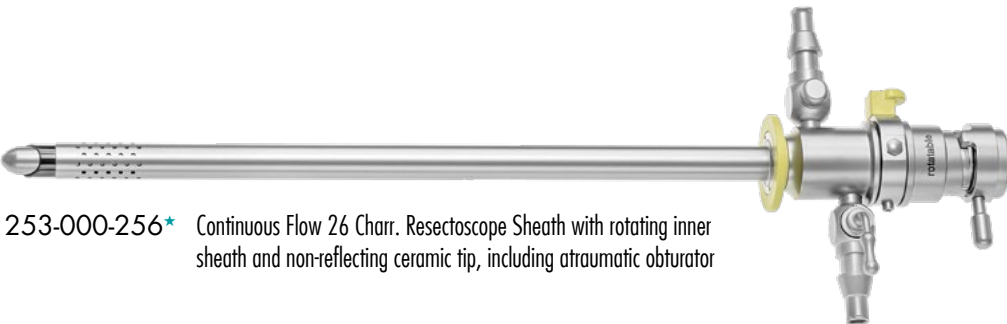

253-000-256* Continuous Flow 26 Charr. Resectoscope Sheath with rotating inner sheath and non-reflecting ceramic tip, including atraumatic obturator



253-874-000 Laser Working Insert with 7 Charr. working channel, for 24/26 Charr. sheaths and 4mm telescope

URETHROTOME

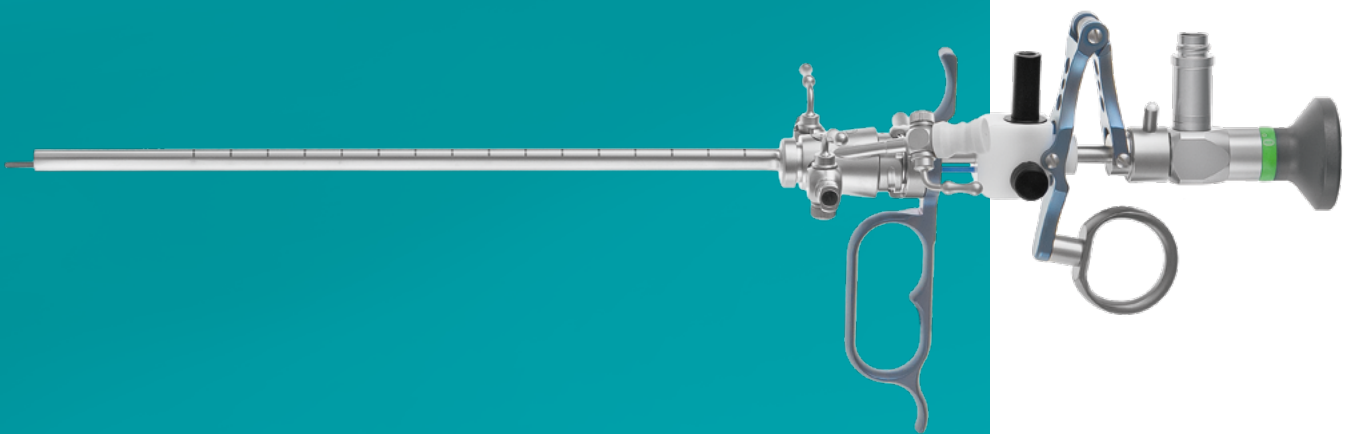

21
CHARR.

URETHROTOME SET

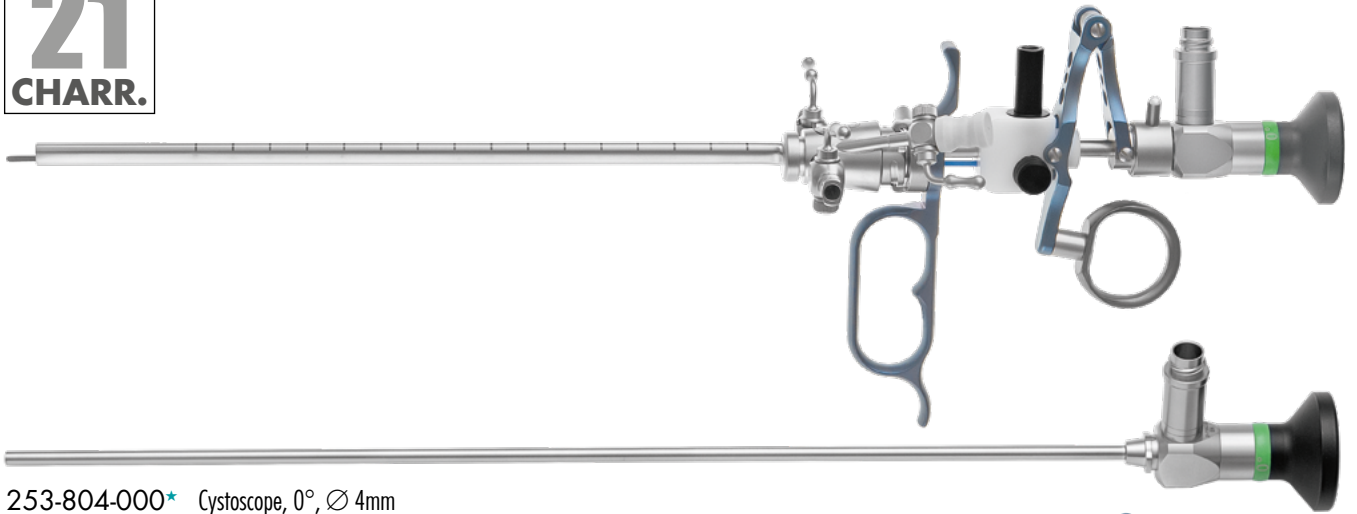

253-804-000* Cystoscope, 0°, Ø 4mm

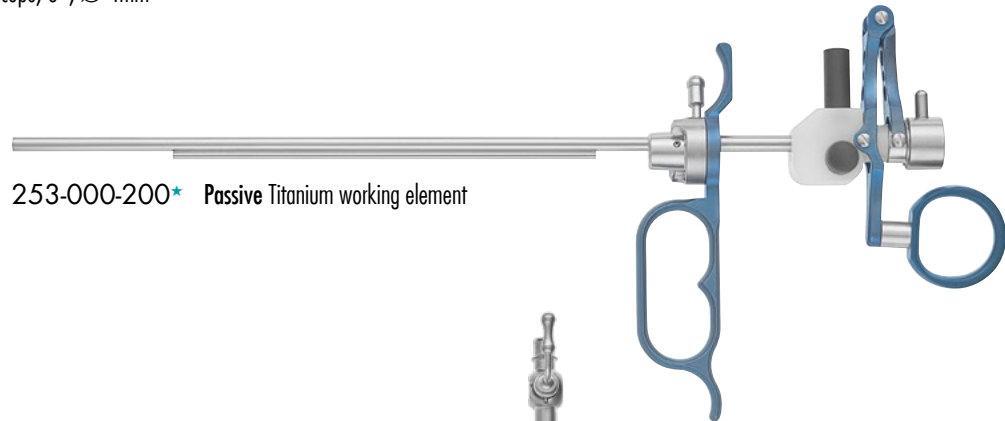

253-000-200* Passive Titanium working element

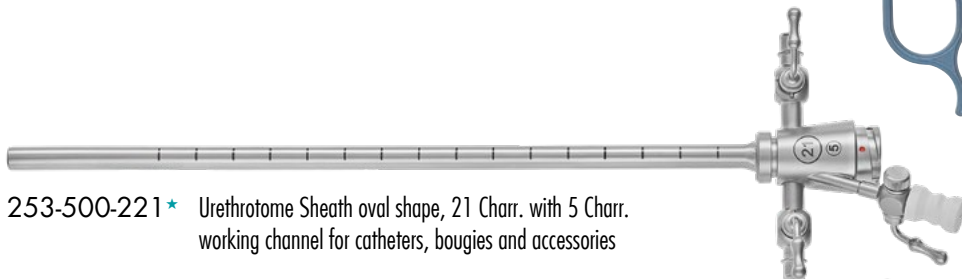

253-500-221* Urethrotome Sheath oval shape, 21 Charr. with 5 Charr. working channel for catheters, bougies and accessories

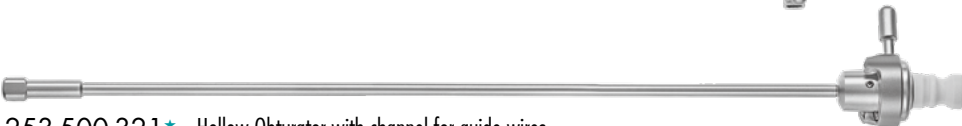

253-500-321* Hollow Obturator with channel for guide wires

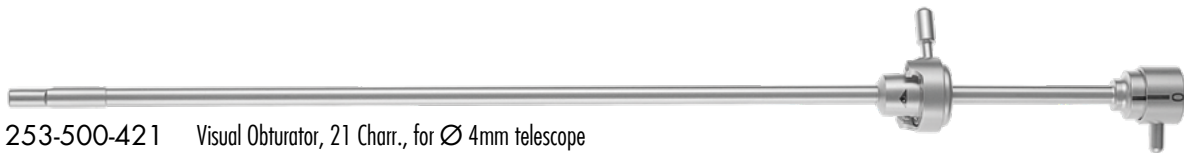

253-500-421 Visual Obturator, 21 Charr., for Ø 4mm telescope

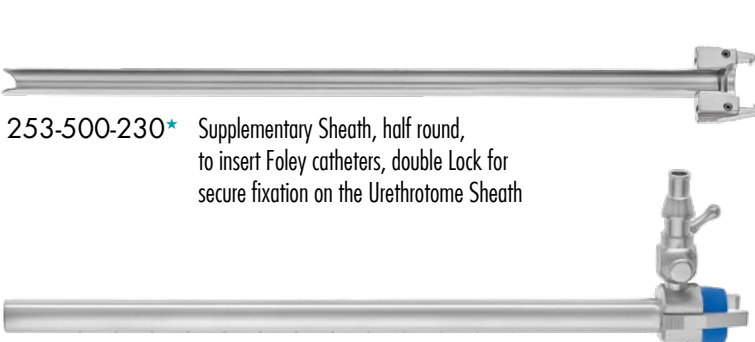

253-500-230* Supplementary Sheath, half round, to insert Foley catheters, double Lock for secure fixation on the Urethrotome Sheath



253-500-325 Bridge with channel for 5 Charr. accessories



253-500-229 Continuous Flow supplementary sheath with double lock



1 Guide Stem Urethrotome Knives, for use without HF



253-500-561★

Sachse knife, straight



253-500-562

Sickle knife, retrograde



253-500-563★

Half round knife, 180° cutting



253-500-564

WaveCut knife, straight



253-300-999★ Storage container for knives and electrodes, metal, perforated

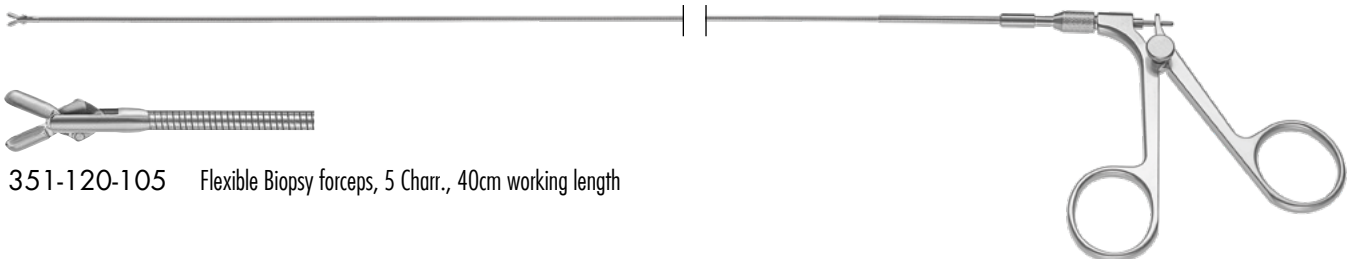

351-120-105 Flexible Biopsy forceps, 5 Charr., 40cm working length

15.5
CHARR.

URETHROTOME SET

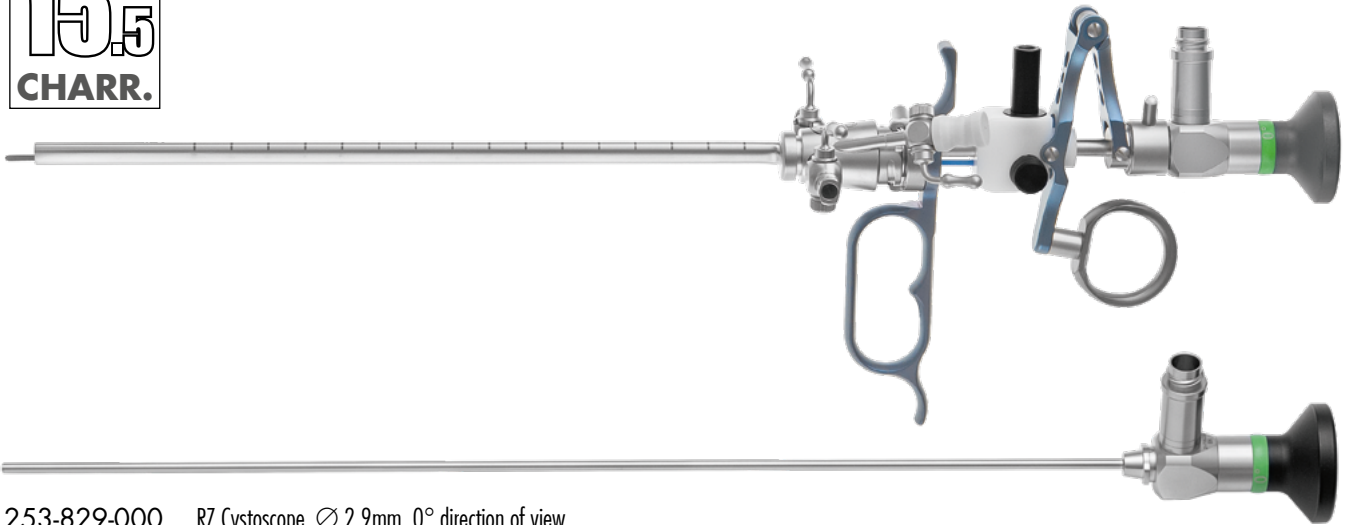

253-829-000 RZ Cystoscope, Ø 2.9mm, 0° direction of view

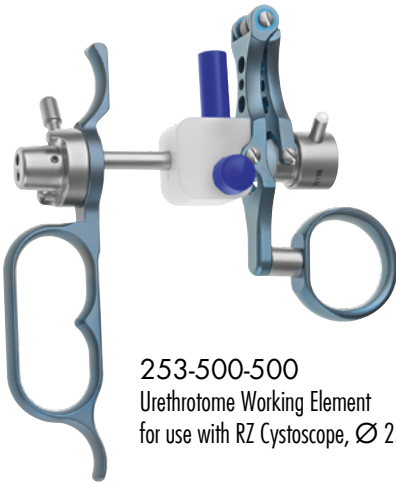

253-500-500
Urethrotome Working Element
for use with RZ Cystoscope, Ø 2.9mm, 0°



253-500-125 Urethrotome Bridge 15.5 Charr.,
with 5 Charr. working channel,
for Ø 2.9mm endoscopes

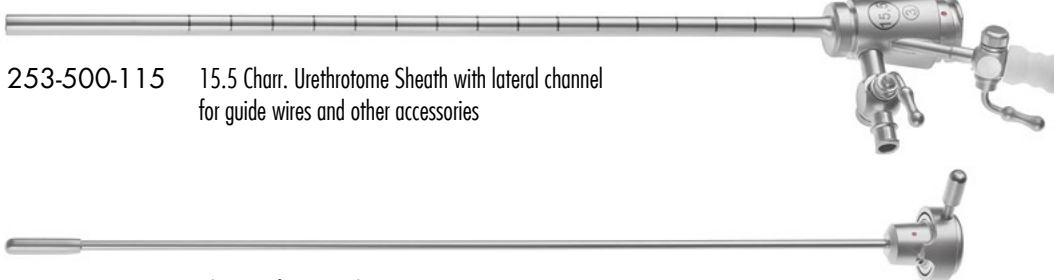

253-500-115 15.5 Charr. Urethrotome Sheath with lateral channel
for guide wires and other accessories

253-500-315 Obturator for use with 253-500-115



253-500-581

Sachse knife, straight, 15 Charr.



253-500-582

Sickle knife, retrograde, 15 Charr.



- 253-500-100 OTIS Dilation Urethrotome complete with 3 atraumatic tips and 2 knives, in wooden case
- 253-500-103 Wooden case only



- 253-500-101 Urethrotome only



- 253-500-102 Knife only



- 253-500-108 Set with 3 atraumatic tips

LITHOTRIPSY

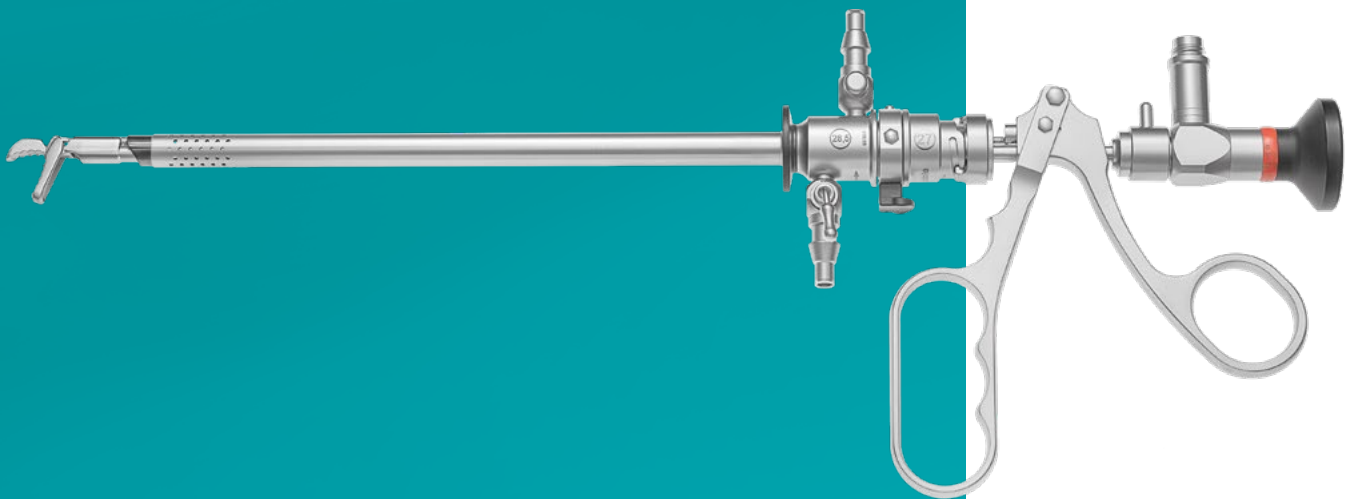

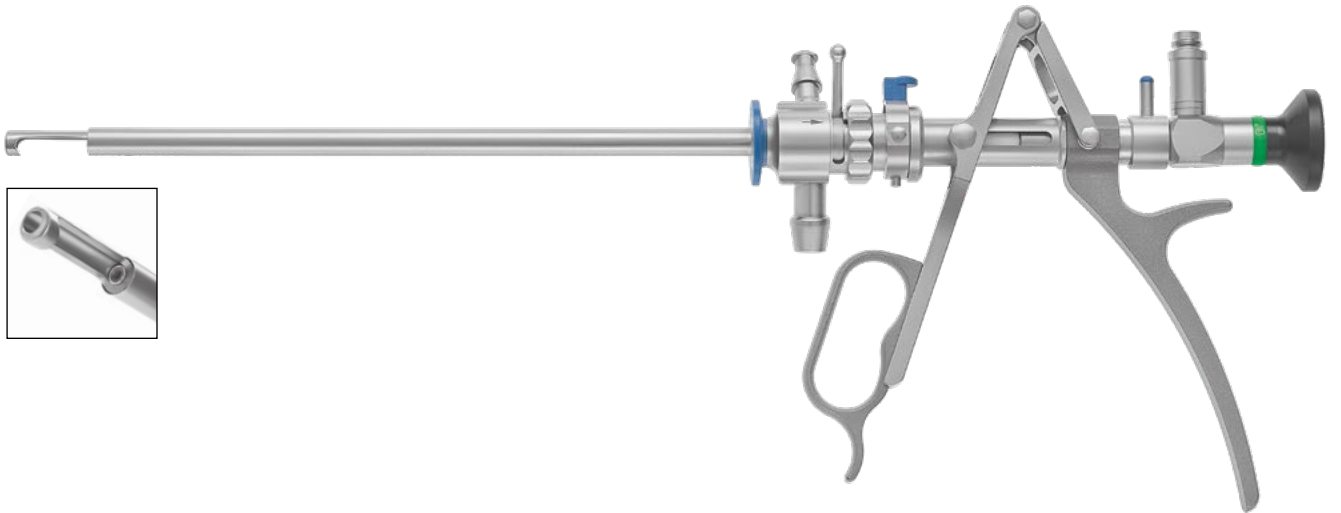

253-804-000* Cystoscope, 0°, Ø 4mm, autoclavable



253-755-020* Punch Sheath with Central Valve, 25 Charr. including Obturator

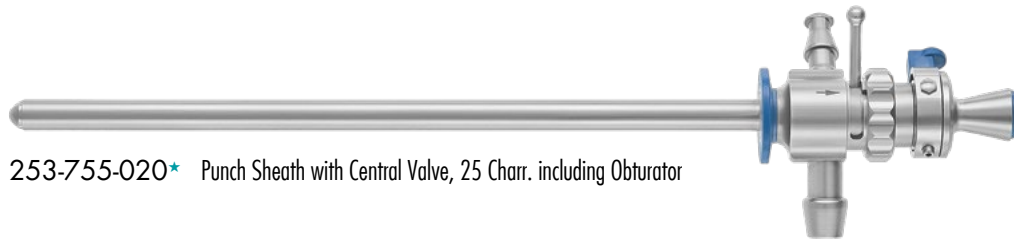

253-755-030 Visual Obturator with 7 Charr. working channel

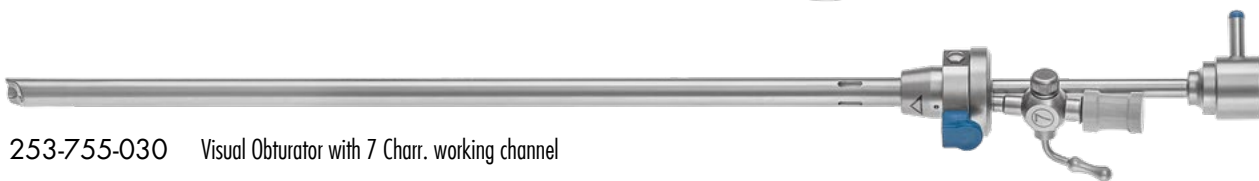

253-755-040 Obturator only



253-755-010* Mauer Mayer Stone Punch

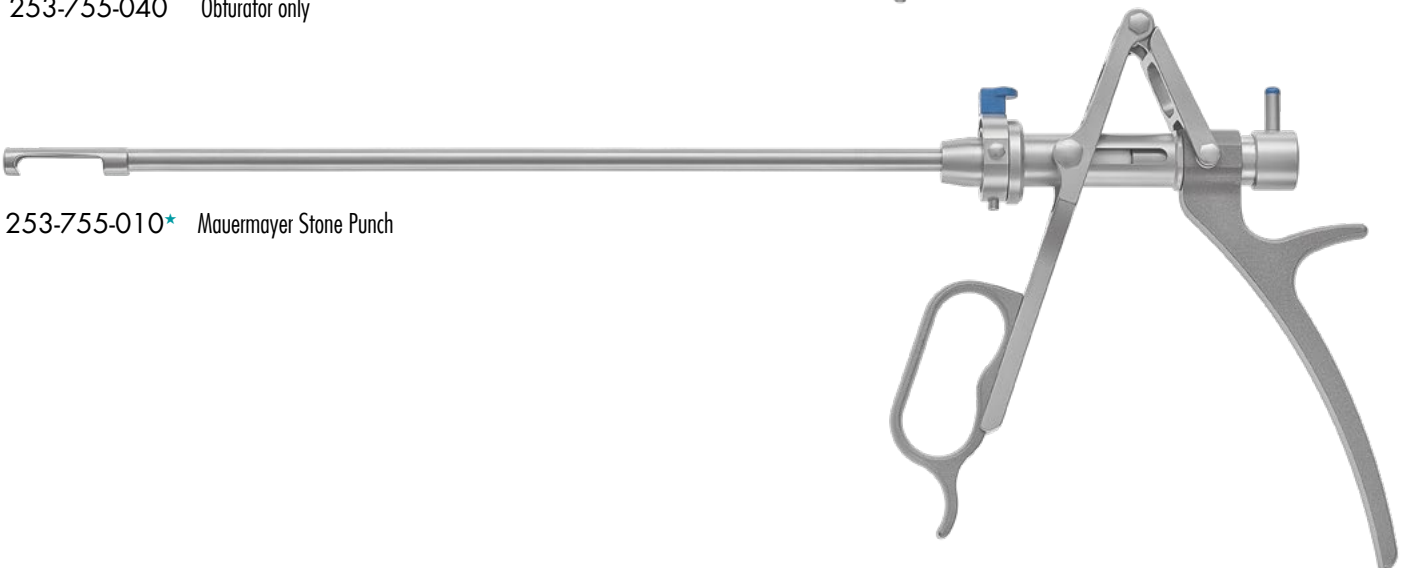

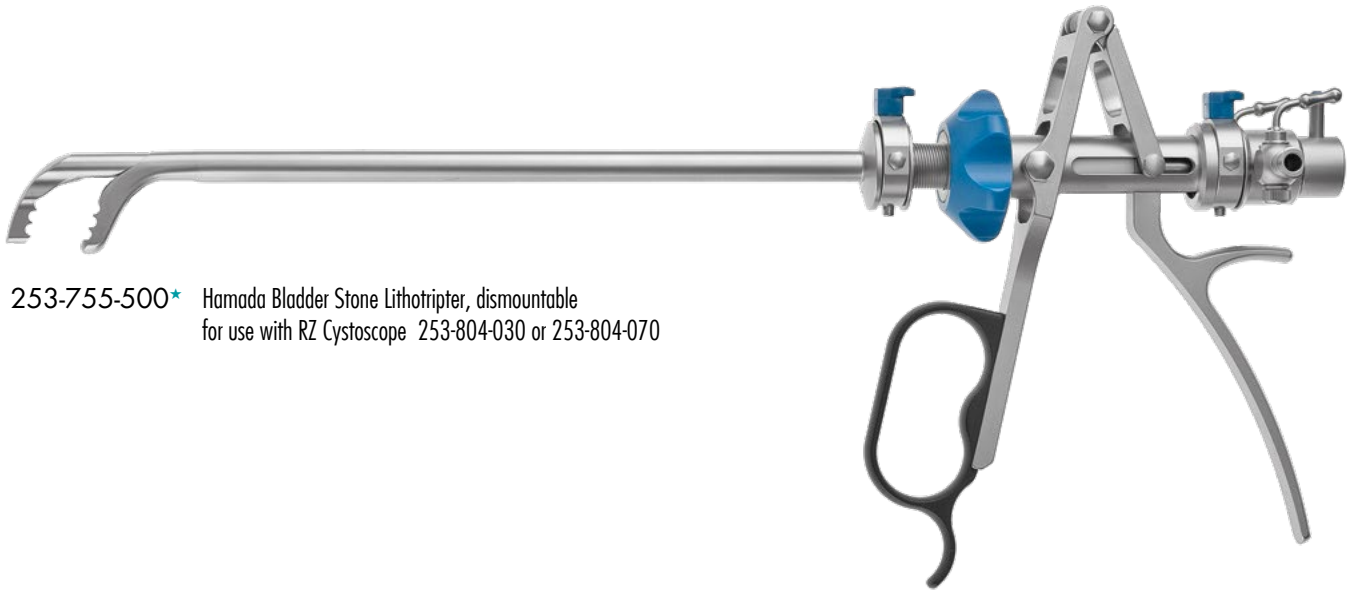

253-755-500* Hamada Bladder Stone Lithotripter, dismantable
for use with RZ Cystoscope 253-804-030 or 253-804-070

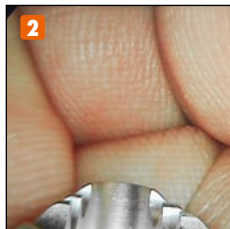
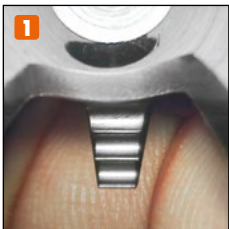

Comparison:
field of view

- 1 with 30° Endoscope
- 2 with 70° Endoscope

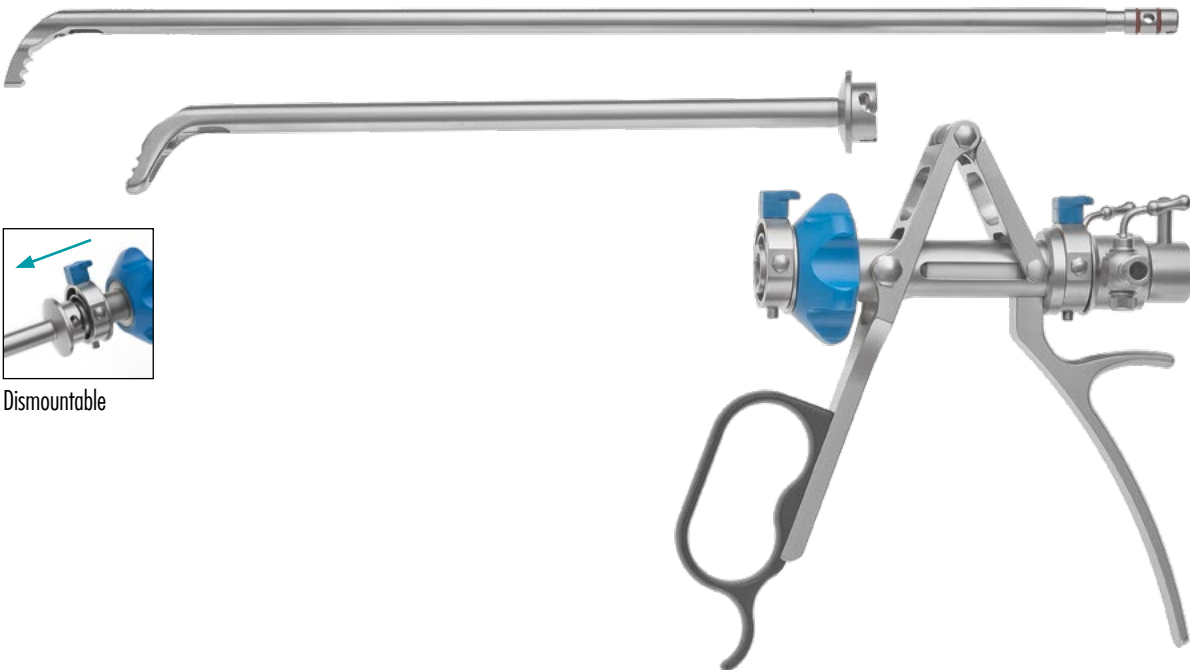

Dismountable

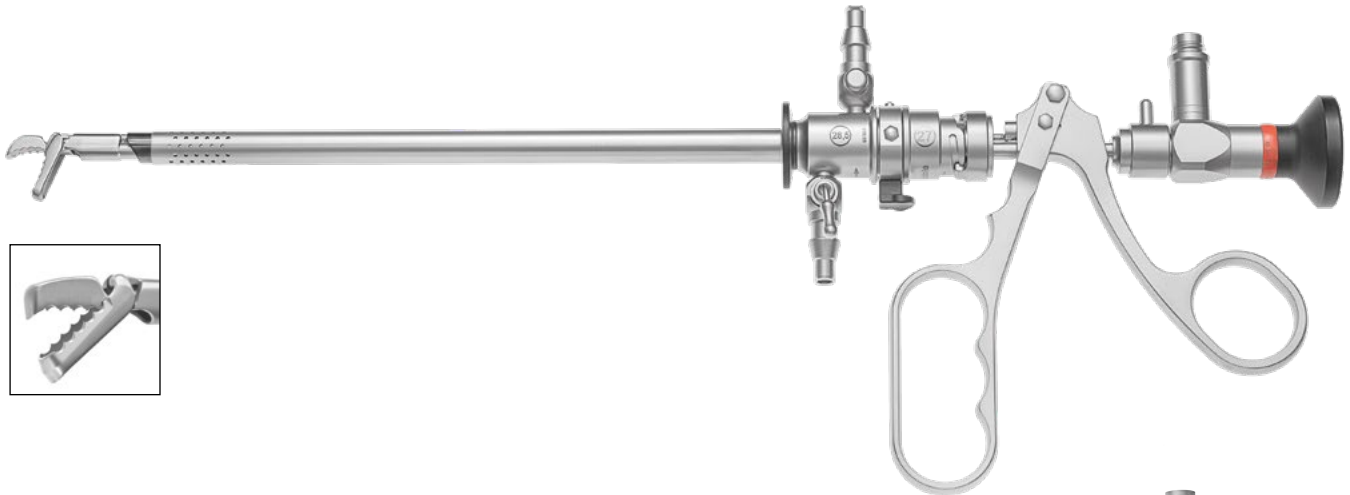

253-804-030 Cystoscope, autoclavable, Ø 4.0mm, 30° direction of view

To be used with Sheaths:

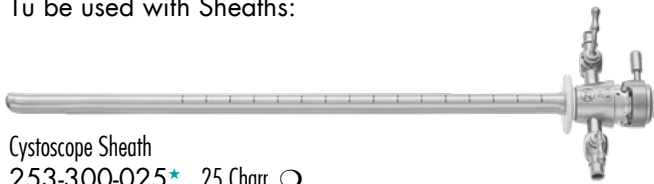

Cystoscope Sheath
253-300-025* 25 Charr. ○

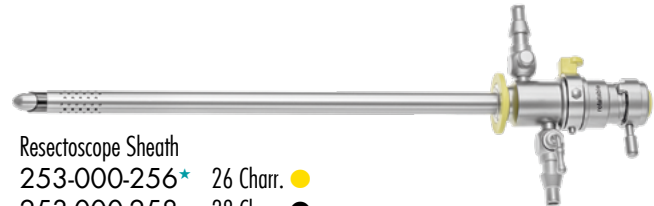

Resectoscope Sheath
253-000-256* 26 Charr. ●
253-000-258 28 Charr. ●



Resectoscope Sheath
253-000-356 Fixed, 26 Charr. ●
253-000-358 Fixed, 28 Charr. ●

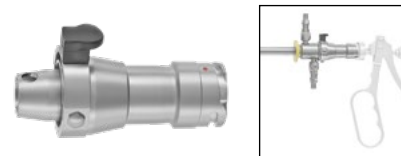

253-430-100* Adapter for use with Outer Resectoscope Sheaths

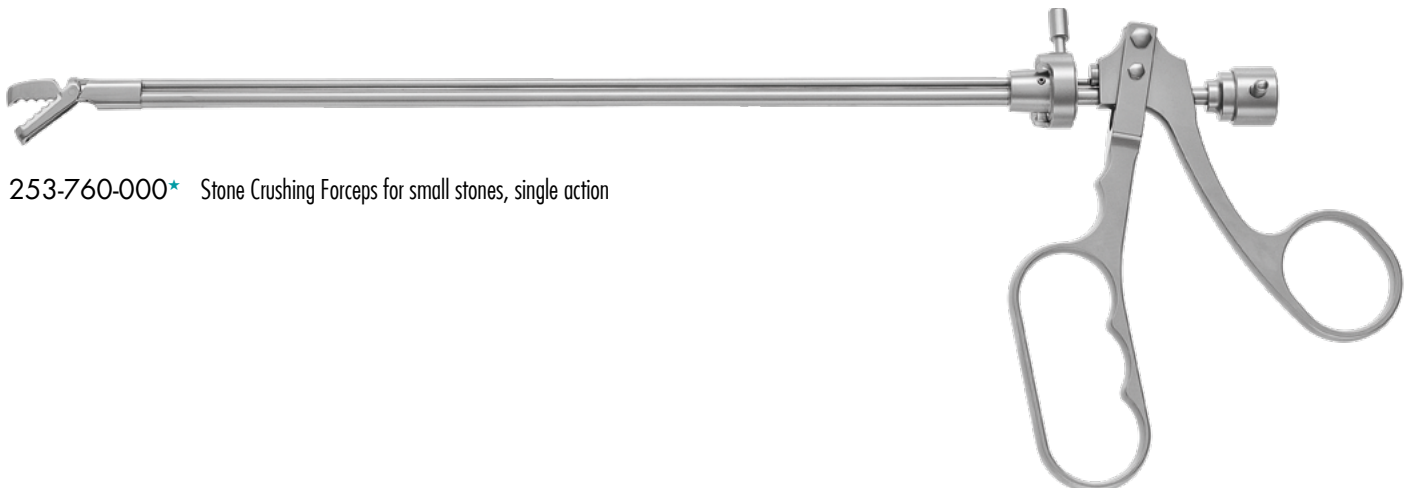

253-760-000* Stone Crushing Forceps for small stones, single action

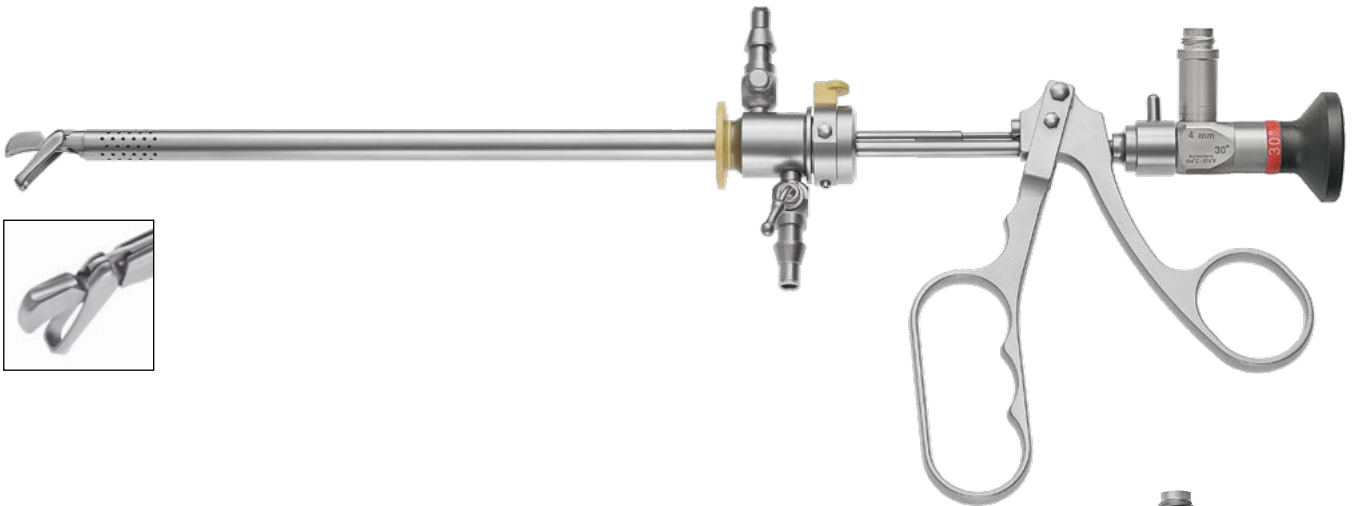

253-804-030 Cystoscope, autoclavable, Ø 4.0mm, 30° direction of view

Suitable Resectoscope Sheaths

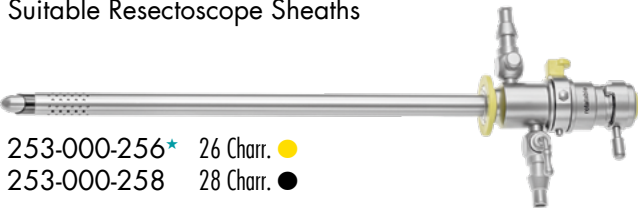

253-000-256* 26 Charr. ●
253-000-258 28 Charr. ●

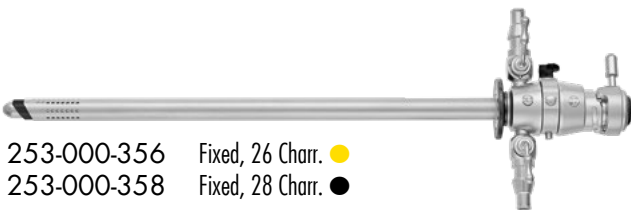

253-000-356 Fixed, 26 Charr. ●
253-000-358 Fixed, 28 Charr. ●

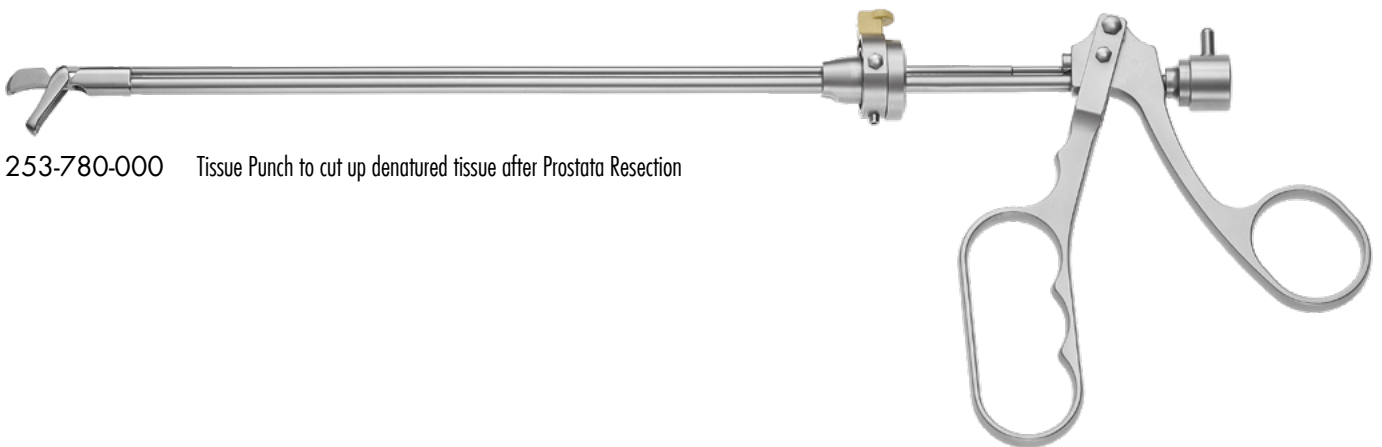

253-780-000 Tissue Punch to cut up denatured tissue after Prostata Resection

NEPHROSCOPY

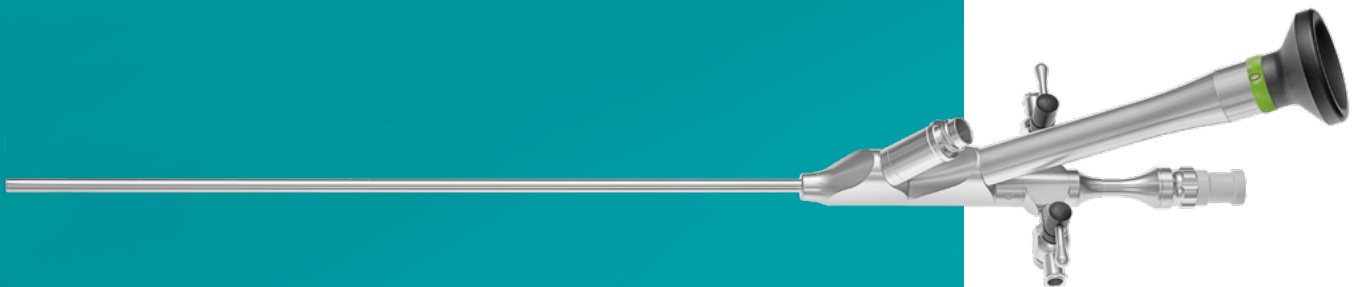



12 Charr. MINI NEPHROSCOPE



253-900-140* Mini Nephroscope, 0° direction of view, 220mm working length

12
CHARR.

Ø SHAFT

7.0
CHARR.

WORKING
CHANNEL*

* for use with instruments up to 5 Charr.



253-905-400
Silicone Valve,
package with 5 pieces



253-900-010
Silicone Valve, package with 10 pieces,
for use with very delicate instruments
from 0.5 – 1.6mm diameter.



OPERATING SHEATHS for use with RZ Mini Nephroscope

Mini PCNL Sheaths with valve

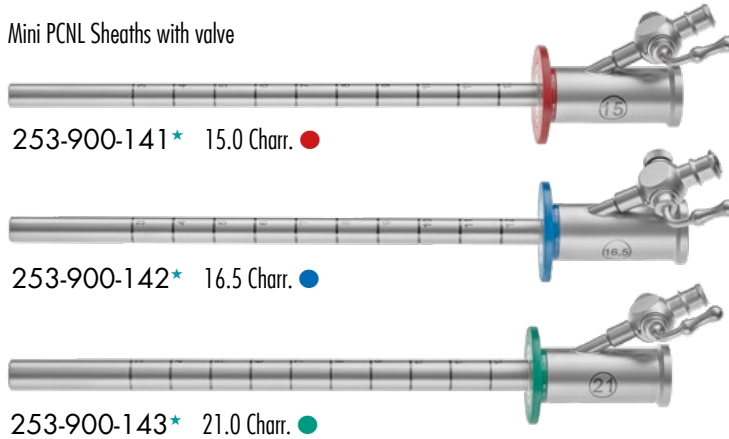

253-900-141* 15.0 Charr. ●

253-900-142* 16.5 Charr. ●

253-900-143* 21.0 Charr. ●

Long Mini PCNL Sheaths

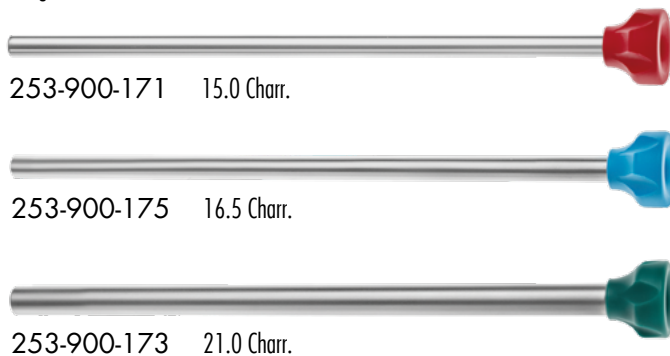

253-900-171 15.0 Charr.

253-900-175 16.5 Charr.

253-900-173 21.0 Charr.

One-Step Dilators with 1 central guide wire channel

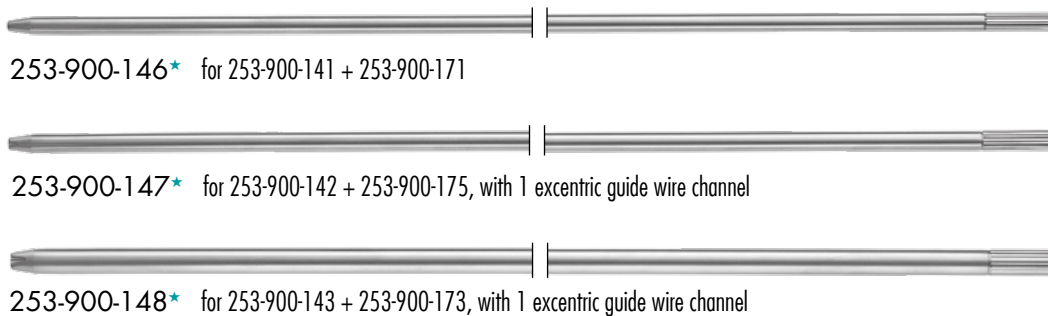

253-900-146* for 253-900-141 + 253-900-171

253-900-147* for 253-900-142 + 253-900-175, with 1 excentric guide wire channel

253-900-148* for 253-900-143 + 253-900-173, with 1 excentric guide wire channel



253-900-145* 2-piece Sealing Adapter with sheath and obturator for use with 253-900-141

RZ NEPHROSCOPY INSTRUMENTS

semi-rigid, 5 Charr.

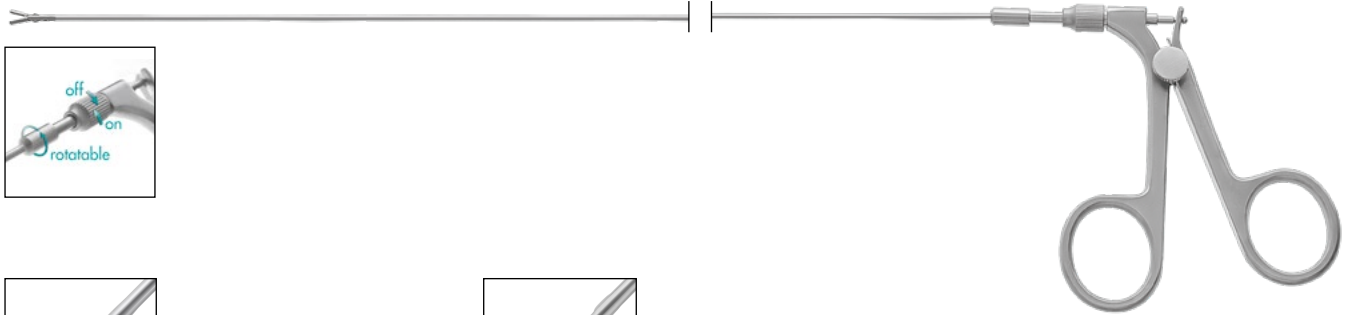

Stone Grasping Forceps,
double action jaws, retrograde serration
253-950-455* 450mm working length

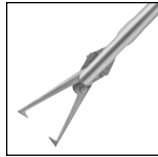

Stone Grasping Forceps
for large stones, double action jaws, 1 x 1 teeth
253-952-455* 450mm working length



Hamada Long Stone Grasping Forceps,
double action jaws, fine serrated
253-954-455 450mm working length

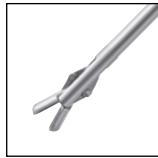

Biopsy Forceps,
double action jaws
253-956-455* 450mm working length

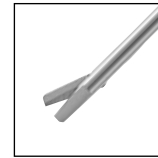

Scissors,
single action jaws
253-958-455 450mm working length

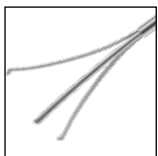

253-960-360* Stone Grasping Forceps, rigid, 5 Charr., 400mm,
for grasping of bigger stones and -fragments
triple toothed jaw, U-spring handle

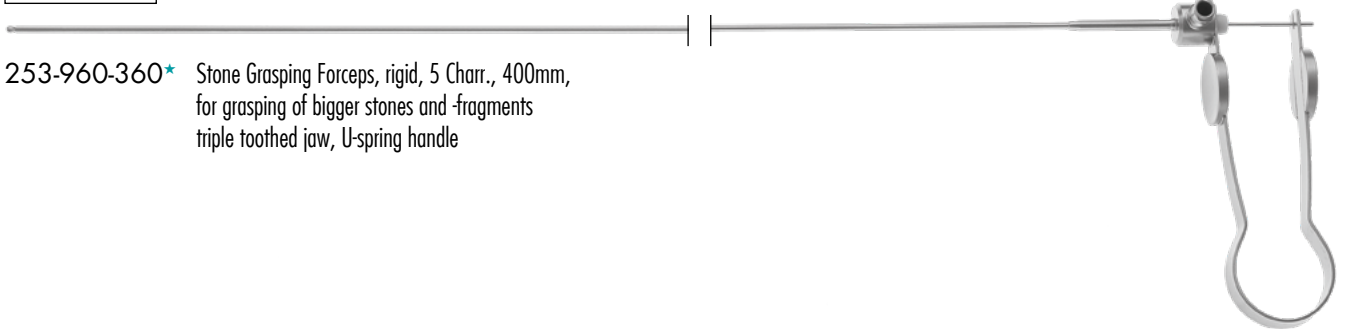

253-900-200 Sterile disposable Guide wire, J-tip, flexible, 150cm length



RZ COMPACT NEPHROSCOPE

220mm working length

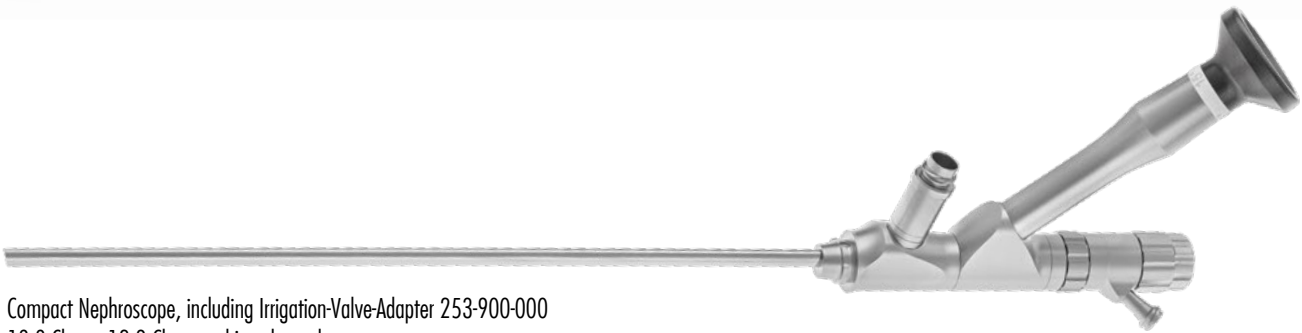

Compact Nephroscope, including Irrigation-Valve-Adapter 253-900-000
 18.8 Charr., 12.9 Charr working channel
 253-900-815 15°
 253-900-830 30°

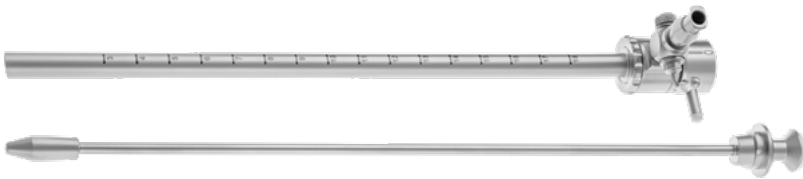

Suitable Shaft, with obturator, 23 Charr., 220mm working length
 253-900-888



253-900-000
 Irrigation-Valve-Adapter

Percutane Nephroscopy, 190mm length



RZ Nephroscope, oblique view, with 2 Luer-Lock stopcocks and detachable instrument stopcock
 253-900-100 6° direction of view
 253-900-150 15° direction of view



253-900-105 Stopcock, only for use with RZ Nephrosopes



RZ Nephroscope, parallel view, with 2 Luer-Lock stopcocks and detachable instrument stopcock
 253-900-101 6° direction of view
 253-900-151 15° direction of view

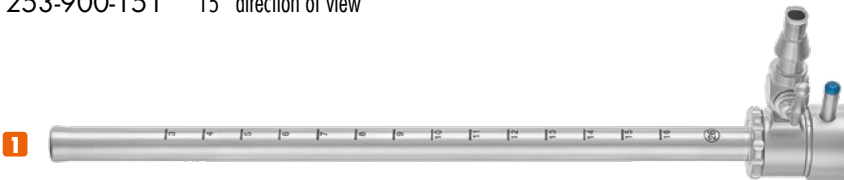

Operating Sheath

1 253-900-110* 26 Charr.

2 253-900-111 24 Charr.



Hollow Obturator

1 253-900-115* 26 Charr.

2 253-900-116 24 Charr.



Percutane Nephroscopy, 250mm length



RZ Nephroscope, oblique view, with 2 Luer-Lock stopcocks and detachable instrument stopcock, 250mm working length

- 253-900-120 6° direction of view
- 253-900-160 15° direction of view



253-900-105 Stopcock, only for use with RZ Nephrosopes (including: 253-900-100 and 253-900-101)

Nephroscope Scope, oval instrument channel, parallel eye piece, 250mm working length

- 253-900-121 6° direction of view
- 253-900-161 15° direction of view



Operating Sheath

- 1** 253-900-130* 26 Charr.
- 2** 253-900-131 24 Charr.



Hollow Obturator

- 1** 253-900-135* 26 Charr.
- 2** 253-900-136 24 Charr.

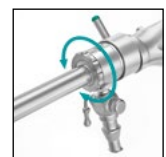



253-900-155* Amplatz Metal Dilator set containing 6 Dilators (9, 12, 15, 18, 21, 24 Charr.)
2 flexible and 2 rigid guide rods for use with guide wires



Amplatz Metal Dilator
253-900-156* 27 Charr.
253-900-157* 30 Charr.



253-900-201* Puncture Cannula with inner and outer cannula



253-900-202* Dilation Cannula, 3mm \varnothing with inner and outer cannula



253-900-200 Sterile disposable Guide wire, J-tip, flexible, 150cm length

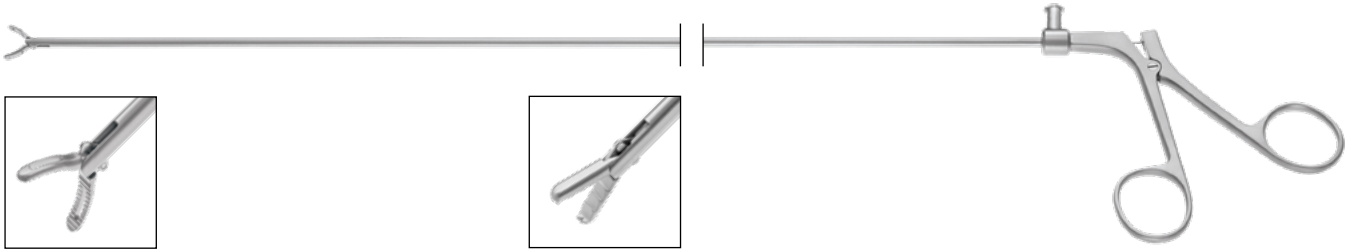

Stone Grasping forceps with fenestrated jaws,
double action, with flushing port
253-900-210* 360mm working length
253-900-250* 430mm working length



Stone Grasping forceps with coarse serrated jaws,
double action
253-900-212* 360mm working length
253-900-252* 430mm working length



Biopsy forceps with sharp cup,
single action
253-900-211 360mm working length
253-900-251 430mm working length



Scissors, sharp tip,
single action
253-900-213 360mm working length
253-900-253 430mm working length

Stone Grasping Forceps with spring handle and finger platform
Ø 4mm, Luer-Lock connection

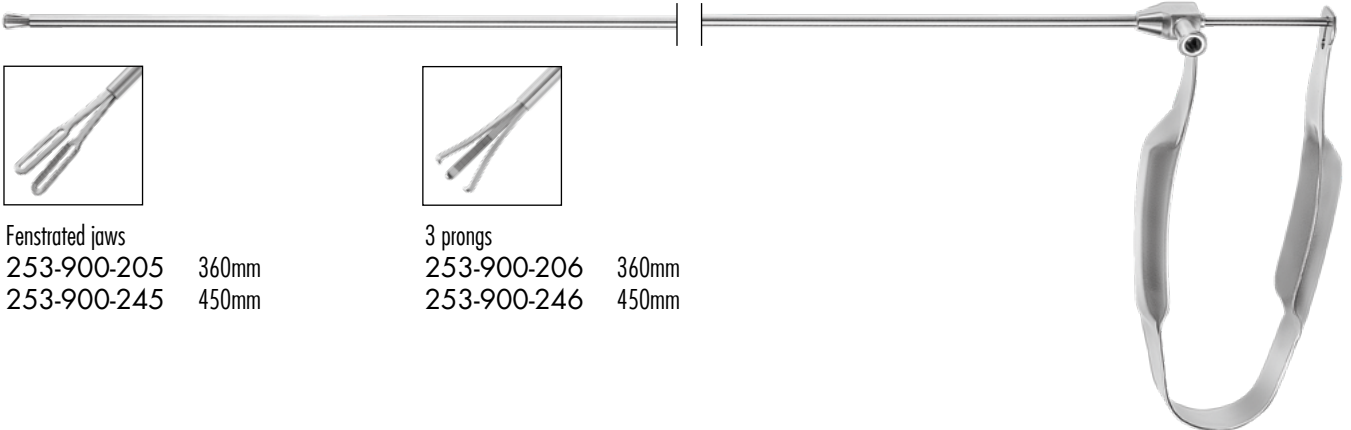

Fenestrated jaws
253-900-205 360mm
253-900-245 450mm



3 prongs
253-900-206 360mm
253-900-246 450mm

URETERO-RENOSCOPY

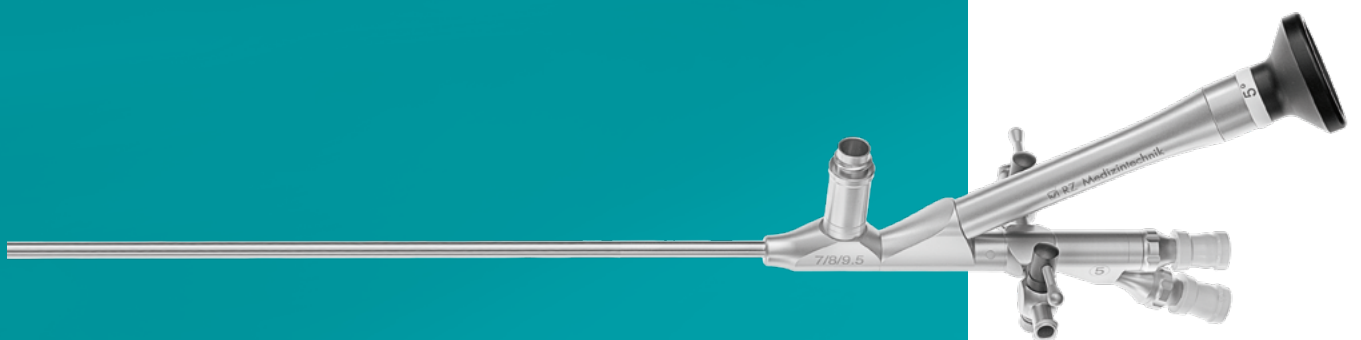

RZ URETERO-RENOSCOPES

- FullHD 50.000 pixel fiber system
- Semi-flexible shaft
- Silicone valve system with 2 parallel sealings
- Large working channels
- Irrigation/suction channels



Sealing caps included
 301-701-060 Ø 0.6mm
 301-701-030 Ø 0.3mm



Atraumatic tip design

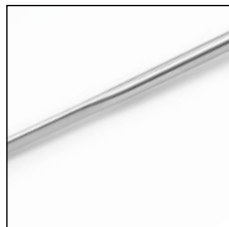

Tapered shaft

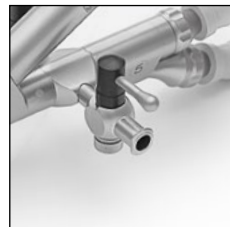

90° stopcocks



5° direction of view
 65° field of view

ADVANCED SEMI-RIGID URETERO-RENSCOPES

standard LINE

253-905-540* 425mm
253-905-530 310mm

7.5 CHARR.	9.0 CHARR.	13 CHARR.	5.8 CHARR.
DISTAL TIP	DISTAL	PROXIMAL	WORKING CHANNEL*

* for use with instruments up to 5 Charr.

slim LINE

253-910-540* 425mm
253-910-530 310mm

6.0 CHARR.	7.5 CHARR.	10.5 CHARR.	5.0 CHARR.
DISTAL TIP	DISTAL	PROXIMAL	WORKING CHANNEL*

* for use with instruments up to 4 Charr.

superslim LINE

253-915-540* 425mm
253-915-530 310mm

5.0 CHARR.	6.5 CHARR.	8.0 CHARR.	4.0 CHARR.
DISTAL TIP	DISTAL	PROXIMAL	WORKING CHANNEL*

* for use with instruments up to 3 Charr.



VERSATIP 360° rotating, color coded Instruments

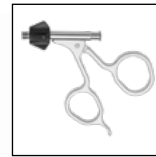
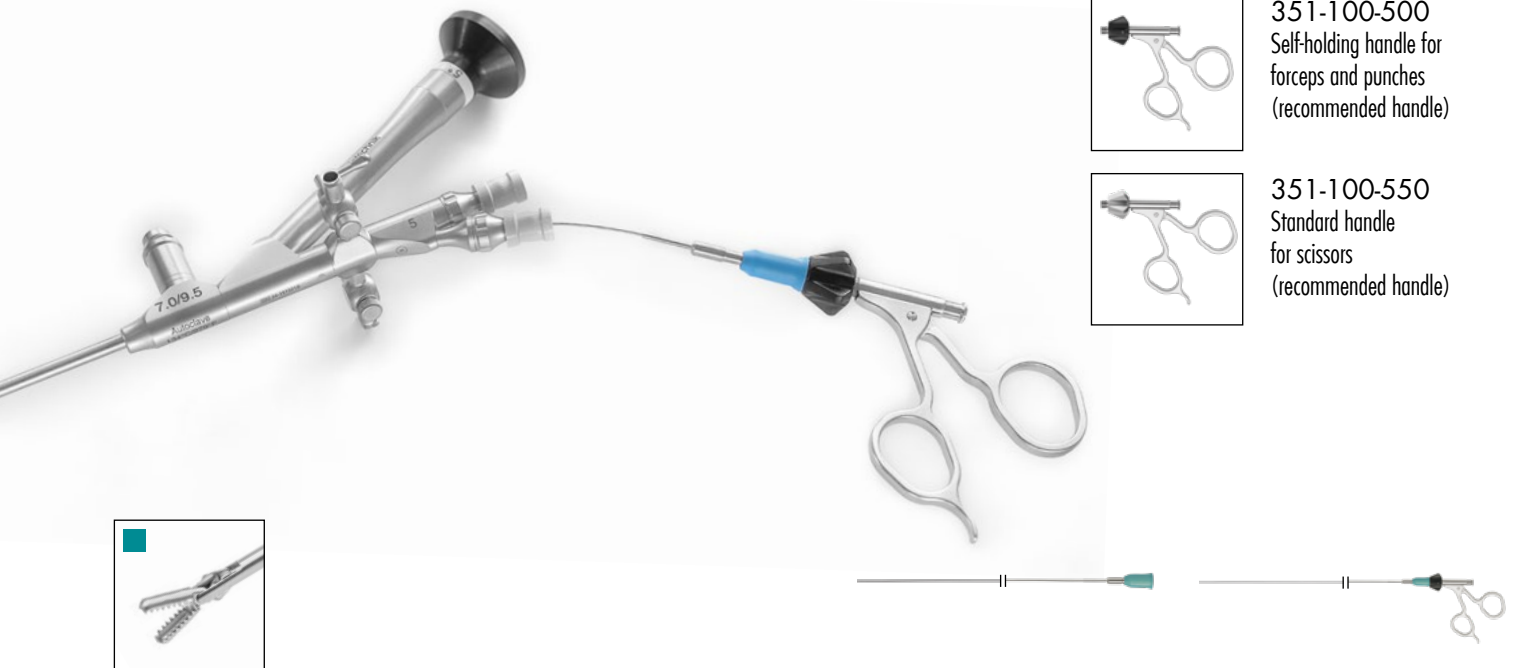

351-100-500
Self-holding handle for
forceps and punches
(recommended handle)

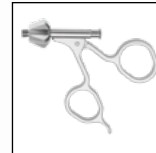

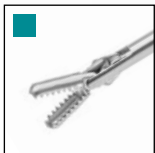

351-100-550
Standard handle
for scissors
(recommended handle)



Grasping Forceps with toothed cup,
double action, 600mm working length

Insert only

Complete instrument



 SEMI RIGID	semi-rigid	3 Charr., Ø 1.0mm	253-950-503	253-950-003
		4 Charr., Ø 1.3mm	253-950-504	253-950-004
		5 Charr., Ø 1.6mm	253-950-505	253-950-005
 FLEXIBLE	flexible	3 Charr., Ø 1.0mm	253-951-503	253-951-003
		4 Charr., Ø 1.3mm	253-951-504	253-951-004
		5 Charr., Ø 1.6mm	253-951-505	253-951-005



Stone Grasping Forceps for large stones,
double action jaws, 600mm working length

Insert only



Complete instrument

 SEMI RIGID	semi-rigid	3 Charr., Ø 1.0mm	253-952-503	253-952-003
		4 Charr., Ø 1.3mm	253-952-504	253-952-004
		5 Charr., Ø 1.6mm	253-952-505	253-952-005
 FLEXIBLE	flexible	3 Charr., Ø 1.0mm	253-953-503	253-953-003
		4 Charr., Ø 1.3mm	253-953-504	253-953-004
		5 Charr., Ø 1.6mm	253-953-505	253-953-005



HAMADA long Stone Grasping Forceps,
double action jaws, 600mm working length





			Insert only	Complete instrument
 semi-rigid		3 Charr., Ø 1.0mm	253-954-503	253-954-003
		4 Charr., Ø 1.3mm	253-954-504	253-954-004
		5 Charr., Ø 1.6mm	253-954-505	253-954-005
 flexible		3 Charr., Ø 1.0mm	253-955-503	253-955-003
		4 Charr., Ø 1.3mm	253-955-504	253-955-004
		5 Charr., Ø 1.6mm	253-955-505	253-955-005



Biopsy Forceps, 600mm working length





			Insert only	Complete instrument
 semi-rigid		3 Charr., Ø 1.0mm	253-956-503	253-956-003
		4 Charr., Ø 1.3mm	253-956-504	253-956-004
		5 Charr., Ø 1.6mm	253-956-505	253-956-005
 flexible		3 Charr., Ø 1.0mm	253-957-503	253-957-003
		4 Charr., Ø 1.3mm	253-957-504	253-957-004
		5 Charr., Ø 1.6mm	253-957-505	253-957-005



Scissors, single action,
600mm working length



			Insert only	Complete instrument
 semi-rigid		3 Charr., Ø 1.0mm	253-958-503	253-958-003
		4 Charr., Ø 1.3mm	253-958-504	253-958-004
		5 Charr., Ø 1.6mm	253-958-505	253-958-005
 flexible		3 Charr., Ø 1.0mm	253-959-503	253-959-003
		4 Charr., Ø 1.3mm	253-959-504	253-959-004
		5 Charr., Ø 1.6mm	253-959-505	253-959-005

FLEXIBLE INSTRUMENTS

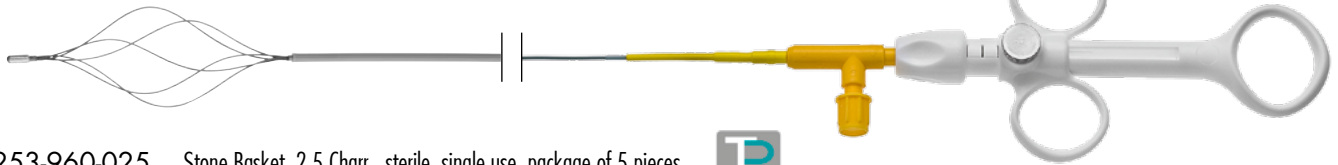

253-960-025 Stone Basket, 2.5 Charr., sterile, single use, package of 5 pieces



253-962-003 Brush for Cytology, 3.0 Charr., for single use, package of 5 pieces



253-940-005 3-Prongs Grasper, flexible, 600mm working length, 5 Charr.



253-585-005 Dormia Metal Stone Basket, flexible, 4 wires, 600mm working length, 5 Charr.

Accessories



253-905-400
Silicone Valve,
package with 5 pieces



253-900-010
Silicone Valve, package with 10 pieces,
for use with very delicate instruments
from 0.5 – 1.6mm diameter.

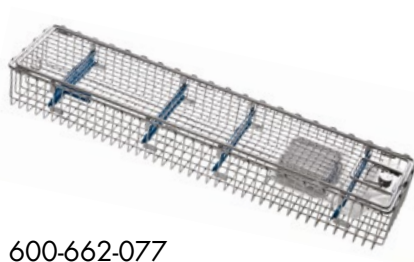

600-662-077
Endoscopic wire basket for URS
640 x 150 x 77mm

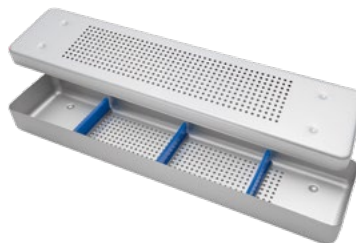

253-905-000
Container for URS with silicone inserts
640 x 140 x 60mm

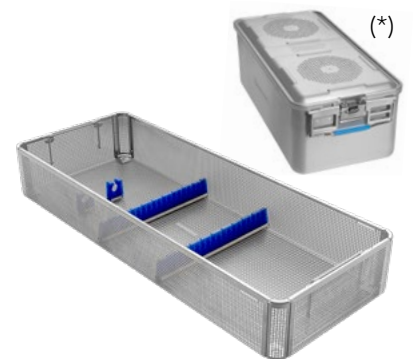

Tray for URS and instruments
600-662-540 Tray
600-600-191 XL Container, Standard,
bottom non perforated,
732 x 280 x 190mm,
silver lid (*)

PEDIATRIC

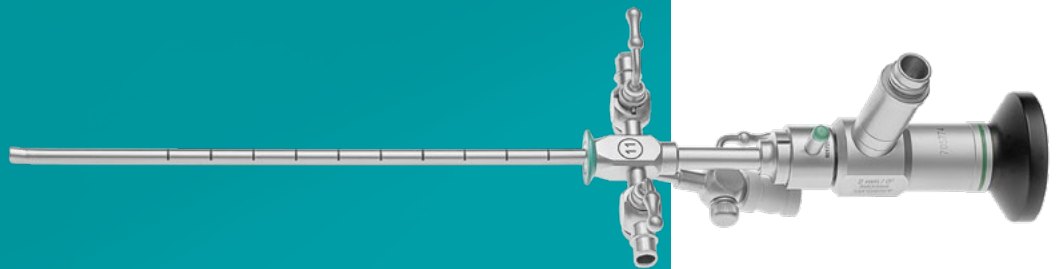

CYSTO-URETHROSCOPE SET FOR NEW BORN



RZ Cystoscope, Ø 2.0mm
 253-221-030 30°
 253-221-000 0°

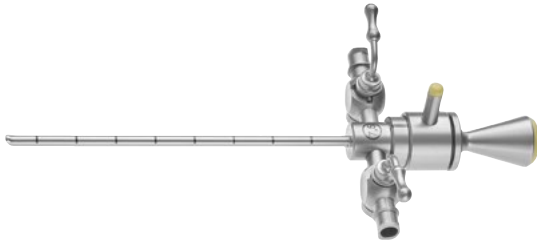

253-200-007 Cysto-Urethroscope Sheath, 7.5 Charr.

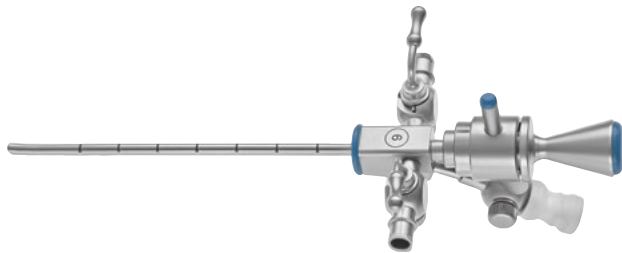

253-200-009 Cysto-Urethroscope Sheath, 9 Charr.,
 with 3 Charr. Instrument Channel

3 Charr. Instruments for new born set

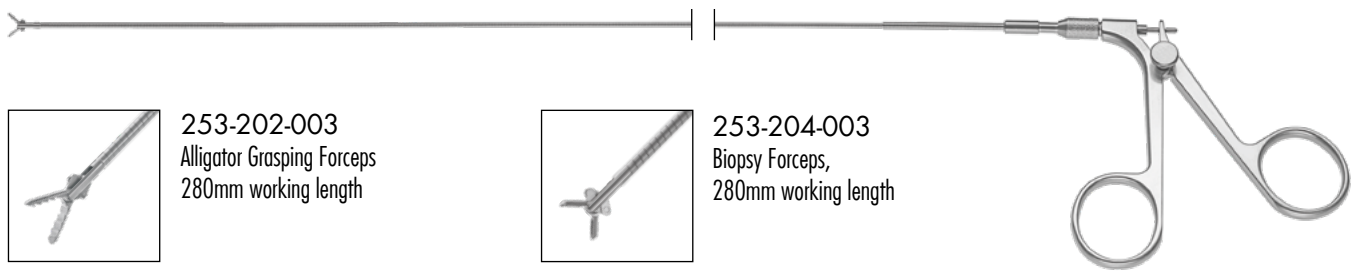

253-202-003
 Alligator Grasping Forceps
 280mm working length



253-204-003
 Biopsy Forceps,
 280mm working length



253-370-253
 Ball Electrode,
 250mm working length

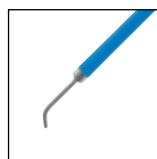

253-371-253
 Needle Electrode,
 250mm working length

Ø 2.0mm PEDIATRIC CYSTOSCOPY

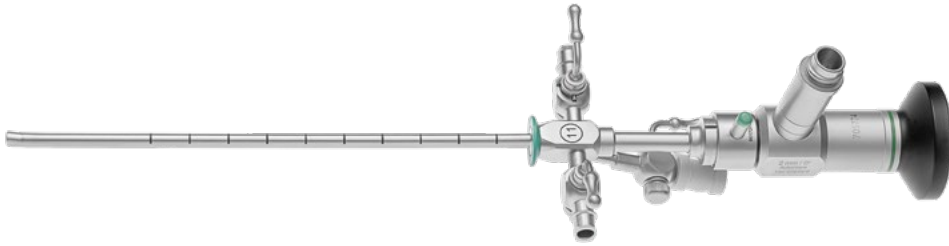

RZ Pediatric Fiber Cystoscope Ø 2.0mm, 187.5mm length
 253-219-100 0°
 253-219-130 30°

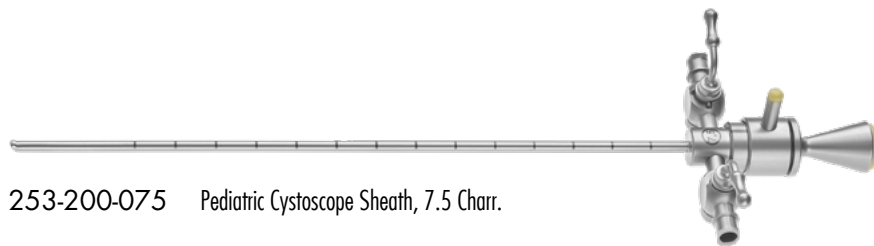

253-200-075 Pediatric Cystoscope Sheath, 7.5 Charr.

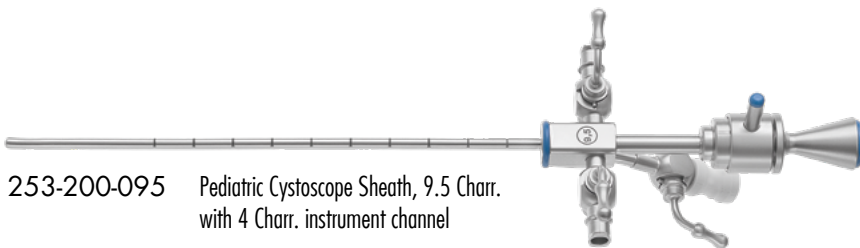

253-200-095 Pediatric Cystoscope Sheath, 9.5 Charr.
 with 4 Charr. instrument channel

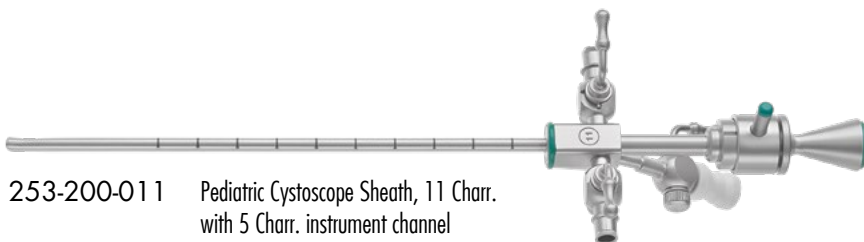

253-200-011 Pediatric Cystoscope Sheath, 11 Charr.
 with 5 Charr. instrument channel

Ø 2.7mm PEDIATRIC CYSTOSCOPY



RZ Pediatric Cystoscope, 2.7mm diameter, 187.5mm working length
 253-227-000 0°
 253-227-030 30°
 253-227-070 70°

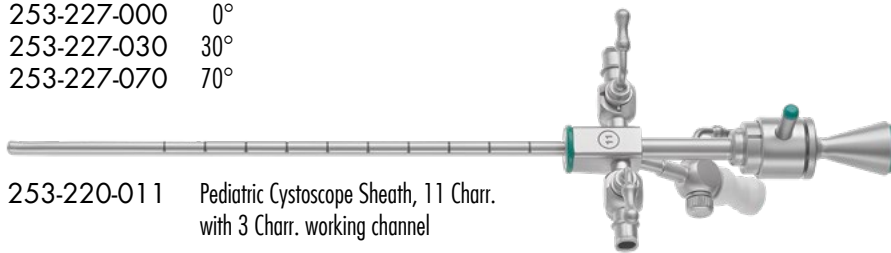

253-220-011 Pediatric Cystoscope Sheath, 11 Charr.
 with 3 Charr. working channel

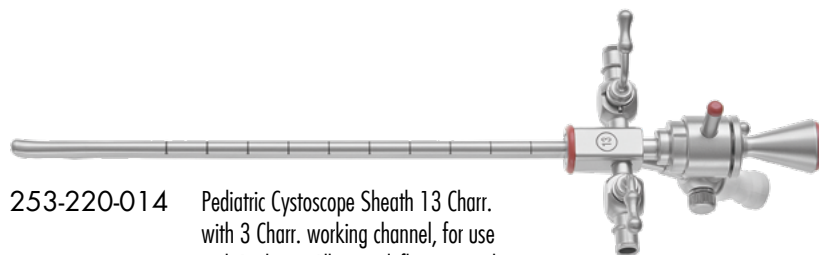

253-220-014 Pediatric Cystoscope Sheath 13 Charr.
 with 3 Charr. working channel, for use
 with Bridge or Albarran deflecting mechanism



253-220-025
 Albarran deflecting mechanism for use with 253-220-014

253-220-030
 Bridge for use with 253-220-014

3 Charr. Instruments for Ø 2.0 / 2.7mm Pediatric Cystoscopy

280mm working length



253-202-003
Alligator Grasping Forceps



253-204-003
Biopsy Forceps



253-370-253
Ball Electrode, 250mm length

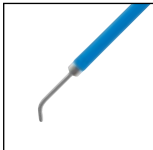

253-371-253
Needle Electrode, 250mm length

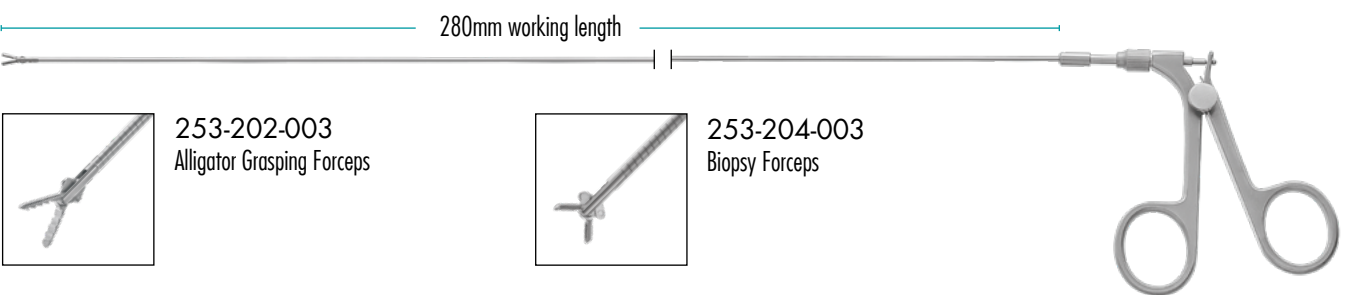

Ø 2.9mm ADOLESCENT CYSTOSCOPY



RZ Cystoscope, Ø 2.9mm
 253-829-000 0°
 253-829-030 30°

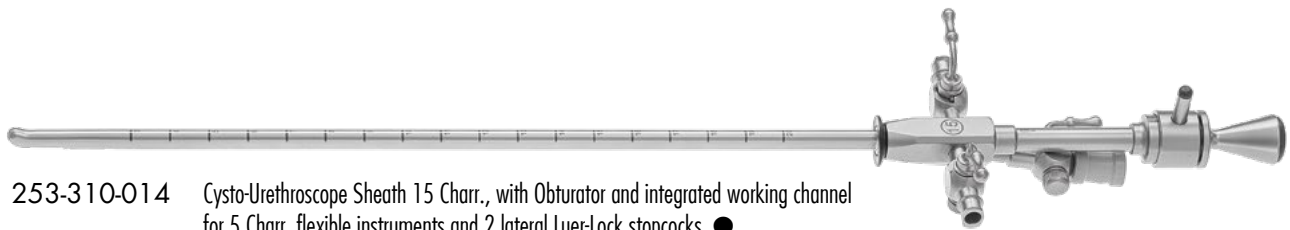

253-310-014 Cysto-Urethroscope Sheath 15 Charr., with Obturator and integrated working channel for 5 Charr. flexible instruments and 2 lateral Luer-Lock stopcocks ●

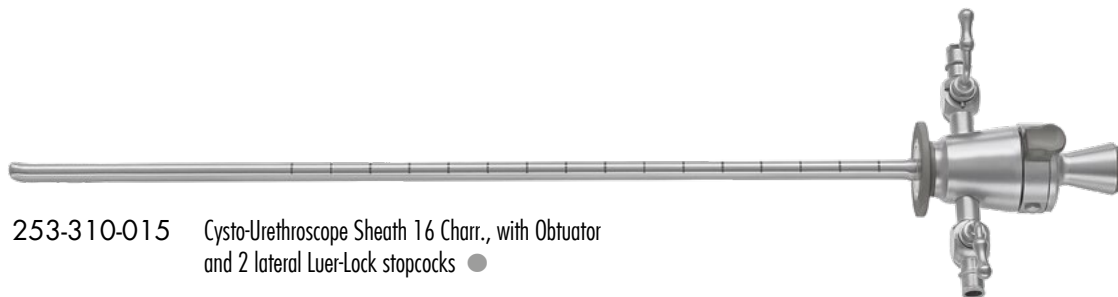

253-310-015 Cysto-Urethroscope Sheath 16 Charr., with Obturator and 2 lateral Luer-Lock stopcocks ●



1 253-310-100 Telescope bridge without channel
2 253-310-101 Telescope bridge with 1 channel for use with 253-310-014 and 5 Charr. flexible instruments

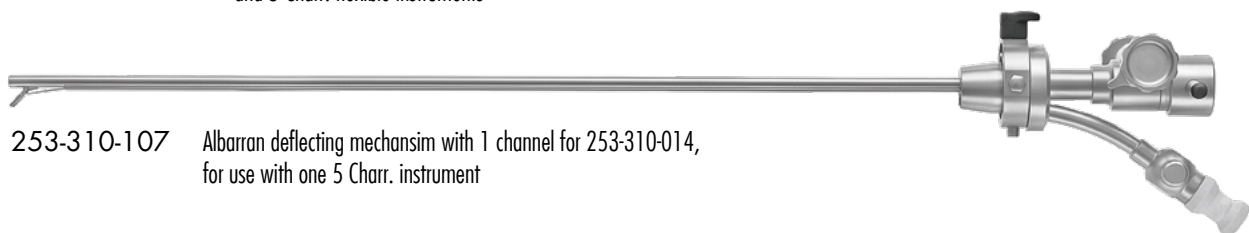

253-310-107 Albarran deflecting mechanism with 1 channel for 253-310-014, for use with one 5 Charr. instrument

Ø 2.0mm PEDIATRIC RESECTOSCOPE

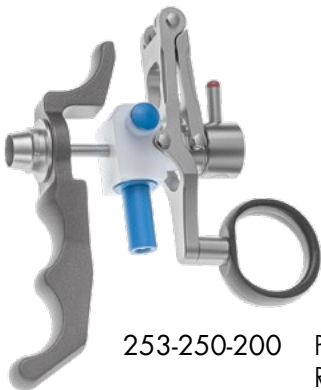
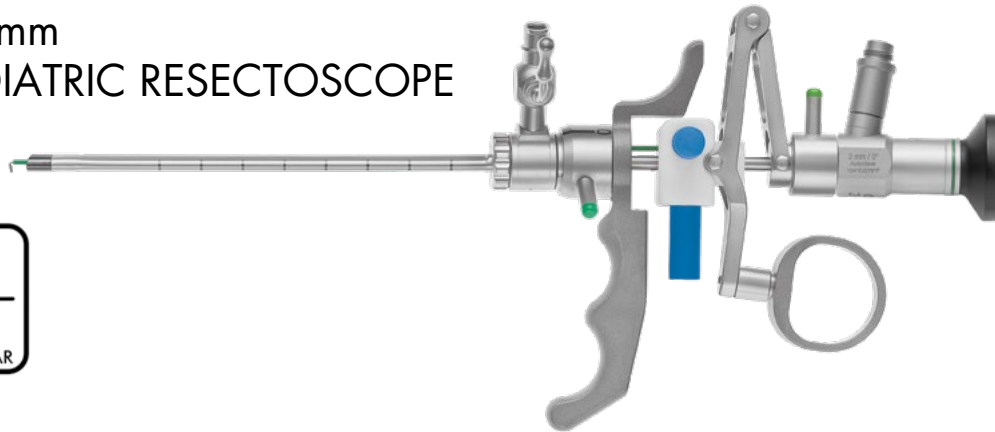

253-250-200 Passive working element for use with Ø 2.0mm RZ Fiber Cystoscope 253-219-100

RZ Pediatric Fiber Cystoscope Ø 2.0mm, 187.5mm length
253-219-100 0°
253-219-130 30°

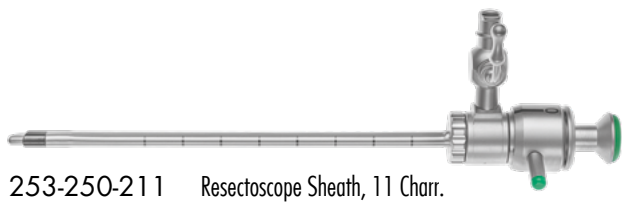
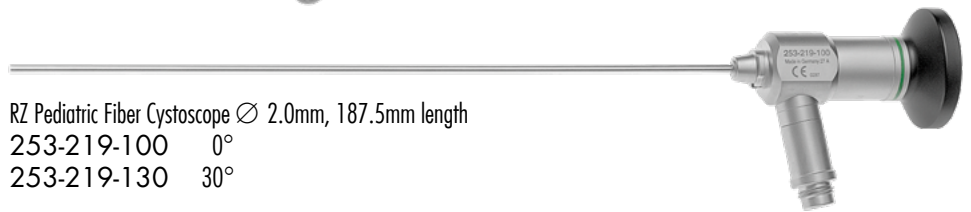

253-250-211 Resectoscope Sheath, 11 Charr. with obturator ●

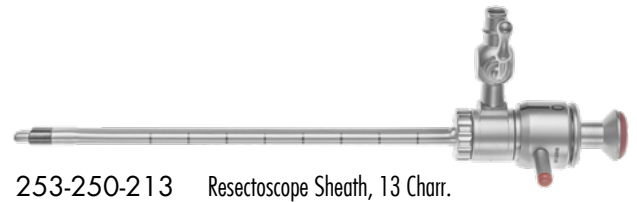

253-250-213 Resectoscope Sheath, 13 Charr. with obturator ●

Electrodes

11
CHARR.

13
CHARR.



Cutting Loop

253-251-111

253-252-111



Coagulation Electrode, blunt

253-251-112

253-252-112



Hook Electrode with ball

253-251-113

253-252-113



Hook Electrode without ball

253-251-114

253-252-114



Needle Electrode, pointed

253-251-115

253-252-115

Ø 2.0mm PEDIATRIC URETHROTOME

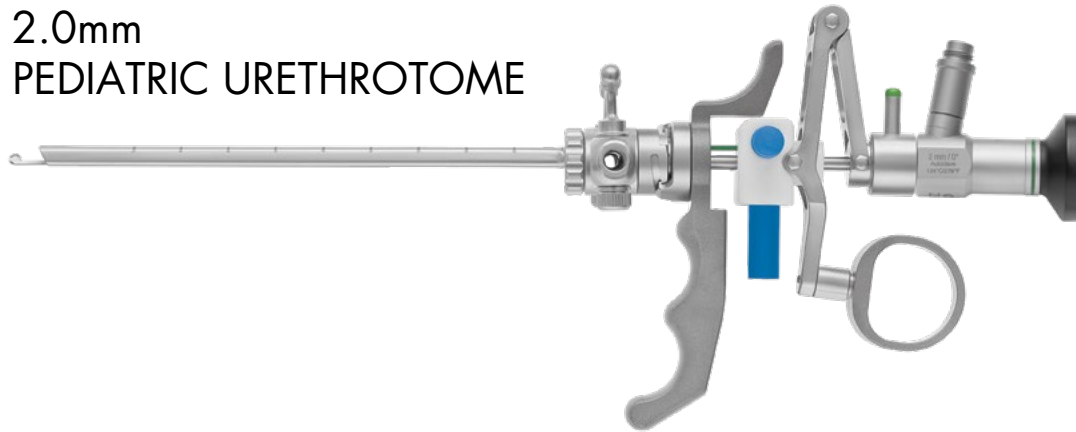

RZ Pediatric Fiber Cystoscope Ø 2.0mm, 187.5mm working length
 253-219-100 0°
 253-219-130 30°

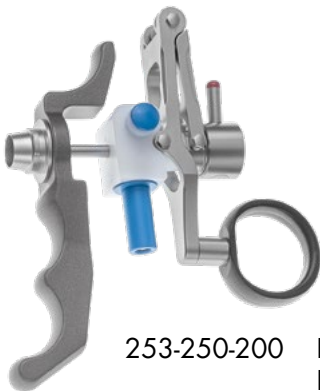
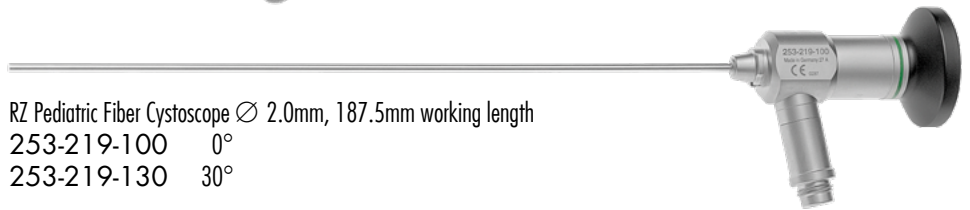

253-250-200 Passive working element for use with Ø 2.0mm
 RZ Fiber Cystoscope 253-219-100

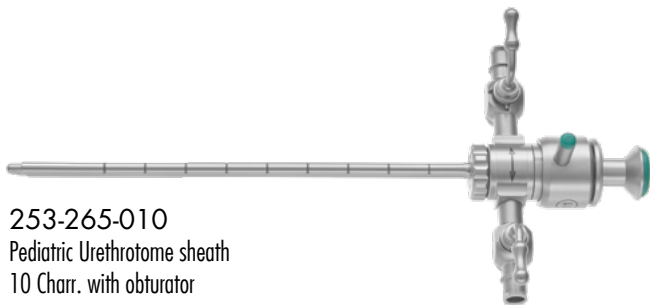

253-265-010
 Pediatric Urethrotome sheath
 10 Charr. with obturator



253-255-001 Bridge with 1 channel

Electrodes



Knife with straight cutting edge 253-265-101



Round knife 253-265-102



Sickle Knife 253-265-103



Hook Knife 253-265-104

RZ PEDIATRIC CYSTO-URETHRO-RENOSCOPE

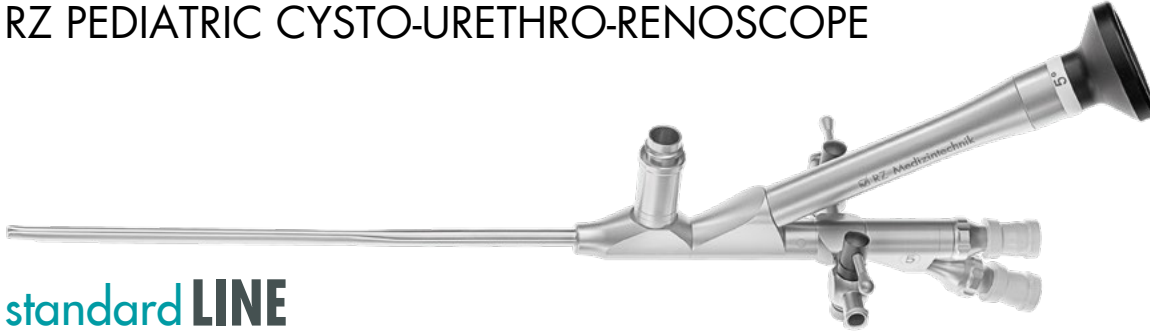

standard LINE

253-200-100 150mm

7.5 CHARR.	9.5 CHARR.	6.0 CHARR.
DISTAL	PROXIMAL	WORKING CHANNEL*

* for use with instruments up to 5 Charr.

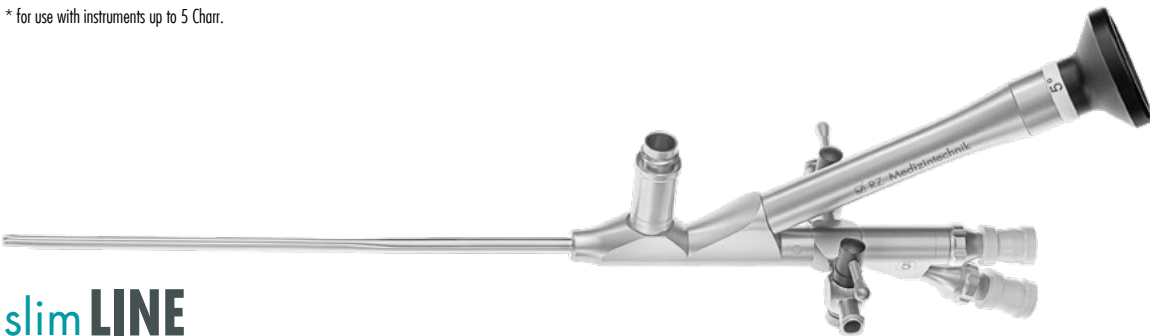

slim LINE

253-200-500 150mm

6.0 CHARR.	7.5 CHARR.	5.0 CHARR.
DISTAL	PROXIMAL	WORKING CHANNEL*

* for use with instruments up to 4 Charr.

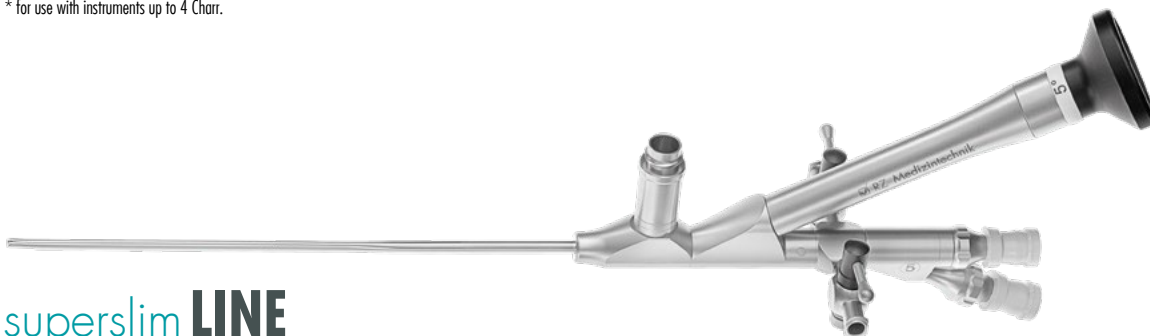

superslim LINE





253-200-600 150mm

4.5 CHARR.	6.0 CHARR.	3.5 CHARR.
DISTAL	PROXIMAL	WORKING CHANNEL*

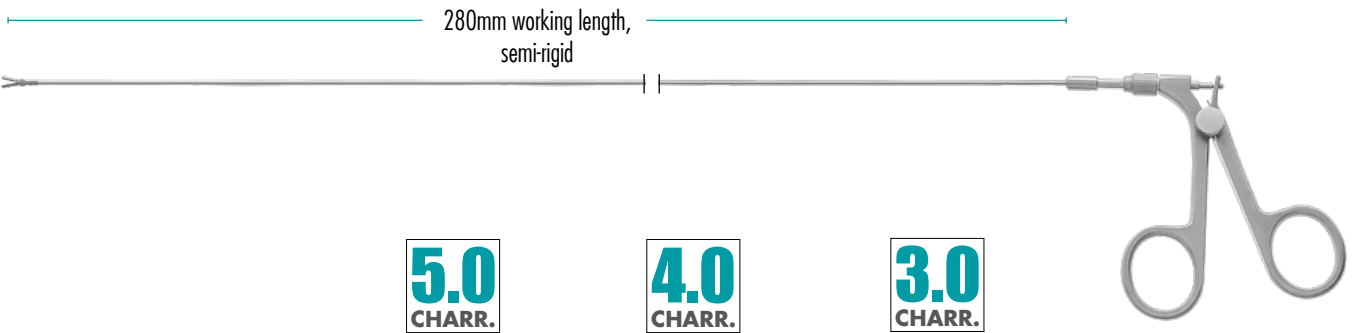

* for use with instruments up to 3 Charr.

INSTRUMENTS FOR PEDIATRIC CYSTO-URETHROTOMES

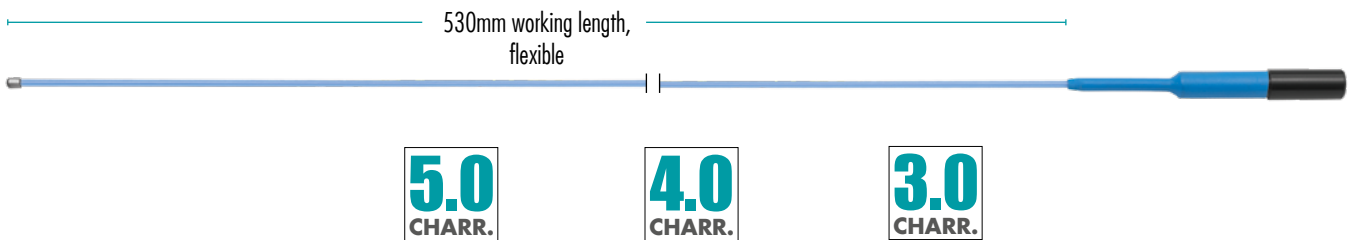

	5.0 CHARR.	4.0 CHARR.	3.0 CHARR.	
	253-200-128	253-204-128	253-203-128	Stone Grasping Forceps, double action jaws
	253-200-228	253-204-228	253-203-228	Large Stone Grasping Forceps, double action jaws
	253-200-328	253-204-328	253-203-328	Biopsy Forceps, double action
	253-200-428	253-204-428	253-203-428	Scissors, single action



	5.0 CHARR.	4.0 CHARR.	3.0 CHARR.	
	253-370-005	253-370-004	253-370-003	Ball Electrode
	253-371-005		253-371-003	Needle Electrode

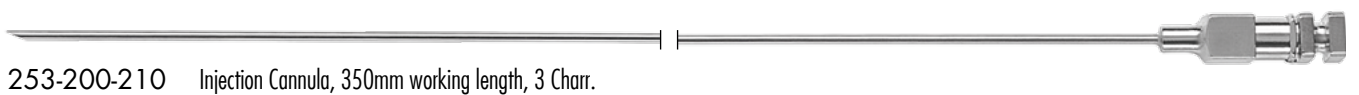

HIGH FREQUENCY CABLES for RZ pediatric resectoscope systems, 4.5m length



253-610-001* with 5 mm plug for Erbe HF-unit

253-610-002* with 4 mm plug for Martin HF-unit

253-610-003* with 8 mm plug for Valleylab HF-unit

253-610-004* with 4 mm plug for older HF-units

700-501-453* SDS plug

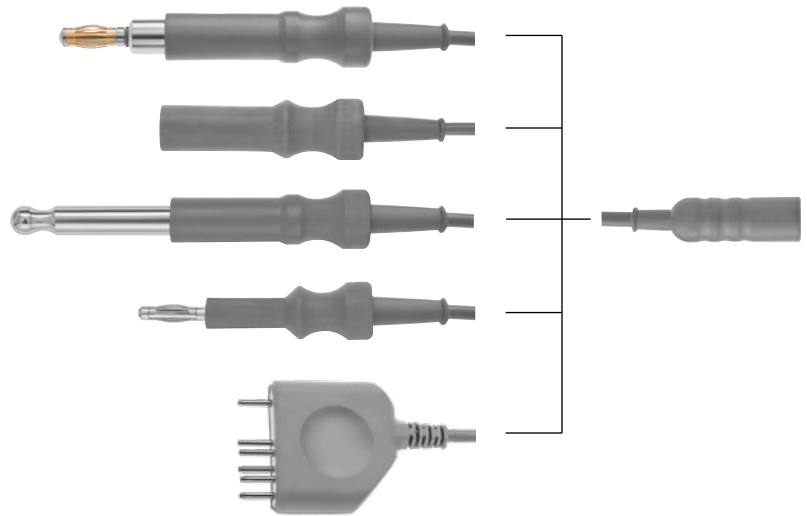

253-400-601 for Erbe HF-unit

253-400-602 for Martin HF-unit

700-500-453 SDS plug

253-400-606 for BOWA

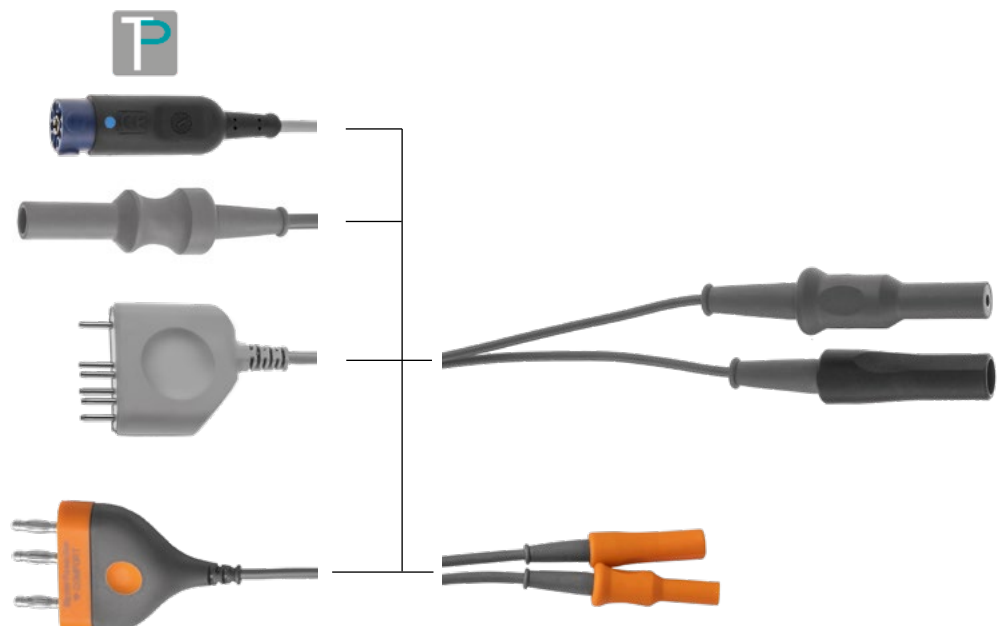

DEVICES AND FLEXIBLE INSTRUMENTS

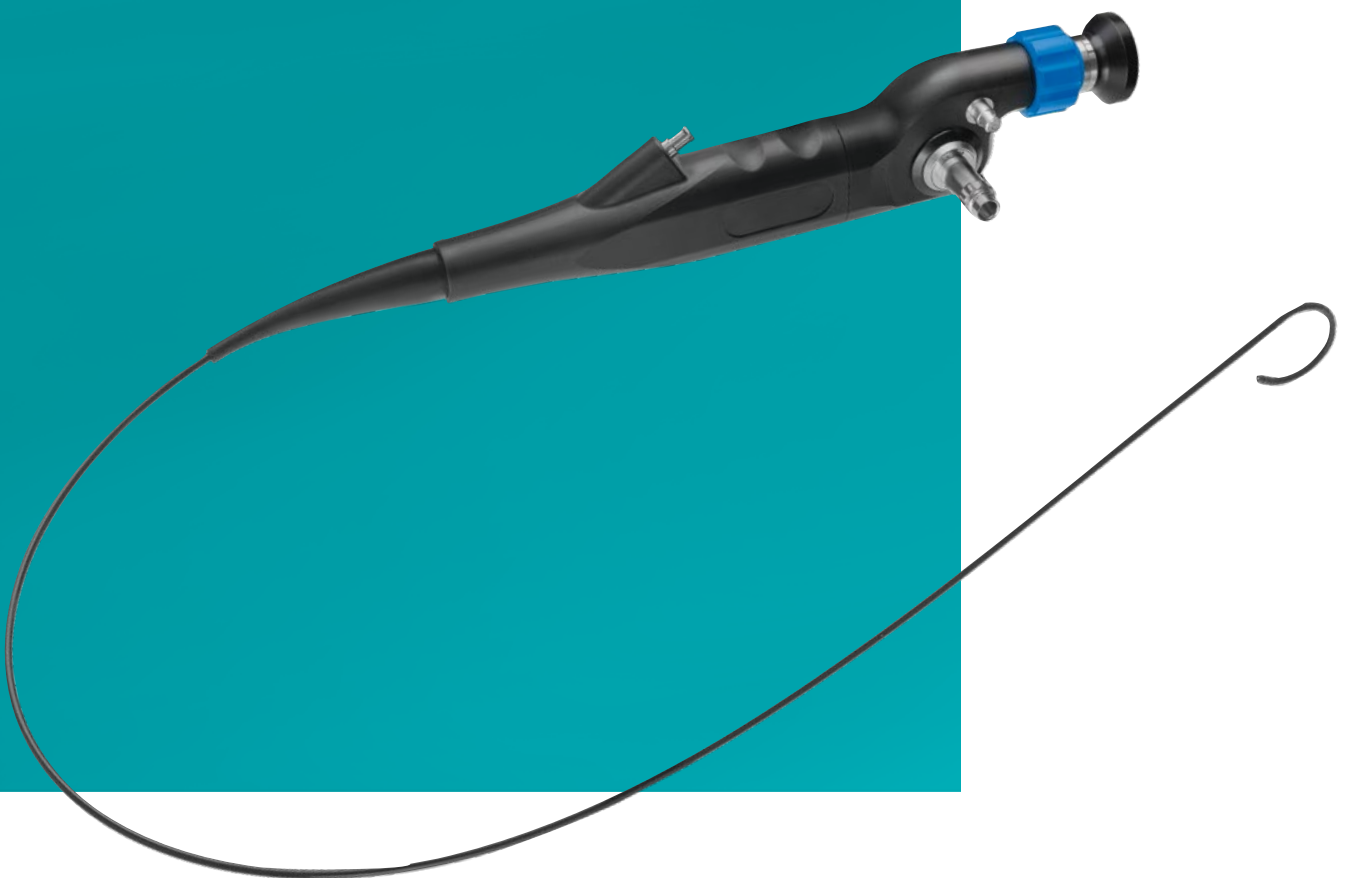

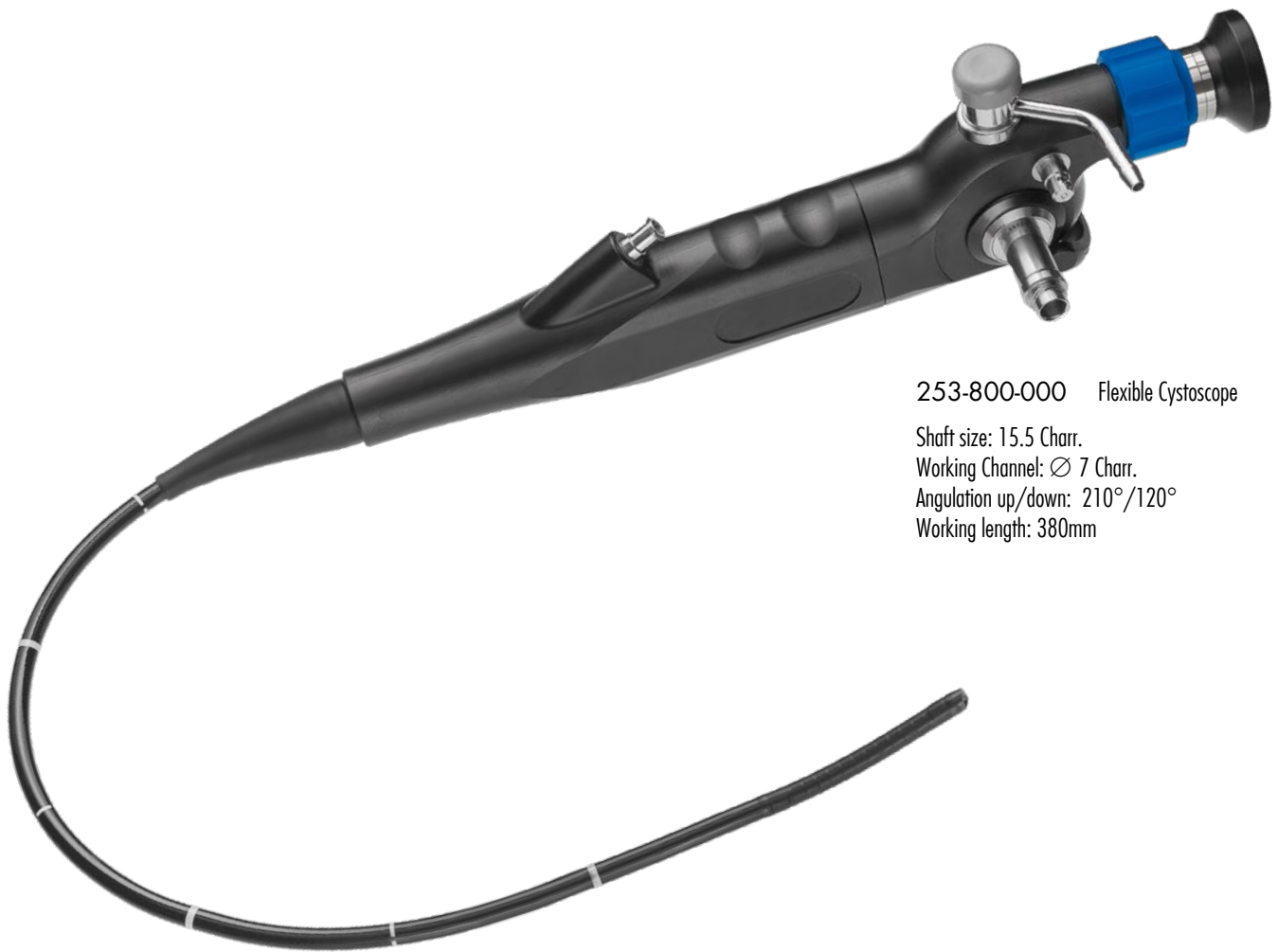

253-800-000 Flexible Cystoscope

Shaft size: 15.5 Charr.

Working Channel: \varnothing 7 Charr.

Angulation up/down: 210°/120°

Working length: 380mm



Shaft size: 15.5 Charr.
Slimline Sheath for
easy insertion



Angulation: 210°/120°



7 Charr. working
channel



Universal suction system



253-800-900 Flexible Uretero-Renoscope

Shaft size: 7.5 Charr.
 WorkingChannel: \varnothing 3.6 Charr.
 Angulation up/down: 275°/275°
 Working length: 680mm



Shaft size: 7.5 Charr.
 Slimline sheath for
 easy insertion



Angulation:
 275° / 275°



3.6 Charr. working
 channel



Ergonomic grip

ACCESSORIES

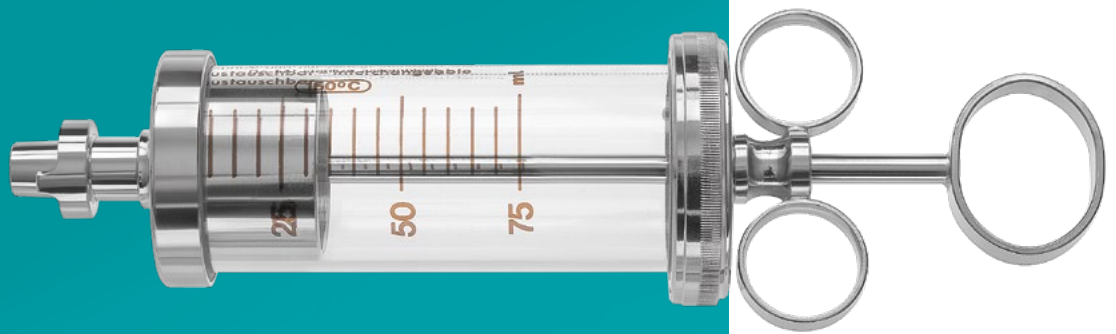

SYRINGES & EVACUATORS

with Turn Lock connection to connect to RZ Cystoscope and Resectoscope sheaths



TOOMEY Bladder Syringe
253-000-850 50cc



Bladder Syringe		Spare Glass Cylinder	
253-000-975	75cc	253-000-976	75cc
253-000-900	100cc	253-000-901	100cc
253-000-950*	150cc	253-000-951	150cc



Elik Evacuator
253-500-000 with turn lock connection
253-500-001 with standard connection

- 1** 253-500-003 Rubber ball
- 2** 253-500-004 Glass body
- 3** 253-500-020 Turn Lock connector with silicone tube
- 4** 253-500-010 Standard connector with silicone tube

ADAPTORS & VALVES



300-011-181* Luer-Lock tube connector,
9mm



300-011-506* Luer-Lock tube connector,
6mm



300-011-184* Luer-Lock Tuohy
Borst Adapter

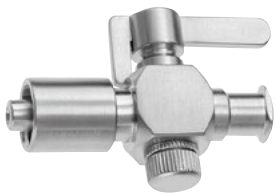

300-011-178 Luer-Lock one-way stop-cock
with spring screw cap



300-011-179* Luer-Lock tube connector
with stopcock



300-011-515* Luer-Lock one-way
stopcock



Rubber sealing cap
301-701-100* Grey / \varnothing 1.0mm
301-701-060 Green / \varnothing 0.6mm
301-701-030 Red / \varnothing 0.3mm



351-905-105 Disposable Silicone Valve
with Luer-Lock connection
for use with 3 - 10 Charr.
instruments, package with
10 pieces, sterile packed



300-400-900* Rubber Seal for
Luer-Lock connectors

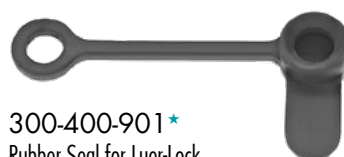

300-400-901* Rubber Seal for Luer-Lock
connectors

CATHETERS



Guyon Catheter Spanner & Introducer

- 1** 253-310-390* curved, 390mm
- 2** 253-310-391 straight, 390mm
- 253-310-392 straight, 455mm
- 253-310-393 straight, 510mm



320-603-455 Foley Catheter Spanner & Introducer, curved, 455mm



Catheter for male

- | | | | |
|-------------|-----------|-------------|-----------|
| 320-720-080 | 8 Charr. | 320-720-180 | 18 Charr. |
| 320-720-100 | 10 Charr. | 320-720-200 | 20 Charr. |
| 320-720-120 | 12 Charr. | 320-720-220 | 22 Charr. |
| 320-720-140 | 14 Charr. | 320-720-240 | 24 Charr. |
| 320-720-160 | 16 Charr. | | |



Catheter for female

- | | |
|-------------|-----------|
| 320-721-080 | 8 Charr. |
| 320-721-100 | 10 Charr. |
| 320-721-120 | 12 Charr. |
| 320-721-140 | 14 Charr. |
| 320-721-160 | 16 Charr. |
| 320-721-180 | 18 Charr. |
| 320-721-200 | 20 Charr. |
| 320-721-220 | 22 Charr. |
| 320-721-240 | 24 Charr. |

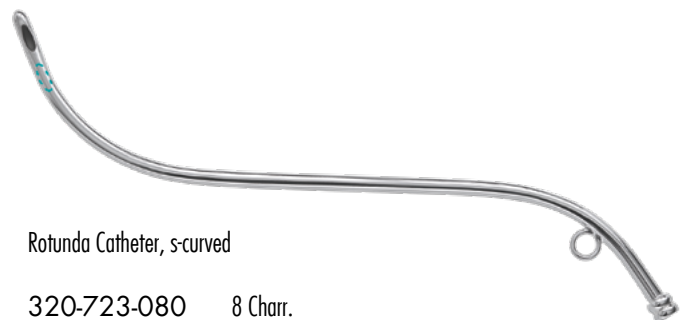

Rotunda Catheter, s-curved

- | | |
|-------------|-----------|
| 320-723-080 | 8 Charr. |
| 320-723-100 | 10 Charr. |
| 320-723-120 | 12 Charr. |
| 320-723-140 | 14 Charr. |
| 320-723-160 | 16 Charr. |
| 320-723-180 | 18 Charr. |
| 320-723-200 | 20 Charr. |
| 320-723-220 | 22 Charr. |
| 320-723-240 | 24 Charr. |

BOUGIES



Guyon Bougie, strongly curved

- 253-340-335* 8 Charr.
- 253-341-335 9 Charr.
- 253-342-335* 10 Charr.
- 253-343-335 11 Charr.
- 253-344-335* 12 Charr.
- 253-345-335* 14 Charr.
- 253-346-335* 16 Charr.
- 253-347-335* 18 Charr.
- 253-348-335* 20 Charr.

- | | |
|-----------------------|-----------------------|
| 253-349-335* 22Charr. | 253-354-335* 28Charr. |
| 253-350-335* 24Charr. | 253-355-335* 30Charr. |
| 253-351-335 25Charr. | 253-356-335 32Charr. |
| 253-352-335* 26Charr. | 253-357-335 34Charr. |
| 253-353-335 27Charr. | |

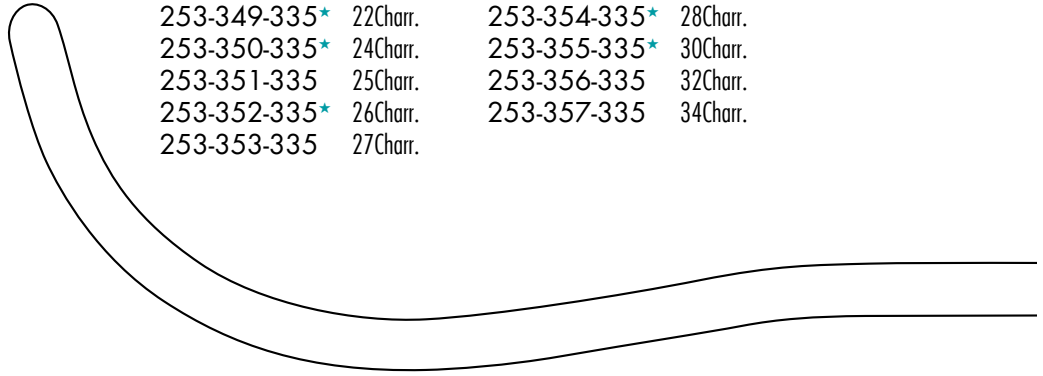

Van Buren Bougie, acutely curved

- 253-650-010* 10 Charr.
- 253-650-012* 12 Charr.
- 253-650-014* 14 Charr.
- 253-650-016* 16 Charr.
- 253-650-018* 18 Charr.
- 253-650-020* 20 Charr.
- 253-650-022* 22 Charr.

- | |
|------------------------|
| 253-650-024* 24 Charr. |
| 253-650-026* 26 Charr. |
| 253-650-028* 28 Charr. |
| 253-650-030* 30 Charr. |
| 253-650-032 32 Charr. |
| 253-650-034 34 Charr. |
| 253-650-036 36 Charr. |

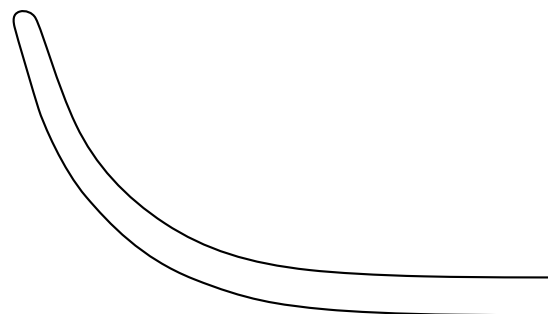

Dittel Bougie, slightly curved

- 253-320-335* 8 Charr.
- 253-321-335 9 Charr.
- 253-322-335* 10 Charr.
- 253-323-335 11 Charr.
- 253-324-335* 12 Charr.
- 253-325-335* 14 Charr.
- 253-326-335* 16 Charr.
- 253-327-335* 18 Charr.
- 253-328-335* 20 Charr.

- | |
|------------------------|
| 253-329-335* 22 Charr. |
| 253-330-335* 24 Charr. |
| 253-331-335 25 Charr. |
| 253-332-335* 26 Charr. |
| 253-333-335 27 Charr. |
| 253-334-335* 28 Charr. |
| 253-335-335* 30 Charr. |
| 253-336-335 32 Charr. |
| 253-337-335 34 Charr. |

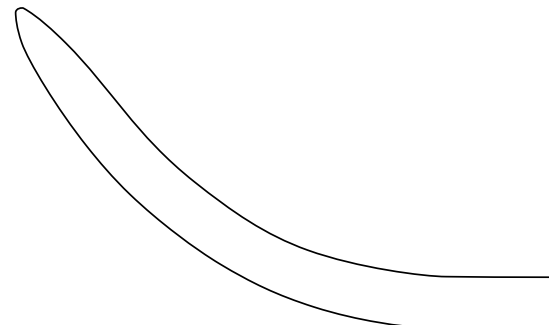

BOUGIES & DILATORS



OTIS Bougie à Boule
 253-370-009 9 - 12 - 15 - 18 Charr.
 253-370-021 21 - 24 - 27 - 30 Charr.



Dittel Bougie, straight

253-320-225	8 Charr.	253-329-225	22 Charr.
253-321-225	9 Charr.	253-330-225	24 Charr.
253-322-225	10 Charr.	253-331-225	25 Charr.
253-323-225	11 Charr.	253-332-225	26 Charr.
253-324-225	12 Charr.	253-333-225	27 Charr.
253-325-225	14 Charr.	253-334-225	28 Charr.
253-326-225	16 Charr.	253-335-225	30 Charr.
253-327-225	18 Charr.	253-336-225	32 Charr.
253-328-225	20 Charr.	253-337-225	34 Charr.



RZ Orifice Dilator
 253-375-015 15 - 30 Charr.



Ureteral Dilator, flexible, 500mm



253-920-090 9.0 Charr.



253-920-135 13.5 Charr.



253-920-105 10.5 Charr.



253-920-150 15.0 Charr.



253-920-120 12.0 Charr.

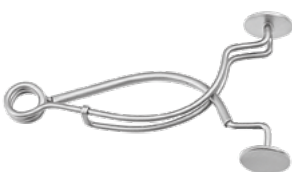

320-998-000 Stockmann Meatus Clamp, 8cm



320-999-000* Strauss Penis Seizing Forceps, 13cm

CLEANING

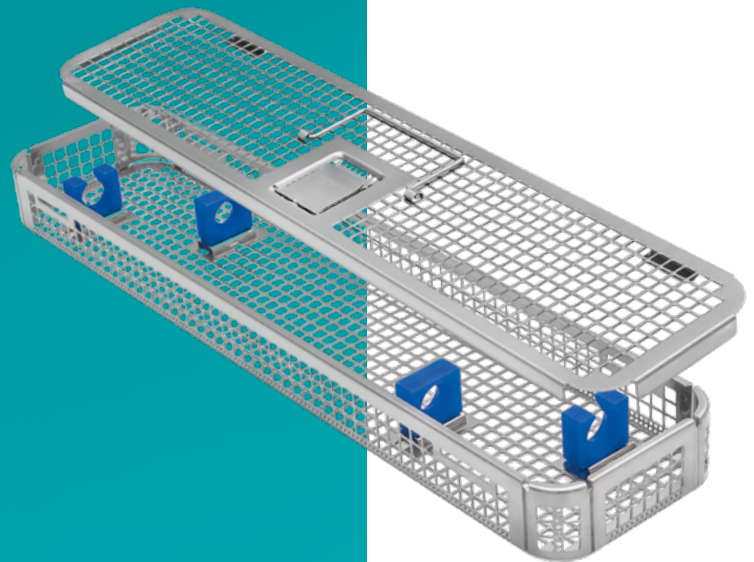

SAFE + CLEAN ENDOSCOPE PLASTIC CONTAINER with silicone bars on base and lid

600-505-000

Endoscopes	1 (∅ 1-10mm)
Endoscope length	max. 270mm
Dimensions	271 x 70 x 35mm

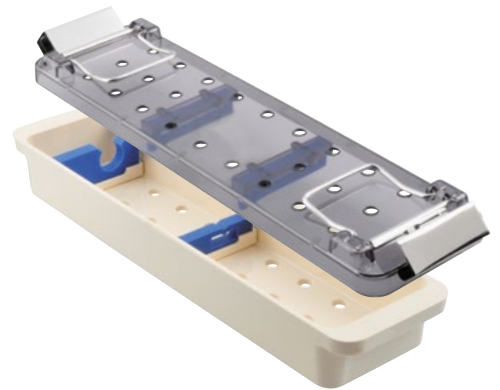

600-505-002

Endoscopes	max. 2
Endoscope length	max. 190mm
Dimensions	271 x 70 x 35mm

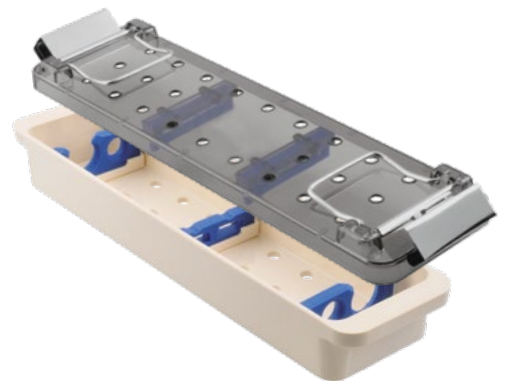

600-506-002*

Endoscopes	max. 2
Endoscope length	max. 390mm
Dimensions	394 x 70 x 35mm

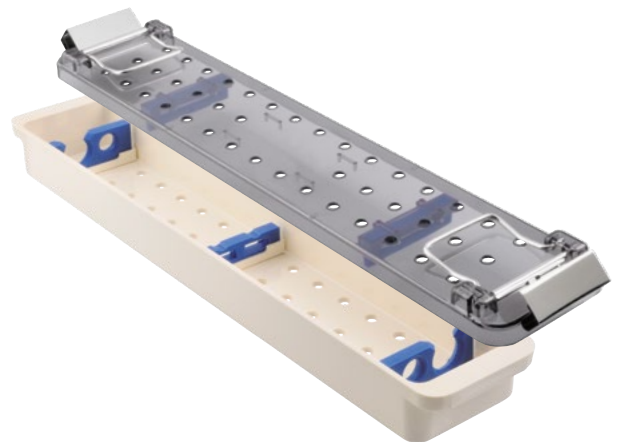

600-501-000

Endoscopes 1

600-501-002

Endoscopes max. 2

Endoscope length	max. 450mm
Dimensions	457 x 70 x 35mm

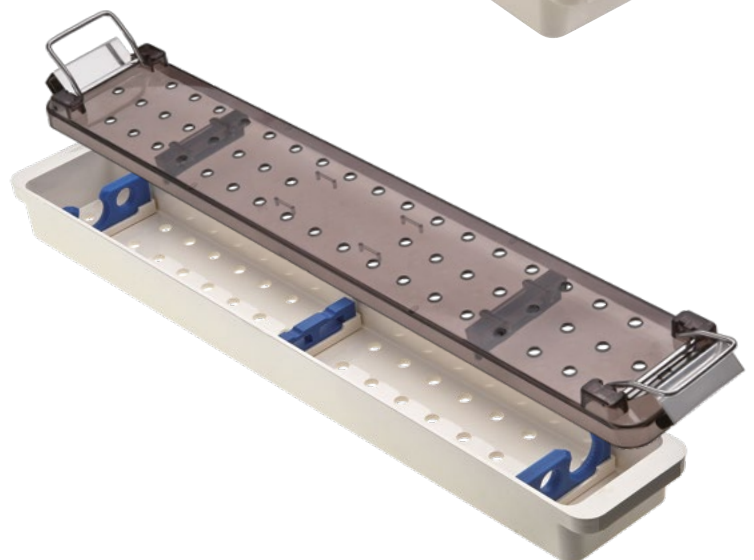

ENDOSCOPE & INSTRUMENT CONTAINERS

600-508-000 for scopes and light guide cables

Endoscopes	max. 3 (Ø 5-10mm)
Fiber Optic Light Cable	1
Endoscope length	max. 450mm
Dimensions	465 x 212 x 51mm

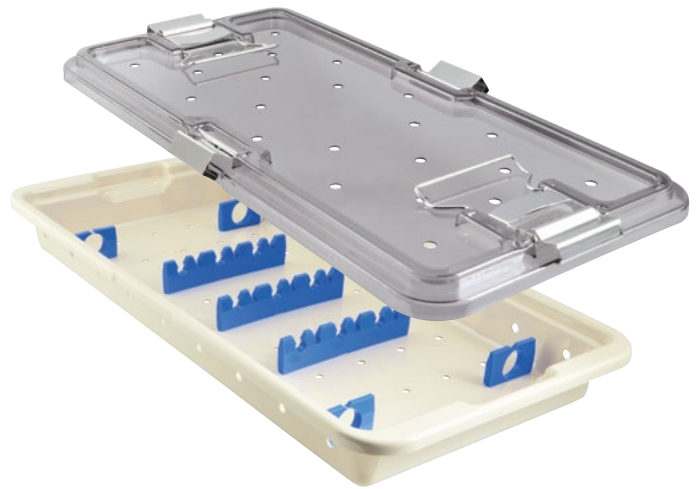

600-464-229 for fixation of instruments with rubber ties

Dimensions	464 x 229 x 51mm
------------	------------------

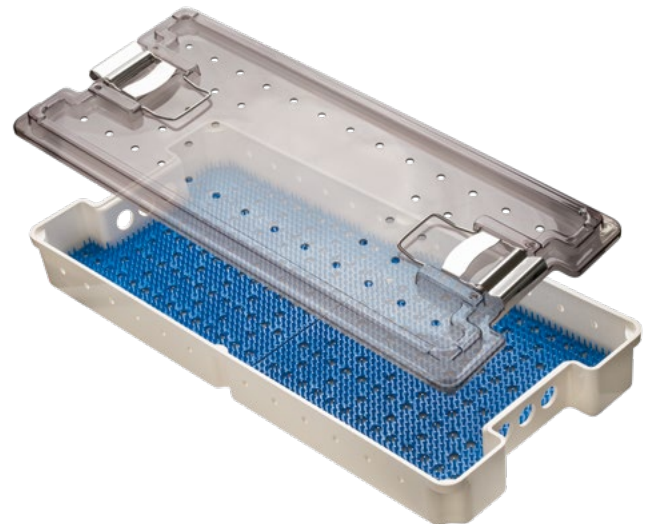

600-511-000 for instruments with rubber ties on 2 levels

Dimensions	502 x 239 x 102mm
------------	-------------------



ENDOSCOPE CLEANING BASKETS & CONTAINERS with silicone bars on base and lid

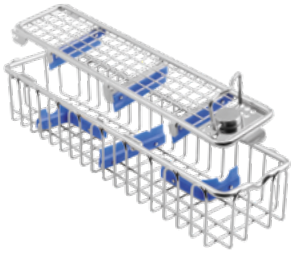

600-292-052*

Endoscopes	max. 2
Endoscope length	max. 190mm
Dimensions	290 x 80 x 52mm

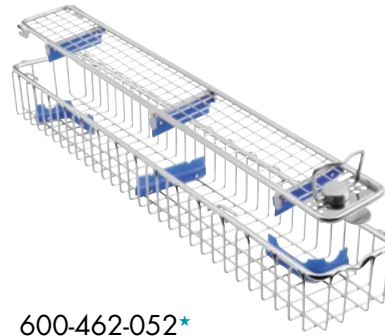

600-462-052*

Endoscopes	max. 2
Endoscope length	max. 350mm
Dimensions	460 x 80 x 52mm

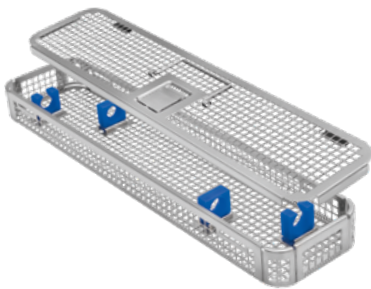

600-460-055	Endoscopes 1
600-460-056	Endoscopes max. 2
Endoscope length	max. 340mm
Dimensions	455 x 86 x 43mm

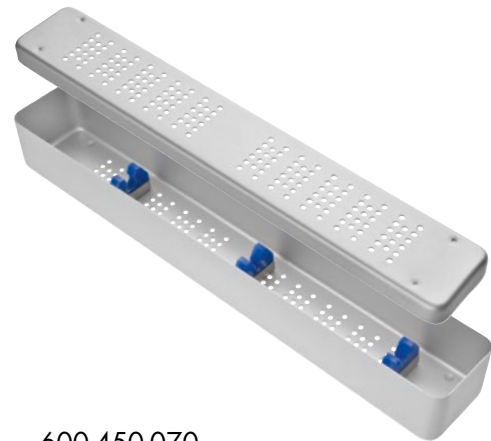

600-450-070	Endoscopes max. 2
Endoscope length	max. 330mm
Dimensions	450 x 70 x 70mm

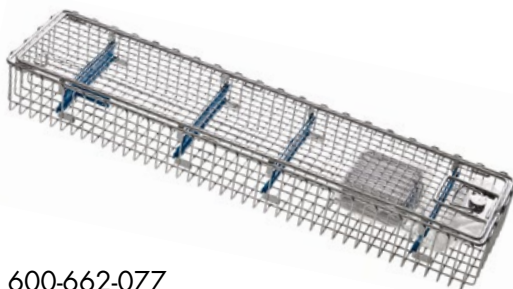

600-662-077
Endoscopic wire basket for URS
640 x 150 x 77mm

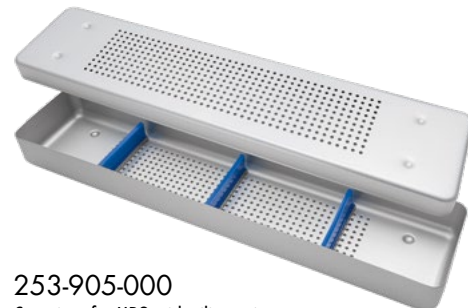

253-905-000
Container for URS with silicone inserts
640 x 140 x 60mm

TRAYS FOR MiLEP SYSTEM

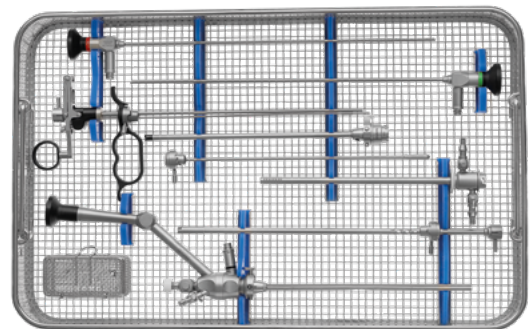
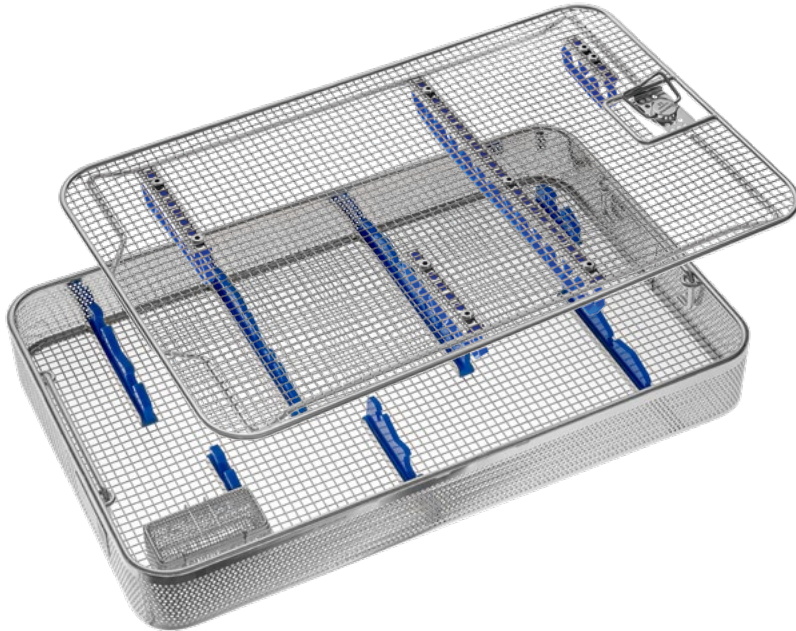

600-605-220 MiLEP Wire Basket
480 x 300 x 60mm

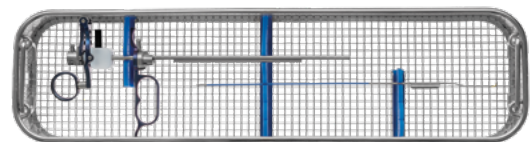
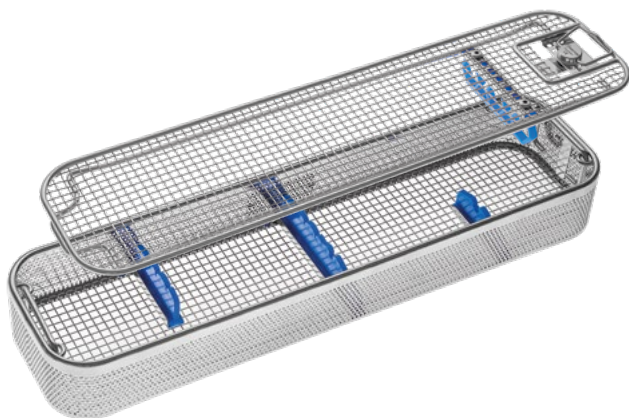

600-605-411 Wire basket for 22 Charr. Resectoscope
480 x 125 x 60mm



1/1

Stainless Steel Basket,
round perforation, with lid

Length

545mm / 485mm

complete

600-540-535	545 x 255 x 35mm
600-540-555	545 x 255 x 55mm
600-540-575	545 x 255 x 75mm
600-540-605	545 x 255 x 105mm
600-485-535	485 x 255 x 35mm
600-485-555	485 x 255 x 55mm
600-485-575	485 x 255 x 75mm
600-485-605	485 x 255 x 105mm

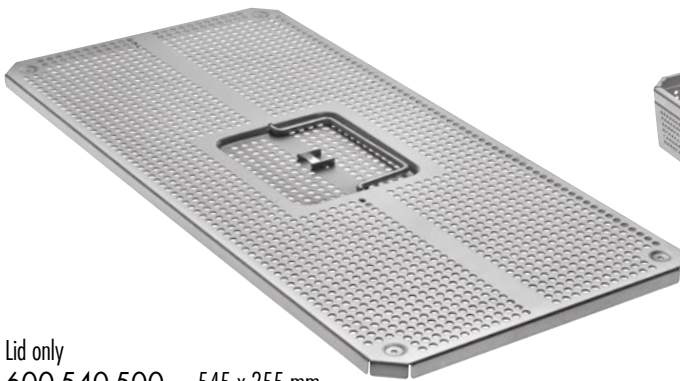

Lid only

600-540-500	545 x 255 mm
600-485-500	485 x 255 mm



Bottom only

600-540-530	545 x 255 x 30mm
600-540-550	545 x 255 x 50mm
600-540-570	545 x 255 x 70mm
600-540-600	545 x 255 x 100mm
600-485-530	485 x 255 x 30mm
600-485-550	485 x 255 x 50mm
600-485-570	485 x 255 x 70mm
600-485-600	485 x 255 x 100mm

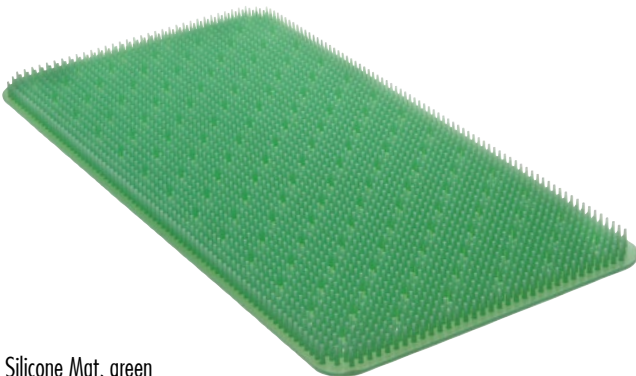

Silicone Mat, green

600-281-004	520 x 230mm
600-281-003	440 x 230mm

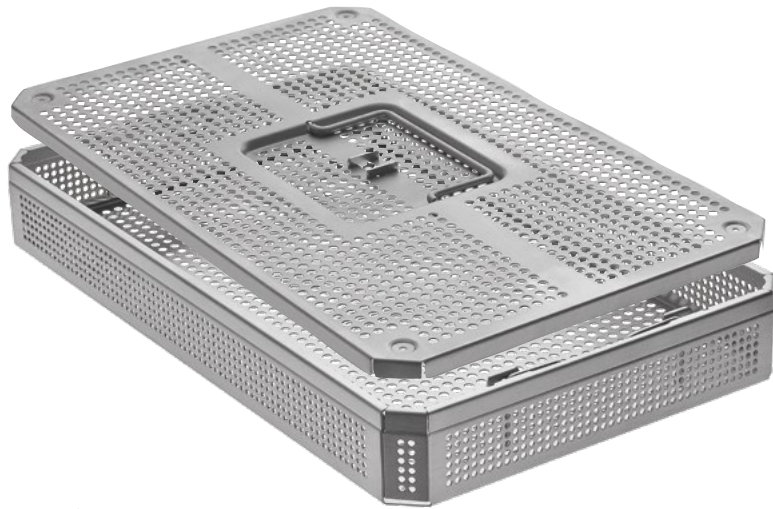

3/4

Stainless Steel Basket,
round perforation, with lid

Length

405mm

600-405-535 405 x 255 x 35mm
 600-405-555 405 x 255 x 55mm
 600-405-575 405 x 255 x 75mm
 600-405-605 405 x 255 x 105mm



Lid only
 600-405-500 405 x 255 mm



Bottom only
 600-405-530 405 x 255 x 30mm
 600-405-550 405 x 255 x 50mm
 600-405-570 405 x 255 x 70mm
 600-405-600 405 x 255 x 100mm

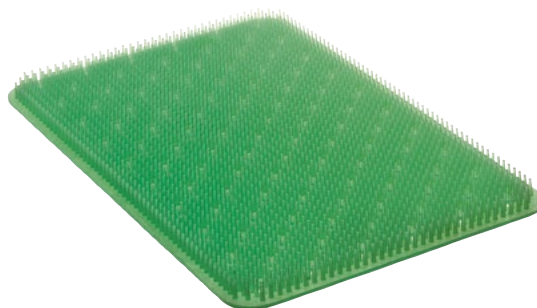

600-281-002 Silicone Mat green, 380 x 230mm



1/2

Stainless Steel Basket,
round perforation, with lid

Length

255mm

600-255-535 255 x 245 x 35mm
 600-255-555 255 x 245 x 55mm
 600-255-575 255 x 245 x 75mm
 600-255-605 255 x 245 x 105mm

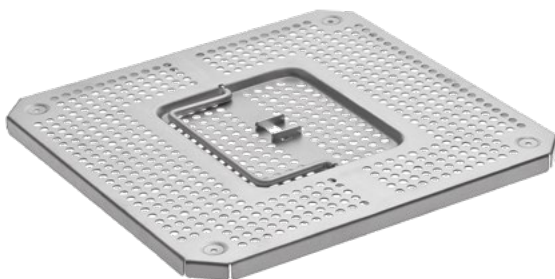

Lid only
 600-255-500 255 x 245 mm



Bottom only
 600-255-530 255 x 245 x 30mm
 600-255-550 255 x 245 x 50mm
 600-255-565 255 x 245 x 70mm
 600-255-600 255 x 245 x 100mm

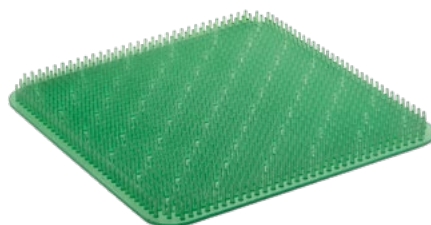

600-281-001 Silicone Mat green, 220 x 230mm

Cleaning



600-100-000
RZ-Aquajet
Water Jet Pistol complete
with 9 tips and 1m pressure
tubing, with strap and
suspension hook



600-050-000
Hand brush, autoclavable
(10 pcs. per box)



600-950-100
RZ - Brush dispenser
for 10 brushes with suspension hook



700-900-220 Special Cotton for polishing metal sheaths and instruments

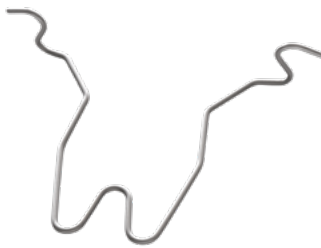

660-166-100
Holding Device for cleaning & sterilization



700-900-160
Instrument Oil in 50ml bottle



700-900-250
Oil Dispenser, 140mm



Cleaning brush (1 piece per box), 500mm length
300-135-905 for \varnothing 5 mm
300-135-910 for \varnothing 10 mm



300-215-000 Cleaning Brush, \varnothing 13mm, 215mm length, 60mm brush length



300-420-065 Cleaning Brush, \varnothing 3mm, 420mm length, 65mm brush length

EQUIPMENT



FLUID MANAGEMENT



Features:

- Versatile Irrigation Pump
- Pump leveling adjustment
- Pressure controlled roller pump

DELIVERY CONTAINS:

- Pump device
- Tubing set (253-910-001)
- Mains cable
- 2 Spare fuses
- Operating manual

253-910-000 Basic Irrigation Pump P1

Technical data

Line voltage	100-240 VAC
Power input	80VA
Irrigation power	0 - 1.0L/min
Pressure range	10 - 150mmHG
Measurements	380 x 130 x 400mm (WxHxD)
Weight	approx. 11kg

Accessories

253-910-001	Irrigation Tubing Set, silicone, autoclavable	non-sterile	included
253-910-002	Irrigation Tubing Set, PVC, 20 pieces, daily tube	sterile	optional
253-910-003	Patient tube, PVC, 2.5m, 40 pieces	sterile	optional

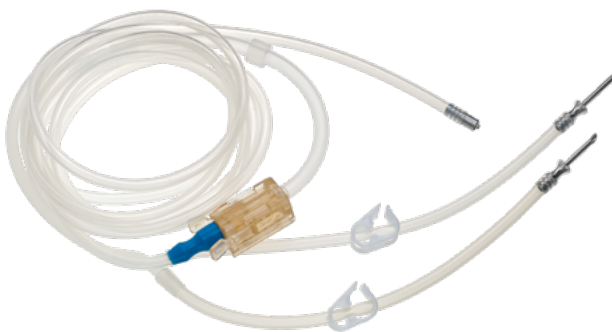

4K CAMERA SYSTEM



300-001-840 4K 3-Chip UHD-Camera K 4000

4K

Features:

- 4K UHD resolution with 3-chip technology
- Image algorithm enhancement of color and structure
- 4K video recording
- 4K image saving
- Camera head with 4 programmable buttons
- Boost function
- Fog reduction
- Freeze function
- 2.5x digital zoom
- 10 USER mode configurations
- Multilingual on screen menu
- SDI 4K Output
- Text generator (optional with keyboard)

DELIVERY CONTAINS:

- Main Unit (300-001-840)
- Camera head (300-001-841)
- HDMI cable
- USB Pen Drive
- Mains cable
- Operating manual

Technical data

Line voltage	100-240 VAC	Video outputs	1x HDMI 4K 1x HDMI FullHD 1x SDI 4K 1x SDI FullHD
Power consumption	60VA	Dimensions	Control unit: 355 x 103 x 350mm (WxHxD) Weight control unit: 6.2kg Weight camera head: 145g
Image sensor	3 MOS		
Resolution	3840 x 2160 pixels (4K)		
Index ratio	16:9		
N/N ratio	54db		

Accessories



300-001-841
UHD 3-Chip Camera Head
(included in the set)



300-001-615
Title generator keyboard, waterproof IP68
US-Layout, cable 1.8m, color: grey,
305x140x15mm, 600gr.



300-001-610
Footswitch for HD Cameras
cable length: 2m

FULL HD CAMERA SYSTEM



Features:

- Full HD camera with 3-chip MOS technology
- Pure Natural Colors technology
- Full HD video recording (F4 only)
- Full HD image saving (F4 only)
- Camera head with 3 programmable buttons
- Boost function
- Freeze function
- 2.5x digital zoom
- 3 USER mode configurations
- Multilingual on screen menu
- Different digital video outputs
- Text generator (optional with keyboard)

DELIVERY CONTAINS:

- Main Unit
- Camera head
- 2x BNC cable
- HDMI - DVI cable
- HDMI cable
- S-Video cable (F3 only)
- USB Pen Drive (F4 only)
- Mains cable
- Operating manual

- 300-001-800 3 Chip HD-Camera F3
- 300-001-804 3 Chip HD-Camera F4 (with recording function)

FULL HD

Technical data

Line voltage	100-240 VAC
Power input	20W
Image sensor	3 MOS
Resolution	1920 x 1080 pixels (FullHD)
Image resolution	>1000 TV lines, horizontal
Index ratio	16:9
Min. sensitivity	< 3lx (1/1.4)
Shutter speed	1/50 (1/60) to 1/100.000sec

Video outputs (F4)	2 x HD SDI 1x HDMI / DVI 2x CVBS 1 x YPbPr / RGB 1 x Y/C (Pal/NTSC) 1x CVBS (Pal/NTSC)
Video outputs (F3)	1 x HDMI / DVI 1 x YPbPr (Component) 1 x Y/C (Pal/NTSC) 1x CVBS (Pal/NTSC)
Dimensions	Control unit: 380 x 120 x 360mm (WxHxD) Weight control unit: 11kg Weight camera head: 145g

Accessories



300-001-802
High-End 3-MOS Camera Head
FullHD (included in the set)



300-001-615
Title generator keyboard, waterproof IP68
US-Layout, cable 1.8m, color: grey,
305x140x15mm, 600gr.



300-001-610
Footswitch for HD Cameras
cable length: 2m

FULL HD CAMERA SYSTEM



Features:

- Full HD camera with 1-chip MOS technology
- Natural color technology
- Full HD video recording (F2 Pro only)
- Full HD image saving (F2 Pro only)
- Camera head with 3 programmable buttons
- Boost function
- Freeze function
- 2.5x digital zoom
- 3 USER mode configurations
- Multilingual on screen menu
- HDMI video outputs
- Text generator (optional with keyboard)

300-001-600 HD-Camera F1
 300-001-601 HD-Camera F2 Pro (with recording function)

FULL HD

Technical data

Line voltage	100-240 VAC
Power input	F2 Pro: 30W / F1: 20W
Image sensor	1/3" MOS
Resolution	1920 x 1080 pixels (FullHD)
Image resolution	>1000 TV lines, horizontal
Index ratio	16:9
Min. sensitivity	< 3lx (1/1.4)

DELIVERY CONTAINS:

- Main Unit
- Camera head
- 2x BNC cable
- HDMI - DVI cable
- HDMI cable
- S-Video cable
- USB Pen Drive (F2 Pro only)
- Operating manual
- Mains cable

Video outputs (F2 Pro)	2 x HD SDI (optional) 1 x HDMI / DVI 1 x Y-Pb-Pr (Component) 1 x Video (PAL/NTSC) 1 x S-Video (PAL/NTSC)
Video outputs (F1)	1 x HDMI 1 x YPbPr / RGB 1 x S-Video (Y/C; Pal / NTSC) 1 x Video (CVBS; Pal / NTSC)
Dimensions	Control unit: 380 x 120 x 360mm (WxHxD) Weight control unit: 11kg Weight camera head: 105g

Accessories



300-001-602
 High-End 1/3" MOS Camera Head
 Full HD (included in the set)



300-001-615
 Title generator keyboard, waterproof IP68
 US-Layout, cable 1.8m, color: grey,
 305x140x15mm, 600gr.



300-001-610
 Footswitch for HD Cameras
 cable length: 2m

TV COUPLER



4K
FULL HD

300-001-823 f=14mm
300-001-824 f=25mm
300-001-825 f=28mm
c-mount, soakable



4K
FULL HD

250-015-030
Zoom-TV-Adapter
f=15 - 30mm
c-mount, soakable



4K
FULL HD

250-015-036
Zoom-TV-Adapter
f=15 - 36mm
c-mount, soakable



FULL HD

300-001-813 f=14mm
300-001-814 f=25mm
300-001-815 f=28mm
c-mount, soakable



FULL HD

250-020-025 F=25mm (splitting 90/10)
250-020-030 F=30mm (splitting 90/10)
Beamsplitter, allows simultaneous video
and direct views, c-mount, soakable

LED LIGHT SOURCE



Features:

- 6500K daylight color temperature
- 375 Watt equivalent output power
- > 20.000 hours lifetime
- Turret connector for the most common light cables (Olympus, Wolf, Gyrus ACMI, Storz)
- Manual or automatic light control
- Waterproof touch control panel
- Low heat conduction by improved LED technology
- Boost function: light increase of 20%

300-900-300 LUMEN LED 3 PRO Light Source, 110 - 230V



Technical data

Line voltage	100-240 VAC
Video input	1x Video, BNC
Protection class	1 (acc. IEC 60601-1) 1 (acc. MDD 93/42/EEC)
Safety class	BF
Standard	IEC 60601-1-2
Dimensions	380 x 120 x 360mm (WxHxD)
Weight	approx. 11kg

DELIVERY CONTAINS:

- Main Unit (300-900-300)
- BNC cable (optional)
- Mains cable
- Operating manual



- A OLYMPUS
- B WOLF
- C GYRUS ACMI
- D STORZ

Turret, multi connector

LED LIGHT SOURCE



Features:

- More than 20.000h lamp lifetime
- 180 Watt equivalent power output
- Manual or automatic light control
- Waterproof touch control panel
- Low heat conduction by improved LED technology
- Daylight color temperature 6000 – 6500° K for accurate color representation
- Boost function: light increase of 20%

300-900-180 LUMEN LED 1 Light Source



DELIVERY CONTAINS:

- Main Unit (300-900-180)
- BNC cable
- Mains cable
- Operating manual

Technical data

Line voltage	100-240 VAC
Power consumption	130VA
Video input	1x Video, 1x S-Video (Y/C) (automatic version only)
Protection class	1 (acc. IEC 60601-1) 1 (acc. MDD 93/42/EEC)
Safety class	BF
Dimensions	380 x 120 x 360mm (WxHxD)
Weight	approx. 11kg

HIGH TEMPERATURE LED/XENON LIGHT CABLES



Adaptor pieces to use with **endoscope**



250-042-000
RZ/Storz/Olympus



250-040-000
Wolf



250-041-000
ACMI/British Standard

XENON/LED Light Guide Cables
with melt and bending protection

250-025-230 Ø 2.5 mm, 2300 mm

250-025-300 Ø 2.5 mm, 3000 mm

250-035-180 Ø 3.5 mm, 1800 mm

250-035-230 Ø 3.5 mm, 2300 mm

250-035-300 Ø 3.5 mm, 3000 mm

250-048-180 Ø 4.8 mm, 1800 mm

250-048-230 Ø 4.8 mm, 2300 mm

250-048-300 Ø 4.8 mm, 3000 mm

Adaptor pieces to use with **light source**



250-039-000
RZ/Storz



250-038-000
ACMI/CUDA



250-048-000
Luxtec



250-051-000
Stryker



250-037-000
Wolf



250-044-000
Olympus



250-045-000
Olympus - Standard



250-052-000
Heine



250-059-000
Pentax



COMPATIBILITY NOTE:

A fiber optic cable with a large diameter should not be connected to a smaller diameter scope.
For example: Ø 4.8mm fiber optic cables connected to a Ø 2.9mm may risk high temperature at the light entry of the endoscope and may risk patient safety.

ELECTROSURGICAL GENERATOR



Features:

- Monopolar/bipolar cutting and coagulation
- Automatic identification of connected instruments
- Powerstart System simplifies the beginning of cutting process
- Automatic power regulation
- 105 different memory locations in 7 groups
- Various output configuration of the sockets available
- 10" Touchscreen
- Tiltable display
- Footswitch (optional)
- Available with Argon and / or the RZeal
- Real-time output monitoring

DELIVERY CONTAINS:

- Main Unit
- Mains Cable (Footswitch not included)

700-350-400 230V
 700-350-410 110V
 G400 ElectroSurgical Generator

Technical data

Line voltage	110-230 VAC
Power consumption	500W
Generator operation frequency	333kHz
Display	TFT 10"
Defibrillation impulse resistance	acc. to EN 60601-1
NEM system	neutral electrode control optical indication 7 levels required resistance < 240 Ω
Gas type	pure argon 4.8 (99,998%) or higher
Inlet gas pressure	0.25-0.4 [MPa]
Monopolar coagulation / cutting	200W / 400W
Bipolar coagulation / cutting	400W / 400W

Gas outflow	0.1-10 l/min, regulated 0.1 l/min in whole range
Pressure range	reducer (0.4 MPa) on argon cylinder
Vessel sealing system	9 effects/300W
AutoStop	automatic stop of sealing process after achieving the optimal effect
Dimensions	495 x 415 x 225mm (LxWxH)
Weight	12.2kg

Accessories



700-350-405
 2-Button-Footswitch, length: 5m
 700-350-402
 3-Button-Footswitch, length: 5m, quick access key



Disposable Neutral Electrode hydrogel, split, for adults or children
 10x5 pcs. per package
 700-503-000 Adults
 700-503-001 Children



Cable for Disposable Neutral Electrode
 5m, RZ compatible only
 700-503-003

ELECTROSURGICAL GENERATOR



Features:

- Monopolar/bipolar cutting and coagulation
- Automatic instrument detection system
- Intuitive Touchscreen
- Automatic power regulation
- Configurable working modes
- Real-time parameter control
- Special endoscopic modes
- Bipolar resection
- Easy software update

700-340-400 230V
 700-340-410 110V
 G44 Electrosurgical Generator

DELIVERY CONTAINS:

- Main Unit
 - Mains Cable
- (Footswitch not included)

Technical data

Line voltage	110-240 VAC
Power consumption	1100VA
Generator operation frequency	333kHz
Display	TFT 7" WVGA
Spectrum result system	automatic power regulation
Monopolar coagulation	max. 200W (200Ω)
Monopolar cutting	max. 400W (100Ω)
Bipolar coagulation	max. 400W (25Ω)
Bipolar cutting	max. 330W (150Ω)

NEM system	neutral electrode control, optical indication, required resistance < 240 Ω
Dimensions	385 x 305 x 141mm (LxWxH)
Weight	7kg

Accessories



700-350-405
 2-Button-Footswitch, length: 5m

700-350-402
 3-Button-Footswitch, length: 5m, quick access key



Disposable Neutral Electrode
 hydrogel, split, for adults or children
 10x5 pcs. per package
 700-503-000 Adults
 700-503-001 Children



Cable for Disposable Neutral Electrode
 5m, RZ compatible only
 700-503-003

LITHOTRIPTER



Features:

- Pure mechanical energy transmission
- The smallest probe diameter of 0.6mm
- Auxiliary instruments can also be inserted
- Very simple handling and cleaning
- Compatible to other RZ and other instruments for the therapy of ureteric, renal and bladder stones
- Non-conductive hand piece to ensure safety for patients as well as users

253-750-100 L100 Lithotripter



DELIVERY CONTAINS:

- Main Unit (253-750-100)
- Operating manual ■ Mains cable

Technical data

Line voltage	115-230 VAC	Dimensions	254 x 113 x 305mm (WxHxD)
Pneumatic power source	3.5 – 6.5 bar, compressed medical air	Weight	6.5kg
Pulse rate control (ppm)	50 – 600 ppm 10 ppm increments between 50 - 100 ppm 50 ppm increments between 100 - 600 ppm		

Accessories



Litho Probe, 605mm working length

253-850-006	0.6mm	253-850-016	1.6mm
253-850-008	0.8mm	253-850-020	2.0mm, 450mm length
253-850-010	1.0mm	253-850-025	2.5mm, 450mm length



253-750-150
Footswitch



253-750-200
Hand piece, anodised



253-750-010
Air compressor, 4 bar maximum

L100 Lithotripter Modular System Chart

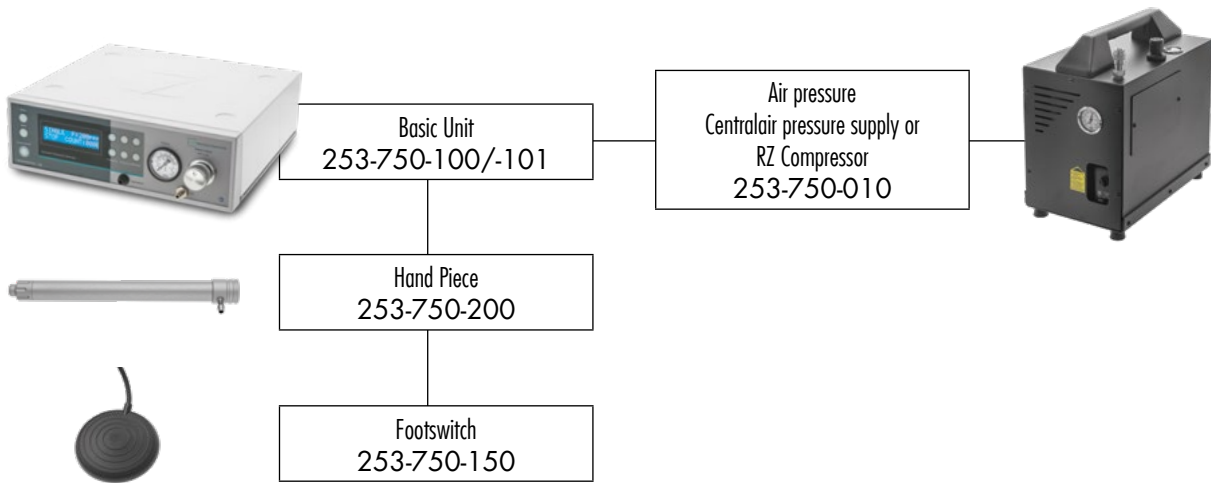

Handpiece + RZ Probes

Telescope + Sheaths

Auxillary Instruments

URETEROSCOPY

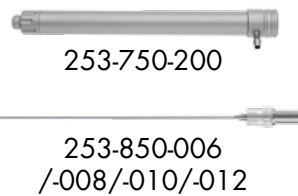
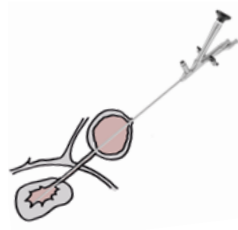

CYSTOSCOPY

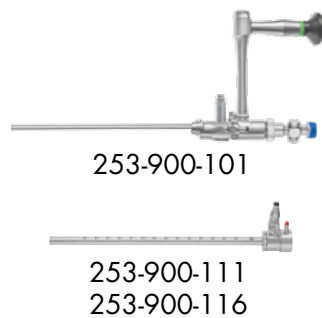
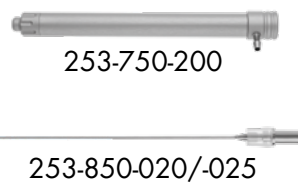
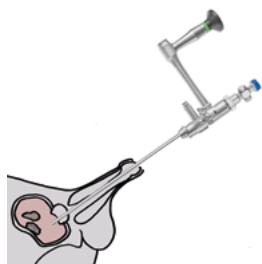

PERCUTANEOUS NEPHROSCOPY

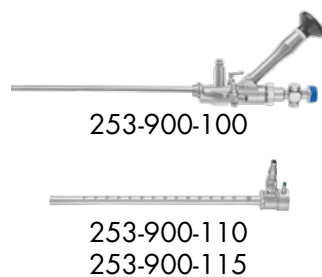
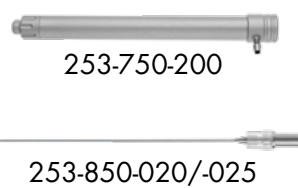



300-001-168
Endovue 32" HD Monitor

300-001-158
Endovue 24" HD Monitor

Technical data

Screen size	31.5" / 24" diagonal
Resolution	1920 x 1080
Aspect ratio	16:9
Viewing angle	178°
Numbers of colors	16.7 Million (8-bit)
Video Inputs	DVI-D, RGBS/VGA/YPbPr (HD-15 or DVI-I via adapter), S-Video, Composite
Video Outputs	DVI-D
Weight	8.8kg (300-001-168) 6.7kg (300-001-158)



300-001-232
Radiance 32" HD Monitor

300-010-226
Radiance 27" HD Monitor

Technical data

Screen size	32" / 27" diagonal
Resolution	1920 x 1080
Aspect ratio	16:9
Viewing angle	178°
Numbers of colors	1.07 Billion (10-bit)
Video Inputs	DVI-I and 3G-SDI Input/Output
Video Outputs	DVI-D
Weight	11.0kg (300-001-232) 8.9kg (300-010-226)



300-001-031
UHD 4K Monitor, 31"

Technical data

Screen size	31" diagonal
Resolution	4096 x 2160
Aspect ratio	17:9
Viewing angle	178°
Number of colors	1.08 Billion (10-bit)
Video Inputs	1 x HDMI 2.0 1 x DP 1.2 (SST) & 1 x DP 1.2 (MST) 1 x DVI (single link), 4 x SDI (3G)
Video Outputs	1 x DP 1.2 (SST) 1 x DVI (single link), 4 x SDI (3G)
Weight	10.5kg



300-001-055
UHD 4K Monitor, 55"

Technical data

Screen size	55" diagonal
Resolution	3840 x 2160
Aspect ratio	16:9
Viewing angle	178°
Numbers of colors	1.08 Billion (10-bit)
Video Inputs	1 x HDMI 2.0, 2 x DP 1.2 (55T) 1 x DVI (single link), 2 x DVI (dual link) 4 x SOi (3G), 2 x SOi (12G)
Video Outputs	1 x DVI (single link), 1 x DP 1.2 (SST) 4 x SDI (3G), 2x SDI (12G)
Weight	37.35kg



300-001-028
Monitor Table Stand

Technical data

Column height	305mm, 12"
Oriantations	Landscape or page mode
Adjustments	+/- 20°
Max. load	31" / 13.6kg / 30lbs

All monitors will be delivered without table stand - need to be ordered separately.

RESECTION SIMULATOR / TRAINER

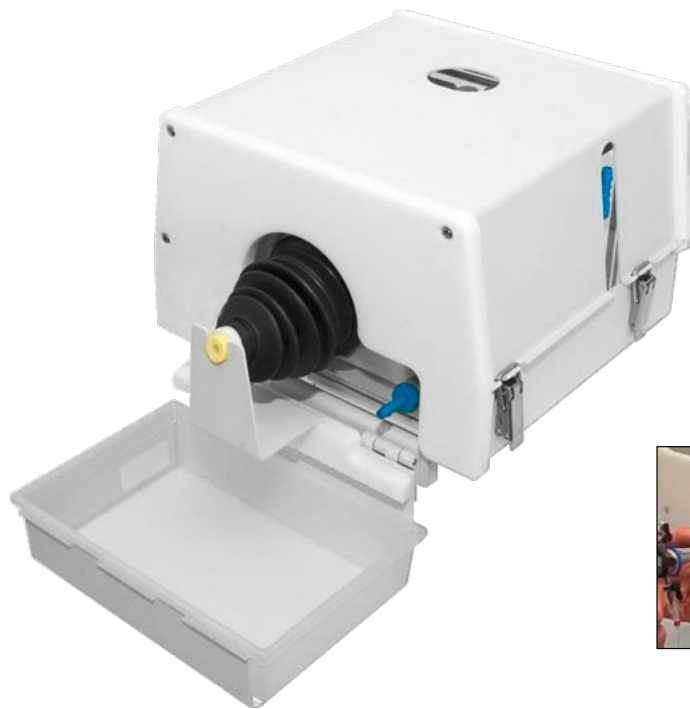

Features:

- Essential hand movements can be learned
- Anatomical substrate can be detected and removed by using the resectoscope
- Usage in workshops, exhibitions or at the customer's location

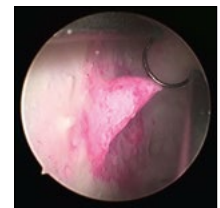
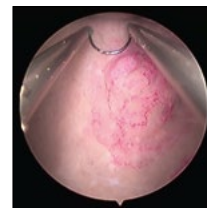

900-253-000 GIUSEPPE Urological Simulator / Trainer, prostate and bladder, incl. pump and accessories, without substrates



Urological Substrate with and without anatomical structures

- Realistic tissue
- Myomas and Polyps structures
- Close to reality environment

	Quantity	Storable
900-253-001 Anatomical structure of the prostate	12	6 months
900-253-002 Anatomical structure of the bladder	6	3 months
900-253-003 Without anatomical structure	12	12 months

250-015-030	136	253-000-219	25	253-000-545	8, 59
250-015-036	136	253-000-220	25	253-000-547	59
250-020-025	136	253-000-222	25	253-000-555	58
250-020-030	136	253-000-225	25	253-000-666	54, 71
250-025-230	139	253-000-250	54	253-000-676	54
250-025-300	139	253-000-251	54, 71	253-000-677	54
250-035-180	139	253-000-256	5, 7, 12, 47, 68,	253-000-678	54
250-035-230	139		69, 70, 74, 77, 86, 87	253-000-724	47
250-035-300	139	253-000-258	86, 87	253-000-850	117
250-037-000	139	253-000-266	47, 69	253-000-900	117
250-038-000	139	253-000-300	68, 69	253-000-901	117
250-039-000	139	253-000-301	10, 11, 69, 70,	253-000-950	2, 5, 13, 117
250-040-000	139		72, 73	253-000-951	117
250-041-000	139	253-000-302	12, 69, 70, 72, 73	253-000-975	117
250-042-000	139	253-000-305	68, 70	253-000-976	117
250-044-000	139	253-000-312	12, 68, 69	253-200-007	104
250-045-000	139	253-000-316	68, 72	253-200-009	104
250-048-000	139	253-000-318	11, 68, 73	253-200-011	105
250-048-180	139	253-000-319	10, 68, 72	253-200-075	3, 105
250-048-230	139	253-000-320	70	253-200-095	3, 105
250-048-300	139	253-000-321	70	253-200-100	110
250-051-000	139	253-000-322	70	253-200-128	111
250-052-000	139	253-000-323	70	253-200-200	4, 111
250-059-000	139	253-000-330	70	253-200-210	4, 111
253-000-044	48	253-000-331	70	253-200-228	111
253-000-054	48	253-000-332	70	253-200-328	111
253-000-082	72	253-000-333	70	253-200-428	111
253-000-084	5, 48	253-000-350	71	253-200-500	110
253-000-094	7, 48	253-000-352	8, 10, 58, 68, 72	253-200-600	4, 110
253-000-100	26	253-000-356	47, 74, 86, 87	253-202-003	3, 104, 106
253-000-101	26	253-000-358	86, 87	253-203-128	4, 111
253-000-102	2, 26	253-000-362	72	253-203-228	111
253-000-105	2, 26	253-000-366	47	253-203-328	4, 111
253-000-106	26	253-000-400	7, 46	253-203-428	4, 111
253-000-107	26	253-000-401	46	253-204-003	3, 104, 106
253-000-108	26	253-000-410	8, 58	253-204-128	111
253-000-117	25	253-000-411	58	253-204-228	111
253-000-119	25	253-000-501	59	253-204-328	111
253-000-120	25	253-000-502	59	253-204-428	111
253-000-122	25	253-000-503	59	253-219-100	6, 14, 105, 108,
253-000-125	25	253-000-505	59		109
253-000-200	5, 13, 45, 79	253-000-507	59	253-219-130	3, 105, 108, 109
253-000-201	45	253-000-524	47	253-220-011	106
253-000-210	57	253-000-541	8, 59	253-220-014	106
253-000-211	57	253-000-542	59	253-220-025	106
253-000-217	25	253-000-543	8, 59	253-220-030	106

253-221-000	104	253-300-222	49	253-333-335	120
253-221-030	104	253-300-251	55	253-334-225	121
253-227-000	106	253-300-252	55	253-334-335	120
253-227-030	106	253-300-253	55	253-335-225	121
253-227-070	106	253-300-255	55	253-335-335	120
253-250-200	6, 14, 108, 109	253-300-256	55	253-336-225	121
253-250-211	6, 108	253-300-258	55	253-336-335	120
253-250-213	108	253-300-259	55	253-337-225	121
253-251-111	6, 108	253-300-999	5, 7, 8, 9, 13, 80	253-337-335	120
253-251-112	6, 108	253-310-014	107	253-340-335	120
253-251-113	6, 108	253-310-015	107	253-341-335	120
253-251-114	108	253-310-100	107	253-342-335	120
253-251-115	6, 108	253-310-101	107	253-343-335	120
253-252-111	108	253-310-107	107	253-344-335	120
253-252-112	108	253-310-390	119	253-345-335	120
253-252-113	108	253-310-391	119	253-346-335	120
253-252-114	108	253-310-392	119	253-347-335	120
253-252-115	108	253-310-393	119	253-348-335	120
253-255-001	14, 109	253-315-000	25	253-349-335	120
253-265-010	14, 109	253-320-225	121	253-350-335	120
253-265-101	14, 109	253-320-335	120	253-351-335	120
253-265-102	14, 109	253-321-225	121	253-352-335	120
253-265-103	109	253-321-335	120	253-353-335	120
253-265-104	14, 109	253-322-225	121	253-354-335	120
253-300-017	2, 24	253-322-335	120	253-355-335	120
253-300-019	24	253-323-225	121	253-356-335	120
253-300-020	24	253-323-335	120	253-357-335	120
253-300-022	2, 24	253-324-225	121	253-370-003	37, 111
253-300-025	19, 24, 86	253-324-335	120	253-370-004	111
253-300-201	5, 49, 51	253-325-225	121	253-370-005	2, 37, 111
253-300-202	49	253-325-335	120	253-370-007	2, 37
253-300-203	5, 49, 51	253-326-225	121	253-370-009	121
253-300-204	49	253-326-335	120	253-370-010	37
253-300-205	5, 49, 51	253-327-225	121	253-370-021	121
253-300-206	5, 49, 51	253-327-335	120	253-370-103	37
253-300-207	49	253-328-225	121	253-370-253	3, 4, 104, 106
253-300-208	49	253-328-335	120	253-371-003	37, 111
253-300-209	50	253-329-225	121	253-371-005	37, 111
253-300-210	50	253-329-335	120	253-371-007	37
253-300-211	50	253-330-225	121	253-371-253	3, 4, 104, 106
253-300-212	50	253-330-335	120	253-372-005	37
253-300-213	50	253-331-225	121	253-372-007	37
253-300-214	50	253-331-335	120	253-375-015	121
253-300-215	50	253-332-225	121	253-400-200	52
253-300-218	50	253-332-335	120	253-400-201	7, 52
253-300-219	50	253-333-225	121	253-400-202	52

253-400-203	7, 52	253-500-229	79	253-755-030	19, 84
253-400-204	52	253-500-230	13, 79	253-755-040	84
253-400-205	7, 52	253-500-315	81	253-755-500	85
253-400-206	52	253-500-321	13, 79	253-760-000	19, 86
253-400-211	52	253-500-325	13, 79	253-780-000	87
253-400-222	52	253-500-421	79	253-800-000	114
253-400-501	64	253-500-500	81	253-800-900	115
253-400-502	64	253-500-561	13, 80	253-804-000	13, 19, 23, 44, 68, 79, 84
253-400-503	64	253-500-562	80	253-804-012	23, 44, 68, 69, 70, 76, 77
253-400-504	64	253-500-563	13, 80	253-804-030	2, 5, 7, 12, 19, 23, 44, 68, 69, 70, 76, 77, 85, 86, 87
253-400-505	64	253-500-564	13, 80	253-804-070	23, 85
253-400-506	64	253-500-581	81	253-804-400	22
253-400-508	64	253-500-582	81	253-804-412	22
253-400-601	63, 112	253-580-007	36	253-804-430	22
253-400-602	63, 112	253-581-007	36	253-804-470	22
253-400-606	63, 112	253-581-045	35	253-804-530	54, 71
253-400-701	53	253-582-045	35	253-829-000	81, 107
253-400-702	53	253-582-055	35	253-829-012	72, 73
253-400-703	53	253-582-065	35	253-829-030	9, 72, 73, 107
253-400-704	53	253-584-005	36	253-850-006	20, 142, 143
253-420-100	2, 34	253-585-005	2, 15, 35, 102	253-850-008	20, 142
253-421-100	34	253-610-001	37, 63, 112	253-850-010	20, 142
253-422-100	34	253-610-002	37, 63, 112	253-850-012	20
253-423-100	34	253-610-003	2, 3, 5, 6, 37, 63, 112	253-850-016	20, 142
253-425-100	34	253-610-004	37, 63, 112	253-850-020	20, 142, 143
253-426-100	34	253-650-010	120	253-850-025	142
253-427-100	34	253-650-012	120	253-870-023	76
253-428-100	12, 74	253-650-014	120	253-872-000	76
253-428-500	47	253-650-016	120	253-873-000	76
253-429-100	34	253-650-018	120	253-874-000	69, 77
253-430-100	86	253-650-020	120	253-900-000	92
253-431-100	34	253-650-022	120	253-900-010	89, 102
253-500-000	2, 5, 19, 117	253-650-024	120	253-900-100	93, 94, 143
253-500-001	117	253-650-026	120	253-900-101	93, 94, 143
253-500-003	117	253-650-028	120	253-900-105	93, 94
253-500-004	117	253-650-030	120	253-900-110	93, 143
253-500-010	117	253-650-032	120	253-900-111	93, 143
253-500-020	117	253-650-034	120	253-900-115	93, 143
253-500-100	13, 82	253-650-036	120	253-900-116	93, 143
253-500-101	82	253-750-010	142, 143	253-900-120	94
253-500-102	82	253-750-100	20, 142, 143	253-900-121	12, 18, 68, 74, 94
253-500-103	82	253-750-150	20, 142, 143	253-900-130	18, 94
253-500-108	82	253-750-200	20, 142, 143	253-900-131	94
253-500-115	81	253-755-010	19, 84		
253-500-125	81	253-755-020	19, 84		
253-500-221	13, 79				

253-900-135	18, 94	253-900-919	4	253-952-503	31, 100
253-900-136	94	253-900-920	12	253-952-504	31, 100
253-900-140	16, 89	253-900-921	9	253-952-505	31, 100
253-900-141	16, 90	253-900-922	14	253-953-003	31, 100
253-900-142	16, 90	253-900-923	17	253-953-004	31, 100
253-900-143	16, 90	253-900-924	18	253-953-005	31, 100
253-900-145	16, 90	253-900-925	19	253-953-503	31, 100
253-900-146	16, 90	253-900-926	20	253-953-504	31, 100
253-900-147	16, 90	253-901-220	11, 68, 75	253-953-505	31, 100
253-900-148	16, 90	253-904-220	10, 11, 75	253-954-003	31, 101
253-900-150	93	253-905-000	102, 125	253-954-004	31, 101
253-900-151	93	253-905-220	10, 11, 68, 75	253-954-005	15, 31, 101, 143
253-900-155	18, 95	253-905-400	89, 102	253-954-455	91
253-900-156	18, 95	253-905-530	99	253-954-503	31, 101
253-900-157	18, 95	253-905-540	15, 99, 143	253-954-504	31, 101
253-900-160	94	253-910-000	132	253-954-505	31, 101
253-900-161	94	253-910-001	132	253-955-003	31, 101
253-900-171	90	253-910-002	132	253-955-004	31, 101
253-900-173	90	253-910-003	132	253-955-005	31, 101
253-900-175	90	253-910-530	99	253-955-503	31, 101
253-900-200	91, 95	253-910-540	99	253-955-504	31, 101
253-900-201	18, 95	253-915-530	99	253-955-505	31, 101
253-900-202	18, 95	253-915-540	99	253-956-003	31, 101
253-900-205	96, 143	253-920-090	121	253-956-004	31, 101
253-900-206	96	253-920-105	121	253-956-005	15, 31, 101
253-900-210	96, 143	253-920-120	121	253-956-455	16, 17, 91
253-900-211	96	253-920-135	121	253-956-503	31, 101
253-900-212	96	253-920-150	121	253-956-504	31, 101
253-900-213	96	253-940-005	35, 102	253-956-505	31, 101
253-900-245	96	253-950-003	30, 100	253-957-003	31, 101
253-900-246	96	253-950-004	30, 100	253-957-004	31, 101
253-900-250	18, 96	253-950-005	15, 30, 100	253-957-005	31, 101
253-900-251	96	253-950-455	16, 17, 91	253-957-105	27
253-900-252	18, 96	253-950-503	30, 100	253-957-503	31, 101
253-900-253	96	253-950-504	30, 100	253-957-504	31, 101
253-900-815	92	253-950-505	30, 100	253-957-505	31, 101
253-900-830	17, 92	253-951-003	30, 100	253-958-003	32, 101
253-900-888	17, 92	253-951-004	30, 100	253-958-004	32, 101
253-900-900	2	253-951-005	30, 100	253-958-005	32, 101
253-900-901	5	253-951-503	30, 100	253-958-105	27
253-900-902	13	253-951-504	30, 100	253-958-455	91
253-900-903	15	253-951-505	30, 100	253-958-503	32, 101
253-900-905	6	253-952-003	31, 100	253-958-504	32, 101
253-900-909	16	253-952-004	31, 100	253-958-505	32, 101
253-900-911	7	253-952-005	15, 31, 100	253-959-003	32, 101
253-900-918	3	253-952-455	16, 17, 91	253-959-004	32, 101

253-959-005	32, 101	300-900-180	138	351-100-107	27
253-959-503	32, 101	300-900-300	137	351-100-109	27
253-959-504	32, 101	301-701-030	98, 118	351-100-500	30, 100
253-959-505	32, 101	301-701-060	98, 118	351-100-550	32, 100
253-960-025	102	301-701-100	38, 118	351-107-107	27
253-960-360	91	320-603-455	119	351-107-109	27
253-961-102	38	320-720-080	119	351-114-105	27
253-961-103	38	320-720-100	119	351-114-107	2, 27
253-962-003	102	320-720-120	119	351-114-109	27
253-990-800	38	320-720-140	119	351-120-105	27, 80
300-001-028	145	320-720-160	119	351-120-107	2, 27
300-001-031	145	320-720-180	119	351-120-109	27
300-001-055	145	320-720-200	119	351-124-107	27
300-001-158	144	320-720-220	119	351-400-200	9, 61
300-001-168	144	320-720-240	119	351-400-201	61
300-001-232	144	320-721-080	119	351-829-000	56, 60, 68
300-001-600	135	320-721-100	119	351-829-012	56, 60, 68
300-001-601	135	320-721-120	119	351-829-030	8, 10, 11, 56, 60,
300-001-602	135	320-721-140	119		68
300-001-610	133, 134, 135	320-721-160	119	351-905-105	118
300-001-615	133, 134, 135	320-721-180	119	600-050-000	130
300-001-800	134	320-721-200	119	600-100-000	130
300-001-802	134	320-721-220	119	600-255-500	129
300-001-804	134	320-721-240	119	600-255-530	129
300-001-813	136	320-723-080	119	600-255-535	129
300-001-814	136	320-723-100	119	600-255-550	129
300-001-815	136	320-723-120	119	600-255-555	129
300-001-823	136	320-723-140	119	600-255-565	129
300-001-824	136	320-723-160	119	600-255-575	129
300-001-825	136	320-723-180	119	600-255-600	129
300-001-840	133	320-723-200	119	600-255-605	129
300-001-841	133	320-723-220	119	600-281-001	129
300-010-226	144	320-723-240	119	600-281-002	128
300-011-178	118	320-998-000	121	600-281-003	127
300-011-179	118	320-999-000	121	600-281-004	127
300-011-181	118	351-000-155	61	600-292-052	125
300-011-184	10, 11, 12, 69,	351-000-180	9, 61	600-405-500	128
	70, 72, 73, 118	351-000-185	9, 11, 61, 68, 73	600-405-530	128
300-011-506	118	351-000-186	61	600-405-535	128
300-011-515	118	351-000-195	61, 73	600-405-550	128
300-135-905	130	351-000-201	9, 62	600-405-555	128
300-135-910	130	351-000-202	62	600-405-570	128
300-215-000	38, 130	351-000-203	9, 62	600-405-575	128
300-400-900	118	351-000-205	9, 62	600-405-600	128
300-400-901	118	351-000-206	62	600-405-605	128
300-420-065	130	351-100-105	2, 27	600-450-070	125

600-460-055	125	700-503-003	140, 141
600-460-056	125	700-900-160	130
600-462-052	125	700-900-220	130
600-464-229	124	700-900-250	130
600-485-500	127	900-253-000	146
600-485-530	127	900-253-001	146
600-485-535	127	900-253-002	146
600-485-550	127	900-253-003	146
600-485-555	127		
600-485-570	127		
600-485-575	127		
600-485-600	127		
600-485-605	127		
600-501-000	123		
600-501-002	123		
600-505-000	123		
600-505-002	123		
600-506-002	123		
600-508-000	124		
600-511-000	124		
600-540-500	127		
600-540-530	127		
600-540-535	127		
600-540-550	127		
600-540-555	127		
600-540-570	127		
600-540-575	127		
600-540-600	127		
600-540-605	127		
600-600-191	102		
600-605-220	126		
600-605-411	126		
600-662-077	102, 125		
600-662-540	102		
600-950-100	130		
660-166-100	130		
700-340-400	141		
700-340-410	141		
700-350-400	140		
700-350-402	140, 141		
700-350-405	140, 141		
700-350-410	140		
700-500-453	7, 8, 9, 63, 112		
700-501-453	37, 63, 112		
700-503-000	140, 141		
700-503-001	140, 141		

