

## INDEX

Sets & Retractors	1 - 12
Laparoscopes	13 - 18
Advanced Trocar Systems	19 - 32
Suction & Irrigation	33 - 44
Ring Handle Instruments	45 - 88
Clip Applying, Bulldog Clamps, Needle Holders	89 - 116
Bipolar Instruments	117 - 126
Bariatric Instruments	127 - 136
Pediatric & Mini Instruments	137 - 150
Container & Cleaning	151 - 164
Equipment	165 - 183



### CONFIGURATIONS by RZ

Recommended configuration indicates a non-binding product combination recommendation for guidance only and is not intended to be understood as a system or procedure pack under the (EU) 2017/745.



Products marked with this symbol are not available with RZ-marking, and not the CE sign/CE number of RZ.



#### RZ-Topseller products

All products marked with this green star are available on stock.



# CONTAINER SETS

## Small Incision, fast recovery.

Innovations in high-precision instrumentation or high class optical scopes we offer a broad spectrum of laparoscopic instruments and devices for your minimal invasive surgeries.

We work hand-in-hand with clinical partners and produce under high quality standards in Germany which makes our instrument your choice for minimally invasive surgery.

Our portfolio includes instruments and trocars as well as different specialties, endoscopes and advanced energy solutions. Together with our clinical partners we have defined a complete Laparoscopic Set which fulfill the requirements for minimal invasive surgery from the first cut till the last stitch.

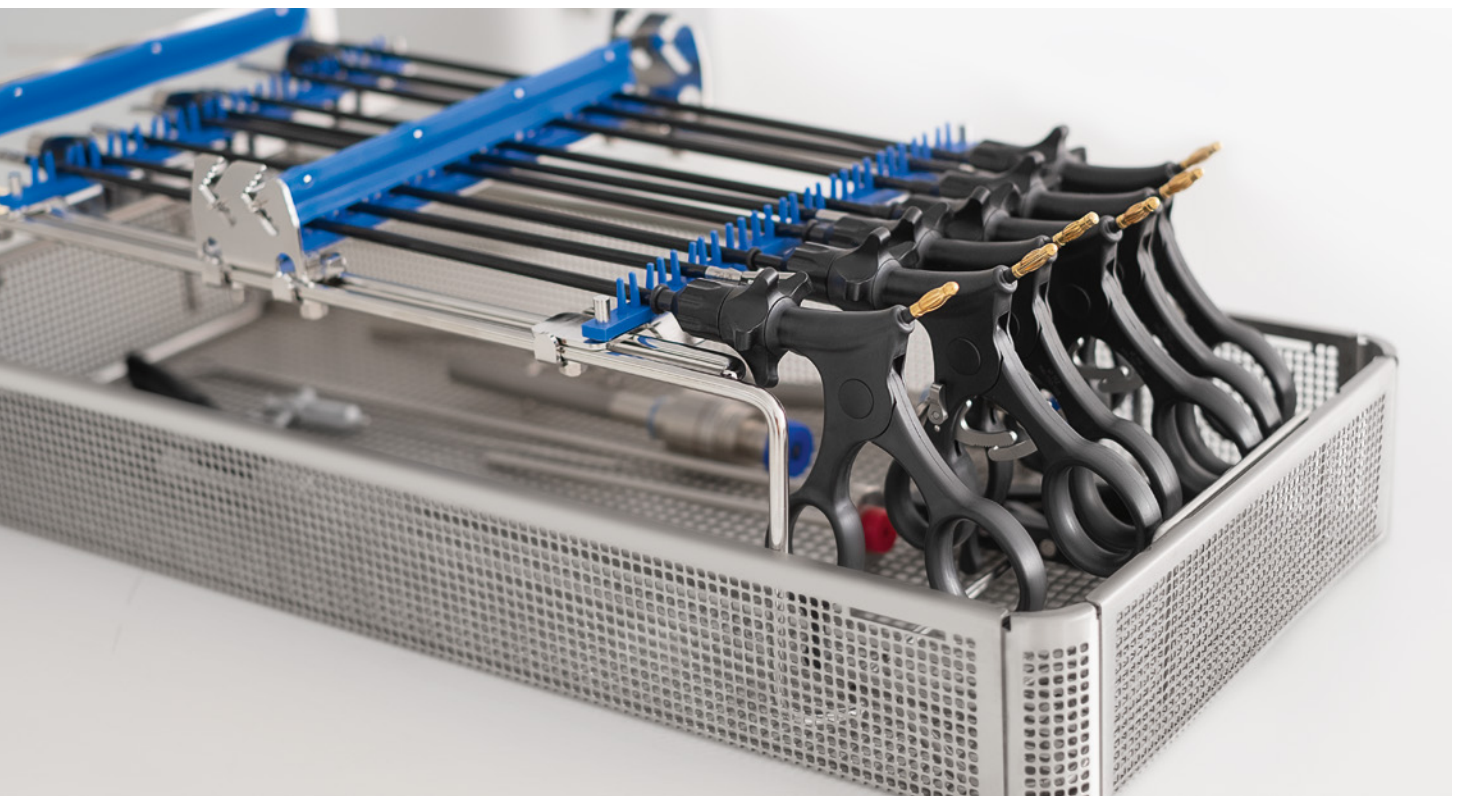

# CONTAINER SET #1

Grasping and Dissecting Forceps, Needle Holders, Scissors, Trocars and other specialities makes the first Container fully equipped with the instruments you need.

Open the tray and start working without missing your favorite instrument.



300-900-902 (Set #1 + Set #2)

# CONTAINER SET #2







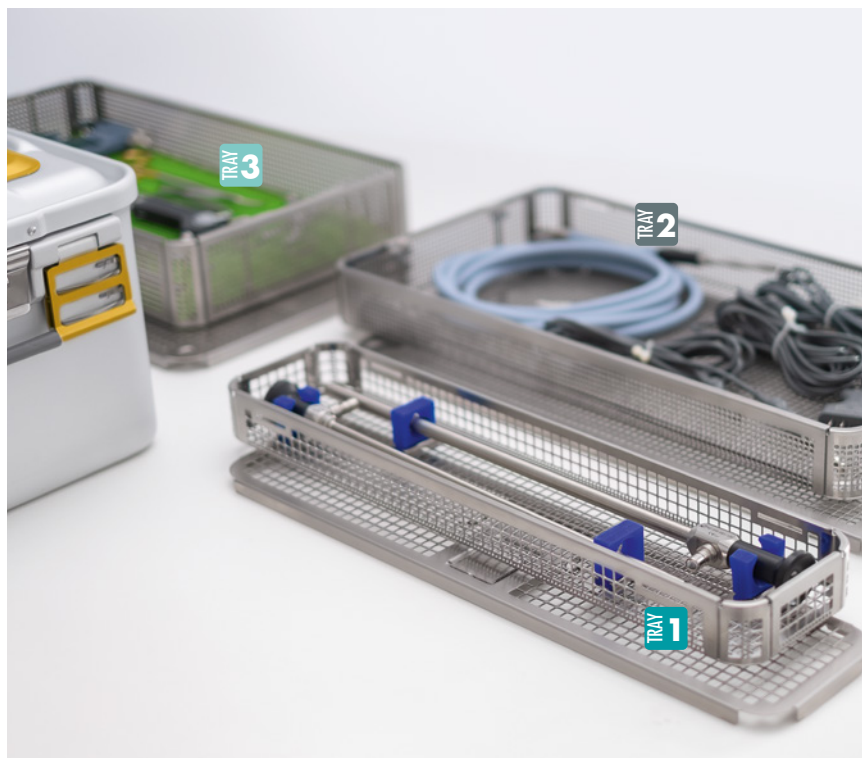





The second container includes high class scopes, instruments, monopolar and bipolar solutions and many accessories.





















Everything stored in trays for easy cleaning and reprocessing.

Your CSSD department will like it.





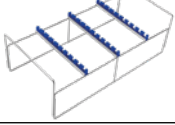







CONTAINER  
SET #1

	Reducer Sleeve $\varnothing$ 10 - 5mm, 190mm	300-012-455	1 pc.
	Reducer Sleeve $\varnothing$ 5 - 4mm, 175mm, red	300-012-405	1 pc.
	Reducer Clip, for all modular trocar sleeves, 11.0 / 5.5mm	300-021-011	1 pc.
	Veress Needle, $\varnothing$ 2mm, 120mm chrome, matt	300-195-120	1 pc.
	Multiport Multifunctional Trocar System $\varnothing$ 11mm, 105mm working length blue metal trocar sleeve, smooth, oblique	300-222-011	2 pcs.
	Multiport Multifunctional Trocar System $\varnothing$ 13mm, 102mm working length green metal trocar sleeve, smooth, oblique	300-222-013	1 pc.
	Multiport Multifunctional Trocar System $\varnothing$ 5.5mm, 103mm working length white metal trocar sleeve, smooth, oblique	300-222-055	3 pcs.
	Trocar, $\varnothing$ 11mm, pyramidal tip for 300-22X-011 & 300-23X-011	300-241-011	1 pc.
	Trocar, $\varnothing$ 13mm, triangular, for 300-22X-013 & 300-23X-013	300-241-013	1 pc.
	Trocar, $\varnothing$ 5.5mm, triangular, for 300-22X-055 & 300-23X-055	300-241-055	1 pc.
	Dick III Lightweight Needle Holder, TC, $\varnothing$ 5mm, straight handle, 330mm working length, left curved jaw	300-300-140	1 pc.
	Dick III Lightweight Needle Holder, TC, $\varnothing$ 5mm, straight handle, 330mm working length, right curved jaw	300-300-141	1 pc.



















		Bullnose Grasping Forceps, heavy insert, deep serrated, double action Ø 5mm, 330mm working length, complete*	300-460-001	1 pc.
		Martin Grasping Forceps, multiple serrated, 4.8mm wide, single action Ø 5mm, 330mm working length, complete*	300-460-011	1 pc.
		Gripper #1 Grasping Forceps, fenestrated coarse serrated, double action Ø 5mm, 330mm working length, complete*	300-460-017	1 pc.
		Hook Scissors, round cutting blade, single action Ø 5mm, 330mm working length, complete*	300-420-060	1 pc.
		Metzenbaum Scissors, slightly curved 12mm short blade, double action Ø 5mm, 330mm working length, complete*	300-420-067	1 pc.
		Johans Grasping Forceps, 20mm fenestrated, double action Ø 5mm, 330mm working length, complete*	300-470-289	1 pc.
		Kelly Dissecting Forceps, cross-serrated slightly tapered, double action Ø 5mm, 330mm working length, complete*	300-420-732	1 pc.
		Dissecting & Grasping Forceps, right angled fine serrated, double action Ø 5mm, 330mm working length, complete*	300-420-735	1 pc.
		Articulating Triangular Retractor, straight, 60mm width, 330mm working length	300-069-000	1 pc.
		1/1 Sterilization Container, safety model, bottom non-perforated, yellow lid 580 x 280 x 200mm	600-580-205	1 pc.
		1/1 Stainless Steel Tray, perforated, 540 x 253 x 47mm	600-540-550	1 pc.
		Storage rack for MIS instruments 485 x 235 x 160mm	600-513-003	1 pc.
		* complete MIC Instrument, consists of insert, handle and shaft		

### CONTAINER SET #2

	TRAY 1	Laparoscope, 0°, Ø 10mm, 330mm working length	300-091-100	1 pc.
	TRAY 1	Laparoscope, 30°, Ø 5mm, 302mm working length	300-092-130	1 pc.
	TRAY 2	Monopolar Electrode, ceramic tip Ø 5mm, 360mm, spatula shaped	300-144-002	1 pc.
	TRAY 2	Monopolar Electrode, ceramic tip Ø 5mm, 360mm, L-Hook	300-144-005	1 pc.
	TRAY 3	RZ Power Handle Bipolar Forceps, Ø 5mm, detachable, flat plug	300-860-134	1 pc.
	TRAY 3	Powergrip Bipolar Grasping Forceps Ø 5mm, 340mm	300-860-013	1 pc.
	TRAY 3	Powergrip Bipolar TC Metzenbaum Scissors Ø 5mm, 340mm	300-860-018	1 pc.
	TRAY 3	Powergrip Bipolar Maryland Forceps Ø 5mm, 340mm	300-860-019	1 pc.
	TRAY 2	HF Cable, monopolar Valleylab/Lamiday/EMC, 3m	700-360-031	3 pcs.
	TRAY 2	HF Cable, bipolar RZ/Valleylab/ Lamiday/EMC, 3m	700-351-131	1 pc.
	TRAY 2	Fibre Optic Light Guide Cable, Ø 4.8mm, 230cm	250-048-230	1 pc.

		Adapter for fibre optic light guide RZ/Storz (unit)	250-039-000	1 pc.
		Adapter for fibre optic light guide RZ/Storz (endoscope)	250-042-000	1 pc.
		Knot Pusher with slit and eye, Ø 4mm, 330mm	300-030-001	1 pc.
		Tobias Fascia Needle Holder, spring handle 2mm tip, 150mm	300-151-000	1 pc.
		Suction/Irrigation Pistol Handle, 2-way-valve, 2x universal tube connector	300-166-100	1 pc.
		Suction/Irrigation Tube Ø 5mm, 4x4 holes, 340mm working length	300-173-005	1 pc.
		Suction/Irrigation Tube Ø 10mm, 4x4 holes, 340mm working length	300-173-010	1 pc.
		Palpation Probe, graduated Ø 5mm, 330mm working length	300-193-335	1 pc.
		Puncture and Injection Tube Ø 1.4mm tip, 20mm tip, Ø 5mm, 330mm working length	300-194-314	1 pc.
		Scalpel Handle No. 3, 130mm	110-110-003	1 pc.
		TC Metzenbaum Scissors, Fig. 1 curved, blunt/blunt, 145mm	120-511-145	1 pc.
		Adson Tissue Forceps, 1x2 teeth, 120mm	130-140-120	1 pc.

### CONTAINER SET #2

		Halsted-Mosquito Hemostatic Forceps, straight, 125mm	140-254-125	2 pcs.
		TC Ligature Scissors, curved, serrated, 180mm	120-611-180	1 pc.
		Backhaus Towel Forceps, 130mm	140-573-130	4 pcs.
		Foerster Swab Forceps, straight, smooth jaw, 180mm	150-050-180	2 pcs.
		TC Mayo Hegar Needle Holder, straight, serrated, 160mm	180-550-160	1 pc.
		1/1 Sterilization Container, safety model, bottom non-perforated, yellow lid 580 x 280 x 200mm	600-580-205	1 pc.
		1/1 Stainless Steel Tray, perforated, 540 x 254 x 35mm	600-540-535	1 pc.
		1/1 Stainless Steel Tray, perforated, 540 x 254 x 55mm	600-540-555	1 pc.
		Silicone Mat, green 440 x 230mm	600-281-003	1 pc.
		Tray for 2 Endoscopes until 340mm	600-460-056	1 pc.

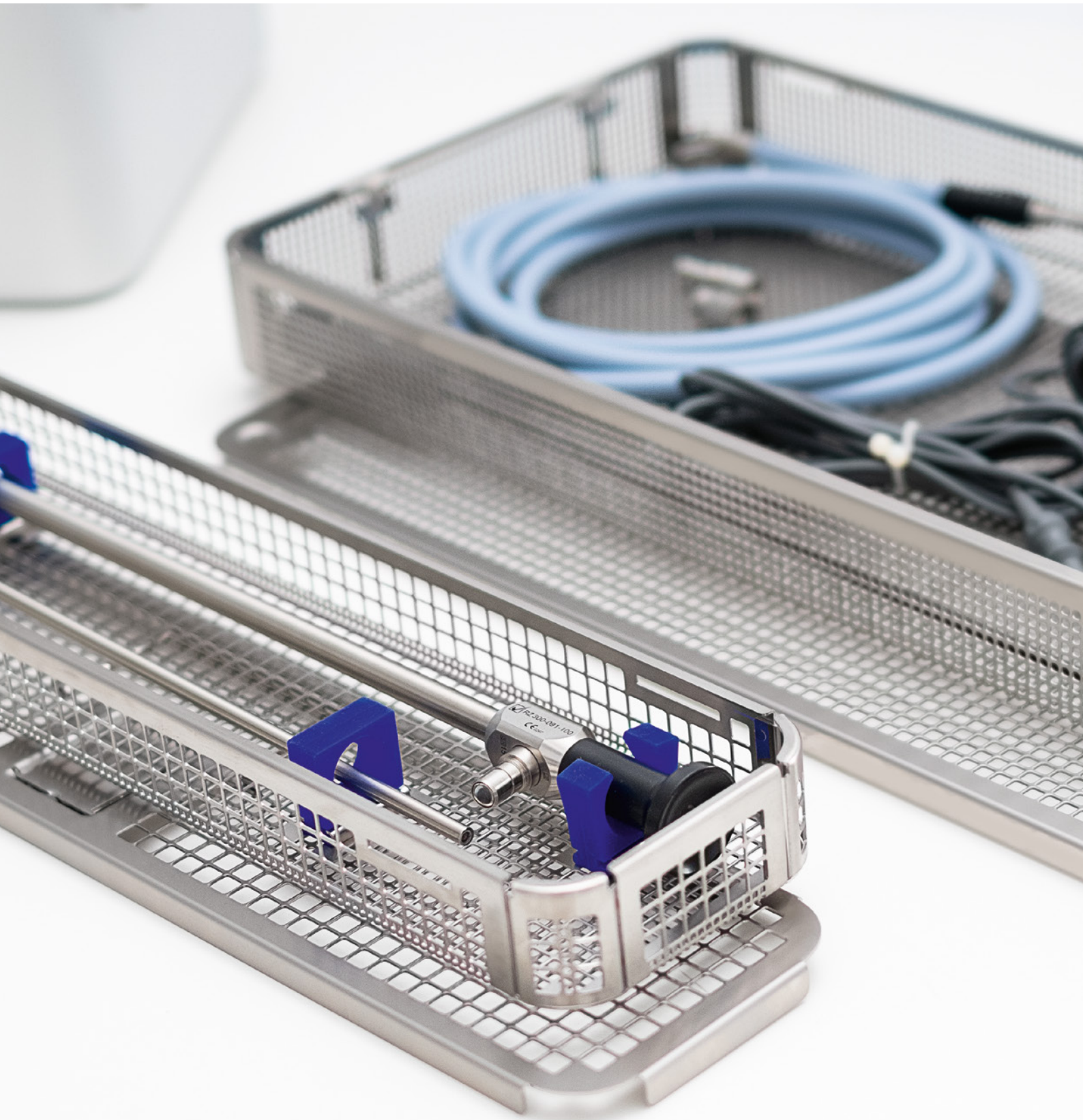

All you need in two containers  
stored in different trays.

## NATHANSON LIVER RETRACTOR SET

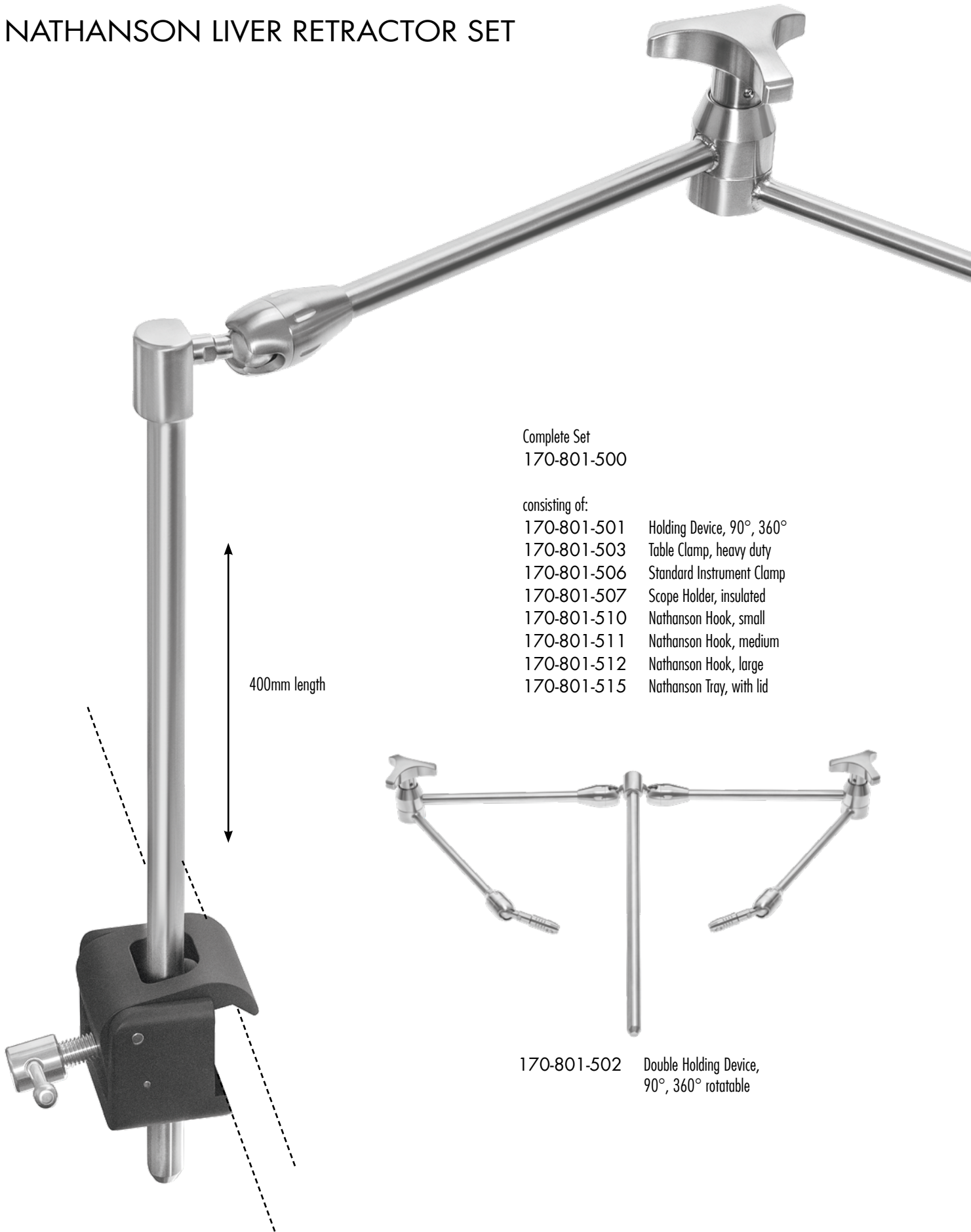

Complete Set  
170-801-500

consisting of:

- 170-801-501 Holding Device, 90°, 360°
- 170-801-503 Table Clamp, heavy duty
- 170-801-506 Standard Instrument Clamp
- 170-801-507 Scope Holder, insulated
- 170-801-510 Nathanson Hook, small
- 170-801-511 Nathanson Hook, medium
- 170-801-512 Nathanson Hook, large
- 170-801-515 Nathanson Tray, with lid

400mm length

170-801-502 Double Holding Device,  
90°, 360° rotatable

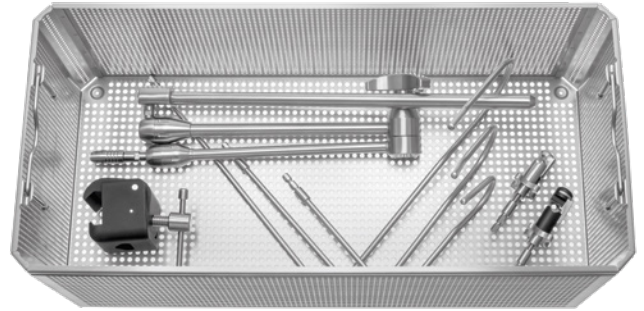

170-801-515  
Tray, with lid, 540 x 253 x 197mm



Quick lock mechanism



Hook,  $\varnothing$  6.5mm  
170-801-510 Small  
170-801-511 Medium  
170-801-512 Large

Hook,  $\varnothing$  3.0mm  
170-802-520 Small  
170-802-521 Medium  
170-802-522 Large

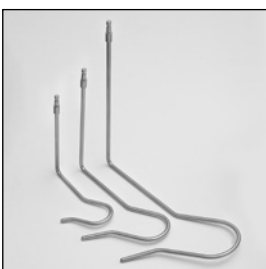



170-801-503 Table Clamp, heavy duty

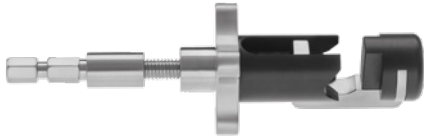

170-801-507 Scope Holder, insulated



170-801-506 Standard Instrument Clamp

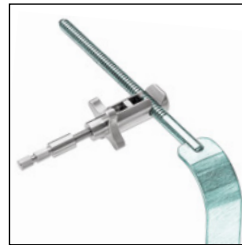

170-801-504 Universal Retractor Holder

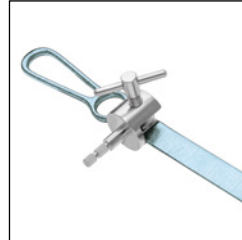

170-801-505 Frame Clamp for Retractor Frames

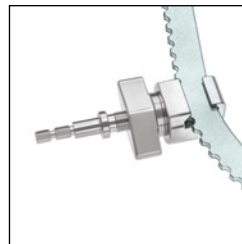

170-801-508 Ratchet mechanism



# LAPAROSCOPES



## 4K LAPAROSCOPES

State-of-the-art Laparoscopes to achieve excellent image quality and finest details in Ultra High Definition.

# 4K

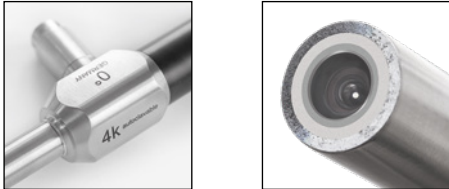

Ø  
10 mm



### 0° DIRECTION OF VIEW

330mm working length	300-100-400*
405mm overall length	
450mm working length	300-200-400
532mm overall length	

### 30° DIRECTION OF VIEW

330mm working length	300-100-430*
405mm overall length	
450mm working length	300-200-430
532mm overall length	



Ø  
5.5mm

### 0° DIRECTION OF VIEW

300mm working length	300-155-400*
356mm overall length	
424mm working length	300-255-400
480mm overall length	

### 30° DIRECTION OF VIEW

300mm working length	300-155-430*
356mm overall length	
424mm working length	300-255-430
480mm overall length	

## ICG/NIR 4K LAPAROSCOPES

Endoscopes for Indocyanine Green (ICG) and Near Infrared (NIR) Laparoscopy procedures in 4K Ultra High Definition.

# 4K



### 0° DIRECTION OF VIEW

330mm working length  
407mm overall length    300-700-400

### 30° DIRECTION OF VIEW

330mm working length  
407mm overall length    300-700-430



### 0° DIRECTION OF VIEW

300mm working length  
359mm overall length    300-755-400

### 30° DIRECTION OF VIEW

300mm working length  
359mm overall length    300-755-430

## FULL HD LAPAROSCOPES

High definition pictures with significant detail-resolution through newest CAD - designed rod - lens systems.

# FULL HD



### 0° DIRECTION OF VIEW

330mm working length  
405mm overall length    300-091-100\*

450mm working length  
532mm overall length    300-091-430



### 30° DIRECTION OF VIEW

330mm working length  
405mm overall length    300-091-130\*

450mm working length  
532mm overall length    300-091-433

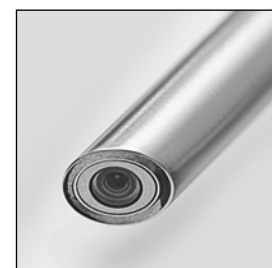

### 45° DIRECTION OF VIEW

330mm working length  
405mm overall length    300-091-145

450mm working length  
532mm overall length    300-091-445

## FULL HD

### FULL HD LAPAROSCOPES

High definition pictures with significant detail-resolution through newest CAD - designed rod - lens systems.

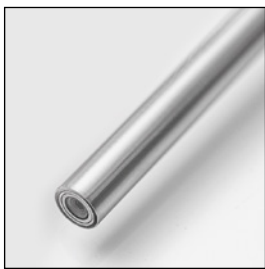

#### 0° DIRECTION OF VIEW

300mm working length 356mm overall length	300-092-100*
424mm working length 480mm overall length	300-096-455



#### 30° DIRECTION OF VIEW

300mm working length 356mm overall length	300-092-130*
424mm working length 480mm overall length	300-096-453



#### 45° DIRECTION OF VIEW

300mm working length 356mm overall length	300-092-145
424mm working length 480mm overall length	300-096-450



#### 0° DIRECTION OF VIEW

207mm working length 270mm overall length	300-097-100
--	-------------



#### 30° DIRECTION OF VIEW

207mm working length 270mm overall length	300-097-130
--	-------------

## FULL HD OPERATING LAPAROSCOPES

For 11 mm trocar systems and single puncture,  
6mm instrument channel

**FULL HD**

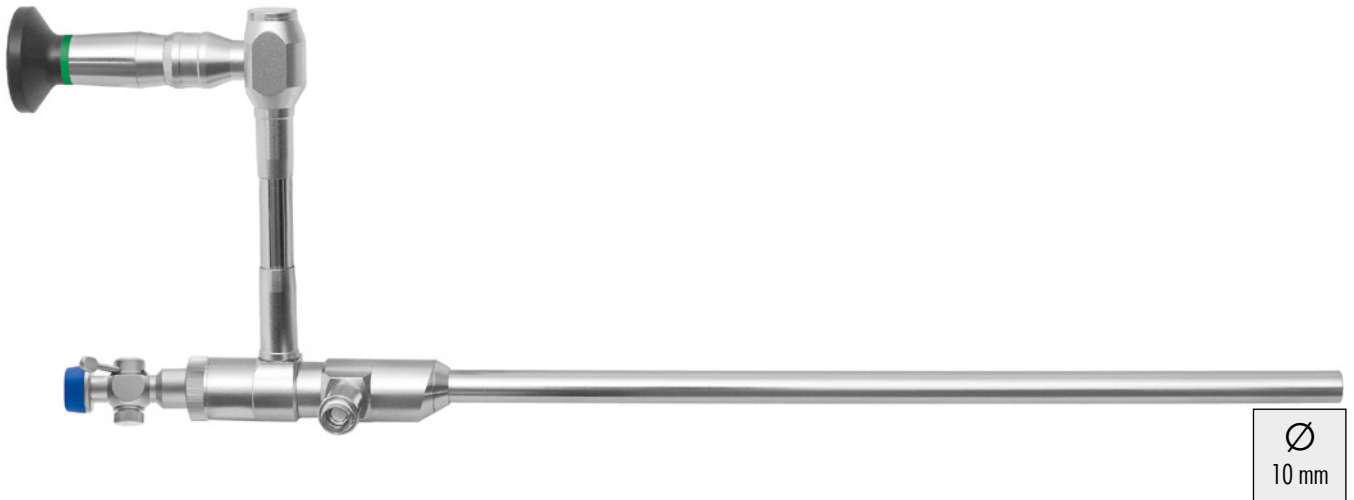

### 0° DIRECTION OF VIEW

Parallel eye piece  
270mm length      300-099-006



Stopcock with 6mm instrument channel  
for 300-099-006      300-099-500



## RECOMMENDATIONS FOR RZ LAPAROSCOPES

- Sterilization Containers and Trays for safe usage and storage:  
pages 157-167
- Ø 3.5mm, Ø 4.8mm light cables and adapter pieces to be used with all RZ Laparoscopes:  
page 179

# ADVANCED TROCAR SYSTEMS

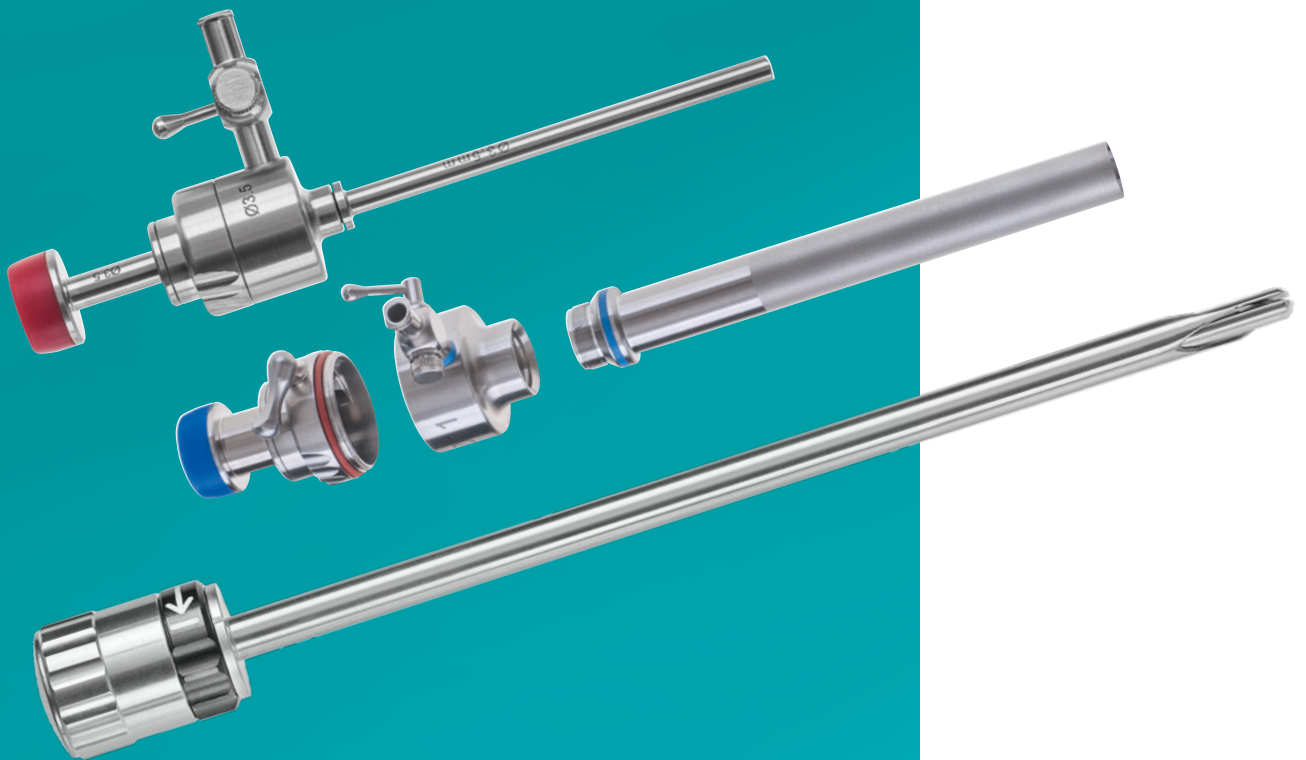

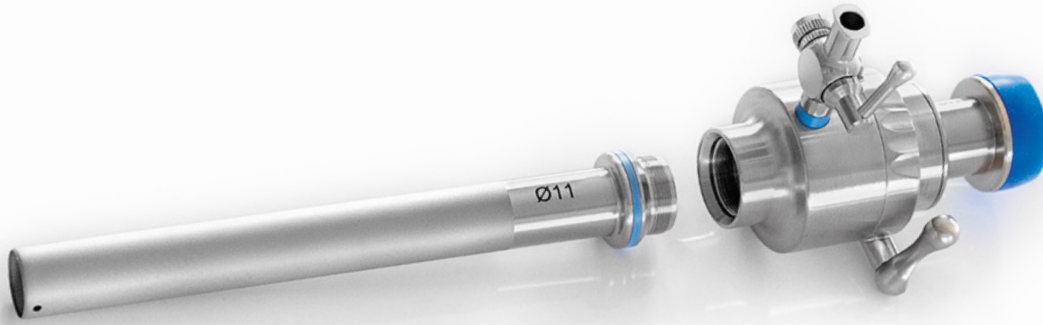

- 1 Reusable and autoclavable seals
- 2 Easy opening by pushing the lever
- 3 Stainless steel stopcock
- 4 Ergonomic stainless steel housing
- 5 Self-centering conical sleeve



Easy opening MultiPort System



Improved trap-door valves

## SILIPORT TROCAR SYSTEM



- 1 Reusable and autoclavable seals
- 2 Reusable and autoclavable silicon valve
- 3 Stainless steel stopcock
- 4 Lightweight synthetic housing
- 5 Self-centering conical sleeve

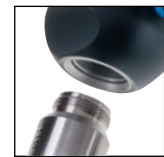

Highest safety due to stainless steel connections

Color code	∅
<span style="display: inline-block; width: 10px; height: 10px; background-color: gray; border-radius: 50%;"></span>	5.5mm
<span style="display: inline-block; width: 10px; height: 10px; background-color: blue; border-radius: 50%;"></span>	11.0mm
<span style="display: inline-block; width: 10px; height: 10px; background-color: green; border-radius: 50%;"></span>	13.0mm

MultiPort Trocar System

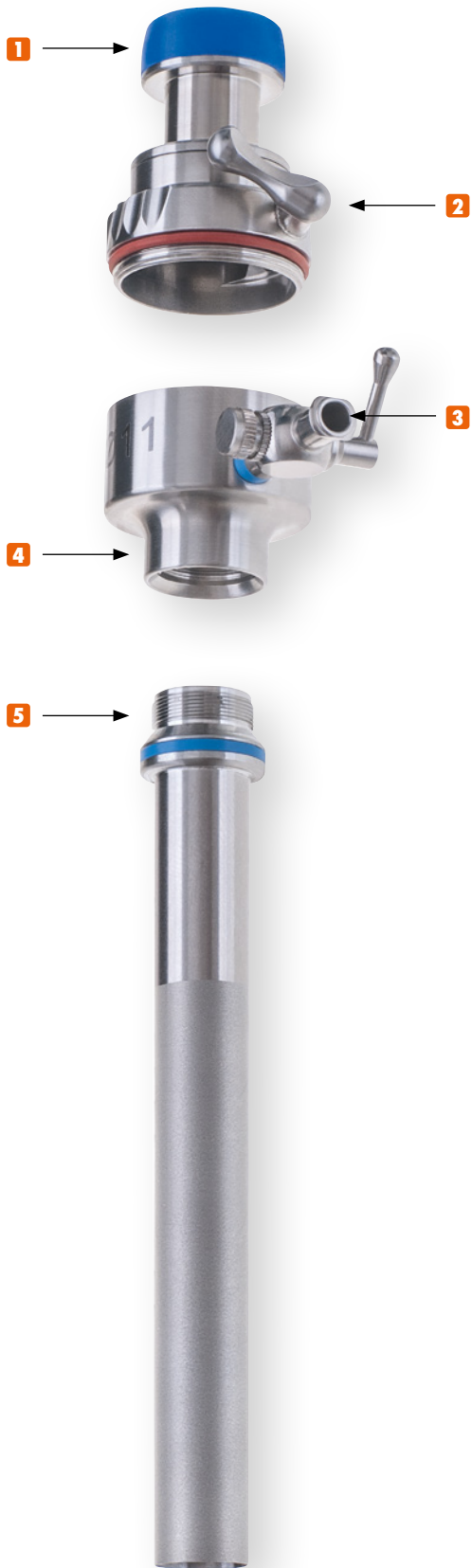

SiliPort Trocar System



Multiport Trocar Sleeves, 100mm working length

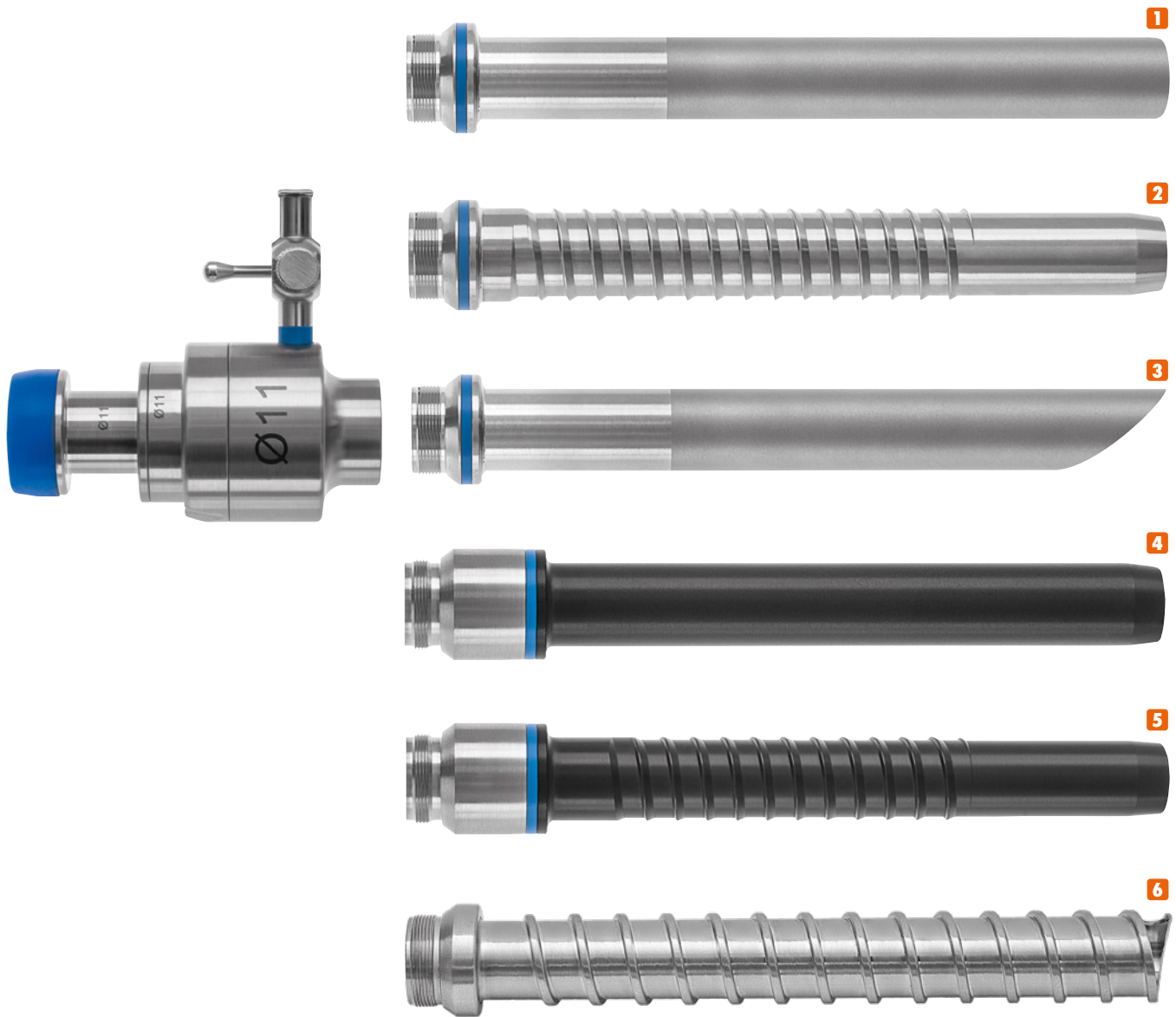

- 1** Stainless steel sleeve, smooth
- 2** Stainless steel sleeve, thread
- 3** Stainless steel sleeve, oblique
- 4** Synthetic sleeve, smooth
- 5** Synthetic sleeve, thread
- 6** Stainless steel sleeve, self-cutting

	Ø 5.5mm	Ø 11mm	Ø 13mm
	300-220-055*	300-220-011*	300-220-013*
	300-221-055	300-221-011	300-221-013
	300-222-055*	300-222-011*	300-222-013*
	300-223-055	300-223-011	300-223-013
	300-224-055	300-224-011	300-224-013
	300-226-055	300-226-011	300-226-013

## Siliport Trocar Sleeves, 100mm working length

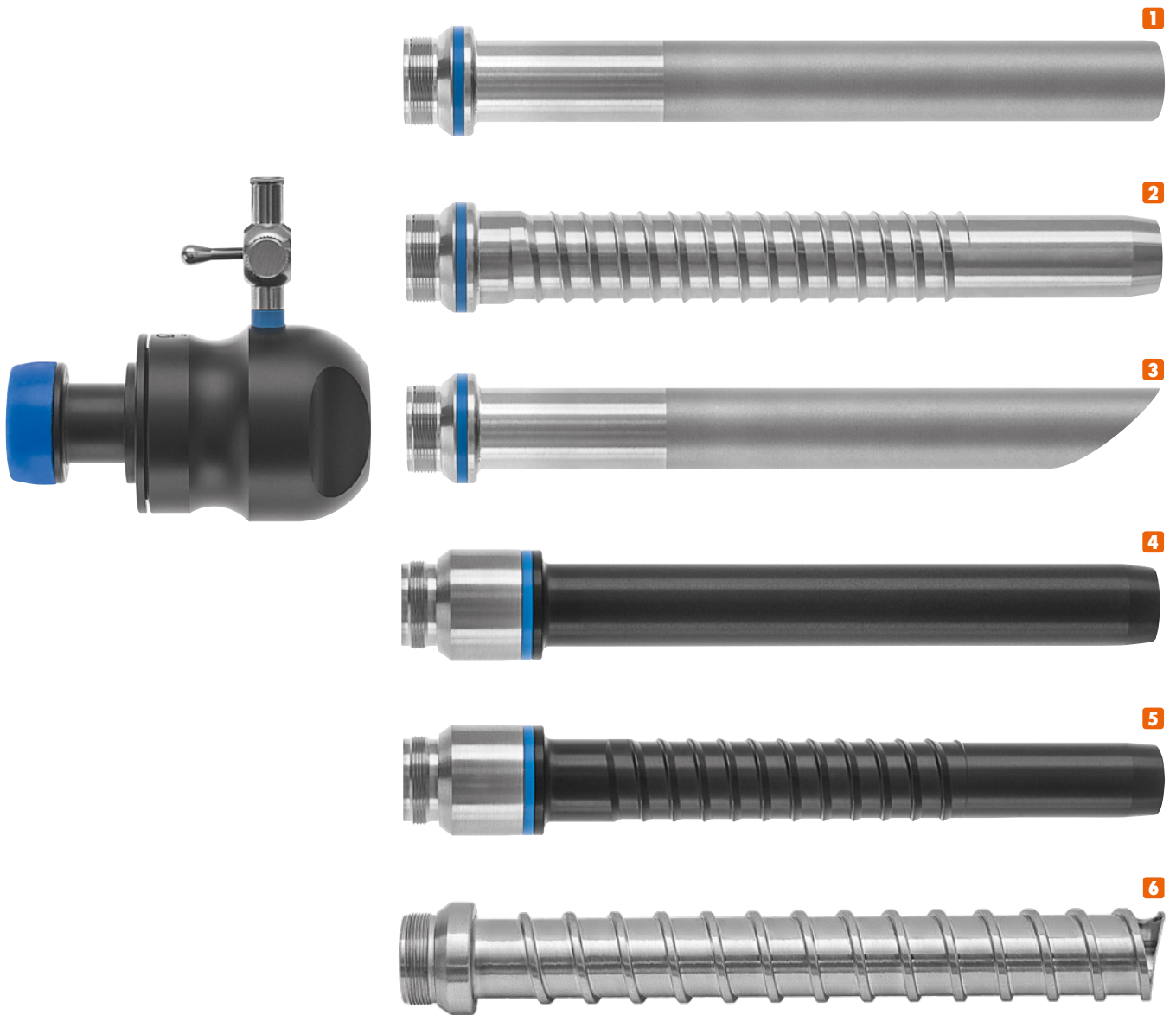

- 1** Stainless steel sleeve, smooth
- 2** Stainless steel sleeve, thread
- 3** Stainless steel sleeve, oblique
- 4** Synthetic sleeve, smooth
- 5** Synthetic sleeve, thread
- 6** Stainless steel sleeve, self-cutting

	Ø 5.5mm	Ø 11mm	Ø 13mm
	300-230-055	300-230-011	300-230-013
	300-231-055	300-231-011	300-231-013
	300-232-055	300-232-011	300-232-013
	300-233-055	300-233-011	300-233-013
	300-234-055	300-234-011	300-234-013
	300-236-055	300-236-011	300-236-013

## SPECIAL SIZED TROCAR SYSTEM



Stainless steel trocar with oblique sleeve, 109.9mm working length  
Ø 15mm 300-020-015

Stainless steel trocar with oblique sleeve, 118.7mm working length  
Ø 20mm 300-020-020

## PEDIATRIC TROCAR SYSTEM



Stainless steel trocar with smooth sleeve, 70mm working length  
Ø 3.5mm 300-112-035

## SPARE TROCAR SLEEVES AND VALVE UNITS

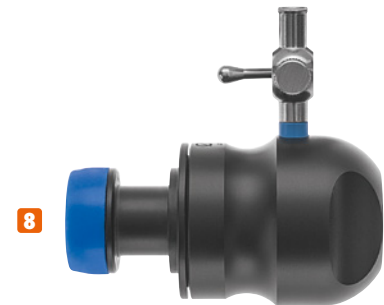

	Ø 5.5mm	Ø 11mm	Ø 13mm
<b>1</b> Stainless steel sleeve, smooth	300-220-255	300-220-211	300-220-213
<b>2</b> Stainless steel sleeve, thread	300-221-255	300-221-211	300-221-213
<b>3</b> Stainless steel sleeve, oblique	300-222-255	300-222-211	300-222-213
<b>4</b> Synthetic sleeve, smooth	300-233-255	300-233-211	300-233-213
<b>5</b> Synthetic sleeve, thread	300-234-255	300-234-211	300-234-213
<b>6</b> Stainless steel sleeve, self-cutting	300-236-255	300-236-211	300-236-213
	Ø 5.5mm	Ø 11mm	Ø 13mm
<b>7</b> MultiPort Valve unit	300-219-055	300-219-011	300-219-013
<b>8</b> SiliPort Valve Unit	300-229-055	300-229-011	300-229-013

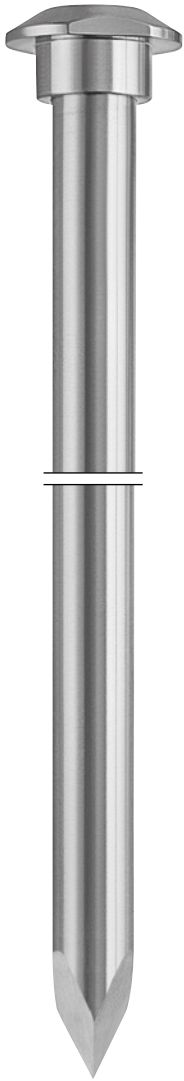

Standard trocar  
with pyramidal tip, reusable, cutting

300-241-035	Ø 3.5mm
300-241-055*	Ø 5.5mm
300-241-011*	Ø 11mm
300-241-013*	Ø 13mm
300-241-015	Ø 15mm
300-241-020	Ø 20mm

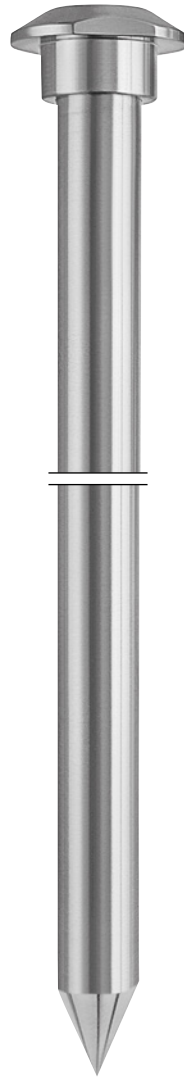

Standard trocar  
with conical tip, reusable, cutting

300-240-035	Ø 3.5mm
300-240-055*	Ø 5.5mm
300-240-011*	Ø 11mm
300-240-013*	Ø 13mm
300-240-015	Ø 15mm
300-240-020	Ø 20mm



Hasson Obturator with blunt ball tip,  
reusable, atraumatic

300-242-035	Ø 3.5mm
300-242-055	Ø 5.5mm
300-242-011	Ø 11mm

### SAFETY TROCARS

- Avoids injuries in the abdomen
- Automatic self-locking shielding
- Shield covers the cutting edges
- Minimal Puncture wound due to rounded cutting edges



300-152-055\* 5.5mm  
 300-152-011\* 11.0 mm  
 300-152-012 12.5mm



Shielded trocar tip



Sharp trocar tip



Safety mechanism

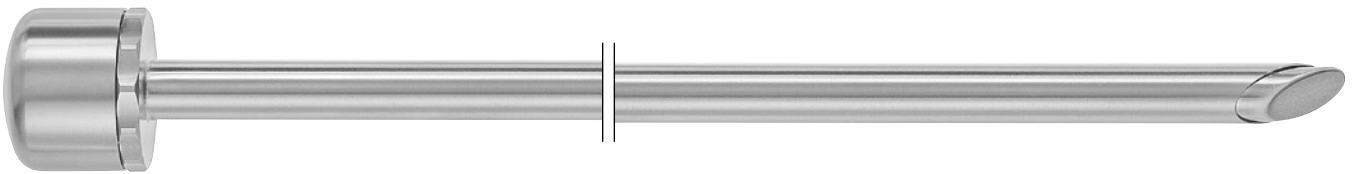

Safety trocar with oblique cutting edge  
 300-154-055 5.5mm  
 300-154-125 12.5mm

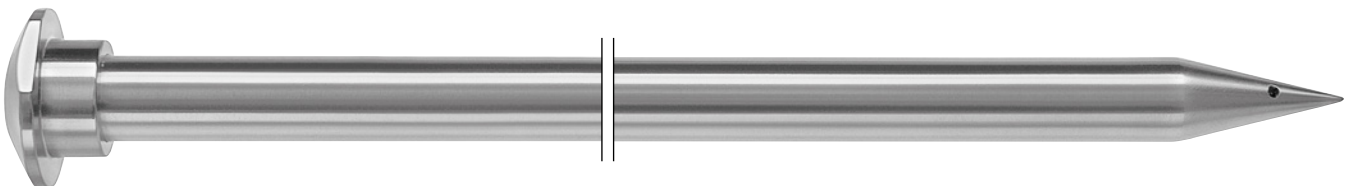

Cannulated trocars with hole, conical tip  
 300-243-055 5.5mm  
 300-243-011 11.0 mm  
 300-243-013 13.0 mm

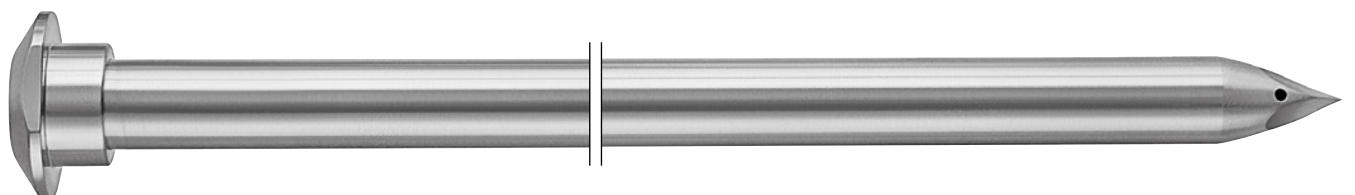

Cannulated trocars with hole, trocar point  
 300-244-055 5.5mm  
 300-244-011 11.0 mm  
 300-244-013 13.0 mm

### SPARE PARTS



**1**  
Silicone seal insert for SiliPort  
Trocar System, 5 pieces  
300-025-358\* Ø 5.5mm  
300-025-359\* Ø 11mm  
300-025-359 Ø 13mm



**2**  
Sealing caps, color-coded, 10 pieces  
300-250-035 Ø 3.5mm (red)  
300-250-055\* Ø 5.5mm (white)  
300-250-011\* Ø 11mm (blue)  
300-250-013\* Ø 13mm (green)  
300-020-915 Ø 15mm (grey)  
300-020-920 Ø 20mm (grey)



**3**  
Gaskets for MultiPort Trocar System, 10 pieces  
300-250-235 Ø 3.5mm (black)  
300-250-255 Ø 5.5mm (white)  
300-250-211 Ø 11mm (blue)  
300-250-213 Ø 13mm (green)  
300-020-215 Ø 15mm (blue)  
300-020-220 Ø 20mm (blue)

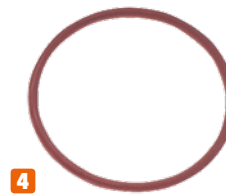

**4**  
Gaskets for MultiPort Trocar System, 10 pieces  
300-250-135 Ø 3.5mm / 5.5mm  
300-250-111 Ø 11mm / 13mm  
300-020-115 Ø 15mm  
300-020-120 Ø 20mm



Reducer clip with silicone band

for all RZ trocar systems

300-021-011\* Ø 11mm ⇒ 5.5mm

300-021-125 Ø 12.5mm ⇒ 5.5mm



Reducer clip with silicone band for

all RZ trocar systems

300-021-355\* Ø 11mm ⇒ 5.5mm

300-021-380 Ø 11mm ⇒ 8.0 mm

300-021-305 Ø 13mm ⇒ 5.5mm

300-021-310 Ø 13mm ⇒ 10.0 mm



Slide-reducer for all RZ Trocar Systems

300-021-455 Ø 11mm ⇒ 5.5mm

300-021-405 Ø 13mm ⇒ 5.5mm

300-021-410 Ø 13mm ⇒ 10.0 mm



Reducer Sleeve short, for all RZ modular trocar systems, 60mm

300-012-106 Ø 10mm ⇒ 5.0 mm

300-012-116 Ø 11mm ⇒ 5.5mm

300-012-121 Ø 12.5mm ⇒ 5.5mm

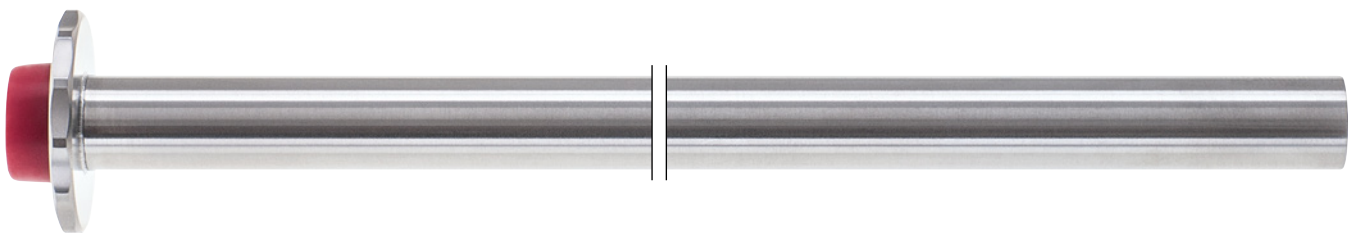

Reducer Sleeve long, for all RZ modular trocar systems, 190mm

300-012-405\* Ø 5.0mm ⇒ 4.0mm (red)\*

300-012-455\* Ø 10.0/11.0mm ⇒ 5.5mm (red)

300-012-410 Ø 12.5mm ⇒ 10.0mm (blue)

300-012-412 Ø 12.5mm ⇒ 5.5mm (red)

300-012-415 Ø 15.0mm ⇒ 10.0mm (blue)

300-012-416 Ø 15.0mm ⇒ 5.5mm (red)

300-012-425 Ø 20.0mm ⇒ 15.0mm (grey)

300-012-420 Ø 20.0mm ⇒ 10.0mm (blue)

300-012-421 Ø 20.0mm ⇒ 5.5mm (red)

\* 175mm



### RZ Dilation Set

- 300-013-500 for 5.5 ⇒ 10.0 mm
- 300-013-511 for 5.5 ⇒ 11.0 mm
- 300-013-510 for 5.5 ⇒ 10.0 mm
- 300-013-115 for 11.0 ⇒ 15.0 mm
- 300-013-512 for 5.5 ⇒ 12.5mm
- 300-013-522 for 11.0 ⇒ 20.0 mm

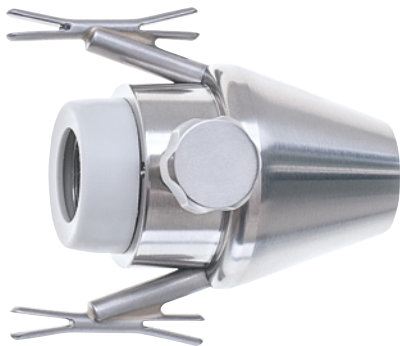

Fixable sliding Hasson Cone with suture fixation device, for all RZ Modular Trocar Systems with smooth metal sleeves

- 300-014-155 Ø 5.5mm
- 300-014-111 Ø 11mm
- 300-014-113 Ø 13mm



Fixable sliding Hasson cone with suture fixation device, for all RZ Modular Trocar Systems with smooth metal sleeves

- 300-014-711 Ø 11mm

### FLEXIBLE TROCAR SYSTEM FOR THE USE OF CURVED INSTRUMENTS

- Complete Thorax trocar system
- For inserting curved or strongly curved jaws
- For 5mm and 10mm instruments

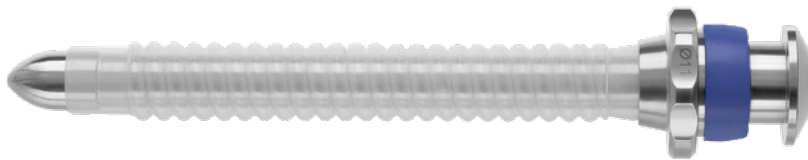
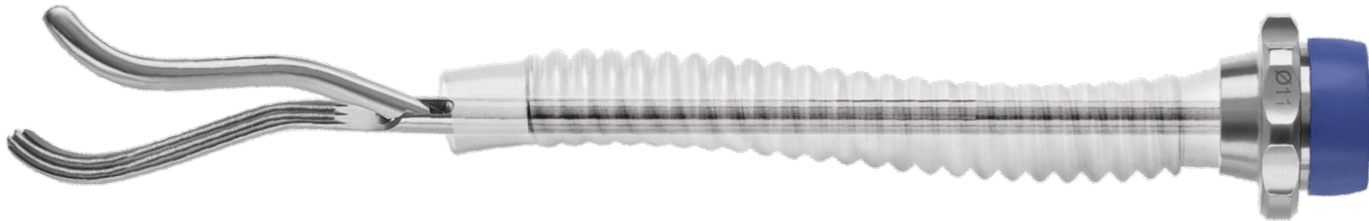

Thorax Trocar System, flexible, complete, Ø 11 mm  
 300-020-211 100 mm working length  
 300-020-711 70 mm working length



Thorax Trocar Sheath, Ø 11 mm,  
 for 100 mm  
 300-021-111



Thorax Trocar System, flexible, complete, Ø 5.5mm  
 300-020-255 100 mm working length  
 300-020-755 70 mm working length



Thorax Trocar Sheath, Ø 5.5mm  
 300-021-155 for 100 mm  
 300-021-755 for 70 mm



Obturator for flexible Thorax Trocar System  
 300-023-111 Ø 11.0mm, 100mm  
 300-023-711 Ø 11.0mm, 70mm  
 300-023-255 Ø 5.5mm, 100mm  
 300-023-755 Ø 5.5mm, 70mm



Gasket for Thorax Trocar System  
 Ø 11mm (package of 10 pcs.)  
 300-250-011 blue  
 300-250-055 white



Plastic Trocar Sleeve, flexible, package of 5 pieces  
 300-024-111 Ø 11.0mm, 100mm  
 300-024-711 Ø 11.0mm, 70mm  
 300-024-155 Ø 5.5mm, 100mm  
 300-024-755 Ø 5.5mm, 70mm



300-023-100 Endo Dilator Speculum, 195mm, with 3 blades,  
for symmetric dilation of the tissue during heavy tissue removal

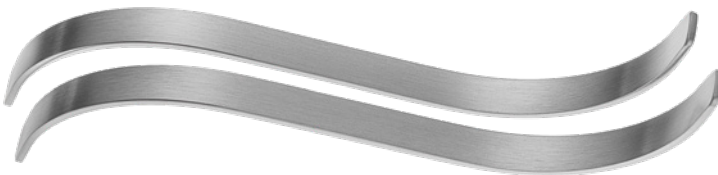

300-098-105 Tissue retractor, S-shaped, pair with 2 pieces  
to expose anatomical layers

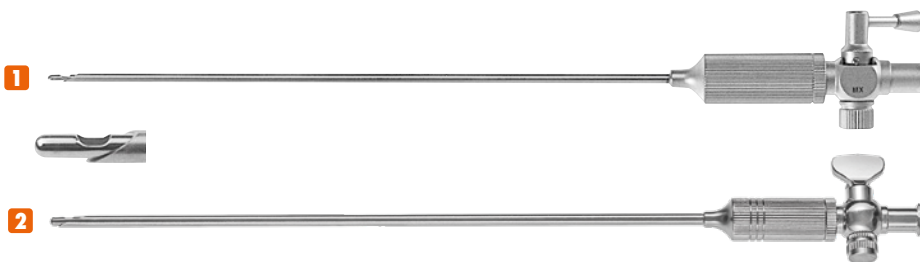

**1** Insufflation needle, matt chrome, Ø 2 mm

300-195-080	80 mm
300-195-100	100 mm*
300-195-120*	120 mm*
300-195-150	150 mm*
300-195-170	170 mm
300-195-200	200 mm

\* standard length

**2** Insufflation needle, polished chrome, Ø 2.7 mm, High-Flow

300-195-300	100 mm
300-195-320	120 mm*
300-195-350	150 mm*
300-195-370	170 mm*

# SUCTION AND IRRIGATION

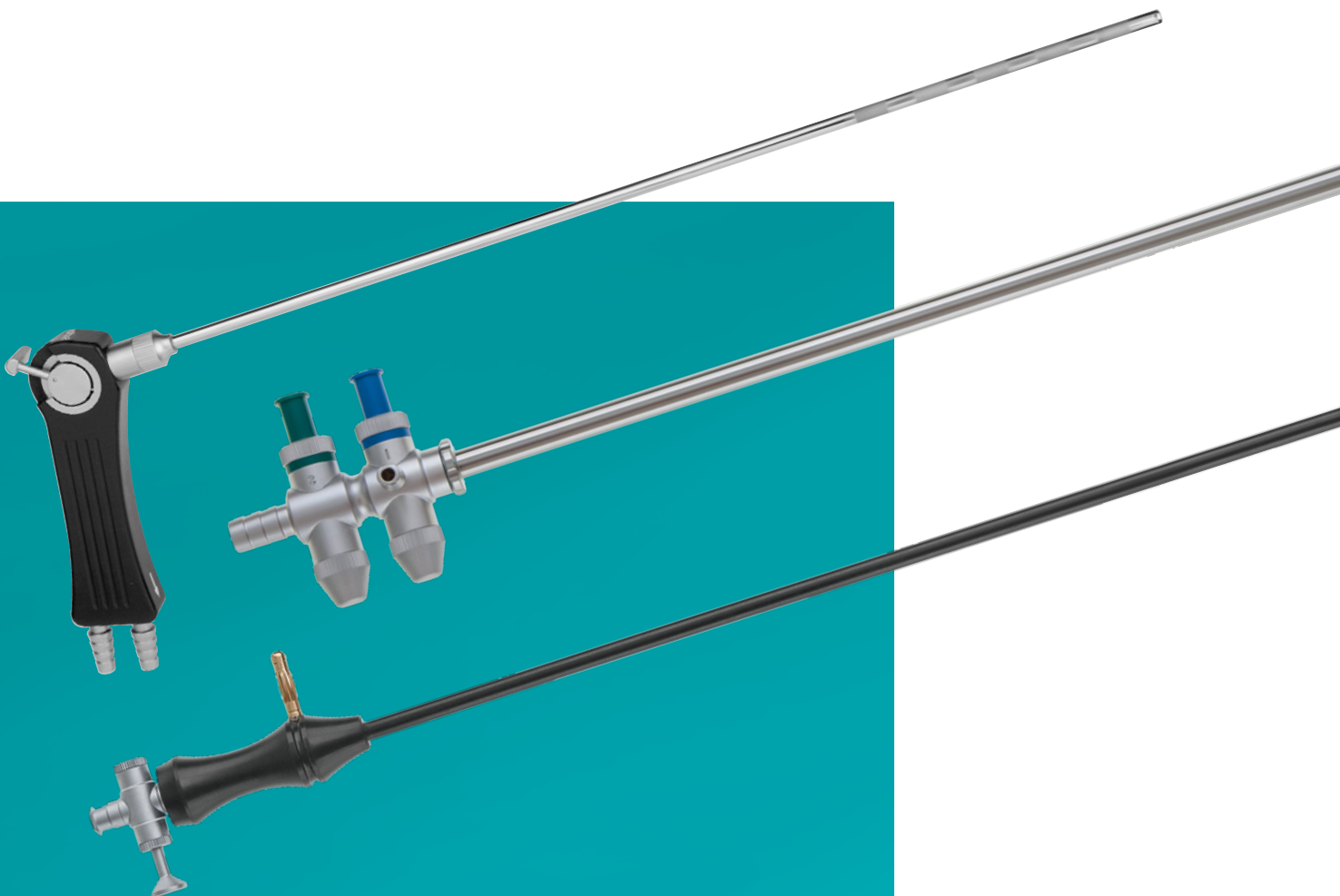

### RZ EASYCLEAN SUCTION AND IRRIGATION SYSTEM

- 2 color coded trumped valves
- Universal suction channel
- Lateral LuerLock irrigation channel

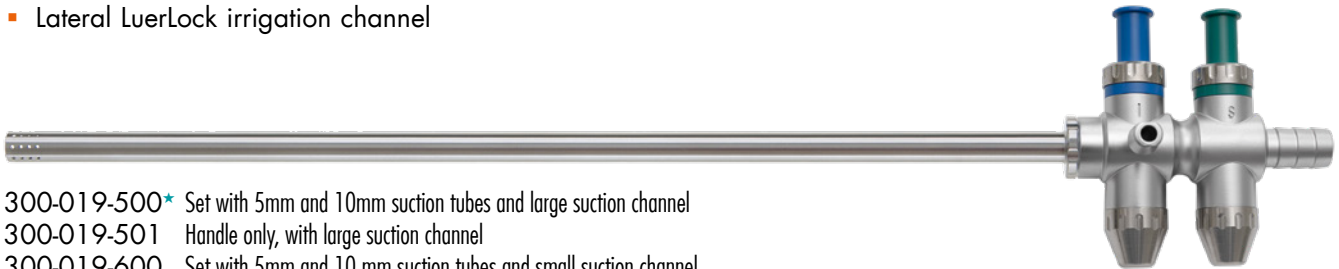

- 300-019-500\* Set with 5mm and 10mm suction tubes and large suction channel
- 300-019-501 Handle only, with large suction channel
- 300-019-600 Set with 5mm and 10 mm suction tubes and small suction channel
- 300-019-601 Handle only, with small suction channel



- Suction and irrigation handle
- 300-019-501 large suction channel
- 300-019-601 small suction channel



- 300-019-780 Gasket O-Ring
- 1 set with 10 pieces



- 300-019-770 Spring
- 1 set with 10 pieces



- Suction and irrigation tubes for 300-019-500/501/600/601



4x 4 holes, 340mm working length



Ø 3mm

300-019-735



Ø 5mm

300-019-705

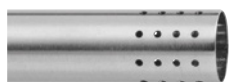

Ø 10mm

300-019-710



- Suction and irrigation tube with 4 x 4 holes for handles 300-019-501 and 300-019-601
- 300-019-805 Ø 5mm, 450mm
- 300-019-810 Ø 10 mm, 450mm



**300-165-100** Suction and irrigation handle with 2 trumpet valves, suction channel with large universal tube connector, irrigation channel with lateral LuerLock connection, removable ergonomic handle plate



**300-167-100** Suction and irrigation handle with 1 trumpet valve and large universal tube adapter



**300-166-100\*** Pistol-shaped suction and irrigation handle with 2-way valve and 2 large universal tube connectors for suction and irrigation

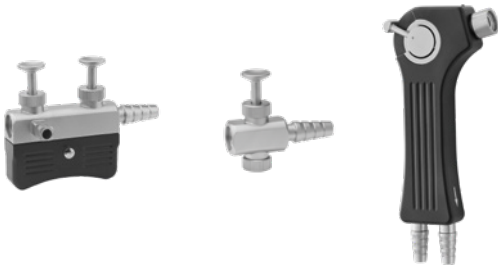

Suction and irrigation tubes, for 300-165-100, 300-166-100 and 300-167-100



4 holes, with markings, 340 mm working length



Ø 3mm

300-172-003



Ø 5mm

300-172-005\*



Ø 10mm

300-172-010\*



4x 4 holes, with markings, 340mm working length



Ø 3mm

300-173-003



Ø 5mm

300-173-005\*



Ø 10mm

300-173-010\*

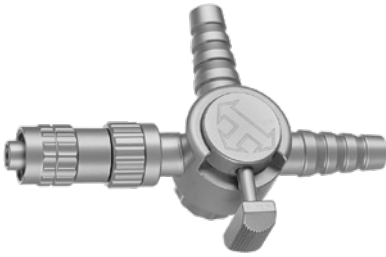

300-192-000\* Suction and irrigation handle with rotating 2-way lever mechanism and 2 large universal tube adapters with LuerLock connector



Suction and irrigation tubes for 300-192-000



4 holes on the tip, with markings and LuerLock, 340 mm working length



Ø 3mm

300-192-003



Ø 5mm

300-192-005\*

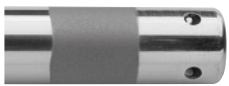

Ø 10mm

300-192-010\*



4x 4 holes, with markings and LuerLock, 340mm working length



Ø 3mm

300-193-003



Ø 5mm

300-193-005\*

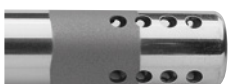

Ø 10mm

300-193-010\*



Suction or irrigation tube with LuerLock, 4 x 4 holes and stopcock, Ø 5mm

300-006-305 330 mm working length  
300-006-455 450 mm working length



Puncture and injection needle with LuerLock adapter, 5mm diameter, 20 mm needle length

	Needle tip	Working length	Needle length
300-194-307*	0.7 mm	330 mm	12mm
300-194-309*	0.9 mm	330 mm	20mm
300-194-312*	1.2 mm	330 mm	20mm
300-194-412	1.2 mm	450 mm	20mm
300-194-314*	1.4 mm	330 mm	20mm
300-194-414	1.4 mm	450 mm	20mm
300-194-318*	1.8 mm	330 mm	20mm
300-194-418	1.8 mm	450 mm	20mm



Palpation probe with markings and small handle

	Working length	Ø
300-193-305	330 mm	5mm
300-193-335*	330 mm	5mm
300-193-405	400 mm	5mm
300-193-410	400 mm	10mm

### ELECTRODES 340mm working length



J-hook Electrode, thick wire

300-163-110



L-hook Electrode

300-163-120



Spatula Electrode

300-163-130



Ballpoint Electrode

300-163-140

With ceramic tip, 340mm working length



L-hook Electrode

300-163-820



Spatula Electrode

300-163-830



300-166-000

Pistol-shaped suction and irrigation handle with 2-way valve.  
Additional rotating HF connector for monopolar cables.  
2 large universal tube connectors for suction and irrigation.

## COAGULATION ELECTRODES

with 4mm HF connector,  $\varnothing$  5mm,  
330mm working length



J-hook Electrode 300-100-132



L-hook Electrode 300-100-133\*



Spatula Electrode 300-100-131\*



Ballpoint Electrode 300-100-134

### HANDLE ELECTRODES

∅ 5mm, 360mm working length

- Large and ergonomic handle design
- Very fine tips
- Ceramic tip and PEEK shaft
- Suction connection optionally available



Without suction



With suction



Spatula Electrode  
360mm working length  
450mm working length

300-144-002\*  
300-144-452

300-145-003\*  
300-145-453



J-hook Electrode  
360mm working length  
450mm working length

300-144-004  
300-144-454

300-145-004\*  
300-145-454



L-hook Electrode  
360mm working length  
450mm working length

300-144-005\*  
300-144-455

300-145-005\*  
300-145-455



Needle Electrode  
360mm working length  
450mm working length

300-144-006\*  
300-144-456





300-145-006\*  
300-145-456

### ELECTRODES

with 4mm HF connector,  $\varnothing$  5mm, 340mm / 440mm working length







- Coagulation Suction / Irrigation Electrode
- Ergonomic handle
- Ceramic tip



		340mm	440mm
	J-hook Electrode	300-163-410	300-163-610
	L-hook Electrode	300-163-420	300-163-620*
	Spatula Electrode	300-163-430	300-163-630
	Knife Electrode	300-163-450	300-163-650

### MONOPOLAR CABLES



	4mm socket	4mm socket, angled	2mm plug	4mm plug	3mm socket	4mm plug
 Generator end RZ HF Unit Standard Plug	3m 700-501-303*					
	5m 700-501-503					
 RZ HF Unit SDS Plug	3m 700-501-300*					
	5m 700-501-500*					
 Erbe, Martin, Berchtold	3m 700-280-030*	700-290-030	700-291-030		700-292-030	700-293-033
	5m 700-280-050*	700-290-050				700-293-035
 Bovie, Valleylab, Conmed	3m 700-360-031*	700-361-030	700-362-030	700-363-030	700-364-030	700-370-030
	5m 700-360-051*	700-361-050		700-363-050		700-370-050
 Martin, Berchtold	3m 700-285-030*		700-286-030	700-286-130		700-286-230
	5m 700-285-050*					
 Erbe ACC/ICC	3m 700-101-030	700-102-030	700-103-030			700-286-230
	5m 700-101-050				700-104-050	

## RING HANDLE INSTRUMENTS

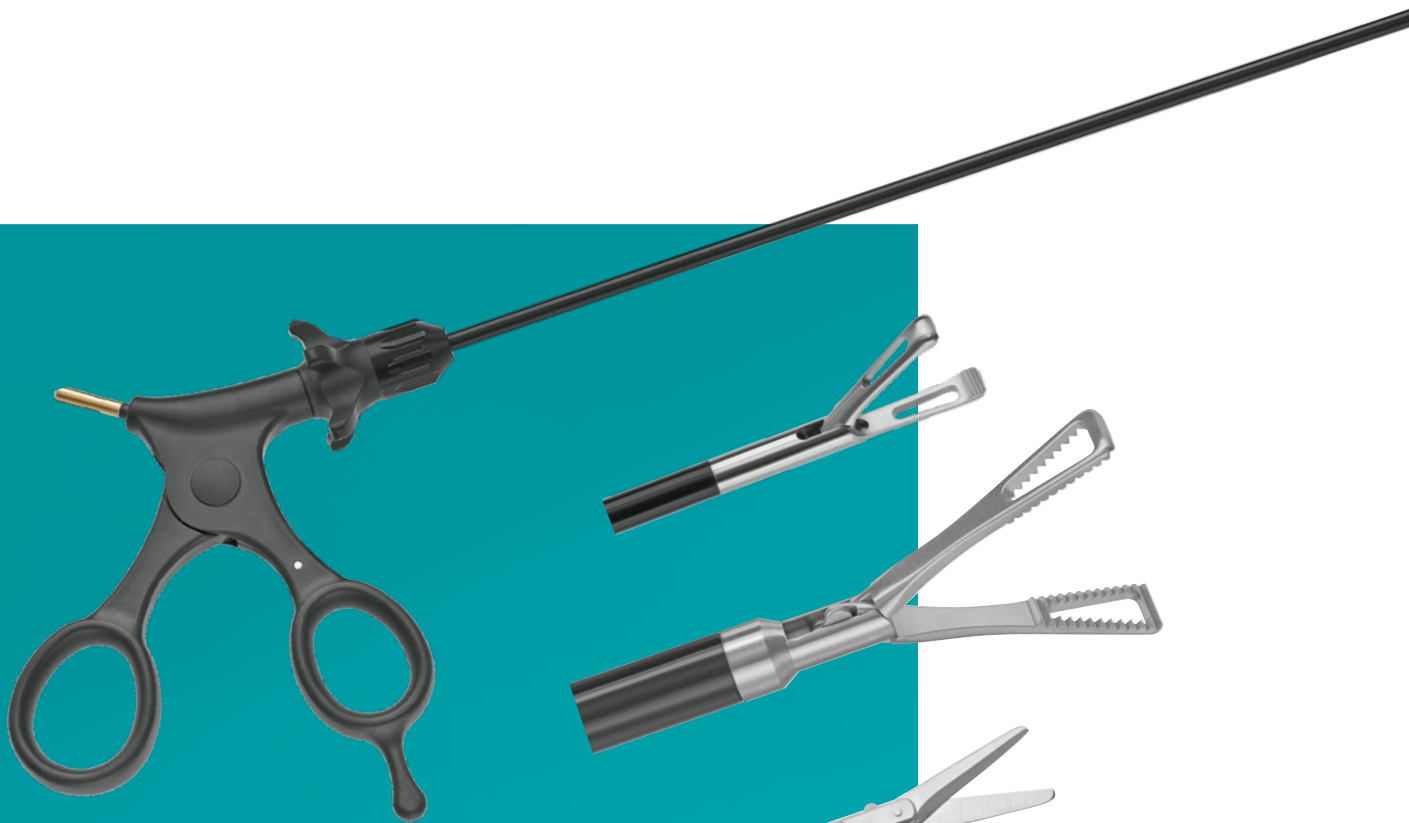

## Handles



300-750-101\*  
PEEK Polymer Handle with  
HF - connection



300-750-103\*  
PEEK Polymer Handle with ratchet  
and HF - connection



300-750-105\*  
PEEK Polymer Handle with hook up  
ratchet and HF - connection



300-750-106\*  
PEEK Polymer Handle with swing-away  
ratchet, rotatable and HF - connection



300-750-001  
Carbon Fiber Handle, rotating,  
HF - connection



300-750-003  
Carbon Fiber Handle, rotating,  
with ratchet, HF - connection



300-750-015  
Axial Handle with catch for needle holder  
fixed, for all needle holder inserts,  
with two gold rings

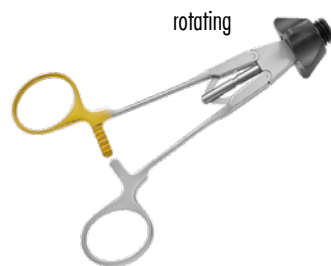

300-750-115  
Axial Handle with catch, rotating,  
for standard instrument,  
with one golden ring



300-750-215  
Axial Handle without catch,  
non rotating, for standard instrument,  
with two gold rings

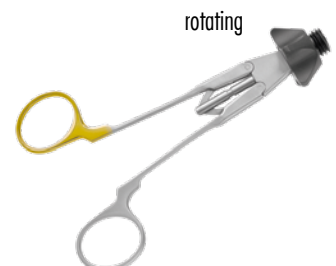

300-750-315  
Axial Handle without catch, rotating,  
for standard instrument, with one gold ring



Outer Sheath, insulated, adaptable to all handles, Ø 5mm

210 mm 300-550-005  
 330 mm 300-660-005\*  
 450 mm 300-760-005\*

- exchangeable color coding locking nuts
- advantages in handling and cleaning
- strengthening of the shaft through a partial thickening at the proximal end



Outer Sheath, insulated, adaptable to all handles, Ø 10 mm

210 mm 300-550-010  
 330 mm 300-660-010\*  
 450 mm 300-760-010\*



Outer Sheath, insulated, adaptable to all handles, with LuerLock

Ø 5mm 210 mm 300-550-105  
 Ø 5mm 330 mm 300-660-105  
 Ø 10 mm 330 mm 300-660-110  
 Ø 5mm 450 mm 300-760-105  
 Ø 10 mm 450 mm 300-760-110



300-400-900  
 Rubber Seals for LuerLock connectors  
 sales unit: 5 pcs.

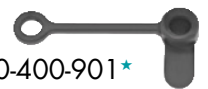

300-400-901\*  
 Rubber Seals for LuerLock connectors  
 sales unit: 5 pcs.



Locking Nuts

300-661-005 5mm ●  
 300-661-010 10mm ●  
 300-661-006 5mm ●  
 300-661-007 5mm ●  
 300-661-008 5mm ●  
 300-661-004 5mm ●  
 300-661-009 3.5mm\* ●



300-661-006OR  
 Sealing ring, package of  
 10 pieces,  
 autoclavable

\* for 3.5mm Mini Laparoscopy instruments



## 3-PIECE MODULAR INSTRUMENT

- Long-life and reliable materials
- Large variety of handle designs
- Ratchet mechanism / deactivation

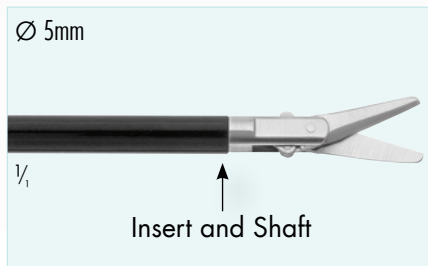

insert only

300-400-067

↑  
Insert's Catalogue-No.

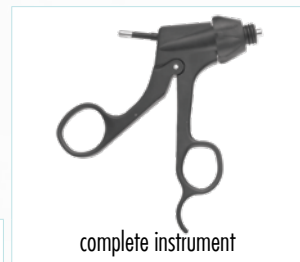

complete instrument  
300-410-067

↑  
Catalogue-No. of the  
complete Instrument

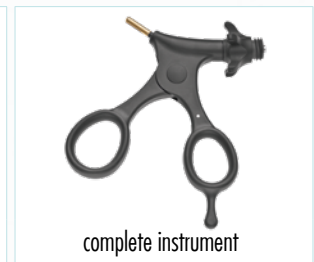

complete instrument  
300-420-067

↑  
Catalogue-No. of the  
complete Instrument

\*Each piece can be ordered separately

\*Each piece can be ordered separately



Watch the video on  
YouTube



The RZ spherical head  
locking system for fast  
assembling / disassembling



Modular 3-piece detachable instrument system consists of:

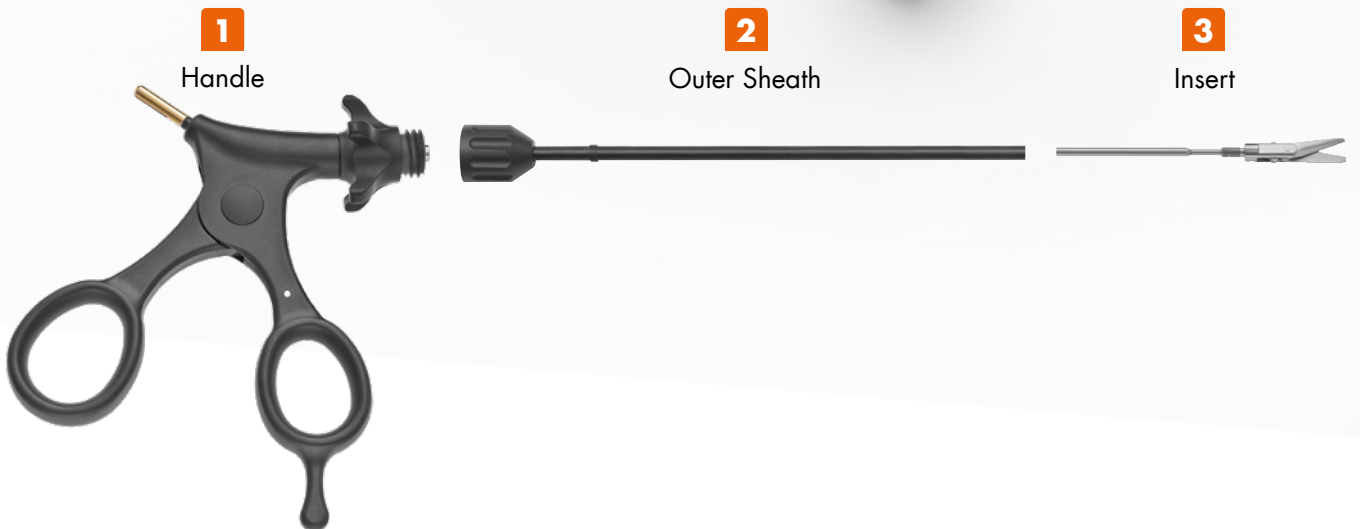

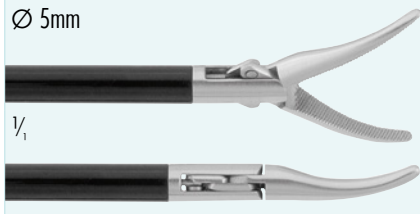

Catalogue-No. for insert only

300-400-732\*



Complete Instrument with handle 300-750-001  
300-410-732



Complete Instrument with handle 300-750-101  
300-420-732\*

**KELLY**

Dissecting forceps curved, slightly tapered, cross-serrated jaws, wide opening, double action, Ø 5mm, 330 mm

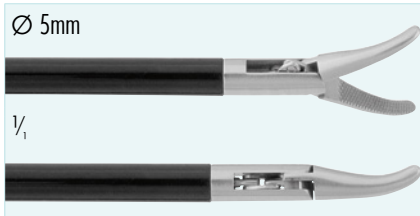

300-400-733

300-410-733

300-420-733

**BABY KELLY**

Short dissecting and suturing forceps, curved, tapered, cross-serrated jaws, wide opening, double action, Ø 5mm, 330 mm

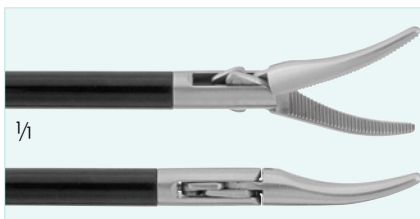

300-400-731\*

300-410-731

300-420-731\*

**MARYLAND**

Extra fine dissector with slightly tapered tip and gently curved for precise dissection, Ø 5mm, 330 mm





300-400-738\*

300-410-738

300-420-738\*

**MIXTER**

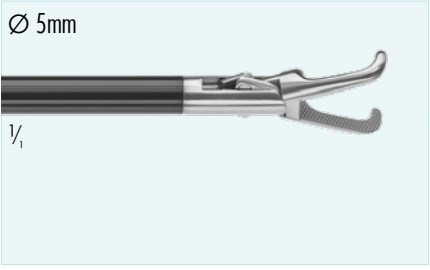
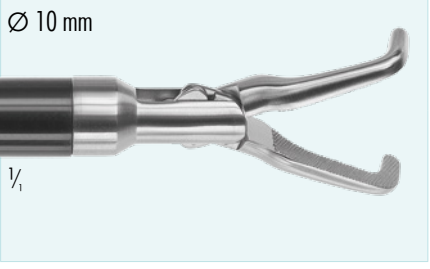
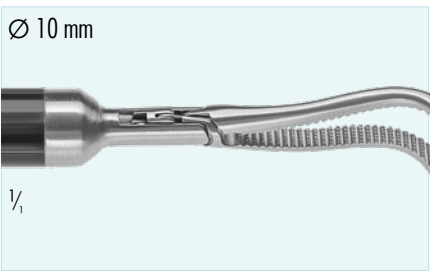
Fine dissecting forceps, 90° angled, fine serrated jaws, double action, Ø 5mm, 330 mm

	insert only	Complete Instrument with handle 300-750-001	Complete Instrument with handle 300-750-101
 <p>Ø 5mm 1/4</p>	300-400-735*	300-410-735	300-420-735*
<p><b>RIGHT ANGLE</b> Dissecting grasping forceps, fine serrated jaws, double action, Ø 5mm, 330 mm</p>			
 <p>Ø 10 mm 1/4</p>	300-400-736*	300-410-736	300-420-736*
<p><b>RIGHT ANGLE</b> Dissecting grasping forceps, fine serrated jaws, double action, Ø 10 mm, 330 mm</p>			
 <p>Ø 10 mm 1/4</p>	300-400-741	300-410-741	300-420-741
<p><b>OVERHOLT</b> Dissecting forceps 90° angled jaws, double action, Ø 10 mm, 330 mm</p>			
 <p>Ø 10 mm 1/4</p>	300-400-740	300-410-740	300-420-740
<p><b>MIXTER</b> Dissecting forceps, 10 mm long tip, 90° angled jaws, double action, Ø 10 mm, 330 mm</p>			
 <p>Ø 5mm 1/4</p>	300-400-027	300-410-027	300-420-027
<p><b>PETELIN</b> Dissecting forceps, single action jaws, angled 60° left. deep serrations, Ø 5mm, 330 mm</p>			

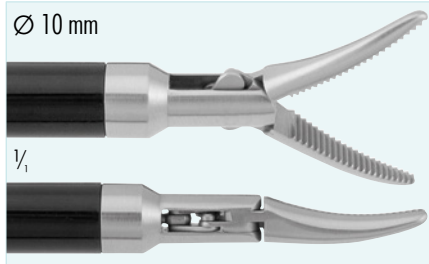

insert only  
300-400-730

Complete Instrument  
with handle 300-750-001  
300-410-730

Complete Instrument  
with handle 300-750-101  
300-420-730

**MARYLAND**  
Dissecting forceps curved left, blunt jaws, double action, Ø 10 mm, 330 mm

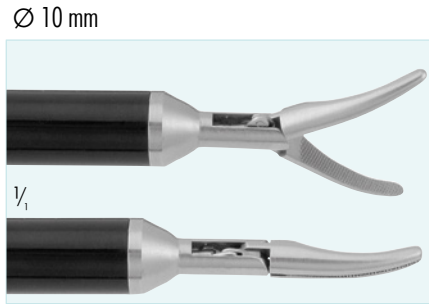

300-400-734

300-410-734

300-420-734

**MIXTER 45°**  
Dissecting forceps curved with long fine serrated jaws, double action, Ø 10 mm, 330 mm

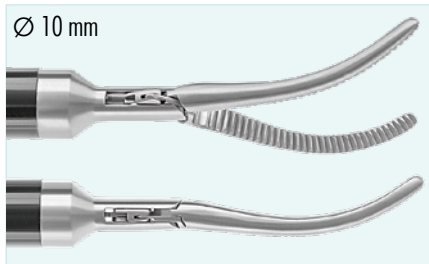

300-400-737

300-410-737

300-420-737

**OVERHOLT-MIXTER**  
Dissecting forceps curved with slim long serrated jaws, double action, Ø 10 mm, 330 mm





300-400-739\*

300-410-739

300-420-739\*

**MIXTER 90°**  
Dissecting forceps 90° angled, serrated jaws, double action, Ø 10 mm, 330 mm

	insert only	 Complete Instrument with handle 300-750-001	 Complete Instrument with handle 300-750-101
Ø 5mm	300-400-044	300-410-044	300-420-044



### ADHESION FORCEPS

Serrated jaws, one fenestrated, double action, Ø 5mm, 330 mm

Ø 5mm	300-400-109	300-410-109	300-420-109
-------	-------------	-------------	-------------



### GRASPING FORCEPS

1x2 teeth, single action, Ø 5mm, 330 mm

Ø 5mm	300-400-251*	300-410-251	300-420-251*
-------	--------------	-------------	--------------



### BABCOCK

Grasping Forceps, single action, Ø 5mm, 330 mm

Ø 5mm	300-400-023	300-410-023	300-420-023
-------	-------------	-------------	-------------

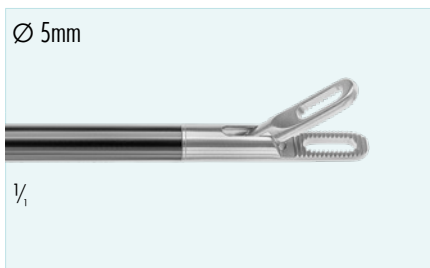

### JOHANS

Grasping Forceps, fenestrated jaws, serrated, 12mm, single action, Ø 5mm, 330 mm

Ø 5mm	300-400-087	300-410-087	300-420-087
-------	-------------	-------------	-------------



### DUCKBILL

Grasping Forceps, serrated, double action, Ø 5mm, 330 mm

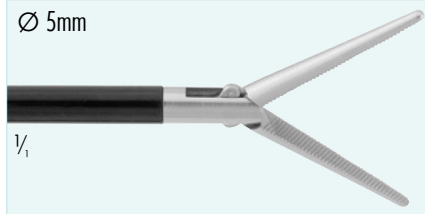

insert only
300-400-016*



300-410-016
-------------



300-420-016*
--------------

### NEEDLE NOSE

Dissecting and grasping forceps with tapered and fine, cross-serrated jaws, double action, Ø 5mm, 330 mm



300-400-003
-------------

300-410-003
-------------

300-420-003
-------------

### NEEDLE NOSE

Dissecting and grasping forceps with tapered and fine, cross-serrated jaws, single action, Ø 5mm, 330 mm



300-400-040
-------------

300-410-040
-------------

300-420-040
-------------

### FENESTRATED BULLNOSE

Dissecting and grasping forceps with delicate, fenestrated and flat jaws, deep serration, double action, Ø 5mm, 330 mm

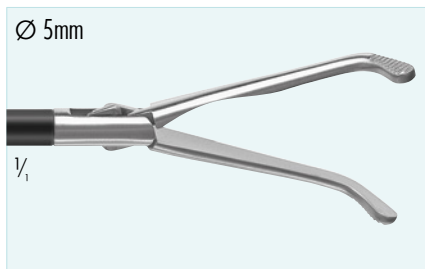

300-400-610
-------------

300-430-610
-------------

300-440-610
-------------

### PYLORUS

Spreader, double action, Ø 5mm, 330 mm



insert only
-------------

Complete Instrument with handle 300-750-001
---

Complete Instrument with handle 300-750-101
---

Complete Instrument with handle 300-750-003
---

Complete Instrument with handle 300-750-103
---



300-400-025*
--------------

300-410-025
-------------

300-420-025*
--------------

300-430-025
-------------

300-440-025*
--------------

### DOLPHIN

Dissecting and grasping forceps with biopsy cup and fine serrated and tapered jaws, double action, Ø 5mm, 330 mm



insert only  
300-400-012\*

Complete Instrument with handle 300-750-003  
300-430-012

Complete Instrument with handle 300-750-103  
300-440-012\*

**JAEGER**  
Grasping forceps with fenestrated jaws, DeBakey serration, 20 mm, double action, Ø 5mm, 330 mm

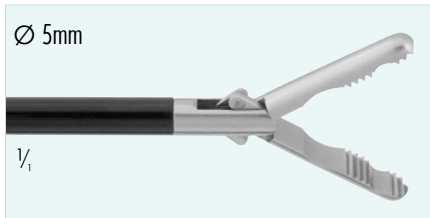

300-400-015\*

300-430-015

300-440-015\*

**FUNDUS**  
Grasping forceps with 2 cups and serrated jaws, double action, Ø 5mm, 330 mm



300-400-005

300-430-005

300-440-005

**BULLDOG**  
Grasping forceps with fine serrated jaws, single action, Ø 5mm, 330 mm

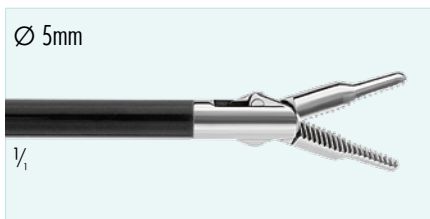





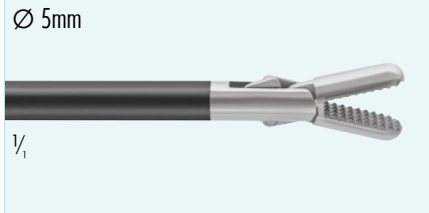

300-400-021

300-430-021

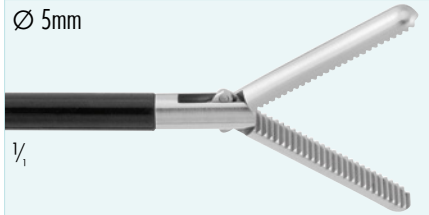
300-440-021

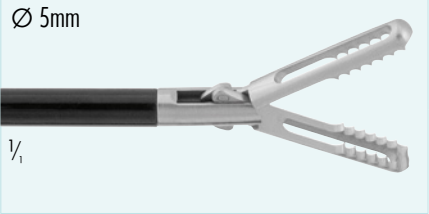
**DOLPHIN**  
Grasping and dissecting forceps with fine serrated tapered jaws, double action, Ø 5mm, 330 mm

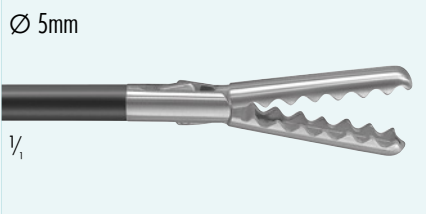

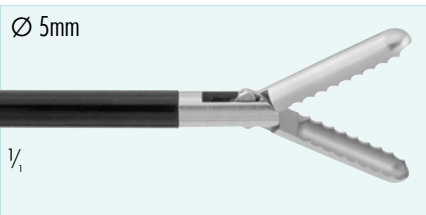

	insert only	Complete Instrument with handle 300-750-003	Complete Instrument with handle 300-750-103	Complete Instrument with handle 300-750-105
 <p>Ø 5mm 1/1</p>	300-400-001*	300-430-001	300-440-001*	300-460-001*
<b>BULLNOSE</b> Grasping forceps, heavy pattern, standard serrated jaws, double action, Ø 5mm, 330 mm				
 <p>Ø 5mm 1/1</p>	300-400-008	300-430-008	300-440-008	300-460-008
<b>STRONG TC GRASPER</b> Grasping forceps with Tungsten Carbide jaw inserts, heavy pattern, pyramidal tip, serrated jaws, double action, Ø 5mm, 330 mm				
 <p>Ø 5mm 1/1</p>	300-400-029*	300-430-029	300-440-029*	300-460-029*
<b>STRONG TC GRASPER</b> Grasping forceps with Tungsten Carbide jaw inserts, heavy pattern, pyramidal tip, serrated, 15mm long jaws, double action, Ø 5mm, 330 mm				
 <p>Ø 5mm 1/1</p>	300-400-002	300-430-002	300-440-002	300-460-002
<b>XL BULLNOSE</b> Grasping forceps, standard serrated jaws, double action, Ø 5mm, 330 mm				
 <p>Ø 5mm 1/1</p>	300-400-000	300-430-000	300-440-000	300-460-000
<b>STANDARD</b> Grasping forceps with biopsy cup, heavy pattern, standard serrated jaws, double action, Ø 5mm, 330 mm				
 <p>Ø 5mm 1/1</p>	300-400-017*	300-430-017	300-440-017*	300-460-017*
<b>GRIPPER #1</b> Grasping forceps with coarse-serrated, fenestrated jaws, double action, Ø 5mm, 330 mm				

	insert only	Complete Instrument with handle 300-750-003	Complete Instrument with handle 300-750-103	Complete Instrument with handle 300-750-105
 <p>Ø 5mm 1/1</p> <p><b>PRESTIGE</b> Atraumatic grasping forceps with long, wave shaped jaws and deep cup with lateral serration, double action, Ø 5mm, 330 mm</p>	300-400-013*	300-430-013	300-440-013*	300-460-013*
 <p>Ø 5mm 1/1</p> <p><b>PRESTIGE</b> Grasping Forceps, wave-shaped lateral serration, and deep cup, single action, atraumatic, Ø 5mm, 330 mm</p>	300-400-033*	300-430-033	300-440-033*	300-460-033*
 <p>Ø 5mm 1/1</p> <p><b>ALLIGATOR</b> Grasping forceps with fine sharp lateral teeth and deep cup, double action, Ø 5mm, 330 mm</p>	300-400-053	300-430-053	300-440-053	300-460-053

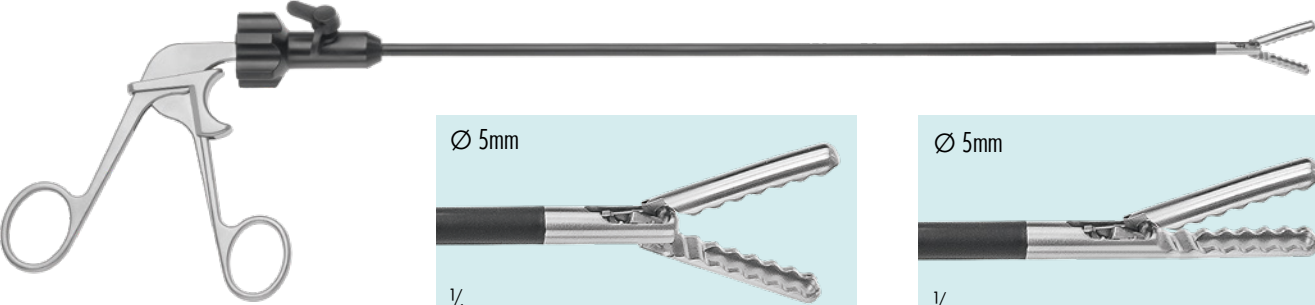
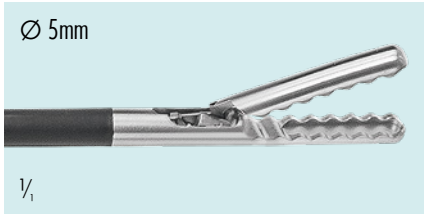
## NON-DETACHABLE PRESTIGE FORCEPS

Complete Instrument, rotating, insulated, with prestige handle and Luer-Lock connection, 330mm working length

 <p>Ø 5mm 1/1</p> <p>300-111-013 Double action jaws</p>	 <p>Ø 5mm 1/1</p> <p>300-111-033 Single action jaws</p>
---	--

	insert only	Complete Instrument with handle 300-750-003	Complete Instrument with handle 300-750-103	Complete Instrument with handle 300-750-105
 <p>Ø 5mm 1/1</p> <p><b>KOCHER</b> Grasping forceps with aggressive 3 x 4 teeth and serrated inner jaws, double action, Ø 5mm, 330 mm</p>	300-400-004*	300-430-004	300-440-004*	300-460-004*
 <p>Ø 5mm 1/1</p> <p><b>KOCHER</b> Grasping forceps with aggressive 2 x 4 teeth and serrated inner jaws, single action, Ø 5mm, 330 mm</p>	300-400-006	300-430-006	300-440-006	300-460-006
 <p>Ø 5mm 1/1</p> <p><b>ALLIS</b> Grasping forceps with 1 x 2 teeth and smooth inner jaws, single action, Ø 5mm, 330 mm</p>	300-400-014	300-430-014	300-440-014	300-460-014
 <p>Ø 5mm 1/1</p> <p><b>ALLIS</b> Grasping forceps with 1 x 2 teeth and serrated inner jaws, double action, Ø 5mm, 330 mm</p>	300-400-009	300-430-009	300-440-009	300-460-009
 <p>Ø 5mm 1/1</p> <p><b>COBRA</b> Grasping forceps with sharp 2 x 4 teeth and serrated inner jaws, double action, Ø 5mm, 330 mm</p>	300-400-201*	300-430-201	300-440-201*	300-460-201*



insert only  
300-400-011\*



Complete Instrument  
with handle 300-750-003  
300-430-011



Complete Instrument  
with handle 300-750-103  
300-440-011\*



Complete Instrument  
with handle 300-750-105  
300-460-011\*

### MARTIN

Grasping forceps with multiple fine serrations, 4.8 mm wide jaws, single action, Ø 5mm, 330 mm



300-400-713\*

300-430-713

300-440-713\*

300-460-713\*

### CLAW GRASPER

Grasping forceps, aggressive 2 x 3 teeth and smooth inner jaws, single action, Ø 5mm, 330 mm



300-401-713

300-431-713

300-441-713

300-461-713

### CLAW GRASPER

Grasping forceps, aggressive 2 x 3 teeth and smooth inner jaws, single action, Ø 5mm, 450 mm

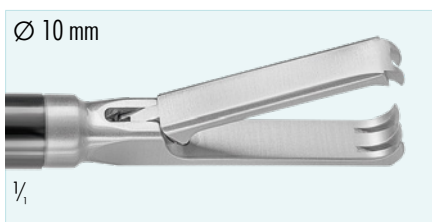

300-400-710\*

300-430-710

300-440-710\*

300-460-710\*

### CLAW GRASPER

Grasping forceps, aggressive 2 x 3 teeth and smooth inner jaws, single action, Ø 10 mm, 330 mm



300-400-717

300-430-717

300-440-717

300-460-717

### DAVIS

Grasping forceps, blunt interlocking 2 x 3 teeth and long ridged inner jaws, double action, Ø 5mm, 330 mm

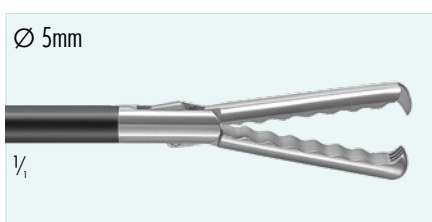

300-400-715

300-430-715

300-440-715

300-460-715

### ST. ANDREWS

Grasping forceps, with sharp 2 x 4 teeth and wave shaped inner jaws, double action, Ø 5mm, 330 mm

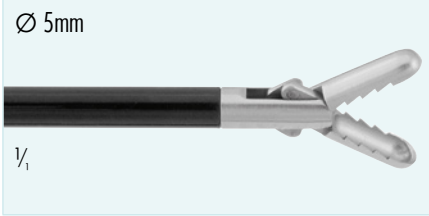
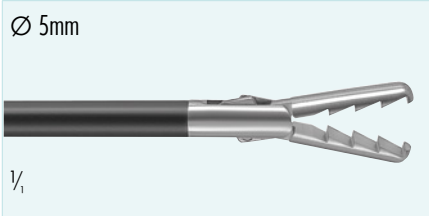
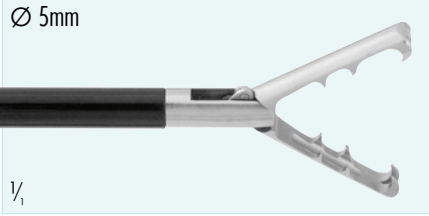
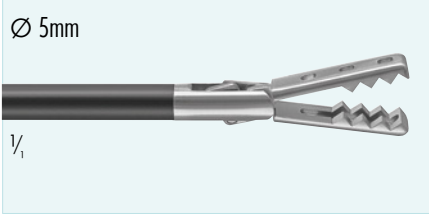
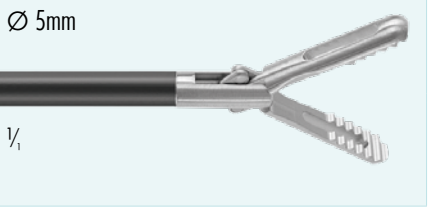
	insert only	Complete Instrument with handle 300-750-003	Complete Instrument with handle 300-750-103	Complete Instrument with handle 300-750-105
 <p>∅ 5mm 1/1</p>	300-400-051	300-430-051	300-440-051	300-460-051
<p><b>ALLIGATOR SPOON</b> Grasping forceps with cupped jaws, aggressive retrograde lateral teeth, double action, ∅ 5mm, 330 mm</p>				
 <p>∅ 5mm 1/1</p>	300-400-010*	300-430-010	300-440-010*	300-460-010*
<p><b>ALLIGATOR</b> Grasping forceps with strong retrograde serrations, double action, ∅ 5mm, 330 mm</p>				
 <p>∅ 5mm 1/1</p>	300-400-048	300-430-048	300-440-048	300-460-048
<p><b>SHARK</b> Grasping forceps with very sharp and aggressive lateral retrograde teeth, double action, ∅ 5mm, 330 mm</p>				
 <p>∅ 5mm 1/1</p>	300-400-018	300-430-018	300-440-018	300-460-018
<p><b>CLINCH</b> Grasping forceps with strong serration and fenestrated jaws, double action, ∅ 5mm, 330 mm</p>				
 <p>∅ 5mm 1/1</p>	300-400-049	300-430-049	300-440-049	300-460-049
<p><b>ENDOCLINCH</b> Grasping forceps, wave-shaped, fenestrated, double action, ∅ 5mm, 330 mm</p>				



insert only  
300-400-042

Complete Instrument  
with handle 300-750-003  
300-410-042

Complete Instrument  
with handle 300-750-103  
300-420-042

### PIN GRASPER

Grasping Forceps with fine 1x2 teeth, smooth inner jaws, double action, Ø 5mm, 330 mm

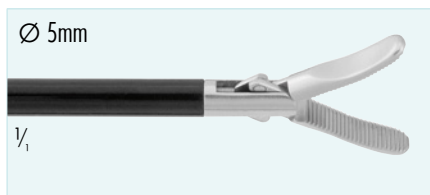

300-400-045

300-410-045

300-420-045

### OVARY

Grasping forceps with fine serrated, wave shaped jaws, double action, Ø 5mm, 330 mm

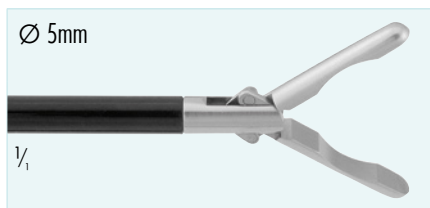

300-400-046

300-410-046

300-420-046

### TUBAL

Dissecting and grasping forceps with smooth jaws, double action, Ø 5mm, 330 mm



300-400-024

300-410-024

300-420-024

### DUCKBILL

Grasping and dissecting forceps with flat jaws, fine serrations, double action, Ø 5mm, 330 mm



300-400-032

300-410-032

300-420-032

### PETITE

Micro Grasping Forceps, double action, fenestrated, fine jaw, fine serration







300-400-026

300-410-026

300-420-026

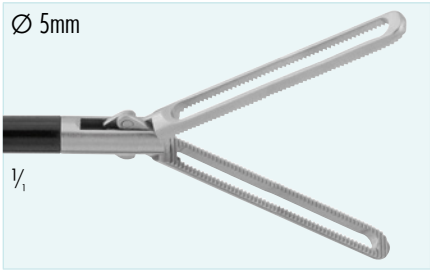
### PETELIN

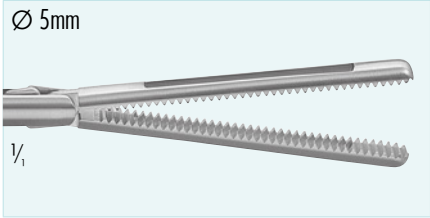
Grasping and Dissecting Forceps with serrated jaws, curved left, single action, Ø 5mm, 330 mm

	insert only	Complete Instrument with handle 300-750-003	Complete Instrument with handle 300-750-103	Complete Instrument with handle 300-750-105
 <p>Ø 5mm 1/1</p> <p><b>JOHANS</b> Grasping forceps with 20 mm fenestrated jaws, double action, Ø 5mm, 330 mm</p>	300-400-289*	300-430-289	300-440-289*	300-470-289*
 <p>Ø 5mm 1/1</p> <p><b>LONG JOHANS</b> Grasping forceps with 40 mm fenestrated jaws, double action, Ø 5mm, 330 mm</p>	300-400-291*	300-430-291	300-440-291*	300-470-291*
 <p>Ø 5mm 1/1</p> <p><b>DORSEY</b> Grasping forceps with 12 mm fenestrated jaws, double action, Ø 5mm, 330 mm</p>	300-400-285*	300-430-285	300-440-285*	300-470-285*
 <p>Ø 5mm 1/1</p> <p><b>LONG DORSEY</b> Grasping forceps with 45 mm fenestrated jaws, double action, Ø 5mm, 330 mm</p>	300-400-287	300-430-287	300-440-287	300-470-287
 <p>Ø 5mm 1/1</p> <p><b>LONG JOHANS</b> Grasping forceps with 40 mm fenestrated jaws, single action, Ø 5mm, 330 mm</p>	300-400-288	300-430-288	300-440-288	300-470-288



insert only
300-400-284*



Complete Instrument  
with handle 300-750-003

300-430-284



Complete Instrument  
with handle 300-750-103

300-440-284\*



Complete Instrument  
with handle 300-750-105

300-470-284\*

### JOHANS

Grasping forceps with 20 mm fenestrated jaws, single action, Ø 5mm, 330 mm



300-400-310*
300-400-312**

300-430-310
300-430-312*

300-440-310*
300-440-312**

300-470-310*
300-470-312**

### MARQUES

Grasping forceps with 2 fenestrations, single action, Ø 5mm, 330 mm  
\* with 3 fenestrations



300-400-314*
--------------

300-430-314
-------------

300-440-314*
--------------

300-470-314*
--------------

### MARQUES

Grasping forceps with 2 fenestrations, bent up, single action, Ø 5mm, 330 mm

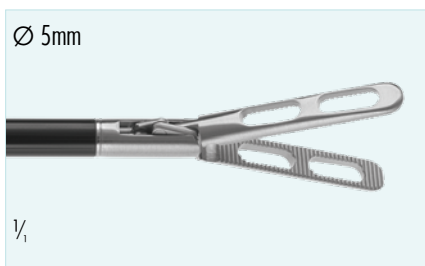

300-400-311
300-400-313*

300-430-311
300-430-313*

300-440-311
300-440-313*

300-470-311
300-470-313*

### MARQUES

Grasping forceps with 2 fenestrations, double action, Ø 5mm, 330 mm  
\* with 3 fenestrations

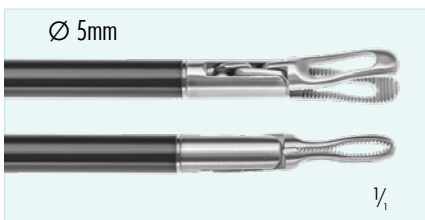

300-400-052*
--------------







300-430-052
-------------

300-440-052*
--------------

300-470-052*
--------------

### GRASPER

Atraumatic Grasping forceps with fenestrated jaws, fine serrations, double action, Ø 5mm, 330 mm

<p>Ø 5mm</p>  <p>1/1</p>	<p>insert only</p>	 <p>Complete Instrument with handle 300-750-001</p>	 <p>Complete Instrument with handle 300-750-101</p>
	<p>300-400-080*</p>	<p>300-410-080</p>	<p>300-420-080*</p>
<p>Biopsy forceps with 2 pinholes, sharp oval cups, double action, Ø 5mm, 330 mm</p>			
<p>Ø 5mm</p>  <p>1/1</p>	<p>300-400-082</p>	<p>300-410-082</p>	<p>300-420-082</p>
<p>Biopsy forceps with sharp oval cups, double action, Ø 5mm, 330 mm</p>			
<p>Ø 5mm</p>  <p>1/1</p>	<p>300-400-521</p>	<p>300-410-521</p>	<p>300-420-521</p>
<p>Biopsy forceps with 2 pins, sharp oval cups, single action, Ø 5mm, 330 mm</p>			
<p>Ø 5mm</p>  <p>1/1</p>	<p>300-400-086</p>	<p>300-410-086</p>	<p>300-420-086</p>
<p><b>BLAKESLEY</b> Biopsy forceps with sharp cups, single action, Ø 5mm, 330 mm</p>			
<p>Ø 5mm</p>  <p>1/1</p>	<p>300-400-100</p>	<p>300-410-100</p>	<p>300-420-100</p>
<p>Hook punch forceps, thru-cutting, single action, Ø 5mm, 330 mm</p>			

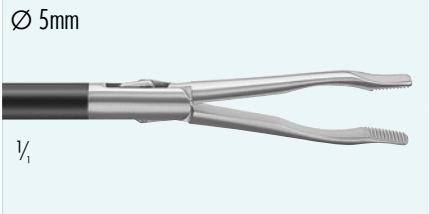
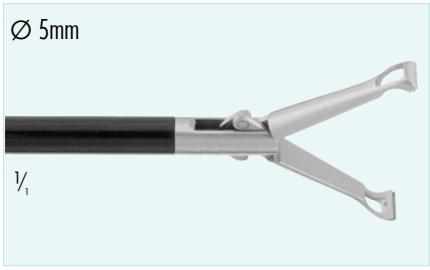
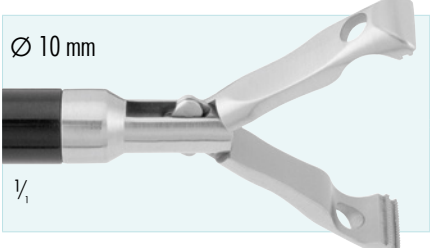
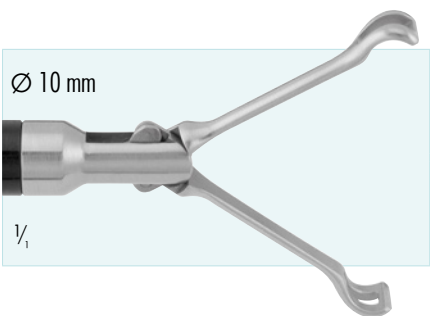
	insert only	Complete Instrument with handle 300-750-003	Complete Instrument with handle 300-750-103	Complete Instrument with handle 300-750-105
 <p>Ø 5mm 1/4</p>	300-400-250	300-430-250	300-440-250	300-470-250
<p><b>BABCOCK PADDLE</b> Grasping forceps with flat paddles and fine serration for atraumatic grip of delicate tissue, double action, Ø 5mm, 330 mm</p>				
 <p>Ø 5mm 1/4</p>	300-400-252*	300-430-252	300-440-252*	300-470-252*
<p><b>BABCOCK</b> Traditional style Babcock grasping forceps, rounded jaws with fine serrations, double action, Ø 5mm, 330 mm</p>				
 <p>Ø 10 mm 1/4</p>	300-400-079	300-430-079	300-440-079	300-470-079
<p><b>DEBAKEY BABCOCK</b> Traditional style Babcock grasping forceps, rounded jaws with atraumatic DeBakey serration, double action, Ø 10 mm, 330 mm</p>				
 <p>Ø 10 mm 1/4</p>	300-400-078*	300-430-078	300-440-078*	300-470-078*
<p><b>BABCOCK</b> Traditional style Babcock grasping forceps with medium jaws, rounded jaws with fine serrations, double action, Ø 10 mm, 330 mm</p>				

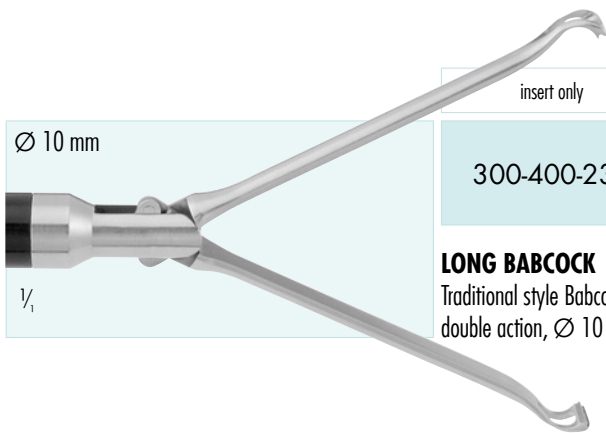

insert only  
300-400-234

Complete Instrument  
with handle 300-750-003  
300-430-234

Complete Instrument  
with handle 300-750-103  
300-440-234

Complete Instrument  
with handle 300-750-105  
300-470-234

### LONG BABCOCK

Traditional style Babcock grasping forceps with long jaws, rounded jaws with fine serrations, double action, ∅ 10 mm, 330 mm

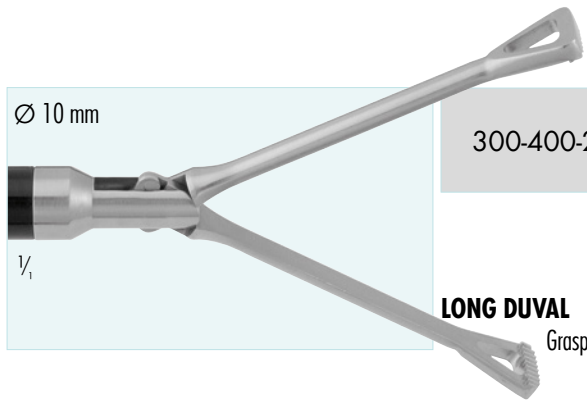

300-400-280

300-430-280

300-440-280

300-470-280

### LONG DUVAL

Grasping forceps with long jaws, V-shaped tip with fine serrations, double action, ∅ 10 mm, 330 mm

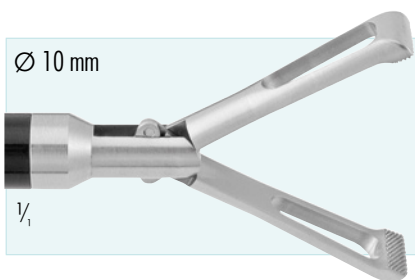

300-400-084





300-430-084

300-440-084

300-470-084

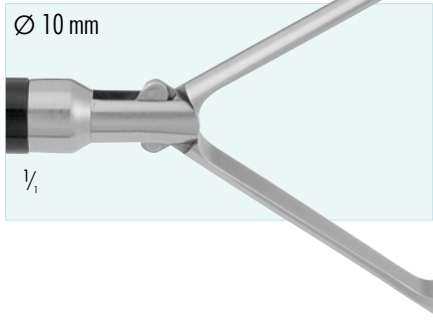
### COLLIN-DUVAL

Grasping forceps, V-shaped tip with fine serrations on the tip, double action, ∅ 10 mm, 330 mm

 <p>Ø 10 mm</p> <p>1/1</p>	insert only	 <p>Complete Instrument with handle 300-750-003</p>	 <p>Complete Instrument with handle 300-750-103</p>	 <p>Complete Instrument with handle 300-750-105</p>
	300-400-074	300-430-074	300-440-074	300-470-074

**ALLIS**  
Traditional Allis grasping forceps, with fine serrations on the tip, double action, Ø 10 mm, 330 mm

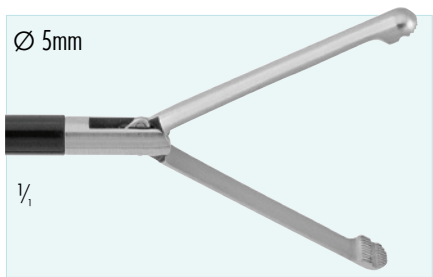
 <p>Ø 5mm</p> <p>1/1</p>	300-400-097	300-430-097	300-440-097	300-470-097
--	-------------	-------------	-------------	-------------

**SLIM ALLIS**  
Grasping forceps with delicate jaws and with fine serrations on the tip, double action, Ø 5mm, 330 mm

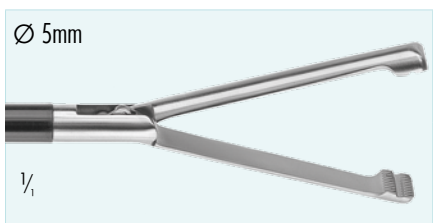
 <p>Ø 5mm</p> <p>1/1</p>	300-400-197	300-430-197	300-440-197	300-470-197
---	-------------	-------------	-------------	-------------

**ALLIS**  
Bowell grasping forceps, 4 mm x 35mm, double action, Ø 5mm, 330 mm

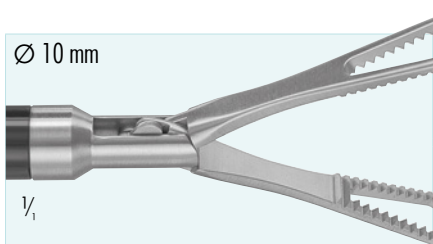
 <p>Ø 10 mm</p> <p>1/1</p>	300-400-085*	300-430-085	300-440-085*	300-470-085*
---	--------------	-------------	--------------	--------------

**COLLIN**  
Grasping forceps, V-shaped tip with deep serrations for firm grip, double action, Ø 10 mm, 330 mm



insert only
300-400-243

Complete Instrument with handle 300-750-003
300-430-243

Complete Instrument with handle 300-750-103
300-440-243

Complete Instrument with handle 300-750-105
300-460-243

**DEBAKEY**  
Pick-up forceps with fine 22 mm long atraumatic serrations, 38 mm jaws, double action, Ø 5mm, 330 mm

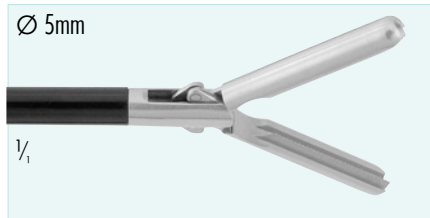

300-400-244
-------------

300-430-244
-------------

300-440-244
-------------

300-460-244
-------------

**DEBAKEY**  
Atraumatic grasping forceps, fine atraumatic serrations, double action, 25mm jaws, Ø 5mm, 330 mm

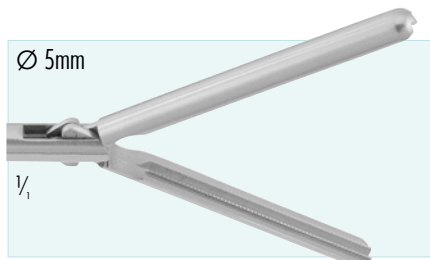

300-400-245
-------------

300-430-245
-------------

300-440-245
-------------

300-460-245
-------------

**DEBAKEY**  
Atraumatic grasping forceps, fine atraumatic serrations, double action, 40 mm jaws, Ø 5mm, 330 mm

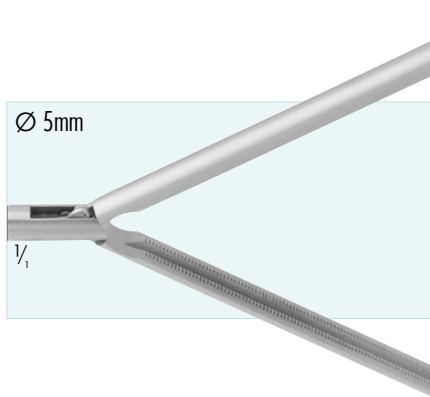

300-400-246
-------------

300-430-246
-------------

300-440-246
-------------

300-460-246
-------------

**DEBAKEY**  
Atraumatic grasping forceps, fine atraumatic serrations, double action, 60 mm jaws, Ø 5mm, 330 mm

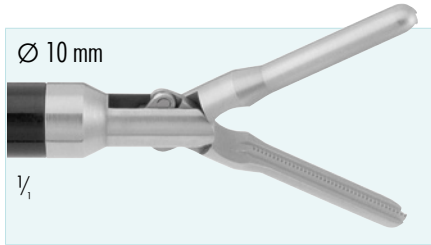

insert only	Complete Instrument with handle 300-750-003	Complete Instrument with handle 300-750-103	Complete Instrument with handle 300-750-105
300-400-263	300-430-263	300-440-263	300-460-263

**DEBAKEY**

Atraumatic grasping forceps, fine atraumatic serrations, double action, 25mm jaws, Ø 10 mm, 330 mm

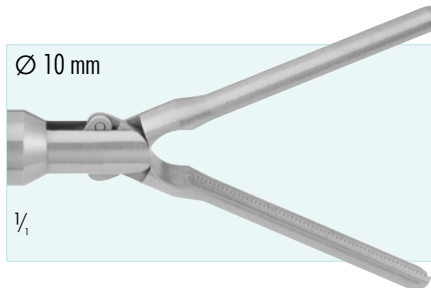

300-400-264	300-430-264	300-440-264	300-460-264
-------------	-------------	-------------	-------------

**DEBAKEY**

Atraumatic grasping forceps, fine atraumatic serrations, double action, 40 mm jaws, Ø 10 mm, 330 mm

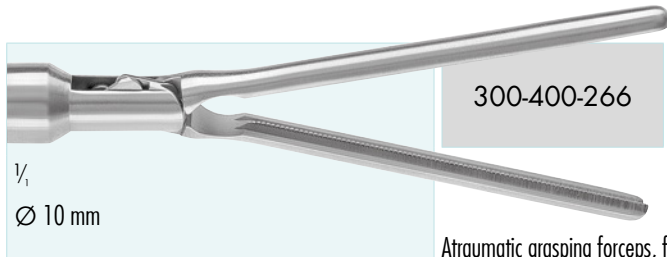

300-400-266	300-430-266	300-440-266	300-460-266
-------------	-------------	-------------	-------------

**DEBAKEY**

Atraumatic grasping forceps, fine atraumatic serrations, double action, 60 mm jaws, Ø 10 mm, 330 mm

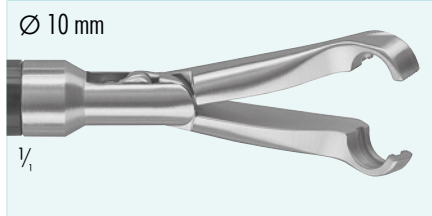

insert only

300-400-295

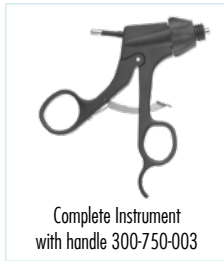

Complete Instrument  
with handle 300-750-003

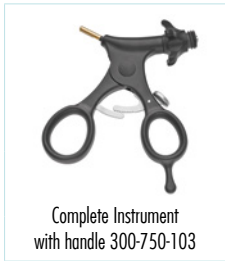

Complete Instrument  
with handle 300-750-103



Complete Instrument  
with handle 300-750-105

**ANVIL**  
Grasping forceps with specially shaped jaws to grasp and hold the anvil of a circular stapler, double action, Ø 10 mm, 330 mm



300-400-286

300-430-286

300-440-286

300-460-286

**DORSEY**  
Grasping forceps, fenestrated jaws with medium serrations, double action, Ø 10 mm, 330 mm

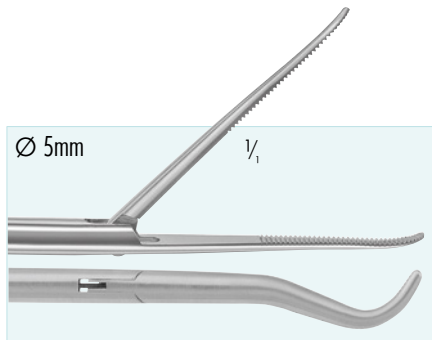

300-400-030

300-430-030

300-440-030

300-460-030

**GEEGEE**  
Dissecting and grasping forceps with fine jaws, strongly curved and fine serrations, **single action**, Ø 5 mm, 330 mm

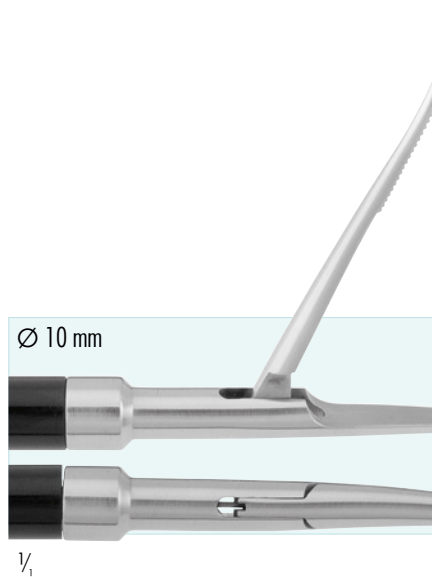

300-400-076

300-430-076

300-440-076

300-460-076

**GEEGEE**  
Dissector and grasping forceps with fine jaws, strongly curved and fine serration, **single action**, Ø 10 mm, 330 mm



insert only  
300-400-720\*

Complete Instrument  
with handle 300-750-003  
300-430-720

Complete Instrument  
with handle 300-750-103  
300-440-720\*

Complete Instrument  
with handle 300-750-105  
300-460-720\*

### SPOON

Forceps with sharp, cup-shaped jaws for tissue or stone removal, **single action**, Ø 10 mm, 330 mm

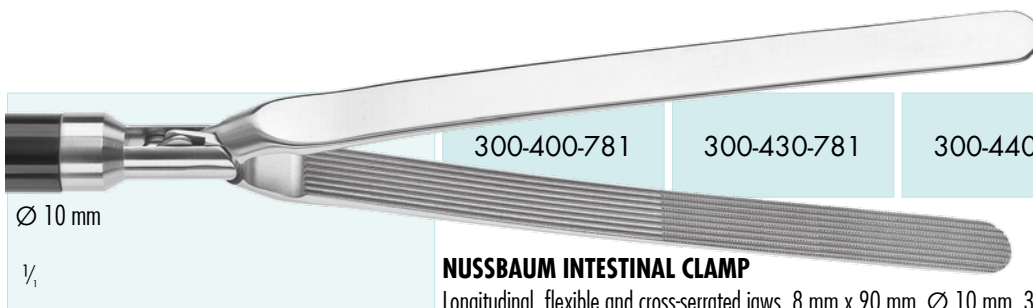

300-400-781

300-430-781

300-440-781

300-460-781

### NUSSBAUM INTESTINAL CLAMP

Longitudinal, flexible and cross-serrated jaws, 8 mm x 90 mm, Ø 10 mm, 330 mm

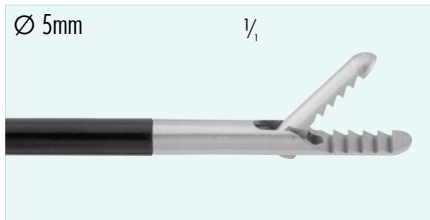

300-400-700

300-430-700

300-440-700

300-460-700

### RETROGRADE

Grasping and extracting forceps with deep retrograde serration for a secure grip of tissue, **single action**, Ø 5mm, 330 mm

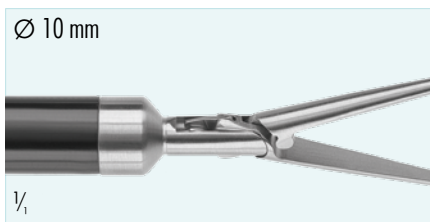

300-400-753\*

300-430-753

300-440-753\*

300-460-753\*

### TENACULUM FORCEPS

35mm long jaws, **double action**, Ø 10 mm, 330 mm

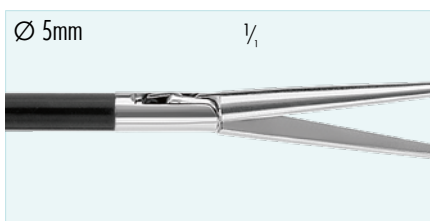

300-400-751\*

300-430-751

300-440-751\*

300-460-751\*

### TENACULUM FORCEPS

35mm long jaws, **double action**, Ø 5mm, 330 mm



Complete Instrument  
with handle 300-750-015

insert only

Ø 5mm

300-400-200\*

300-490-200

1/1

### SATINSKY

Grasping Forceps, 50 mm atraumatic jaws, Ø 5mm, 330 mm

Ø 5mm

300-400-202

300-490-202

1/1

### SATINSKY

Grasping Forceps, 40 mm atraumatic jaws, Ø 5mm, 330 mm

Ø 5mm



300-400-206

300-490-206

1/1

### CRAFOORD

Thorax clamp, 50 mm atraumatic jaws, Ø 5mm, 330 mm

 <p>Ø 5mm</p> <p>1/1</p>	<p>insert only</p> <p>300-400-204</p>	 <p>Complete Instrument with handle 300-750-015</p> <p>300-490-204</p>
	<p><b>CRAFOORD</b> Thorax clamp, 35mm atraumatic jaws, Ø 5mm, 330 mm</p>	

 <p>Ø 5mm</p> <p>1/1</p>	<p>300-400-220*</p>	<p>300-490-220</p>
	<p><b>DEBAKEY</b> Pulmonary atraumatic Clamp, curved shape, Ø 5mm, 330 mm</p>	

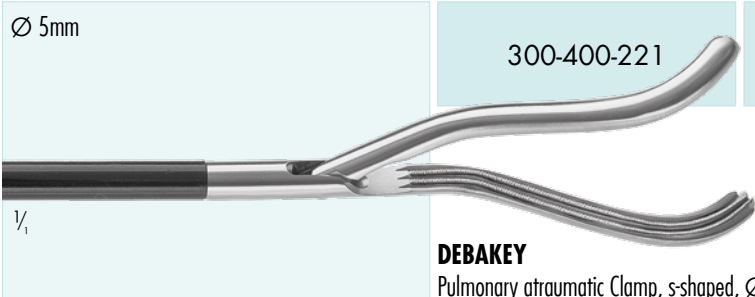
 <p>Ø 5mm</p> <p>1/1</p>	<p>300-400-221</p>	<p>300-490-221</p>
	<p><b>DEBAKEY</b> Pulmonary atraumatic Clamp, s-shaped, Ø 5mm, 330 mm</p>	

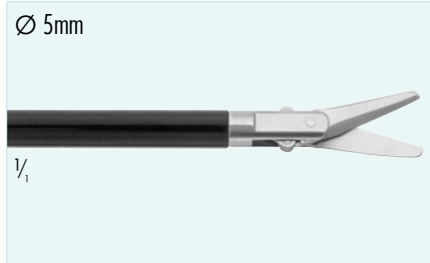

insert only

300-400-067\*



300-410-067



300-420-067\*

### ORIGINAL METZENBAUM

Scissors, short blades (12 mm), slightly curved, double action, Ø 5mm, 330 mm

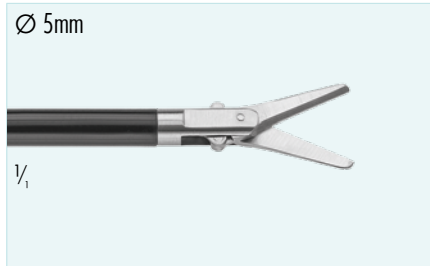

300-400-069\*

300-410-069

300-420-069\*

### METZENBAUM

Scissors, short blades (12 mm), straight, double action, Ø 5mm, 330 mm



300-400-172

300-410-172

300-420-172

### METZENBAUM

Scissors, short, with **Diamond Dusted** blades (12 mm), curved, double action, Ø 5mm, 330 mm



300-400-168

300-410-168

300-420-168

### METZENBAUM

Scissors, medium, with **Diamond Dusted** blades (15mm), straight, double action, Ø 5mm, 330 mm

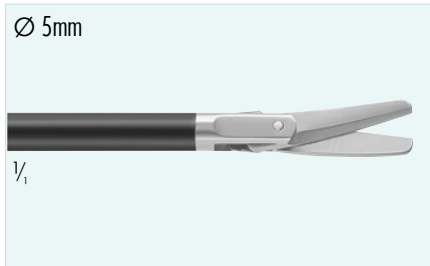

insert only

300-400-072\*



300-410-072



300-420-072\*

### METZENBAUM

Scissors, medium blades (15mm), slightly curved, double action, Ø 5mm, 330 mm

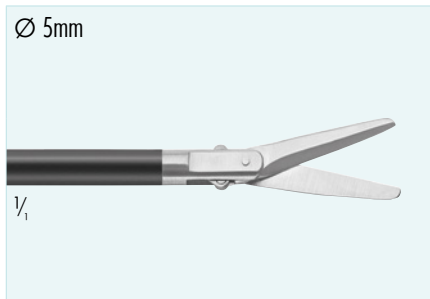

300-400-070\*

300-410-070

300-420-070\*

### METZENBAUM

Scissors, long blades (18 mm), slightly curved, double action, Ø 5mm, 330 mm

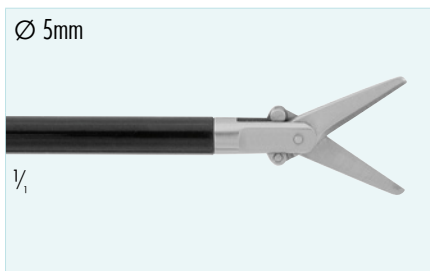

300-400-068\*

300-410-068

300-420-068\*

### METZENBAUM

Scissors, medium blades (15mm), straight, double action, Ø 5mm, 330 mm

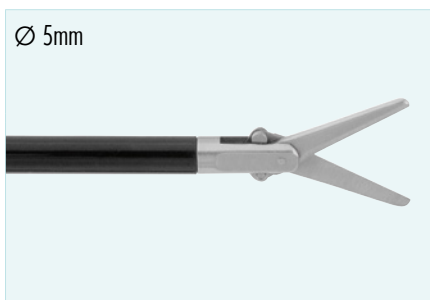

300-400-071

300-410-071

300-420-071

### METZENBAUM

Scissors, long blades (18 mm), straight, double action, Ø 5mm, 330 mm

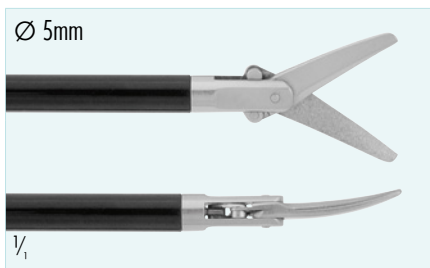

300-400-169

300-410-169

300-420-169

### METZENBAUM

Scissors, medium blades (15mm) coated with **Diamond Dust**, slightly curved, double action, Ø 5mm, 330 mm, **DD-Coating** gives the scissors' blades a more durable cutting performance.

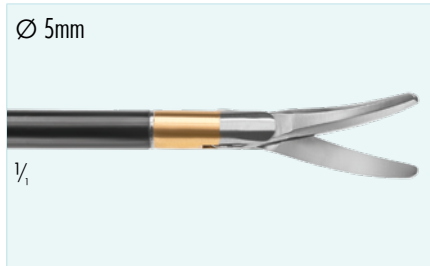

insert only

300-400-170



300-410-170



300-420-170

### TC METZENBAUM

Scissors, long blades (18 mm) with **Tungsten Carbide** inserts, strong curved, double action, Ø 5mm, 330 mm

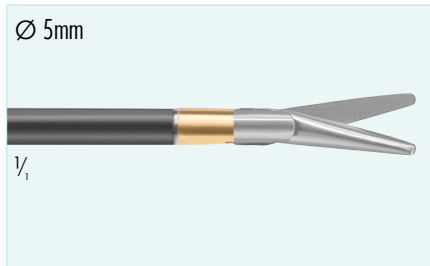

300-400-171

300-410-171

300-420-171

### TC METZENBAUM

Scissors, short blades (12 mm) with **Tungsten Carbide** inserts, slight curved, double action, Ø 5mm, 330 mm

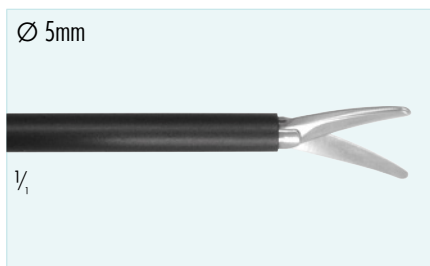

300-400-180

300-410-180

300-420-180

### HINGELESS TC METZENBAUM

Scissors, long blades (18 mm), curved, double action, Ø 5mm, 330 mm, with **Tungsten Carbide** inserts  
For use with shaft 300-660-015 only



300-400-181

300-410-181

300-420-181

### HINGELESS TC METZENBAUM

Scissors, short blades (12 mm), curved, double action, Ø 5mm, 330 mm, with **Tungsten Carbide** inserts  
For use with shaft 300-660-015 only

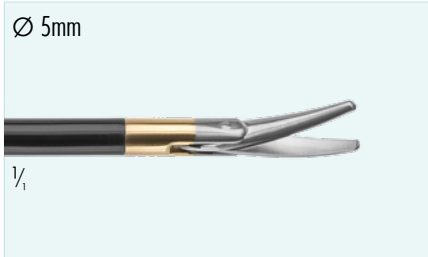

insert only

300-400-173



300-410-173



300-420-173

### METZENBAUM TC

TC Scissors, medium blades (15mm), curved, double action, ∅ 5mm, 330 mm



300-400-065

300-410-064

300-420-064

### METZENBAUM

Scissors, bow shape curved, 16mm blades, fine serrated, double action, ∅ 5mm, 330 mm



300-400-165\*

300-410-165

300-420-165\*

### METZENBAUM TC

TC Scissors, bow shape curved, 16mm blades, fine serrated, double action, ∅ 5mm, 330 mm

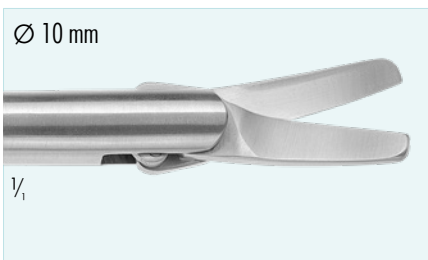

300-400-056

300-410-056

300-420-056

### METZENBAUM

Scissors, slightly curved, double action, ∅ 10 mm, 330 mm

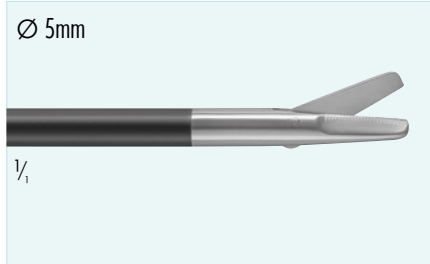

insert only

300-400-063



300-410-063



300-420-063

### PERITONEAL

Scissors, delicate with fine serrated blades, straight, single action, Ø 5mm, 330 mm



300-400-060\*

300-410-060

300-420-060\*

### HOOK

Scissors with round cutting blades, single action, Ø 5mm, 330 mm



300-400-062

300-410-062

300-420-062

### HOOK

Scissors with round cutting blades, fine serrated lower blade, single action, Ø 5mm, 330 mm



insert only

300-400-570



300-410-570

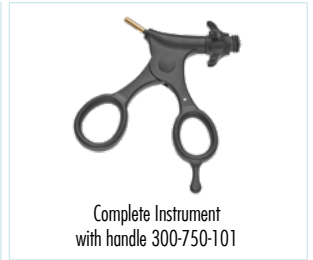

300-420-570

### MICRO

Scissors with straight sharp blades, single action, Ø 5mm, 330 mm



300-400-571

300-410-571

300-420-571

### MICRO

Scissors with curved sharp blades, single action, Ø 5mm, 330 mm

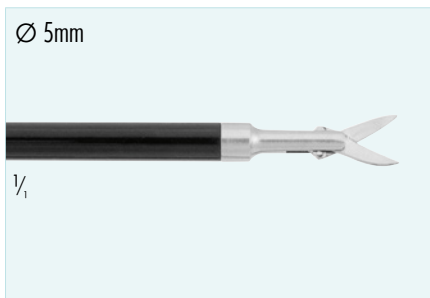

300-400-572

300-410-572

300-420-572

### MICRO

Scissors with curved sharp blades, double action, Ø 5mm, 330 mm



### 4-PIECE ENDO TIP SYSTEM

- Reusable handle and shaft, disposable tip
- Always having a sharp tip
- Ecological and economical - reduces waste and saves budget

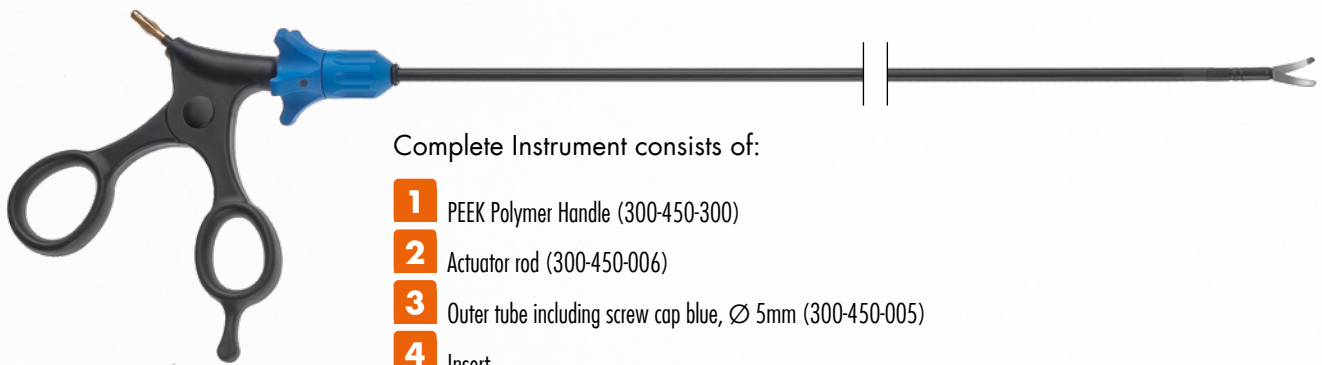

Complete Instrument consists of:

- 1** PEEK Polymer Handle (300-450-300)
- 2** Actuator rod (300-450-006)
- 3** Outer tube including screw cap blue, Ø 5mm (300-450-005)
- 4** Insert

#### **1** PEEK POLYMER HANDLES



300-450-300 PEEK Polymer Handle, blue rotating wheel, without ratchet





The EndoTip system allows to reuse the handle and the sheath of the Instrument, but gives the opportunity to easily change the tip. That provides an always sharp scissors without creating the waste of a complete single use instrument.

4



**METZENBAUM** non-sterile, limited reusable  
 300-450-177 medium, 15mm curved  
 300-450-171 short, 10mm, curved  
 300-450-173 long, 18 mm, curved  
 300-450-174 long, 18 mm, straight  
 300-450-176 medium, 15mm, straight



**JOHANS** Grasper, fenestrated  
 300-450-289 non-sterile (limited reusable)



**MARYLAND** Grasper, curved  
 300-450-731 non-sterile (limited reusable)



**ENDOCLINCH** Grasper, fenestrated  
 300-450-049 non-sterile (limited reusable)

## CHOLANGIOGRAPHY SYSTEM



300-100-760 Cholangiography fixation clamp with channel for 6 Fr. catheters,  
Ø 5mm, 330 mm working length, with ratchet and LuerLock, double action jaws



300-193-330 Guide tube for Cholangiography catheter,  
Ø 5mm, 330 mm working length



### RZ FAN RETRACTORS

- One-piece instrument with flush port
- 50° vertical adjustment
- Available in Ø 5mm and 10mm

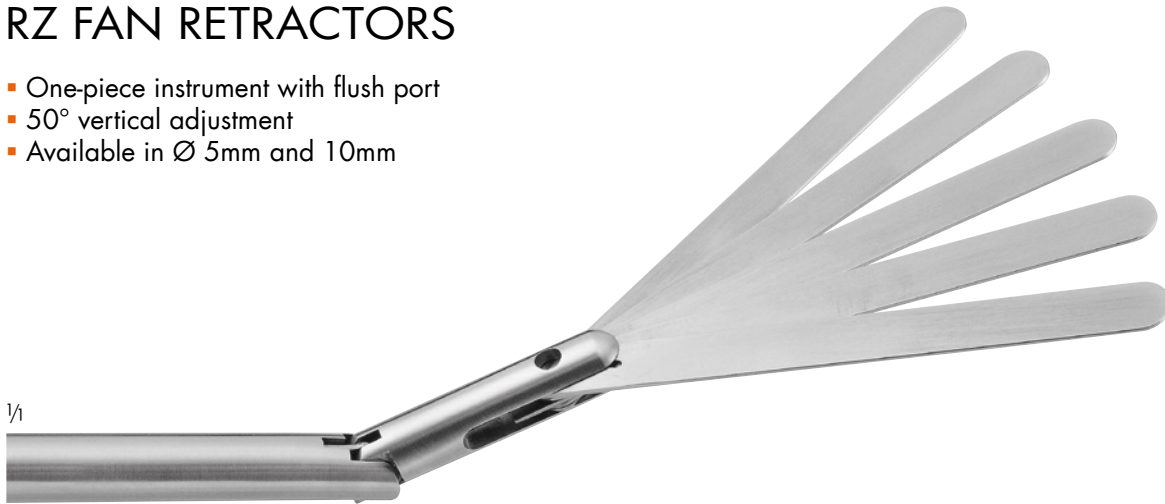

- RZ Fan Retractor, 330mm working length
- 300-065-000\* 10 mm, with 5 prongs
  - 300-063-000\* 5mm, with 3 prongs



- Esophagus Retractor with cleaning port, vertical up 90°, with distal hole
- 300-099-033 5mm, 330 mm working length
  - 300-099-100 5mm, 440 mm working length
  - 300-099-133 10 mm, 330 mm working length
  - 300-099-140 10 mm, 440 mm working length



- 300-065-100 Advanced Fan Retractor, 10 mm, 5 prongs,  
angulation: max. 80°, spread: max. 60°, length: 330 mm

### ARTICULATING LAPAROSCOPIC RETRACTORS & BAND-PASSER

- 5mm shaft
- For use with 5.0 or 5.5mm trocars
- With LuerLock



Carbon handle with overload protection



Atraumatic segments, jamming is prevented



The nitinol wire straightens the working end to allow easy introduction and extraction

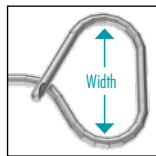

#### TRIANGULAR

Straight	Width	Working length	
	60mm	330mm	300-069-000*
	60mm	450mm	300-069-450
	80mm	330mm	300-070-000*
	80mm	450mm	300-070-450

30° angled	Width	Working length	
	60mm	330mm	300-072-000*
	60mm	450mm	300-072-450
	80mm	330mm	300-073-000*
	80mm	450mm	300-073-450*

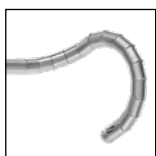

#### HOOK

90° upwards	Shape	Working length	
	Curved right	340mm	300-075-001
	Curved left	340mm	300-075-002

45° angled	Shape	Working length	
	Curved right	340mm	300-075-101
	Curved left	340mm	300-075-102

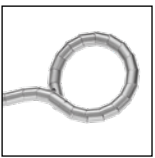
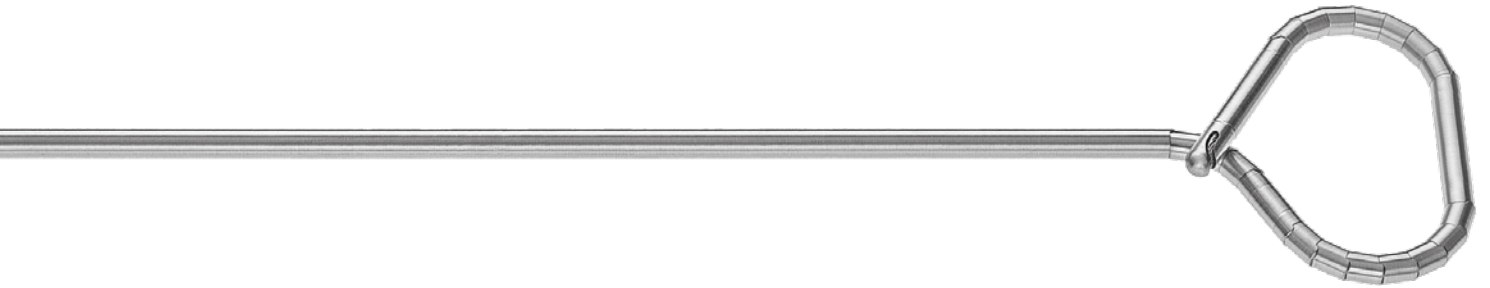

### CIRCLE

	Width	Working length	
Straight	40mm	340mm	300-076-001
Angled	40mm	340mm	300-076-101

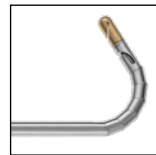

### BAND-PASSER

Working length	
330mm	300-071-000*
450mm	300-071-450*



### J-RETRACTOR

Working length	
340mm	300-077-000

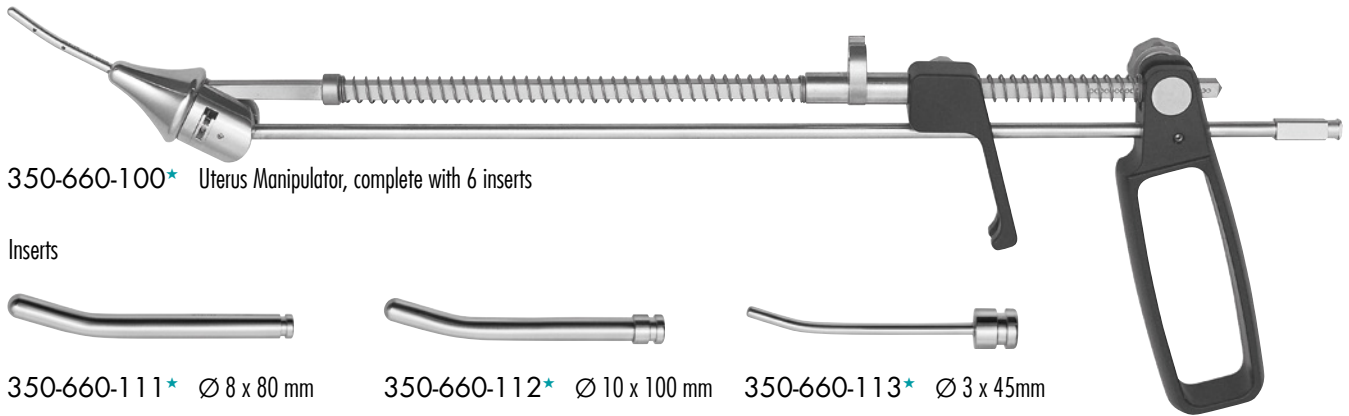

350-660-100\* Uterus Manipulator, complete with 6 inserts

Inserts



350-660-111\* Ø 8 x 80 mm



350-660-112\* Ø 10 x 100 mm



350-660-113\* Ø 3 x 45mm



350-660-114\* Ø 3 x 55mm



350-660-115\* Ø 3.2 x 35mm



350-660-116\* Ø 3.2 x 45mm



### COHEN

Self retaining Cannula complete with 2 interchangeable acorns  
350-750-000\*

Acorn only  
350-750-002 large  
350-750-001 small

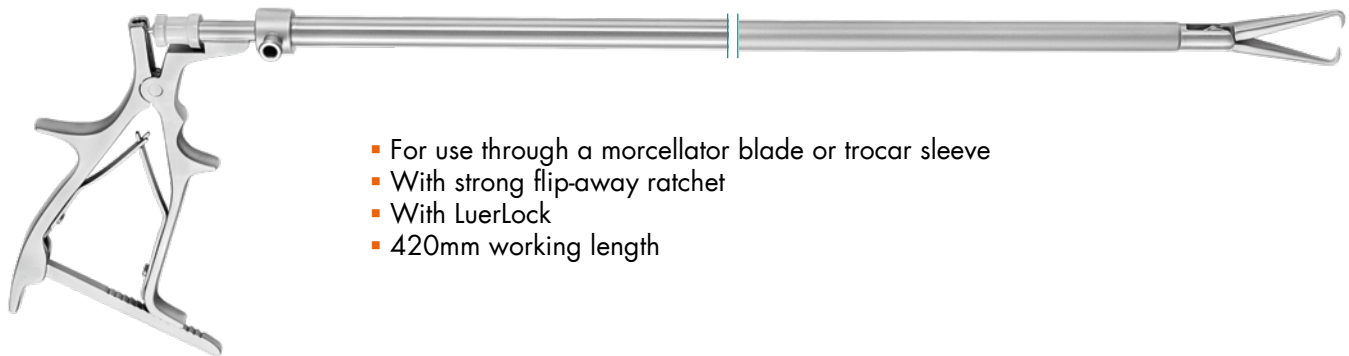

- For use through a morcellator blade or trocar sleeve
- With strong flip-away ratchet
- With LuerLock
- 420mm working length



300-110-714  
Tenaculum Forceps, Ø10mm



300-110-711  
Claw Forceps, Ø10mm

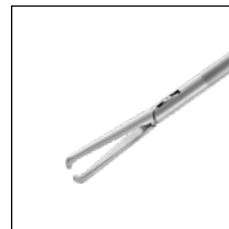

300-110-715  
Tenaculum Forceps, Ø5mm



**MANGESHIKAR**  
Uterus Manipulator, complete set  
350-740-000

Set consisting of:



Universal Handle, rotatable  
350-740-001



Shaft with fixation nut  
350-740-002



Inner shaft with locking pin  
350-740-003



Cervical Tenaculum  
350-740-008



Sliding and fixation shaft  
350-740-004



Tube with insulation ring  
350-740-005 35mm  
350-740-006 40mm  
350-740-007 45mm



Intrauterus tip insert  
350-740-040 4x40mm  
350-740-050 5x50mm  
350-740-060 6x60mm  
350-740-070 7x70mm  
350-740-080 8x80mm

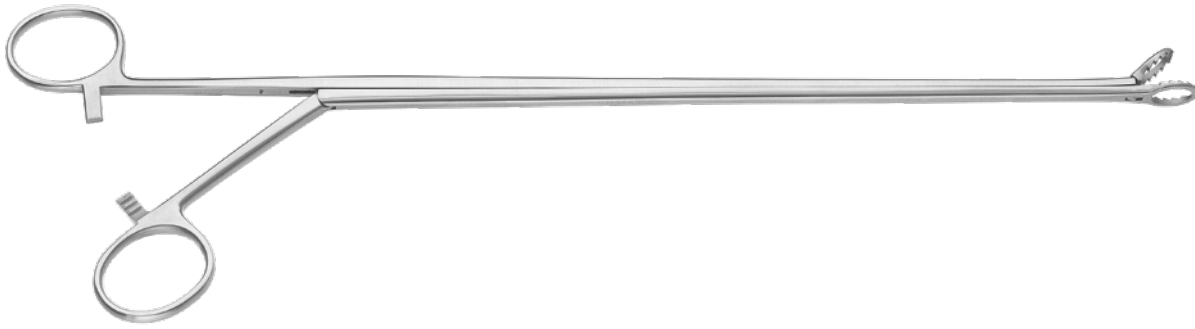

RZ Myoma Grasping Forceps, 330 mm working length  
 350-755-007 7 mm jaws  
 350-755-011\* 11 mm jaws  
 350-755-017 17 mm jaws

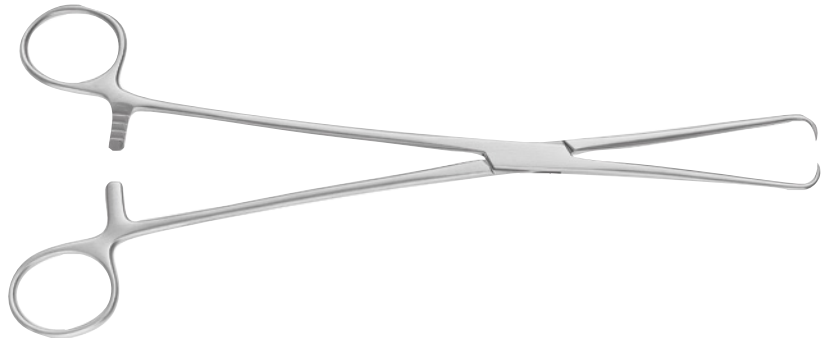

350-400-250\* **SCHROEDER** tenaculum forceps



Myoma screw  
 300-032-015\* Ø 5mm, 330mm working length  
 300-042-005 Ø 5mm, 420mm working length  
 300-033-010 Ø 10mm, 330mm working length  
 300-042-010 Ø 10mm, 420mm working length

## RZ RING APPLICATORS

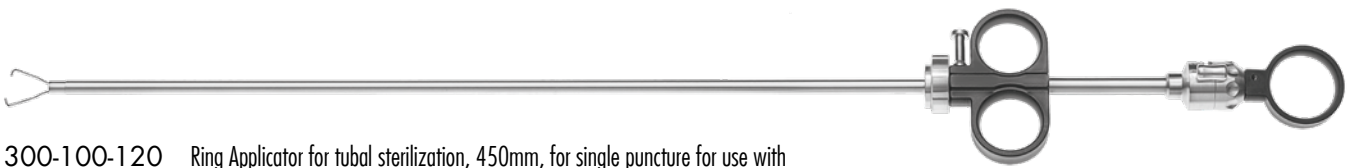

300-100-120 Ring Applicator for tubal sterilization, 450mm, for single puncture for use with operating Laparoscopes with Ø 6mm instrument channels (300-099-006).



300-100-122\* Ring Applicator for Tubal Sterilisation, 330mm, for second puncture, for use with Trocar sleeves Ø 7.0mm



300-100-125 Cone for Ring Applicator



300-100-127 Loading Device for Ring Applicator

# CLIP APPLYING BULLDOG CLAMPS NEEDLE HOLDERS

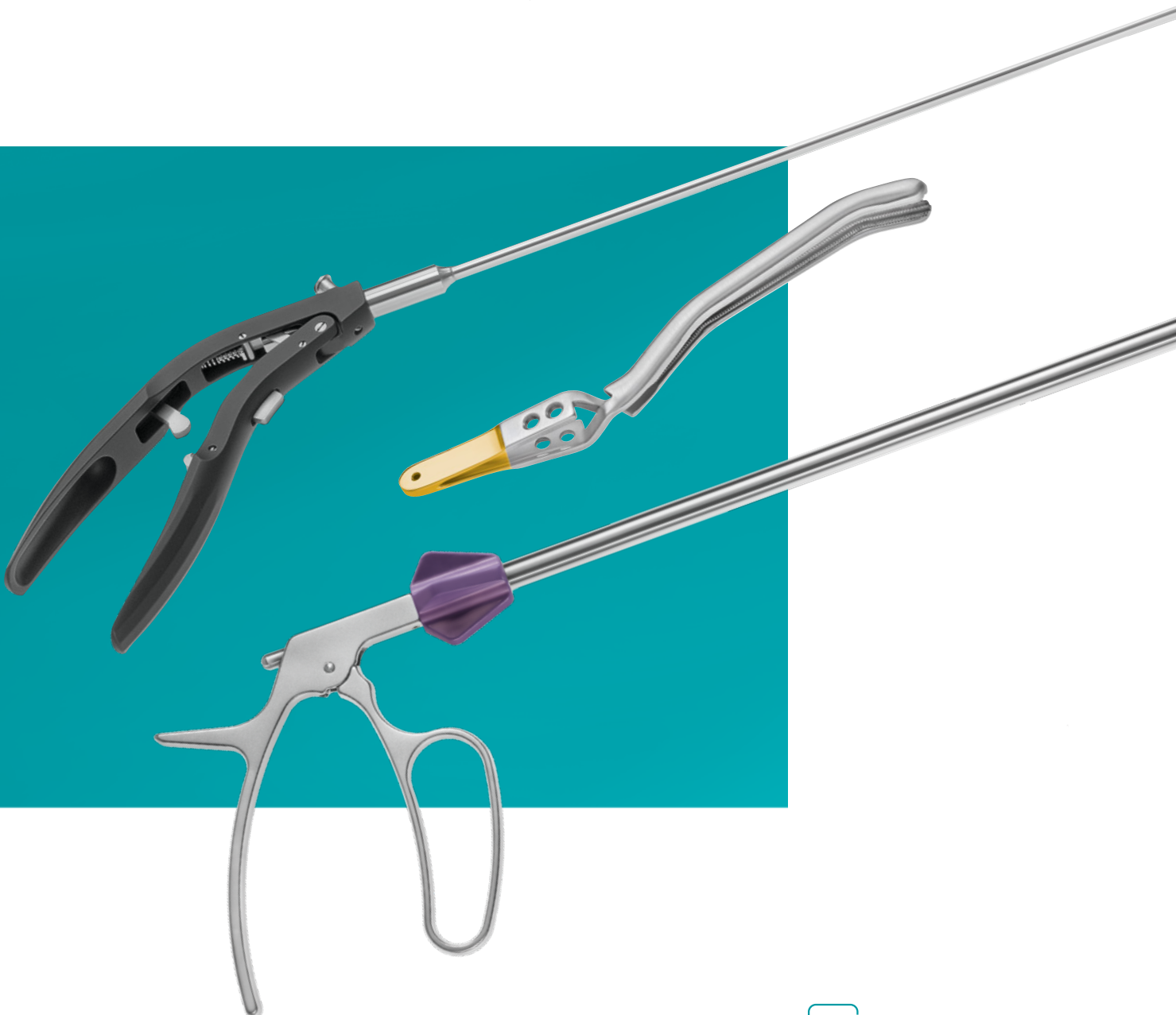

### ENDOSCOPIC CLIP APPLYING FORCEPS - TITAN CLIPS

- 360° rotatable
- Color-coded
- Detachable and non-detachable models



TYPE ETHICON, TITANIUM

Size / color code	detachable, 330mm	A insert only, 330mm	B shaft only
∅ 5mm S (blue) ■	300-810-001	300-810-101	300-830-010
∅ 5mm M (white) □	300-810-002	300-810-102	300-830-010
∅ 10mm M/L (green) ■	300-810-004*	300-810-104	300-830-010
∅ 10mm L (yellow) ■	300-810-006*	300-810-106	300-830-010

Size / color code	detachable, 450mm	A insert only, 450mm	B shaft only
∅ 5mm S (blue) ■	300-810-401	300-810-501	300-830-410
∅ 5mm M (white) □	300-810-402	300-810-502	300-830-410
∅ 10mm M/L (green) ■	300-810-404	300-810-504	300-830-410
∅ 10mm L (yellow) ■	300-810-406	300-810-506	300-830-410



Size / color code	non detachable, 330mm	non detachable, 450mm
∅ 5mm S (blue) ■	300-800-001	300-800-401
∅ 5mm M (white) □	300-800-002	300-800-402
∅ 10mm M/L (green) ■	300-800-004*	300-800-404
∅ 10mm L (yellow) ■	300-800-006*	300-800-406

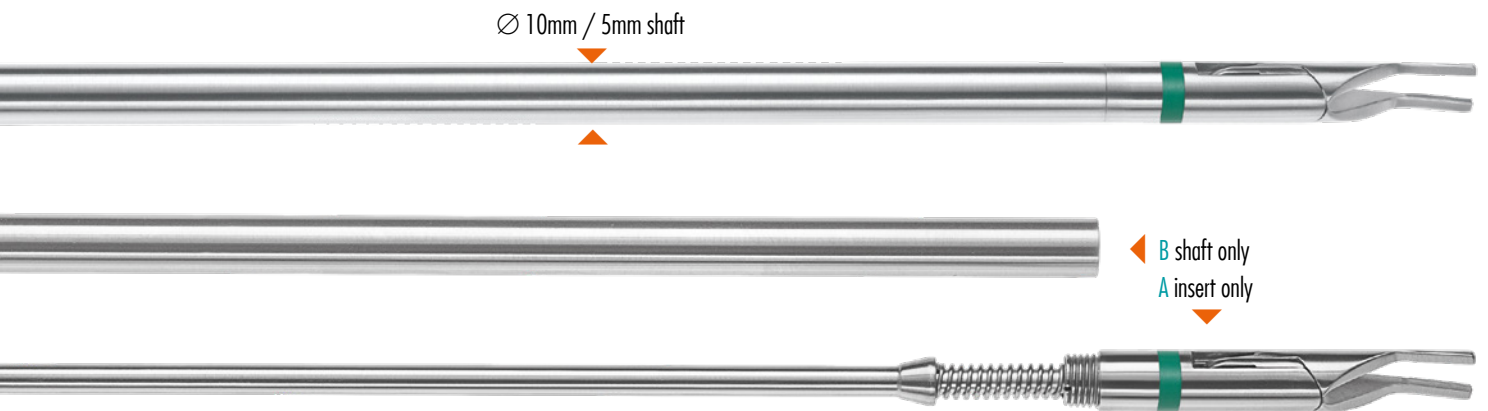

### TYPE HORIZON, TITANIUM





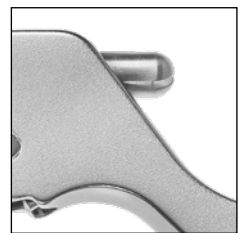

Titan Clips, Ethicon and Horizon type

Size / color code	detachable, 330mm	A insert only, 330mm	B shaft only
Ø 5mm S (yellow) 	300-810-011	300-810-111	300-830-010
Ø 5mm M (blue) 	300-810-012	300-810-112	300-830-010
Ø 10mm M/L (green) 	300-810-014	300-810-114	300-830-010
Ø 10mm L (orange) 	300-810-016	300-810-116	300-830-010





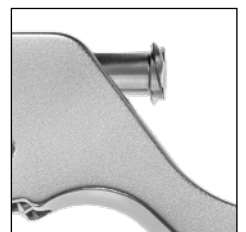

Detachable Forceps without LuerLock

Size / color code	detachable, 450mm	A insert only, 450mm	B shaft only
Ø 5mm S (yellow) 	300-810-411	300-810-511	300-830-410
Ø 5mm M (blue) 	300-810-412	300-810-512	300-830-410
Ø 10mm M/L (green) 	300-810-414	300-810-514	300-830-410
Ø 10mm L (orange) 	300-810-416	300-810-516	300-830-410



Non-detachable Forceps with LuerLock

Size / color code	non detachable, 330mm	non detachable, 450mm
Ø 5mm S (yellow) 	300-800-011	300-800-411
Ø 5mm M (blue) 	300-800-012	300-800-412
Ø 10mm M/L (green) 	300-800-014	300-800-414
Ø 10mm L (orange) 	300-800-016	300-800-416

### ENDOSCOPIC CLIP APPLYING FORCEPS - POLYMER CLIPS

- 360° rotatable
- Color-coded
- Detachable and non-detachable models

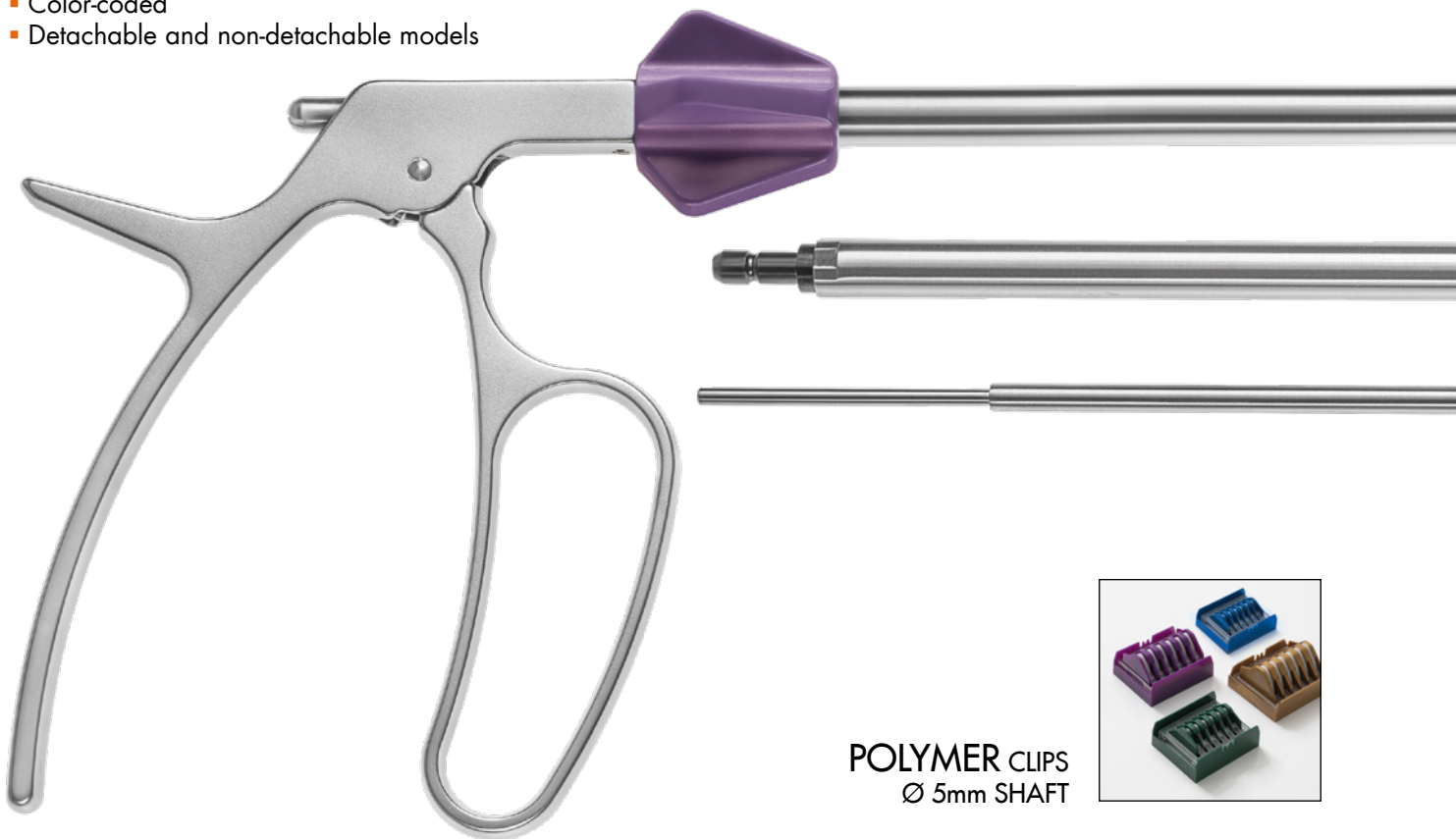

**POLYMER CLIPS**  
Ø 5mm SHAFT

Size / color code	detachable, 330mm	A insert only, 330mm	B shaft only
M (blue) ■	300-830-051	300-830-151	300-830-005
M/L (green) ■	300-830-052	300-830-152	300-830-005

#### Ø 10mm SHAFT

Size / color code	detachable, 330mm	A insert only, 330mm	B shaft only
L (purple) ■	300-830-013	300-830-113	300-830-010
XL (yellow) ■	300-830-014	300-830-114	300-830-010

#### Ø 5mm SHAFT

Size / color code	detachable, 450mm	A insert only, 450mm	B shaft only
M (blue) ■	300-830-451	300-830-551	300-830-405
M/L (green) ■	300-830-452	300-830-552	300-830-405

#### Ø 10mm SHAFT

Size / color code	detachable, 450mm	A insert only, 450mm	B shaft only
L (purple) ■	300-830-413	300-830-513	300-830-410
XL (yellow) ■	300-830-414	300-830-514	300-830-410

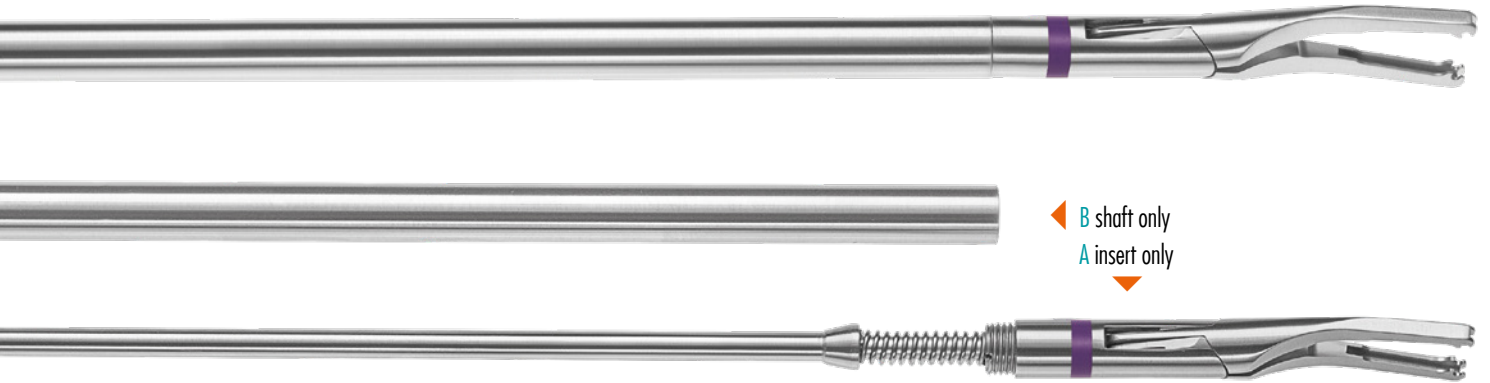

### Ø 5mm SHAFT

Size / color code	non-detachable, 330mm	non-detachable, 450mm
M (blue) <span style="color: blue;">■</span>	300-820-051	300-820-451
M/L (green) <span style="color: green;">■</span>	300-820-052*	300-820-452*

### Ø 10mm SHAFT

Size / color code	non-detachable, 330mm	non-detachable, 450mm
L (purple) <span style="color: purple;">■</span>	300-820-013*	300-820-413*
XL (yellow) <span style="color: yellow;">■</span>	300-820-014*	300-820-414*

Polymer Clips  
Applying Forceps



Detachable Forceps  
without LuerLock



Non-detachable Forceps  
with LuerLock

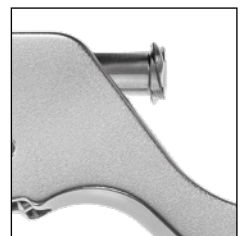

### POLYMER CLIP REMOVING FORCEPS

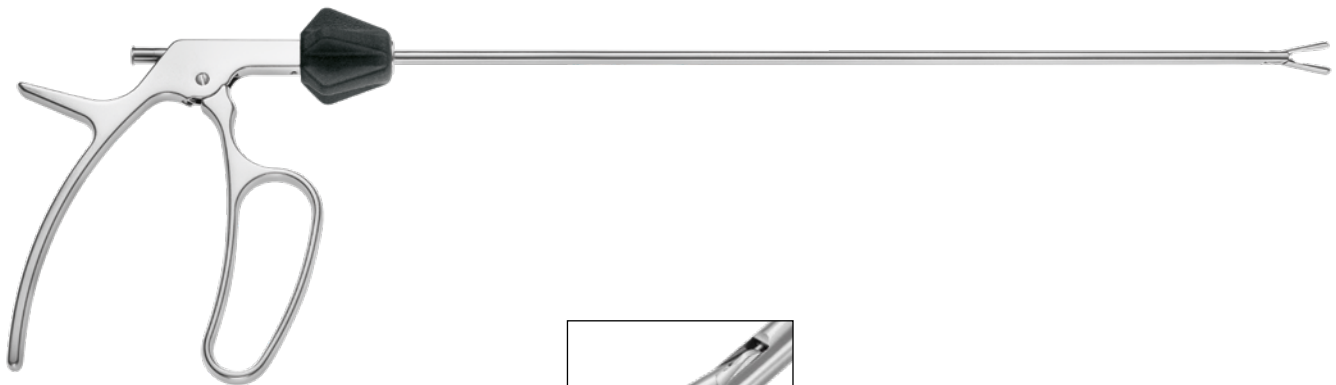

Ø 5mm SHAFT



Polymer Clips Removal Forceps

Size / color code	detachable, 330mm	insert only, 330mm	shaft only
M & M/L (black) ■	300-830-056	300-830-156	300-830-005

Ø 10mm SHAFT

Size / color code	detachable, 330mm	insert only, 330mm	shaft only
L & XL (black) ■	300-830-015	300-830-115	300-830-010

Ø 5mm SHAFT

Size / color code	detachable, 450mm	insert only, 450mm	shaft only
M & M/L (black) ■	300-830-456	300-830-556	300-830-405

Ø 10mm SHAFT

Size / color code	detachable, 450mm	insert only, 450mm	shaft only
L & XL (black) ■	300-830-415	300-830-515	300-830-410

Ø 5mm SHAFT

Size / color code	non detachable, 330mm	non detachable, 450mm
M & M/L (black) ■	300-820-056*	300-820-456

Ø 10mm SHAFT

Size / color code	non detachable, 450mm	non detachable, 450mm
L & XL (black) ■	300-820-015*	300-820-415



Detachable Forceps without LuerLock

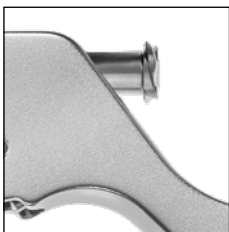

Non-detachable Forceps with LuerLock

### ENDOSCOPIC BULLDOG CLAMP APPLIER

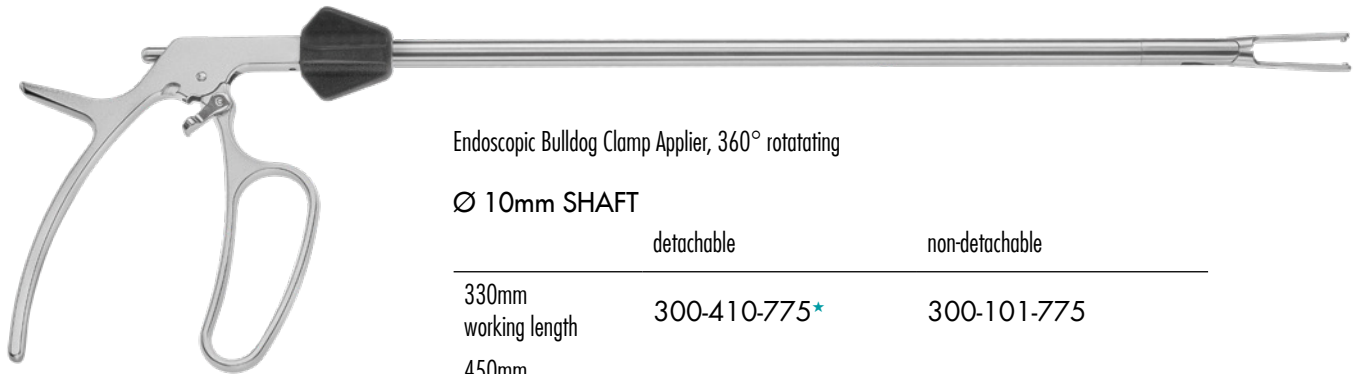

Endoscopic Bulldog Clamp Applier, 360° rotating

Ø 10mm SHAFT

	detachable	non-detachable
330mm working length	300-410-775*	300-101-775
450mm working length	300-411-775	300-111-775



Shaft only, for detachable Bulldog Clamp Applier

300-830-010 330 mm working length  
300-830-410 450 mm working length



Insert only, for detachable Bulldog Clamp Applier

300-400-775 330 mm working length  
300-401-775 450 mm working length



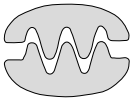

2 x 3 rows of teeth



Endoscopic Vascular Bulldog Clamp, straight, with DeBakey serration

300-100-773\* 17 mm jaws

300-100-774\* 25mm jaws



Endoscopic Bulldog Clamp for bowel surgery, straight, with DeBakey serration

300-100-771\* 45mm jaws

300-100-772\* 60 mm jaws



Endoscopic Vascular Bulldog Clamp, curved, with DeBakey serration

300-100-776 17 mm jaws

300-100-777\* 25mm jaws



Endoscopic Bulldog Clamp for bowel surgery, curved, with DeBakey serration

300-100-778\* 45mm jaws

300-100-779 60 mm jaws



Endoscopic Satinsky Bulldog Clamp, with DeBakey serration golden spring, to be used with 12.5mm trocar system

300-100-786 60 mm jaws



300-100-789 60 mm jaws

Endoscopic Satinsky Bulldog Clamp, curved, with atraumatic DeBakey serration, to be used with 12.5mm trocar system

### Endoscopic Bulldog Clamps with DeBakey serration

- Secure holding of tissue structure
- Occlusion of vessel and other tissue without an additional port
- Atraumatic cross clamping of the colon
- 450-475g closing pressure (300-100-771 - 779)

## ROBOTIC BULLDOG CLAMP

- Specifically designed for use with robotic surgical system
- Single surgeon placement via Pro-Grasp® instrument
- Full control for optimal clamp placement
- Atraumatic DeBakey clamp design
- Introduced through 12.5mm cannula
- Suture hole for easy retrieval



Robotic Bulldog Clamp, bayonet shape,  
with suture hole, blunt teeth  
500g closing pressure  
300-100-799\* 30mm  
300-100-798\* 25mm

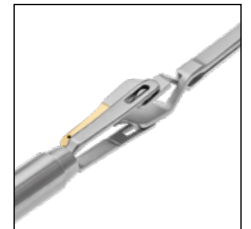

300-101-777  
Robotic Bulldog Clamp Remover  
Ø 10mm, rotatable, with LuerLock

## TITANIUM ARTERIAL &amp; VENOUS BULLDOG CLAMPS

- Different pressure color coding (A-Artery / V-Vein)
- Lightweight
- Non-magnetic
- Highest biocompatibility and corrosion resistance
- Mechanical strength
- DeBaKey serration



CLOSING PRESSURE

300 - 375g



Titanium Bulldog Clamp, straight, Code V (Vein),  
blue

300-100-773TV	17mm jaw
300-100-774TV	25mm jaw
300-100-771TV	45mm jaw
300-100-772TV	60mm jaw



CLOSING PRESSURE

475 - 500g



Titanium Bulldog Clamp, straight, Code A (Artery), red

300-100-773TA	17mm jaw
300-100-774TA	25mm jaw
300-100-771TA	45mm jaw
300-100-772TA	60mm jaw

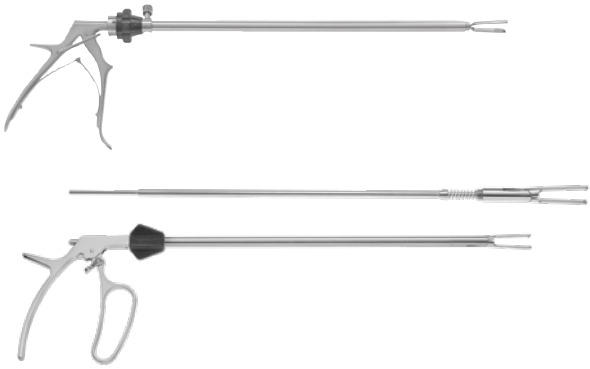

Applier recommendation:  
300-101-775  
300-410-775 (detachable)



### DETACHABLE NEEDLE HOLDERS

- Detachable 2- and 3-part system
- Easy cleaning
- Handle can be used with different inserts

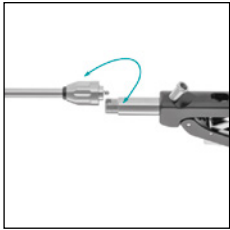

Detachable shaft from handle:  
convertible system, better  
cleaning possibilities

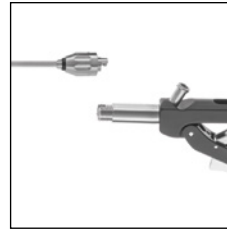

2-piece system:  
An extra thin  $\varnothing$  3mm System  
with 250mm and 330mm length  
for Pediatric and Mini-Laparoscopy

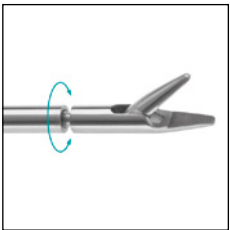

Secure screwing on the insert:  
Perfect fit of the insert and  
single cleaning  
(only 3-piece system)

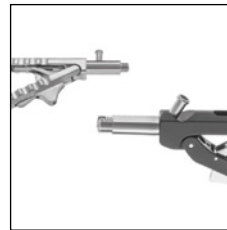

Modular handles:  
Axial and straight handles  
available to fulfill the surgeon's  
needs and provide ergonomical  
comfort

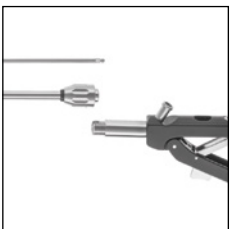

3-piece system:  
Needle holder can be fitted  
with different shafts and  
inserts, different lengths  
available

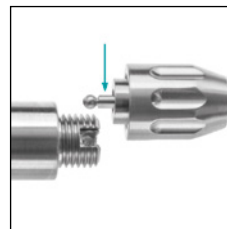

Anti-rotation feature:  
due to an extra rectangular  
connector, wrong insertion of  
the insert is excluded

### 3-PIECE INSTRUMENT $\varnothing$ 5mm

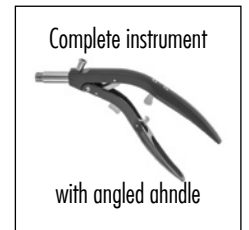
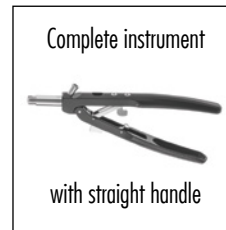
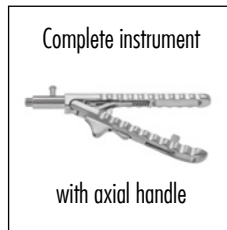
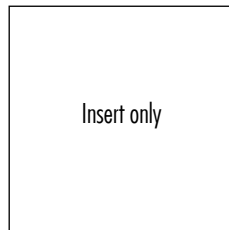
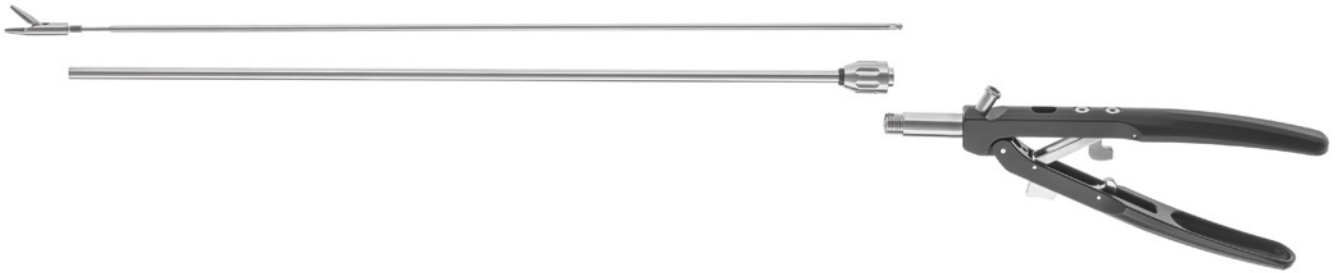

Straight jaw, TC

330mm 300-405-130  
450mm 300-406-130

300-480-630  
300-480-730

300-480-130  
300-480-230

300-480-160  
300-480-260



Left curved jaw, TC

330mm 300-405-140  
450mm 300-406-140

300-480-640  
300-480-740

300-480-140  
300-480-240

300-480-170  
300-480-270



Right curved jaw, TC

330mm 300-405-141  
450mm 300-406-141

300-480-641  
300-480-741

300-480-141  
300-480-241

300-480-171  
300-480-271



Diamond dusted jaw,  
self-aligning

330mm 300-405-142  
450mm 300-406-142

300-480-642  
300-480-742

300-480-142  
300-480-242

300-480-172  
300-480-272



1x2 teeth jaw, TC

330mm 300-405-131  
450mm 300-406-131

300-480-631  
300-480-731

300-480-131  
300-480-231

300-480-161  
300-480-261

## SINGLE PARTS FOR DETACHABLE NEEDLE HOLDER



Axial Handle, strong, straight  
300-480-002



Axial Handle, straight  
300-480-000



Axial Handle, angled  
300-480-001



Outer Sheath, for combination with  
shaft and insert, three-pieces

330mm      300-480-033  
450mm      300-480-045

### 2-PIECE INSTRUMENT $\varnothing$ 3mm



<p>Insert and shaft</p>	<p>Complete instrument with straight handle</p>	<p>Complete instrument with angled handle</p>
-------------------------	---	---



250mm  
330mm

Straight jaw

300-405-330  
300-404-330

300-480-330  
300-480-530

300-480-360  
300-480-560



250mm  
330mm

Left curved jaw

300-405-340  
300-404-340

300-480-340  
300-480-540

300-480-370  
300-480-570



250mm  
330mm

Right curved jaw

300-405-341  
300-404-341

300-480-341  
300-480-541

300-480-371  
300-480-571

### 1-PIECE NEEDLE HOLDER

- Extremely light
- Aluminium anodized handle



Lightweight design with satin black surface

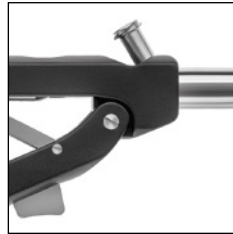

65° LuerLock flushing port for optimal accessibility

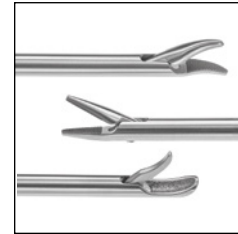

5 different jaw designs available



Rubber sealing cap included



6-tooth ratchet for always optimal positioning, with overload protection



Straight



Left curved

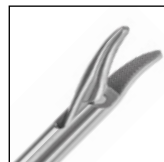

Right curved



1x2 teeth



Concave/convex



### Ø 5mm STRAIGHT HANDLE

300-300-130*	straight	TC serrated	330mm
300-300-131	straight, 1x2 teeth	TC serrated	330mm
300-300-140*	left curved	TC serrated	330mm
300-300-141 *	right curved	TC serrated	330mm
300-300-142*	concave/convex	diamond dusted	330mm
300-300-230	straight	TC serrated	450mm
300-300-231	straight, 1x2 teeth	TC serrated	450mm
300-300-240	left curved	TC serrated	450mm
300-300-241	right curved	TC serrated	450mm
300-300-242	concave/convex	diamond dusted	450mm

### Ø 5mm ANGLED HANDLE

300-300-160*	straight	TC serrated	330mm
300-300-161	straight, 1x2 teeth	TC serrated	330mm
300-300-170*	left curved	TC serrated	330mm
300-300-171 *	right curved	TC serrated	330mm
300-300-172*	concave/convex	diamond dusted	330mm
300-300-260	straight	TC serrated	450mm
300-300-261	straight, 1x2 teeth	TC serrated	450mm
300-300-270	left curved	TC serrated	450mm
300-300-271	right curved	TC serrated	450mm
300-300-272	concave/convex	diamond dusted	450mm

### Ø 3mm STRAIGHT HANDLE

300-300-330	straight	TC serrated	330mm
300-300-340	left curved	TC serrated	330mm
300-300-341	right curved	TC serrated	330mm
300-300-430	straight	TC serrated	450mm
300-300-440	left curved	TC serrated	450mm
300-300-441	right curved	TC serrated	450mm

### Ø 3mm ANGLED HANDLE

300-300-360	straight	TC serrated	330mm
300-300-370	left curved	TC serrated	330mm
300-300-371	right curved	TC serrated	330mm
300-300-460	straight	TC serrated	450mm
300-300-470	left curved	TC serrated	450mm
300-300-471	right curved	TC serrated	450mm

## STAINLESS STEEL NEEDLE HOLDERS

- Automatic mechanism
- Smoothly releasing interlock



Smooth release lock, very robust handle design

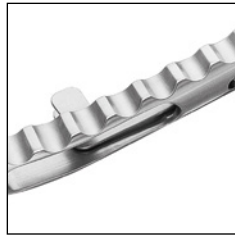

Ergonomic and reliable handle design

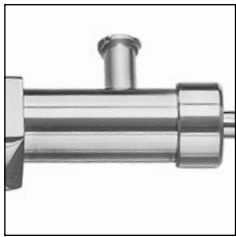

Straight LuerLock flushing port (sealing cap included)



Straight



Left curved



Right curved



Diamond dusted, self aligning



### Ø 5mm STRAIGHT HANDLE

300-100-694*	right curved	330mm	serration TC
300-100-695*	straight	330mm	serration TC
300-100-696*	left curved	330mm	serration TC
300-100-697	straight	450mm	serration TC
300-100-698	left curved	450mm	serration TC
300-100-699	right curved	450mm	serration TC
300-100-702	straight	330mm	diamond dusted
300-100-703	straight	450mm	diamond dusted

### Ø 3mm STRAIGHT HANDLE

300-100-687	left curved	250mm	serration TC
300-100-688	right curved	250mm	serration TC
300-100-689	straight	250mm	serration TC
300-100-691	left curved	330mm	serration TC
300-100-692	right curved	330mm	serration TC
300-100-693	straight	330mm	serration TC

## WERNER NEEDLE HOLDERS

- Detachable and single-piece option
- 3-piece model for efficient cleaning

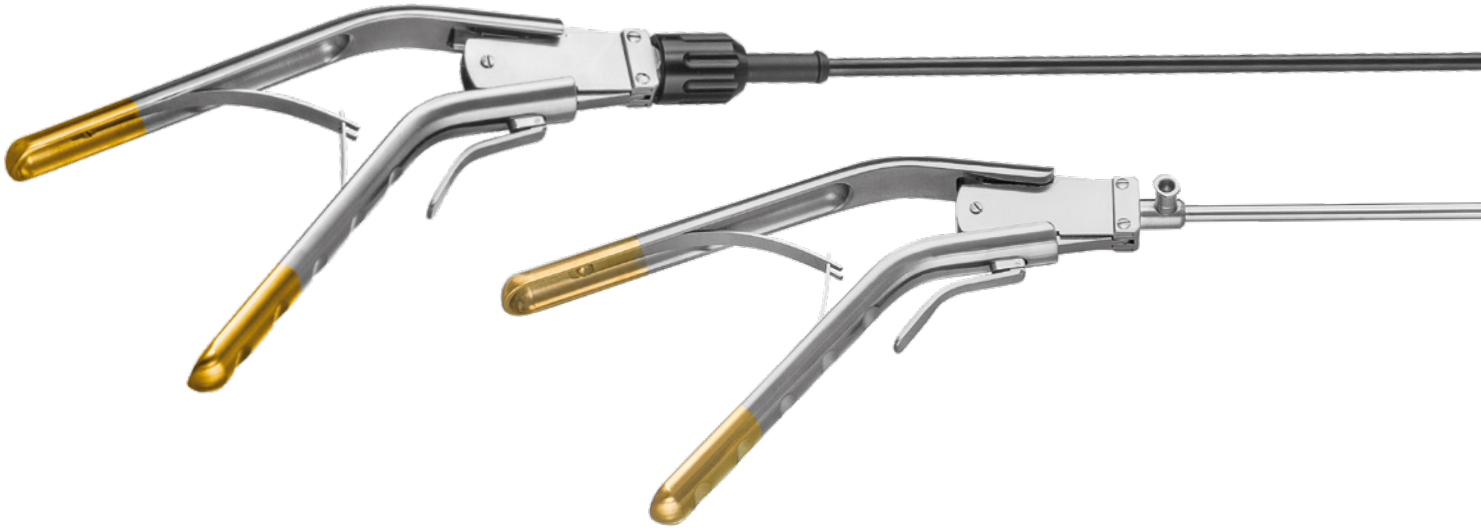

Ergonomic axial handle design  
for effortless working

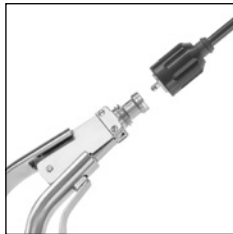

Detachable 3-piece system



Smooth and ergonomic ratchet

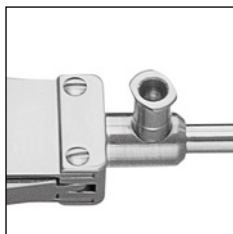

Straight LuerLock flushing port  
(sealing cap included)



### Ø 5mm DETACHABLE

300-300-001	straight	TC serrated	330mm
300-300-101	left curved	TC serrated	330mm
300-300-201	right curved	TC serrated	330mm
300-300-501	convex/concave	toothed	330mm
300-302-001	straight	TC serrated	450mm
300-302-101	left curved	TC serrated	450mm
300-302-201	right curved	TC serrated	450mm
300-302-501	convex/concave	toothed	450mm

### Ø 5mm SINGLE-PIECE

300-300-000	straight	TC serrated	330mm
300-300-100	left curved	TC serrated	330mm
300-300-200	right curved	TC serrated	330mm
300-300-500	convex/concave	toothed	330mm
300-302-000	straight	TC serrated	450mm
300-302-100	left curved	TC serrated	450mm
300-302-200	right curved	TC serrated	450mm

### Ø 3mm DETACHABLE

300-303-001	straight	TC serrated	330mm
300-303-101	left curved	TC serrated	330mm
300-303-201	right curved	TC serrated	330mm
300-303-501	convex/concave	toothed	330mm

### Ø 3mm SINGLE-PIECE

300-303-000	straight	TC serrated	330mm
300-303-100	left curved	TC serrated	330mm
300-303-200	right curved	TC serrated	330mm
300-303-500	convex/concave	toothed	330mm

### TC ENDOSCOPIC NEEDLE HOLDER

- Axial ring handle
- For intra- & extracorporeal suturing
- Jaw with TC inserts: firm & reliable grip of suturing needles, long lifetime of the needle holder
- Ø 5mm

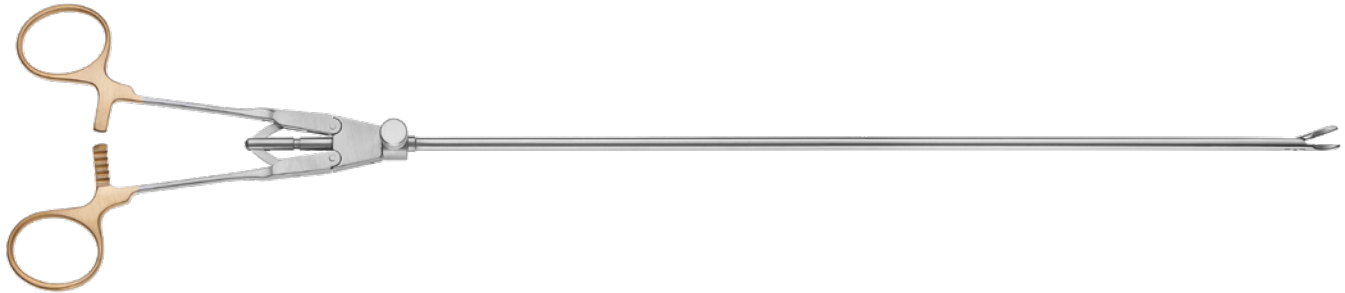

330mm

450mm



Curved left

300-101-588\*

300-101-589



Curved right

300-101-592

300-101-599



Straight jaw

300-101-594\*



Bullnose, straight jaw

300-101-596\*

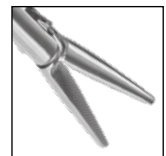
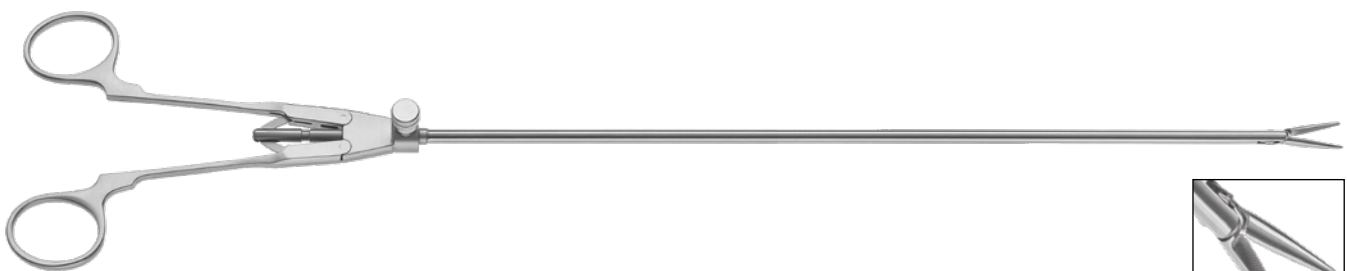

300-332-320 **LIONS** Needle forceps Ø 5mm, 330 mm without ratchet, with LuerLock, double-action

## ROMEO DIAMOND DUSTED NEEDLE HOLDER

- Auto-aligning of needles
- Concave shaped jaw: aligns curved endoscopic needles by itself in 90° position to the jaw's horizontal line
- Diamond dusted jaw: keeps needle securely in place
- Ø 5mm

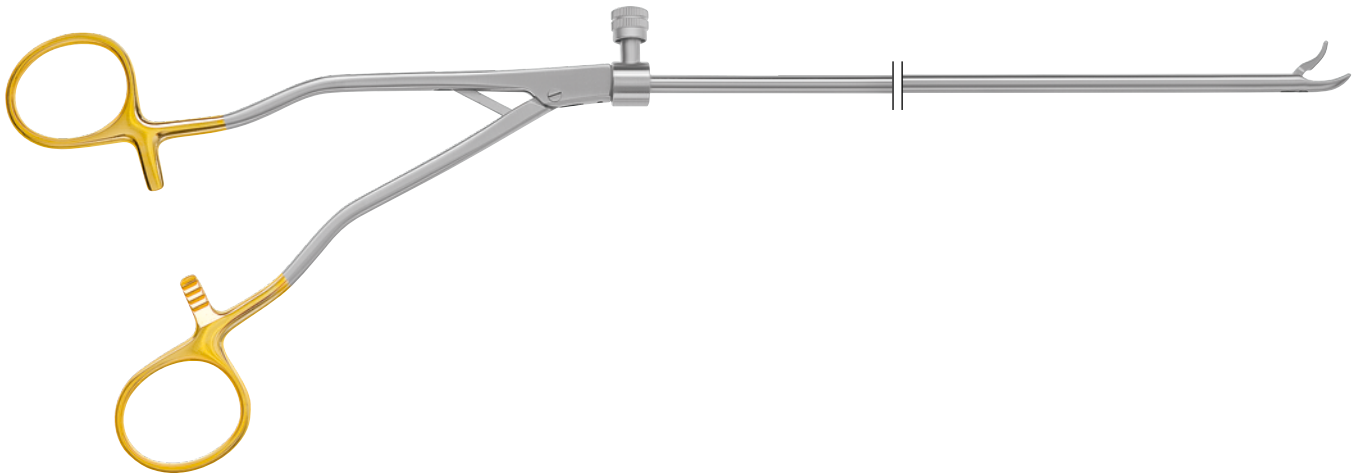

360mm





Parrot design jaw

300-101-593

### MATHIEU TC ENDOSCOPIC NEEDLE HOLDER

- For intra- & extracorporal suturing
- Jaw with TC inserts: firm & reliable grip of suturing needles
- Ergonomic designed handle: easy posture by alignment of the surgeon's hand with the suturing needle
- Curved, fine tapered jaw
- Ø 5mm



		330mm	450mm
	Curved left	300-330-033	300-330-045
	Curved right	300-332-033	
	Straight jaw	300-334-033	

### TOBIAS & TOBIAS II FASCIA SUTURING INSTRUMENTS

- Self-closing spring mechanism
- For closing trocar incisions under vision



Shaft diameter	2.0mm
Working length	150mm
Tip Geometry	sharp conical tip, detachable
Cleaning	LuerLock flush port

300-151-000\* Tobias Fascia Suturing Instrument with slim 2.0mm shaft and detachable conical tip



300-152-000 Tip only, set with 5 pieces



Shaft diameter	2.8mm
Working length	150mm
Tip Geometry	sharp conical tip, detachable
Cleaning	LuerLock flush port

300-153-000\* Tobias II Fascia Suturing Instrument with strong 2.8mm shaft and fixed pyramidal tip

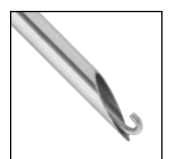

300-151-100 Rainer Fascia Suturing Device, Ø 2.3mm, 140mm working length

## KNOT TIERS



Classic knot tier with slit and eye for extra corporal knotting,  $\varnothing$  4 mm  
 300-030-001\* 330 mm working length  
 300-030-003 450 mm working length

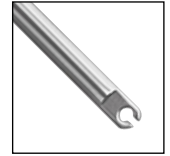

Knot tier with eye for extra corporal knotting,  $\varnothing$  4 mm  
 300-030-004 330 mm working length  
 300-030-006 450 mm working length

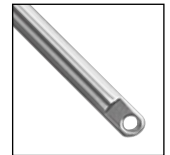

300-030-000\* Knot tier with longitudinal conical form for secure holding of extracorporal knots to suture site,  $\varnothing$  4 mm, 330 mm working length

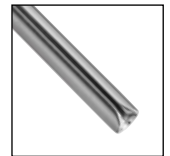

300-012-405\* Reducer Sleeve,  $\varnothing$  5 - 4mm, 175mm, red

### KNOT PUSHER WITH SCISSORS



Consists of:

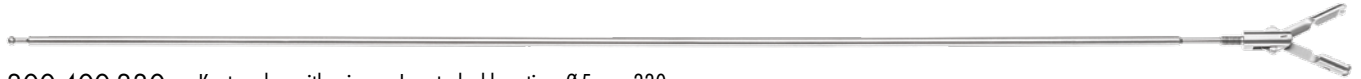

300-400-330 Knot pusher with scissors, Insert, double action, Ø 5mm, 330mm



300-660-005 Outer Sheath, insulated, Ø 5mm, 330mm, adaptable to all handles

Handles



300-750-101 Carbon Fiber Handle, HF-connection



300-750-105 Carbon Fiber Handle, hook up ratchet, HF-connection



# BIPOLAR INSTRUMENTS

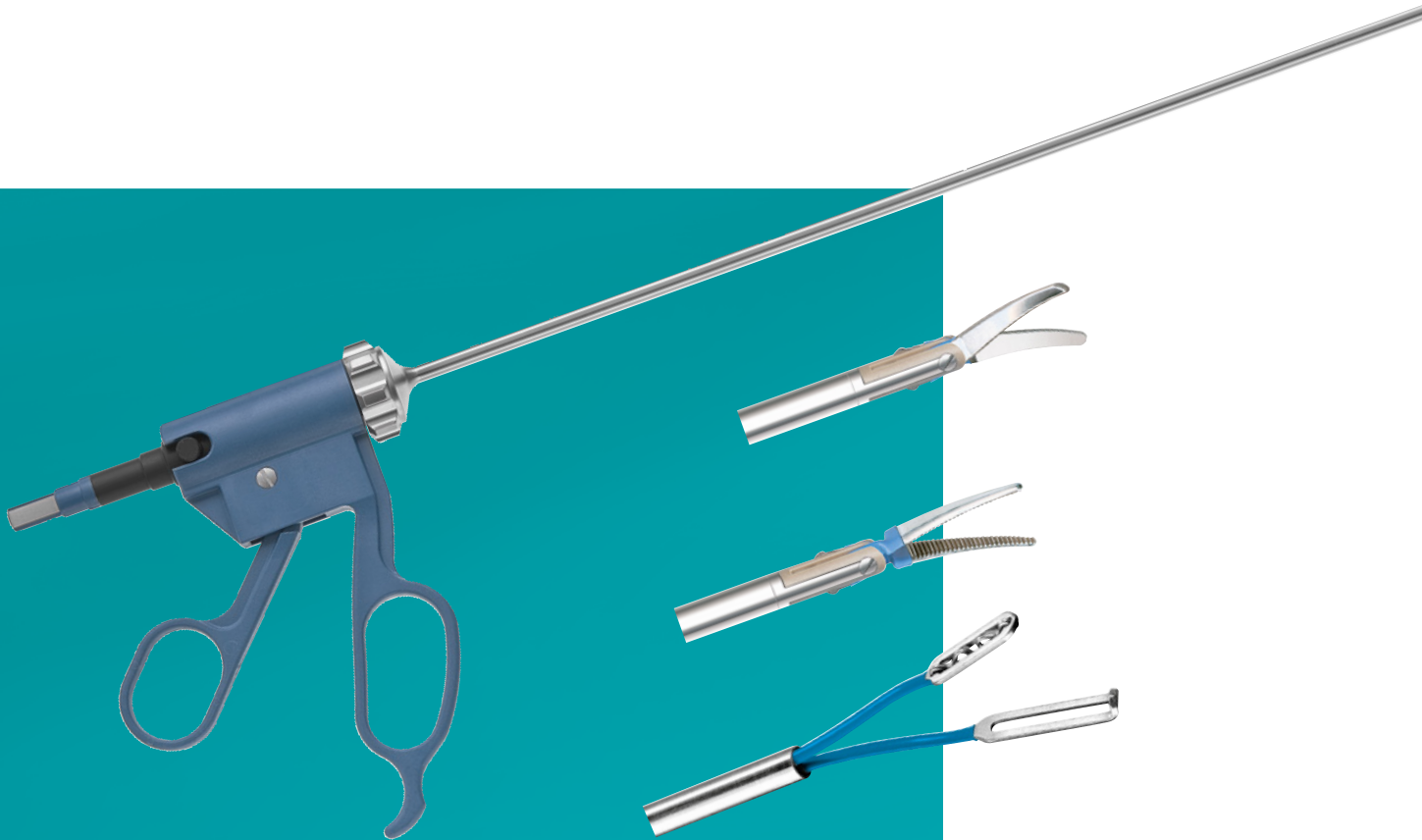

## DETACHABLE BIPOLAR FORCEPS

- 360° rotatable
- Consists of forceps body & shaft - without electrode

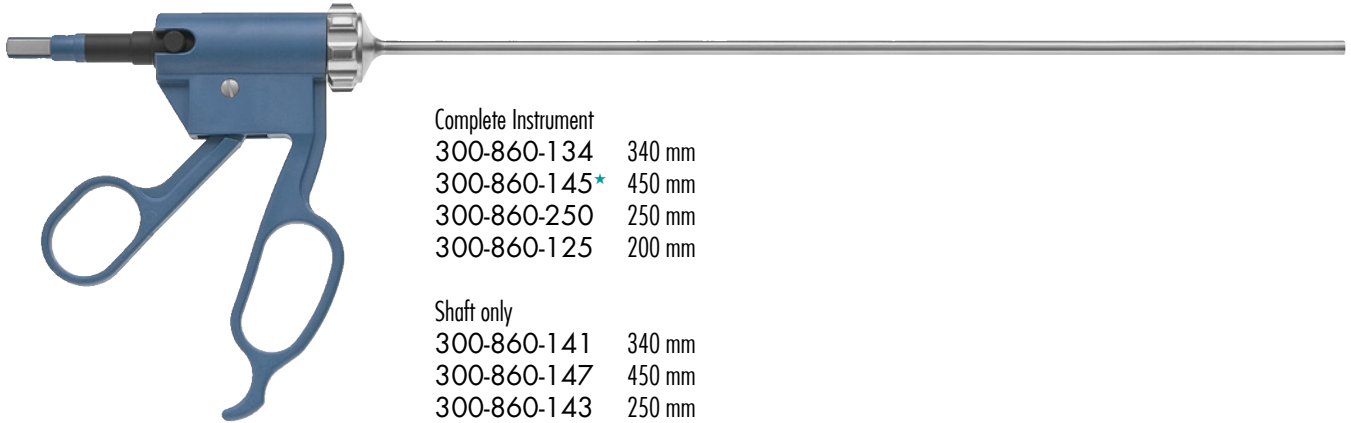

### Complete Instrument

300-860-134	340 mm
300-860-145*	450 mm
300-860-250	250 mm
300-860-125	200 mm

### Shaft only

300-860-141	340 mm
300-860-147	450 mm
300-860-143	250 mm
300-860-142	200 mm

### Handle only

300-860-140

## DETACHABLE 720° ROTATABLE BIPOLAR FORCEPS

- 720° rotatable, independently of the shaft
- Consists of forceps body & shaft - without electrode

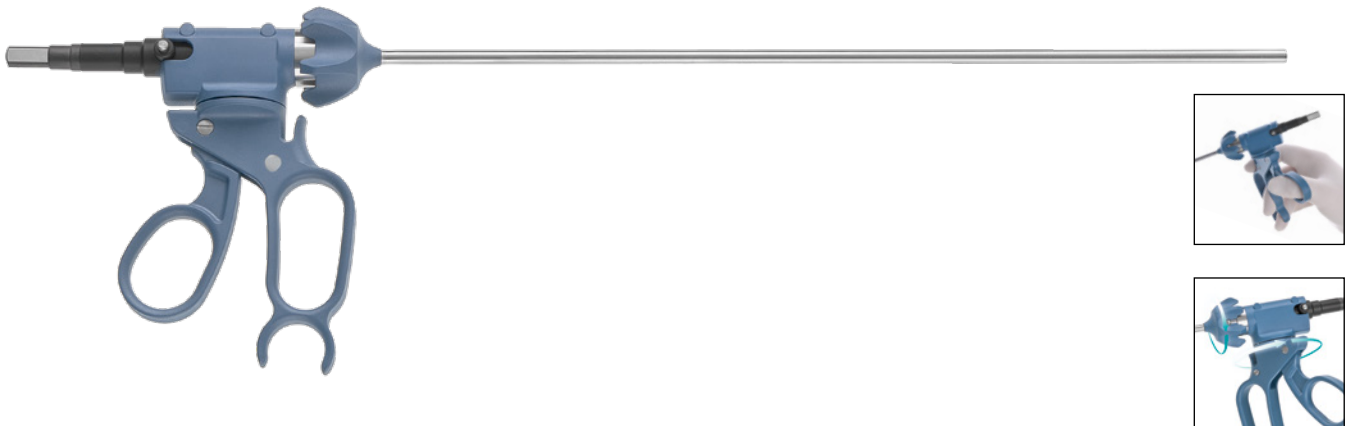

### Complete Instrument

300-860-534	340 mm
300-860-545	450 mm

### Shaft only

300-560-535	340 mm
300-560-546	450 mm









### Handle only, with adjustment (rotating stop)

300-860-500

## POWERGRIP BIPOLAR ELECTRODE INSERTS

- Insulated up to the end of the working zone
- Ø 5mm



	Grasping Forceps, fenestrated jaws, curved	300-860-009	340 mm
	Grasping Forceps, fenestrated jaws, serrated	300-860-013* 300-860-023 300-860-063	340 mm 450 mm 200 mm*
	Grasping Forceps, slightly curved	300-860-011 300-860-021 300-860-061	340 mm 450 mm 250 mm*
	Powergrip Bipolar Forceps, 2x3 teeth	300-860-012	340 mm
	Delta Grasping Forceps, double action	300-860-014 300-860-024	340 mm 450mm
	Grasping Forceps, curved	300-860-015 300-860-025 300-860-065	340 mm 450 mm 200 mm*
	Duckbill Forceps	300-860-016 300-860-026	340 mm 450 mm
	TC-Metzenbaum Scissors	300-860-018* 300-860-028 300-860-068	340 mm 450 mm 200 mm*
	Maryland Insert	300-860-019* 300-860-029 300-860-069	340 mm 450 mm 200 mm*

\* 20 / 25 cm pattern not available for 720° rotatable Bipolar Forceps

### POWERGRIP PREMIUM BIPOLAR ELECTRODE INSERTS



- Joint mechanism stays in place
- Insulated up to the end of the working zone
- Ø 5mm

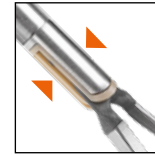

Premium model -  
joint mechanism  
stays in place



Standard model -  
joint mechanism  
exposes

	Grasping Forceps, fenestrated, curved	300-860-009	340 mm
	Grasping Forceps, fenestrated, straight	300-860-032	340 mm
	Grasping Forceps, fenestrated, curved	300-860-033	340 mm
	TC Metzenbaum Scissors	300-860-035	340 mm
	Maryland Forceps	300-860-037	340 mm
	Cut and seal forceps, curved	300-860-040	340 mm

### 3mm DETACHABLE BIPOLAR FORCEPS

- Small diameter, equal performance
- One-finger control of the 360° rotation wheel
- Overload protection and direct force transmission
- Flat plug for common bipolar cables



Shaft,  $\varnothing$  3mm  
 300-867-129 290mm  
 300-867-120 200mm



Grasping Forceps, fenestrated

300-867-529 290mm  
 300-867-520 200mm



Maryland Forceps, curved

300-867-929 290 mm  
 300-867-620 200 mm



Micro Forceps

300-867-729 290 mm  
 300-867-720 200 mm

### BIPOLAR FORCEPS SYSTEM, Ø 5mm

- Detachable
- Consists of forceps body, inner & outer tube - without electrode



With standard handle **1**

300-855-034	340 mm
300-855-045	450 mm
300-855-020	200 mm

With ring handle **4**

300-855-134	340 mm
300-855-145	450 mm
300-855-120	200 mm



Forceps body standard  
300-855-001



Forceps body ring handle  
300-855-101

Outer Tube **2**

300-855-007	340 mm
300-855-052	450 mm
300-855-003	200 mm

Inner tube **3**

300-855-006	340 mm
300-855-051	450 mm
300-855-002	200 mm



Bipolar Cables, length: 3m  
2 banana plug 300-855-100  
Valleylab plug 300-855-105  
Martin plug 300-855-102  
Erbe plug 300-855-103



Adapter for bipolar cable  
300-855-400 with flat plug  
300-855-401 with 2-pin-plug

#### Electrodes / Inserts

	Tubal ligation	300-855-010	340 mm
		300-855-022	450 mm
		300-855-060	200 mm
	Micro jaw, 1 mm	300-855-011	340 mm
		300-855-021	450 mm
		300-855-061	200 mm
	Grasping forceps, 3 mm	300-855-015	340 mm
		300-855-025	450 mm
		300-855-065	200 mm
	Scissors, curved	300-855-017	340 mm
		300-855-027	450 mm
		300-855-067	200 mm
	Kleppinger, serrated	300-855-013	340 mm
		300-855-023	450 mm
		300-855-063	200 mm
	Scissors with TC blades, curved	300-855-018	340 mm
		300-855-028	450 mm
	Dissector Maryland, curved	300-855-019	340 mm
		300-855-029	450 mm
		300-855-069	200 mm

### MICRO BIPOLAR SYSTEM, Ø 3mm

- Suits for all operations in Laparoscopy
- Especially for fine coagulation of tissue and small vessels
- Easy detachable for cleaning purposes



300-857-100 Bipolar Micro Coagulation Forceps, Ø 3mm

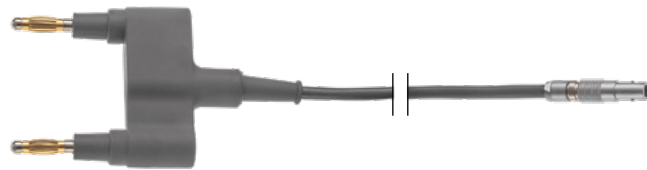

300-857-205  
Cable only for 300-857-100

#### Electrode Inserts



Micro Electrode, rippled bar

300-857-111



Micro Electrode, fluted tip, 1mm

300-857-112



#### Bipolar Micro Electrodes, 3 mm



Bipolar L-Hook

300-857-301



Bipolar V-Hook

300-857-302



Bipolar Needle

300-857-303

### BIPOLAR CABLES



Flat plug



Flat plug, angled



Flat plug, square



2-pin plug



RZ HF Unit  
SDS Plug,  
programmable

3m	700-500-300
5m	700-500-500



2-Banana\*

3m	700-350-030	300-860-100	700-350-130	700-351-030
5m	700-350-050	300-860-111	700-350-150	700-351-050



Erbe

3m	700-101-001	700-100-130	700-101-130	700-100-102
5m	700-100-101	700-100-150	700-101-150	700-100-103



Martin, Aesculap  
Berchtold

3m	700-287-030	700-200-130	700-287-130	700-200-132
5m	700-287-050	700-200-150	700-287-150	700-200-152



RZ, Valleylab,  
Lamidey, EMC

3m	700-351-031*	700-300-003	700-351-131	700-300-203
5m	700-351-051	700-300-005	700-351-151	700-300-205



Erbe  
EMC/Dolley

3m	700-400-050	700-400-003	700-400-103	700-400-203
5m	700-400-055		700-400-105	

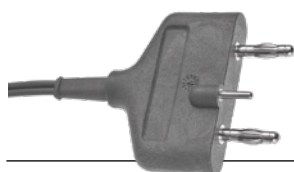

Valleylab  
autobipolar

3m	700-400-030	700-400-130
5m		

\* Not available with CE marking within Europe



2-pin plug, angled

2-pin plug, angled

Round plug

R. Wolf plug

Karl Storz plug

Ethicon Scissors plug

Aesculap Plug

700-345-403	700-345-003	700-739-003	700-630-003	700-351-047	700-351-053	700-200-030
700-345-405	700-345-005	700-739-005		700-351-048	700-351-055	700-200-050

700-101-230		700-100-202	700-100-104	700-100-302	700-100-402	700-100-502
700-101-250		700-100-303	700-100-105	700-100-305	700-100-405	700-100-505

700-287-230		700-200-232	700-390-030	700-200-332	700-200-432	700-200-532
700-287-250		700-200-252	700-390-050	700-200-352	700-200-452	700-200-552

700-351-231	700-300-403	700-736-003	700-300-503	700-300-603	700-300-703	
700-351-251	700-300-405	700-736-005	700-300-505		700-300-705	700-300-805

700-400-303	700-400-403	700-400-503		700-400-603	
		700-400-205			



# BARIATRIC INSTRUMENTS

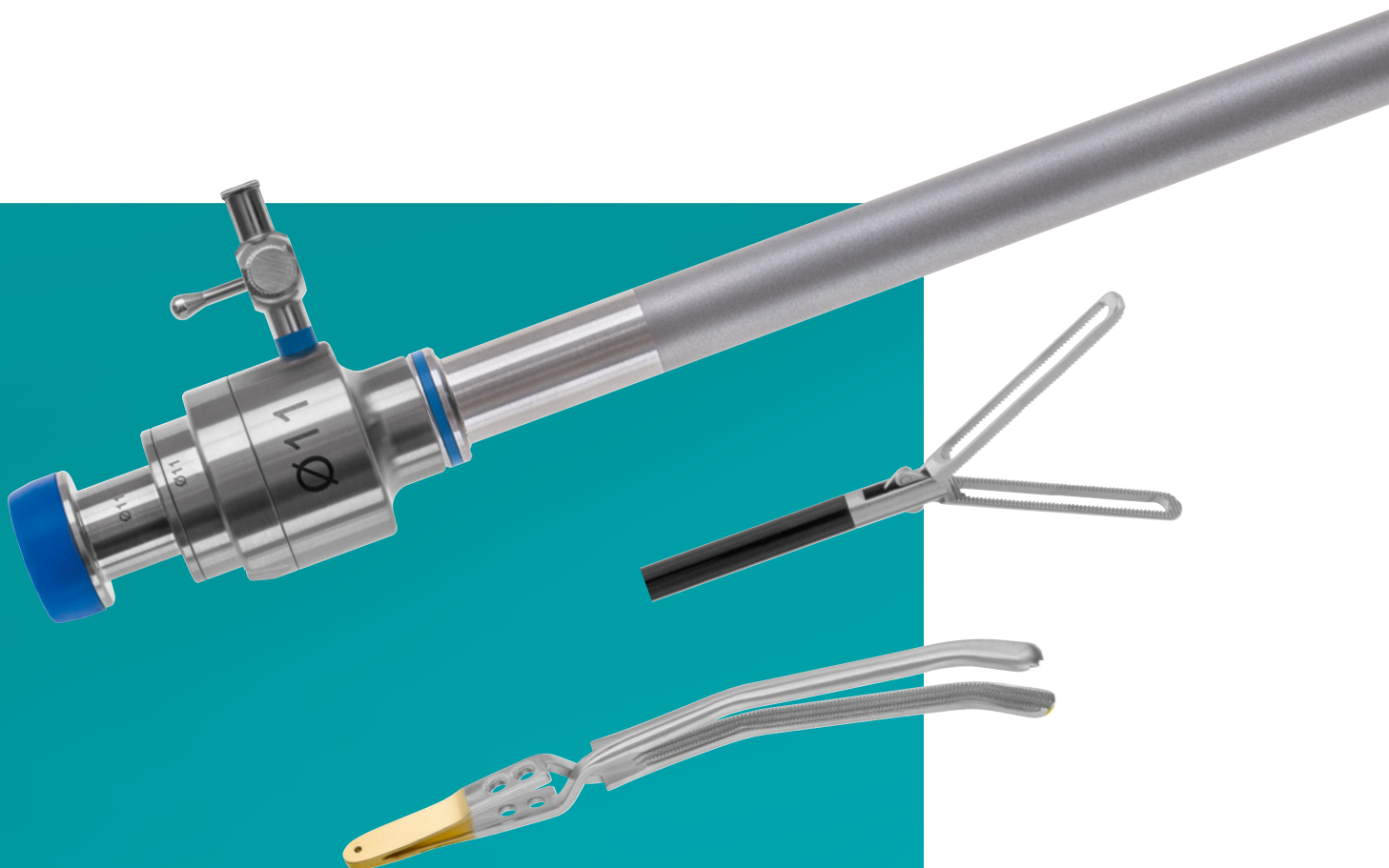

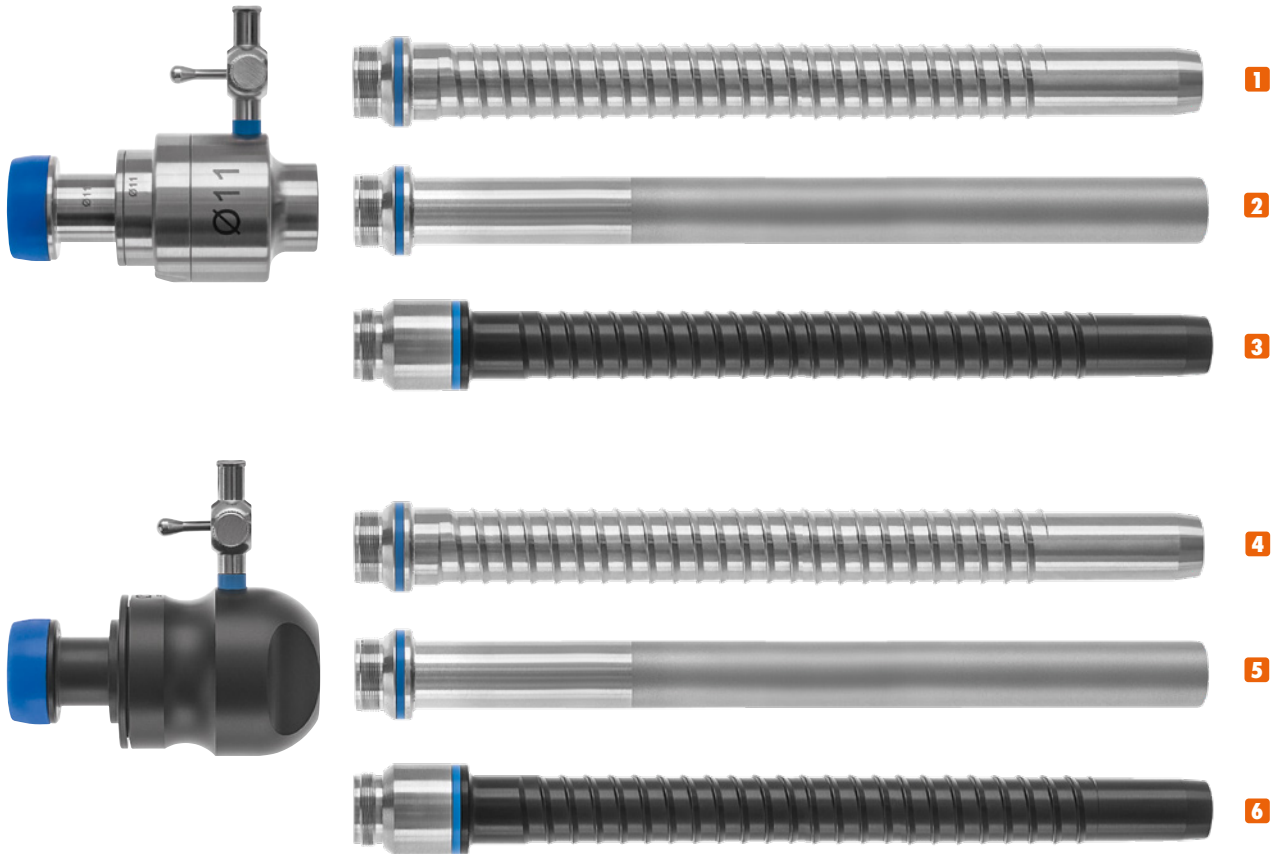

XL Valve, 150mm working length

- 1** MultiPort Valve,  
Stainless steel sleeve, thread
- 2** MultiPort Valve,  
Stainless steel sleeve
- 3** MultiPort Valve,  
Synthetic sleeve, thread
- 4** SiliPort Valve,  
Stainless steel sleeve, thread
- 5** SiliPort Valve,  
Stainless steel sleeve
- 6** SiliPort Valve,  
Synthetic sleeve, thread
  
- 1 4** Spare Sleeve
- 2 5** Spare Sleeve
- 3 6** Spare Sleeve

Ø 5.5mm

Ø 11mm

Ø 13mm

300-221-155

300-221-111

300-221-113

300-220-155

300-220-111

300-220-113

300-224-155

300-224-111

300-224-113

300-231-155

300-231-111

300-231-113

300-230-155

300-230-111

300-230-113

300-234-155

300-234-111

300-234-113

300-221-355

300-221-311

300-221-313

300-220-355

300-220-311

300-220-313

300-234-355

300-234-311

300-234-313

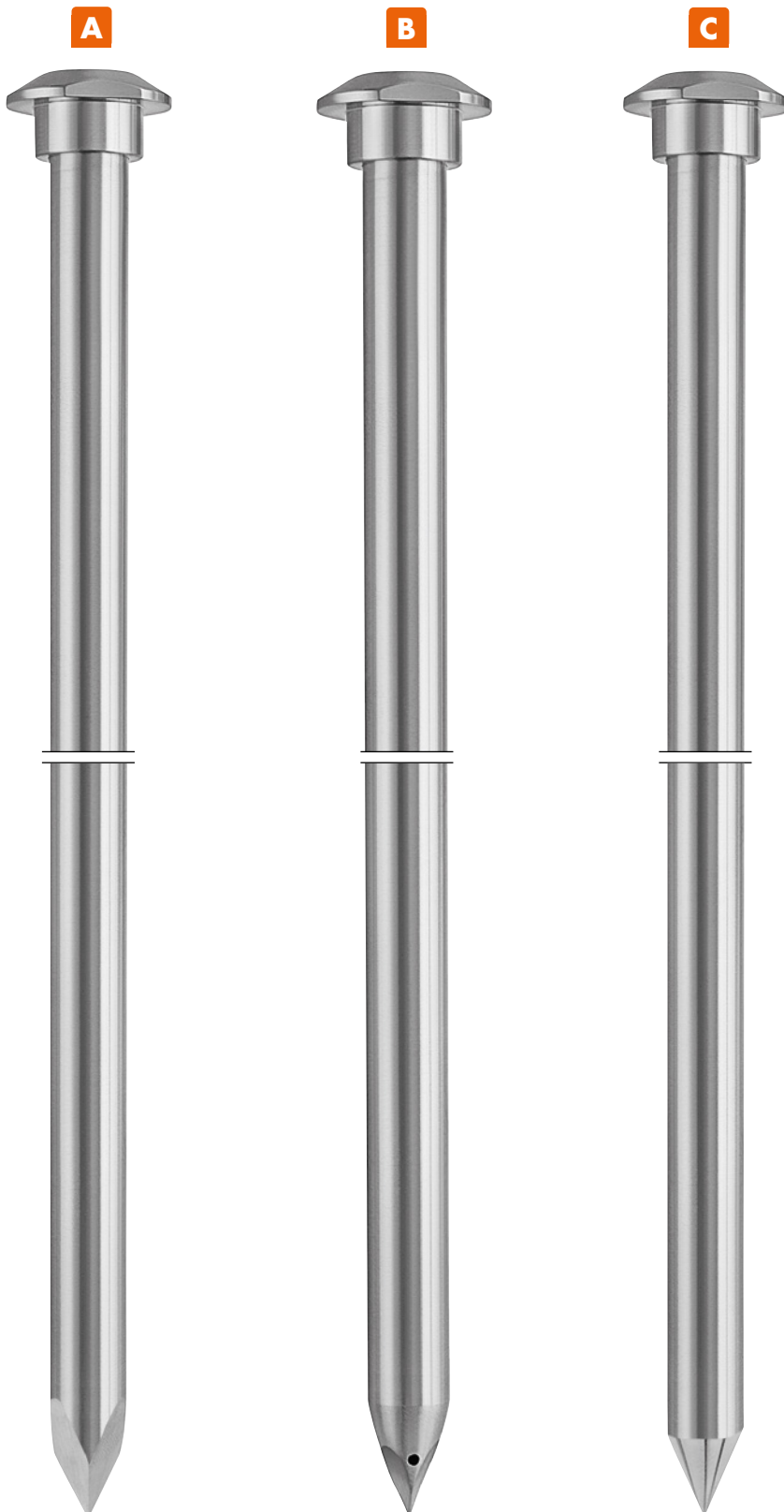
**A**

With pyramidal tip, reusable, cutting  
 150mm working length  
 300-241-155 Ø 5.5mm  
 300-241-111 Ø 11.0mm  
 300-241-113 Ø 13.0mm

**B**

Cannulated with hole, pyramidal tip  
 150mm working length  
 300-244-155 Ø 5.5mm  
 300-244-111 Ø 11.0mm  
 300-244-113 Ø 13.0mm

**C**

With conical tip, reusable, cutting  
 150mm working length  
 300-240-155 Ø 5.5mm  
 300-240-111 Ø 11.0mm  
 300-240-113 Ø 13.0mm



300-330-045 **MATHIEU** Endoscopic TC needle holder, traditional ratchet design, spring-loaded, curved left, Ø 5mm, 450 mm working length



Endoscopic TC needle holder, strong axial handle, automatic locking mechanism, Ø 5mm, 450 mm working length

- 300-100-697 straight jaw
- 300-100-698 left curved jaw

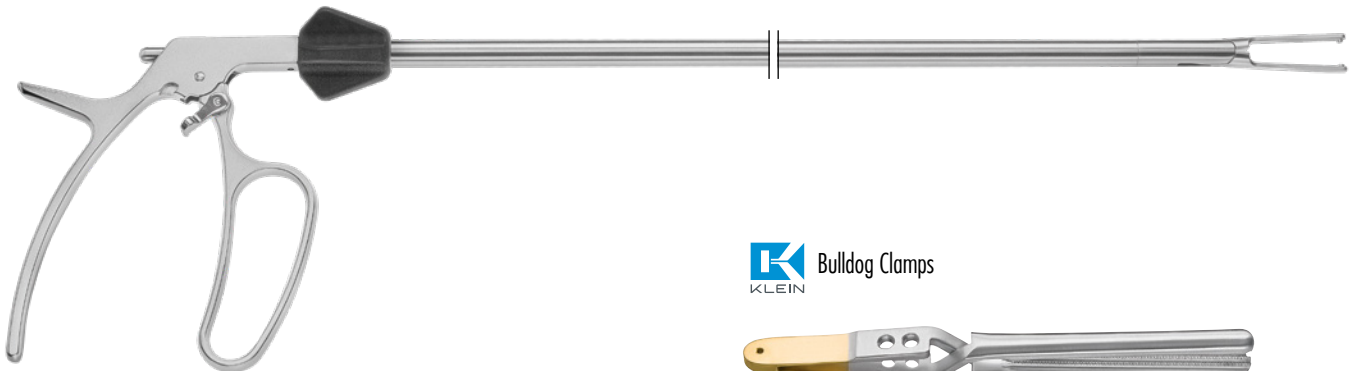

300-111-775 Endoscopic Bulldog Clamp Applier, detachable, Ø 10mm, 360° rotating, 450mm working length



300-100-772 60 mm jaws  
Endoscopic Bulldog Clamp for bowel surgery, straight, with DeBaKey serration



300-100-786 60 mm jaws  
Endoscopic Satinsky Bulldog Clamp, with DeBaKey serration, to be used with 12.5mm trocar system



300-100-789 60 mm jaws  
Endoscopic Satinsky Bulldog Clamp, curved, with atraumatic DeBaKey serration, to be used with 12.5mm trocar system



Ø 5mm

insert only

300-401-732



Complete Instrument with handle 300-750-001

300-411-732

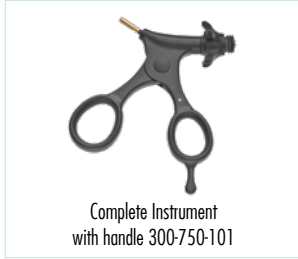

Complete Instrument with handle 300-750-101

300-421-732

### KELLY

Dissecting forceps curved, fine-tapered, cross-serrated jaws with wide opening, double action, Ø 5mm, 450 mm

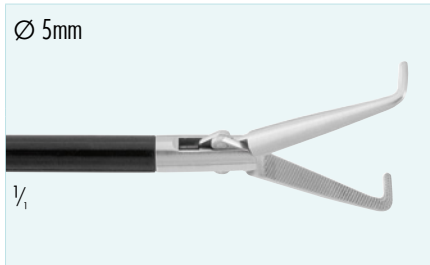

Ø 5mm

1/4

300-401-738

300-411-738

300-421-738

### MIXTER

Fine dissecting forceps 90° angled, fine serrated jaws, double action, Ø 5mm, 450 mm

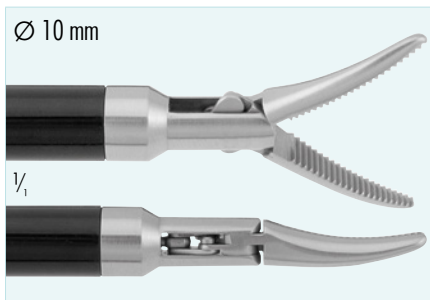

Ø 10 mm

1/4

300-401-730

300-411-730

300-421-730

### MARYLAND

Dissecting forceps curved, blunt jaws, double action, Ø 10 mm, 450 mm

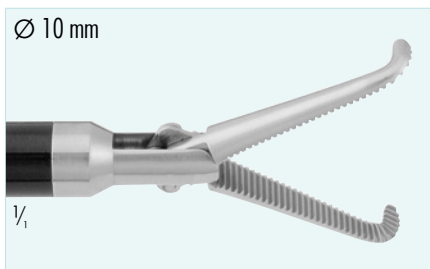

Ø 10 mm

1/4

300-401-739

300-411-739

300-421-739

### MIXTER

Dissecting forceps 90° angled, serrated jaws, double action, Ø 10 mm, 450 mm

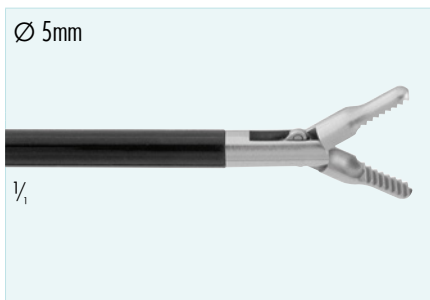

Ø 5mm

1/4

300-401-025

300-411-025

300-421-025

### DOLPHIN

Grasping and dissecting forceps, fine serrated and tapered jaws, double action, Ø 5mm, 450 mm

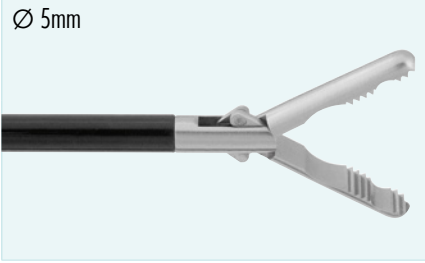
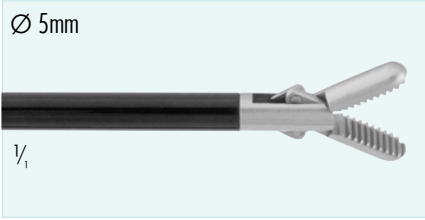
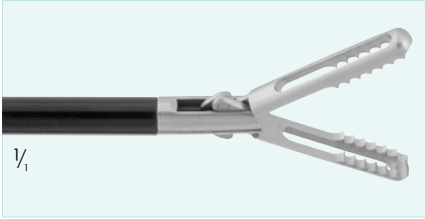
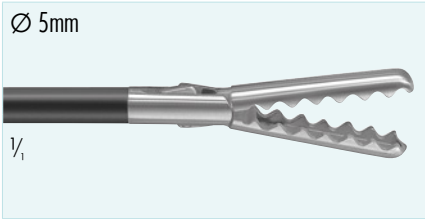
	insert only	Complete Instrument with handle 300-750-003	Complete Instrument with handle 300-750-103
<p>Ø 5mm</p>  <p><b>FUNDUS</b> Grasping forceps with 2 cups and serrated jaws, double action, Ø 5mm, 450 mm</p>	300-401-015	300-431-015	300-441-015
<p>Ø 5mm</p>  <p><b>BULLNOSE</b> Grasping forceps, heavy pattern, standard serrated jaws, double action, Ø 5mm, 450 mm</p>	300-401-001	300-431-001	300-441-001
<p>Ø 5mm</p>  <p><b>GRIPPER #1</b> Grasping forceps with coarse serration and fenestration, double action, Ø 5mm, 450 mm</p>	300-401-017	300-431-017	300-441-017
<p>Ø 5mm</p>  <p><b>PRESTIGE</b> Grasping forceps with long, bevelled-edge jaws and deep cup for large tissue collection, double action, Ø 5mm, 450 mm</p>	300-401-013	300-431-013	300-441-013



insert only

300-401-201



300-431-201

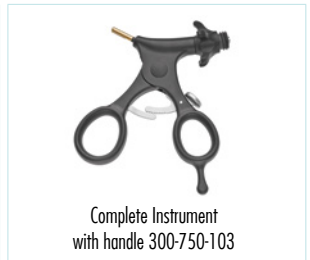

300-441-201

**COBRA**  
Grasping forceps with sharp 2 x 4 teeth and serrated inner jaws, double action, Ø 5mm, 450 mm



300-401-710

300-431-710

300-441-710

**CLAW GRASPER**  
Grasping forceps, aggressive 2 x 3 teeth and smooth inner jaws, single action, Ø 10 mm, 450 mm

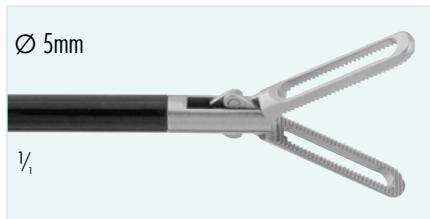

300-401-289

300-431-289

300-441-289

**JOHANS**  
Grasping forceps with 20 mm fenestrated jaws, double action, Ø 5mm, 450 mm

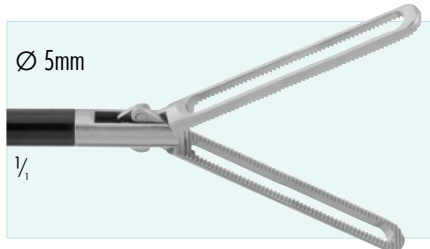

300-401-291

300-431-291

300-441-291

**LONG JOHANS**  
Grasping forceps with 40 mm fenestrated jaws, double action, Ø 5mm, 450 mm



insert only

300-401-082



300-411-082



300-421-082

Biopsy forceps with sharp oval cups, double action, Ø 5mm, 450 mm

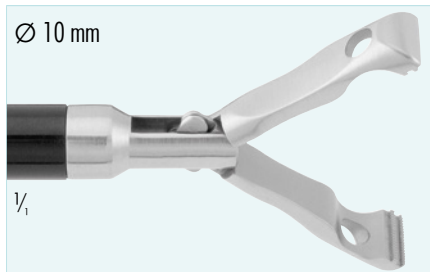

insert only

300-401-079



300-431-079

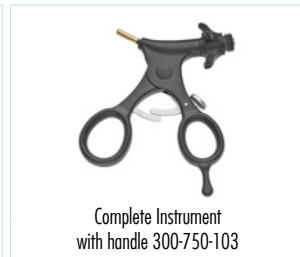

300-441-079

### DEBAKEY BABCOCK

Traditional style Babcock grasping forceps, fenestrated jaws with atraumatic DeBakey serration, double action, Ø 10 mm, 450 mm

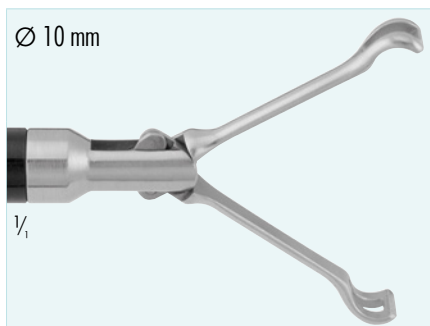

300-401-078

300-431-078

300-441-078

### BABCOCK

Traditional style Babcock grasping forceps, fenestrated jaws with fine serration, double action, Ø 10 mm, 450 mm

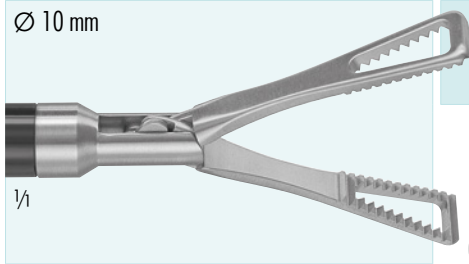

insert only

300-401-085



300-431-085



300-441-085

### COLLIN

Grasping forceps, V-shaped tip with deep serrations for a firm grip, double action, Ø 10 mm, 450 mm

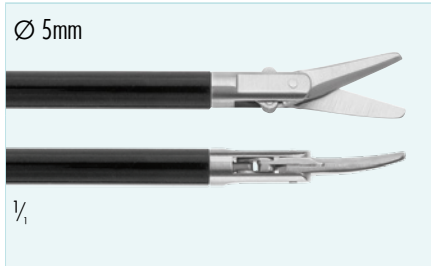

insert only

300-401-067



300-411-067



300-421-067

### ORIGINAL METZENBAUM

Scissors, short blades (12 mm), slightly curved, double action, Ø 5mm, 450 mm

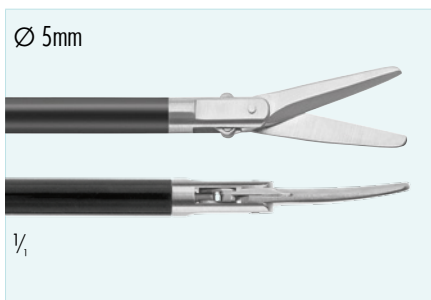

300-401-070

300-411-070

300-431-070

### METZENBAUM

Scissors, long blades (18 mm), slightly curved, double action, Ø 5mm, 450 mm



300-401-072

300-411-072

300-431-072

### METZENBAUM

Scissors, medium blades (15mm), slightly curved, double action, Ø 5mm, 450 mm

## DETACHABLE XL BIPOLAR FORCEPS

- 360° rotatable
- Consists of forceps body & shaft - without electrode



300-860-145 Bipolar Coagulation Forceps, 450mm

## POWERGRIP XL BIPOLAR ELECTRODE INSERTS

- Insulated up to the end of the working zone
- Ø 5mm



	Grasping Forceps, fenestrated jaws, serrated, 5mm	300-860-023	450 mm
	Grasping Forceps, slightly curved	300-860-021	450 mm
	Delta Grasping Forceps	300-860-024	450 mm
	Grasping Forceps, curved	300-860-025	450 mm
	TC-Metzenbaum Scissors	300-860-028	450 mm
	Maryland Insert	300-860-029	450 mm

# PEDIATRIC AND MINI INSTRUMENTS

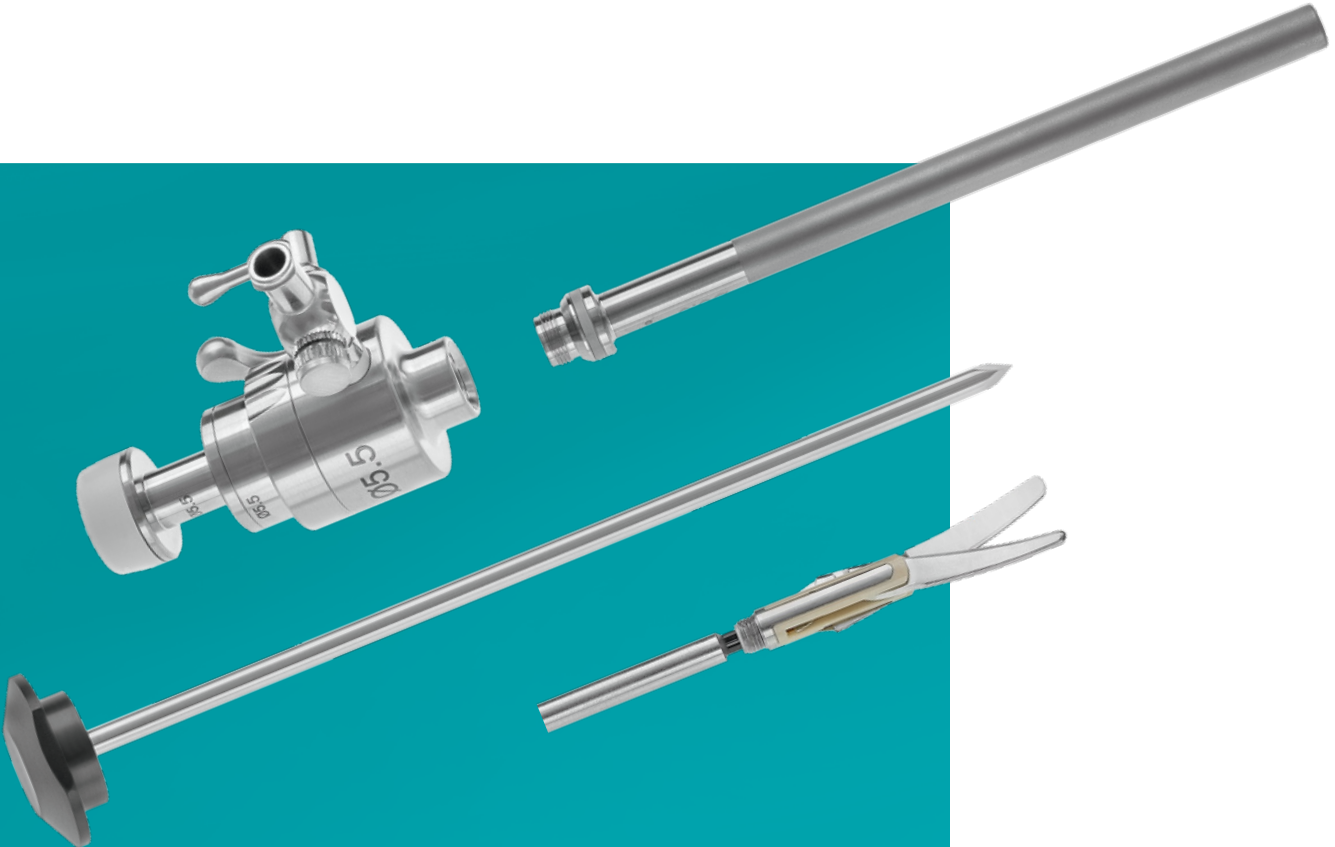

## PEDIATRIC TROCAR SYSTEM

- 100mm working length
- Ø 5.5mm



MultiPort Trocar System



SiliPort Trocar System

- 1** Stainless steel sleeve, smooth
- 2** Stainless steel sleeve, thread
- 3** Stainless steel sleeve, oblique
- 4** Synthetic sleeve, smooth
- 5** Synthetic sleeve, thread

MultiPort Trocar System

- 300-220-055\*
- 300-221-055
- 300-222-055\*
- 300-223-055
- 300-224-055

Siliport Trocar System

- 300-230-055
- 300-231-055
- 300-232-055
- 300-233-055
- 300-234-055



300-112-035 Stainless steel trocar with smooth sleeve, 70mm working length, Ø 3.5mm

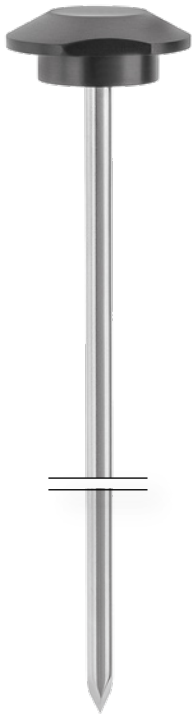

With pyramidal tip, reusable, cutting  
 300-241-035 Ø 3.5mm  
 300-241-055\* Ø 5.5mm



With conical tip, reusable, cutting  
 300-240-035 Ø 3.5mm  
 300-240-055 Ø 5.5mm



Hasson Obturator with blunt ball tip,  
 reusable, atraumatic  
 300-242-035 Ø 3.5mm  
 300-242-055 Ø 5.5mm



Safety Trocar  
 300-152-055 5.5mm



Sealing caps, color-coded, 10 pieces  
 300-250-035 Ø 3.5mm (red)  
 300-250-055\* Ø 5.5mm (white)



Gaskets for MultiPort Trocar System, 10 pieces  
 300-250-235 Ø 3.5mm (black)  
 300-250-255\* Ø 5.5mm (white)



Gaskets for MultiPort Trocar System, 10 pieces  
 300-250-135 Ø 3.5mm  
 300-250-155\* Ø 5.5mm

## RZ EASYCLEAN MINI SUCTION AND IRRIGATION SYSTEM

- 2 color coded trumped valves
- Universal suction channel
- Lateral LuerLock irrigation channel



Suction and irrigation set  
300-019-700 suction tube 300-019-735 and big valve body 300-019-501

### Spare Parts for RZ EasyClean Mini Suction and Irrigation System



300-019-501 big  
300-019-601 small  
Single Valve Body

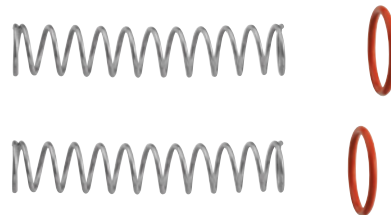

300-019-770  
Spring  
1 set with 10 pieces

300-019-780  
Gasket O-Ring  
1 set with 10 pieces



300-019-735 Suction and irrigation tube with 4x4 holes,  $\varnothing$  3.5mm  
for handles 300-019-501 and 300-019-601, 240mm



300-165-100 Suction and irrigation handle with 2 trumpet valves. Suction channel with large universal tube connector, irrigation channel with lateral LuerLock connection. Removable ergonomic handle plate for easy cleaning and maintenance.



300-166-100\* Pistol-shaped suction and irrigation handle with 2-way valve and 2 big universal tube connectors for suction and irrigation. Ergonomic handle design for optimal operating convenience.



Suction and irrigation tubes,  
for 300-165-100 and 300-166-100



4 holes, with markings, Ø 3 mm



340mm working length  
250mm working length

300-172-003  
300-172-253



16 holes, with markings, Ø 3 mm



340mm working length  
250mm working length

300-173-003  
300-173-253



300-192-000 Suction and irrigation handle with rotating 2-way lever mechanism and 2 big universal tube adapter

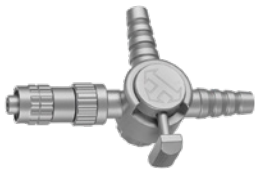

Suction tubes, probes and irrigation tubes, for 300-192-000



4 holes, with markings, Ø 3 mm



340mm working length  
250mm working length

300-192-003  
300-192-253



4 x 4 holes, with markings, Ø 3 mm



340mm working length  
250mm working length

300-193-003  
300-193-253



Palpation Probe, graduated, Ø 2.8 mm



340mm working length  
250mm working length

300-193-303  
300-193-353



Injection and puncture needle, Ø 2.8mm, 1.2mm sharp needle tip



340mm working length  
250mm working length

300-194-303  
300-194-353

## TC ENDOSCOPIC NEEDLE HOLDERS, Ø 3mm



## STRAIGHT HANDLE

300-300-330	straight	330mm
300-300-340	left curved	330mm
300-300-341	right curved	330mm
300-300-430	straight	450mm
300-300-440	left curved	450mm
300-300-441	right curved	450mm

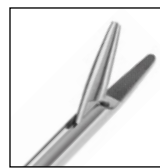

Straight

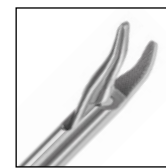

Left curved



Right curved



## ANGLED HANDLE

300-300-360	straight	330mm
300-300-370	left curved	330mm
300-300-371	right curved	330mm
300-300-460	straight	450mm
300-300-470	left curved	450mm
300-300-471	right curved	450mm

### LAPAROSCOPIC MICRO INSTRUMENTS, 2-PIECE

- Ø 3 mm shaft
- LuerLock irrigation channel
- To be used with standard RZ handles



Metzenbaum Scissors  
straight, short blade: 8mm, double action

300-503-069 330mm  
300-505-069 210mm



Hook Scissors  
round cutting blade, single action

300-503-060 330mm  
300-505-060 210mm



Peritoneal Scissors  
straight, delicate, fine serrated, single action

300-503-063 330mm  
300-505-063 210mm



Micro Scissors  
straight, sharp, single action

300-503-570 330mm  
300-505-570 210mm



Metzenbaum Scissors  
slightly curved, short blade, double action

300-503-067 330mm  
300-505-067 210mm



Biopsy Cup Forceps  
sharp, oval cups, double action

300-503-082 330mm  
300-505-082 210mm



Biopsy Cup Forceps  
sharp, oval cups, 1 pin, 1 hole, double action

300-503-080 330mm  
300-505-080 210mm



Fundus Grasping Forceps  
serrated, double action

300-503-015  
300-505-015

330mm  
210mm



Dolphin Dissecting Forceps  
fine serrated, biopsy cup, conical shape, double action

300-503-025  
300-505-025

330mm  
210mm



Maryland fine Dissector  
serrated, curved, conical shape, double action

300-503-731  
300-505-731

330mm  
210mm



Dolphin Dissecting Forceps  
fine serrated, double action

300-503-021  
300-505-021

330mm  
210mm



Johans atraumatic Grasping Forceps  
fenestrated, serrated, double action

300-503-052  
300-505-052

330mm  
210mm



„Needle Nose“ Dissecting & Grasping Forceps  
fine, conical shape, cross serrated, double action

300-503-016  
300-505-016

330mm  
210mm



Standard Grasping Forceps  
biopsy cup, serrated, double action

300-503-000  
300-505-000

330mm  
210mm



Claw Grasper Forceps  
2x3 teeth, smooth, single action

300-503-710  
300-505-710

330mm  
210mm

## 3.5mm LAPAROSCOPIC INSTRUMENTS

- Stronger 3-piece detachable instruments, less invasive & scarless surgery
- Very simple cleaning, assembling and disassembling
- 3.5mm mini instruments designed for pediatric (250mm) and mini Laparoscopy use



300-750-101\*  
PEEK Polymer Handle with  
HF - connection



300-750-103\*  
PEEK Polymer Handle with ratchet  
and HF - connection



Outer Sheath, insulated, adaptable to all handles  
300-660-035 330mm  
300-550-035 250mm



Metzenbaum Scissors  
straight, short blade: 12mm, double action

300-403-069 330mm  
300-404-069 250mm



Hook Scissors  
round cutting blade, single action

300-403-060 330mm  
300-404-060 250mm



Biopsy Cup Forceps  
sharp, oval cups, double action

300-403-082 330mm  
300-404-082 250mm



Maryland Dissecting Forceps  
gently curved, double action

300-403-732 330mm  
300-404-732 250mm



Mixer Dissecting Forceps  
90° angled, fine serrated jaws, double action

300-403-738 330mm  
300-404-738 250mm



Fundus Grasping Forceps  
2 cups, serrated, double action

300-403-015 330mm  
300-404-015 250mm



DeBaKey Grasping Forceps  
25mm long, atraumatic, double action

300-403-244 330mm  
300-404-244 250mm



Johans Grasping Forceps  
20mm long, fenestrated, single action

300-403-284 330mm  
300-404-284 250mm



Johans Grasping Forceps  
17mm long, fenestrated, double action

300-403-289 330mm  
300-404-289 250mm

## 3mm DETACHABLE BIPOLAR FORCEPS

- Small diameter, equal performance
- One-finger control of the 360° rotation wheel
- Overload protection and direct force transmission
- Flat plug for common bipolar cables



Shaft, Ø 3mm  
 300-867-129 290mm  
 300-867-120 200mm



Grasping Forceps, fenestrated

300-867-529 290mm  
 300-867-520 200mm



Maryland Forceps, curved

300-867-929 290 mm  
 300-867-620 200 mm



Micro Forceps

300-867-729 290 mm  
 300-867-720 200 mm

## MICRO BIPOLAR SYSTEM, Ø 3mm

- Suits for all operations in Laparoscopy
- Especially for fine coagulation of tissue and small vessels
- Easy detachable for cleaning purposes



300-857-100 Bipolar Micro Coagulation Forceps, Ø 3mm

300-857-205  
Cable only for 300-857-100

### Electrode Inserts



Micro Electrode, rippled bar

300-857-111



Micro Electrode, fluted tip, 1mm

300-857-112



### Bipolar Micro Electrodes, 3 mm



Bipolar L-Hook

300-857-301



Bipolar V-Hook

300-857-302







Bipolar Needle

300-857-303

## MONOPOLAR COAGULATION ELECTRODES, Ø 2.8mm





	J-hook	300-200-132 300-200-232	330 mm 250 mm
	L-hook	300-200-133 300-200-233	330 mm 250 mm
	Ballpoint	300-200-134 300-200-234	330 mm 250 mm
	Spatula	300-200-131 300-200-231	330 mm 250 mm
	Needle	300-200-137 300-200-237	330 mm 250 mm

## BIPOLAR COAGULATION ELECTRODES



Bipolar Micro Electrodes, Ø 3 mm, 340mm working length

	Bipolar L-Hook	300-257-002
	Bipolar V-Hook	300-257-004
	Bipolar Needle	300-257-015

## CONTAINER AND CLEANING

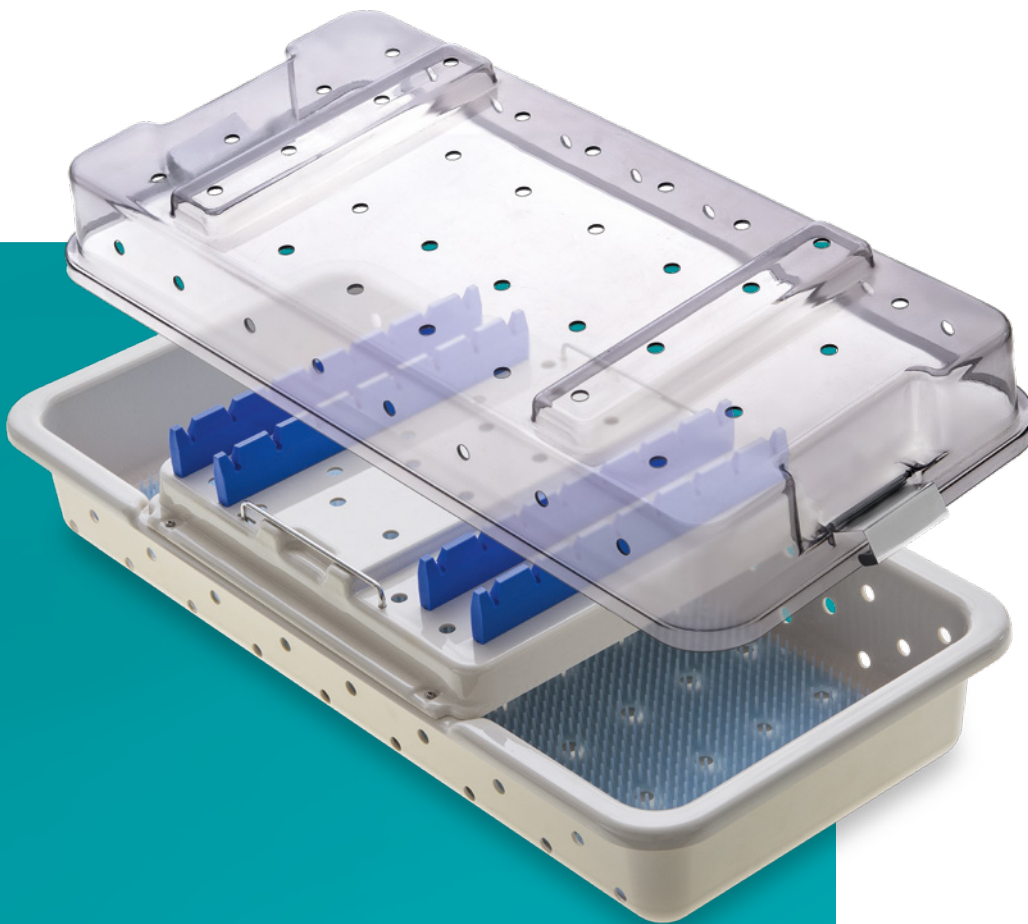

### SAFE + CLEAN ENDOSCOPE PLASTIC CONTAINER with silicone bars on base and lid

#### 600-505-000

Endoscopes	1 (∅ 1-10mm)
Endoscope length	max. 270mm
Dimensions	271 x 70 x 35mm

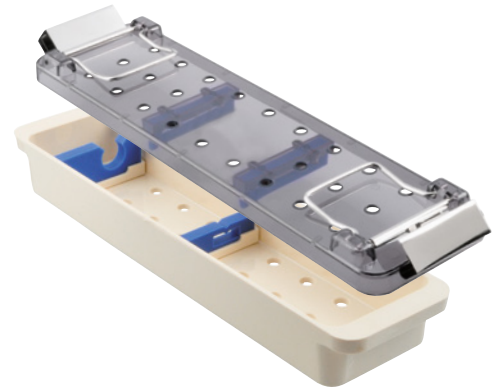

#### 600-505-002

Endoscopes	max. 2
Endoscope length	max. 190mm
Dimensions	271 x 70 x 35mm

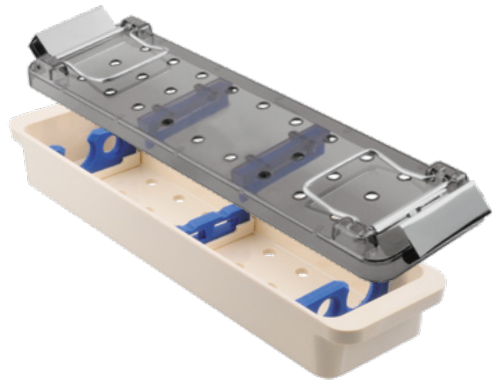

#### 600-506-002\*

Endoscopes	max. 2
Endoscope length	max. 390mm
Dimensions	394 x 70 x 35mm

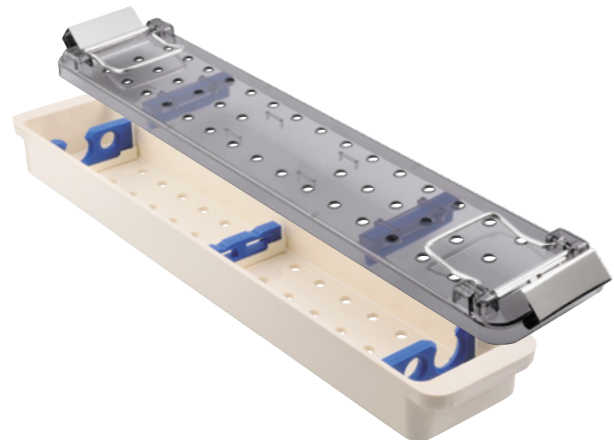

600-501-000	Endoscopes 1
600-501-002	Endoscopes max. 2
Endoscope length	max. 450mm
Dimensions	457 x 70 x 35mm

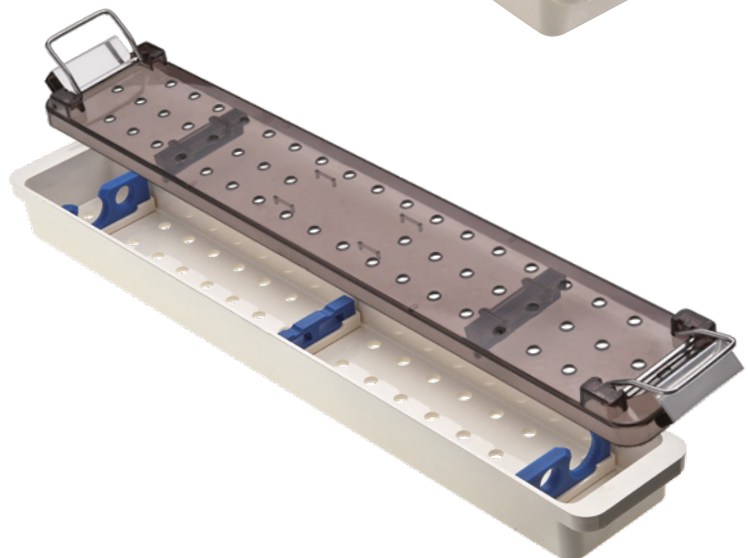

### ENDOSCOPE & INSTRUMENT CONTAINERS

600-508-000	for scopes and light guide cables
Endoscopes	max. 3 (Ø 5-10mm)
Fiber Optic Light Cable	1
Endoscope length	max. 450mm
Dimensions	465 x 212 x 51mm

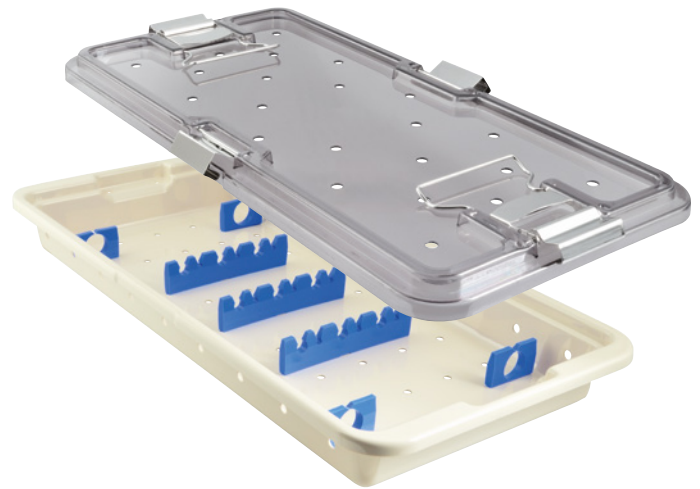

600-464-229	for fixation of instruments with rubber ties
Dimensions	464 x 229 x 51mm

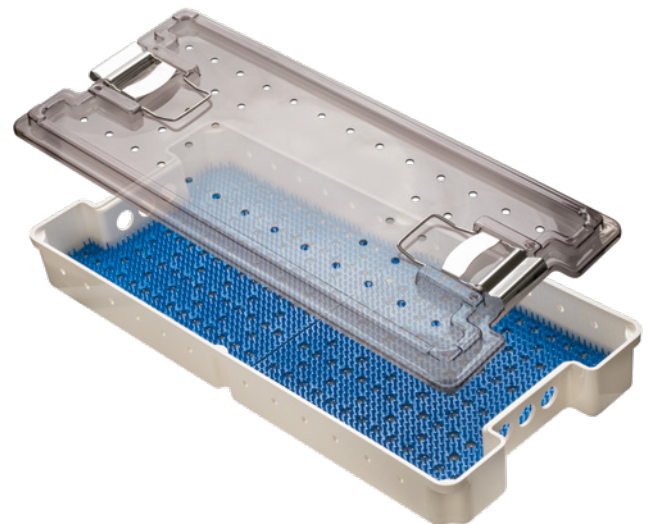

600-511-000	for instruments with rubber ties on 2 levels
Dimensions	502 x 239 x 102mm



### ENDOSCOPE CLEANING BASKETS & CONTAINERS with silicone bars on base and lid

#### 600-292-052\*

Endoscopes	max. 2
Endoscope length	max. 190mm
Dimensions	290 x 80 x 52mm

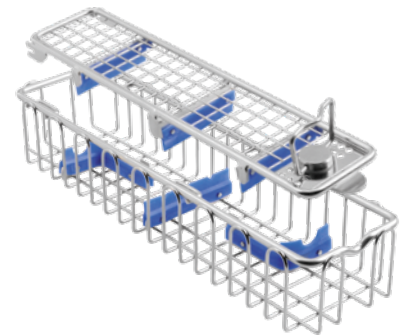

#### 600-462-052\*

Endoscopes	max. 2
Endoscope length	max. 350mm
Dimensions	460 x 80 x 52mm

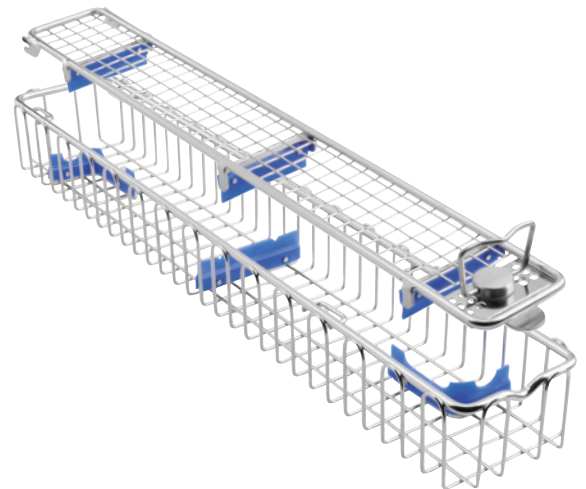

600-460-055	Endoscopes 1
600-460-056	Endoscopes max. 2
Endoscope length	max. 340mm
Dimensions	455 x 86 x 43mm

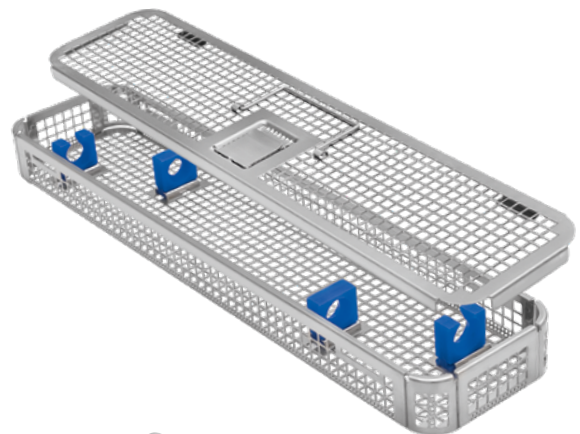

#### 600-450-070

Endoscopes	max. 2
Endoscope length	max. 330mm
Dimensions	450 x 70 x 70mm

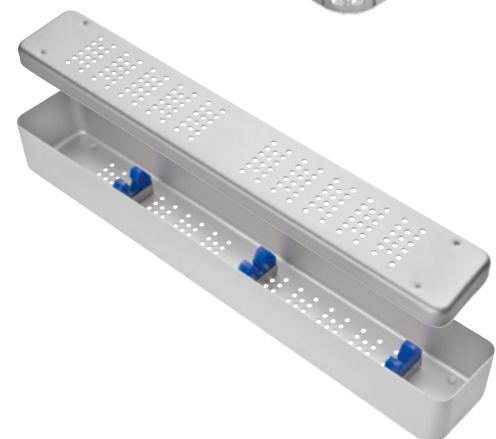

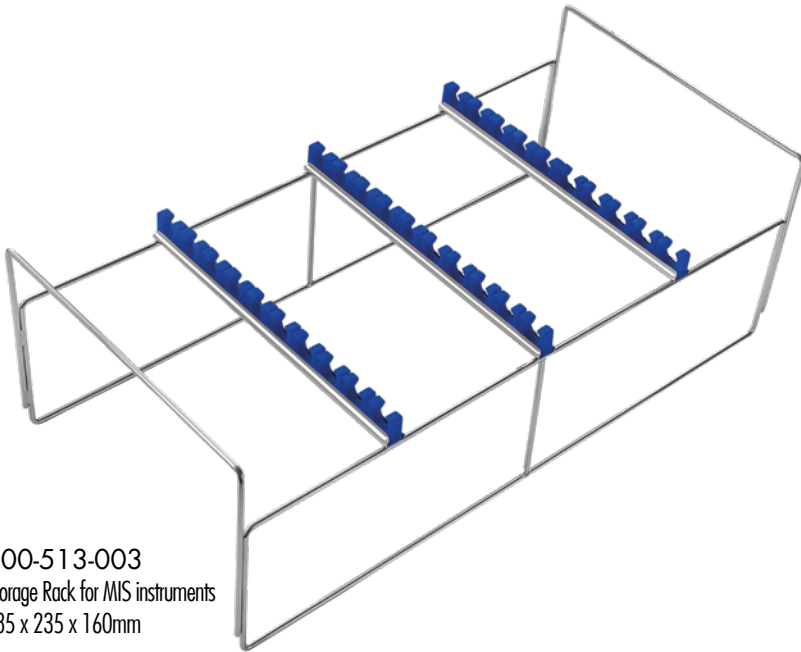

600-513-003  
Storage Rack for MIS instruments  
485 x 235 x 160mm

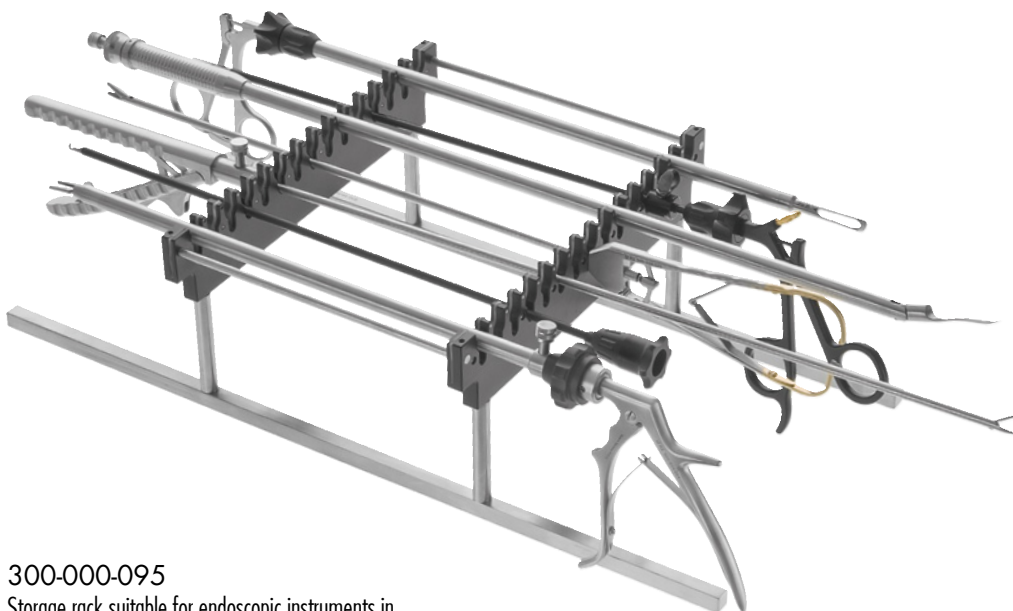

300-000-095  
Storage rack suitable for endoscopic instruments in  
Standard Container "Safety Model"  
(without Instruments)

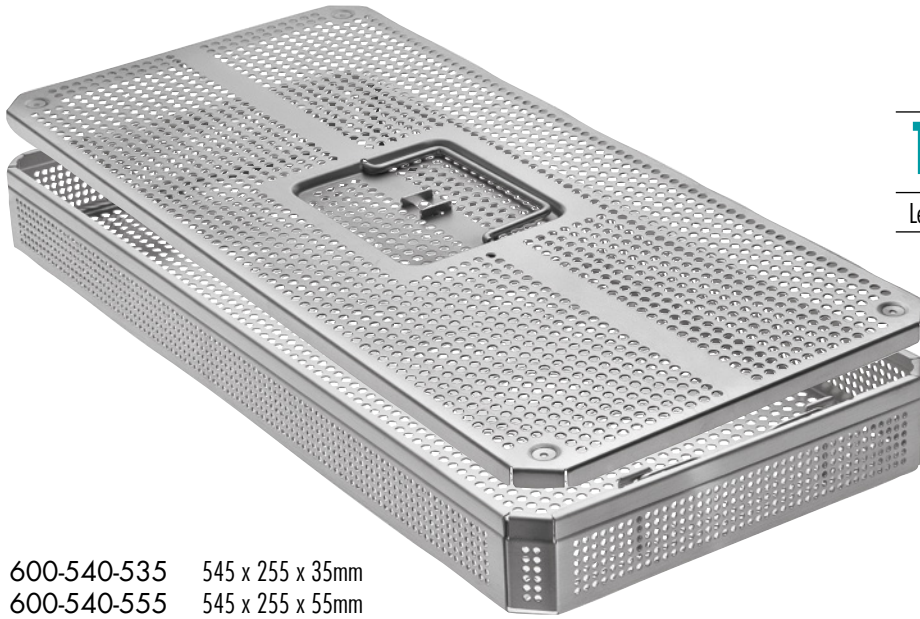

**1/1**

Stainless Steel Basket,  
round perforation, with lid

Length

545mm

600-540-535 545 x 255 x 35mm  
 600-540-555 545 x 255 x 55mm  
 600-540-575 545 x 255 x 75mm  
 600-540-605 545 x 255 x 105mm



Lid only  
 600-540-500 545 x 255mm



Bottom only  
 600-540-530 545 x 255 x 30mm  
 600-540-550 545 x 255 x 50mm  
 600-540-570 545 x 255 x 70mm  
 600-540-600 545 x 255 x 100mm

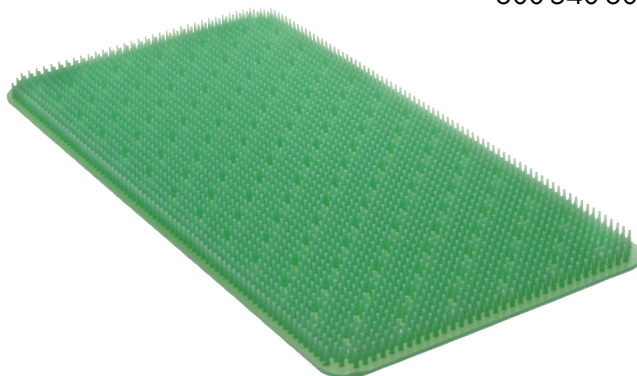

600-281-004 Silicone Mat green, 520 x 230mm

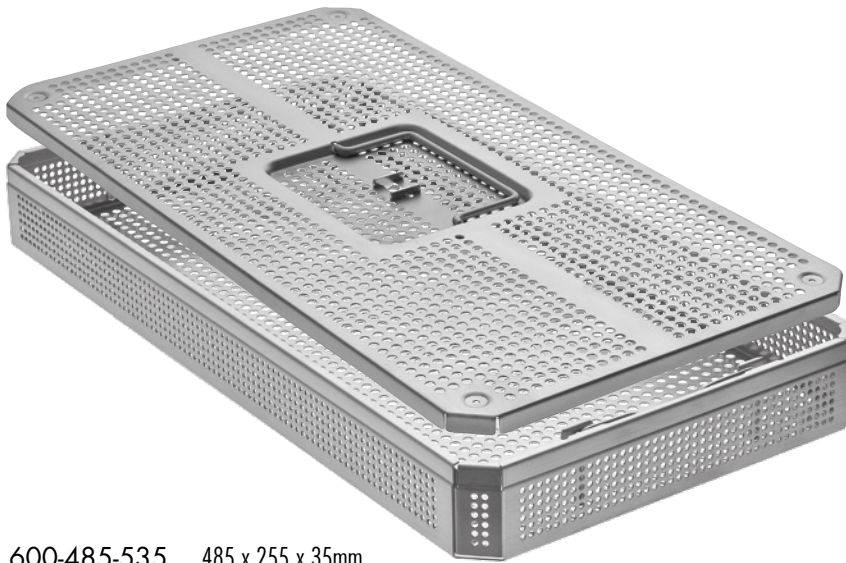

**1/1**

Stainless Steel Basket,  
round perforation, with lid

Length

485mm

600-485-535 485 x 255 x 35mm  
 600-485-555 485 x 255 x 55mm  
 600-485-575 485 x 255 x 75mm  
 600-485-605 485 x 255 x 105mm



Lid only  
 600-485-500 485 x 255mm

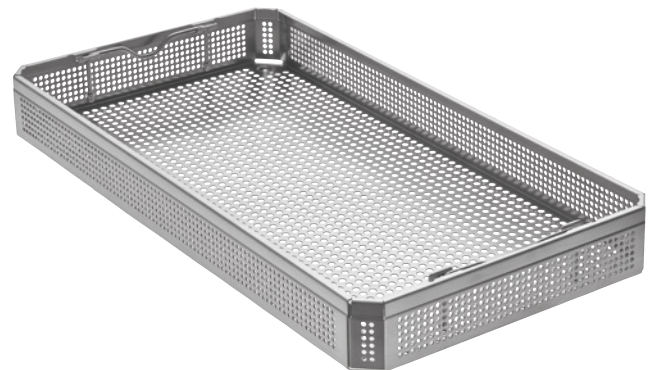

Bottom only  
 600-485-530 485 x 255 x 30mm  
 600-485-550 485 x 255 x 50mm  
 600-485-570 485 x 255 x 70mm  
 600-485-600 485 x 255 x 100mm

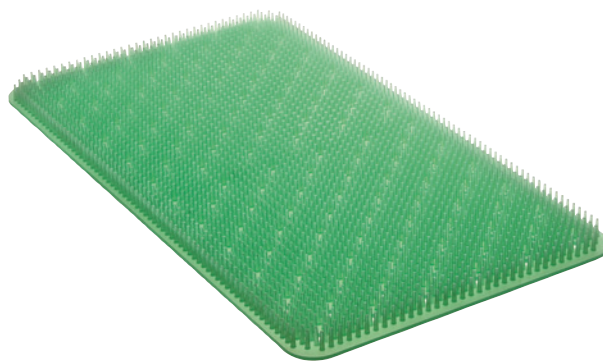

600-281-003 Silicone Mat green, 440 x 230mm

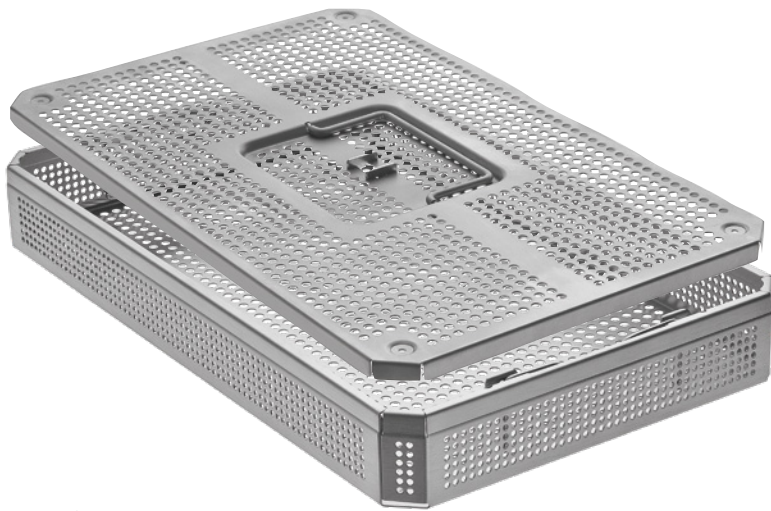

### 3/4

Stainless Steel Basket,  
round perforation, with lid

Length

405mm

600-405-535 405 x 255 x 35mm  
 600-405-555 405 x 255 x 55mm  
 600-405-575 405 x 255 x 75mm  
 600-405-605 405 x 255 x 105mm

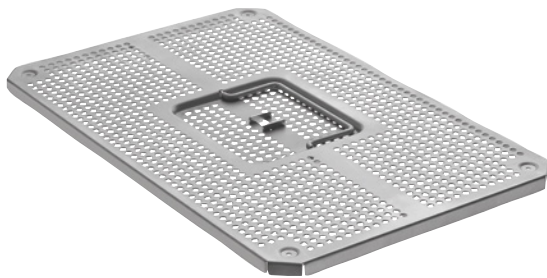

Lid only  
 600-405-500 405 x 255mm



Bottom only  
 600-405-530 405 x 255 x 30mm  
 600-405-550 405 x 255 x 50mm  
 600-405-570 405 x 255 x 70mm  
 600-405-600 405 x 255 x 100mm

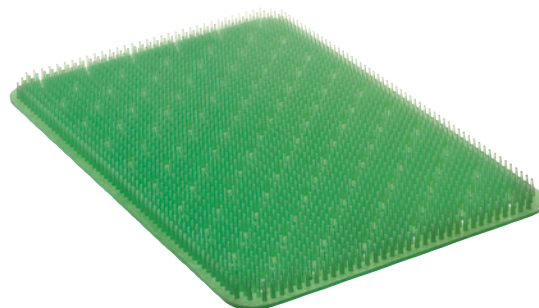

600-281-002 Silicone Mat green, 380 x 230mm



# 1/2

Stainless Steel Basket,  
round perforation, with lid

Length

255mm

600-255-535 255 x 245 x 35mm  
 600-255-555 255 x 245 x 55mm  
 600-255-575 255 x 245 x 75mm  
 600-255-605 255 x 245 x 105mm

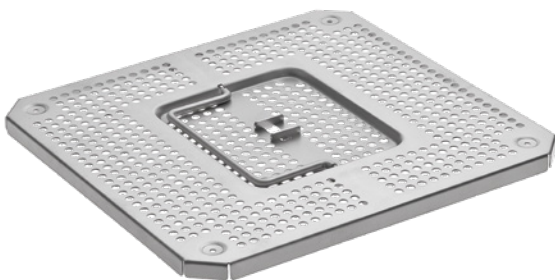

Lid only

600-255-500 255 x 245mm



Bottom only

600-255-530 255 x 245 x 30mm  
 600-255-550 255 x 245 x 50mm  
 600-255-565 255 x 245 x 70mm  
 600-255-600 255 x 245 x 100mm

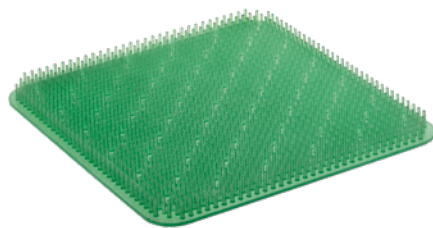

600-281-001 Silicone Mat green, 220 x 230mm



### SIZE (LXWXH)



580 x 280 x 100mm	● 600-580-101	600-579-101
	● 600-580-102	600-579-102
	● 600-580-103	600-579-103
	● 600-580-104	600-579-104
	● 600-580-105	600-579-105
	● 600-580-106	600-579-106



580 x 280 x 135mm	● 600-580-131	600-579-131
	● 600-580-132	600-579-132
	● 600-580-133	600-579-133
	● 600-580-134	600-579-134
	● 600-580-135	600-579-135
	● 600-580-136	600-579-136



580 x 280 x 150mm	● 600-580-151	600-579-151
	● 600-580-152	600-579-152
	● 600-580-153	600-579-153
	● 600-580-154	600-579-154
	● 600-580-155	600-579-155
	● 600-580-156	600-579-156



580 x 280 x 200mm	● 600-580-201	600-579-201
	● 600-580-202	600-579-202
	● 600-580-203	600-579-203
	● 600-580-204	600-579-204
	● 600-580-205	600-579-205
	● 600-580-206	600-579-206



580 x 280 x 260mm	● 600-580-261	600-579-261
	● 600-580-262	600-579-262
	● 600-580-263	600-579-263
	● 600-580-264	600-579-264
	● 600-580-265	600-579-265
	● 600-580-266	600-579-266

SIZE (LXWXH)



465 x 280 x 100mm

●	600-469-101	600-470-101
●	600-469-102	600-470-102
●	600-469-103	600-470-103
●	600-469-104	600-470-104
●	600-469-105	600-470-105
●	600-469-106	600-470-106



465 x 280 x 135mm

●	600-469-131	600-470-131
●	600-469-132	600-470-132
●	600-469-133	600-470-133
●	600-469-134	600-470-134
●	600-469-135	600-470-135
●	600-469-136	600-470-136



465 x 280 x 150mm

●	600-469-151	600-470-151
●	600-469-152	600-470-152
●	600-469-153	600-470-153
●	600-469-154	600-470-154
●	600-469-155	600-470-155
●	600-469-156	600-470-156



### SIZE (LXWXH)



285 x 280 x 100mm	●	600-280-101	600-279-101
	●	600-280-102	600-279-102
	●	600-280-103	600-279-103
	●	600-280-104	600-279-104
	●	600-280-105	600-279-105
	●	600-280-106	600-279-106



285 x 280 x 135mm	●	600-280-131	600-279-131
	●	600-280-132	600-279-132
	●	600-280-133	600-279-133
	●	600-280-134	600-279-134
	●	600-280-135	600-279-135
	●	600-280-136	600-279-136



285 x 280 x 150mm	●	600-280-151	600-279-151
	●	600-280-152	600-279-152
	●	600-280-153	600-279-153
	●	600-280-154	600-279-154
	●	600-280-155	600-279-155
	●	600-280-156	600-279-156



285 x 280 x 200mm	●	600-280-201	600-279-201
	●	600-280-202	600-279-202
	●	600-280-203	600-279-203
	●	600-280-204	600-279-204
	●	600-280-205	600-279-205
	●	600-280-206	600-279-206



285 x 280 x 260mm	●	600-280-261	600-279-261
	●	600-280-262	600-279-262
	●	600-280-263	600-279-263
	●	600-280-264	600-279-264
	●	600-280-265	600-279-265
	●	600-280-266	600-279-266



Identification label, 100 pieces per package

① 600-908-100 STANDARD

② 600-908-000 SMALL



600-909-000  
Plastic security seal,  
100 pieces per package

Identification label

with hole for snap hook

56x17mm

50x17mm



unmarked	●	600-900-040	600-900-041
	●	600-900-050	600-900-051
	●	600-900-060	600-900-061
	●	600-900-070	600-900-071
	●	600-900-080	600-900-081
	●	600-900-090	600-900-091
	●	600-900-100	600-900-101
	●	600-900-108	600-900-109
	●	600-900-110	600-900-111
	●	600-900-120	600-900-121
marked	●	600-900-130	600-900-131
	●	600-900-140	600-900-141
	●	600-900-150	600-900-151
	●	600-900-160	600-900-161

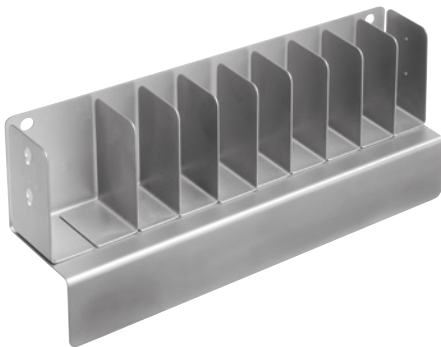

600-900-210

Dispenser for identification labels  
(8 small compartments and 1 double compartment)  
as table or wall model



600-380-100

PTFE (TEFLON) Filter, round, STANDARD

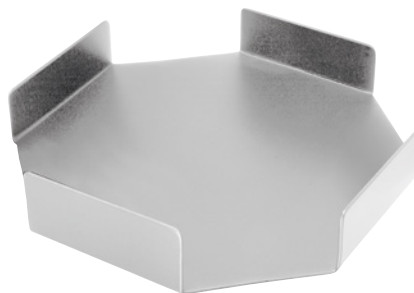

600-290-630

Filter Dispenser for disposable Filter,  
round, 195x195mm



600-100-000  
RZ-Aquajet  
Water Jet Pistol complete  
with 9 tips and 1m pressure  
tubing, with strap and  
suspension hook



600-050-000  
Hand brush, autoclavable  
(10 pcs. per box)



600-950-100  
RZ - Brush dispenser  
for 10 brushes with suspension hook



700-900-220 Special Cotton for polishing metal sheaths and instruments



700-900-160  
Instrument Oil in 50ml bottle



700-900-250  
Oil Dispenser, 140mm



Cleaning brush (1 piece per box), 500mm length  
300-135-905 for  $\varnothing$  5mm  
300-135-910 for  $\varnothing$  10 mm



300-215-000 Cleaning Brush,  $\varnothing$  13mm, 215mm length, 60mm brush length



300-420-065 Cleaning Brush,  $\varnothing$  3mm, 420mm length, 65mm brush length

# DEVICES



### INSUFFLATOR



#### Features:

- User-friendly interface
- Highest safety standard for patients
- All units are available with or without CO<sub>2</sub> heating system
- Pre-insufflation mode for use with Verres Cannulas
- Non-heating unit have the same gasflow rates as heating unit models

#### DELIVERY CONTAINS:

- Main Unit (300-900-020/-021/030/-031/-040/-041)
- Sterile Filter (300-902-007)\* (TP Product)
- CO<sub>2</sub> High Pressure Tube (300-902-003)
- Standard Silicone Tube (300-902-005)
- Silicone Tube (300-902-004), only Heater-Version
- Gas Heater with tube (300-902-001), only Heater-Version
- Operating manual
- Mains cable

#### Airflow Insufflator A2/A3/A4

- 300-900-020 20L/min
- 300-900-021 20L/min, with heating unit
- 300-900-030 30L/min
- 300-900-031 30L/min, with heating unit
- 300-900-040 45L/min
- 300-900-041 45L/min, with heating unit

#### Technical data

Line voltage	100-240 VAC
Power consumption	25 - 40W 25-105W (with gas heating) max. 0.4A (max. 1A with gas heating)
Frequency	50 - 60Hz
Insufflation pressure	1 - 30mmHG
Gas flow	1-20L/min (300-900-020 / -021) 1-30L/min (300-900-030 / -031) 1-45L/min (300-900-040 / -041)

Gas connection	UNF 7/16" male
Gas type	Medical Grade Carbon Dioxide
Dimensions	380 x 120 x 360 mm (WxDxH)
Weight	11kg

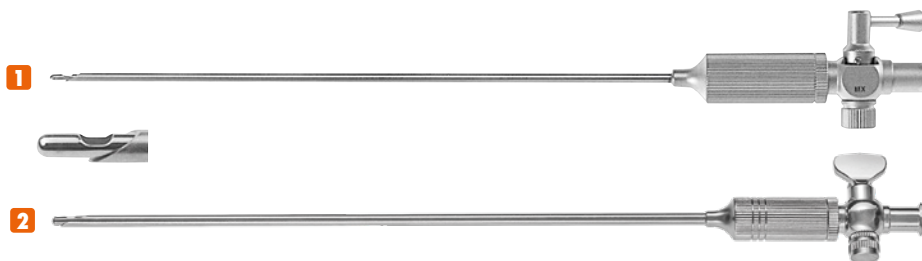

- 1** Insufflation needle, matt chrome,  $\varnothing$  2 mm
- 300-195-080 80 mm
  - 300-195-100 100 mm\*
  - 300-195-120\* 120 mm\*
  - 300-195-150 150 mm\*
  - 300-195-170 170 mm
  - 300-195-200 200 mm

- 2** Insufflation needle, polished chrome,  $\varnothing$  2.7 mm, High-Flow
- 300-195-300 100 mm
  - 300-195-320 120 mm\*
  - 300-195-350 150 mm\*
  - 300-195-370 170 mm\*

\* standard length

Accessories (included):



Sterile Filter\*  
300-902-007



Standard Silicone Tube  
300-902-005



Gas heater with tube (only Heater-Version)  
300-902-001



CO2 High Pressure Tube  
300-902-003



Silicone Tube (only Heater-Version)  
300-902-004



Optional available:  
300-902-008  
CO2 Bottle, 0.75kg, empty

\* Trade Product:  
Products marked with this TradeProduct-Symbol are not available with RZ-Marking and not with the CE-number of RZ.

### SUCTION & IRRIGATION PUMP

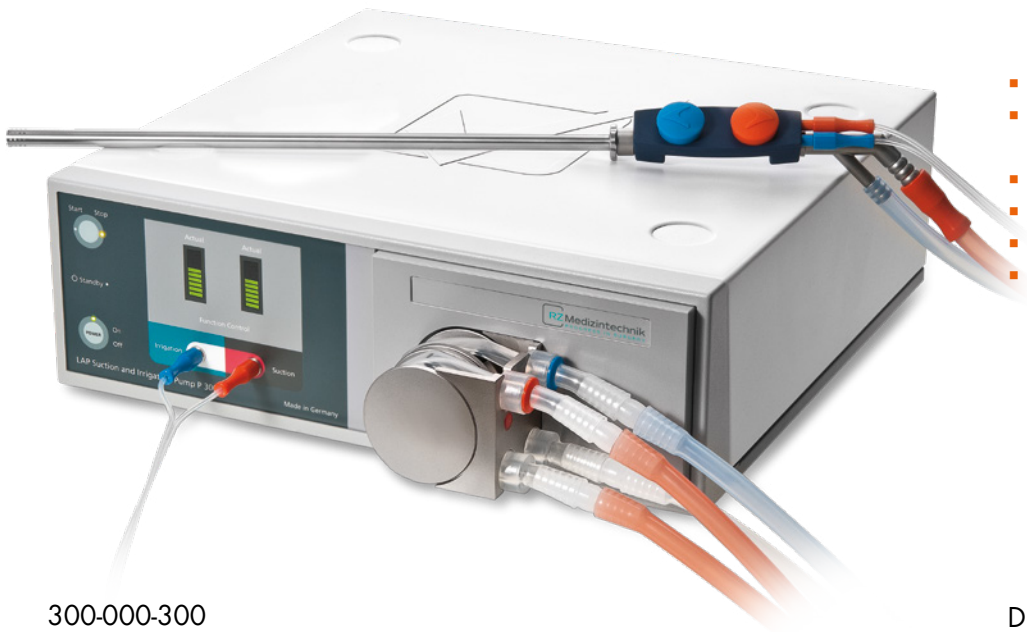

#### Features:

- Double roll pump for precise suction and irrigation during Laparoscopic surgeries
- Optional footswitch available
- Digital display of actual suction and irrigation pressures
- High flow rates up to 3L/min
- Color coded tubing sets
- Standby function
- Hand remote controlled

#### DELIVERY CONTAINS:

- Pump device (300-000-300)
- Cannula 5mm (300-000-302)
- Cannula 10mm (300-000-303)
- Silicone Tubing Set (300-000-301)
- Tube Adapter (300-000-304)
- Pneumatic Control Handle (300-000-305)
- Double-Lumen Control Tube (300-000-306)
- Mains cable
- 2 Spare fuses
- Operating manual

300-000-300

LAP Suction and Irrigation Pump P 3000, complete set

#### Technical data

Line voltage	100-240 VAC
Power input	36W
Irrigation power	0 - 3.000ml/min
Suction power	0 - 3.000ml/min
Max. pressure	0 - 750mmHg
Measurements	380 x 130 x 400mm (WxHxD)
Weight	approx. 11kg

#### Accessories



300-000-304

Adapter with instrument connector, autoclavable

300-000-307

Pneumatic double footswitch

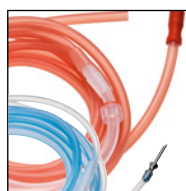

300-000-301 (included)

Tubing Set, non-sterile, autoclavable

300-000-301S (optional)

Tubing Set, single-use, sterile, moq: 50 pcs.

## SUCTION &amp; IRRIGATION PUMP



300-000-100  
LAP Suction and Irrigation Pump P1000, complete set

## Technical data

Line voltage	100-240 VAC
Power input	80VA
Irrigation power	3L/min
Suction power	3L/min
Max. vacuum	- 525mmHG
Max. pressure	0 - 750mmHG
Measurements	380 x 120 x 360mm (WxHxD) with Aspiration Bottle Retainers approx. 440 x 120 x 360mm
Weight	Device: approx. 11kg Aspiration Bottle-Retainer: (for 1 Liter = 0.34kg, for 2 Liter = 0.44kg)

## Features:

- Dual suction and irrigation vacuum pump
- Digital display of suction and irrigation pressures
- High rates up to 3L/min
- Color coded tubing sets
- Standby function
- Low noise level
- Hydrophobic disposable filters

## DELIVERY CONTAINS:

- Pump device (300-000-100)
- Suction and irrigation tubing set (300-000-102)
- Aspiration bottle 2L with overflow valve (300-000-101)
- Puncture tube 235mm (300-001-521)
- 2 Hydrophobic disposable sterile filters (300-000-103)
- 2 Bottle holders with screws
- Mains cable
- 2 Spare fuses
- Operating manual

## Accessories (optional available)



300-000-110  
Start/Stop - Footswitch

ICG  
**CONSENS**  
 ICG/NIR FLUORESCENCE  
 CAMERA SOLUTION

The visualization  
 platform VP2

**4K**



- Camera, illumination and recording combined in a single control unit
- One-click switching between white light, ICG/NIR and fusion visualization modes
- Integrated LED white light and NIR illumination laser-free technology
- Ergonomic camera head and centralized control designed for focused surgical handling
- Native 4K imaging provide ultra-high-definition visualization



Multifunctional camera head



High transmission light cable

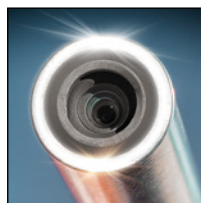

Laser-free LED Illumination



8.4" LCD capacitive touchscreen



CONSENS VP2  
ICG 4K Camera and light source  
including camera head

300-700-100



CONSENS ICG 4K Camera Head only  
with fixed 2.8m cable

300-700-110

## ACCESSORIES (for ICG/NIR use)

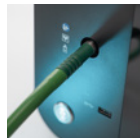

CONSENS ICG/NIR LED Light Cable  
Ø 4.8mm, 2300mm, with adapter

250-148-230



CONSENS TV-Coupler (compatible ICG/NIR)  
f14 - 32, C-mount

250-015-040

### 4K CAMERA SYSTEM



#### Features:

- 4K UHD resolution with 3-chip technology
- Image algorithm enhancement of color and structure
- 4K video recording
- 4K image saving
- Camera head with 4 programmable buttons
- Boost function
- Fog reduction
- Freeze function
- 2.5x digital zoom
- 10 USER mode configurations
- Multilingual on screen menu
- SDI 4K Output
- Text generator (optional with keyboard)

#### DELIVERY CONTAINS:

- Main Unit (300-001-840)
- Camera head (300-001-841)
- HDMI cable
- USB Pen Drive
- Mains cable
- Operating manual

300-001-840 4K 3-Chip UHD-Camera K 4000

# 4K

#### Technical data

Line voltage	100-240 VAC
Power consumption	60VA
Image sensor	3 MOS
Resolution	3840 x 2160 pixels (4K)
Index ratio	16:9
N/N ratio	54db

Video outputs	1x HDMI 4K 1x HDMI FullHD 1x SDI 4K 1x SDI FullHD
Dimensions	Control unit: 355 x 103 x 350mm (WxHxD) Weight control unit: 6.2kg Weight camera head: 145g

#### Accessories



300-001-841  
UHD 3-Chip Camera Head  
(included in the set)



300-001-615  
Title generator keyboard, waterproof IP68  
US-Layout, cable 1.8m, color: grey,  
305x140x15mm, 600gr.



300-001-610  
Footswitch for HD Cameras  
cable length: 2m

### FULL HD CAMERA SYSTEM



#### Features:

- Full HD camera with 3-chip MOS technology
- Pure Natural Colors technology
- Full HD video recording (F4 only)
- Full HD image saving (F4 only)
- Camera head with 3 programmable buttons
- Boost function
- Freeze function
- 2.5x digital zoom
- 3 USER mode configurations
- Multilingual on screen menu
- Different digital video outputs
- Text generator (optional with keyboard)

300-001-800 3 Chip HD-Camera F3  
 300-001-804 3 Chip HD-Camera F4 (with recording function)

# FULL HD

#### Technical data

Line voltage	100-240 VAC
Power input	20W
Image sensor	3 MOS
Resolution	1920 x 1080 pixels (FullHD)
Image resolution	>1000 TV lines, horizontal
Index ratio	16:9
Min. sensitivity	< 3lx (1/1.4)
Shutter speed	1/50 (1/60) to 1/100.000sec

<b>Video outputs (F4)</b>	2 x HD SDI 1x HDMI / DVI 2x CVBS 1 x YPbPr / RGB 1 x Y/C (Pal/NTSC) 1x CVBS (Pal/NTSC)
<b>Video outputs (F3)</b>	1 x HDMI / DVI 1 x YPbPr (Component) 1 x Y/C (Pal/NTSC) 1x CVBS (Pal/NTSC)
<b>Dimensions</b>	Control unit: 380 x 120 x 360mm (WxHxD) Weight control unit: 11kg Weight camera head: 145g

#### Accessories



300-001-802  
 High-End 3-MOS Camera Head  
 FullHD (included in the set)



300-001-615  
 Title generator keyboard, waterproof IP68  
 US-Layout, cable 1.8m, color: grey,  
 305x140x15mm, 600gr.



300-001-610  
 Footswitch for HD Cameras  
 cable length: 2m

### FULL HD CAMERA SYSTEM



#### Features:

- Full HD camera with 1-chip MOS technology
- Natural color technology
- Full HD video recording (F2 Pro only)
- Full HD image saving (F2 Pro only)
- Camera head with 3 programmable buttons
- Boost function
- Freeze function
- 2.5x digital zoom
- 3 USER mode configurations
- Multilingual on screen menu
- HDMI video outputs
- Text generator (optional with keyboard)

- 300-001-600 HD-Camera F1
- 300-001-601 HD-Camera F2 Pro (with recording function)

#### DELIVERY CONTAINS:

- Main Unit
- Camera head
- 2x BNC cable
- HDMI - DVI cable
- HDMI cable
- S-Video cable
- USB Pen Drive (F2 Pro only)
- Operating manual
- Mains cable

# FULL HD

#### Technical data

Line voltage	100-240 VAC
Power input	F2 Pro: 30W / F1: 20W
Image sensor	1/3" MOS
Resolution	1920 x 1080 pixels (FullHD)
Image resolution	>1000 TV lines, horizontal
Index ratio	16:9
Min. sensitivity	< 3lx (1/1.4)

<b>Video outputs (F2 Pro)</b>	2 x HD SDI (optional) 1 x HDMI / DVI 1 x Y-Pb-Pr (Component) 1 x Video (PAL/NTSC) 1 x S-Video (PAL/NTSC)
<b>Video outputs (F1)</b>	1 x HDMI 1 x YPbPr / RGB 1 x S-Video (Y/C; Pal / NTSC) 1 x Video (CVBS; Pal / NTSC)
<b>Dimensions</b>	Control unit: 380 x 120 x 360mm (WxHxD) Weight control unit: 11kg Weight camera head: 105g

#### Accessories



300-001-602  
High-End 1/3" MOS Camera Head  
Full HD (included in the set)



300-001-615  
Title generator keyboard, waterproof IP68  
US-Layout, cable 1.8m, color: grey,  
305x140x15mm, 600gr.



300-001-610  
Footswitch for HD Cameras  
cable length: 2m

## TV COUPLER



**4K**  
**FULL HD**

300-001-823 f=14mm  
300-001-824 f=25mm  
300-001-825 f=28mm  
c-mount, soakable



**4K**  
**FULL HD**

250-015-030  
Zoom-TV-Adapter  
f=15 - 30mm  
c-mount, soakable



**4K**  
**FULL HD**

250-015-036  
Zoom-TV-Adapter  
f=15 - 36mm  
c-mount, soakable



**FULL HD**

300-001-813 f=14mm  
300-001-814 f=25mm  
c-mount, soakable



**FULL HD**

250-022-018 f=18mm  
250-022-025 f=25mm  
90°, c-mount, soakable

## RZ MEDIA WORKSTATION Innovative Documentation System – the stand alone “all in one” solution

Sophisticated users get a comprehensive tool for creating, documenting and archiving of videos, pictures and findings.

An extensive set of tools gives the ability for easy creation of individual and complex findings reports. Easy integration into IT-environment ensures an optimal workflow. The database provides long-term availability of picture findings with almost no capacity limitation.

### Diagnostics & Results

- Recording of videos and pictures
- PACS support DICOM worklist/store
- Playing videos with abstraction of individual images
- Manual input of comments and markers for sessions and recordings
- Graphical markers with individual comments
- Creation of reports incl. patient information, pictures, videos and comments
- Full-text search in data base
- User management including import, adaption and export of patients
- LIVE OR communication via e.g. Zoom, Skype or Teams
- Hospital Safety guidelines  
(Windows based network and firewall)



Documentation System 21" touch

300-001-199 OR version with DICOM worklist

300-001-198 without DICOM worklist



## LED LIGHT SOURCE



### Features:

- 6500K daylight color temperature
- 375 Watt equivalent output power
- > 20.000 hours lifetime
- Turret connector for the most common light cables (Olympus, Wolf, Gyrus ACMI, Storz)
- Manual or automatic light control
- Waterproof touch control panel
- Low heat conduction by improved LED technology
- Boost function: light increase of 20%

300-900-300 LUMEN LED 3 PRO Light Source, 110 - 230V



### Technical data

Line voltage	100-240 VAC
Video input	1x Video, BNC
Protection class	1 (acc. IEC 60601-1) 1 (acc. MDD 93/42/EEC)
Safety class	BF
Standard	IEC 60601-1-2
Dimensions	380 x 120 x 360mm (WxHxD)
Weight	approx. 11kg

### DELIVERY CONTAINS:

- Main Unit (300-900-300)
- BNC cable (optional)
- Mains cable
- Operating manual



Turret, multi connector

A **OLYMPUS**

B **RICHARD WOLF**

C **GYRUS ACMI**

D **STORZ**  
KARL STORZ ENDOSKOPE

## LED LIGHT SOURCE



## Features:

- More than 20.000h lamp lifetime
- 180 Watt equivalent power output
- Manual or automatic light control
- Waterproof touch control panel
- Low heat conduction by improved LED technology
- Daylight color temperature 6000 – 6500° K for accurate color representation
- Boost function: light increase of 20%

300-900-180 LUMEN LED 1 Light Source



## DELIVERY CONTAINS:

- Main Unit (300-900-180)
- BNC cable
- Mains cable
- Operating manual

## Technical data

Line voltage	100-240 VAC
Power consumption	130VA
Video input	1x Video, 1x S-Video (Y/C) (automatic version only)
Protection class	1 (acc. IEC 60601-1) 1 (acc. MDD 93/42/EEC)
Safety class	BF
Dimensions	380 x 120 x 360mm (WxHxD)
Weight	approx. 11kg

## HIGH TEMPERATURE LED/XENON LIGHT CABLES

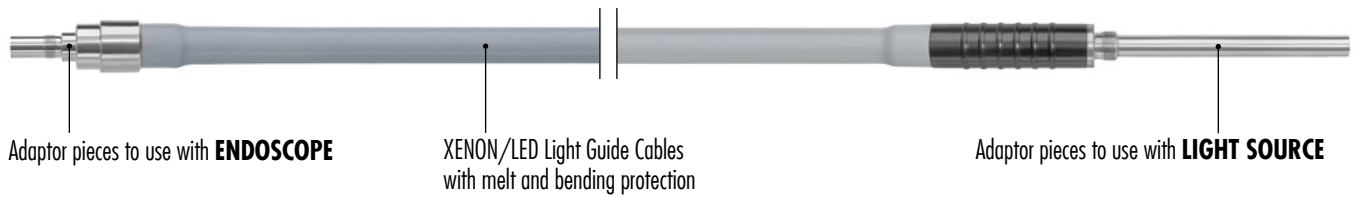

250-042-000  
250-042-400 for ICG/NRI  
RZ/Storz/Olympus



250-040-000  
Wolf



250-041-000  
ACMI/British Standard

250-025-230	Ø 2.5mm, 2300 mm
250-025-300	Ø 2.5mm, 3000 mm
250-035-180	Ø 3.5mm, 1800 mm
250-035-230	Ø 3.5mm, 2300 mm
250-035-300	Ø 3.5mm, 3000 mm
250-048-180	Ø 4.8mm, 1800 mm
250-048-230	Ø 4.8mm, 2300 mm
250-048-300	Ø 4.8mm, 3000 mm



250-039-000  
250-039-400 for ICG/NRI  
RZ/Storz



250-038-000  
ACMI/CUDA



250-048-000  
Luxtec



250-051-000  
Stryker



250-037-000  
250-037-400 for ICG/NRI  
Wolf



250-044-000  
Olympus



250-045-000  
Olympus - Standard



250-052-000  
Heine



250-059-000  
Pentax

## ICG/NIR LIGHT CABLE



CONSENS ICG/NIR LED Light Cable  
Ø 4.8mm, 2300mm, with adapter

250-148-230

### COMPATIBILITY NOTE:

A fiber optic cable with a large diameter should not be connected to a smaller diameter scope.  
For example: Ø 4.8mm fiber optic cables connected to a Ø 2.9mm may risk high temperature at the light entry of the endoscope and may risk patient safety.

### ELECTROSURGICAL GENERATOR



#### Features:

- Monopolar/bipolar cutting and coagulation
- Automatic identification of connected instruments
- Powerstart System simplifies the beginning of cutting process
- Automatic power regulation
- 105 different memory locations in 7 groups
- Various output configuration of the sockets available
- 10" Touchscreen
- Tiltable display
- Footswitch (optional)
- Available with Argon and / or the RZeal
- Real-time output monitoring

700-350-400 Electrosurgical Generator G400, 230V

700-350-410 Electrosurgical Generator G400, 110V

#### DELIVERY CONTAINS:

- Main Unit
- Mains Cable (Footswitch not included)

#### Technical data

Line voltage	230 V +/- 10% 50 Hz or 110 V +/- 10% 60 Hz
Power consumption	1350VA
Generator operation frequency	333kHz
Display	TFT 10"
Defibrillation impulse resistance	acc. to to EN 60601-1
NEM system	neutral electrode control optical indication 7 levels required resistance < 240 Ω
Gas type	pure argon 4.8 (99,998%) or higher
Inlet gas pressure	0.25-0.4 [MPa]
Monopolar coagulation / cutting	200W / 400W
Bipolar coagulation / cutting	400W / 400W

Gas outflow	0.1-10 l/min, regulated 0.1 l/min in whole range
Pressure range	reducer (0.4 MPa) on argon cylinder
Vessel sealing system	9 effects/300W
AutoStop	automatic stop of sealing process after achieving the optimal effect
Dimensions	495 x 415 x 225mm (LxWxH)
Weight	12.2kg

#### Accessories



700-350-405  
2-Button-Footswitch, length: 5m

700-350-402  
3-Button-Footswitch, length: 5m, quick access key



Disposable Neutral Electrode  
hydrogel, split, for adults or children  
10x5 pcs. per package  
700-503-000 Adults  
700-503-001 Children



Cable for Disposable Neutral Electrode  
5m, RZ compatible only  
700-503-003

## ELECTROSURGICAL GENERATOR



Features:

- Monopolar/bipolar cutting and coagulation
- Automatic instrument detection system
- Intuitive Touchscreen
- Automatic power regulation
- Configurable working modes
- Real-time parameter control
- Special endoscopic modes
- Bipolar resection
- Easy software update

700-340-400 Electrosurgical Generator G44, 230V

700-340-410 Electrosurgical Generator G44, 110V

DELIVERY CONTAINS:

- Main Unit
  - Mains Cable
- (Footswitch not included)

Technical data

Line voltage	230 V +/- 10% 50 Hz or 110 V +/- 10% 60 Hz
Power consumption	1350VA
Generator operation frequency	333kHz
Display	TFT 7" WVGA
Spectrum result system	automatic power regulation
Monopolar coagulation	max. 200W (200Ω)
Monopolar cutting	max. 400W (100Ω)
Bipolar coagulation	max. 400W (25Ω)
Bipolar cutting	max. 330W (150Ω)

NEM system	neutral electrode control, optical indication, required resistance < 240 Ω
Dimensions	385 x 305 x 141mm (LxWxH)
Weight	7kg

Accessories



700-350-405  
2-Button-Footswitch, length: 5m

700-350-402  
3-Button-Footswitch, length: 5m, quick access key



Disposable Neutral Electrode  
hydrogel, split, for adults or children  
10x5 pcs. per package  
700-503-000 Adults  
700-503-001 Children



Cable for Disposable Neutral Electrode  
5m, RZ compatible only  
700-503-003



Endovue HD Monitor  
 300-001-168 32"  
 300-001-158 27"

### Technical data

Screen size	31.5" / 27" diagonal
Resolution	1920 x 1080
Aspect ratio	16:9
Viewing angle	178°
Numbers of colors	16.7 Million (8-bit)
Video Inputs	DVI-D, RGBS/VGA/YPbPr (HD-15 or DVH via adapter), S-Video, Composite
Video Outputs	DVI-D
Weight	8.8kg (300-001-168) 6.7kg (300-001-158)



300-001-031  
 UHD 4K Monitor, 31"

### Technical data

Screen size	31" diagonal
Resolution	4096 x 2160
Aspect ratio	17:9
Viewing angle	178°
Number of colors	1.08 Billion (10-bit)
Video Inputs	1 x HDMI 2.0 1 x DP 1.2 (SST) & 1 x DP 1.2 (MST) 1 x DVI (single link), 4 x SDI (3G)
Video Outputs	1 x DP 1.2 (SST) 1 x DVI (single link), 4 x SDI (3G)
Weight	10.5kg

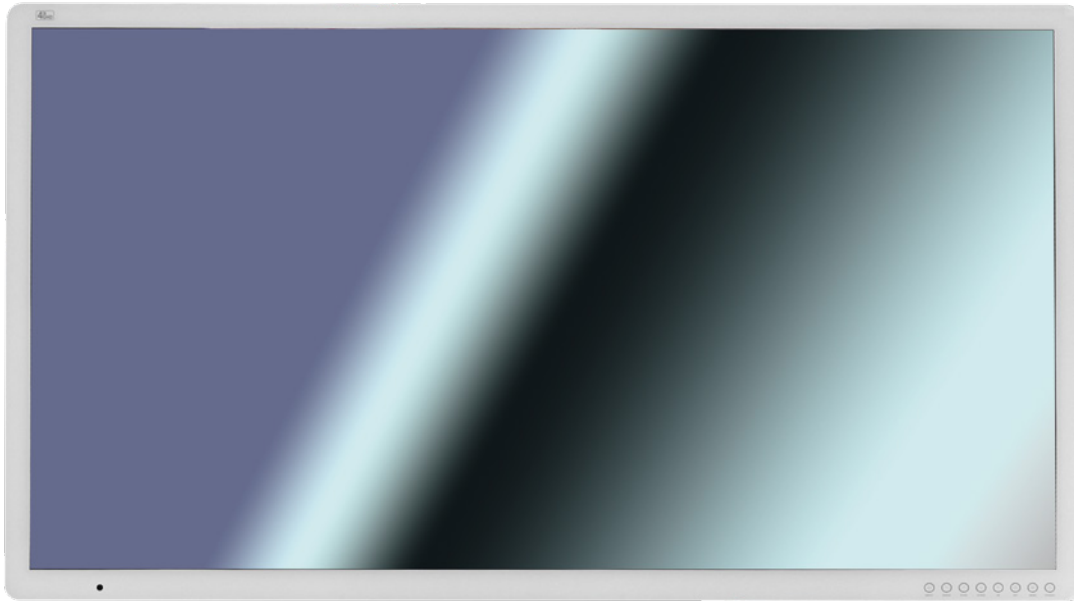

300-001-055  
UHD 4K Monitor, 55"

### Technical data

<b>Screen size</b>	55" diagonal
<b>Resolution</b>	3840 x 2160
<b>Aspect ratio</b>	16:9
<b>Viewing angle</b>	178°
<b>Numbers of colors</b>	1.08 Billion (10-bit)
<b>Video Inputs</b>	1 x HDMI 2.0, 2 x DP 1.2 (55T) 1 x DVI (single link), 2 x DVI (dual link) 4 x SDi (3G), 2 x SDi (12G)
<b>Video Outputs</b>	1 x DVI (single link), 1 x DP 1.2 (SST) 4 x SDi (3G), 2x SDi (12G)
<b>Weight</b>	37.35kg



300-001-028  
Monitor Table Stand

### Technical data

<b>Column height</b>	305mm, 12"
<b>Oriantations</b>	Landscape or page mode
<b>Adjustments</b>	+/- 20°
<b>Max. load</b>	31" / 13.6kg / 30lbs

All monitors will be delivered without table stand - need to be ordered separately.

## CONSENS Cart - EQUIPMENT TROLLEYS

## Features:

- Front handle
- Camera holder (ocular)
- 4 antistatic wheels with brake
- Drawer
- 8-outlet power strip
- Adjustable heights



300-002-910  
CONSENS Cart Basic



300-002-920  
CONSENS Cart Essential  
shelf with monitor holder



300-002-930  
CONSENS Cart Advanced  
shelf with monitor holder,  
pivoted second monitor holder,  
wheel wall deflectors

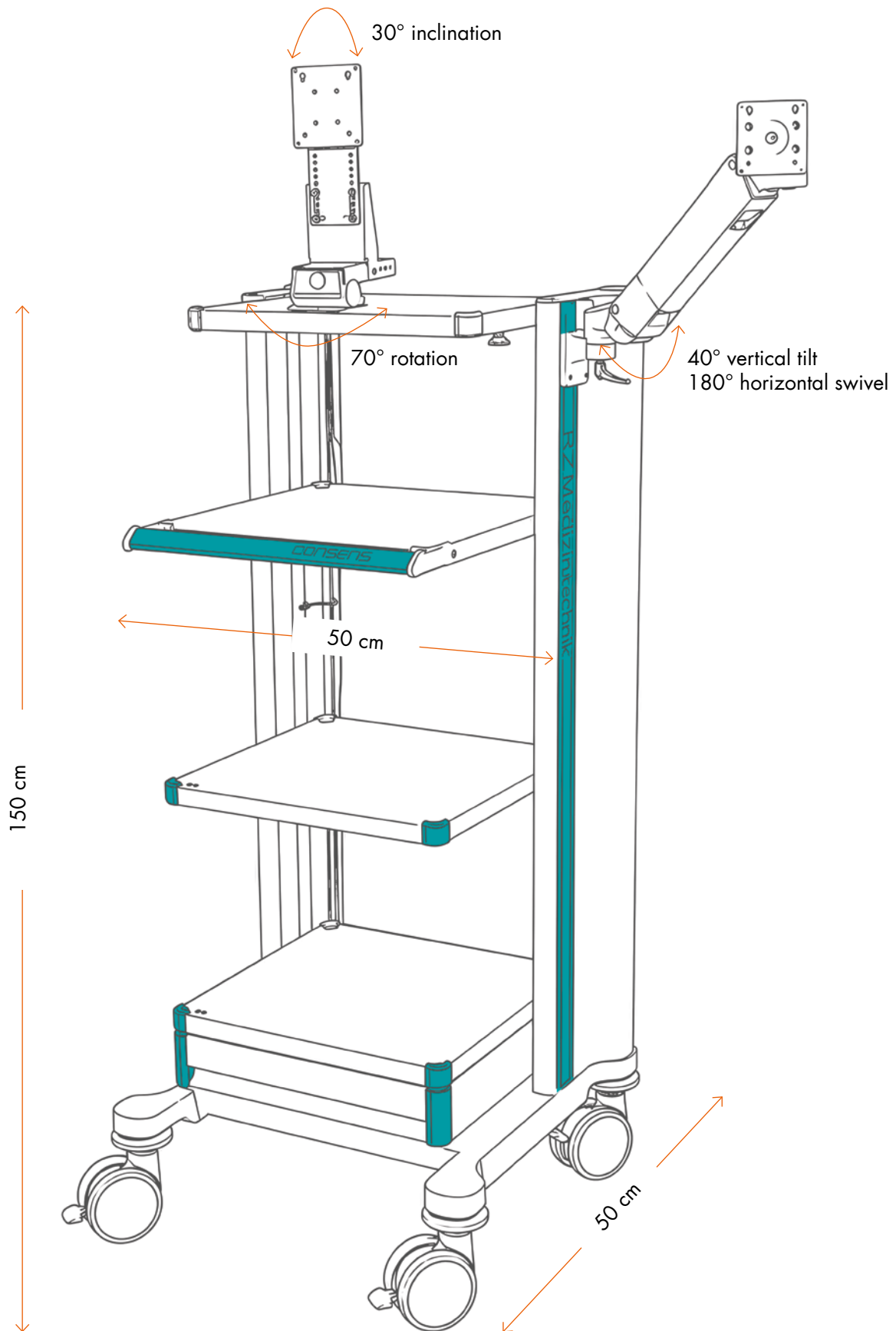

110-110-003	7	250-048-180	177	300-002-930	182
120-511-145	7	250-048-230	6, 177	300-006-305	37
120-611-180	8	250-048-300	177	300-006-455	37
130-140-120	7	250-051-000	177	300-012-106	29
140-254-125	8	250-052-000	177	300-012-116	29
140-573-130	8	250-059-000	177	300-012-121	29
150-050-180	8	250-148-230	169, 177	300-012-405	4, 29, 112
170-801-500	10	300-000-095	153	300-012-410	29
170-801-501	10	300-000-100	167	300-012-412	29
170-801-502	10	300-000-101	167	300-012-415	29
170-801-503	10, 12	300-000-102	167	300-012-416	29
170-801-504	12	300-000-103	167	300-012-420	29
170-801-505	12	300-000-110	167	300-012-421	29
170-801-506	10, 12	300-000-300	166	300-012-425	29
170-801-507	10, 12	300-000-301	166	300-012-455	4, 29
170-801-508	12	300-000-302	166	300-013-115	30
170-801-510	10, 11	300-000-303	166	300-013-500	30
170-801-511	10, 11	300-000-304	166	300-013-510	30
170-801-512	10, 11	300-000-305	166	300-013-511	30
170-801-515	10, 11	300-000-306	166	300-013-512	30
170-802-520	11	300-000-307	166	300-013-522	30
170-802-521	11	300-001-028	181	300-014-111	30
170-802-522	11	300-001-031	180	300-014-113	30
180-550-160	8	300-001-055	181	300-014-155	30
250-015-030	173	300-001-158	180	300-014-711	30
250-015-036	173	300-001-168	180	300-019-500	34
250-015-040	169	300-001-198	174	300-019-501	34, 138
250-022-018	173	300-001-199	174	300-019-600	34
250-022-025	173	300-001-521	167	300-019-601	34, 138
250-025-230	177	300-001-600	172	300-019-700	138
250-025-300	177	300-001-601	172	300-019-705	34
250-035-180	177	300-001-602	172	300-019-710	34
250-035-230	177	300-001-610	170, 171, 172	300-019-735	34, 138
250-035-300	177	300-001-615	170, 171, 172	300-019-770	34, 138
250-037-000	177	300-001-800	171	300-019-780	34, 138
250-037-400	177	300-001-802	171	300-019-805	34
250-038-000	177	300-001-804	171	300-019-810	34
250-039-000	7, 177	300-001-813	173	300-020-015	24
250-039-400	177	300-001-814	173	300-020-020	24
250-040-000	177	300-001-823	173	300-020-115	28
250-041-000	177	300-001-824	173	300-020-120	28
250-042-000	7, 177	300-001-825	173	300-020-211	31
250-042-400	177	300-001-840	170	300-020-215	28
250-044-000	177	300-001-841	170	300-020-220	28
250-045-000	177	300-002-910	182	300-020-255	31
250-048-000	177	300-002-920	182	300-020-711	31

300-020-755	31	300-073-000	82	300-100-694	105
300-020-915	28	300-073-450	82	300-100-695	105
300-020-920	28	300-075-001	82	300-100-696	105
300-021-011	4, 29	300-075-002	82	300-100-697	105, 128
300-021-111	31	300-075-101	82	300-100-698	105, 128
300-021-125	29	300-075-102	82	300-100-699	105
300-021-155	31	300-076-001	83	300-100-702	105
300-021-305	29	300-076-101	83	300-100-703	105
300-021-310	29	300-077-000	83	300-100-760	80
300-021-355	29	300-091-100	6, 15	300-100-771	94, 96
300-021-380	29	300-091-130	15	300-100-772	94, 96, 128
300-021-405	29	300-091-145	15	300-100-773	94, 96
300-021-410	29	300-091-430	15	300-100-774	94, 96
300-021-455	29	300-091-433	15	300-100-776	94
300-021-755	31	300-091-445	15	300-100-777	94
300-023-100	32	300-092-100	16	300-100-778	94
300-023-111	31	300-092-130	6, 16	300-100-779	94
300-023-255	31	300-092-145	16	300-100-786	94, 128
300-023-711	31	300-096-450	16	300-100-789	94, 128
300-023-755	31	300-096-453	16	300-100-798	95
300-024-111	31	300-096-455	16	300-100-799	95
300-024-155	31	300-097-100	16	300-101-588	108
300-024-711	31	300-097-130	16	300-101-589	108
300-024-755	31	300-098-105	32	300-101-592	108
300-025-358	28	300-099-006	17, 86	300-101-593	109
300-025-359	28	300-099-033	81	300-101-594	108
300-030-000	112	300-099-100	81	300-101-596	108
300-030-001	7, 112	300-099-133	81	300-101-599	108
300-030-003	112	300-099-140	81	300-101-775	93, 97
300-030-004	112	300-099-500	17	300-101-777	95
300-030-006	112	300-100-120	86	300-110-711	84
300-032-015	86	300-100-122	86	300-110-714	84
300-033-010	86	300-100-125	86	300-110-715	84
300-042-005	86	300-100-127	86	300-111-013	55
300-042-010	86	300-100-131	39	300-111-033	55
300-063-000	81	300-100-132	39	300-111-775	93, 128
300-065-000	81	300-100-133	39	300-112-035	24, 136
300-065-100	81	300-100-134	39	300-135-905	162
300-069-000	5, 82	300-100-400	14	300-135-910	162
300-069-450	82	300-100-430	14	300-144-002	6, 40
300-070-000	82	300-100-687	105	300-144-004	40
300-070-450	82	300-100-688	105	300-144-005	6, 40
300-071-000	83	300-100-689	105	300-144-006	40
300-071-450	83	300-100-691	105	300-144-452	40
300-072-000	82	300-100-692	105	300-144-454	40
300-072-450	82	300-100-693	105	300-144-455	40

300-144-456	40	300-192-000	36, 140	300-200-400	14
300-145-003	40	300-192-003	36, 140	300-200-430	14
300-145-004	40	300-192-005	36	300-215-000	162
300-145-005	40	300-192-010	36	300-219-011	25
300-145-006	40	300-192-253	140	300-219-013	25
300-145-453	40	300-193-003	36, 140	300-219-055	25
300-145-454	40	300-193-005	36	300-220-011	22
300-145-455	40	300-193-010	36	300-220-013	22
300-145-456	40	300-193-253	140	300-220-055	22, 136
300-151-000	7, 111	300-193-303	140	300-220-111	126
300-151-100	111	300-193-305	37	300-220-113	126
300-152-000	111	300-193-330	80	300-220-155	126
300-152-011	27	300-193-335	7, 37	300-220-211	25
300-152-012	27	300-193-353	140	300-220-213	25
300-152-055	27, 137	300-193-405	37	300-220-255	25
300-153-000	111	300-193-410	37	300-220-311	126
300-154-055	27	300-194-303	140	300-220-313	126
300-154-125	27	300-194-307	37	300-220-355	126
300-155-400	14	300-194-309	37	300-221-011	22
300-155-430	14	300-194-312	37	300-221-013	22
300-163-110	38	300-194-314	7, 37	300-221-055	22, 136
300-163-120	38	300-194-318	37	300-221-111	126
300-163-130	38	300-194-353	140	300-221-113	126
300-163-140	38	300-194-412	37	300-221-155	126
300-163-410	41	300-194-414	37	300-221-211	25
300-163-420	41	300-194-418	37	300-221-213	25
300-163-430	41	300-195-080	32, 164	300-221-255	25
300-163-450	41	300-195-100	32, 164	300-221-311	126
300-163-610	41	300-195-120	4, 32, 164	300-221-313	126
300-163-620	41	300-195-150	32, 164	300-221-355	126
300-163-630	41	300-195-170	32, 164	300-222-011	4, 22
300-163-650	41	300-195-200	32, 164	300-222-013	4, 22
300-163-820	38	300-195-300	32, 164	300-222-055	4, 22, 136
300-163-830	38	300-195-320	32, 164	300-222-211	25
300-165-100	35, 139	300-195-350	32, 164	300-222-213	25
300-166-000	38	300-195-370	32, 164	300-222-255	25
300-166-100	7, 35, 139	300-200-131	148	300-223-011	22
300-167-100	35	300-200-132	148	300-223-013	22
300-172-003	35, 139	300-200-133	148	300-223-055	22, 136
300-172-005	35	300-200-134	148	300-224-011	22
300-172-010	35	300-200-137	148	300-224-013	22
300-172-253	139	300-200-231	148	300-224-055	22, 136
300-173-003	35, 139	300-200-232	148	300-224-111	126
300-173-005	7, 35	300-200-233	148	300-224-113	126
300-173-010	7, 35	300-200-234	148	300-224-155	126
300-173-253	139	300-200-237	148	300-226-011	22

300-226-013	22	300-240-015	26	300-300-100	107
300-226-055	22	300-240-020	26	300-300-101	107
300-229-011	25	300-240-035	26, 137	300-300-130	103
300-229-013	25	300-240-055	26, 137	300-300-131	103
300-229-055	25	300-240-111	127	300-300-140	4, 103
300-230-011	23	300-240-113	127	300-300-141	4, 103
300-230-013	23	300-240-155	127	300-300-142	103
300-230-055	23, 136	300-241-011	4, 26	300-300-160	103
300-230-111	126	300-241-013	4, 26	300-300-161	103
300-230-113	126	300-241-015	26	300-300-170	103
300-230-155	126	300-241-020	26	300-300-171	103
300-231-011	23	300-241-035	26, 137	300-300-172	103
300-231-013	23	300-241-055	4, 26, 137	300-300-200	107
300-231-055	23, 136	300-241-111	127	300-300-201	107
300-231-111	126	300-241-113	127	300-300-230	103
300-231-113	126	300-241-155	127	300-300-231	103
300-231-155	126	300-242-011	26	300-300-240	103
300-232-011	23	300-242-035	26, 137	300-300-241	103
300-232-013	23	300-242-055	26, 137	300-300-242	103
300-232-055	23, 136	300-243-011	27	300-300-260	103
300-233-011	23	300-243-013	27	300-300-261	103
300-233-013	23	300-243-055	27	300-300-270	103
300-233-055	23, 136	300-244-011	27	300-300-271	103
300-233-211	25	300-244-013	27	300-300-272	103
300-233-213	25	300-244-055	27	300-300-330	103, 141
300-233-255	25	300-244-111	127	300-300-340	103, 141
300-234-011	23	300-244-113	127	300-300-341	103, 141
300-234-013	23	300-244-155	127	300-300-360	103, 141
300-234-055	23, 136	300-250-011	28, 31	300-300-370	103, 141
300-234-111	126	300-250-013	28	300-300-371	103, 141
300-234-113	126	300-250-035	28, 137	300-300-430	103, 141
300-234-155	126	300-250-055	28, 31, 137	300-300-440	103, 141
300-234-211	25	300-250-111	28	300-300-441	103, 141
300-234-213	25	300-250-135	28, 137	300-300-460	103, 141
300-234-255	25	300-250-155	137	300-300-470	103, 141
300-234-311	126	300-250-211	28	300-300-471	103, 141
300-234-313	126	300-250-213	28	300-300-500	107
300-234-355	126	300-250-235	28, 137	300-300-501	107
300-236-011	23	300-250-255	28, 137	300-302-000	107
300-236-013	23	300-255-400	14	300-302-001	107
300-236-055	23	300-255-430	14	300-302-100	107
300-236-211	25	300-257-002	148	300-302-101	107
300-236-213	25	300-257-004	148	300-302-200	107
300-236-255	25	300-257-015	148	300-302-201	107
300-240-011	26	300-300-000	107	300-302-501	107
300-240-013	26	300-300-001	107	300-303-000	107

300-303-001	107	300-400-049	58	300-400-243	66
300-303-100	107	300-400-051	58	300-400-244	66
300-303-101	107	300-400-052	61	300-400-245	66
300-303-200	107	300-400-053	55	300-400-246	66
300-303-201	107	300-400-056	75	300-400-250	63
300-303-500	107	300-400-060	76	300-400-251	51
300-303-501	107	300-400-062	76	300-400-252	63
300-330-033	110	300-400-063	76	300-400-263	67
300-330-045	110, 128	300-400-065	75	300-400-264	67
300-332-033	110	300-400-067	46, 72	300-400-266	67
300-332-320	108	300-400-068	73	300-400-280	64
300-334-033	110	300-400-069	72	300-400-284	61
300-400-000	54	300-400-070	73	300-400-285	60
300-400-001	54	300-400-071	73	300-400-286	68
300-400-002	54	300-400-072	73	300-400-287	60
300-400-003	52	300-400-074	65	300-400-288	60
300-400-004	56	300-400-076	68	300-400-289	60
300-400-005	53	300-400-078	63	300-400-291	60
300-400-006	56	300-400-079	63	300-400-295	68
300-400-008	54	300-400-080	62	300-400-310	61
300-400-009	56	300-400-082	62	300-400-311	61
300-400-010	58	300-400-084	64	300-400-312	61
300-400-011	57	300-400-085	65	300-400-313	61
300-400-012	53	300-400-086	62	300-400-314	61
300-400-013	55	300-400-087	51	300-400-330	113
300-400-014	56	300-400-097	65	300-400-521	62
300-400-015	53	300-400-100	62	300-400-570	77
300-400-016	52	300-400-109	51	300-400-571	77
300-400-017	54	300-400-165	75	300-400-572	77
300-400-018	58	300-400-168	72	300-400-610	52
300-400-021	53	300-400-169	73	300-400-700	69
300-400-023	51	300-400-170	74	300-400-710	57
300-400-024	59	300-400-171	74	300-400-713	57
300-400-025	52	300-400-172	72	300-400-715	57
300-400-026	59	300-400-173	75	300-400-717	57
300-400-027	49	300-400-180	74	300-400-720	69
300-400-029	54	300-400-181	74	300-400-730	50
300-400-030	68	300-400-197	65	300-400-731	48
300-400-032	59	300-400-200	70	300-400-732	48
300-400-033	55	300-400-201	56	300-400-733	48
300-400-040	52	300-400-202	70	300-400-734	50
300-400-042	59	300-400-204	71	300-400-735	49
300-400-044	51	300-400-206	70	300-400-736	49
300-400-045	59	300-400-220	71	300-400-737	50
300-400-046	59	300-400-221	71	300-400-738	48
300-400-048	58	300-400-234	64	300-400-739	50

300-400-740	49	300-404-330	101	300-410-100	62
300-400-741	49	300-404-340	101	300-410-109	51
300-400-751	69	300-404-341	101	300-410-165	75
300-400-753	69	300-404-732	145	300-410-168	72
300-400-775	93	300-404-738	145	300-410-169	73
300-400-781	69	300-405-130	99	300-410-170	74
300-400-900	45	300-405-131	99	300-410-171	74
300-400-901	45	300-405-140	99	300-410-172	72
300-401-001	130	300-405-141	99	300-410-173	75
300-401-013	130	300-405-142	99	300-410-180	74
300-401-015	130	300-405-330	101	300-410-181	74
300-401-017	130	300-405-340	101	300-410-251	51
300-401-025	129	300-405-341	101	300-410-521	62
300-401-067	133	300-406-130	99	300-410-570	77
300-401-070	133	300-406-131	99	300-410-571	77
300-401-072	133	300-406-140	99	300-410-572	77
300-401-078	132	300-406-141	99	300-410-730	50
300-401-079	132	300-406-142	99	300-410-731	48
300-401-082	132	300-410-003	52	300-410-732	48
300-401-085	133	300-410-016	52	300-410-733	48
300-401-201	131	300-410-023	51	300-410-734	50
300-401-289	131	300-410-024	59	300-410-735	49
300-401-291	131	300-410-025	52	300-410-736	49
300-401-710	131	300-410-026	59	300-410-737	50
300-401-713	57	300-410-027	49	300-410-738	48
300-401-730	129	300-410-032	59	300-410-739	50
300-401-732	129	300-410-040	52	300-410-740	49
300-401-738	129	300-410-042	59	300-410-741	49
300-401-739	129	300-410-044	51	300-410-775	93, 97
300-401-775	93	300-410-045	59	300-411-025	129
300-403-015	145	300-410-046	59	300-411-067	133
300-403-060	145	300-410-056	75	300-411-070	133
300-403-069	145	300-410-060	76	300-411-072	133
300-403-082	145	300-410-062	76	300-411-082	132
300-403-244	145	300-410-063	76	300-411-730	129
300-403-284	145	300-410-064	75	300-411-732	129
300-403-289	145	300-410-067	46, 72	300-411-738	129
300-403-732	145	300-410-068	73	300-411-739	129
300-403-738	145	300-410-069	72	300-411-775	93
300-404-015	145	300-410-070	73	300-420-003	52
300-404-060	145	300-410-071	73	300-420-016	52
300-404-069	145	300-410-072	73	300-420-023	51
300-404-082	145	300-410-080	62	300-420-024	59
300-404-244	145	300-410-082	62	300-420-025	52
300-404-284	145	300-410-086	62	300-420-026	59
300-404-289	145	300-410-087	51	300-420-027	49

300-420-032	59	300-420-738	48	300-430-234	64
300-420-040	52	300-420-739	50	300-430-243	66
300-420-042	59	300-420-740	49	300-430-244	66
300-420-044	51	300-420-741	49	300-430-245	66
300-420-045	59	300-421-025	129	300-430-246	66
300-420-046	59	300-421-067	133	300-430-250	63
300-420-056	75	300-421-082	132	300-430-252	63
300-420-060	5, 76	300-421-730	129	300-430-263	67
300-420-062	76	300-421-732	129	300-430-264	67
300-420-063	76	300-421-738	129	300-430-266	67
300-420-064	75	300-421-739	129	300-430-280	64
300-420-065	162	300-430-000	54	300-430-284	61
300-420-067	5, 46, 72	300-430-001	54	300-430-285	60
300-420-068	73	300-430-002	54	300-430-286	68
300-420-069	72	300-430-004	56	300-430-287	60
300-420-070	73	300-430-005	53	300-430-288	60
300-420-071	73	300-430-006	56	300-430-289	60
300-420-072	73	300-430-008	54	300-430-291	60
300-420-080	62	300-430-009	56	300-430-295	68
300-420-082	62	300-430-010	58	300-430-310	61
300-420-086	62	300-430-011	57	300-430-311	61
300-420-087	51	300-430-012	53	300-430-312	61
300-420-100	62	300-430-013	55	300-430-313	61
300-420-109	51	300-430-014	56	300-430-314	61
300-420-165	75	300-430-015	53	300-430-610	52
300-420-168	72	300-430-017	54	300-430-700	69
300-420-169	73	300-430-018	58	300-430-710	57
300-420-170	74	300-430-021	53	300-430-713	57
300-420-171	74	300-430-025	52	300-430-715	57
300-420-172	72	300-430-029	54	300-430-717	57
300-420-173	75	300-430-030	68	300-430-720	69
300-420-180	74	300-430-033	55	300-430-751	69
300-420-181	74	300-430-048	58	300-430-753	69
300-420-251	51	300-430-049	58	300-430-781	69
300-420-521	62	300-430-051	58	300-431-001	130
300-420-570	77	300-430-052	61	300-431-013	130
300-420-571	77	300-430-053	55	300-431-015	130
300-420-572	77	300-430-074	65	300-431-017	130
300-420-730	50	300-430-076	68	300-431-070	133
300-420-731	48	300-430-078	63	300-431-072	133
300-420-732	5, 48	300-430-079	63	300-431-078	132
300-420-733	48	300-430-084	64	300-431-079	132
300-420-734	50	300-430-085	65	300-431-085	133
300-420-735	5, 49	300-430-097	65	300-431-201	131
300-420-736	49	300-430-197	65	300-431-289	131
300-420-737	50	300-430-201	56	300-431-291	131

300-431-710	131	300-440-266	67	300-450-300	78
300-431-713	57	300-440-280	64	300-450-731	79
300-440-000	54	300-440-284	61	300-460-000	54
300-440-001	54	300-440-285	60	300-460-001	5, 54
300-440-002	54	300-440-286	68	300-460-002	54
300-440-004	56	300-440-287	60	300-460-004	56
300-440-005	53	300-440-288	60	300-460-006	56
300-440-006	56	300-440-289	60	300-460-008	54
300-440-008	54	300-440-291	60	300-460-009	56
300-440-009	56	300-440-295	68	300-460-010	58
300-440-010	58	300-440-310	61	300-460-011	5, 57
300-440-011	57	300-440-311	61	300-460-013	55
300-440-012	53	300-440-312	61	300-460-014	56
300-440-013	55	300-440-313	61	300-460-017	5, 54
300-440-014	56	300-440-314	61	300-460-018	58
300-440-015	53	300-440-610	52	300-460-029	54
300-440-017	54	300-440-700	69	300-460-030	68
300-440-018	58	300-440-710	57	300-460-033	55
300-440-021	53	300-440-713	57	300-460-048	58
300-440-025	52	300-440-715	57	300-460-049	58
300-440-029	54	300-440-717	57	300-460-051	58
300-440-030	68	300-440-720	69	300-460-053	55
300-440-033	55	300-440-751	69	300-460-076	68
300-440-048	58	300-440-753	69	300-460-201	56
300-440-049	58	300-440-781	69	300-460-243	66
300-440-051	58	300-441-001	130	300-460-244	66
300-440-052	61	300-441-013	130	300-460-245	66
300-440-053	55	300-441-015	130	300-460-246	66
300-440-074	65	300-441-017	130	300-460-263	67
300-440-076	68	300-441-078	132	300-460-264	67
300-440-078	63	300-441-079	132	300-460-266	67
300-440-079	63	300-441-085	133	300-460-286	68
300-440-084	64	300-441-201	131	300-460-295	68
300-440-085	65	300-441-289	131	300-460-700	69
300-440-097	65	300-441-291	131	300-460-710	57
300-440-197	65	300-441-710	131	300-460-713	57
300-440-201	56	300-441-713	57	300-460-715	57
300-440-234	64	300-450-005	78	300-460-717	57
300-440-243	66	300-450-006	78	300-460-720	69
300-440-244	66	300-450-049	79	300-460-751	69
300-440-245	66	300-450-171	79	300-460-753	69
300-440-246	66	300-450-173	79	300-460-781	69
300-440-250	63	300-450-174	79	300-461-713	57
300-440-252	63	300-450-176	79	300-470-052	61
300-440-263	67	300-450-177	79	300-470-074	65
300-440-264	67	300-450-289	79	300-470-078	63

300-470-079	63	300-480-340	101	300-505-025	143
300-470-084	64	300-480-341	101	300-505-052	143
300-470-085	65	300-480-360	101	300-505-060	142
300-470-097	65	300-480-370	101	300-505-063	142
300-470-197	65	300-480-371	101	300-505-067	142
300-470-234	64	300-480-530	101	300-505-069	142
300-470-250	63	300-480-540	101	300-505-080	142
300-470-252	63	300-480-541	101	300-505-082	142
300-470-280	64	300-480-560	101	300-505-570	142
300-470-284	61	300-480-570	101	300-505-710	143
300-470-285	60	300-480-571	101	300-505-731	143
300-470-287	60	300-480-630	99	300-550-005	45
300-470-288	60	300-480-631	99	300-550-010	45
300-470-289	5, 60	300-480-640	99	300-550-035	144
300-470-291	60	300-480-641	99	300-550-105	45
300-470-310	61	300-480-642	99	300-560-535	116
300-470-311	61	300-480-730	99	300-560-546	116
300-470-312	61	300-480-731	99	300-660-005	45, 113
300-470-313	61	300-480-740	99	300-660-010	45
300-470-314	61	300-480-741	99	300-660-015	74
300-480-000	100	300-480-742	99	300-660-035	144
300-480-001	100	300-490-200	70	300-660-105	45
300-480-002	100	300-490-202	70	300-660-110	45
300-480-033	100	300-490-204	71	300-661-004	45
300-480-045	100	300-490-206	70	300-661-005	45
300-480-130	99	300-490-220	71	300-661-006	45
300-480-131	99	300-490-221	71	300-661-007	45
300-480-140	99	300-503-000	143	300-661-008	45
300-480-141	99	300-503-015	143	300-661-009	45
300-480-142	99	300-503-016	143	300-661-010	45
300-480-160	99	300-503-021	143	300-700-100	169
300-480-161	99	300-503-025	143	300-700-110	169
300-480-170	99	300-503-052	143	300-700-400	15
300-480-171	99	300-503-060	142	300-700-430	15
300-480-172	99	300-503-063	142	300-750-001	44-133
300-480-230	99	300-503-067	142	300-750-003	44-133
300-480-231	99	300-503-069	142	300-750-015	44, 70, 71
300-480-240	99	300-503-080	142	300-750-101	44-144
300-480-241	99	300-503-082	142	300-750-103	44-144
300-480-242	99	300-503-570	142	300-750-105	44-113
300-480-260	99	300-503-710	143	300-750-106	44
300-480-261	99	300-503-731	143	300-750-115	44
300-480-270	99	300-505-000	143	300-750-215	44
300-480-271	99	300-505-015	143	300-750-315	44
300-480-272	99	300-505-016	143	300-755-400	15
300-480-330	101	300-505-021	143	300-755-430	15

300-760-005	45	300-810-504	88	300-855-001	120
300-760-010	45	300-810-506	88	300-855-002	120
300-760-105	45	300-810-511	89	300-855-003	120
300-760-110	45	300-810-512	89	300-855-006	120
300-800-001	88	300-810-514	89	300-855-007	120
300-800-002	88	300-810-516	89	300-855-010	120
300-800-004	88	300-820-013	91	300-855-011	120
300-800-006	88	300-820-014	91	300-855-013	120
300-800-011	89	300-820-015	92	300-855-015	120
300-800-012	89	300-820-051	91	300-855-017	120
300-800-014	89	300-820-052	91	300-855-018	120
300-800-016	89	300-820-056	92	300-855-019	120
300-800-401	88	300-820-413	91	300-855-020	120
300-800-402	88	300-820-414	91	300-855-021	120
300-800-404	88	300-820-415	92	300-855-022	120
300-800-406	88	300-820-451	91	300-855-023	120
300-800-411	89	300-820-452	91	300-855-025	120
300-800-412	89	300-820-456	92	300-855-027	120
300-800-414	89	300-830-005	90, 92	300-855-028	120
300-800-416	89	300-830-010	88, 89, 90, 92, 93	300-855-029	120
300-810-001	88	300-830-013	90	300-855-034	120
300-810-002	88	300-830-014	90	300-855-045	120
300-810-004	88	300-830-015	92	300-855-051	120
300-810-006	88	300-830-051	90	300-855-052	120
300-810-011	89	300-830-052	90	300-855-060	120
300-810-012	89	300-830-056	92	300-855-061	120
300-810-014	89	300-830-113	90	300-855-063	120
300-810-016	89	300-830-114	90	300-855-065	120
300-810-101	88	300-830-115	92	300-855-067	120
300-810-102	88	300-830-151	90	300-855-069	120
300-810-104	88	300-830-152	90	300-855-100	120
300-810-106	88	300-830-156	92	300-855-101	120
300-810-111	89	300-830-405	90, 92	300-855-102	120
300-810-112	89	300-830-410	88, 89, 90, 92, 93	300-855-103	120
300-810-114	89	300-830-413	90	300-855-105	120
300-810-116	89	300-830-414	90	300-855-120	120
300-810-401	88	300-830-415	92	300-855-134	120
300-810-402	88	300-830-451	90	300-855-145	120
300-810-404	88	300-830-452	90	300-855-400	120
300-810-406	88	300-830-456	92	300-855-401	120
300-810-411	89	300-830-513	90	300-857-100	121, 147
300-810-412	89	300-830-514	90	300-857-111	121, 147
300-810-414	89	300-830-515	92	300-857-112	121, 147
300-810-416	89	300-830-551	90	300-857-205	121, 147
300-810-501	88	300-830-552	90	300-857-301	121, 147
300-810-502	88	300-830-556	92	300-857-302	121, 147

300-857-303	121, 147	300-867-620	119, 146	350-755-017	86
300-860-009	117, 118	300-867-720	119, 146	600-050-000	162
300-860-011	117	300-867-729	119, 146	600-100-000	162
300-860-012	117	300-867-929	119, 146	600-255-500	157
300-860-013	6, 117	300-900-020	164	600-255-530	157
300-860-014	117	300-900-021	164	600-255-535	157
300-860-015	117	300-900-030	164	600-255-550	157
300-860-016	117	300-900-031	164	600-255-555	157
300-860-018	6, 117	300-900-040	164	600-255-565	157
300-860-019	6, 117	300-900-041	164	600-255-575	157
300-860-021	117, 134	300-900-180	176	600-255-600	157
300-860-023	117, 134	300-900-300	175	600-255-605	157
300-860-024	117, 134	300-900-902	3	600-279-101	160
300-860-025	117, 134	300-902-001	164, 165	600-279-102	160
300-860-026	117	300-902-003	164, 165	600-279-103	160
300-860-028	117, 134	300-902-004	164, 165	600-279-104	160
300-860-029	117, 134	300-902-005	164, 165	600-279-105	160
300-860-032	118	300-902-007	164, 165	600-279-106	160
300-860-033	118	300-902-008	165	600-279-131	160
300-860-035	118	350-400-250	86	600-279-132	160
300-860-037	118	350-660-100	84	600-279-133	160
300-860-040	118	350-660-111	84	600-279-134	160
300-860-061	117	350-660-112	84	600-279-135	160
300-860-063	117	350-660-113	84	600-279-136	160
300-860-065	117	350-660-114	84	600-279-151	160
300-860-068	117	350-660-115	84	600-279-152	160
300-860-069	117	350-660-116	84	600-279-153	160
300-860-100	122	350-740-000	85	600-279-154	160
300-860-111	122	350-740-001	85	600-279-155	160
300-860-125	116	350-740-002	85	600-279-156	160
300-860-134	6, 116	350-740-003	85	600-279-201	160
300-860-140	116	350-740-004	85	600-279-202	160
300-860-141	116	350-740-005	85	600-279-203	160
300-860-142	116	350-740-006	85	600-279-204	160
300-860-143	116	350-740-007	85	600-279-205	160
300-860-145	116, 134	350-740-008	85	600-279-206	160
300-860-147	116	350-740-040	85	600-279-261	160
300-860-250	116	350-740-050	85	600-279-262	160
300-860-500	116	350-740-060	85	600-279-263	160
300-860-534	116	350-740-070	85	600-279-264	160
300-860-545	116	350-740-080	85	600-279-265	160
300-867-100	119, 146	350-750-000	84	600-279-266	160
300-867-120	119, 146	350-750-001	84	600-280-101	160
300-867-129	119, 146	350-750-002	84	600-280-102	160
300-867-520	119, 146	350-755-007	86	600-280-103	160
300-867-529	119, 146	350-755-011	86	600-280-104	160

600-280-105	160	600-464-229	151	600-501-000	150
600-280-106	160	600-469-101	159	600-501-002	150
600-280-131	160	600-469-102	159	600-505-000	150
600-280-132	160	600-469-103	159	600-505-002	150
600-280-133	160	600-469-104	159	600-506-002	150
600-280-134	160	600-469-105	159	600-508-000	151
600-280-135	160	600-469-106	159	600-511-000	151
600-280-136	160	600-469-131	159	600-513-003	5, 153
600-280-151	160	600-469-132	159	600-540-500	154
600-280-152	160	600-469-133	159	600-540-530	154
600-280-153	160	600-469-134	159	600-540-535	8, 154
600-280-154	160	600-469-135	159	600-540-550	5, 154
600-280-155	160	600-469-136	159	600-540-555	8, 154
600-280-156	160	600-469-151	159	600-540-570	154
600-280-201	160	600-469-152	159	600-540-575	154
600-280-202	160	600-469-153	159	600-540-600	154
600-280-203	160	600-469-154	159	600-540-605	154
600-280-204	160	600-469-155	159	600-579-101	158
600-280-205	160	600-469-156	159	600-579-102	158
600-280-206	160	600-470-101	159	600-579-103	158
600-280-261	160	600-470-102	159	600-579-104	158
600-280-262	160	600-470-103	159	600-579-105	158
600-280-263	160	600-470-104	159	600-579-106	158
600-280-264	160	600-470-105	159	600-579-131	158
600-280-265	160	600-470-106	159	600-579-132	158
600-280-266	160	600-470-131	159	600-579-133	158
600-281-001	157	600-470-132	159	600-579-134	158
600-281-002	156	600-470-133	159	600-579-135	158
600-281-003	8, 155	600-470-134	159	600-579-136	158
600-281-004	154	600-470-135	159	600-579-151	158
600-290-630	161	600-470-136	159	600-579-152	158
600-292-052	152	600-470-151	159	600-579-153	158
600-380-100	161	600-470-152	159	600-579-154	158
600-405-500	156	600-470-153	159	600-579-155	158
600-405-530	156	600-470-154	159	600-579-156	158
600-405-535	156	600-470-155	159	600-579-201	158
600-405-550	156	600-470-156	159	600-579-202	158
600-405-555	156	600-485-500	155	600-579-203	158
600-405-570	156	600-485-530	155	600-579-204	158
600-405-575	156	600-485-535	155	600-579-205	158
600-405-600	156	600-485-550	155	600-579-206	158
600-405-605	156	600-485-555	155	600-579-261	158
600-450-070	152	600-485-570	155	600-579-262	158
600-460-055	152	600-485-575	155	600-579-263	158
600-460-056	8, 152	600-485-600	155	600-579-264	158
600-462-052	152	600-485-605	155	600-579-265	158

600-579-266	158	600-900-109	161	700-200-132	122
600-580-101	158	600-900-110	161	700-200-150	122
600-580-102	158	600-900-111	161	700-200-152	122
600-580-103	158	600-900-120	161	700-200-232	123
600-580-104	158	600-900-121	161	700-200-252	123
600-580-105	158	600-900-130	161	700-200-332	123
600-580-106	158	600-900-131	161	700-200-352	123
600-580-131	158	600-900-140	161	700-200-432	123
600-580-132	158	600-900-141	161	700-200-452	123
600-580-133	158	600-900-150	161	700-200-532	123
600-580-134	158	600-900-151	161	700-200-552	123
600-580-135	158	600-900-160	161	700-280-030	42
600-580-136	158	600-900-161	161	700-280-050	42
600-580-151	158	600-900-210	161	700-285-030	42
600-580-152	158	600-908-000	161	700-285-050	42
600-580-153	158	600-908-100	161	700-286-030	42
600-580-154	158	600-909-000	161	700-286-130	42
600-580-155	158	600-950-100	162	700-286-230	42
600-580-156	158	700-100-101	122	700-287-030	122
600-580-201	158	700-100-102	122	700-287-050	122
600-580-202	158	700-100-103	122	700-287-130	122
600-580-203	158	700-100-104	123	700-287-150	122
600-580-204	158	700-100-105	123	700-287-230	123
600-580-205	5, 8, 158	700-100-130	122	700-287-250	123
600-580-206	158	700-100-150	122	700-290-030	42
600-580-261	158	700-100-202	123	700-290-050	42
600-580-262	158	700-100-302	123	700-291-030	42
600-580-263	158	700-100-303	123	700-292-030	42
600-580-264	158	700-100-305	123	700-293-033	42
600-580-265	158	700-100-402	123	700-293-035	42
600-580-266	158	700-100-405	123	700-300-003	122
600-900-040	161	700-100-502	123	700-300-005	122
600-900-041	161	700-100-505	123	700-300-203	122
600-900-050	161	700-101-001	122	700-300-205	122
600-900-051	161	700-101-030	42	700-300-403	123
600-900-060	161	700-101-050	42	700-300-405	123
600-900-061	161	700-101-130	122	700-300-503	123
600-900-070	161	700-101-150	122	700-300-505	123
600-900-071	161	700-101-230	123	700-300-603	123
600-900-080	161	700-101-250	123	700-300-703	123
600-900-081	161	700-102-030	42	700-300-705	123
600-900-090	161	700-103-030	42	700-300-805	123
600-900-091	161	700-104-050	42	700-340-400	179
600-900-100	161	700-200-030	123	700-340-410	179
600-900-101	161	700-200-050	123	700-345-003	123
600-900-108	161	700-200-130	122	700-345-005	123

700-345-403	123	700-400-603	123
700-345-405	123	700-500-300	122
700-350-030	122	700-500-500	122
700-350-050	122	700-501-300	42
700-350-130	122	700-501-303	42
700-350-150	122	700-501-500	42
700-350-400	178	700-501-503	42
700-350-402	178, 179	700-503-000	178, 179
700-350-405	178, 179	700-503-001	178, 179
700-350-410	178	700-503-003	178, 179
700-351-030	122	700-630-003	123
700-351-031	122	700-736-003	123
700-351-047	123	700-736-005	123
700-351-048	123	700-739-003	123
700-351-050	122	700-739-005	123
700-351-051	122	700-900-160	162
700-351-053	123	700-900-220	162
700-351-055	123	700-900-250	162
700-351-131	6, 122		
700-351-151	122		
700-351-231	123		
700-351-251	123		
700-360-031	6, 42		
700-360-051	42		
700-361-030	42		
700-361-050	42		
700-362-030	42		
700-363-030	42		
700-363-050	42		
700-364-030	42		
700-370-030	42		
700-370-050	42		
700-390-030	123		
700-390-050	123		
700-400-003	122		
700-400-030	122		
700-400-050	122		
700-400-055	122		
700-400-103	122		
700-400-105	122		
700-400-130	122		
700-400-203	122		
700-400-205	123		
700-400-303	123		
700-400-403	123		
700-400-503	123		

