

Cleaning and Sterilization



STERILIZATION CONTAINER

CONTAINER MODELS



STANDARD

model

- Easy insertion and change of filter materials and filter retainer
- Extra long handles with silicone
- Stable and safe closing mechanism canceling overpressure
- Tag holders for clear traceability



SAFETY

model

- Additional safety lid with exterior press-button



ADVANCED SAFETY

model

- Color matched lid and handles
- Integrated safety lid
- Increased stability due to reinforced container walls
- Integrated spring system

SYMBOL EXPLANATION



Bottom: non-perforated



Bottom: perforated



Safety lid
Bottom: non-perforated



Safety lid
Bottom: perforated



Bottom only: non-perforated



Bottom only: perforated



Standard lid



Safety lid



Advanced Safety lid

LID COLORS



● Silver
End of numeral: 1



● Blue
End of numeral: 2



● Red
End of numeral: 3



● Green
End of numeral: 4

















● Yellow
End of numeral: 5

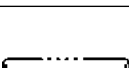

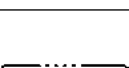
● Black
End of numeral: 6

STERILIZATION CONTAINER

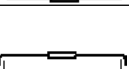
Suitability of our sterile containers for steam sterilization procedures¹⁾ as per DIN 58953 part 9 (issue Mai 1987)

	Packing		Steam sterilization procedure acc. to DIN 58946, part 1				
	Description	Symbolic representation and packing system	Gravitation procedure	Pre-vacuum procedure	Fractional vacuum procedure	Fractional flow procedure	Steam injection procedure
with filters (StB-F)	Textiles in sterilization container with filter in lid and bottom acc. to DIN 58952 part 1		✓	✓	✓	✓	✓
			✓	✓	✓	✓	✓
	Textiles in sterilization container with filter in lid, bottom not perforated acc. to DIN 58952 part 1		✗	✗	✓	✓	✓
			✗	✗	✓	✓	✓
	Textiles in sterilization container with filter bottom, lid not perforated acc. to DIN 58952 part 1		✓	✓	✓	✓	✓
			✗	✓	✓	✓	✓
	Instruments in wire basket acc. to DIN 58952 part III, in sterilization container with filter in lid and bottom acc. to DIN 58952 part 1		✓	✓	✓	✓	✓
	Instruments in wire basket acc. to DIN 58952 part III, in sterilization container with filter in lid, bottom not perforated acc. to DIN 58952 part 1		✗	✓	✓	✓	✓
	Instruments in wire basket acc. to DIN 58952 part III, in sterilization container with filter in bottom acc. to DIN 58952 part 1		✓	✓	✓	✓	✓
	with valves (StB-V)	Textiles in sterilization container with valves in lid and bottom acc. to DIN 58952 part 1		✗	✓	✓	✓
			✗	✗	✓	✓	✓
Textiles in sterilization container with valves in lid, no valves on the bottom			✗	✗	✓	✓	✗
			✗	✗	✓	✓	✗
Instruments in wire basket in sterilization container with valve in lid and bottom			✗	✓	✓	✓	✓
Instruments in wire basket in sterilization container with valve in lid, bottom not perforated			✗	✓	✓	✓	✓

¹⁾ In order to avoid mistakes with regards to service, operation and/or when loading the sterilizer, please refer to table 1 for correct or wrong combination of sterilization containers for standardized steam sterilization procedure.

✓ Applicable ✓ Limited applicable ✗ not applicable

²⁾ Suitable are only sterilization containers guaranteeing evaporation or discharge of condensate.

³⁾ Gravitation procedures having no drying device do not guarantee a sufficient after-drying effect.

1/1 CONTAINER

580 x 280mm



STERILIZATION CONTAINER

1/1 ADVANCED SAFETY CONTAINER



Size (LxWxH)

580x280x100 mm

▲ 100mm

●	600-580-101	600-579-101
●	600-580-102	600-579-102
●	600-580-103	600-579-103
●	600-580-104	600-579-104
●	600-580-105	600-579-105
●	600-580-106	600-579-106



580x280x135 mm

▲ 135mm

●	600-580-131	600-579-131
●	600-580-132	600-579-132
●	600-580-133	600-579-133
●	600-580-134	600-579-134
●	600-580-135	600-579-135
●	600-580-136	600-579-136



580x280x150 mm

▲ 150mm

●	600-580-151	600-579-151
●	600-580-152	600-579-152
●	600-580-153	600-579-153
●	600-580-154	600-579-154
●	600-580-155	600-579-155
●	600-580-156	600-579-156



580x280x200 mm

▲ 200mm

●	600-580-201	600-579-201
●	600-580-202	600-579-202
●	600-580-203	600-579-203
●	600-580-204	600-579-204
●	600-580-205	600-579-205
●	600-580-206	600-579-206



580x280x260 mm

▲ 260mm

●	600-580-261	600-579-261
●	600-580-262	600-579-262
●	600-580-263	600-579-263
●	600-580-264	600-579-264
●	600-580-265	600-579-265
●	600-580-266	600-579-266

1/1 SAFETY CONTAINER



Size (LxWxH)



580x280x100 mm	● 600-583-101	600-584-101
	● 600-583-102	600-584-102
	● 600-583-103	600-584-103
	● 600-583-104	600-584-104
	● 600-583-105	600-584-105
▲ 100mm	● 600-583-106	600-584-106



580x280x135 mm	● 600-583-131	600-584-131
	● 600-583-132	600-584-132
	● 600-583-133	600-584-133
	● 600-583-134	600-584-134
	● 600-583-135	600-584-135
▲ 135mm	● 600-583-136	600-584-136



580x280x150 mm	● 600-583-151	600-584-151
	● 600-583-152	600-584-152
	● 600-583-153	600-584-153
	● 600-583-154	600-584-154
	● 600-583-155	600-584-155
▲ 150mm	● 600-583-156	600-584-156



580x280x200 mm	● 600-583-201	600-584-201
	● 600-583-202	600-584-202
	● 600-583-203	600-584-203
	● 600-583-204	600-584-204
	● 600-583-205	600-584-205
▲ 200mm	● 600-583-206	600-584-206



580x280x260 mm	● 600-583-261	600-584-261
	● 600-583-262	600-584-262
	● 600-583-263	600-584-263
	● 600-583-264	600-584-264
	● 600-583-265	600-584-265
▲ 260mm	● 600-583-266	600-584-266

STERILIZATION CONTAINER

1/1 STANDARD CONTAINER



Size (LxWxH)

580x280x100 mm

▲ 100mm

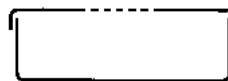

●	600-581-101	600-582-101
●	600-581-102	600-582-102
●	600-581-103	600-582-103
●	600-581-104	600-582-104
●	600-581-105	600-582-105
●	600-581-106	600-582-106



580x280x135 mm

▲ 135mm

●	600-581-131	600-582-131
●	600-581-132	600-582-132
●	600-581-133	600-582-133
●	600-581-134	600-582-134
●	600-581-135	600-582-135
●	600-581-136	600-582-136



580x280x150 mm

▲ 150mm

●	600-581-151	600-582-151
●	600-581-152	600-582-152
●	600-581-153	600-582-153
●	600-581-154	600-582-154
●	600-581-155	600-582-155
●	600-581-156	600-582-156



580x280x200 mm

▲ 200mm

●	600-581-201	600-582-201
●	600-581-202	600-582-202
●	600-581-203	600-582-203
●	600-581-204	600-582-204
●	600-581-205	600-582-205
●	600-581-206	600-582-206



580x280x260 mm

▲ 260mm

●	600-581-261	600-582-261
●	600-581-262	600-582-262
●	600-581-263	600-582-263
●	600-581-264	600-582-264
●	600-581-265	600-582-265
●	600-581-266	600-582-266

1/1



Bottom perforated

Size (LxWxH)



580x280x100 mm	600-585-100
580x280x135 mm	600-585-135
580x280x150 mm	600-585-150
580x280x200 mm	600-585-200
580x280x260 mm	600-585-260



Bottom non-perforated

Size (LxWxH)



580x280x100 mm	600-586-100
580x280x135 mm	600-586-135
580x280x150 mm	600-586-150
580x280x200 mm	600-586-200
580x280x260 mm	600-586-260



Standard Lid

Size (LxW)



580x280 mm	600-587-281
	600-587-282
	600-587-283
	600-587-284
	600-587-285
	600-587-286



Safety Lid

Size (LxW)



580x280 mm	600-588-281
	600-588-282
	600-588-283
	600-588-284
	600-588-285
	600-588-286

STERILIZATION TRAYS

1/1

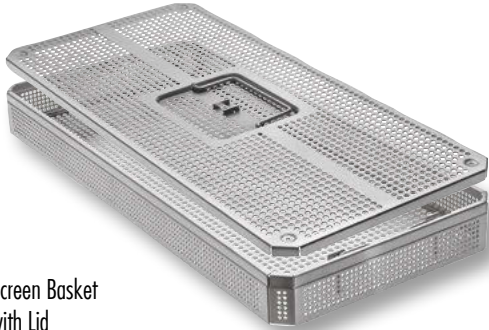

Screen Basket
with Lid

Size (LxWxH)

545x255x35mm	600-540-535
545x255x55mm	600-540-555
545x255x75mm	600-540-575
545x255x105mm	600-540-605

485x255x35mm	600-485-535
485x255x55mm	600-485-555
485x255x75mm	600-485-575
485x255x105mm	600-485-605



Lid only

545x255mm	600-540-500
485x255mm	600-485-500



Bottom only

545x255x30mm	600-540-530
545x255x50mm	600-540-550
545x255x70mm	600-540-570
545x255x100mm	600-540-600

485x255x30mm	600-485-530
485x255x50mm	600-485-550
485x255x70mm	600-485-570
485x255x100mm	600-485-600

1/1



Rippled wire mesh

Size (LxWxH)

485x255x30 mm	600-485-030
485x255x50 mm	600-485-050
485x255x70 mm	600-485-070
485x255x100 mm	600-485-100
540x255x30 mm	600-540-030
540x255x50 mm	600-540-050
540x255x70 mm	600-540-070
540x255x100 mm	600-540-100

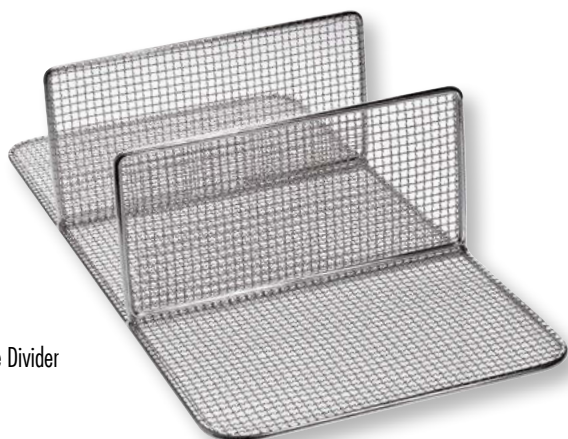

Wire Divider

One Partition	510x250x130 mm	600-901-130
	510x250x180 mm	600-901-180
	510x250x230 mm	600-901-230
Two Partitions	510x250x130 mm	600-901-131
	510x250x180 mm	600-901-181
	510x250x230 mm	600-901-231



Drape Retainer

545x255mm	600-900-003
-----------	-------------

3/4 CONTAINER

465 x 280mm



3/4 ADVANCED SAFETY CONTAINER



Size (LxWxH)

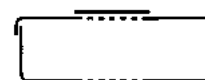

465x280x100 mm

●	600-469-101	600-470-101
●	600-469-102	600-470-102
●	600-469-103	600-470-103
●	600-469-104	600-470-104
●	600-469-105	600-470-105
●	600-469-106	600-470-106

▲ 100mm



465x280x135 mm

●	600-469-131	600-470-131
●	600-469-132	600-470-132
●	600-469-133	600-470-133
●	600-469-134	600-470-134
●	600-469-135	600-470-135
●	600-469-136	600-470-136

▲ 135mm



465x280x150 mm

●	600-469-151	600-470-151
●	600-469-152	600-470-152
●	600-469-153	600-470-153
●	600-469-154	600-470-154
●	600-469-155	600-470-155
●	600-469-156	600-470-156

▲ 150mm

STERILIZATION CONTAINER

3/4 SAFETY CONTAINER



Size (LxWxH)



465x280x100 mm

●	600-463-101	600-464-101
●	600-463-102	600-464-102
●	600-463-103	600-464-103
●	600-463-104	600-464-104
●	600-463-105	600-464-105
●	600-463-106	600-464-106

▲ 100mm



465x280x135 mm

●	600-463-131	600-464-131
●	600-463-132	600-464-132
●	600-463-133	600-464-133
●	600-463-134	600-464-134
●	600-463-135	600-464-135
●	600-463-136	600-464-136

▲ 135mm



465x280x150 mm

●	600-463-151	600-464-151
●	600-463-152	600-464-152
●	600-463-153	600-464-153
●	600-463-154	600-464-154
●	600-463-155	600-464-155
●	600-463-156	600-464-156

▲ 150mm

3/4 STANDARD CONTAINER



Size (LxWxH)



465x280x100 mm

●	600-461-101	600-462-101
●	600-461-102	600-462-102
●	600-461-103	600-462-103
●	600-461-104	600-462-104
●	600-461-105	600-462-105
●	600-461-106	600-462-106

▲ 100mm



465x280x135 mm

●	600-461-131	600-462-131
●	600-461-132	600-462-132
●	600-461-133	600-462-133
●	600-461-134	600-462-134
●	600-461-135	600-462-135
●	600-461-136	600-462-136

▲ 135mm



465x280x150 mm

●	600-461-151	600-462-151
●	600-461-152	600-462-152
●	600-461-153	600-462-153
●	600-461-154	600-462-154
●	600-461-155	600-462-155
●	600-461-156	600-462-156

▲ 150mm

STERILIZATION CONTAINER & TRAYS

3/4



Size (LxWxH)



465x280x100 mm	600-465-100
465x280x135 mm	600-465-135
465x280x150 mm	600-465-150



Size (LxWxH)



465x280x100 mm	600-466-100
465x280x135 mm	600-466-135
465x280x150 mm	600-466-150



Size (LxW)

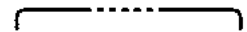

465x280 mm	600-467-281
	600-467-282
	600-467-283
	600-467-284
	600-467-285
	600-467-286



Size (LxW)



465x280 mm	600-468-281
	600-468-282
	600-468-283
	600-468-284
	600-468-285
	600-468-286

3/4

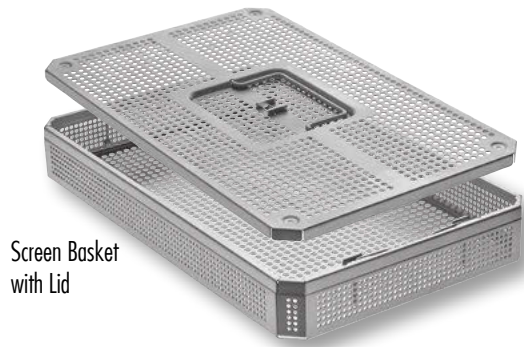

Screen Basket
with Lid

Size (LxWxH)

405x255x35mm	600-405-535
405x255x55mm	600-405-555
405x255x75mm	600-405-575
405x255x105mm	600-405-605



Lid only

405x255mm	600-405-500
-----------	-------------



Bottom only

405x255x30mm	600-405-530
405x255x50mm	600-405-550
405x255x70mm	600-405-570
405x255x100mm	600-405-600



Rippled
Wire Mesh

405x255x30mm	600-405-030
405x255x50mm	600-405-050
405x255x70mm	600-405-070
405x255x100mm	600-405-100



Drape Retainer

405x255mm	600-463-200
-----------	-------------

1/2 CONTAINER

285 x 280mm



1/2 ADVANCED SAFETY CONTAINER



Size (LxWxH)

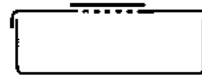

285x280x100 mm

●	600-280-101	600-279-101
●	600-280-102	600-279-102
●	600-280-103	600-279-103
●	600-280-104	600-279-104
●	600-280-105	600-279-105
●	600-280-106	600-279-106

▲ 100mm



285x280x135 mm

●	600-280-131	600-279-131
●	600-280-132	600-279-132
●	600-280-133	600-279-133
●	600-280-134	600-279-134
●	600-280-135	600-279-135
●	600-280-136	600-279-136

▲ 135mm



285x280x150 mm

●	600-280-151	600-279-151
●	600-280-152	600-279-152
●	600-280-153	600-279-153
●	600-280-154	600-279-154
●	600-280-155	600-279-155
●	600-280-156	600-279-156

▲ 150mm



285x280x200 mm

●	600-280-201	600-279-201
●	600-280-202	600-279-202
●	600-280-203	600-279-203
●	600-280-204	600-279-204
●	600-280-205	600-279-205
●	600-280-206	600-279-206

▲ 200mm



285x280x260 mm

●	600-280-261	600-279-261
●	600-280-262	600-279-262
●	600-280-263	600-279-263
●	600-280-264	600-279-264
●	600-280-265	600-279-265
●	600-280-266	600-279-266

▲ 260mm

STERILIZATION CONTAINER

1/2 SAFETY CONTAINER



Size (LxWxH)



285x280x100 mm

●	600-283-101	600-284-101
●	600-283-102	600-284-102
●	600-283-103	600-284-103
●	600-283-104	600-284-104
●	600-283-105	600-284-105
●	600-283-106	600-284-106

▲ 100mm



285x280x135 mm

●	600-283-131	600-284-131
●	600-283-132	600-284-132
●	600-283-133	600-284-133
●	600-283-134	600-284-134
●	600-283-135	600-284-135
●	600-283-136	600-284-136

▲ 135mm



285x280x150 mm

●	600-283-151	600-284-151
●	600-283-152	600-284-152
●	600-283-153	600-284-153
●	600-283-154	600-284-154
●	600-283-155	600-284-155
●	600-283-156	600-284-156

▲ 150mm



285x280x200 mm

●	600-283-201	600-284-201
●	600-283-202	600-284-202
●	600-283-203	600-284-203
●	600-283-204	600-284-204
●	600-283-205	600-284-205
●	600-283-206	600-284-206

▲ 200mm



285x280x260 mm

●	600-283-261	600-284-261
●	600-283-262	600-284-262
●	600-283-263	600-284-263
●	600-283-264	600-284-264
●	600-283-265	600-284-265
●	600-283-266	600-284-266

▲ 260mm

1/2 STANDARD CONTAINER



Size (LxWxH)



285x280x100 mm	●	600-281-101	600-282-101
	●	600-281-102	600-282-102
	●	600-281-103	600-282-103
	●	600-281-104	600-282-104
	●	600-281-105	600-282-105
	●	600-281-106	600-282-106

▲ 100mm



285x280x135 mm	●	600-281-131	600-282-131
	●	600-281-132	600-282-132
	●	600-281-133	600-282-133
	●	600-281-134	600-282-134
	●	600-281-135	600-282-135
	●	600-281-136	600-282-136

▲ 135mm



285x280x150 mm	●	600-281-151	600-282-151
	●	600-281-152	600-282-152
	●	600-281-153	600-282-153
	●	600-281-154	600-282-154
	●	600-281-155	600-282-155
	●	600-281-156	600-282-156

▲ 150mm



285x280x200 mm	●	600-281-201	600-282-201
	●	600-281-202	600-282-202
	●	600-281-203	600-282-203
	●	600-281-204	600-282-204
	●	600-281-205	600-282-205
	●	600-281-206	600-282-206

▲ 200mm



285x280x260 mm	●	600-281-261	600-282-261
	●	600-281-262	600-282-262
	●	600-281-263	600-282-263
	●	600-281-264	600-282-264
	●	600-281-265	600-282-265
	●	600-281-266	600-282-266

▲ 260mm

STERILIZATION CONTAINER

1/2

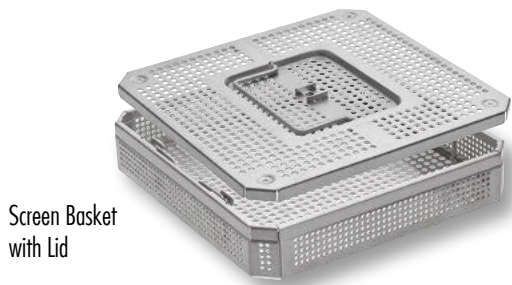

Screen Basket
with Lid

Size (LxWxH)

<u>255x245x35mm</u>	<u>600-255-535</u>
<u>255x245x55mm</u>	<u>600-255-555</u>
<u>255x245x75mm</u>	<u>600-255-575</u>
<u>255x245x105mm</u>	<u>600-255-605</u>

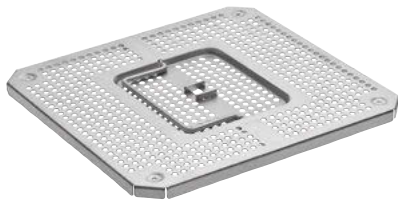

Lid only

<u>255x245mm</u>	<u>600-255-500</u>
------------------	--------------------



Bottom only

<u>255x245x30mm</u>	<u>600-255-530</u>
<u>255x245x50mm</u>	<u>600-255-550</u>
<u>255x245x70mm</u>	<u>600-255-570</u>
<u>255x245x100mm</u>	<u>600-255-600</u>

1/2

Rippled
Wire Mesh



Size (LxWxH)

<u>255x245x30mm</u>	<u>600-255-030</u>
<u>255x245x50mm</u>	<u>600-255-050</u>
<u>255x245x70mm</u>	<u>600-255-070</u>
<u>255x245x100mm</u>	<u>600-255-100</u>

Wire
Divider

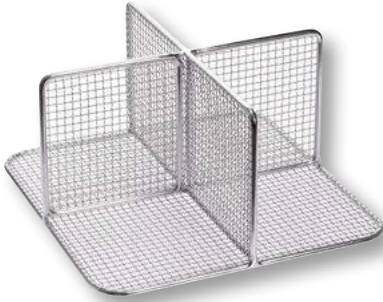

<u>255x245x130mm</u>	<u>600-901-132</u>
<u>255x245x180mm</u>	<u>600-901-182</u>
<u>255x245x280mm</u>	<u>600-901-232</u>



Drape Retainer

255x255mm

600-288-300

SPECIAL SIZE CONTAINER



Size (LxWxH)



600x400x120 mm

●	600-600-121	600-601-121
●	600-600-122	600-601-122
●	600-600-123	600-601-123
●	600-600-124	600-601-124
●	600-600-125	600-601-125
●	600-600-126	600-601-126

▲ 120mm



600x400x180 mm

●	600-600-181	600-601-181
●	600-600-182	600-601-182
●	600-600-183	600-601-183
●	600-600-184	600-601-184
●	600-600-185	600-601-185
●	600-600-186	600-601-186

▲ 180mm



Square Hole
Wire Mesh

470x337x51 mm
533x337x101 mm

600-470-050
600-533-100

STERILIZATION CONTAINER

Size (LxWxH)



285x280x55 mm

▲ 55mm

●	600-271-051
●	600-271-052
●	600-271-053
●	600-271-054
●	600-271-055
●	600-271-056



▲ 85mm

●	600-271-081	600-272-081
●	600-271-082	600-272-082
●	600-271-083	600-272-083
●	600-271-084	600-272-084
●	600-271-085	600-272-085
●	600-271-086	600-272-086

Square hole
wire mesh



255x245x30mm	600-255-030
255x245x50mm	600-255-050

Screen Basket
with Lid



Size (LxWxH)

255x245x35mm	600-255-535
255x245x55mm	600-255-555
255x245x75mm	600-255-575
255x245x105mm	600-255-605

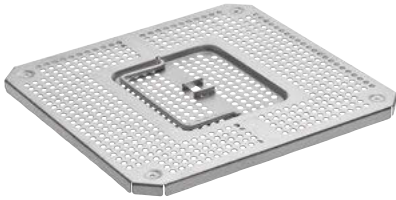

Lid only

255x245mm

600-255-500



Bottom only

255x245x30mm	600-255-530
255x245x50mm	600-255-550
255x245x70mm	600-255-570
255x245x100mm	600-255-600



Drape Retainer

255x255mm

600-288-300

STERILIZATION CONTAINER



Size (LxWxH)



300x140x40 mm

▲ 40mm

●	600-141-041	600-142-041
●	600-141-042	600-142-042
●	600-141-043	600-142-043
●	600-141-044	600-142-044
●	600-141-045	600-142-045
●	600-141-046	600-142-046



300x140x70 mm

▲ 70mm

●	600-141-071	600-142-071
●	600-141-072	600-142-072
●	600-141-073	600-142-073
●	600-141-074	600-142-074
●	600-141-075	600-142-075
●	600-141-076	600-142-076



300x140x100 mm

▲ 100mm

●	600-141-101	600-142-101
●	600-141-102	600-142-102
●	600-141-103	600-142-103
●	600-141-104	600-142-104
●	600-141-105	600-142-105
●	600-141-106	600-142-106



Size (LxWxH)



300x140x40 mm	600-143-040
300x140x70 mm	600-143-070
300x140x100 mm	600-143-100



Size (LxWxH)



300x140x40 mm	600-144-040
300x140x70 mm	600-144-070
300x140x100 mm	600-144-100



Size (LxW)



300x140 mm

- 600-145-141
- 600-145-142
- 600-145-143
- 600-145-144
- 600-145-145
- 600-145-146

STERILIZATION CONTAINER



Screen Basket with Lid

Size (LxWxH)

271x117x45mm

600-267-050



Lid only

271x177mm

600-540-055



Bottom only

271x117x40mm

600-267-045



Rippled Wire Mesh

265x120x45mm

600-265-045



Drape Retainer

280x125mm

600-141-200

TELESCOPE CONTAINER

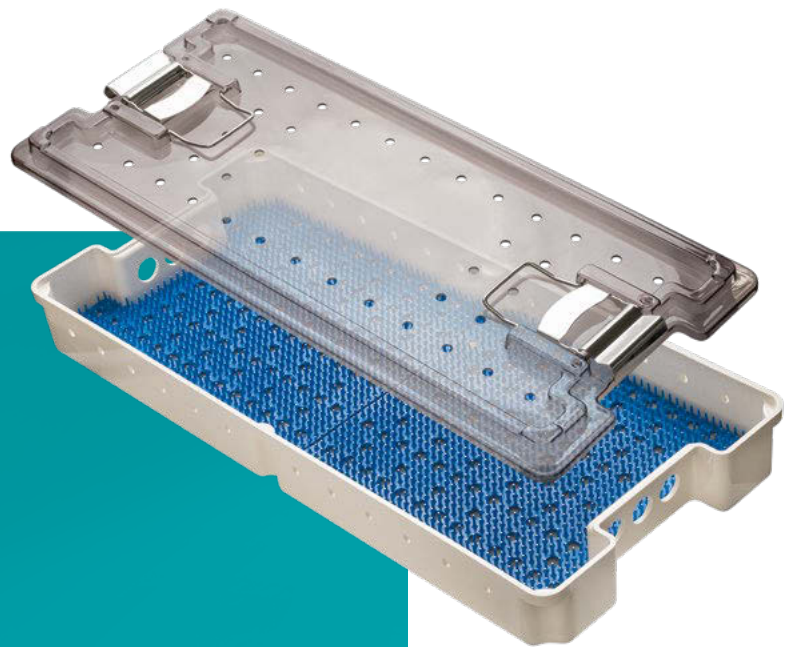

STERILIZATION CONTAINER

SAFE+ CLEAN ENDOSCOPE PLASTIC CONTAINER

with silicone bars on base and lid

600-505-000

Endoscopes	1 (∅ 1-10mm)
Endoscope length	max. 270mm
Dimensions	271 x 70 x 35mm

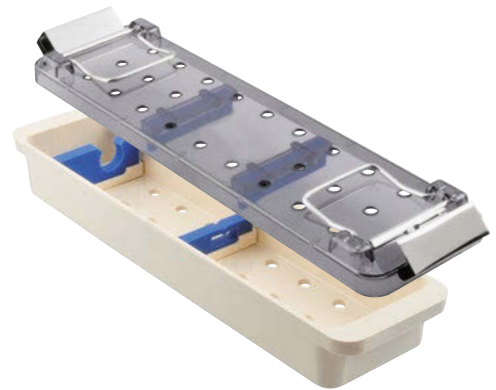

600-505-002

Endoscopes	max. 2
Endoscope length	max. 190mm
Dimensions	271 x 70 x 35mm

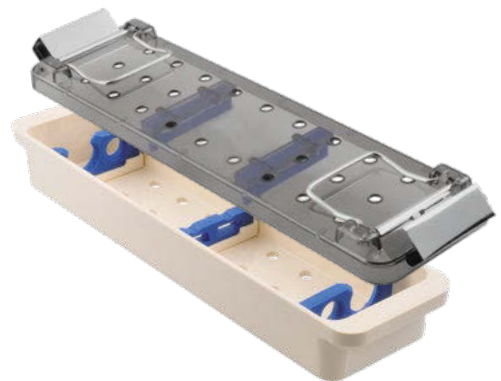

600-506-002*

Endoscopes	max. 2
Endoscope length	max. 390mm
Dimensions	394 x 70 x 35mm

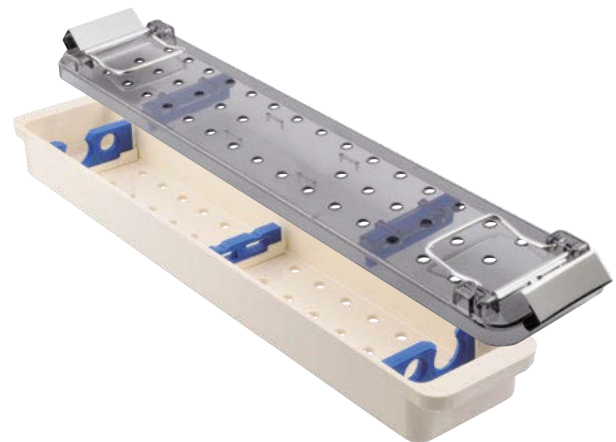

600-501-000

Endoscopes 1

600-501-002

Endoscopes max. 2

Endoscope length	max. 450mm
Dimensions	457 x 70 x 35mm

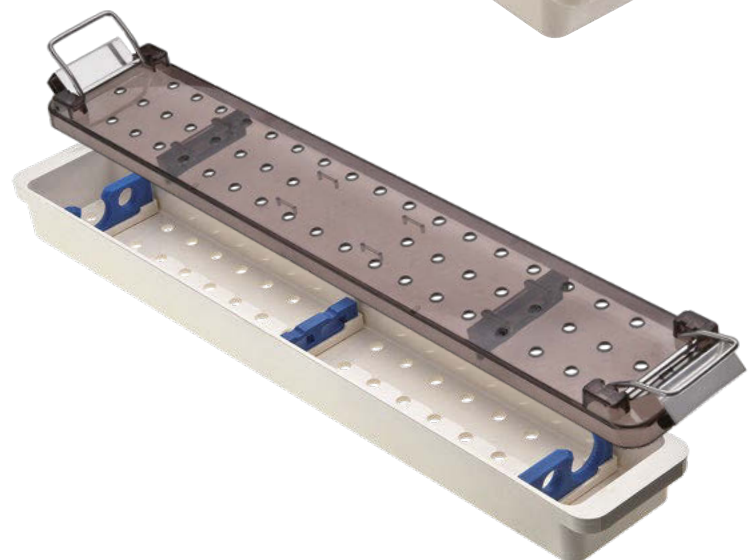

ENDOSCOPE & INSTRUMENT CONTAINERS

600-508-000 for scopes and light guide cables

Endoscopes	max. 3 (∅ 5-10mm)
Fiber Optic Light Cable	1
Endoscope length	max. XXXmm
Dimensions	465 x 212 x 51mm

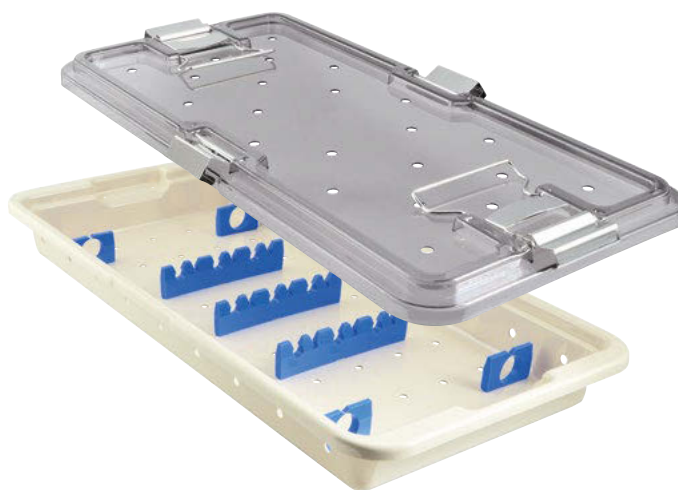

600-464-229 for fixation of instruments with rubber ties

Dimensions	464 x 229 x 51mm
------------	------------------

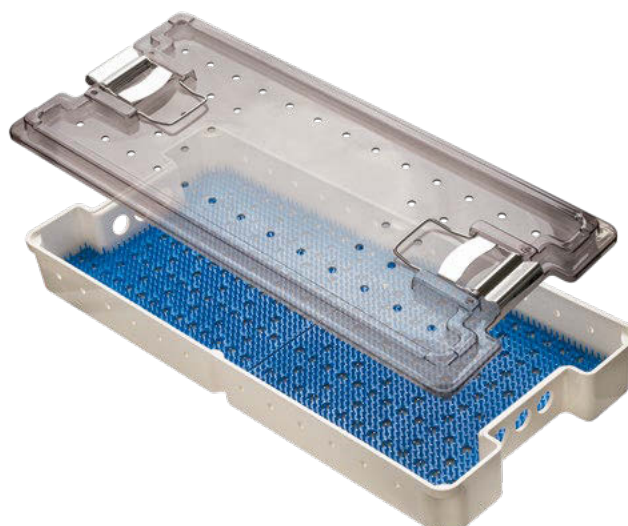

600-511-000 for instruments with rubber ties on 2 levels

Dimensions	502 x 239 x 102mm
------------	-------------------



STERILIZATION CONTAINER

ENDOSCOPE CLEANING BASKETS & CONTAINERS

with silicone bars on base and lid

600-292-052*

Endoscopes	max. 2
Endoscope length	max. 190mm
Dimensions	290 x 80 x 52mm

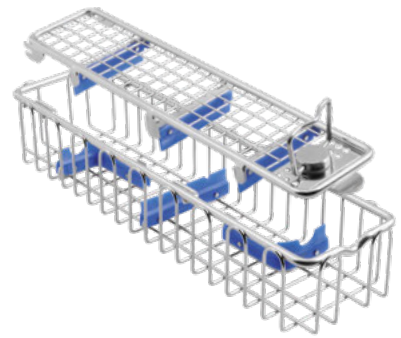

600-462-052*

Endoscopes	max. 2
Endoscope length	max. 350mm
Dimensions	460 x 80 x 52mm

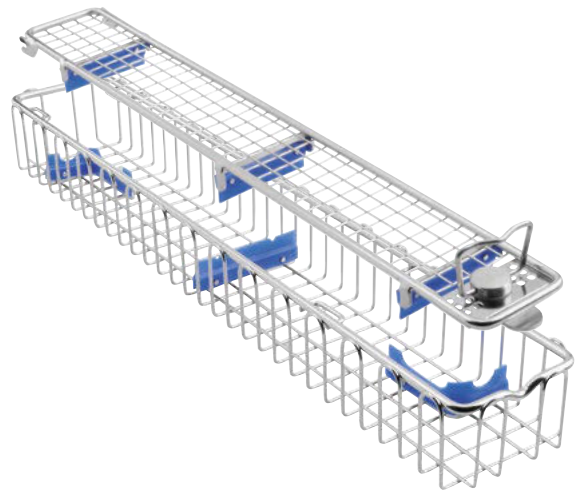

600-460-055	Endoscopes 1
600-460-056	Endoscopes max. 2
Endoscope length	max. 340mm
Dimensions	455 x 86 x 43mm

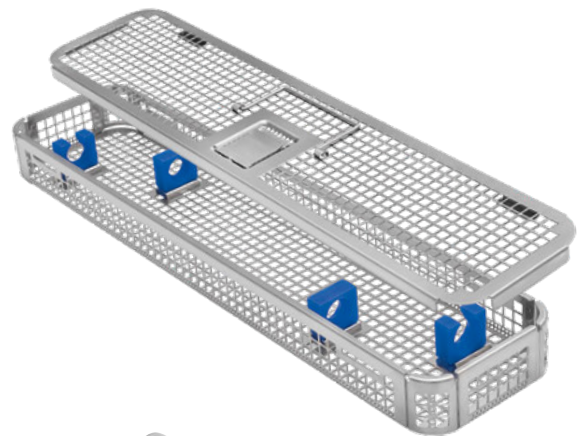

600-450-070

Endoscopes	max. 2
Endoscope length	max. 330mm
Dimensions	450 x 70 x 70mm

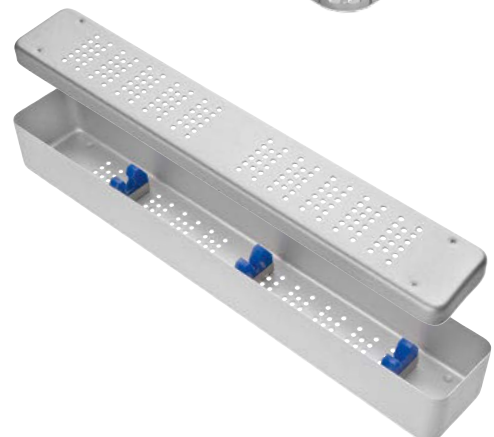

ARTHROSCOPY INSTRUMENTS CONTAINER

600-513-000

Container for 8 instruments in upright position
with utility space for extra instruments



600-513-005

Container Case with inner tray
for 5 Chondro Picks + Hammer
or 6 Hand Grip Instruments
Dimensions: 400 x 45 x 250mm

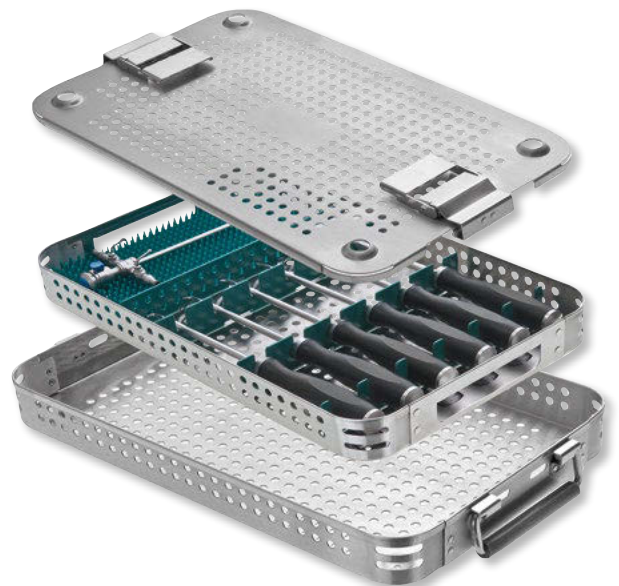

600-513-001

Container for Arthroscopy for 16 instruments
up to 4mm in upright position with utility space
for extra instruments.
Dimensions: 464x190x70mm

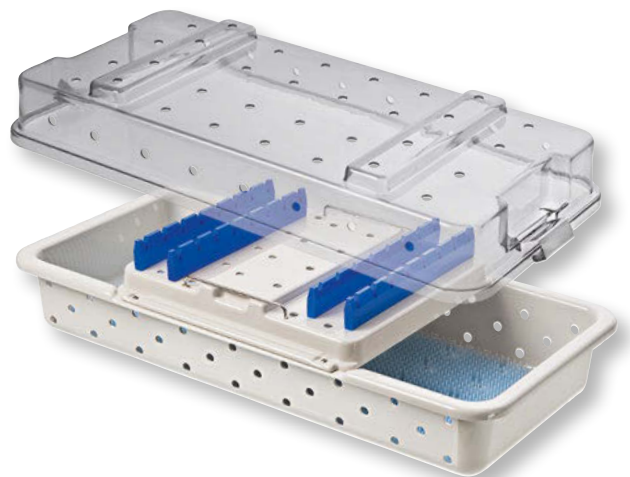

STERILIZATION CONTAINER

LAPAROSCOPY INSTRUMENTS CONTAINER

600-512-000

Container for Laparoscopy for up to 12 Instruments
with maximum length of 320 mm.
Dimensions: 478x203x130mm

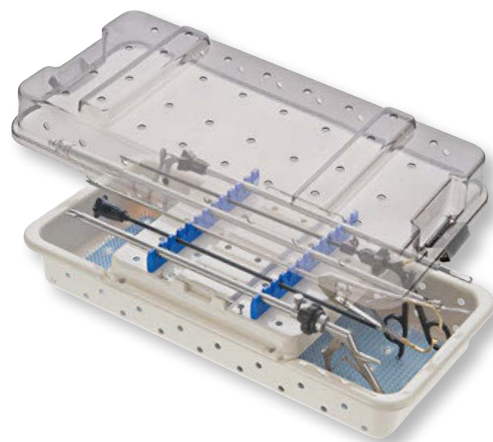

600-512-000

Container for Laparoscopy for up to 12 Instruments
with maximum length of 320 mm.
Dimensions: 478x203x130mm

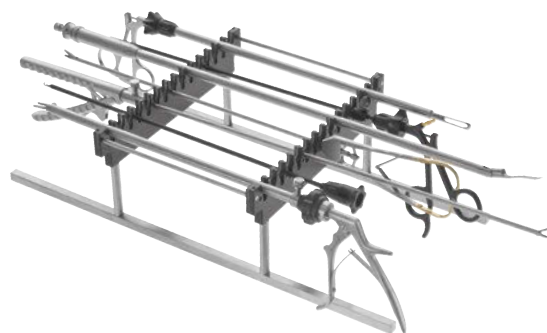

600-513-004

Storage rack for shaft instruments
Dimensions: 220x232x155mm

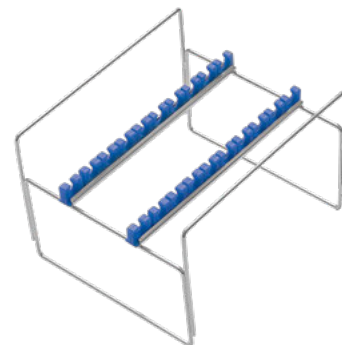

600-513-003

Storage Rack for MIS instruments
Dimensions: 460x232x155mm

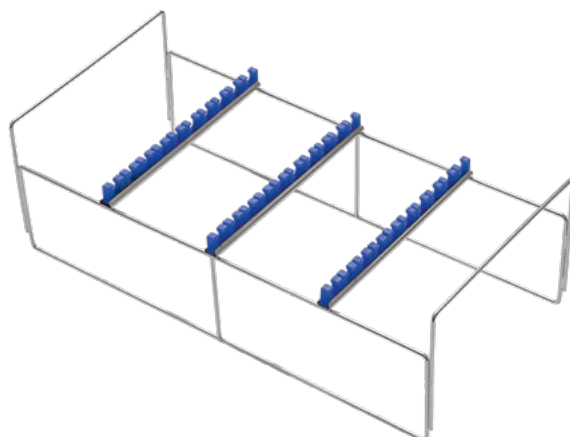

MAINTENANCE & ACCESSORIES



MAINTENANCE & ACCESSORIES



Identification label, 100 pieces per package

- 1** 600-908-100 Standard
- 1** 600-908-000 Small

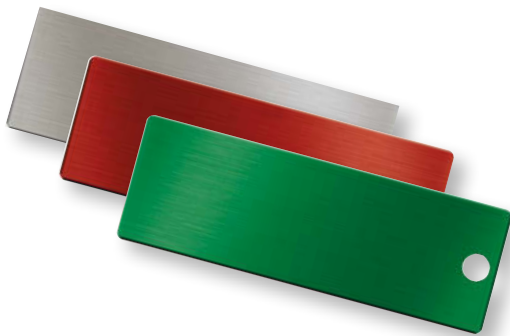

Identification label

with hole for snap hook
56x17mm

unmarked	600-900-040	marked	600-900-108
	600-900-050		600-900-110
	600-900-060		600-900-120
	600-900-070		600-900-130
	600-900-080		600-900-140
	600-900-090		600-900-150
	600-900-100		600-900-160

Snap Hook

without retainer (without illustration)
600-900-170

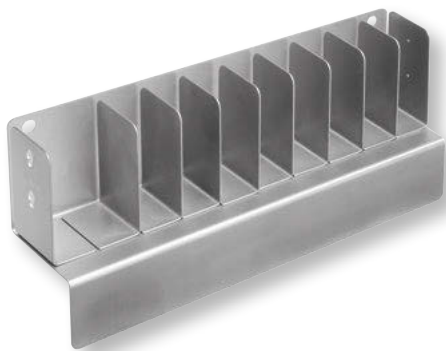

600-900-210

Dispenser for identification labels
(8 small compartments and 1 double compartment)
as table or wall model



600-909-000

Plastic security seal, 100 pieces per package

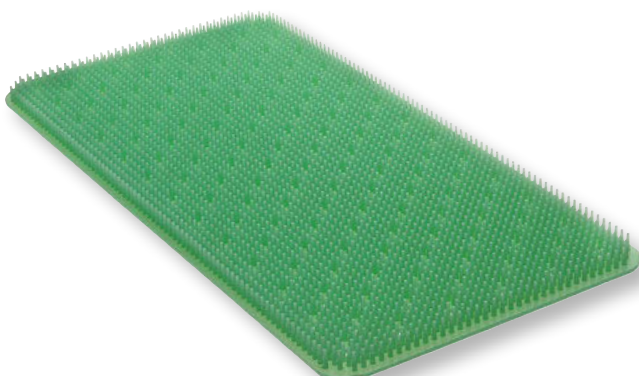

520x230mm	600-281-004
440x230mm	600-281-003
380x230mm	600-281-002
220x230mm	600-281-001

Silicone Mat green,
cuttable to desired size



600-290-610
Paper Filter STANDARD, 100 pieces per package



600-480-100
Textile Filter STANDARD, 1 piece per package



600-380-100
PTFE (TEFLON) Filter, round, STANDARD

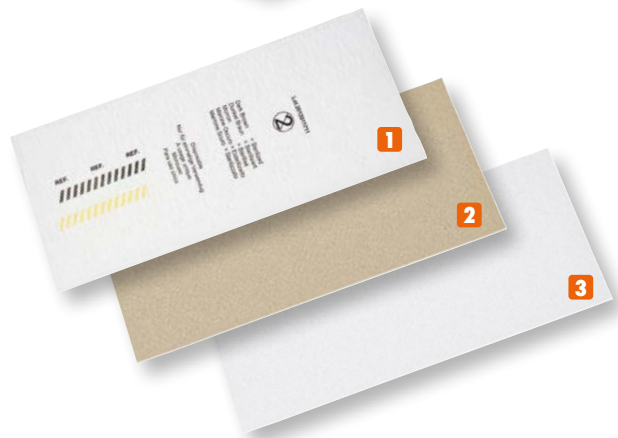

- 1** 600-290-620
Disposable Paper Filters, 235x118mm with
Steam Indicator, 100 pcs.
- 2** 600-480-200
Textile Filter, 210x95mm, 1 piece per package
- 3** 600-380-200
PTFE (Teflon) Filter, 215x95mm,
1 piece per package



600-290-630
Filter Dispenser for disposable Filter,
round, 195x195mm

MAINTENANCE & ACCESSORIES



Filter Tray for all standard containers

Ø 185mm

600-290-640



Drape, green ●

600 x 400mm	600-900-301
850 x 850mm	600-900-302
900 x 600mm	600-900-309
900 x 800mm	600-900-310
1300 x 450mm	600-900-311
1300 x 600mm	600-900-306
1400 x 1000mm	600-900-303
2750 x 1250mm	600-900-304
2450 x 2450mm	600-900-305
1850 x 450mm	600-900-307
1850 x 600mm	600-900-308



Measuring Jug with feet, graduated

capacity	height	
0.5 l	110mm	600-098-205
1.0 l	140mm	600-098-100
1.5 l	160mm	600-098-150
2.0 l	200mm	600-098-220



Needle Sterilizing Case
Ø 65mm

Complete case	600-100-065
Perforated Interior Box only	600-100-070
Non Perforated Exterior Box only	600-100-071



SAUERBRUCH

Needle sterilising case, 12 compartments
Lid / Bottom perforation

210 x 125 x 17mm 600-210-125



Needle sterilising case, 7 compartments,
rectangular, Bottom perforation

150 x 95 x 13mm 600-115-100



Needle sterilising case, 3 compartments,
rectangular, Lid / Bottom perforation

150 x 95 x 13mm 600-115-000



Needle sterilizing case, with holes

65 x 42 x 8mm 600-110-065

MAINTENANCE & ACCESSORIES



Laboratory Bowl

Ø	capacity	height	
140mm	0.5 l	55mm	600-170-151
150mm	0.75 l	75mm	600-170-165
160mm	1.0 l	75mm	600-170-175
220mm	2.0 l	75mm	600-170-220
240mm	3.0 l	95mm	600-170-240
260mm	4.5 l	120mm	600-170-275
300mm	6.0 l	120mm	600-170-310
320mm	8.0 l	140mm	600-170-325
380mm	11.0 l	130mm	600-170-380
400mm	14.0 l	155mm	600-170-415



Stainless Steel Bowl,
round

Ø	capacity	height	
40mm	0.02 l	19mm	600-231-040
60mm	0.06 l	30mm	600-231-060
85mm	0.16 l	40mm	600-231-080
110mm	0.40 l	55mm	600-231-100
150mm	1.00 l	75mm	600-231-150



Instrument Box with lid

LxWxH	
100x60x40mm	600-310-100
120x80x40mm	600-310-120
160x100x30mm	600-310-160
180x120x50mm	600-310-180
200x100x50mm	600-310-200
220x150x50mm	600-312-220
260x150x50mm	600-310-260
300x200x50mm	600-310-300
400x200x80mm	600-312-400
500x270x70mm	600-312-500



Dressing Tray

LxWxH
235x190x45mm

600-340-230



Instrument Tray

LxWxH		
215x155x18mm		600-113-100
295x195x20mm		600-113-110
360x240x10mm		600-113-120
390x270x10mm		600-113-130
490x320x14mm		600-113-140
445x350x12mm		600-113-150
445x325x9mm		600-113-160



Cylinder Jar

∅	height	
30mm	95mm	600-142-001
50mm	105mm	600-142-002
50mm	135mm	600-142-003
50mm	180mm	600-142-004
80mm	135mm	600-142-006
80mm	175mm	600-142-007
95mm	205mm	600-142-009

MAINTENANCE & ACCESSORIES



Cotton Wool Dispenser

∅ capacity height

60mm	0.15 l	60mm	600-397-010
85mm	0.25 l	50mm	600-397-020
100mm	0.35 l	50mm	600-397-060
85mm	0.4 l	85mm	600-397-080
85mm	0.6 l	125mm	600-397-030
100mm	0.75 l	100mm	600-397-040
120mm	1.25 l	120mm	600-398-120
150mm	1.75 l	100mm	600-398-130
150mm	2.5 l	150mm	600-398-150
200mm	3.0 l	100mm	600-398-160
200mm	6.0 l	200mm	600-398-170



Sputum Cup with lid

∅ capacity height

75mm	0.3 l	75mm	600-662-075
80mm	0.4 l	85mm	600-662-080



Gynecological Bedpan
350 x 290 x 90mm
(L x W x H)

Bedpan	600-665-001
Bedpan with side handles	600-665-002
lid only	600-665-003



Irrigator Bowl
with tube fixing

Ø	capacity	height	
100mm	1.0l	165mm	600-676-010
120mm	1.5l	175mm	600-676-015
120mm	2.0l	195mm	600-676-020



Kidney Bowl

Length	capacity	
170mm	0.25 l	600-673-170
205mm	0.35 l	600-673-200
250mm	0.50 l	600-673-250
275mm	0.75 l	600-673-275



Slipper Pan with handle
LxWxH
360x255x90mm

Slipper Pan	600-740-300
lid only	600-740-301

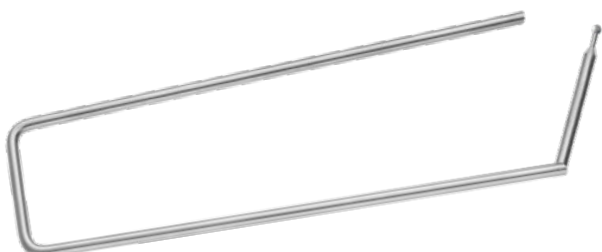

STRINGER

Instrument Holder

102 x 70mm (4")	660-160-100
152 x 70mm (6")	660-160-150
203 x 70mm (8")	660-160-200
254 x 70mm (10")	660-160-250
305 x 70mm (12")	660-160-300
356 x 70mm (14")	660-160-350
406 x 70mm (16")	660-160-400
457 x 70mm (18")	660-160-450
508 x 70mm (20")	660-160-500

WEINSTEIN

Instrument Holder

63 x 152mm (6")	660-163-150
63 x 200mm (8")	660-163-200
63 x 250mm (10")	660-163-250
63 x 300mm (12")	660-163-300
63 x 350mm (14")	660-163-350
63 x 400mm (16")	660-163-400
63 x 450mm (18")	660-163-450

MAJO

Safety Pin, 140mm, 5^{1/2}", with ball

without ball	660-100-100
with ball	660-100-140

BUNT

Safety Pin

120mm, 4 ^{3/4} "	660-102-120
---------------------------	-------------



ROGGE

Sterilizing Forceps

235mm, 9¹/₄"

600-087-230



CHEATE

Sterilizing Forceps

270mm, 10²/₃"

600-095-270



DAVIS

Sterilizing Forceps

200mm, 8"

600-080-200



Cleaning Brush for Ø 5mm

500mm, 19³/₄"

300-135-905



Cleaning Brush for Ø 10mm

500mm, 19³/₄"

300-135-910

MAINTENANCE & ACCESSORIES



Cleaning Brush

Ø3mm, 245 x 65mm	300-245-000
Ø3mm, 420 x 65mm	300-420-065
Ø7mm, 285 x 75mm	300-285-000
Ø8mm, 270 x 65mm	300-270-000



Cleaning Brush

Ø12mm, 270 x 65mm	300-215-050
Ø13mm, 215 x 60mm	300-215-000
Ø15mm, 215 x 70mm	300-215-070
Ø20mm, 215 x 65mm	300-215-080
Ø25mm, 215 x 65mm	300-215-090
Ø30mm, 215 x 60mm	300-215-100

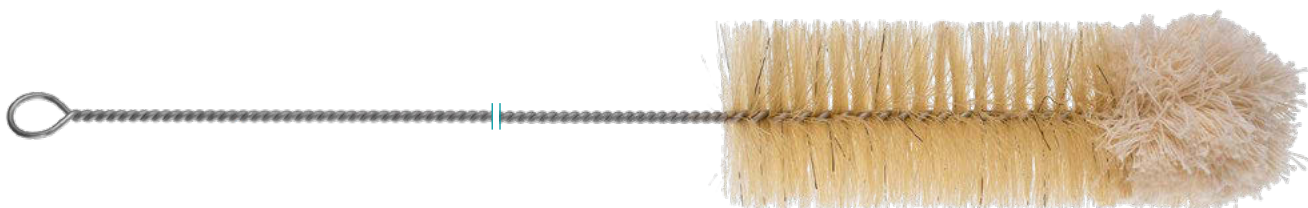

Cleaning Brush

Ø12mm, 275 x 65mm	600-091-012
Ø15mm, 275 x 80mm	600-091-015
Ø30mm, 300 x 120mm	600-091-030
Ø50mm, 320 x 130mm	600-091-050

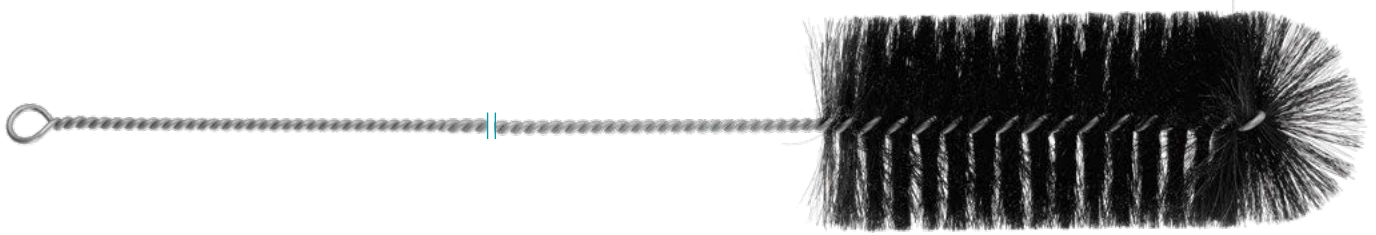

Cleaning Brush

Ø80mm,
490 x 180mm

300-092-080

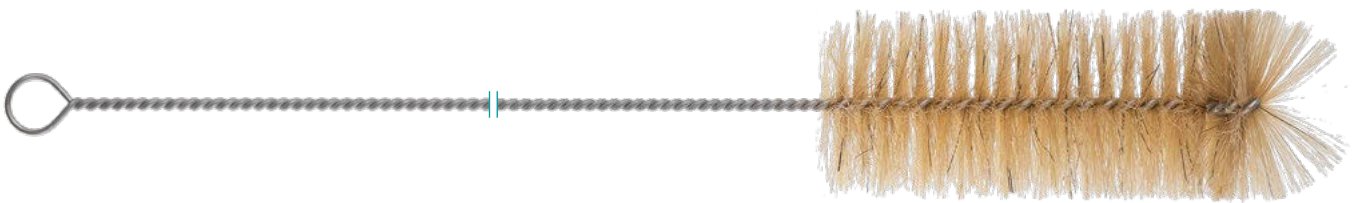

Cleaning Brush

Ø50mm,
330 x 130mm

600-092-050



Cleaning Brush

Ø8/20mm,
300 x 190mm

300-215-110



Cleaning Brush

Ø18/33mm,
300 x 110mm

300-215-111

MAINTENANCE & ACCESSORIES



Cleaning Brush

Ø15/25mm,
320 x 70mm

300-215-112



Cleaning Brush

Ø15/25mm,
320 x 70mm

300-215-112



RZ Brush Dispenser
for 20 brushes with suspension hook

240 x 275 x 70mm

600-950-100



Cleaning Brush with plastic handle
10 pcs. / package

600-050-000



RZ Aquajet Water Pistol, complete
9 tips, 1m pressure tubing, strap,
suspension hook

600-100-000



Oil Dispenser

140mm, 5 1/2"

700-900-250



Special Cotton for polishing metal sheaths
and instruments

700-900-220

MAINTENANCE & ACCESSORIES



Oil Spray

400ml

700-900-149



Instrument Oil

50ml

700-900-160



Tape

green

900-950-001

yellow

900-950-002

blue

900-950-003

red

900-950-004

brown

900-950-005

white

900-950-006

orange

900-950-007

black

900-950-008

purple

900-950-009

300-092-080	49	600-141-044	28	600-144-100	29
300-135-905	47	600-141-045	28	600-145-141	29
300-135-910	47	600-141-046	28	600-145-142	29
300-215-000	48	600-141-071	28	600-145-143	29
300-215-050	48	600-141-072	28	600-145-144	29
300-215-070	48	600-141-073	28	600-145-145	29
300-215-080	48	600-141-074	28	600-145-146	29
300-215-090	48	600-141-075	28	600-170-151	42
300-215-100	48	600-141-076	28	600-170-165	42
300-215-110	49	600-141-101	28	600-170-175	42
300-215-111	49	600-141-102	28	600-170-220	42
300-215-112	50	600-141-103	28	600-170-240	42
300-245-000	48	600-141-104	28	600-170-275	42
300-270-000	48	600-141-105	28	600-170-310	42
300-285-000	48	600-141-106	28	600-170-325	42
300-420-065	48	600-141-200	30	600-170-380	42
600-050-000	50	600-142-001	43	600-170-415	42
600-080-200	47	600-142-002	43	600-210-125	41
600-087-230	47	600-142-003	43	600-231-040	42
600-091-012	48	600-142-004	43	600-231-060	42
600-091-015	48	600-142-006	43	600-231-080	42
600-091-030	48	600-142-007	43	600-231-100	42
600-091-050	48	600-142-009	43	600-231-150	42
600-092-050	49	600-142-041	28	600-255-030	23, 26
600-095-270	47	600-142-042	28	600-255-050	23, 26
600-098-100	40	600-142-043	28	600-255-070	23
600-098-150	40	600-142-044	28	600-255-100	23
600-098-205	40	600-142-045	28	600-255-500	22, 27
600-098-220	40	600-142-046	28	600-255-530	22, 27
600-100-000	51	600-142-071	28	600-255-535	22, 27
600-100-065	40	600-142-072	28	600-255-550	22, 27
600-100-070	40	600-142-073	28	600-255-555	22, 27
600-100-071	40	600-142-074	28	600-255-570	22, 27
600-110-065	41	600-142-075	28	600-255-575	22, 27
600-113-100	43	600-142-076	28	600-255-600	22, 27
600-113-110	43	600-142-101	28	600-255-605	22, 27
600-113-120	43	600-142-102	28	600-265-045	30
600-113-130	43	600-142-103	28	600-267-045	30
600-113-140	43	600-142-104	28	600-267-050	30
600-113-150	43	600-142-105	28	600-271-051	26
600-113-160	43	600-142-106	28	600-271-052	26
600-115-000	41	600-143-040	29	600-271-053	26
600-115-100	41	600-143-070	29	600-271-054	26
600-141-041	28	600-143-100	29	600-271-055	26
600-141-042	28	600-144-040	29	600-271-056	26
600-141-043	28	600-144-070	29	600-271-081	26

NUMERICAL INDEX

600-271-082	26	600-280-106	19	600-281-156	21
600-271-083	26	600-280-131	19	600-281-201	21
600-271-084	26	600-280-132	19	600-281-202	21
600-271-085	26	600-280-133	19	600-281-203	21
600-271-086	26	600-280-134	19	600-281-204	21
600-272-081	26	600-280-135	19	600-281-205	21
600-272-082	26	600-280-136	19	600-281-206	21
600-272-083	26	600-280-151	19	600-281-261	21
600-272-084	26	600-280-152	19	600-281-262	21
600-272-085	26	600-280-153	19	600-281-263	21
600-272-086	26	600-280-154	19	600-281-264	21
600-279-101	19	600-280-155	19	600-281-265	21
600-279-102	19	600-280-156	19	600-281-266	21
600-279-103	19	600-280-201	19	600-282-101	21
600-279-104	19	600-280-202	19	600-282-102	21
600-279-105	19	600-280-203	19	600-282-103	21
600-279-106	19	600-280-204	19	600-282-104	21
600-279-131	19	600-280-205	19	600-282-105	21
600-279-132	19	600-280-206	19	600-282-106	21
600-279-133	19	600-280-261	19	600-282-131	21
600-279-134	19	600-280-262	19	600-282-132	21
600-279-135	19	600-280-263	19	600-282-133	21
600-279-136	19	600-280-264	19	600-282-134	21
600-279-151	19	600-280-265	19	600-282-135	21
600-279-152	19	600-280-266	19	600-282-136	21
600-279-153	19	600-281-001	38	600-282-151	21
600-279-154	19	600-281-002	38	600-282-152	21
600-279-155	19	600-281-003	38	600-282-153	21
600-279-156	19	600-281-004	38	600-282-154	21
600-279-201	19	600-281-101	21	600-282-155	21
600-279-202	19	600-281-102	21	600-282-156	21
600-279-203	19	600-281-103	21	600-282-201	21
600-279-204	19	600-281-104	21	600-282-202	21
600-279-205	19	600-281-105	21	600-282-203	21
600-279-206	19	600-281-106	21	600-282-204	21
600-279-261	19	600-281-131	21	600-282-205	21
600-279-262	19	600-281-132	21	600-282-206	21
600-279-263	19	600-281-133	21	600-282-261	21
600-279-264	19	600-281-134	21	600-282-262	21
600-279-265	19	600-281-135	21	600-282-263	21
600-279-266	19	600-281-136	21	600-282-264	21
600-280-101	19	600-281-151	21	600-282-265	21
600-280-102	19	600-281-152	21	600-282-266	21
600-280-103	19	600-281-153	21	600-283-101	20
600-280-104	19	600-281-154	21	600-283-102	20
600-280-105	19	600-281-155	21	600-283-103	20

600-283-104	20	600-284-202	20	600-405-530	17
600-283-105	20	600-284-203	20	600-405-535	17
600-283-106	20	600-284-204	20	600-405-550	17
600-283-131	20	600-284-205	20	600-405-555	17
600-283-132	20	600-284-206	20	600-405-570	17
600-283-133	20	600-284-261	20	600-405-575	17
600-283-134	20	600-284-262	20	600-405-600	17
600-283-135	20	600-284-263	20	600-405-605	17
600-283-136	20	600-284-264	20	600-450-070	34
600-283-151	20	600-284-265	20	600-460-055	34
600-283-152	20	600-284-266	20	600-460-056	34
600-283-153	20	600-288-300	23, 27	600-461-101	15
600-283-154	20	600-290-610	39	600-461-102	15
600-283-155	20	600-290-620	39	600-461-103	15
600-283-156	20	600-290-630	39	600-461-104	15
600-283-201	20	600-290-640	40	600-461-105	15
600-283-202	20	600-292-052	34	600-461-106	15
600-283-203	20	600-310-100	42	600-461-131	15
600-283-204	20	600-310-120	42	600-461-132	15
600-283-205	20	600-310-160	42	600-461-133	15
600-283-206	20	600-310-180	42	600-461-134	15
600-283-261	20	600-310-200	42	600-461-135	15
600-283-262	20	600-310-260	42	600-461-136	15
600-283-263	20	600-310-300	42	600-461-151	15
600-283-264	20	600-312-220	42	600-461-152	15
600-283-265	20	600-312-400	42	600-461-153	15
600-283-266	20	600-312-500	42	600-461-154	15
600-284-101	20	600-340-230	43	600-461-155	15
600-284-102	20	600-380-100	39	600-461-156	15
600-284-103	20	600-380-200	39	600-462-052	34
600-284-104	20	600-397-010	44	600-462-101	15
600-284-105	20	600-397-020	44	600-462-102	15
600-284-106	20	600-397-030	44	600-462-103	15
600-284-131	20	600-397-040	44	600-462-104	15
600-284-132	20	600-397-060	44	600-462-105	15
600-284-133	20	600-397-080	44	600-462-106	15
600-284-134	20	600-398-120	44	600-462-131	15
600-284-135	20	600-398-130	44	600-462-132	15
600-284-136	20	600-398-150	44	600-462-133	15
600-284-151	20	600-398-160	44	600-462-134	15
600-284-152	20	600-398-170	44	600-462-135	15
600-284-153	20	600-405-030	17	600-462-136	15
600-284-154	20	600-405-050	17	600-462-151	15
600-284-155	20	600-405-070	17	600-462-152	15
600-284-156	20	600-405-100	17	600-462-153	15
600-284-201	20	600-405-500	17	600-462-154	15

NUMERICAL INDEX

600-462-155	15	600-467-281	16	600-470-154	13
600-462-156	15	600-467-282	16	600-470-155	13
600-463-101	14	600-467-283	16	600-470-156	13
600-463-102	14	600-467-284	16	600-480-100	39
600-463-103	14	600-467-285	16	600-480-200	39
600-463-104	14	600-467-286	16	600-485-030	11
600-463-105	14	600-468-281	16	600-485-050	11
600-463-106	14	600-468-282	16	600-485-070	11
600-463-131	14	600-468-283	16	600-485-100	11
600-463-132	14	600-468-284	16	600-485-500	10
600-463-133	14	600-468-285	16	600-485-530	10
600-463-134	14	600-468-286	16	600-485-535	10
600-463-135	14	600-469-101	13	600-485-550	10
600-463-136	14	600-469-102	13	600-485-555	10
600-463-151	14	600-469-103	13	600-485-570	10
600-463-152	14	600-469-104	13	600-485-575	10
600-463-153	14	600-469-105	13	600-485-600	10
600-463-154	14	600-469-106	13	600-485-605	10
600-463-155	14	600-469-131	13	600-501-000	32
600-463-156	14	600-469-132	13	600-501-002	32
600-463-200	17	600-469-133	13	600-505-000	32
600-464-101	14	600-469-134	13	600-505-002	32
600-464-102	14	600-469-135	13	600-506-002	32
600-464-103	14	600-469-136	13	600-508-000	33
600-464-104	14	600-469-151	13	600-511-000	33
600-464-105	14	600-469-152	13	600-512-000	36
600-464-106	14	600-469-153	13	600-513-000	35
600-464-131	14	600-469-154	13	600-513-001	35
600-464-132	14	600-469-155	13	600-513-003	36
600-464-133	14	600-469-156	13	600-513-004	36
600-464-134	14	600-470-050	25	600-513-005	35
600-464-135	14	600-470-101	13	600-533-100	25
600-464-136	14	600-470-102	13	600-540-030	11
600-464-151	14	600-470-103	13	600-540-050	11
600-464-152	14	600-470-104	13	600-540-055	30
600-464-153	14	600-470-105	13	600-540-070	11
600-464-154	14	600-470-106	13	600-540-100	11
600-464-155	14	600-470-131	13	600-540-500	10
600-464-156	14	600-470-132	13	600-540-530	10
600-464-229	33	600-470-133	13	600-540-535	10
600-465-100	16	600-470-134	13	600-540-550	10
600-465-135	16	600-470-135	13	600-540-555	10
600-465-150	16	600-470-136	13	600-540-570	10
600-466-100	16	600-470-151	13	600-540-575	10
600-466-135	16	600-470-152	13	600-540-600	10
600-466-150	16	600-470-153	13	600-540-605	10

600-579-101	6	600-580-155	6	600-582-103	8
600-579-102	6	600-580-156	6	600-582-104	8
600-579-103	6	600-580-201	6	600-582-105	8
600-579-104	6	600-580-202	6	600-582-106	8
600-579-105	6	600-580-203	6	600-582-131	8
600-579-106	6	600-580-204	6	600-582-132	8
600-579-131	6	600-580-205	6	600-582-133	8
600-579-132	6	600-580-206	6	600-582-134	8
600-579-133	6	600-580-261	6	600-582-135	8
600-579-134	6	600-580-262	6	600-582-136	8
600-579-135	6	600-580-263	6	600-582-151	8
600-579-136	6	600-580-264	6	600-582-152	8
600-579-151	6	600-580-265	6	600-582-153	8
600-579-152	6	600-580-266	6	600-582-154	8
600-579-153	6	600-581-101	8	600-582-155	8
600-579-154	6	600-581-102	8	600-582-156	8
600-579-155	6	600-581-103	8	600-582-201	8
600-579-156	6	600-581-104	8	600-582-202	8
600-579-201	6	600-581-105	8	600-582-203	8
600-579-202	6	600-581-106	8	600-582-204	8
600-579-203	6	600-581-131	8	600-582-205	8
600-579-204	6	600-581-132	8	600-582-206	8
600-579-205	6	600-581-133	8	600-582-261	8
600-579-206	6	600-581-134	8	600-582-262	8
600-579-261	6	600-581-135	8	600-582-263	8
600-579-262	6	600-581-136	8	600-582-264	8
600-579-263	6	600-581-151	8	600-582-265	8
600-579-264	6	600-581-152	8	600-582-266	8
600-579-265	6	600-581-153	8	600-583-101	7
600-579-266	6	600-581-154	8	600-583-102	7
600-580-101	6	600-581-155	8	600-583-103	7
600-580-102	6	600-581-156	8	600-583-104	7
600-580-103	6	600-581-201	8	600-583-105	7
600-580-104	6	600-581-202	8	600-583-106	7
600-580-105	6	600-581-203	8	600-583-131	7
600-580-106	6	600-581-204	8	600-583-132	7
600-580-131	6	600-581-205	8	600-583-133	7
600-580-132	6	600-581-206	8	600-583-134	7
600-580-133	6	600-581-261	8	600-583-135	7
600-580-134	6	600-581-262	8	600-583-136	7
600-580-135	6	600-581-263	8	600-583-151	7
600-580-136	6	600-581-264	8	600-583-152	7
600-580-151	6	600-581-265	8	600-583-153	7
600-580-152	6	600-581-266	8	600-583-154	7
600-580-153	6	600-582-101	8	600-583-155	7
600-580-154	6	600-582-102	8	600-583-156	7

NUMERICAL INDEX

600-583-201	7	600-585-260	9	600-665-003	44
600-583-202	7	600-586-100	9	600-673-170	45
600-583-203	7	600-586-135	9	600-673-200	45
600-583-204	7	600-586-150	9	600-673-250	45
600-583-205	7	600-586-200	9	600-673-275	45
600-583-206	7	600-586-260	9	600-676-010	45
600-583-261	7	600-587-281	9	600-676-015	45
600-583-262	7	600-587-282	9	600-676-020	45
600-583-263	7	600-587-283	9	600-740-300	45
600-583-264	7	600-587-284	9	600-740-301	45
600-583-265	7	600-587-285	9	600-900-003	11
600-583-266	7	600-587-286	9	600-900-040	38
600-584-101	7	600-588-281	9	600-900-050	38
600-584-102	7	600-588-282	9	600-900-060	38
600-584-103	7	600-588-283	9	600-900-070	38
600-584-104	7	600-588-284	9	600-900-080	38
600-584-105	7	600-588-285	9	600-900-090	38
600-584-106	7	600-588-286	9	600-900-100	38
600-584-131	7	600-600-121	25	600-900-108	38
600-584-132	7	600-600-122	25	600-900-110	38
600-584-133	7	600-600-123	25	600-900-120	38
600-584-134	7	600-600-124	25	600-900-130	38
600-584-135	7	600-600-125	25	600-900-140	38
600-584-136	7	600-600-126	25	600-900-150	38
600-584-151	7	600-600-181	25	600-900-160	38
600-584-152	7	600-600-182	25	600-900-170	38
600-584-153	7	600-600-183	25	600-900-210	38
600-584-154	7	600-600-184	25	600-900-301	40
600-584-155	7	600-600-185	25	600-900-302	40
600-584-156	7	600-600-186	25	600-900-303	40
600-584-201	7	600-601-121	25	600-900-304	40
600-584-202	7	600-601-122	25	600-900-305	40
600-584-203	7	600-601-123	25	600-900-306	40
600-584-204	7	600-601-124	25	600-900-307	40
600-584-205	7	600-601-125	25	600-900-308	40
600-584-206	7	600-601-126	25	600-900-309	40
600-584-261	7	600-601-181	25	600-900-310	40
600-584-262	7	600-601-182	25	600-900-311	40
600-584-263	7	600-601-183	25	600-901-130	11
600-584-264	7	600-601-184	25	600-901-131	11
600-584-265	7	600-601-185	25	600-901-132	23
600-584-266	7	600-601-186	25	600-901-180	11
600-585-100	9	600-662-075	44	600-901-181	11
600-585-135	9	600-662-080	44	600-901-182	23
600-585-150	9	600-665-001	44	600-901-230	11
600-585-200	9	600-665-002	44	600-901-231	11

<u>600-901-232</u>	<u>23</u>
<u>600-908-000</u>	<u>38</u>
<u>600-908-100</u>	<u>38</u>
<u>600-909-000</u>	<u>38</u>
<u>600-950-100</u>	<u>50</u>
<u>660-100-100</u>	<u>46</u>
<u>660-100-140</u>	<u>46</u>
<u>660-102-120</u>	<u>46</u>
<u>660-160-100</u>	<u>46</u>
<u>660-160-150</u>	<u>46</u>
<u>660-160-200</u>	<u>46</u>
<u>660-160-250</u>	<u>46</u>
<u>660-160-300</u>	<u>46</u>
<u>660-160-350</u>	<u>46</u>
<u>660-160-400</u>	<u>46</u>
<u>660-160-450</u>	<u>46</u>
<u>660-160-500</u>	<u>46</u>
<u>660-163-150</u>	<u>46</u>
<u>660-163-200</u>	<u>46</u>
<u>660-163-250</u>	<u>46</u>
<u>660-163-300</u>	<u>46</u>
<u>660-163-350</u>	<u>46</u>
<u>660-163-400</u>	<u>46</u>
<u>660-163-450</u>	<u>46</u>
<u>700-900-149</u>	<u>52</u>
<u>700-900-160</u>	<u>52</u>
<u>700-900-220</u>	<u>51</u>
<u>700-900-250</u>	<u>51</u>
<u>900-950-001</u>	<u>52</u>
<u>900-950-002</u>	<u>52</u>
<u>900-950-003</u>	<u>52</u>
<u>900-950-004</u>	<u>52</u>
<u>900-950-005</u>	<u>52</u>
<u>900-950-006</u>	<u>52</u>
<u>900-950-007</u>	<u>52</u>
<u>900-950-008</u>	<u>52</u>
<u>900-950-009</u>	<u>52</u>



RZ Medizintechnik GmbH

Unter Hasslen 20
78532 Tuttlingen, Germany

Phone: +49 7462 9470-0

sales@rz-medizintechnik.com
www.rz-medizintechnik.com

