

INDEX

Sets & Retractors	1 - 12
Laparoscopes	13 - 18
Advanced Trocar Systems	19 - 32
Suction & Irrigation	33 - 46
Ring Handle Instruments	47 - 90
Clip Applying, Bulldog Clamps, Needle Holders	91 - 118
Bipolar Instruments	119 - 128
Bariatric Instruments	129 - 138
Pediatric & Mini Instruments	139 - 152
Container & Cleaning	153 - 166
Equipment	167 - 187





CONTAINER SETS

Small Incision, Fast Recovery.

Innovations in high-precision instrumentation or high class optical scopes we offer a broad spectrum of laparoscopic instruments and devices for your minimal invasive surgeries.

We work hand-in-hand with clinical partners and produce under high quality standards in Germany which makes our instrument your choice for minimally invasive surgery.

Our portfolio includes instruments and trocars as well as different specialties, endoscopes and advanced energy solutions. Together with our clinical partners we have defined a complete Laparoscopic Set which fulfill the requirements for minimal invasive surgery from the first cut till the last stitch.

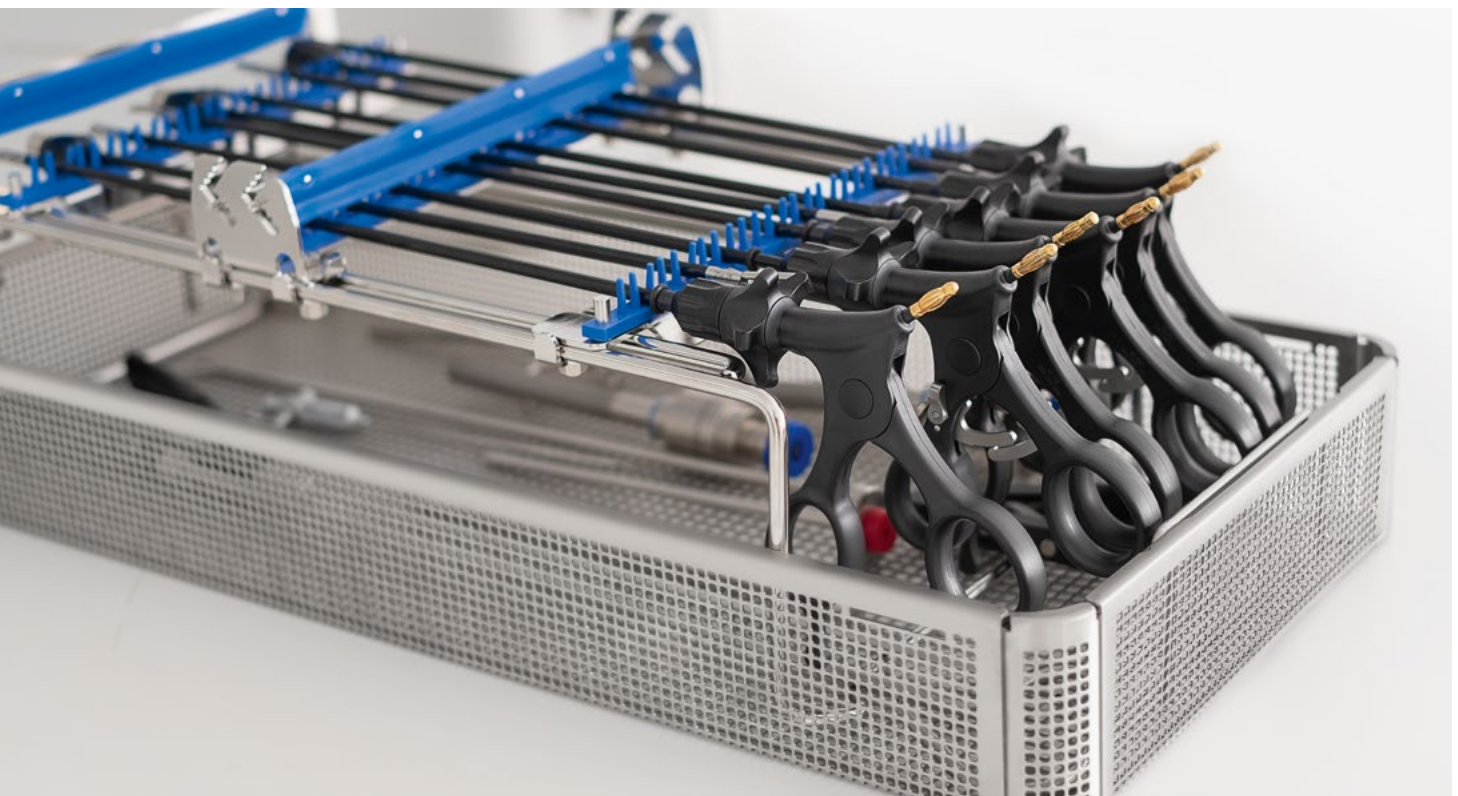

CONTAINER SET #1

Grasping and Dissecting Forceps, Needle Holders, Scissors, Trocars and other specialities makes the first Container fully equipped with the instruments you need.

Open the tray and start working without missing your favorite instrument.



300-900-902 (Set #1 + Set #2)

CONTAINER SET #2







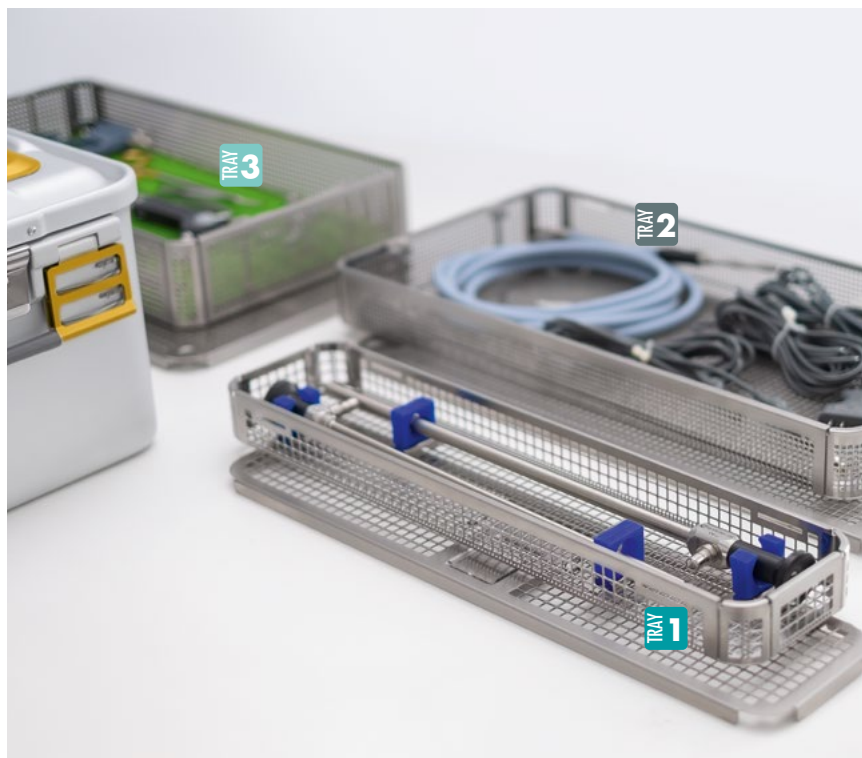





The second container includes high class scopes, instruments, monopolar and bipolar solutions and many accessories.



















Everything stored in trays for easy cleaning and reprocessing.

Your CSSD department will like it.



CONTAINER SET #1



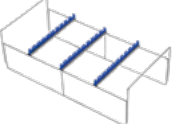







	Reducer Sleeve \varnothing 10 - 5mm, 180mm	300-012-455	1 pc.
	Reducer Sleeve \varnothing 5 - 4mm, 175mm, red	300-012-405	1 pc.
	Reducer Clip, for all modular trocar sleeves, 11.0 / 5.5mm	300-021-011	1 pc.
	Veress Needle, \varnothing 2mm, 120mm chrome, matt	300-195-120	1 pc.
	Multiport Multifunctional Trocar System \varnothing 11mm, 105mm working length blue metal trocar sleeve, smooth, oblique	300-222-011	2 pcs.
	Multiport Multifunctional Trocar System \varnothing 13mm, 102mm working length green metal trocar sleeve, smooth, oblique	300-222-013	1 pc.
	Multiport Multifunctional Trocar System \varnothing 5.5mm, 103mm working length white metal trocar sleeve, smooth, oblique	300-222-055	3 pcs.
	Trocar, \varnothing 11mm, pyramidal tip for 300-22X-011 & 300-23X-011	300-241-011	1 pc.
	Trocar, \varnothing 13mm, triangular, for 300-22X-013 & 300-23X-013	300-241-013	1 pc.
	Trocar, \varnothing 5.5mm, triangular, for 300-22X-055 & 300-23X-055	300-241-055	1 pc.
	Dick III Lightweight Needle Holder, TC, \varnothing 5mm, straight handle, 330mm working length, left curved jaw	300-300-140	1 pc.
	Dick III Lightweight Needle Holder, TC, \varnothing 5mm, straight handle, 330mm working length, right curved jaw	300-300-141	1 pc.

		Bullnose Grasping Forceps, heavy insert, deep serrated, double action Ø 5mm, 330mm working length, complete*	300-460-001	1 pc.
		Martin Grasping Forceps, multiple serrated, 4.8mm wide, single action Ø 5mm, 330mm working length, complete*	300-460-011	1 pc.
		Gripper #1 Grasping Forceps, fenestrated coarse serrated, double action Ø 5mm, 330mm working length, complete*	300-460-017	1 pc.
		Hook Scissors, round cutting blade, single action Ø 5mm, 330mm working length, complete*	300-420-060	1 pc.
		Metzenbaum Scissors, slightly curved 12mm short blade, double action Ø 5mm, 330mm working length, complete*	300-420-067	1 pc.
		Johans Grasping Forceps, 20mm fenestrated, double action Ø 5mm, 330mm working length, complete*	300-470-289	1 pc.
		Kelly Dissecting Forceps, cross-serrated slightly tapered, double action Ø 5mm, 330mm working length, complete*	300-420-732	1 pc.
		Dissecting & Grasping Forceps, right angled fine serrated, double action Ø 5mm, 330mm working length, complete*	300-420-735	1 pc.
		Articulating Triangular Retractor, straight, 60mm width, 330mm working length	300-069-000	1 pc.
		1/1 Sterilization Container, safety model, bottom non-perforated, yellow lid 580 x 280 x 200mm	600-580-205	1 pc.
		1/1 Stainless Steel Tray, perforated, 540 x 253 x 47mm	600-540-550	1 pc.
		Storage rack for MIS instruments	600-513-003	1 pc.





















* complete MIC Instrument, consists of insert, handle and shaft

CONTAINER SET #2

	TRAY 1	Laparoscope, 0°, Ø 10mm, 330mm working length	300-091-100	1 pc.
	TRAY 1	Laparoscope, 30°, Ø 5mm, 302mm working length	300-092-130	1 pc.
	TRAY 2	Monopolar Electrode, ceramic tip Ø 5mm, 360mm, spatula shaped	300-144-002	1 pc.
	TRAY 2	Monopolar Electrode, ceramic tip Ø 5mm, 360mm, L-Hook	300-144-005	1 pc.
	TRAY 3	RZ Power Handle Bipolar Forceps, Ø 5mm, detachable, flat plug	300-860-134	1 pc.
	TRAY 3	Powergrip Bipolar Grasping Forceps Ø 5mm, 340mm	300-860-013	1 pc.
	TRAY 3	Powergrip Bipolar TC Metzenbaum Scissors Ø 5mm, 340mm	300-860-018	1 pc.
	TRAY 3	Powergrip Bipolar Maryland Forceps Ø 5mm, 340mm	300-860-019	1 pc.
	TRAY 2	HF Cable, monopolar Valleylab/Lamiday/EMC, 3m	700-360-031	3 pcs.
	TRAY 2	HF Cable, bipolar RZ/Valleylab/ Lamiday/EMC, 3m	700-351-131	1 pc.
	TRAY 2	Fibre Optic Light Guide Cable, Ø 4.8mm, 230cm	250-048-230	1 pc.

		Adapter for fibre optic light guide RZ/Storz (unit)	250-039-000	1 pc.
		Adapter for fibre optic light guide RZ/Storz (endoscope)	300-042-000	1 pc.
		Knot Pusher with slit and eye, Ø 4mm, 330mm	300-030-001	1 pc.
		Tobias Fascia Needle Holder, spring handle 2mm tip, 150mm	300-151-000	1 pc.
		Suction/Irrigation Pistol Handle, 2-way-valve, 2x universal tube connector	300-166-100	1 pc.
		Suction/Irrigation Tube Ø 5mm, 4x4 holes, 340mm working length	300-173-005	1 pc.
		Suction/Irrigation Tube Ø 10mm, 4x4 holes, 340mm working length	300-173-010	1 pc.
		Palpation Probe, graduated Ø 5mm, 330mm working length	300-193-335	1 pc.
		Puncture and Injection Tube Ø 1.4mm tip, 20mm tip, Ø 5mm, 330mm working length	300-194-314	1 pc.
		Scalpel Handle No. 3, 130mm	110-110-003	1 pc.
		TC Metzenbaum Scissors, Fig. 1 curved, blunt/blunt, 145mm	120-511-145	1 pc.
		Adson Tissue Forceps, 1x2 teeth, 120mm	130-140-120	1 pc.

CONTAINER SET #2

		Halsted-Mosquito Hemostatic Forceps, straight, 125mm	140-254-125	2 pcs.
		TC Ligature Scissors, curved, serrated, 180mm	120-611-180	1 pc.
		Backhaus Towel Forceps, 130mm	140-573-130	4 pcs.
		Foerster Swab Forceps, straight, smooth jaw, 180mm	150-050-180	2 pcs.
		TC Mayo Hegar Needle Holder, straight, serrated, 160mm	180-550-160	1 pc.
		1/1 Sterilization Container, safety model, bottom non-perforated, yellow lid 580 x 280 x 200mm	600-580-205	1 pc.
		1/1 Stainless Steel Tray, perforated, 540 x 254 x 35mm	600-540-535	1 pc.
		1/1 Stainless Steel Tray, perforated, 540 x 254 x 55mm	600-540-555	1 pc.
		Silicone Mat, green 440 x 230mm	600-281-003	1 pc.
		Tray for 2 Endoscopes until 340mm	600-460-056	1 pc.



All you need in two containers
stored in different trays.

NATHANSON LIVER RETRACTOR SET

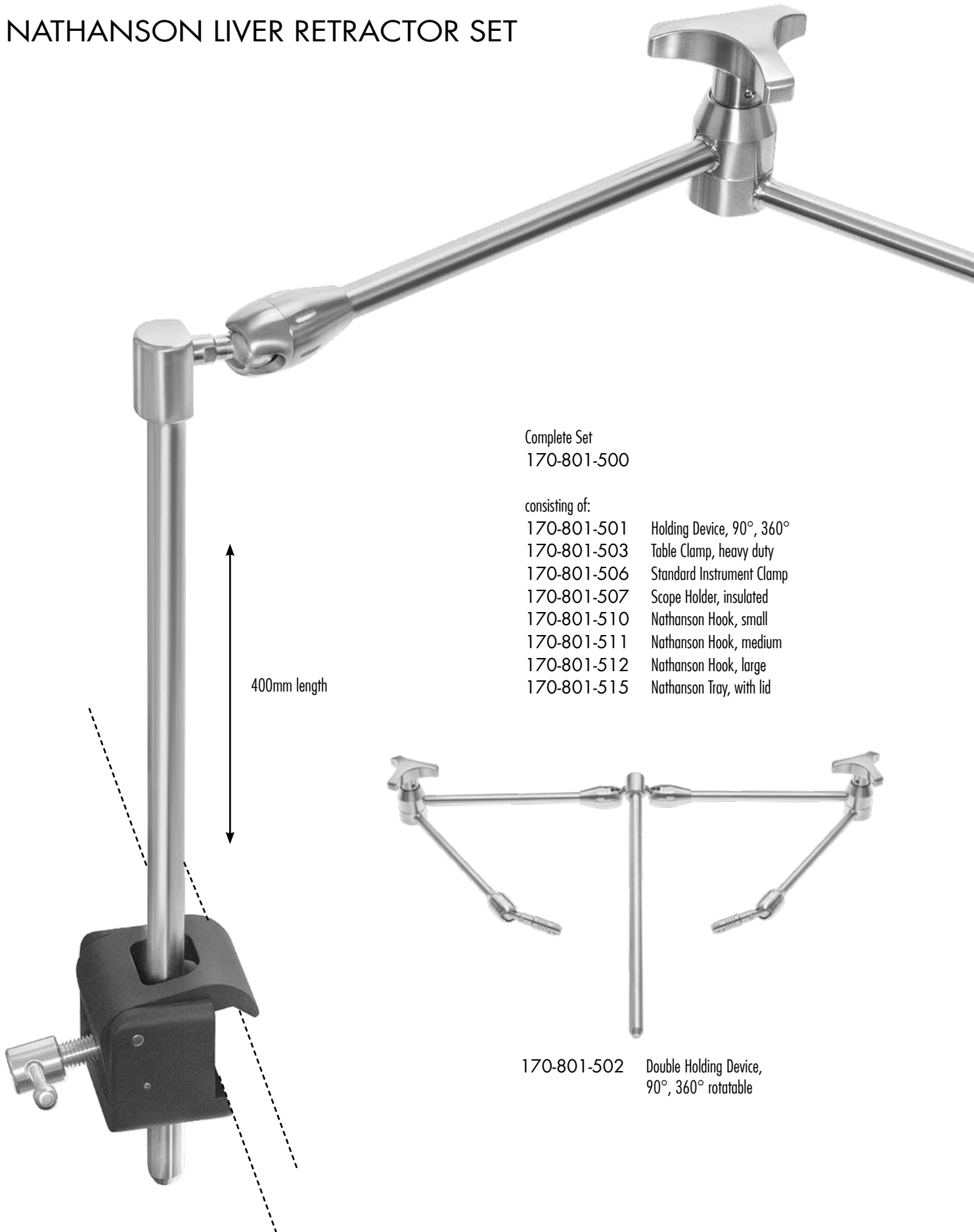

Complete Set
170-801-500

consisting of:

- 170-801-501 Holding Device, 90°, 360°
- 170-801-503 Table Clamp, heavy duty
- 170-801-506 Standard Instrument Clamp
- 170-801-507 Scope Holder, insulated
- 170-801-510 Nathanson Hook, small
- 170-801-511 Nathanson Hook, medium
- 170-801-512 Nathanson Hook, large
- 170-801-515 Nathanson Tray, with lid

400mm length



170-801-502 Double Holding Device,
90°, 360° rotatable

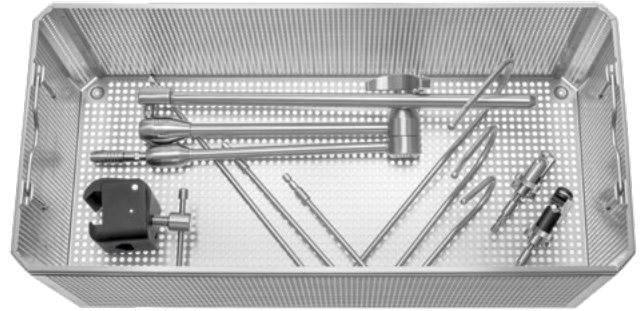

170-801-515
Tray, with lid, 540 x 253 x 197mm



Quick lock mechanism

- Hook, \varnothing 6.5mm
- 170-801-510 Small
 - 170-801-511 Medium
 - 170-801-512 Large

- Hook, \varnothing 3.0mm
- 170-802-520 Small
 - 170-802-521 Medium
 - 170-802-522 Large

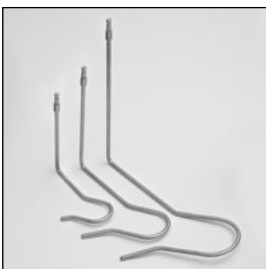



170-801-503 Table Clamp, heavy duty



170-801-507 Scope Holder, insulated



170-801-506 Standard Instrument Clamp

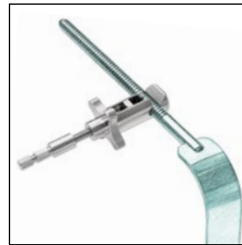

170-801-504 Universal Retractor Holder



170-801-505 Frame Clamp for Retractor Frames

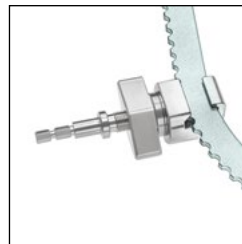

170-801-508 Ratchet mechanism



LAPAROSCOPES

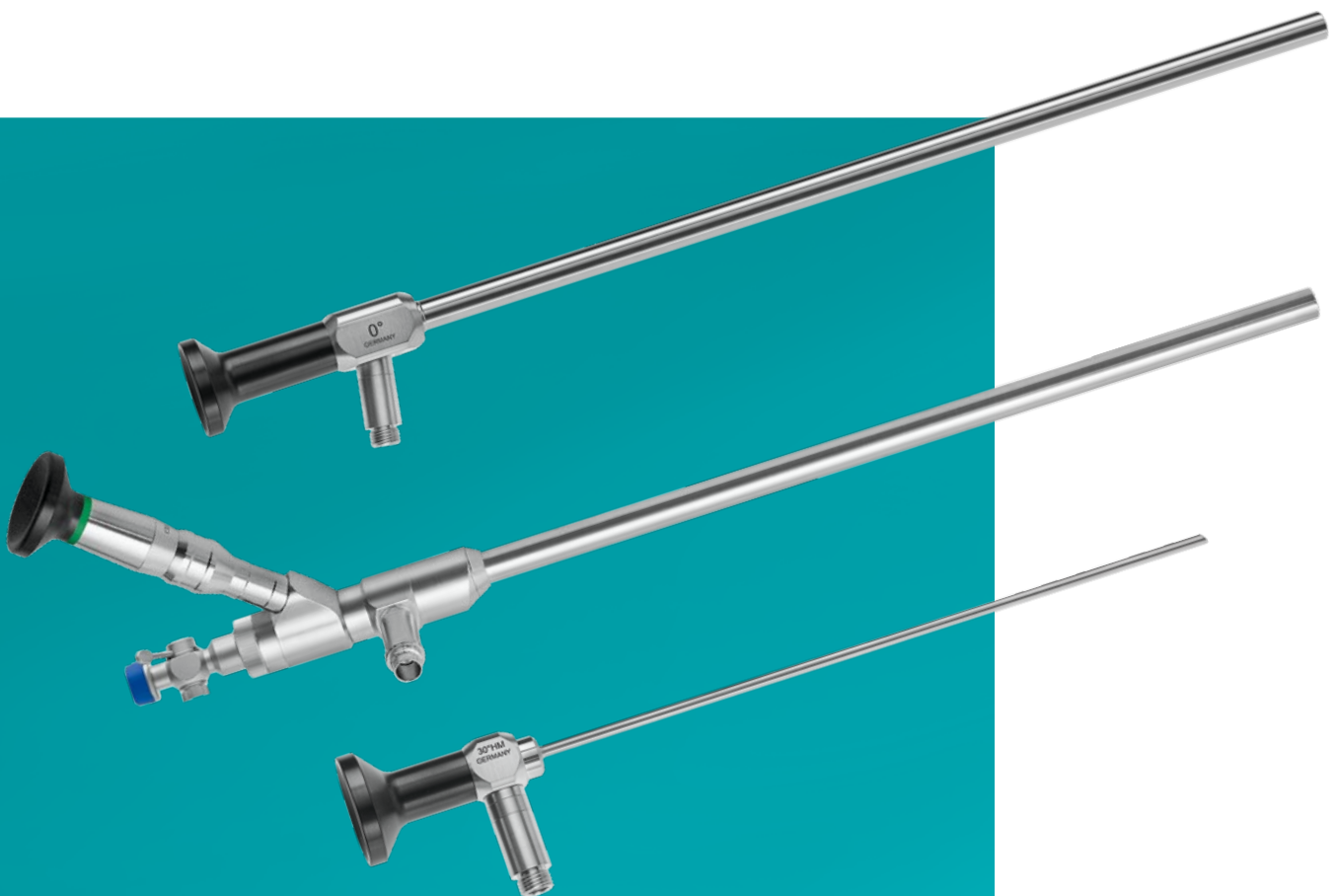

4K LAPAROSCOPES

State-of-the-art Laparoscopes to achieve excellent image quality and finest details in Ultra High Definition.

4K



∅
10 mm



0° DIRECTION OF VIEW

330mm working length 405mm overall length	300-100-400*
450mm working length 532mm overall length	300-200-400

30° DIRECTION OF VIEW

330mm working length 405mm overall length	300-100-430*
450mm working length 532mm overall length	300-200-430



∅
5.5 mm

0° DIRECTION OF VIEW

300mm working length 356mm overall length	300-155-400*
424mm working length 480mm overall length	300-255-400

30° DIRECTION OF VIEW

300mm working length 356mm overall length	300-155-430*
424mm working length 480mm overall length	300-255-430

ICG/NIR 4K LAPAROSCOPES

Endoscopes for Indocyanine Green (ICG) and Near Infrared (NIR) Laparoscopy procedures in 4K Ultra High Definition.

4K

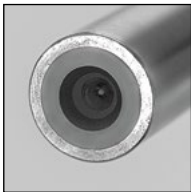

0° DIRECTION OF VIEW Ø 10mm

300mm working length	300-700-400
400mm working length	300-755-400

30° DIRECTION OF VIEW Ø 5.5mm

300mm working length	300-700-430
400mm working length	300-755-430

FULL HD LAPAROSCOPES

High definition pictures with significant detail-resolution through newest CAD - designed rod - lens systems.

FULL HD



0° DIRECTION OF VIEW

330mm working length 405mm overall length	300-091-100*
450mm working length 532mm overall length	300-091-430



30° DIRECTION OF VIEW

330mm working length 405mm overall length	300-091-130*
450mm working length 532mm overall length	300-091-433



45° DIRECTION OF VIEW

330mm working length 405mm overall length	300-091-145
450mm working length 532mm overall length	300-091-445

FULL HD LAPAROSCOPES

High definition pictures with significant detail-resolution through newest CAD - designed rod - lens systems.

FULL HD



0° DIRECTION OF VIEW

300mm working length	300-092-100*
356mm overall length	
424mm working length	300-096-455
480mm overall length	



30° DIRECTION OF VIEW

300mm working length	300-092-130*
356mm overall length	
424mm working length	300-096-453
480mm overall length	



45° DIRECTION OF VIEW

300mm working length	300-092-145
356mm overall length	
424mm working length	300-096-450
480mm overall length	



0° DIRECTION OF VIEW

207mm working length	300-097-100
270mm overall length	



30° DIRECTION OF VIEW

207mm working length	300-097-130
270mm overall length	

FULL HD OPERATING LAPAROSCOPES

For 11 mm trocar systems and single puncture,
6mm instrument channel

FULL HD



Ø
10 mm

0° DIRECTION OF VIEW

Parallel eye piece
270mm length

300-099-006



Stopcock with 6mm instrument channel

for 300-099-006
and 300-099-106
(included)

300-099-500



Ø
10 mm

0° DIRECTION OF VIEW

Lateral eye piece
270mm length

300-099-106



RECOMMENDATIONS FOR RZ LAPAROSCOPES

- Sterilization Containers and Trays for safe usage and storage:
pages 157-167
- Ø 3.5mm, Ø 4.8mm light cables and adapter pieces to be used with all RZ Laparoscopes:
page 179

ADVANCED TROCAR SYSTEMS

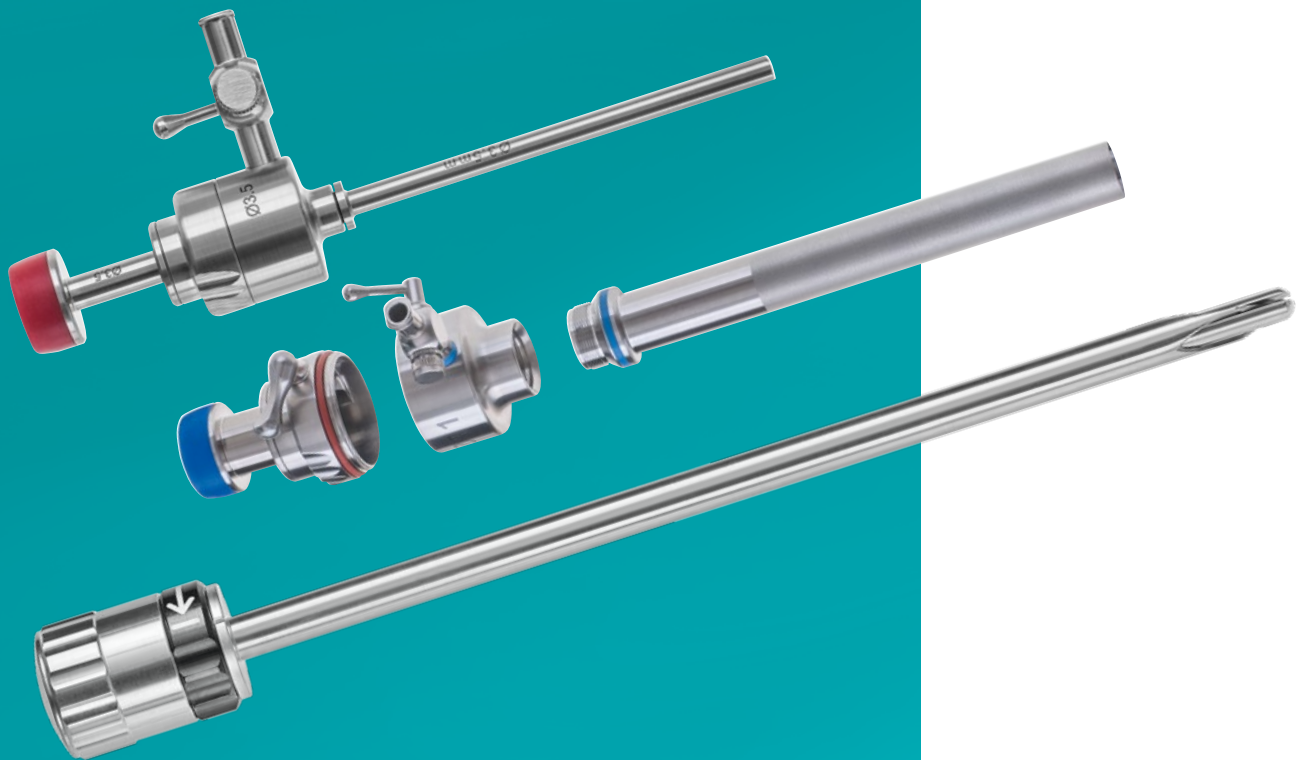



- 1 Reusable and autoclavable seals
- 2 Easy opening by pushing the lever
- 3 Stainless steel stopcock
- 4 Ergonomic stainless steel housing
- 5 Self-centering conical sleeve
- 6 Smooth stainless steel sleeve



Easy opening MultiPort System



Improved trap-door valves



SILIPORT TROCAR SYSTEM

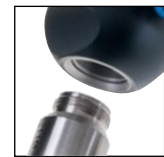

- 1 Reusable and autoclavable seals
- 2 Reusable and autoclavable silicon valve
- 3 Stainless steel stopcock
- 4 Lightweight synthetic housing
- 5 Self-centering conical sleeve
- 6 Synthetic threaded lightweight sleeve



Highest safety due to stainless steel connections

Color code	∅
	5.5mm
	11.0mm
	13.0mm

MultiPort Trocar System



SiliPort Trocar System



Multiport Trocar Sleeves, 100mm working length

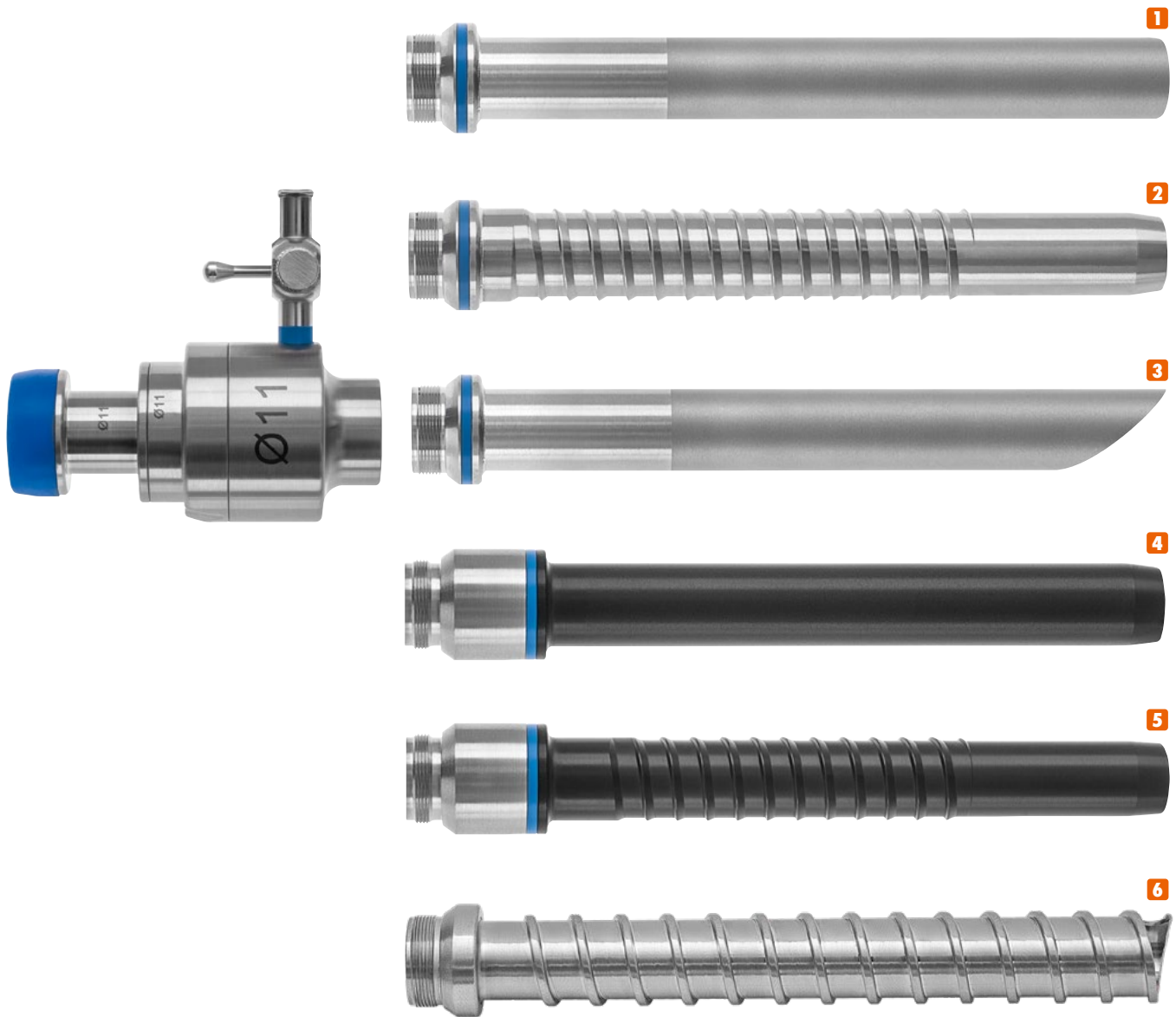

- 1** Stainless steel sleeve, smooth
- 2** Stainless steel sleeve, thread
- 3** Stainless steel sleeve, oblique
- 4** Synthetic sleeve, smooth
- 5** Synthetic sleeve, thread
- 6** Stainless Steel Sleeve, self-cutting

	Ø 5.5mm	Ø 11mm	Ø 13mm
1	300-220-055*	300-220-011*	300-220-013*
2	300-221-055	300-221-011	300-221-013
3	300-222-055*	300-222-011*	300-222-013*
4	300-223-055	300-223-011	300-223-013
5	300-224-055	300-224-011	300-224-013
6	300-226-055	300-226-011	300-226-013

Siliport Trocar Sleeves, 100mm working length

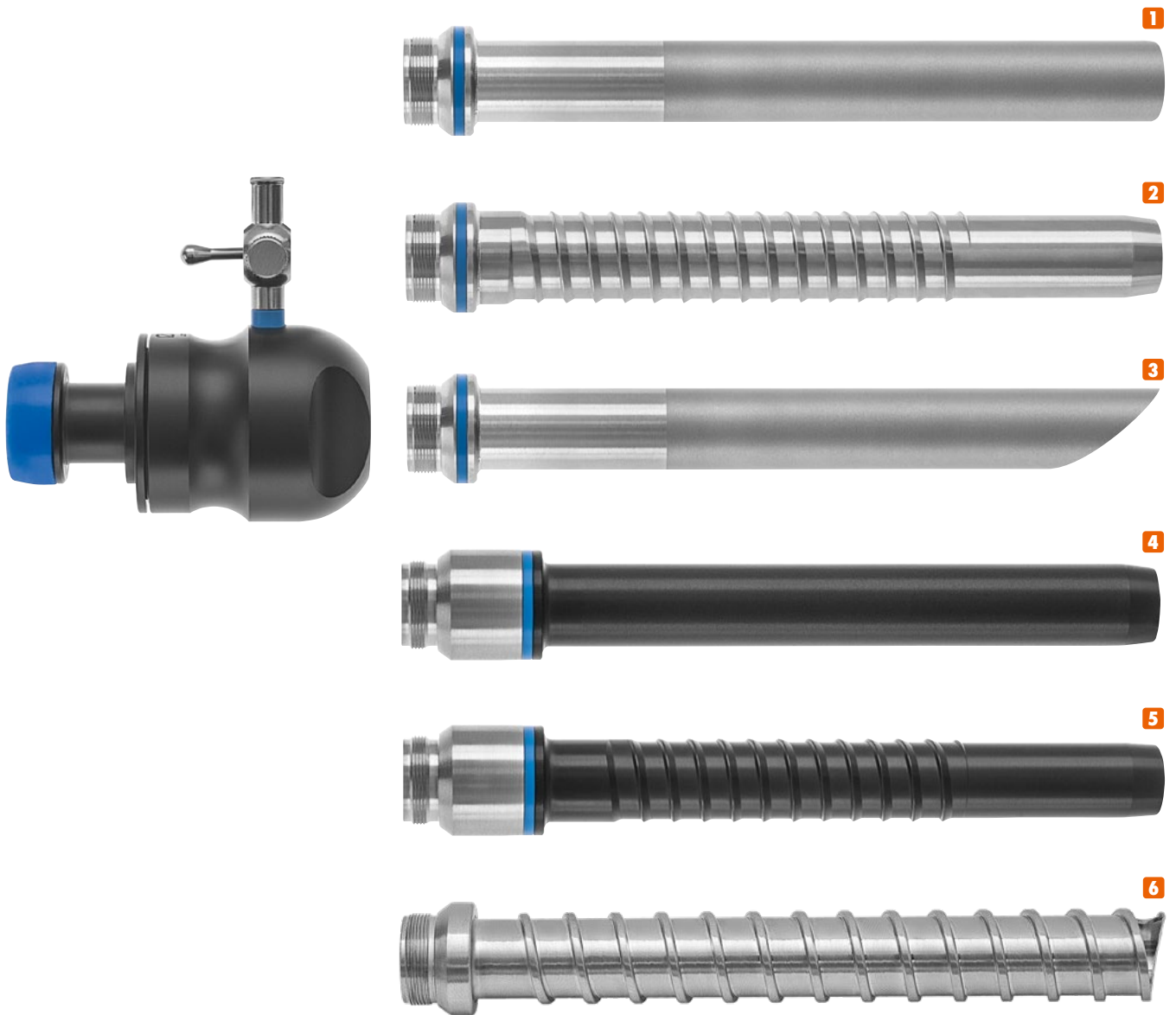

- 1** Stainless steel sleeve, smooth
- 2** Stainless steel sleeve, thread
- 3** Stainless steel sleeve, oblique
- 4** Synthetic sleeve, smooth
- 5** Synthetic sleeve, thread
- 6** Stainless Steel Sleeve, self-cutting

	Ø 5.5mm	Ø 11mm	Ø 13mm
	300-230-055	300-230-011	300-230-013
	300-231-055	300-231-011	300-231-013
	300-232-055	300-232-011	300-232-013
	300-233-055	300-233-011	300-233-013
	300-234-055	300-234-011	300-234-013
	300-236-055	300-236-011	300-236-013

SPECIAL SIZED TROCAR SYSTEM



Stainless steel trocar with oblique sleeve, 109.9mm working length
Ø 15mm 300-020-015

Stainless steel trocar with oblique sleeve, 118.7mm working length
Ø 20mm 300-020-020

PEDIATRIC TROCAR SYSTEM



Stainless steel trocar with smooth sleeve, 70mm working length
Ø 3.5mm 300-112-035

SPARE TROCAR SLEEVES



1

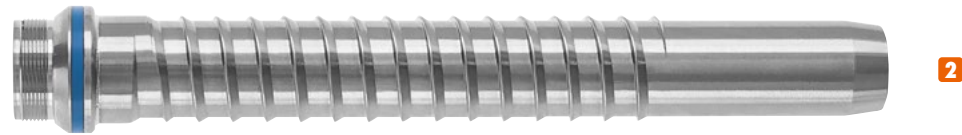

2



3



4



5



6

	Ø 5.5mm	Ø 11mm	Ø 13mm
1 Stainless steel sleeve, smooth	300-220-255	300-220-211	300-220-213
2 Stainless steel sleeve, thread	300-221-255	300-221-211	300-221-213
3 Stainless steel sleeve, oblique	300-222-255	300-222-211	300-222-213
4 Synthetic sleeve, smooth	300-233-255	300-233-211	300-233-213
5 Synthetic sleeve, thread	300-234-255	300-234-211	300-234-213
6 Stainless Steel Sleeve, self-cutting	300-236-255	300-236-211	300-236-213

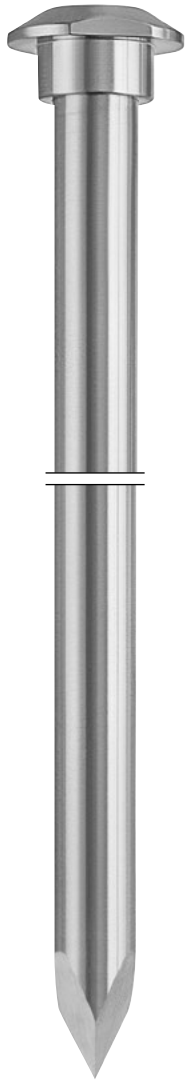

Standard trocar
with pyramidal tip, reusable, cutting

300-241-035	Ø 3.5mm
300-241-055*	Ø 5.5mm
300-241-011*	Ø 11mm
300-241-013*	Ø 13mm
300-241-015	Ø 15mm
300-241-020	Ø 20mm

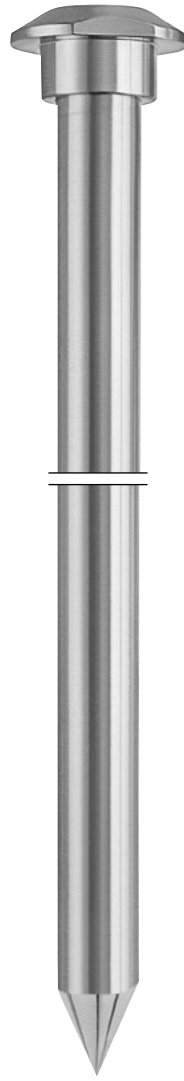

Standard trocar
with conical tip, reusable, cutting

300-240-035	Ø 3.5mm
300-240-055*	Ø 5.5mm
300-240-011*	Ø 11mm
300-240-013*	Ø 13mm
300-240-015	Ø 15mm
300-240-020	Ø 20mm

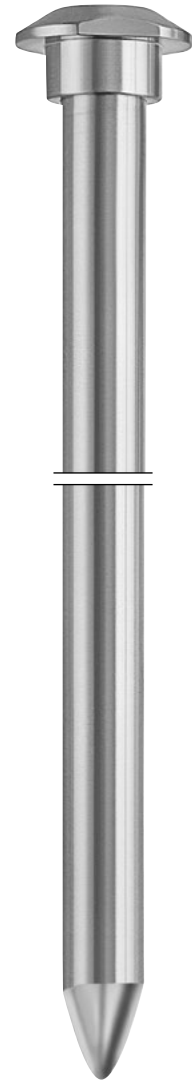

Hasson Obturator with blunt ball tip,
reusable, atraumatic

300-242-035	Ø 3.5mm
300-242-055	Ø 5.5mm
300-242-011	Ø 11mm

SAFETY TROCARS

- Avoids injuries in the abdomen
- Automatic self-locking shielding
- Shield covers the cutting edges
- Minimal Puncture wound due to rounded cutting edges



300-152-055* 5.5 mm
 300-152-011* 11.0 mm
 300-152-012 12.5 mm



Shielded trocar tip



Sharp trocar tip



Safety mechanism

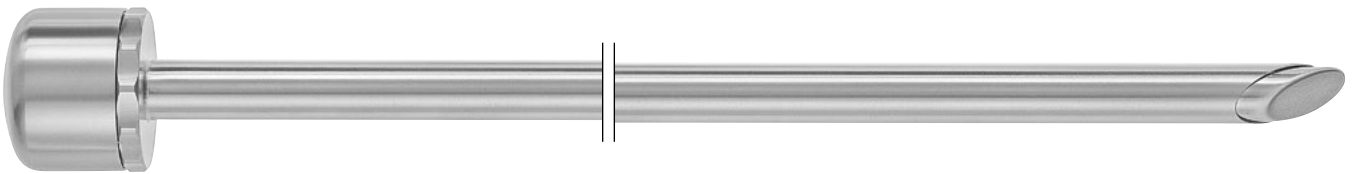

Safety trocar with oblique cutting edge

300-154-055 5.5 mm
 300-154-011 11.0 mm
 300-154-125 12.5 mm

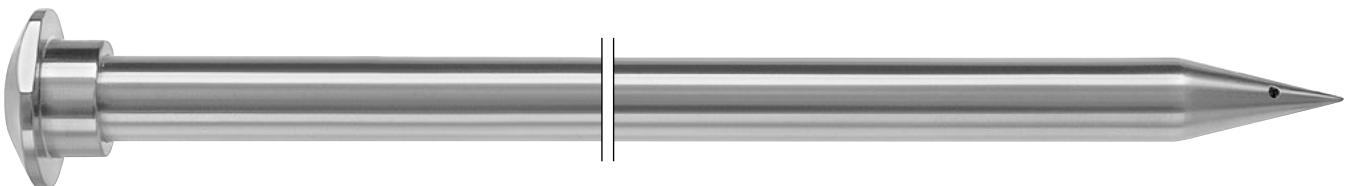

Cannulated trocars with hole, conical tip

300-243-055 5.5 mm
 300-243-011 11.0 mm
 300-243-013 13.0 mm

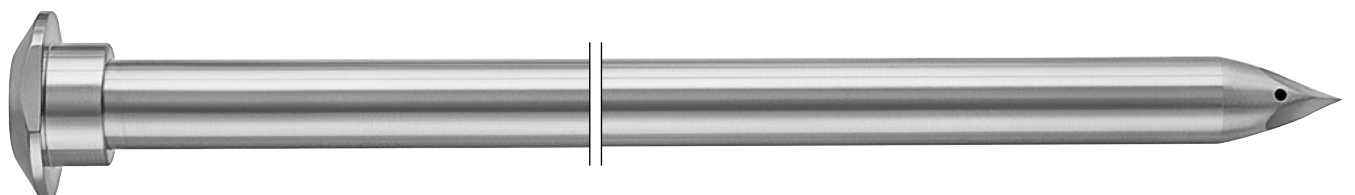

Cannulated trocars with hole, trocar point

300-244-055 5.5 mm
 300-244-011 11.0 mm
 300-244-013 13.0 mm

SPARE PARTS



1
Silicone seal insert for SiliPort
Trocar System, 5 pieces
300-025-358* Ø 5.5mm
300-025-359* Ø 11mm
300-025-359 Ø 13mm



2
Sealing caps, color-coded, 10 pieces
300-250-035 Ø 3.5mm (red)
300-250-055* Ø 5.5mm (white)
300-250-011* Ø 11mm (blue)
300-250-013* Ø 13mm (green)
300-020-915 Ø 15mm (grey)
300-020-920 Ø 20mm (grey)



3
Gaskets for MultiPort Trocar System, 10 pieces
300-250-235 Ø 3.5mm (black)
300-250-255 Ø 5.5mm (white)
300-250-211 Ø 11mm (blue)
300-250-213 Ø 13mm (green)
300-020-215 Ø 15mm (blue)
300-020-220 Ø 20mm (blue)

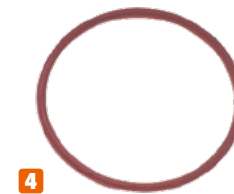

4
Gaskets for MultiPort Trocar System, 10 pieces
300-250-135 Ø 3.5mm
300-250-155 Ø 5.5mm
300-250-111 Ø 11mm
300-250-113 Ø 13mm
300-020-115 Ø 15mm
300-020-120 Ø 20mm



Reducer clip with silicone band

for all RZ trocar systems

300-021-011* Ø 11mm → 5.5 mm

300-021-125 Ø 12.5mm → 5.5 mm



Reducer clip with silicone band for

all RZ trocar systems

300-021-355* Ø 11mm → 5.5 mm

300-021-380 Ø 11mm → 8.0 mm

300-021-305 Ø 13mm → 5.5 mm

300-021-310 Ø 13mm → 10.0 mm



Slide-reducer for all RZ Trocar Systems

300-021-455 Ø 11mm → 5.5 mm

300-021-405 Ø 13mm → 5.5 mm

300-021-410 Ø 13mm → 10.0 mm



Reducer Sleeve short, for all RZ modular trocar systems, 60mm

300-012-106 Ø 10mm → 5.0 mm

300-012-116 Ø 11mm → 5.5 mm

300-012-121 Ø 12.5mm → 5.5 mm

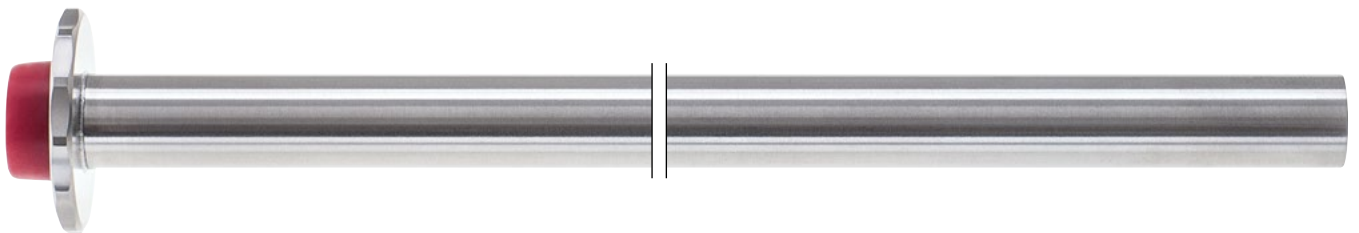

Reducer Sleeve long, for all RZ modular trocar systems, 190mm

300-012-405* Ø 5.0mm → 4.0mm (red)*

300-012-455* Ø 10.0/11.0mm → 5.5mm (red)

300-012-410 Ø 12.5mm → 10.0mm (blue)

300-012-412 Ø 12.5mm → 5.5mm (red)

300-012-415 Ø 15.0mm → 10.0mm (blue)

300-012-416 Ø 15.0mm → 5.5mm (red)

300-012-425 Ø 20.0mm → 15.0mm (grey)

300-012-420 Ø 20.0mm → 10.0mm (blue)

300-012-421 Ø 20.0mm → 5.5mm (red)

* 175mm



RZ Dilation Set

- 300-013-511 for 5.5 → 11.0 mm
- 300-013-510 for 5.5 → 10.0 mm
- 300-013-115 for 11.0 → 15.0 mm
- 300-013-512 for 5.5 → 12.5 mm
- 300-013-522 for 11.0 → 20.0 mm



Fixable sliding Hasson Cone with suture fixation device, for all RZ Modular Trocar Systems with smooth metal sleeves

- 300-014-155 Ø 5.5mm
- 300-014-111 Ø 11mm
- 300-014-113 Ø 13mm



Fixable sliding Hasson cone with suture fixation device, for all RZ Modular Trocar Systems with smooth metal sleeves

- 300-014-711 Ø 11mm

FLEXIBLE TROCAR SYSTEM FOR THE USE OF CURVED INSTRUMENTS

- Complete Thorax trocar system
- For inserting curved or strongly curved jaws
- For 5mm and 10mm instruments

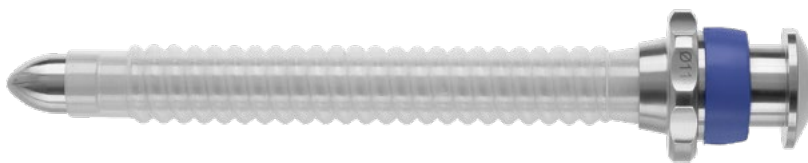
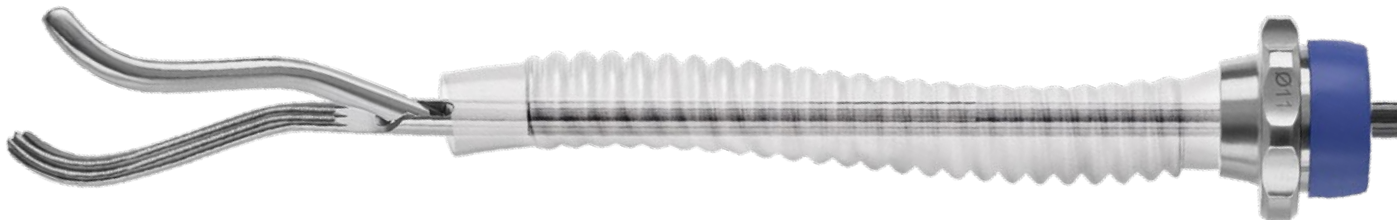

Thorax Trocar System, flexible, complete, Ø 11 mm
 300-020-211 100 mm working length
 300-020-711 70 mm working length



Thorax Trocar Sheath, Ø 11 mm,
 for 100 mm
 300-021-111



Thorax Trocar System, flexible, complete, Ø 5.5 mm
 300-020-255 100 mm working length
 300-020-755 70 mm working length



Thorax Trocar Sheath, Ø 5.5 mm
 300-021-155 for 100 mm
 300-021-755 for 70 mm



Obturator for flexible Thorax Trocar System
 300-023-111 Ø 11.0mm, 100mm
 300-023-711 Ø 11.0mm, 70mm
 300-023-255 Ø 5.5mm, 100mm
 300-023-755 Ø 5.5mm, 70mm



Gasket for Thorax Trocar System
 Ø 11mm (package of 10 pcs.)
 300-250-011 blue
 300-250-055 white



Plastic Trocar Sleeve, flexible, package of 5 pieces
 300-024-111 Ø 11.0mm, 100mm
 300-024-711 Ø 11.0mm, 70mm
 300-024-155 Ø 5.5mm, 100mm
 300-024-755 Ø 5.5mm, 70mm



300-023-100 Endo Dilator Speculum, 195mm, with 3 blades, for symmetric dilation of the tissue during heavy tissue removal



300-098-105 Tissue retractor, S-shaped, pair with 2 pieces to expose anatomical layers



Insufflation needle, matt chrome, \varnothing 2 mm

300-195-080	80 mm
300-195-100	100 mm*
300-195-120*	120 mm*
300-195-150	150 mm*
300-195-170	170 mm
300-195-200	200 mm

* standard length

Insufflation needle, polished chrome, \varnothing 2.7 mm, High-Flow

300-195-300	100 mm
300-195-320	120 mm*
300-195-350	150 mm*
300-195-370	170 mm*

SUCTION AND IRRIGATION

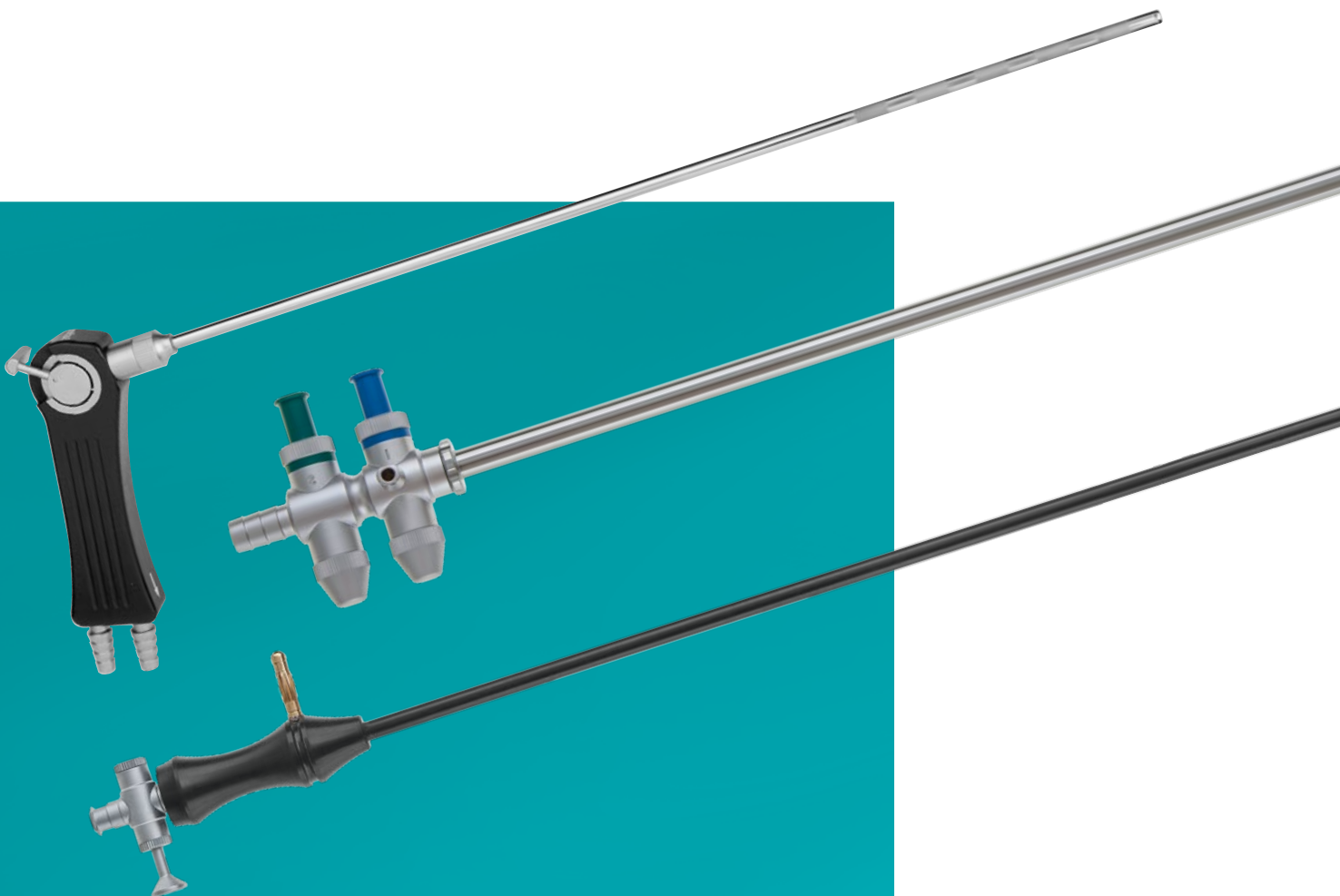

RZ EASYCLEAN SUCTION AND IRRIGATION SYSTEM

- 2 color coded trumped valves
- Universal suction channel
- Lateral LuerLock irrigation channel



- 300-019-500* Set with 5mm and 10mm suction tubes and large suction channel
- 300-019-501 Handle only, with large suction channel
- 300-019-600 Set with 5 mm and 10 mm suction tubes and small suction channel
- 300-019-601 Handle only, with small suction channel



- Suction and irrigation handle
- 300-019-501 large suction channel
- 300-019-601 small suction channel



- 300-192-000* Suction and irrigation handle with rotating 2-way lever mechanism and 2 large universal tube adapters with LuerLock connector



- 300-019-790 Screw cap
- 1 unit



- 300-019-780 Gasket O-Ring
- 1 set with 10 pieces



- 300-019-770 Spring
- 1 set with 10 pieces



- 300-019-740 Valve Body

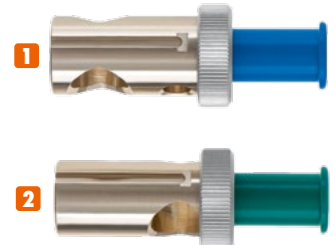

- 1 300-019-760 Irrigation piston
- 1 unit
- 2 300-019-750 Suction piston
- 1 unit

Suction and irrigation tubes, for 300-019-501 and 300-019-601

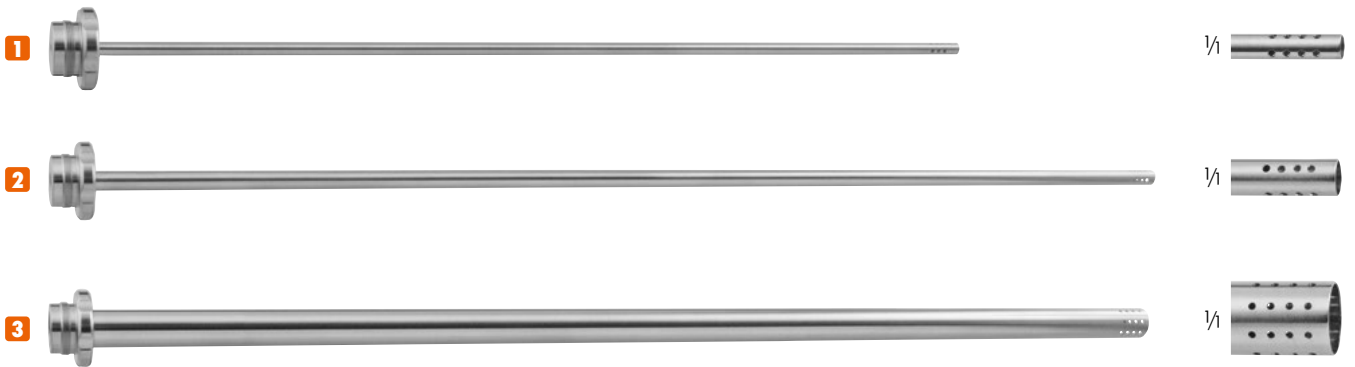

4 x 4 holes, 340mm working length

- 1** 300-019-735 \varnothing 3.5mm
- 2** 300-019-705 \varnothing 5.0mm
- 3** 300-019-710 \varnothing 10.0mm

Suction and irrigation tubes, for 300-192-000

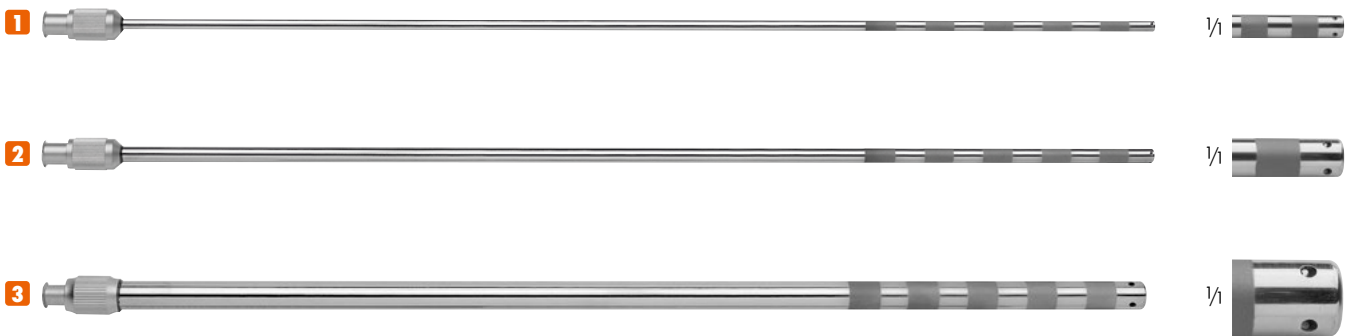

4 holes on the tip, with markings and LuerLock, 340 mm working length

- 1** 300-192-003 \varnothing 3mm
- 2** 300-192-005* \varnothing 5mm
- 3** 300-192-010* \varnothing 10mm

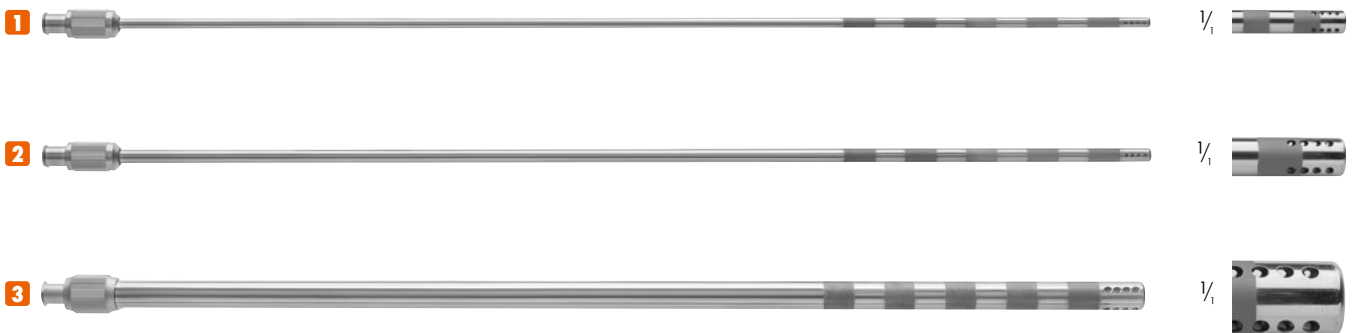

4x 4 holes, with markings and LuerLock, 340mm working length

- 1** 300-193-003 \varnothing 3mm
- 2** 300-193-005* \varnothing 5mm
- 3** 300-193-010* \varnothing 10mm



300-165-100 Suction and irrigation handle with 2 trumpet valves. Suction channel with large universal tube connector, irrigation channel with lateral LuerLock connection. Removable ergonomic handle plate for easy cleaning and maintenance.



300-167-100 Suction and irrigation handle with 1 trumpet valve and large universal tube adapter. To control suction or irrigation.



300-166-100* Pistol-shaped suction and irrigation handle with 2-way valve and 2 large universal tube connectors for suction and irrigation.

Suction and irrigation tubes, for 300-165-100, 300-166-100 and 300-167-100



4 holes on the tip, with markings, 340mm working length

- 1** 300-172-003 \varnothing 3mm
- 2** 300-172-005* \varnothing 5mm
- 3** 300-172-010* \varnothing 10mm



4x4 holes, with markings, 340mm working length

- 1** 300-173-003 \varnothing 3mm
- 2** 300-173-005* \varnothing 5mm
- 3** 300-173-010* \varnothing 10mm









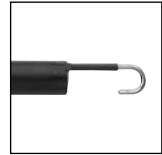



300-166-000 Pistol-shaped suction and irrigation handle with 2-way valve.
Additional rotating HF connector for monopolar cables.
2 large universal tube connectors for suction and irrigation.

ELECTRODES

340mm working length



	J-hook Electrode, thin wire	300-163-100
	J-hook Electrode, thick wire	300-163-110
	L-hook Electrode	300-163-120
	Spatula Electrode	300-163-130
	Ballpoint Electrode	300-163-140
	Knife Electrode	300-163-150
	45° Needle Electrode	300-163-160
	Needle Electrode	300-163-170
	Cone Electrode	300-163-180
	Irrigation tube for use without HF	300-163-190

ELECTRODES

with ceramic tip, 340mm working length

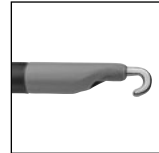

J-hook Electrode

300-163-810



L-hook Electrode

300-163-820



Spatula Electrode

300-163-830



Knife Electrode

300-163-850



45° Electrode

300-163-860



Needle Electrode

300-163-870

COAGULATION ELECTRODES

with 4mm HF connector, Ø 5mm, 330mm working length



J-hook Electrode 300-100-132



L-hook Electrode 300-100-133*



Spatula Electrode 300-100-131*



Ballpoint Electrode 300-100-134



SUCTION-IRRIGATION ELECTRODES

with 4mm HF connector, one piston and LuerLock connector, Ø 5mm, 330mm working length



J-hook Electrode 300-163-111



L-hook Electrode 300-163-121



Spatula Electrode 300-163-131



Ballpoint Electrode 300-163-141



HANDLE ELECTRODES

∅ 5mm, 360mm working length

- Large and ergonomic handle design
- Very fine tips
- Ceramic tip and PEEK shaft
- Suction connection optionally available



Without suction



With suction



Spatula Electrode

300-144-002*

300-145-003*



J-hook Electrode

300-144-004

300-145-004*



L-hook Electrode

300-144-005*

300-145-005*



Needle Electrode

300-144-006*







300-145-006*

ELECTRODES

with 4mm HF connector, Ø 5mm, 340mm / 440mm working length

- Coagulation Suction / Irrigation Electrode
- Ergonomic handle
- Ceramic tip



		340mm	440mm
	J-hook Electrode	300-163-410	300-163-610
	L-hook Electrode	300-163-420	300-163-620*
	Spatula Electrode	300-163-430	300-163-630
	Knife Electrode	300-163-450	300-163-650
	45° Needle Electrode	300-163-460	300-163-660
	Needle Electrode	300-163-470	300-163-670



Suction or irrigation tube with LuerLock, 4 x 4 holes and stopcock, Ø 5 mm
 300-006-305 330 mm working length
 300-006-455 450 mm working length



Puncture and injection needle with LuerLock adapter, 5 mm diameter, 20 mm needle length



	Needle tip	Working length	Needle length
300-194-307*	0.7 mm	330 mm	12mm
300-194-309*	0.9 mm	330 mm	20mm
300-194-312*	1.2 mm	330 mm	20mm
300-194-412	1.2 mm	450 mm	20mm
300-194-314*	1.4 mm	330 mm	20mm
300-194-414	1.4 mm	450 mm	20mm
300-194-318*	1.8 mm	330 mm	20mm
300-194-418	1.8 mm	450 mm	20mm



Palpation probe with markings and small handle



	Working length	Ø
300-193-305	330 mm	5mm
300-193-335*	330 mm	5mm
300-193-405	400 mm	5mm
300-193-410	400 mm	10mm

MONOPOLAR CABLES



Generator end



4mm socket

4mm socket, angled

2mm plug

4mm plug

3mm socket

4mm plug



RZ HF Unit Standard Plug

3m 700-501-303*

5m 700-501-503



RZ HF Unit SDS Plug

3m 700-501-300*

5m 700-501-500*



Erbe, Martin, Berchtold

3m 700-280-030*

700-290-030

700-291-030

700-292-030

700-293-033

5m 700-280-050*

700-290-050

700-291-050

700-293-035



Bovie, Valleylab, Conmed

3m 700-360-031*

700-361-030

700-362-030

700-363-030

700-364-030

700-370-030

5m 700-360-051*

700-361-050

700-362-050

700-363-050

700-370-050



Martin, Berchtold

3m 700-285-030*

700-286-030

700-286-130

700-286-230

5m 700-285-050*

700-286-050



Erbe ACC/ICC

3m 700-101-030

700-102-030

700-103-030

700-286-230

5m 700-101-050

700-103-050

700-104-050

RING HANDLE INSTRUMENTS

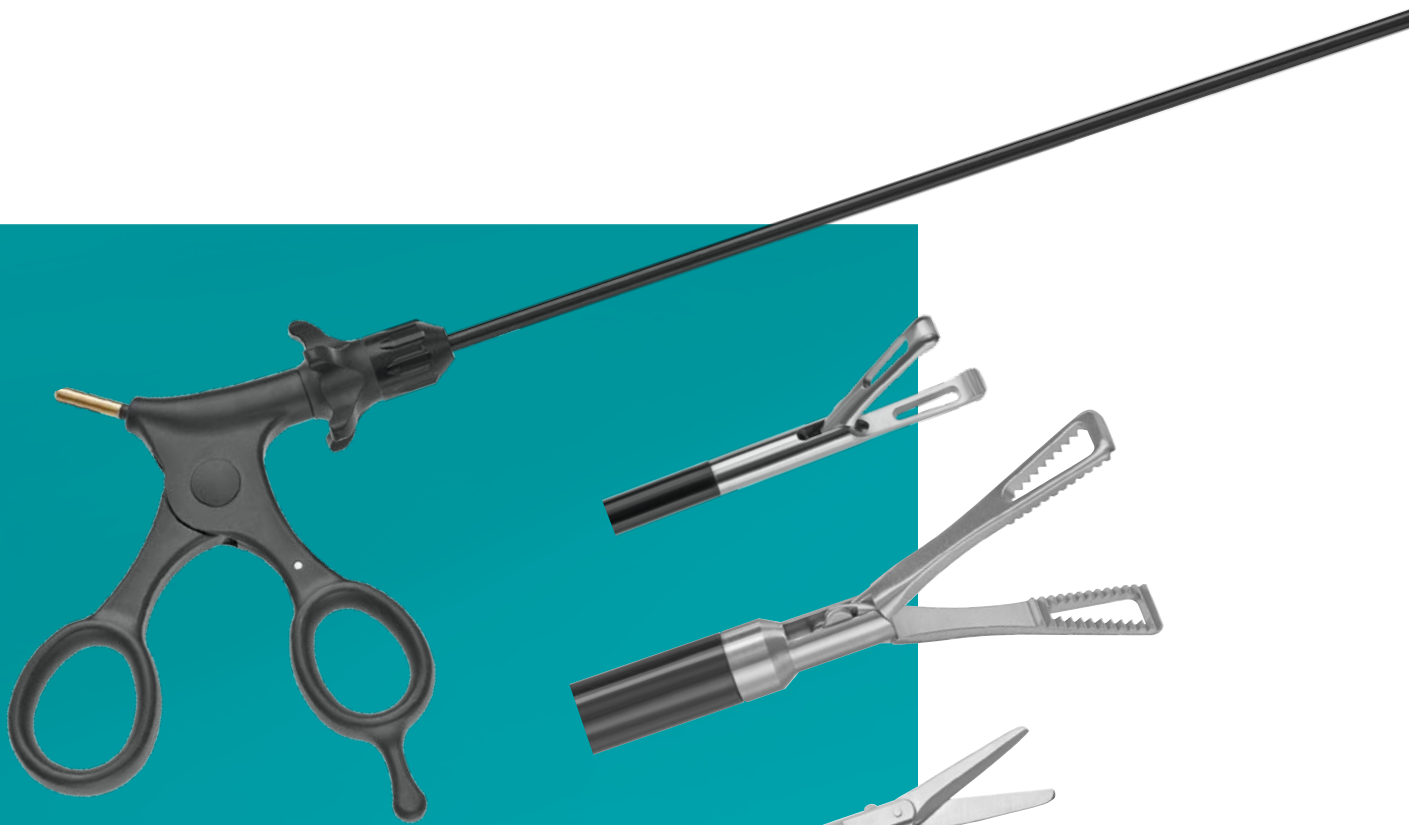

Handles



300-750-101*
PEEK Polymer Handle with
HF - connection



300-750-103*
PEEK Polymer Handle with ratchet
and HF - connection



300-750-105*
PEEK Polymer Handle with hook up
ratchet and HF - connection



300-750-106*
PEEK Polymer Handle with swing-away
ratchet, rotatable and HF - connection



300-750-001
Carbon Fiber Handle, rotating,
HF - connection



300-750-003
Carbon Fiber Handle, rotating,
with ratchet, HF - connection



300-750-015
Axial Handle with catch for needle holder
fixed, for all needle holder inserts,
with two gold rings

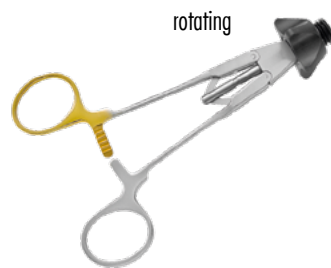

300-750-115
Axial Handle with catch, rotating,
for standard instrument,
with one golden ring



300-750-215
Axial Handle without catch,
non rotating, for standard instrument,
with two gold rings

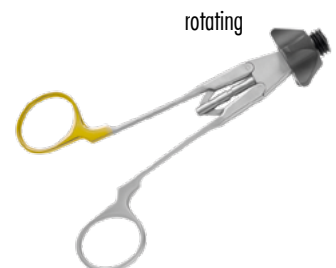

300-750-315
Axial Handle without catch, rotating,
for standard instrument, with one gold ring



Outer Sheath, insulated, adaptable to all handles, Ø 5 mm

210 mm 300-550-005
 330 mm 300-660-005*
 450 mm 300-760-005*

- exchangeable color coding locking nuts
- advantages in handling and cleaning
- strengthening of the shaft through a partial thickening at the proximal end



Outer Sheath, insulated, adaptable to all handles, Ø 10 mm

210 mm 300-550-010
 330 mm 300-660-010*
 450 mm 300-760-010*



Outer Sheath, insulated, adaptable to all handles, with LuerLock

Ø 5 mm 210 mm 300-550-105
 Ø 10 mm 210 mm 300-550-110
 Ø 5 mm 330 mm 300-660-105
 Ø 10 mm 330 mm 300-660-110
 Ø 5 mm 450 mm 300-760-105
 Ø 10 mm 450 mm 300-760-110



300-400-900
 Rubber Seals for LuerLock connectors
 sales unit: 5 pcs.

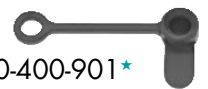

300-400-901*
 Rubber Seals for LuerLock connectors
 sales unit: 5 pcs.



Locking Nuts

300-661-005 5mm ●
 300-661-010 10mm ●
 300-661-006 5mm ●
 300-661-007 5mm ●
 300-661-008 5mm ●
 300-661-004 5mm ●
 300-661-009 3.5mm* ●



300-661-006OR
 Sealing ring, package of
 10 pieces,
 autoclavable

* for 3.5mm Mini Laparoscopy instruments



3-PIECE MODULAR INSTRUMENT

- Long-life and reliable materials
- Large variety of handle designs
- Ratchet mechanism / deactivation

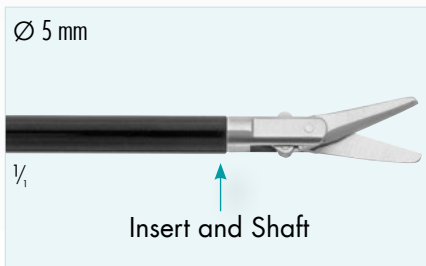

insert only

300-400-067

Insert's Catalogue-No.

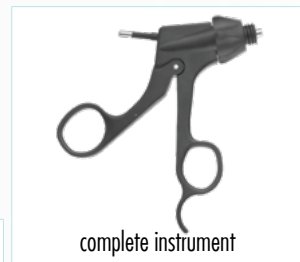

complete instrument

300-410-067

Catalogue-No. of the
complete Instrument



complete instrument

300-420-067

Catalogue-No. of the
complete Instrument

*Each piece can be ordered separately

*Each piece can be ordered separately



Watch the video on
YouTube



The RZ spherical head
locking system for fast
assembling / disassembling



Modular 3-piece detachable instrument system consists of:

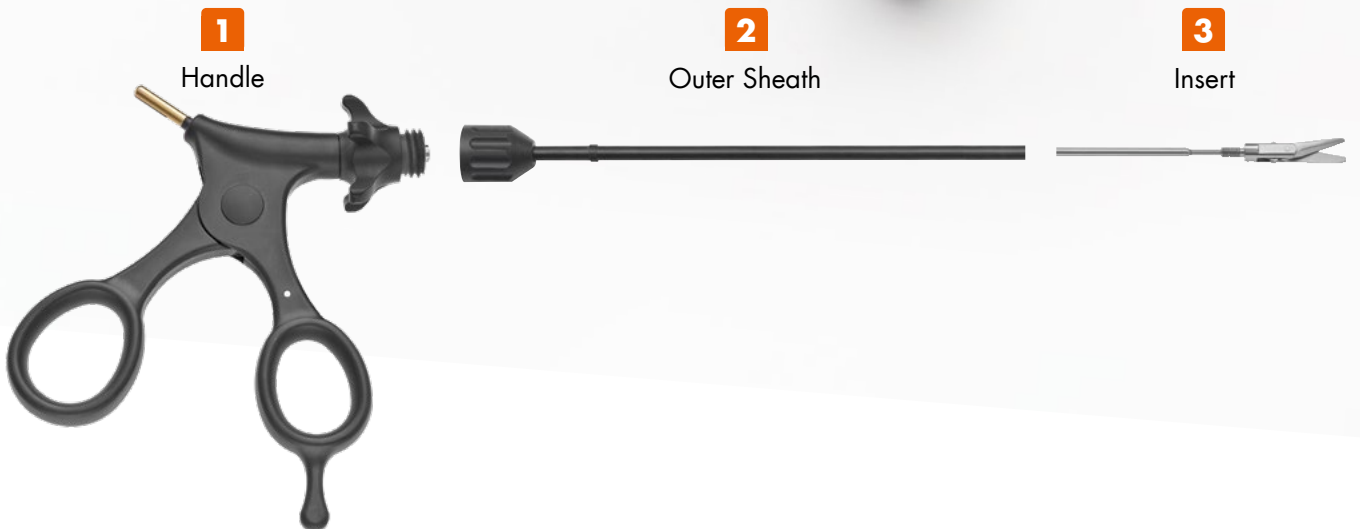

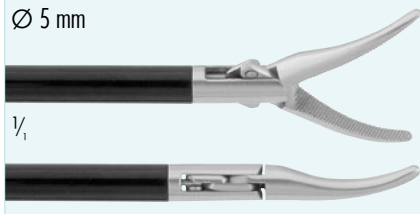

Catalogue-No. for insert only

300-400-732*



Complete Instrument
with handle 300-750-001

300-410-732



Complete Instrument
with handle 300-750-101

300-420-732*

KELLY

Dissecting forceps curved, slightly tapered, cross-serrated jaws, wide opening, double action, Ø 5 mm, 330 mm

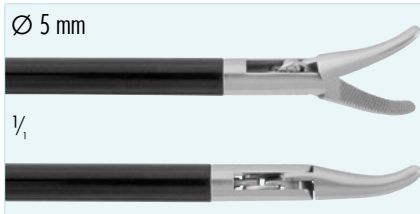

300-400-733

300-410-733

300-420-733

BABY KELLY

Short dissecting and suturing forceps, curved, tapered, cross-serrated jaws, wide opening, double action, Ø 5 mm, 330 mm

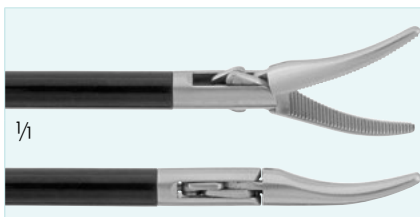

300-400-731*

300-410-731

300-420-731*

MARYLAND

Extra fine dissector with slightly tapered tip and gently curved for precise dissection, Ø 5 mm, 330 mm





300-400-738*

300-410-738

300-420-738*

MIXTER

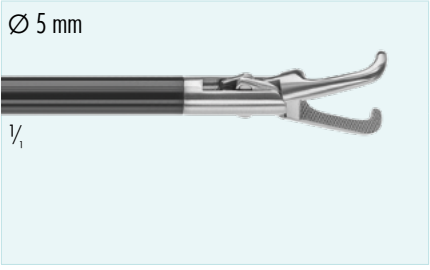
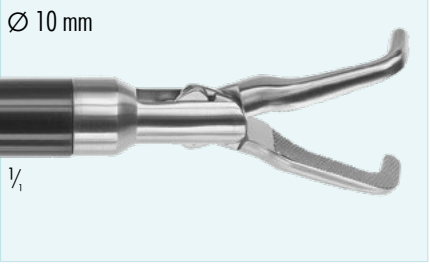
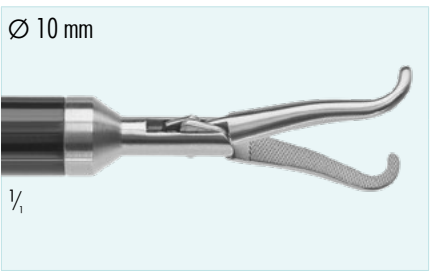
Fine dissecting forceps, 90° angled, fine serrated jaws, double action, Ø 5 mm, 330 mm

	insert only	Complete Instrument with handle 300-750-001	Complete Instrument with handle 300-750-101
<p>Ø 5 mm</p>  <p>1/1</p> <p>RIGHT ANGLE Dissecting grasping forceps, fine serrated jaws, double action, Ø 5 mm, 330 mm</p>	300-400-735*	300-410-735	300-420-735*
<p>Ø 10 mm</p>  <p>1/1</p> <p>RIGHT ANGLE Dissecting grasping forceps, fine serrated jaws, double action, Ø 10 mm, 330 mm</p>	300-400-736*	300-410-736	300-420-736*
<p>Ø 10 mm</p>  <p>1/1</p> <p>OVERHOLT Dissecting forceps 90° angled jaws, double action, Ø 10 mm, 330 mm</p>	300-400-741	300-410-741	300-420-741
<p>Ø 10 mm</p>  <p>1/1</p> <p>MIXTER Dissecting forceps, 10 mm long tip, 90° angled jaws, double action, Ø 10 mm, 330 mm</p>	300-400-740	300-410-740	300-420-740
<p>Ø 5 mm</p>  <p>1/1</p> <p>PETELIN Dissecting forceps, single action jaws, angled 60° left. deep serrations, Ø 5 mm, 330 mm</p>	300-400-027	300-410-027	300-420-027

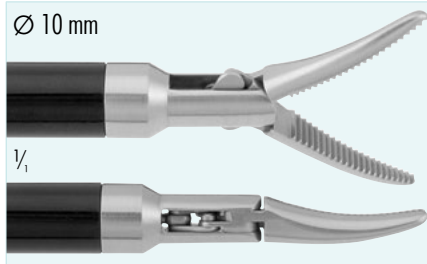

insert only
300-400-730

 Complete Instrument with handle 300-750-001
300-410-730

 Complete Instrument with handle 300-750-101
300-420-730

MARYLAND
Dissecting forceps curved left, blunt jaws, double action, Ø 10 mm, 330 mm

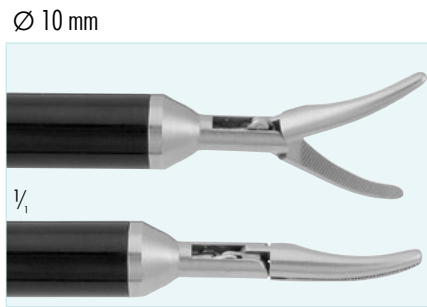

300-400-734

300-410-734

300-420-734

MIXTER 45°
Dissecting forceps curved with long fine serrated jaws, double action, Ø 10 mm, 330 mm

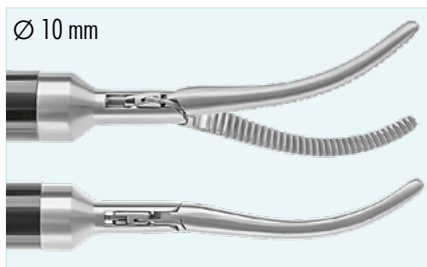

300-400-737

300-410-737

300-420-737

OVERHOLT-MIXTER
Dissecting forceps curved with slim long serrated jaws, double action, Ø 10 mm, 330 mm



300-400-739*

300-410-739

300-420-739*

MIXTER 90°
Dissecting forceps 90° angled, serrated jaws, double action, Ø 10 mm, 330 mm



insert only
300-400-044

Complete Instrument
with handle 300-750-001
300-410-044

Complete Instrument
with handle 300-750-101
300-420-044

ADHESION FORCEPS

Serrated jaws, one fenestrated, double action, ∅ 5 mm, 330 mm



300-400-109

300-410-109

300-420-109

GRASPING FORCEPS

1x2 teeth, single action, ∅ 5 mm, 330 mm

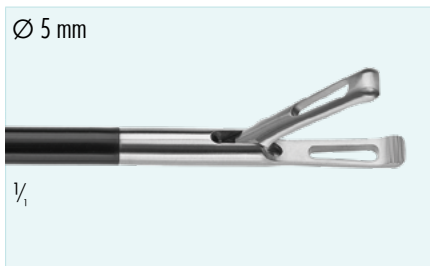

300-400-251*

300-410-251

300-420-251*

BABCOCK

Grasping forceps, single action, ∅ 5 mm, 330 mm

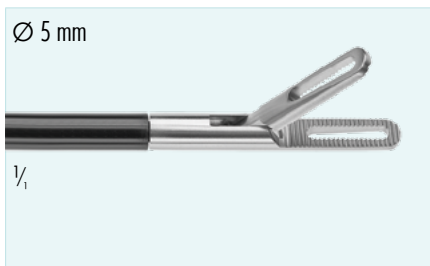

300-400-023

300-410-023

300-420-023

JOHANS

Grasping forceps, fenestrated jaws, serrated, 12mm, single action, ∅ 5 mm, 330 mm

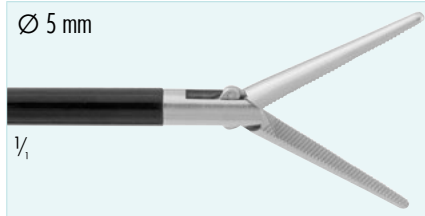

insert only
300-400-016*



300-410-016



300-420-016*

NEEDLE NOSE

Dissecting and grasping forceps with tapered and fine, cross-serrated jaws, double action, Ø 5 mm, 330 mm



300-400-003

300-410-003

300-420-003

NEEDLE NOSE

Dissecting and grasping forceps with tapered and fine, cross-serrated jaws, single action, Ø 5 mm, 330 mm



300-400-040

300-410-040

300-420-040

FENESTRATED BULLNOSE

Dissecting and grasping forceps with delicate, fenestrated and flat jaws, deep serration, double action, Ø 5 mm, 330 mm

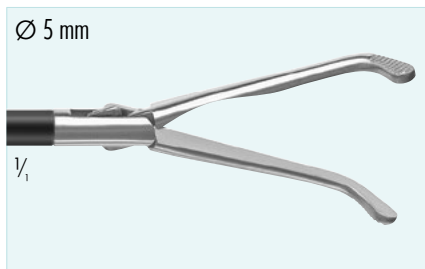

300-400-610

300-430-610

300-440-610

PYLORUS

Spreader, double action, Ø 5 mm, 330 mm

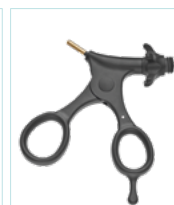

insert only

300-400-025*

300-410-025

300-420-025*

300-430-025

300-440-025*



DOLPHIN

Dissecting and grasping forceps with biopsy cup and fine serrated and tapered jaws, double action, Ø 5 mm, 330 mm

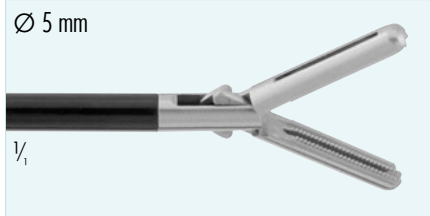

insert only
300-400-012*

Complete Instrument with handle 300-750-003
300-430-012

Complete Instrument with handle 300-750-103
300-440-012*

JAEGER
Grasping forceps with fenestrated jaws, DeBakey serration, 20 mm, double action, Ø 5 mm, 330 mm

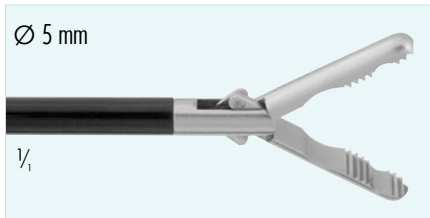

300-400-015*

300-430-015

300-440-015*

FUNDUS
Grasping forceps with 2 cups and serrated jaws, double action, Ø 5 mm, 330 mm



300-400-005

300-430-005

300-440-005

BULLDOG
Grasping forceps with fine serrated jaws, single action, Ø 5 mm, 330 mm

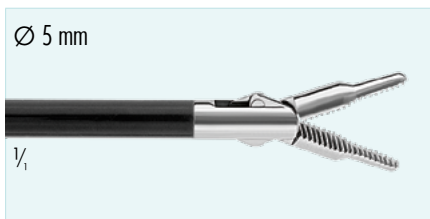





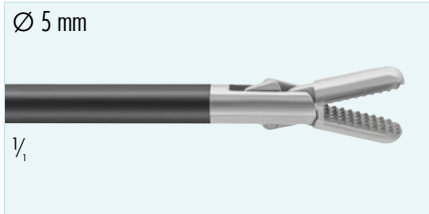

300-400-021

300-430-021

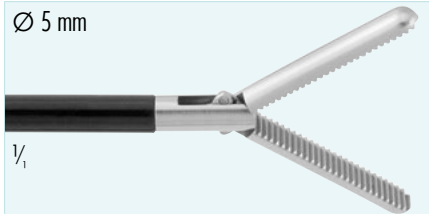
300-440-021

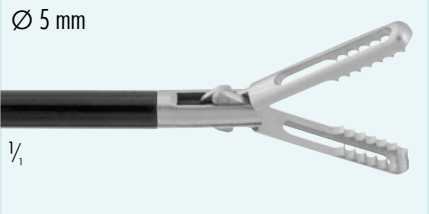
DOLPHIN
Grasping and dissecting forceps with fine serrated tapered jaws, double action, Ø 5 mm, 330 mm

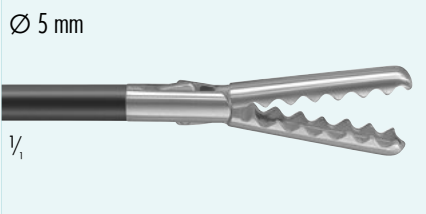

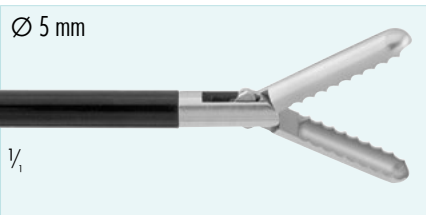

	insert only	Complete Instrument with handle 300-750-003	Complete Instrument with handle 300-750-103	Complete Instrument with handle 300-750-105
 <p>Ø 5 mm 1/1</p>	300-400-001*	300-430-001	300-440-001*	300-460-001*
BULLNOSE Grasping forceps, heavy pattern, standard serrated jaws, double action, Ø 5 mm, 330 mm				
 <p>Ø 5 mm 1/1</p>	300-400-008	300-430-008	300-440-008	300-460-008
STRONG TC GRASPER Grasping forceps with Tungsten Carbide jaw inserts, heavy pattern, pyramidal tip, serrated jaws, double action, Ø 5 mm, 330 mm				
 <p>Ø 5 mm 1/1</p>	300-400-029*	300-430-029	300-440-029*	300-460-029*
STRONG TC GRASPER Grasping forceps with Tungsten Carbide jaw inserts, heavy pattern, pyramidal tip, serrated, 15 mm long jaws, double action, Ø 5 mm, 330 mm				
 <p>Ø 5 mm 1/1</p>	300-400-002	300-430-002	300-440-002	300-460-002
XL BULLNOSE Grasping forceps, standard serrated jaws, double action, Ø 5 mm, 330 mm				
 <p>Ø 5 mm 1/1</p>	300-400-000	300-430-000	300-440-000	300-460-000
STANDARD Grasping forceps with biopsy cup, heavy pattern, standard serrated jaws, double action, Ø 5 mm, 330 mm				
 <p>Ø 5 mm 1/1</p>	300-400-017*	300-430-017	300-440-017*	300-460-017*
GRIPPER #1 Grasping forceps with coarse-serrated, fenestrated jaws, double action, Ø 5 mm, 330 mm				

	insert only	Complete Instrument with handle 300-750-003	Complete Instrument with handle 300-750-103	Complete Instrument with handle 300-750-105
 <p>Ø 5 mm 1/1</p> <p>PRESTIGE Atraumatic grasping forceps with long, wave shaped jaws and deep cup with lateral serration, double action, Ø 5 mm, 330 mm</p>	300-400-013*	300-430-013	300-440-013*	300-460-013*
 <p>Ø 5 mm 1/1</p> <p>PRESTIGE Grasping Forceps, wave-shaped lateral serration, and deep cup, single action, atraumatic, Ø 5 mm, 330 mm</p>	300-400-033*	300-430-033	300-440-033*	300-460-033*
 <p>Ø 5 mm 1/1</p> <p>ALLIGATOR Grasping forceps with fine sharp lateral teeth and deep cup, double action, Ø 5 mm, 330 mm</p>	300-400-053	300-430-053	300-440-053	300-460-053

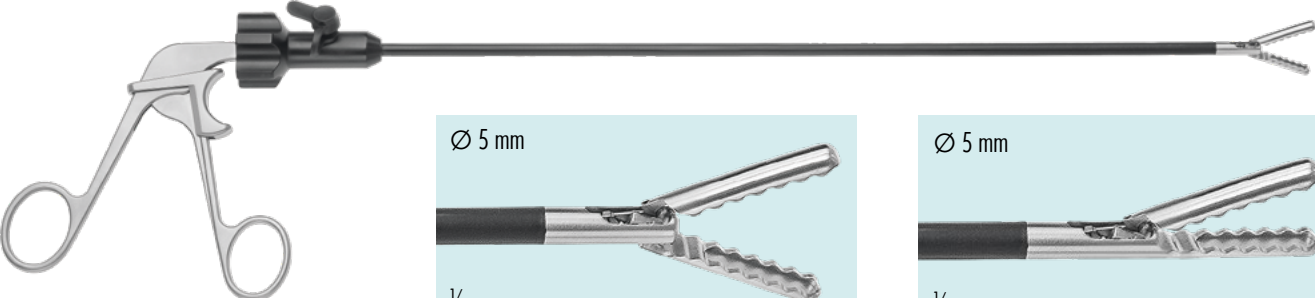
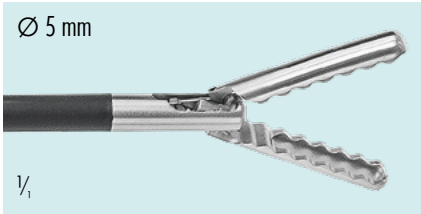
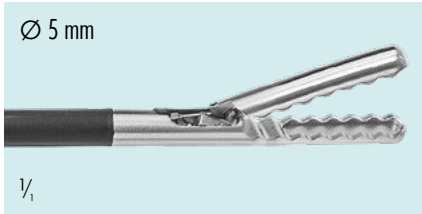
NON-DETACHABLE PRESTIGE FORCEPS

Complete Instrument, rotating, insulated, with prestige handle and Luer-Lock connection, 330mm working length

	 <p>Ø 5 mm 1/1</p> <p>300-111-013 Double action jaws</p>	 <p>Ø 5 mm 1/1</p> <p>300-111-033 Single action jaws</p>
--------------------------------------------------------------------------------------	-----------------------------------------------------------------------------------------------------------------------------------------------------	-------------------------------------------------------------------------------------------------------------------------------------------------------

	insert only	Complete Instrument with handle 300-750-003	Complete Instrument with handle 300-750-103	Complete Instrument with handle 300-750-105
 <p>Ø 5 mm 1/1</p> <p>KOCHER Grasping forceps with aggressive 3 x 4 teeth and serrated inner jaws, double action, Ø 5 mm, 330 mm</p>	300-400-004*	300-430-004	300-440-004*	300-460-004*
 <p>Ø 5 mm 1/1</p> <p>KOCHER Grasping forceps with aggressive 2 x 4 teeth and serrated inner jaws, single action, Ø 5 mm, 330 mm</p>	300-400-006	300-430-006	300-440-006	300-460-006
 <p>Ø 5 mm 1/1</p> <p>ALLIS Grasping forceps with 1 x 2 teeth and smooth inner jaws, single action, Ø 5 mm, 330 mm</p>	300-400-014	300-430-014	300-440-014	300-460-014
 <p>Ø 5 mm 1/1</p> <p>ALLIS Grasping forceps with 1 x 2 teeth and serrated inner jaws, double action, Ø 5 mm, 330 mm</p>	300-400-009	300-430-009	300-440-009	300-460-009
 <p>Ø 5 mm 1/1</p> <p>COBRA Grasping forceps with sharp 2 x 4 teeth and serrated inner jaws, double action, Ø 5 mm, 330 mm</p>	300-400-201*	300-430-201	300-440-201*	300-460-201*



insert only
300-400-011*

Complete Instrument
with handle 300-750-003
300-430-011

Complete Instrument
with handle 300-750-103
300-440-011*

Complete Instrument
with handle 300-750-105
300-460-011*

MARTIN

Grasping forceps with multiple fine serrations, 4.8 mm wide jaws, single action, Ø 5 mm, 330 mm



300-400-713*

300-430-713

300-440-713*

300-460-713*

CLAW GRASPER

Grasping forceps, aggressive 2 x 3 teeth and smooth inner jaws, single action, Ø 5 mm, 330 mm



300-401-713

300-431-713

300-441-713

300-461-713

CLAW GRASPER

Grasping forceps, aggressive 2 x 3 teeth and smooth inner jaws, single action, Ø 5 mm, 450 mm

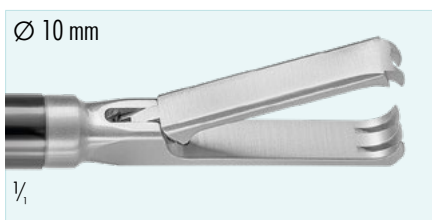

300-400-710*

300-430-710

300-440-710*

300-460-710*

CLAW GRASPER

Grasping forceps, aggressive 2 x 3 teeth and smooth inner jaws, single action, Ø 10 mm, 330 mm



300-400-717

300-430-717

300-440-717

300-460-717

DAVIS

Grasping forceps, blunt interlocking 2 x 3 teeth and long ridged inner jaws, double action, Ø 5 mm, 330 mm



300-400-715

300-430-715





300-440-715

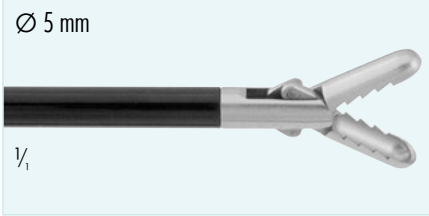
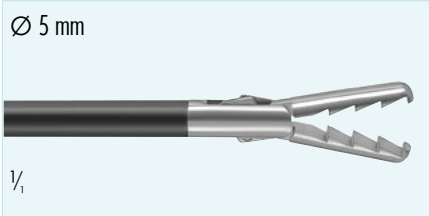
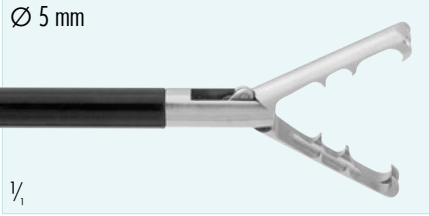
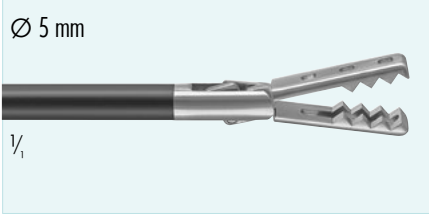
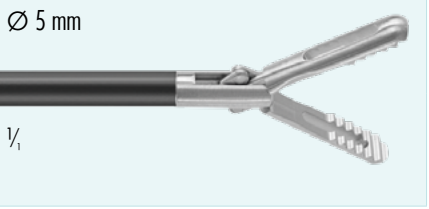

300-460-715

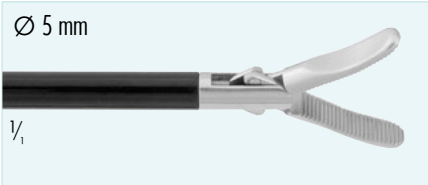
ST. ANDREWS

Grasping forceps, with sharp 2 x 4 teeth and wave shaped inner jaws, double action, Ø 5 mm, 330 mm

	insert only	Complete Instrument with handle 300-750-003	Complete Instrument with handle 300-750-103	Complete Instrument with handle 300-750-105
 <p>Ø 5 mm 1/1</p>	300-400-051	300-430-051	300-440-051	300-460-051
<p>ALLIGATOR SPOON</p> <p>Grasping forceps with cupped jaws, aggressive retrograde lateral teeth, double action, Ø 5 mm, 330 mm</p>				
 <p>Ø 5 mm 1/1</p>	300-400-010*	300-430-010	300-440-010*	300-460-010*
<p>ALLIGATOR</p> <p>Grasping forceps with strong retrograde serrations, double action, Ø 5 mm, 330 mm</p>				
 <p>Ø 5 mm 1/1</p>	300-400-048	300-430-048	300-440-048	300-460-048
<p>SHARK</p> <p>Grasping forceps with very sharp and aggressive lateral retrograde teeth, double action, Ø 5 mm, 330 mm</p>				
 <p>Ø 5 mm 1/1</p>	300-400-018	300-430-018	300-440-018	300-460-018
<p>CLINCH</p> <p>Grasping forceps with strong serration and fenestrated jaws, double action, Ø 5 mm, 330 mm</p>				
 <p>Ø 5 mm 1/1</p>	300-400-049	300-430-049	300-440-049	300-460-049
<p>ENDOCLINCH</p> <p>Grasping forceps, wave-shaped, fenestrated, double action, Ø 5 mm, 330 mm</p>				

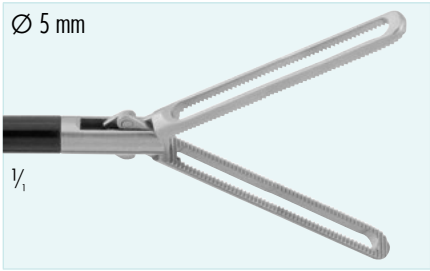
	insert only	Complete Instrument with handle 300-750-003	Complete Instrument with handle 300-750-103
 <p>Ø 5 mm 1/1</p> <p>PIN GRASPER Grasping Forceps with fine 1x2 teeth, smooth inner jaws, double action, Ø 5 mm, 330 mm</p>	300-400-042	300-410-042	300-420-042
 <p>Ø 5 mm 1/1</p> <p>OVARY Grasping forceps with fine serrated, wave shaped jaws, double action, Ø 5 mm, 330 mm</p>	300-400-045	300-410-045	300-420-045
 <p>Ø 5 mm 1/1</p> <p>TUBAL Dissecting and grasping forceps with smooth jaws, double action, Ø 5 mm, 330 mm</p>	300-400-046	300-410-046	300-420-046
 <p>Ø 5 mm 1/1</p> <p>DUCKBILL Grasping and dissecting forceps with flat jaws, fine serrations, double action, Ø 5 mm, 330 mm</p>	300-400-024	300-410-024	300-420-024
 <p>Ø 5 mm 1/1</p> <p>PETITE Micro Grasping Forceps, double action, fenestrated, fine jaw, fine serration</p>	300-400-032	300-410-032	300-420-032
 <p>Ø 5 mm 1/1</p> <p>PETELIN Grasping and Dissecting Forceps with serrated jaws, curved left, single action, Ø 5 mm, 330 mm</p>	300-400-026	300-410-026	300-420-026

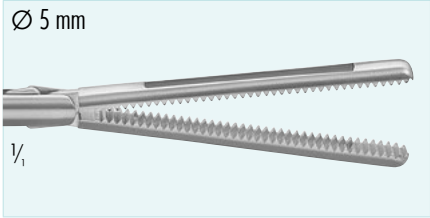
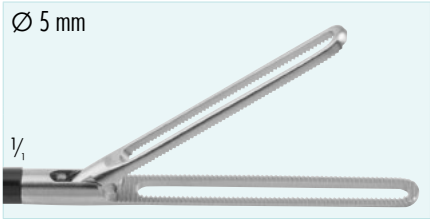
	insert only	Complete Instrument with handle 300-750-003	Complete Instrument with handle 300-750-103	Complete Instrument with handle 300-750-105
 <p>Ø 5 mm 1/1</p> <p>JOHANS Grasping forceps with 20 mm fenestrated jaws, double action, Ø 5 mm, 330 mm</p>	300-400-289*	300-430-289	300-440-289*	300-470-289*
 <p>Ø 5 mm 1/1</p> <p>LONG JOHANS Grasping forceps with 40 mm fenestrated jaws, double action, Ø 5 mm, 330 mm</p>	300-400-291*	300-430-291	300-440-291*	300-470-291*
 <p>Ø 5 mm 1/1</p> <p>DORSEY Grasping forceps with 12 mm fenestrated jaws, double action, Ø 5 mm, 330 mm</p>	300-400-285*	300-430-285	300-440-285*	300-470-285*
 <p>Ø 5 mm 1/1</p> <p>LONG DORSEY Grasping forceps with 45 mm fenestrated jaws, double action, Ø 5 mm, 330 mm</p>	300-400-287	300-430-287	300-440-287	300-470-287
 <p>Ø 5 mm 1/1</p> <p>LONG JOHANS Grasping forceps with 40 mm fenestrated jaws, single action, Ø 5 mm, 330 mm</p>	300-400-288	300-430-288	300-440-288	300-470-288



insert only
300-400-284*

Complete Instrument with handle 300-750-003
300-430-284

Complete Instrument with handle 300-750-103
300-440-284*

Complete Instrument with handle 300-750-105
300-470-284*

JOHANS
Grasping forceps with 20 mm fenestrated jaws, single action, Ø 5 mm, 330 mm

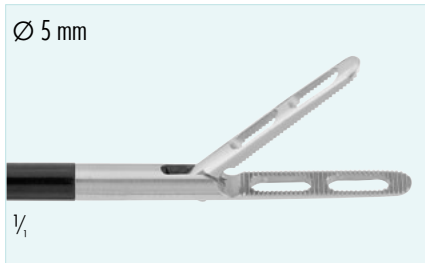

300-400-310*
300-400-312**

300-430-310
300-430-312*

300-440-310*
300-440-312**

300-470-310*
300-470-312**

MARQUES
Grasping forceps with 2 fenestrations, single action, Ø 5 mm, 330 mm
* with 3 fenestrations



300-400-314*

300-430-314

300-440-314*

300-470-314*

MARQUES
Grasping forceps with 2 fenestrations, bent up, single action, Ø 5 mm, 330 mm

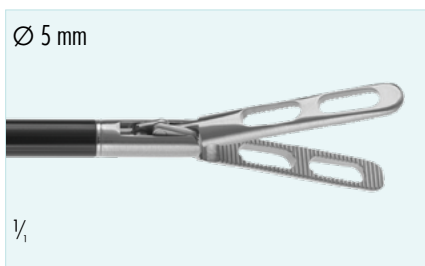

300-400-311
300-400-313*

300-430-311
300-430-313*

300-440-311
300-440-313*

300-470-311
300-470-313*

MARQUES
Grasping forceps with 2 fenestrations, double action, Ø 5 mm, 330 mm
* with 3 fenestrations

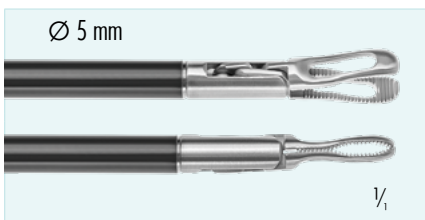







300-400-052*

300-430-052

300-440-052*

300-470-052*

GRASPER
Atraumatic Grasping forceps with fenestrated jaws, fine serrations, double action, Ø 5 mm, 330 mm

<p>Ø 5 mm</p>  <p>1/1</p>	<p>insert only</p>	 <p>Complete Instrument with handle 300-750-001</p>	 <p>Complete Instrument with handle 300-750-101</p>
	<p>300-400-080*</p>	<p>300-410-080</p>	<p>300-420-080*</p>
<p>Biopsy forceps with 2 pinholes, sharp oval cups, double action, Ø 5 mm, 330 mm</p>			
<p>Ø 5 mm</p>  <p>1/1</p>	<p>300-400-082</p>	<p>300-410-082</p>	<p>300-420-082</p>
<p>Biopsy forceps with sharp oval cups, double action, Ø 5 mm, 330 mm</p>			
<p>Ø 5 mm</p>  <p>1/1</p>	<p>300-400-521</p>	<p>300-410-521</p>	<p>300-420-521</p>
<p>Biopsy forceps with 2 pins, sharp oval cups, single action, Ø 5 mm, 330 mm</p>			
<p>Ø 5 mm</p>  <p>1/1</p>	<p>300-400-086</p>	<p>300-410-086</p>	<p>300-420-086</p>
<p>BLAKESLEY Biopsy forceps with sharp cups, single action, Ø 5 mm, 330 mm</p>			
<p>Ø 5 mm</p>  <p>1/1</p>	<p>300-400-100</p>	<p>300-410-100</p>	<p>300-420-100</p>
<p>Hook punch forceps, thru-cutting, single action, Ø 5 mm, 330 mm</p>			

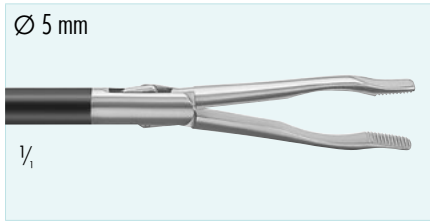

insert only

300-400-250	300-430-250	300-440-250	300-470-250
-------------	-------------	-------------	-------------



BABCOCK PADDLE

Grasping forceps with flat paddles and fine serration for atraumatic grip of delicate tissue, double action, Ø 5 mm, 330 mm

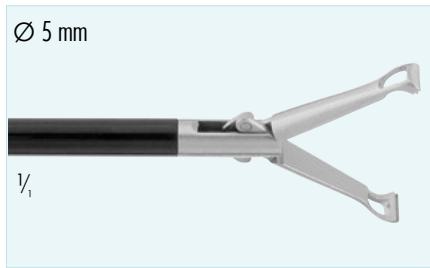

300-400-252*	300-430-252	300-440-252*	300-470-252*
--------------	-------------	--------------	--------------

BABCOCK

Traditional style Babcock grasping forceps, rounded jaws with fine serrations, double action, Ø 5 mm, 330 mm

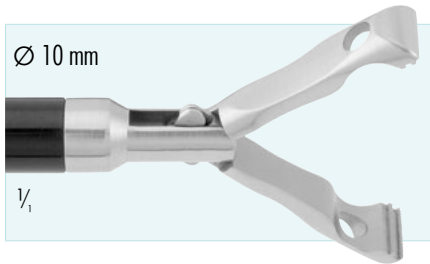

300-400-079	300-430-079	300-440-079	300-470-079
-------------	-------------	-------------	-------------

DEBAKEY BABCOCK

Traditional style Babcock grasping forceps, rounded jaws with atraumatic DeBaKey serration, double action, Ø 10 mm, 330 mm

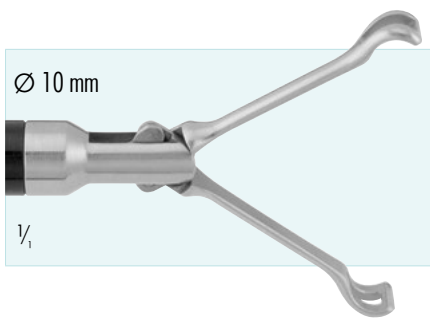

300-400-078*	300-430-078	300-440-078*	300-470-078*
--------------	-------------	--------------	--------------

BABCOCK

Traditional style Babcock grasping forceps with medium jaws, rounded jaws with fine serrations, double action, Ø 10 mm, 330 mm

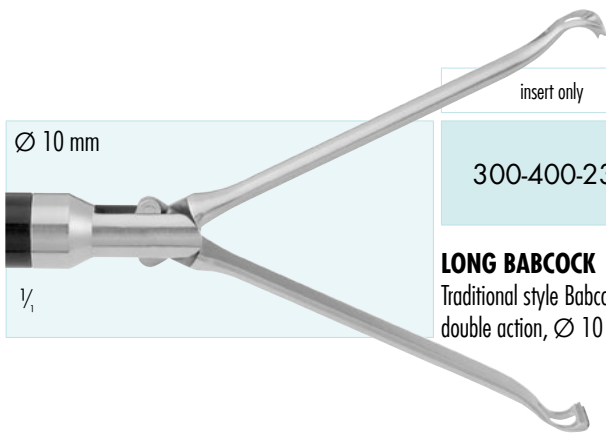

insert only
300-400-234

Complete Instrument
with handle 300-750-003
300-430-234

Complete Instrument
with handle 300-750-103
300-440-234

Complete Instrument
with handle 300-750-105
300-470-234

LONG BABCOCK

Traditional style Babcock grasping forceps with long jaws, rounded jaws with fine serrations, double action, ∅ 10 mm, 330 mm

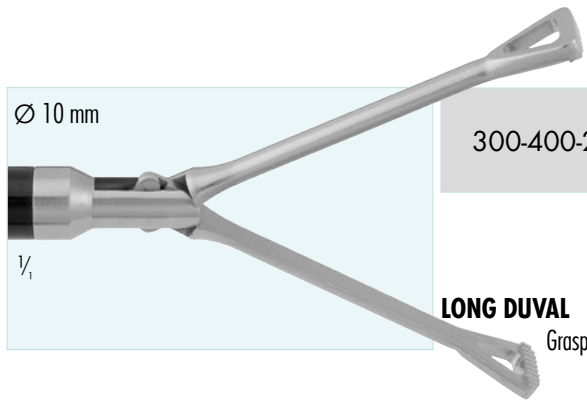

300-400-280

300-430-280

300-440-280

300-470-280

LONG DUVAL

Grasping forceps with long jaws, V-shaped tip with fine serrations, double action, ∅ 10 mm, 330 mm

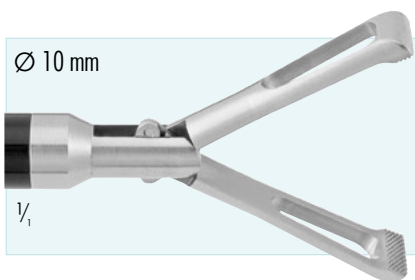

300-400-084





300-430-084

300-440-084

300-470-084

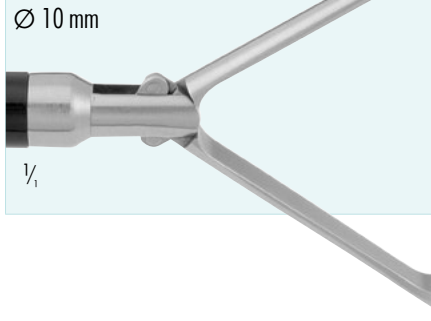
COLLIN-DUVAL



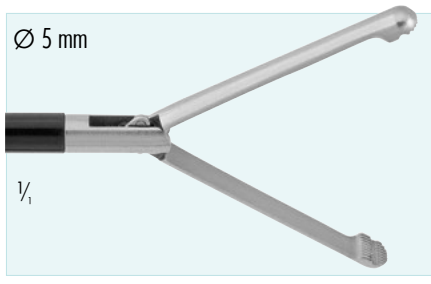

Grasping forceps, V-shaped tip with fine serrations on the tip, double action, ∅ 10 mm, 330 mm

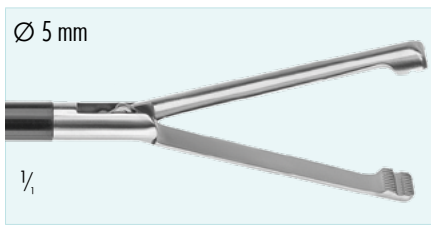
 <p>Ø 10 mm</p> <p>1/1</p>	insert only	 <p>Complete Instrument with handle 300-750-003</p>	 <p>Complete Instrument with handle 300-750-103</p>	 <p>Complete Instrument with handle 300-750-105</p>
	300-400-074	300-430-074	300-440-074	300-470-074
	<p>ALLIS Traditional Allis grasping forceps, with fine serrations on the tip, double action, Ø 10 mm, 330 mm</p>			

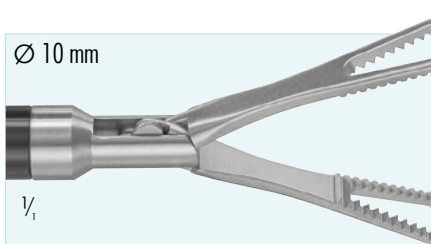
 <p>Ø 5 mm</p> <p>1/1</p>	300-400-097	300-430-097	300-440-097	300-470-097
	<p>SLIM ALLIS Grasping forceps with delicate jaws and with fine serrations on the tip, double action, Ø 5 mm, 330 mm</p>			

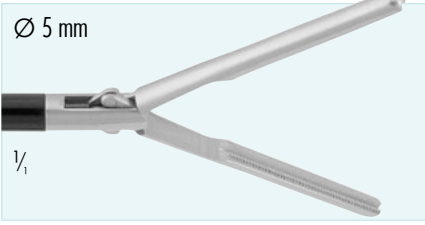
 <p>Ø 5 mm</p> <p>1/1</p>	300-400-197	300-430-197	300-440-197	300-470-197
	<p>ALLIS Bowell grasping forceps, 4 mm x 35 mm, double action, Ø 5 mm, 330 mm</p>			

 <p>Ø 10 mm</p> <p>1/1</p>	300-400-085*	300-430-085	300-440-085*	300-470-085*
	<p>COLLIN Grasping forceps, V-shaped tip with deep serrations for firm grip, double action, Ø 10 mm, 330 mm</p>			

 <p>Ø 5 mm 1/1</p>	insert only	 <p>Complete Instrument with handle 300-750-003</p>	 <p>Complete Instrument with handle 300-750-103</p>	 <p>Complete Instrument with handle 300-750-105</p>
	300-400-243	300-430-243	300-440-243	300-460-243

DEBAKEY

Pick-up forceps with fine 22 mm long atraumatic serrations, 38 mm jaws, double action, Ø 5 mm, 330 mm

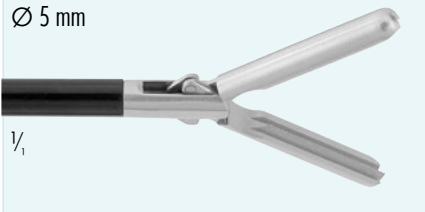
 <p>Ø 5 mm 1/1</p>	300-400-244	300-430-244	300-440-244	300-460-244
	<p>DEBAKEY Atraumatic grasping forceps, fine atraumatic serrations, double action, 25 mm jaws, Ø 5 mm, 330 mm</p>			

 <p>Ø 5 mm 1/1</p>	300-400-245	300-430-245	300-440-245	300-460-245
	<p>DEBAKEY Atraumatic grasping forceps, fine atraumatic serrations, double action, 40 mm jaws, Ø 5 mm, 330 mm</p>			

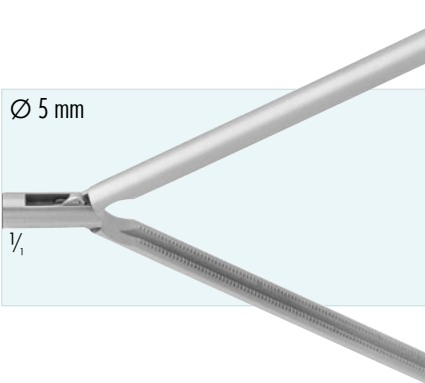
 <p>Ø 5 mm 1/1</p>	300-400-246	300-430-246	300-440-246	300-460-246
	<p>DEBAKEY Atraumatic grasping forceps, fine atraumatic serrations, double action, 60 mm jaws, Ø 5 mm, 330 mm</p>			

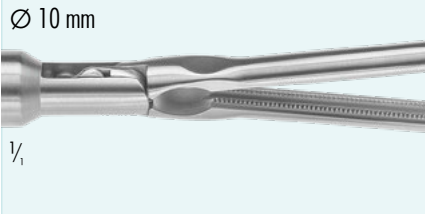
 <p>Ø 10 mm 1/1</p>	300-400-275	300-430-275	300-440-275	300-460-275
	<p>KOCHER Bowell forceps, 40 mm long longitudinal serrated jaws, Ø 10 mm, 330 mm</p>			

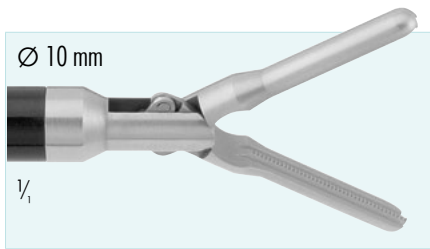

insert only
300-400-263

Complete Instrument with handle 300-750-003
300-430-263

Complete Instrument with handle 300-750-103
300-440-263

Complete Instrument with handle 300-750-105
300-460-263

DEBAKEY
Atraumatic grasping forceps, fine atraumatic serrations, double action, 25 mm jaws, Ø 10 mm, 330 mm

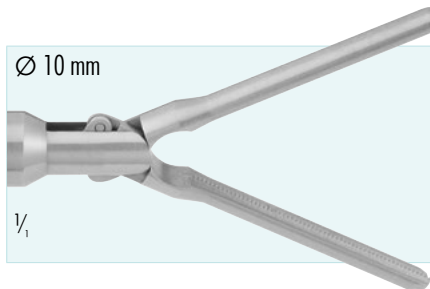

300-400-264

300-430-264

300-440-264

300-460-264

DEBAKEY
Atraumatic grasping forceps, fine atraumatic serrations, double action, 40 mm jaws, Ø 10 mm, 330 mm

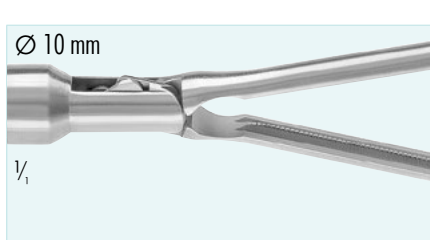

300-400-266

300-430-266

300-440-266

300-460-266

DEBAKEY
Atraumatic grasping forceps, fine atraumatic serrations, double action, 60 mm jaws, Ø 10 mm, 330 mm

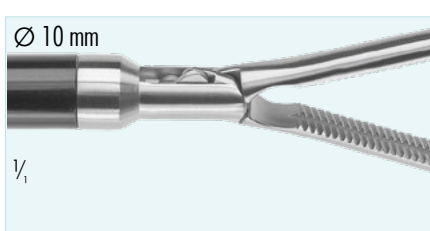

300-400-274

300-430-274

300-440-274

300-460-274

GLASSMAN
Grasping forceps, atraumatic serrations, double action, Ø 10 mm, 330 mm



300-400-276

300-430-276

300-440-276

300-460-276

GLASSMAN
Grasping forceps with oblique, parallel serrations, double action, 60 mm jaws, Ø 10 mm, 330 mm

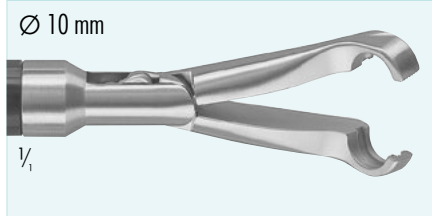

insert only

300-400-295



300-430-295

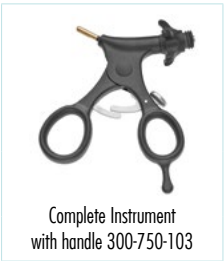

300-440-295

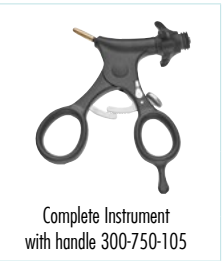

300-460-295

ANVIL
Grasping forceps with specially shaped jaws to grasp and hold the anvil of a circular stapler, double action, Ø 10 mm, 330 mm



300-400-286

300-430-286

300-440-286

300-460-286

DORSEY
Grasping forceps, fenestrated jaws with medium serrations, double action, Ø 10 mm, 330 mm

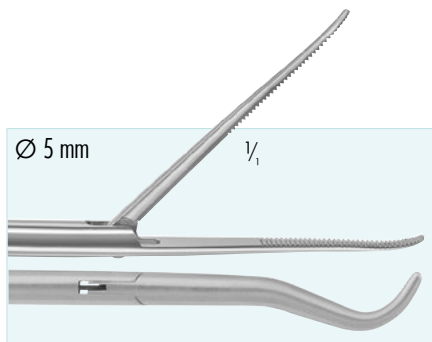

300-400-030

300-430-030

300-440-030

300-460-030

GEEGEE
Dissecting and grasping forceps with fine jaws, strongly curved and fine serrations, single action, Ø 5 mm, 330 mm

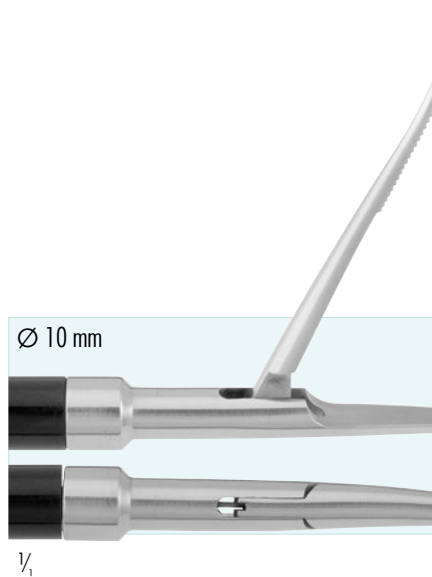

300-400-076

300-430-076

300-440-076

300-460-076

GEEGEE
Dissector and grasping forceps with fine jaws, strongly curved and fine serration, single action, Ø 10 mm, 330 mm

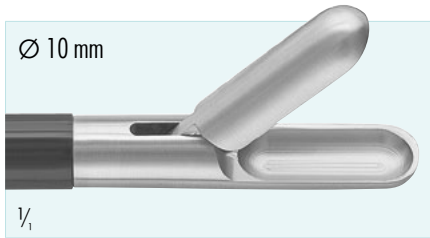

insert only
300-400-720*

Complete Instrument
with handle 300-750-003
300-430-720

Complete Instrument
with handle 300-750-103
300-440-720*

Complete Instrument
with handle 300-750-105
300-460-720*

SPOON

Forceps with sharp, cup-shaped jaws for tissue or stone removal, **single action**, Ø 10 mm, 330 mm

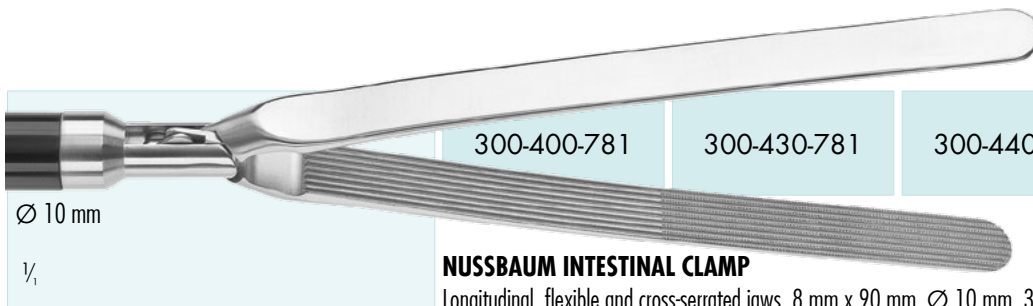

300-400-781

300-430-781

300-440-781

300-460-781

NUSSBAUM INTESTINAL CLAMP

Longitudinal, flexible and cross-serrated jaws, 8 mm x 90 mm, Ø 10 mm, 330 mm

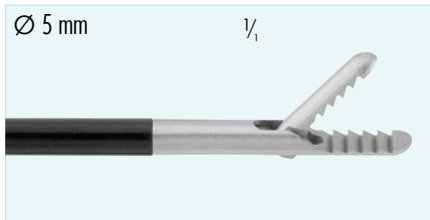

300-400-700

300-430-700

300-440-700

300-460-700

RETROGRADE

Grasping and extracting forceps with deep retrograde serration for a secure grip of tissue, **single action**, Ø 5 mm, 330 mm

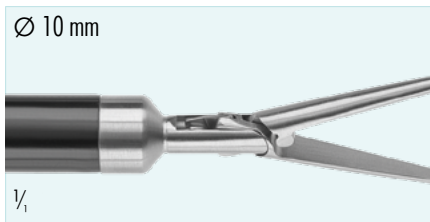

300-400-753*

300-430-753

300-440-753*

300-460-753*

TENACULUM FORCEPS

35mm long jaws, **double action**, Ø 10 mm, 330 mm

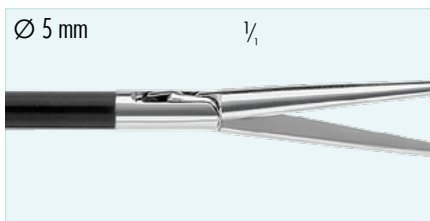

300-400-751*

300-430-751

300-440-751*

300-460-751*

TENACULUM FORCEPS

35mm long jaws, **double action**, Ø 5 mm, 330 mm



Complete Instrument
with handle 300-750-015

insert only

Ø 5 mm

300-400-200*

300-490-200

1/1

SATINSKY

Grasping Forceps, 50 mm atraumatic jaws, Ø 5 mm, 330 mm

Ø 5 mm

300-400-202

300-490-202

1/1

SATINSKY

Grasping Forceps, 40 mm atraumatic jaws, Ø 5 mm, 330 mm

Ø 5 mm



300-400-206

300-490-206

1/1

CRAFOORD

Thorax clamp, 50 mm atraumatic jaws, Ø 5 mm, 330 mm

 <p>Ø 5 mm</p> <p>1/1</p>	<p>insert only</p> <p>300-400-204</p>	 <p>Complete Instrument with handle 300-750-015</p> <p>300-490-204</p>
	<p>CRAFOORD Thorax clamp, 35 mm atraumatic jaws, Ø 5 mm, 330 mm</p>	

 <p>Ø 5 mm</p> <p>1/1</p>	<p>300-400-220*</p>	<p>300-490-220</p>
	<p>DEBAKEY Pulmonary atraumatic Clamp, curved shape, Ø 5 mm, 330 mm</p>	

 <p>Ø 5 mm</p> <p>1/1</p>	<p>300-400-221</p>	<p>300-490-221</p>
	<p>DEBAKEY Pulmonary atraumatic Clamp, s-shaped, Ø 5 mm, 330 mm</p>	

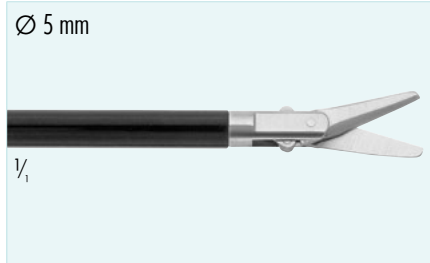

insert only

300-400-067*



300-410-067



300-420-067*

ORIGINAL METZENBAUM

Scissors, short blades (12 mm), slightly curved, double action, Ø 5 mm, 330 mm

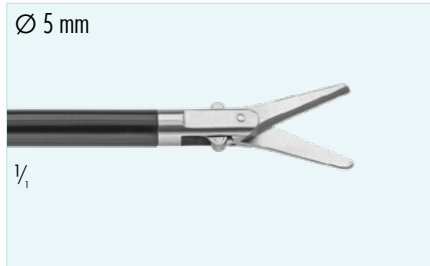

300-400-069*

300-410-069

300-420-069*

METZENBAUM

Scissors, short blades (12 mm), straight, double action, Ø 5 mm, 330 mm

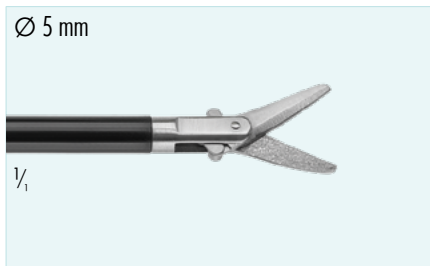

300-400-172

300-410-172

300-420-172

METZENBAUM

Scissors, short, with **Diamond Dusted** blades (12 mm), curved, double action, Ø 5 mm, 330 mm

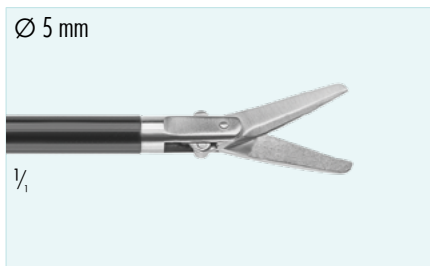

300-400-168

300-410-168

300-420-168

METZENBAUM

Scissors, medium, with **Diamond Dusted** blades (15 mm), straight, double action, Ø 5 mm, 330 mm

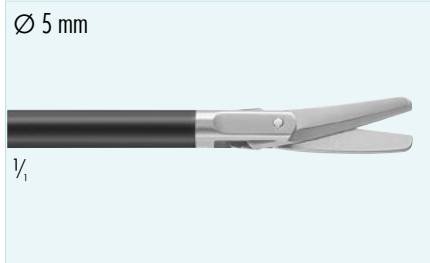

insert only

300-400-072*



300-410-072



300-420-072*

METZENBAUM

Scissors, medium blades (15 mm), slightly curved, double action, Ø 5 mm, 330 mm

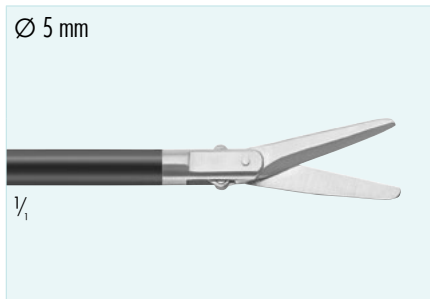

300-400-070*

300-410-070

300-420-070*

METZENBAUM

Scissors, long blades (18 mm), slightly curved, double action, Ø 5 mm, 330 mm

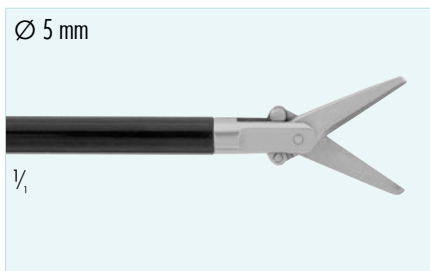

300-400-068*

300-410-068

300-420-068*

METZENBAUM

Scissors, medium blades (15 mm), straight, double action, Ø 5 mm, 330 mm

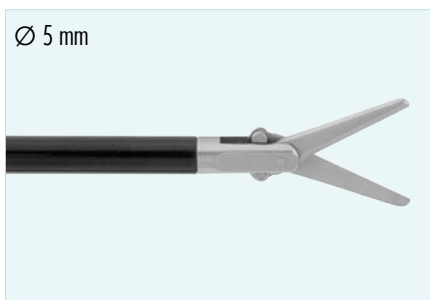

300-400-071

300-410-071

300-420-071

METZENBAUM

Scissors, long blades (18 mm), straight, double action, Ø 5 mm, 330 mm

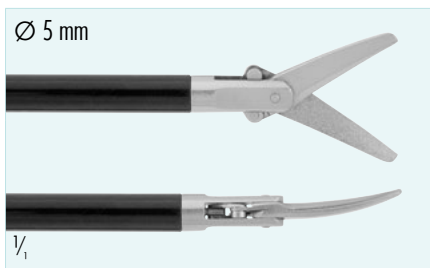

300-400-169

300-410-169

300-420-169

METZENBAUM

Scissors, medium blades (15 mm) coated with **Diamond Dust**, slightly curved, double action, Ø 5 mm, 330 mm, **DD-Coating** gives the scissors' blades a more durable cutting performance.

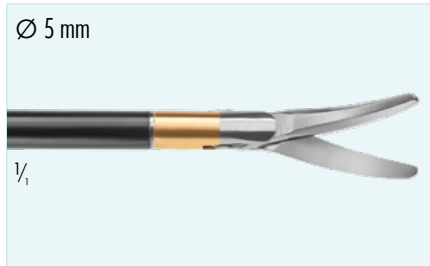

insert only

300-400-170



300-410-170



300-420-170

TC METZENBAUM

Scissors, long blades (18 mm) with **Tungsten Carbide** inserts, strong curved, double action, Ø 5 mm, 330 mm

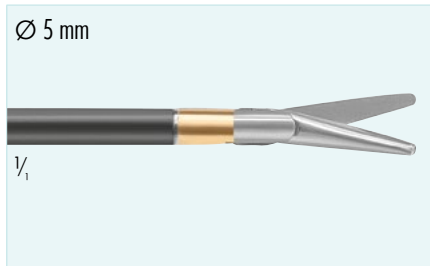

300-400-171

300-410-171

300-420-171

TC METZENBAUM

Scissors, short blades (12 mm) with **Tungsten Carbide** inserts, slight curved, double action, Ø 5 mm, 330 mm



300-400-180

300-410-180

300-420-180

HINGELESS TC METZENBAUM

Scissors, long blades (18 mm), curved, double action, Ø 5 mm, 330 mm, with **Tungsten Carbide** inserts
For use with shaft 300-660-015 only

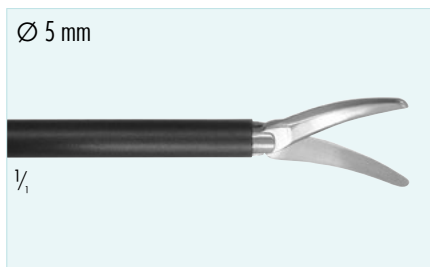

300-400-181

300-410-181

300-420-181

HINGELESS TC METZENBAUM

Scissors, short blades (12 mm), curved, double action, Ø 5 mm, 330 mm, with **Tungsten Carbide** inserts
For use with shaft 300-660-015 only



insert only

300-400-072CC



300-410-072CC

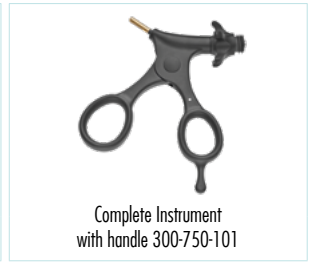

300-420-072CC

METZENBAUM CERA CUT®

Scissors, medium blades (15 mm) slightly curved, double action, Ø 5 mm, 330 mm

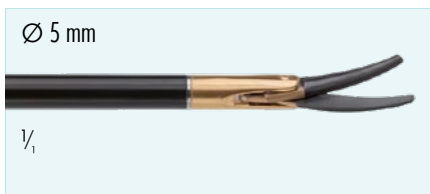

300-400-170CC

300-410-170CC

300-420-170CC

METZENBAUM TC CERA CUT®

TC Scissors, medium blades (16 mm), curved, double action, Ø 5 mm, 330 mm

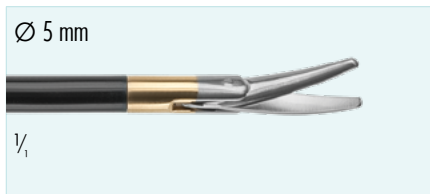

300-400-173

300-410-173

300-420-173

METZENBAUM TC

TC Scissors, medium blades (15 mm), curved, double action, Ø 5 mm, 330 mm



300-400-065

300-410-064

300-420-064

METZENBAUM

Scissors, bow shape curved, 16mm blades, fine serrated, double action, Ø 5 mm, 330 mm



300-400-165*

300-410-165

300-420-165*

METZENBAUM TC

TC Scissors, bow shape curved, 16mm blades, fine serrated, double action, Ø 5 mm, 330 mm



300-400-056

300-410-056

300-420-056

METZENBAUM

Scissors, slightly curved, double action, Ø 10 mm, 330 mm

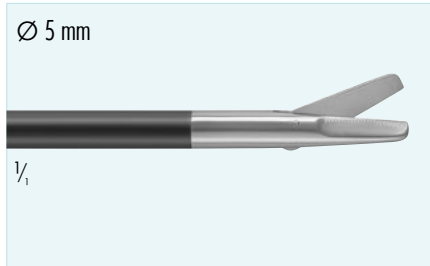

insert only

300-400-063



300-410-063

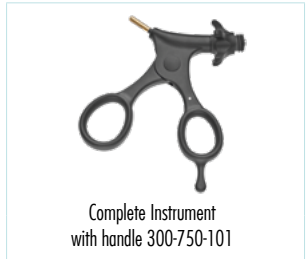

300-420-063

PERITONEAL

Scissors, delicate with fine serrated blades, straight, single action, Ø 5 mm, 330 mm



300-400-060*

300-410-060

300-420-060*

HOOK

Scissors with round cutting blades, single action, Ø 5 mm, 330 mm



300-400-062

300-410-062

300-420-062

HOOK

Scissors with round cutting blades, fine serrated lower blade, single action, Ø 5 mm, 330 mm

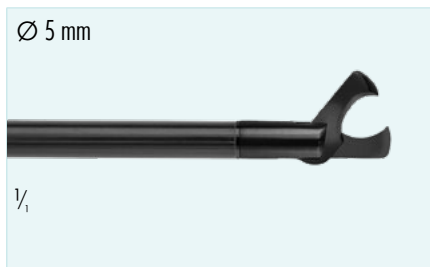

300-400-060CC

300-410-060CC

300-420-060CC

HOOK CERA CUT®

Scissors with round cutting blades, single action, Ø 5 mm, 330 mm

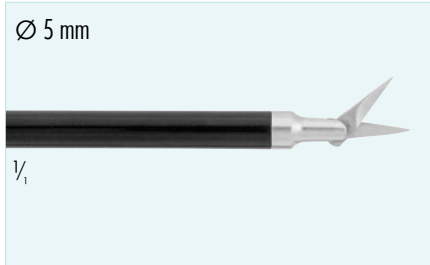

insert only

300-400-570



300-410-570



300-420-570

MICRO

Scissors with straight sharp blades, single action, Ø 5 mm, 330 mm

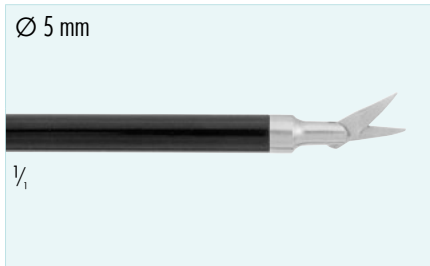

300-400-571

300-410-571

300-420-571

MICRO

Scissors with curved sharp blades, single action, Ø 5 mm, 330 mm

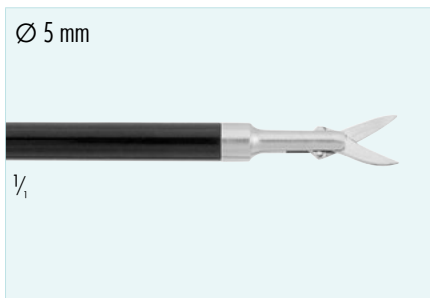

300-400-572

300-410-572

300-420-572

MICRO

Scissors with curved sharp blades, double action, Ø 5 mm, 330 mm



4-PIECE ENDO TIP SYSTEM

- Reusable handle and shaft, disposable tip
- Always having a sharp tip
- Ecological and economical - reduces waste and saves budget

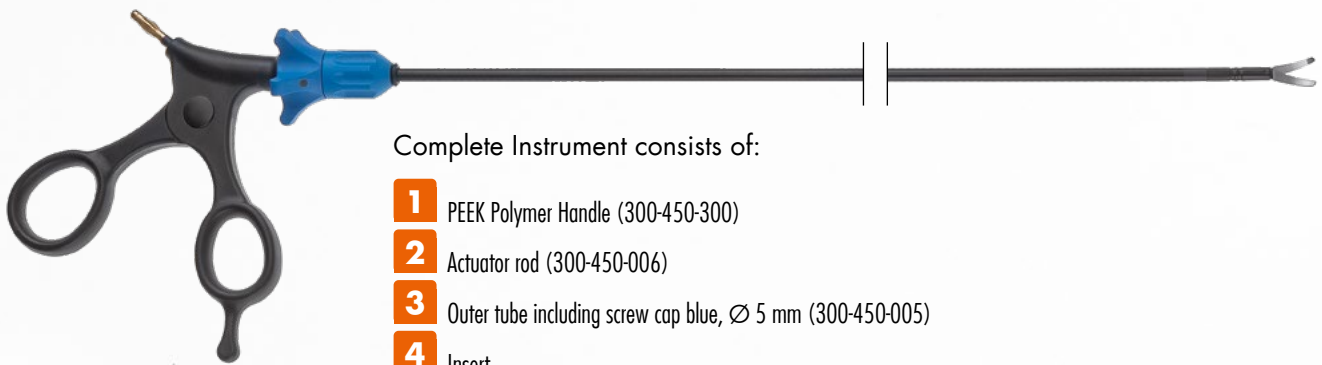

Complete Instrument consists of:

- 1** PEEK Polymer Handle (300-450-300)
- 2** Actuator rod (300-450-006)
- 3** Outer tube including screw cap blue, \varnothing 5 mm (300-450-005)
- 4** Insert

1 PEEK POLYMER HANDLES



300-450-300 PEEK Polymer Handle, blue rotating wheel, without ratchet

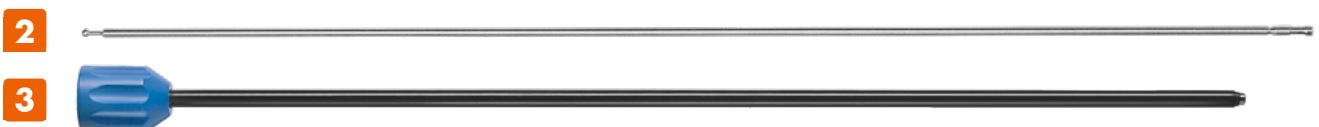



The EndoTip system allows to reuse the handle and the sheath of the Instrument, but gives the opportunity to easily change the tip. That provides an always sharp scissors without creating the waste of a complete single use instrument.

4



METZENBAUM non-sterile, limited reusable
 300-450-177 medium, 15mm curved
 300-450-171 short, 10mm, curved
 300-450-173 long, 18 mm, curved
 300-450-174 long, 18 mm, straight
 300-450-176 medium, 15mm, straight



JOHANS Grasper, fenestrated
 300-450-289 non-sterile (limited reusable)



MARYLAND Grasper, curved
 300-450-731 non-sterile (limited reusable)



METZENBAUM sterile, single use
 300-450-177S medium, 15mm curved



ENDOCLINCH Grasper, fenestrated
 300-450-049 non-sterile (limited reusable)

CHOLANGIOGRAPHY SYSTEM



300-100-760 Cholangiography fixation clamp with channel for 6 Fr. catheters,
 Ø 5 mm, 330 mm working length, with ratchet and LuerLock, double action jaws

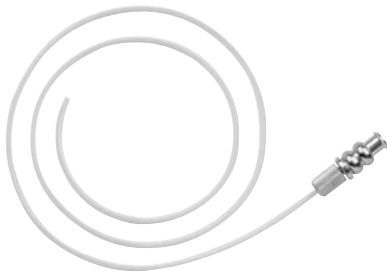

300-100-641 Cholangiography catheter, 6 Fr., for use with Cholangiography fixation clamp



300-011-500 2-way stop cock with 2 valves and LuerLock connector for use
 with flexible tube 300-011-501 for contrast solution



300-011-501 Flexible tube with 2 LuerLock connectors



300-193-330 Guide tube for Cholangiography catheter,
 Ø 5 mm, 330 mm working length



RZ FAN RETRACTORS

- One-piece instrument with flush port
- 50° vertical adjustment
- Available in Ø 5mm and 10mm

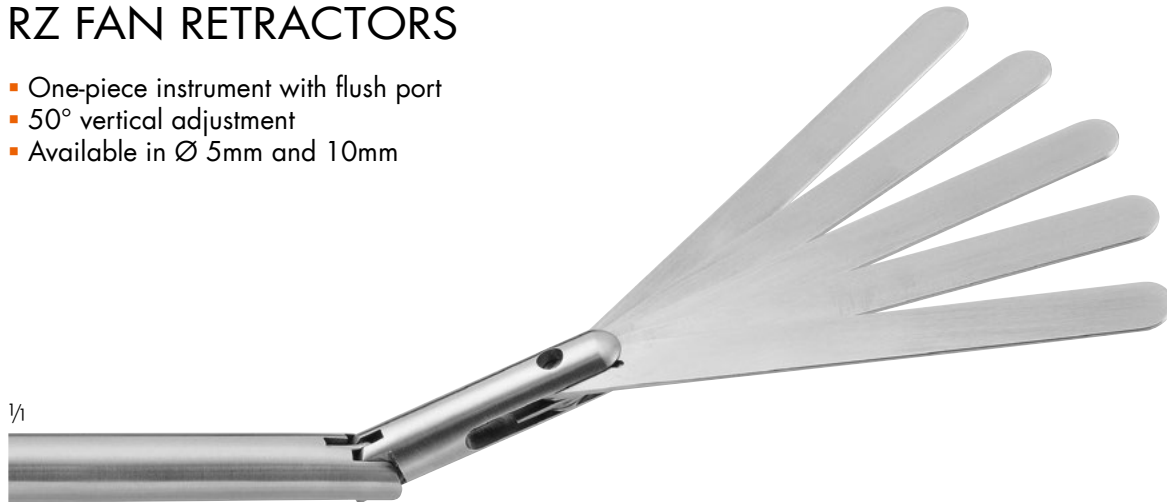

1/1



- RZ Fan Retractor, 330mm working length
- 300-065-000* 10 mm, with 5 prongs
 - 300-063-000* 5 mm, with 3 prongs



- Esophagus Retractor with cleaning port, vertical up 90°, with distal hole
- 300-099-033 5 mm, 330 mm working length
 - 300-099-100 5 mm, 440 mm working length
 - 300-099-133 10 mm, 330 mm working length
 - 300-099-140 10 mm, 440 mm working length



- 300-065-100 Advanced Fan Retractor, 10 mm, 5 prongs,
angulation: max. 80°, spread: max. 60°, length: 330 mm

ARTICULATING LAPAROSCOPIC RETRACTORS & BAND-PASSER

- 5mm shaft
- For use with 5.0 or 5.5mm trocars
- With LuerLock



Carbon handle with overload protection



Atraumatic segments, jamming is prevented



The nitinol wire straightens the working end to allow easy introduction and extraction

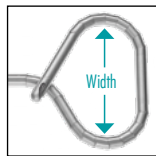

TRIANGULAR

Straight	Width	Working length	
	60mm	330mm	300-069-000*
	60mm	450mm	300-069-450
	80mm	330mm	300-070-000*
	80mm	450mm	300-070-450

30° angled	Width	Working length	
	60mm	330mm	300-072-000*
	60mm	450mm	300-072-450
	80mm	330mm	300-073-000*
	80mm	450mm	300-073-450*

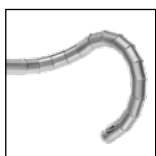

HOOK

90° upwards	Shape	Working length	
	Curved right	340mm	300-075-001
	Curved left	340mm	300-075-002

45° angled	Shape	Working length	
	Curved right	340mm	300-075-101
	Curved left	340mm	300-075-102

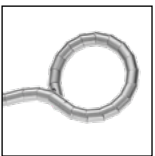

CIRCLE

	Width	Working length	
Straight	40mm	340mm	300-076-001
Angled	40mm	340mm	300-076-101

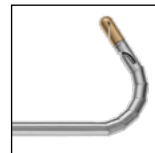

BAND-PASSER

Working length	
330mm	300-071-000*
450mm	300-071-450*



J-RETRACTOR

Working length	
340mm	300-077-000

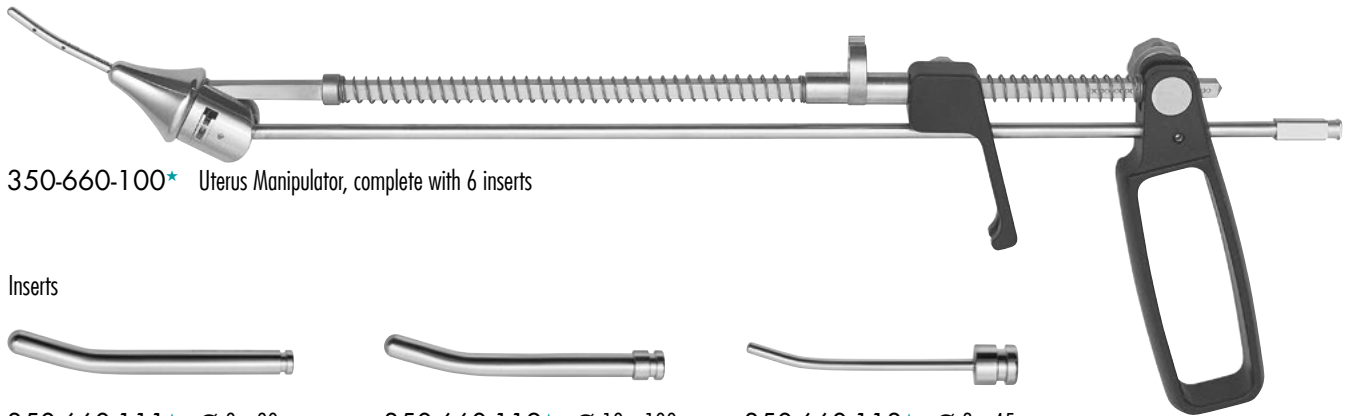

350-660-100* Uterus Manipulator, complete with 6 inserts

Inserts



350-660-111* Ø 8 x 80 mm



350-660-112* Ø 10 x 100 mm



350-660-113* Ø 3 x 45 mm



350-660-114* Ø 3 x 55 mm



350-660-115* Ø 3.2 x 35 mm



350-660-116* Ø 3.2 x 45 mm



COHEN

Self retaining Cannula complete with 2 interchangeable acorns

350-750-000*

Acorn only

350-750-002 large

350-750-001 small

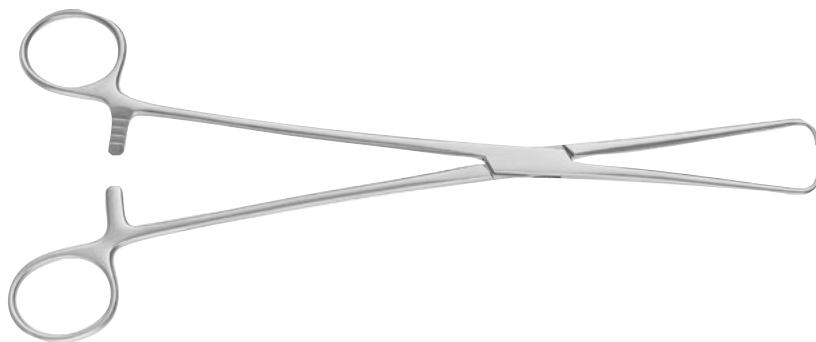

350-400-250* **SCHROEDER** tenaculum forceps



Myoma screw

300-032-015* Ø 5mm, 330mm working length

300-042-005 Ø 5mm, 420mm working length

300-033-010 Ø 10mm, 330mm working length

300-042-010 Ø 10mm, 420mm working length

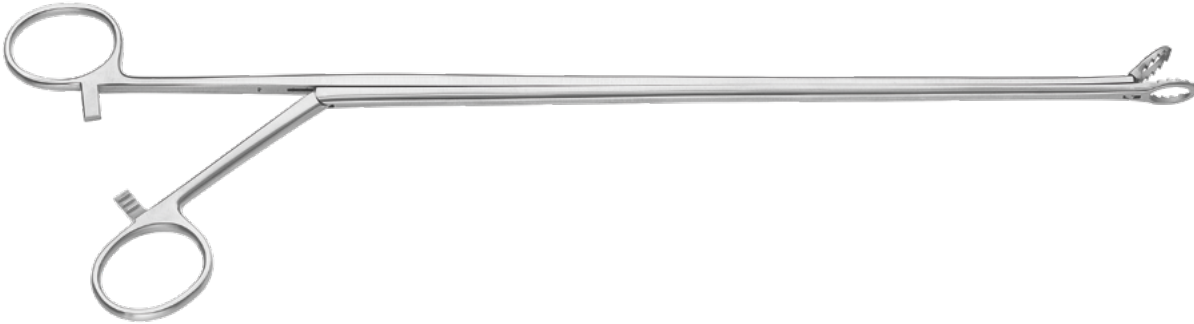

RZ Myoma Grasping Forceps, 330 mm working length

350-755-007 7 mm jaws

350-755-011* 11 mm jaws

350-755-017 17 mm jaws

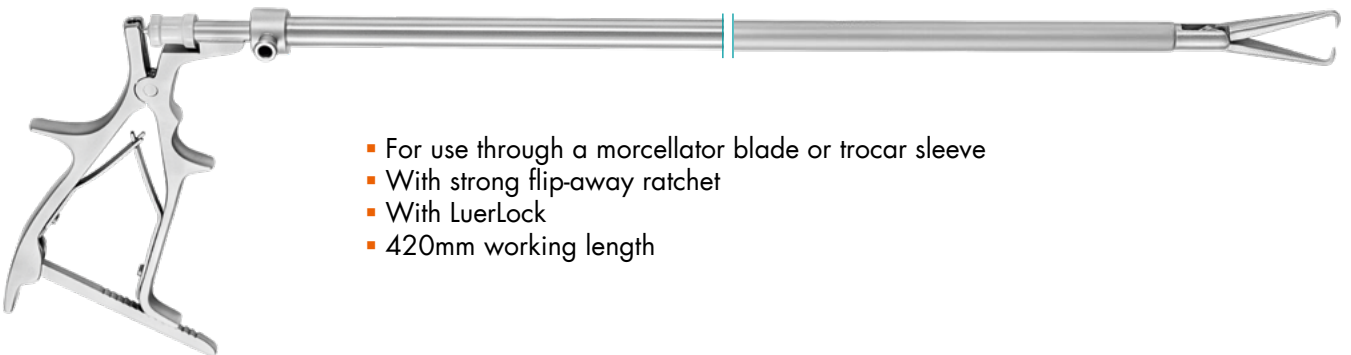

- For use through a morcellator blade or trocar sleeve
- With strong flip-away ratchet
- With LuerLock
- 420mm working length



300-110-714
Tenaculum Forceps, Ø10mm



300-110-711
Claw Forceps, Ø10mm



300-110-715
Tenaculum Forceps, Ø5mm



300-110-712
Claw Forceps, Ø5mm

RZ RING APPLICATORS

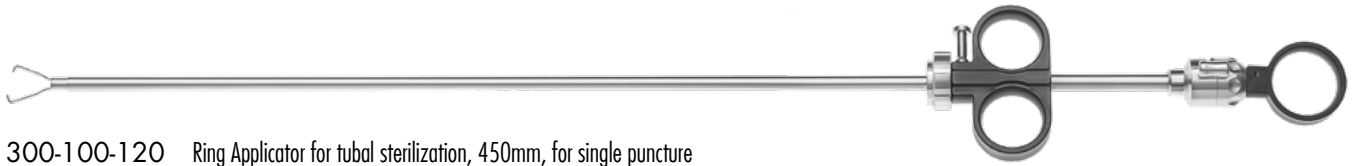

300-100-120 Ring Applicator for tubal sterilization, 450mm, for single puncture for use with Operating Laparoscopes with \varnothing 6mm instrument channels (300-099-006 and 300-099-106).
A knurled screw is fixing the Ring Applicator securely to the telescope

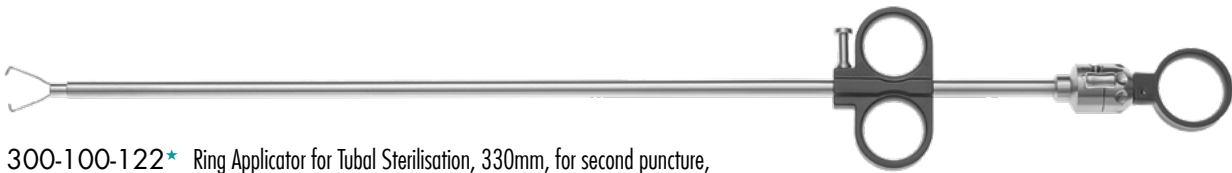

300-100-122* Ring Applicator for Tubal Sterilisation, 330mm, for second puncture, for use with Trocar sleeves \varnothing 7.0mm



300-100-125 Cone for Ring Applicator



300-100-127 Loading Device for Ring Applicator



Plastic Rings
300-100-126 sterile package of 2 pieces

CLIP APPLYING BULLDOG CLAMPS NEEDLE HOLDERS



ENDOSCOPIC CLIP APPLYING FORCEPS - TITAN CLIPS

- 360° rotatable
- Color-coded
- Detachable and non-detachable models



TYPE ETHICON, TITANIUM

Size / color code	detachable, 330mm	A insert only, 330mm	B shaft only
S (blue) ■	300-810-001	300-810-101	300-830-010
M (white) □	300-810-002	300-810-102	300-830-010
M/L (green) ■	300-810-004*	300-810-104	300-830-010
L (yellow) ■	300-810-006*	300-810-106	300-830-010

Size / color code	detachable, 450mm	A insert only, 450mm	B shaft only
S (blue) ■	300-810-401	300-810-501	300-830-410
M (white) □	300-810-402	300-810-502	300-830-410
M/L (green) ■	300-810-404	300-810-504	300-830-410
L (yellow) ■	300-810-406	300-810-506	300-830-410



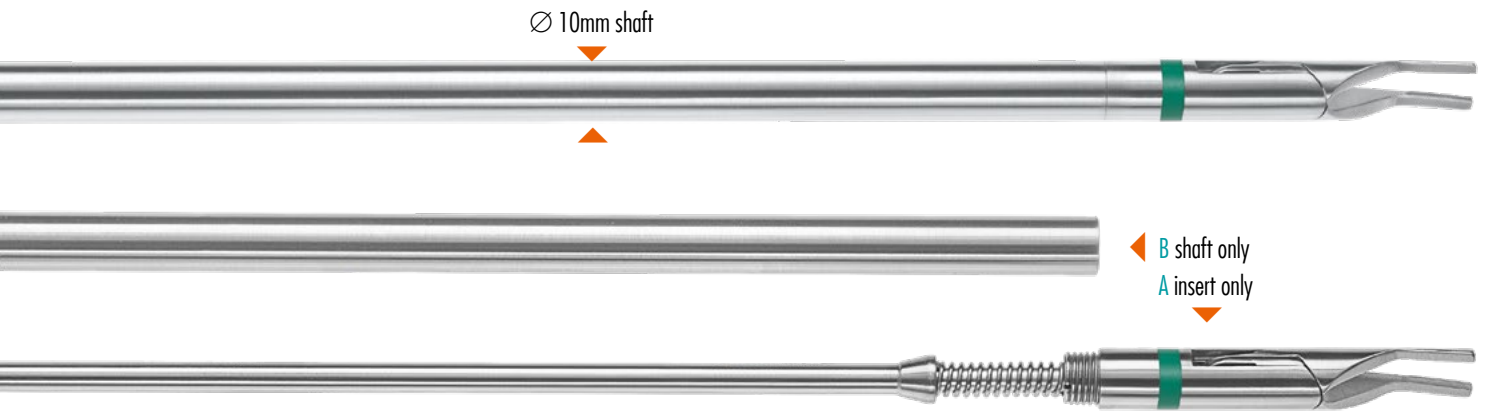

Size / color code	non detachable, 330mm	non detachable, 450mm
S (blue) ■	300-800-001	300-800-401
M (white) □	300-800-002	300-800-402
M/L (green) ■	300-800-004*	300-800-404
L (yellow) ■	300-800-006*	300-800-406



TYPE HORIZON, TITANIUM





Titan Clips,
Ethicon and
Horizon type

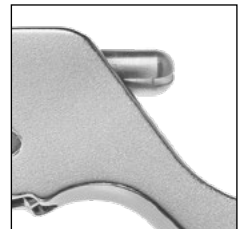

Size / color code	detachable, 330mm	A insert only, 330mm	B shaft only
S (yellow) 	300-810-011	300-810-111	300-830-010
M (blue) 	300-810-012	300-810-112	300-830-010
M/L (green) 	300-810-014	300-810-114	300-830-010
L (orange) 	300-810-016	300-810-116	300-830-010





Detachable Forceps
without LuerLock

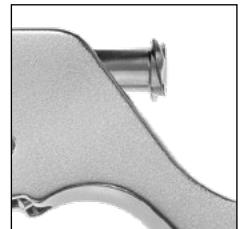

Size / color code	detachable, 450mm	A insert only, 450mm	B shaft only
S (yellow) 	300-810-411	300-810-511	300-830-410
M (blue) 	300-810-412	300-810-512	300-830-410
M/L (green) 	300-810-414	300-810-514	300-830-410
L (orange) 	300-810-416	300-810-516	300-830-410

Non-detachable Forceps
with LuerLock



Size / color code	non detachable, 330mm	non detachable, 450mm
S (yellow) 	300-800-011	300-800-411
M (blue) 	300-800-012	300-800-412
M/L (green) 	300-800-014	300-800-414
L (orange) 	300-800-016	300-800-416

ENDOSCOPIC CLIP APPLYING FORCEPS - POLYMER CLIPS

- 360° rotatable
- Color-coded
- Detachable and non-detachable models

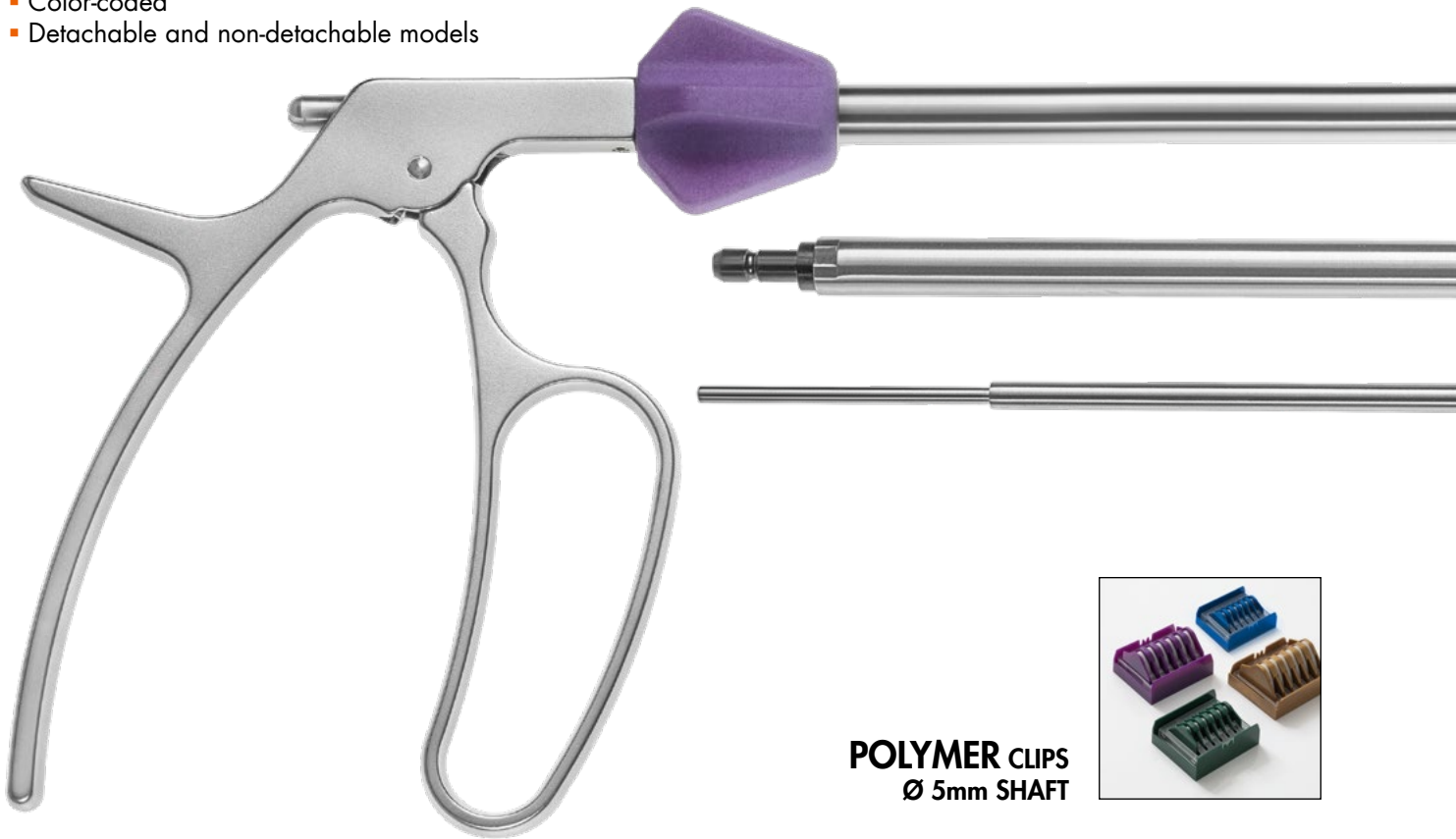

POLYMER CLIPS Ø 5mm SHAFT



Size / color code	detachable, 330mm	A insert only, 330mm	B shaft only
M (blue) ■	300-830-051	300-830-151	300-830-005
M/L (green) ■	300-830-052	300-830-152	300-830-005

Ø 10mm SHAFT

Size / color code	detachable, 330mm	A insert only, 330mm	B shaft only
L (purple) ■	300-830-013	300-830-113	300-830-010
XL (yellow) ■	300-830-014	300-830-114	300-830-010

Ø 5mm SHAFT

Size / color code	detachable, 450mm	A insert only, 450mm	B shaft only
M (blue) ■	300-830-451	300-830-551	300-830-405
M/L (green) ■	300-830-452	300-830-552	300-830-405

Ø 10mm SHAFT

Size / color code	detachable, 450mm	A insert only, 450mm	B shaft only
L (purple) ■	300-830-413	300-830-513	300-830-410
XL (yellow) ■	300-830-414	300-830-514	300-830-410

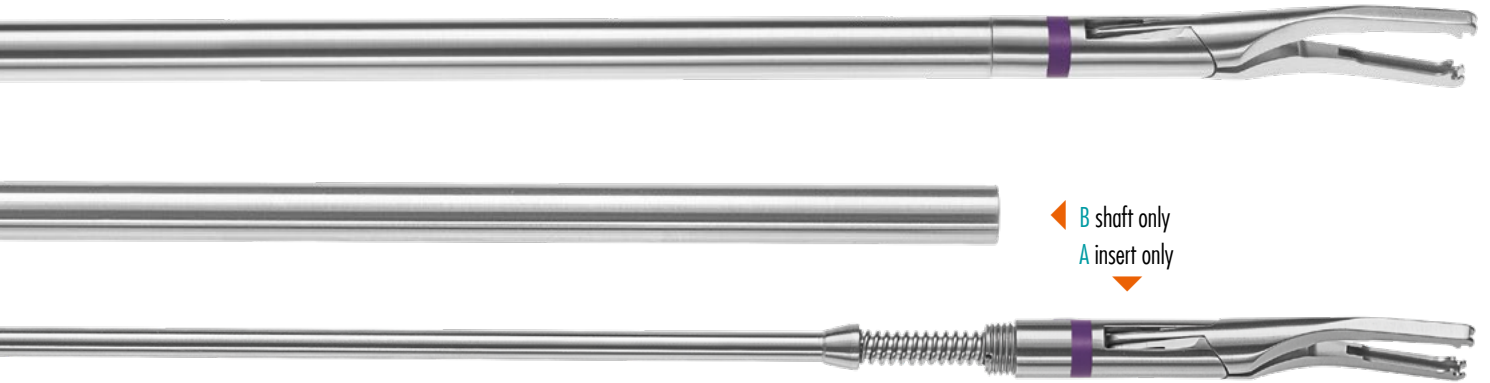

Ø 5mm SHAFT

Size / color code	non-detachable, 330mm	non-detachable, 450mm
M (blue) ■	300-820-051	300-820-451
M/L (green) ■	300-820-052*	300-820-452*

Ø 10mm SHAFT

Size / color code	non-detachable, 330mm	non-detachable, 450mm
L (purple) ■	300-820-013*	300-820-413*
XL (yellow) ■	300-820-014*	300-820-414*

Polymer Clips
Applying Forceps



Detachable Forceps
without LuerLock

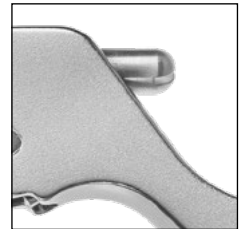

Non-detachable Forceps
with LuerLock

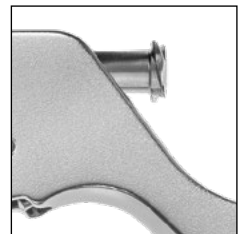

POLYMER CLIP REMOVING FORCEPS

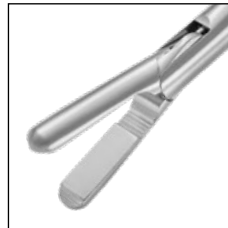
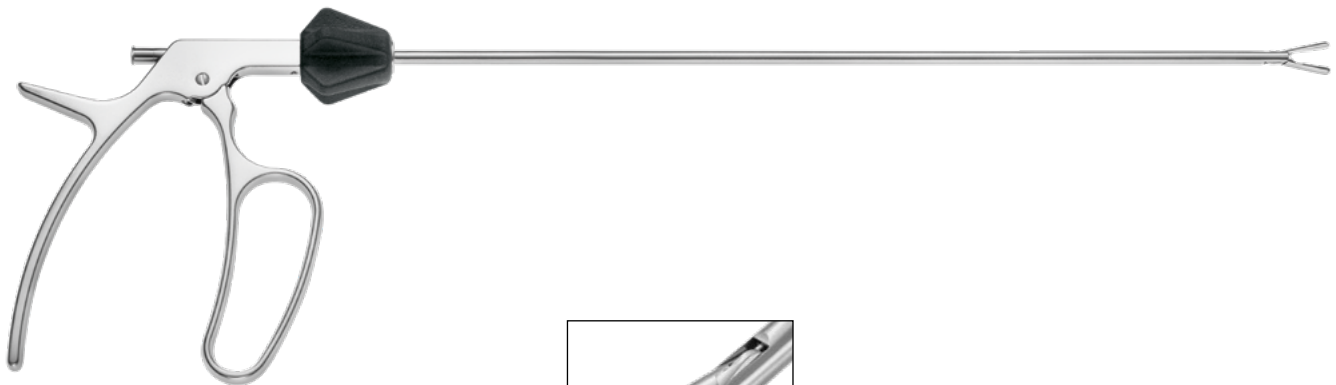

Ø 5mm SHAFT

Size / color code	detachable, 330mm	insert only, 330mm	shaft only
M & M/L (black) ■	300-830-056	300-830-156	300-830-005

Ø 10mm SHAFT

Size / color code	detachable, 330mm	insert only, 330mm	shaft only
L & XL (black) ■	300-830-015	300-830-115	300-830-010

Ø 5mm SHAFT

Size / color code	detachable, 450mm	insert only, 450mm	shaft only
M & M/L (black) ■	300-830-456	300-830-556	300-830-405

Ø 10mm SHAFT

Size / color code	detachable, 450mm	insert only, 450mm	shaft only
L & XL (black) ■	300-830-415	300-830-515	300-830-410

Ø 5mm SHAFT

Size / color code	non detachable, 330mm	non detachable, 450mm
M & M/L (black) ■	300-820-056*	300-820-456

Ø 10mm SHAFT

Size / color code	non detachable, 450mm	non detachable, 450mm
L & XL (black) ■	300-820-015*	300-820-415



Polymer Clips Removal Forceps

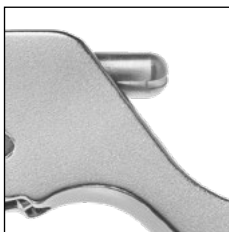

Detachable Forceps without LuerLock

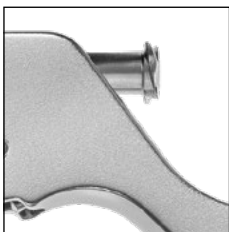

Non-detachable Forceps with LuerLock

ENDOSCOPIC BULLDOG CLAMP APPLIER

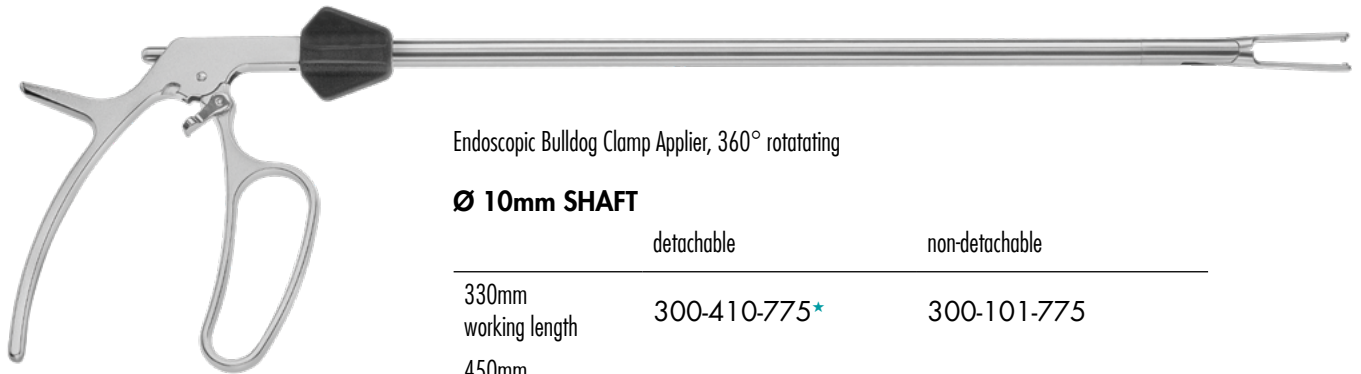

Endoscopic Bulldog Clamp Applier, 360° rotating

Ø 10mm SHAFT

	detachable	non-detachable
330mm working length	300-410-775*	300-101-775
450mm working length	300-411-775	300-111-775



Shaft only, for detachable Bulldog Clamp Applier

- 300-830-010 330 mm working length
- 300-830-410 450 mm working length



Insert only, for detachable Bulldog Clamp Applier

- 300-400-775 330 mm working length
- 300-401-775 450 mm working length



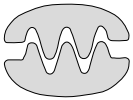

2 x 3 rows of teeth



Endoscopic Vascular Bulldog Clamp, straight, with DeBakey serration

300-100-773* 17 mm jaws

300-100-774* 25 mm jaws



Endoscopic Bulldog Clamp for bowel surgery, straight, with DeBakey serration

300-100-771* 45 mm jaws

300-100-772* 60 mm jaws



Endoscopic Vascular Bulldog Clamp, curved, with DeBakey serration

300-100-776 17 mm jaws

300-100-777* 25 mm jaws



Endoscopic Bulldog Clamp for bowel surgery, curved,
with DeBakey serration

300-100-778* 45 mm jaws

300-100-779 60 mm jaws



Endoscopic Satinsky Bulldog Clamp, with DeBakey serration
golden spring, to be used with 12.5 mm trocar system

300-100-786 60 mm jaws



300-100-789 60 mm jaws

Endoscopic Satinsky Bulldog Clamp, curved, with atraumatic
DeBakey serration, to be used with 12.5 mm trocar system

Endoscopic Bulldog Clamps with DeBakey serration

- Secure holding of tissue structure
- Occlusion of vessel and other tissue without an additional port
- Atraumatic cross clamping of the colon
- 450-475g closing pressure (300-100-771 - 779)

ROBOTIC BULLDOG CLAMP

- Specifically designed for use with robotic surgical system
- Single surgeon placement via Pro-Grasp® instrument
- Full control for optimal clamp placement
- Atraumatic DeBakey clamp design
- Introduced through 12.5mm cannula
- Suture hole for easy retrieval



Robotic Bulldog Clamp, bayonet shape,
with suture hole, blunt teeth
500g closing pressure
300-100-799* 30mm
300-100-798* 25mm

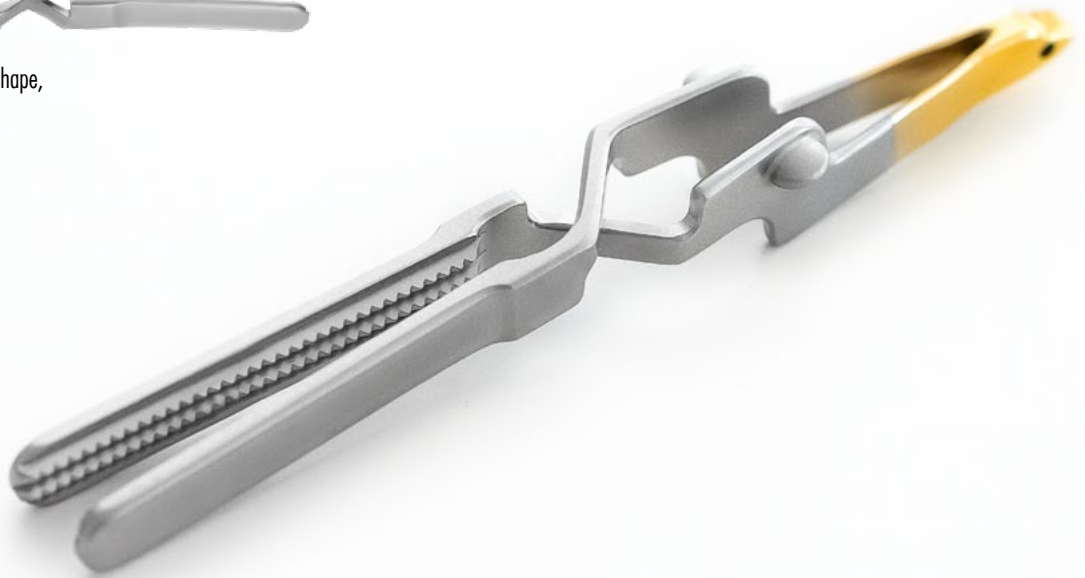

300-101-777
Robotic Bulldog Clamp Remover
Ø 10mm, rotatable, with LuerLock

TITANIUM ARTERIAL & VENOUS BULLDOG CLAMPS

- Different pressure color coding (A-Artery / V-Vein)
- Lightweight
- Non-magnetic
- Highest biocompatibility and corrosion resistance
- Mechanical strength
- DeBaKey serration



CLOSING PRESSURE

300 - 375g



Titanium Bulldog Clamp, straight, Code V (Vein),
blue

300-100-773TV 17mm jaw
300-100-774TV 25mm jaw
300-100-771TV 45mm jaw
300-100-772TV 60mm jaw



CLOSING PRESSURE

475 - 500g



Titanium Bulldog Clamp, straight, Code A (Artery), red

300-100-773TA 17mm jaw
300-100-774TA 25mm jaw
300-100-771TA 45mm jaw
300-100-772TA 60mm jaw



Applier recommendation:
300-101-775
300-410-775 (detachable)



DETACHABLE NEEDLE HOLDERS

- Detachable 2- and 3-part system
- Easy cleaning
- Handle can be used with different inserts

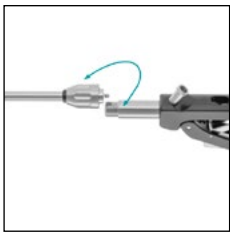

Detachable shaft from handle:
convertible system, better
cleaning possibilities

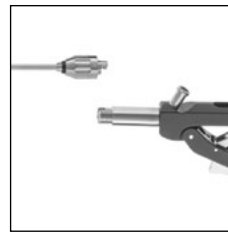

2-piece system:
An extra thin \varnothing 3mm System
with 250mm and 330mm length
for Pediatric and Mini-Laparoscopy

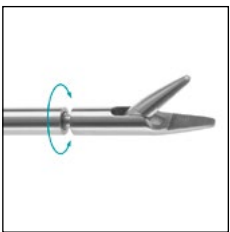

Secure screwing on the insert:
Perfect fit of the insert and
single cleaning
(only 3-piece system)

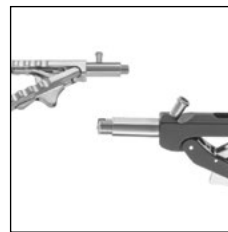

Modular handles:
Axial and straight handles
available to fulfill the surgeon's
needs and provide ergonomical
comfort

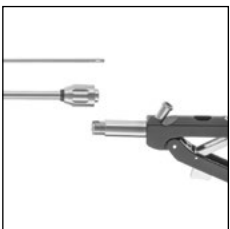



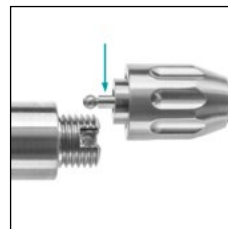

3-piece system:
Needle holder can be fitted
with different shafts and
inserts, different lengths
available

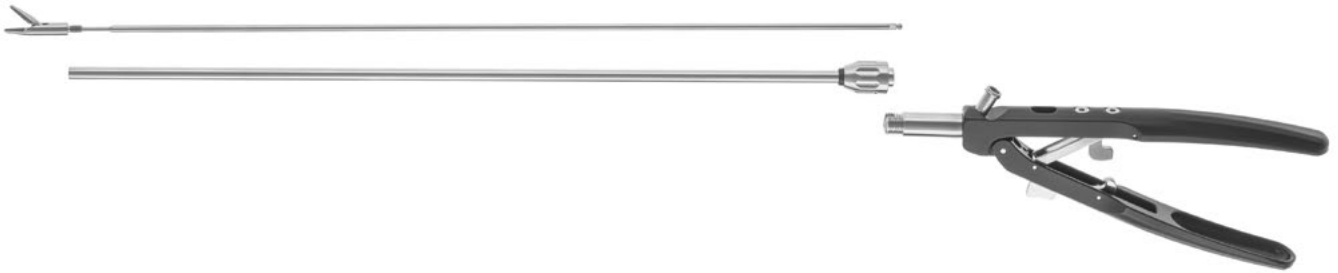

Anti-rotation feature:
due to an extra rectangular
connector, wrong insertion of
the insert is excluded

3-PIECE INSTRUMENT \varnothing 5mm



Insert only	Complete instrument  with axial handle	Complete instrument  with straight handle	Complete instrument  with angled handle
-------------	-------------------------------------------------------------------------------------------------------------------------------	-----------------------------------------------------------------------------------------------------------------------------------	----------------------------------------------------------------------------------------------------------------------------------



Straight jaw, TC

330mm	300-405-130	300-480-630	300-480-130	300-480-160
450mm	300-406-130	300-480-730	300-480-230	300-480-260



Left curved jaw, TC

330mm	300-405-140	300-480-640	300-480-140	300-480-170
450mm	300-406-140	300-480-740	300-480-240	300-480-270



Right curved jaw, TC

330mm	300-405-141	300-480-641	300-480-141	300-480-171
450mm	300-406-141	300-480-741	300-480-241	300-480-271



Diamond dusted jaw,
self-aligning

330mm	300-405-142	300-480-642	300-480-142	300-480-172
450mm	300-406-142	300-480-742	300-480-242	300-480-272



1x2 teeth jaw, TC

330mm	300-405-131	300-480-631	300-480-131	300-480-161
450mm	300-406-131	300-480-731	300-480-231	300-480-261

SINGLE PARTS FOR DETACHABLE NEEDLE HOLDER



Axial Handle, strong, straight
300-480-002



Axial Handle, straight
300-480-000



Axial Handle, angled
300-480-001



Outer Sheath, for combination with
shaft and insert, three-pieces

330mm 300-480-033
450mm 300-480-045

2-PIECE INSTRUMENT \varnothing 3mm

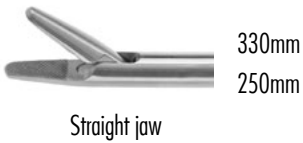
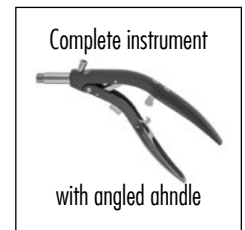
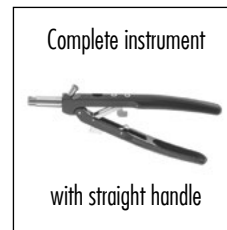
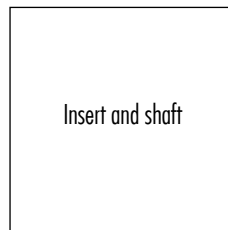

300-404-330
300-405-330

300-480-530
300-480-330

300-480-560
300-480-360

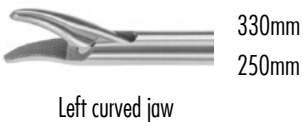

300-404-340
300-405-340

300-480-540
300-480-340

300-480-570
300-480-370

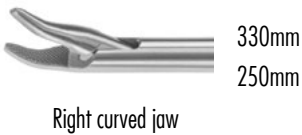

300-404-341
300-405-341

300-480-541
300-480-341

300-480-571
300-480-371

1-PIECE NEEDLE HOLDER

- Extremely light
- Aluminium anodized handle



Lightweight design with satin black surface



65° LuerLock flushing port for optimal accessibility

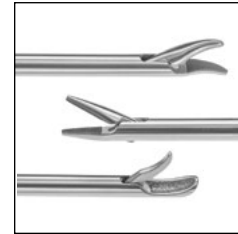

5 different jaw designs available



Rubber sealing cap included



6-tooth ratchet for always optimal positioning, with overload protection



Straight



Left curved



Right curved



1x2 teeth



Concave/convex



Ø 5mm STRAIGHT HANDLE

300-300-130*	straight	TC serrated	330mm
300-300-131	straight, 1x2 teeth	TC serrated	330mm
300-300-140*	left curved	TC serrated	330mm
300-300-141 *	right curved	TC serrated	330mm
300-300-142*	concave/convex	diamond dusted	330mm
300-300-230	straight	TC serrated	450mm
300-300-231	straight, 1x2 teeth	TC serrated	450mm
300-300-240	left curved	TC serrated	450mm
300-300-241	right curved	TC serrated	450mm
300-300-242	concave/convex	diamond dusted	450mm

Ø 5mm ANGLED HANDLE

300-300-160*	straight	TC serrated	330mm
300-300-161	straight, 1x2 teeth	TC serrated	330mm
300-300-170*	left curved	TC serrated	330mm
300-300-171 *	right curved	TC serrated	330mm
300-300-172*	concave/convex	diamond dusted	330mm
300-300-260	straight	TC serrated	450mm
300-300-261	straight, 1x2 teeth	TC serrated	450mm
300-300-270	left curved	TC serrated	450mm
300-300-271	right curved	TC serrated	450mm
300-300-272	concave/convex	diamond dusted	450mm

Ø 3mm STRAIGHT HANDLE

300-300-330	straight	TC serrated	330mm
300-300-340	left curved	TC serrated	330mm
300-300-341	right curved	TC serrated	330mm
300-300-430	straight	TC serrated	450mm
300-300-440	left curved	TC serrated	450mm
300-300-441	right curved	TC serrated	450mm

Ø 3mm ANGLED HANDLE

300-300-360	straight	TC serrated	330mm
300-300-370	left curved	TC serrated	330mm
300-300-371	right curved	TC serrated	330mm
300-300-460	straight	TC serrated	450mm
300-300-470	left curved	TC serrated	450mm
300-300-471	right curved	TC serrated	450mm

STAINLESS STEEL NEEDLE HOLDERS

- Automatic mechanism
- Smoothly releasing interlock



Smooth release lock, very robust handle design

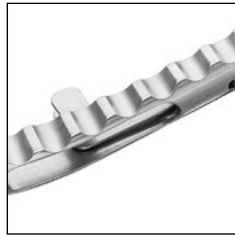

Ergonomic and reliable handle design



Straight LuerLock flushing port (sealing cap included)



Straight



Left curved



Right curved

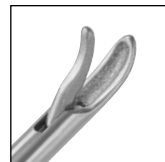

Diamond dusted, self aligning



Ø 5mm STRAIGHT HANDLE

300-100-694*	right curved	330mm	serration TC
300-100-695*	straight	330mm	serration TC
300-100-696*	left curved	330mm	serration TC
300-100-697	straight	450mm	serration TC
300-100-698	left curved	450mm	serration TC
300-100-699	right curved	450mm	serration TC
300-100-702	straight	330mm	diamond dusted
300-100-703	straight	450mm	diamond dusted

Ø 3mm STRAIGHT HANDLE

300-100-687	left curved	250mm	serration TC
300-100-688	right curved	250mm	serration TC
300-100-689	straight	250mm	serration TC
300-100-691	left curved	330mm	serration TC
300-100-692	right curved	330mm	serration TC
300-100-693	straight	330mm	serration TC

WERNER NEEDLE HOLDERS

- Detachable and single-piece option
- 3-piece model for efficient cleaning



Ergonomic axial handle design
for effortless working

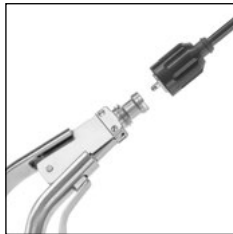

Detachable 3-piece system



Smooth and ergonomic ratchet

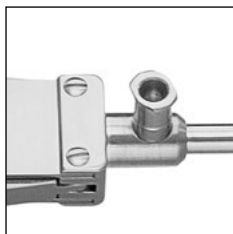

Straight LuerLock flushing port
(sealing cap included)



Ø 5mm DETACHABLE

300-300-001	straight	TC serrated	330mm
300-300-101	left curved	TC serrated	330mm
300-300-201	right curved	TC serrated	330mm
300-300-501	convex/concave	toothed	330mm
300-302-001	straight	TC serrated	450mm
300-302-101	left curved	TC serrated	450mm
300-302-201	right curved	TC serrated	450mm
300-302-501	convex/concave	toothed	450mm

Ø 5mm SINGLE-PIECE

300-300-000	straight	TC serrated	330mm
300-300-100	left curved	TC serrated	330mm
300-300-200	right curved	TC serrated	330mm
300-300-500	convex/concave	toothed	330mm
300-302-000	straight	TC serrated	450mm
300-302-100	left curved	TC serrated	450mm
300-302-200	right curved	TC serrated	450mm

Ø 3mm DETACHABLE

300-303-001	straight	TC serrated	330mm
300-303-101	left curved	TC serrated	330mm
300-303-201	right curved	TC serrated	330mm
300-303-501	convex/concave	toothed	330mm

Ø 3mm SINGLE-PIECE

300-303-000	straight	TC serrated	330mm
300-303-100	left curved	TC serrated	330mm
300-303-200	right curved	TC serrated	330mm
300-303-500	convex/concave	toothed	330mm

TC ENDOSCOPIC NEEDLE HOLDER

- Axial ring handle
- For intra- & extracorporal suturing
- Jaw with TC inserts: firm & reliable grip of suturing needles, long lifetime of the needle holder
- Ø 5 mm



330mm

450mm



Curved left

300-101-588*

300-101-589



Curved right

300-101-592

300-101-599



Straight jaw

300-101-594*



Bullnose, straight jaw

300-101-596*



300-332-320 **LIONS** Needle forceps Ø 5 mm, 330 mm without ratchet, with LuerLock, double-action



ROMEIO DIAMOND DUSTED NEEDLE HOLDER

- Auto-aligning of needles
- Concave shaped jaw: aligns curved endoscopic needles by itself in 90° position to the jaw's horizontal line
- Diamond dusted jaw: keeps needle securely in place
- Ø 5 mm

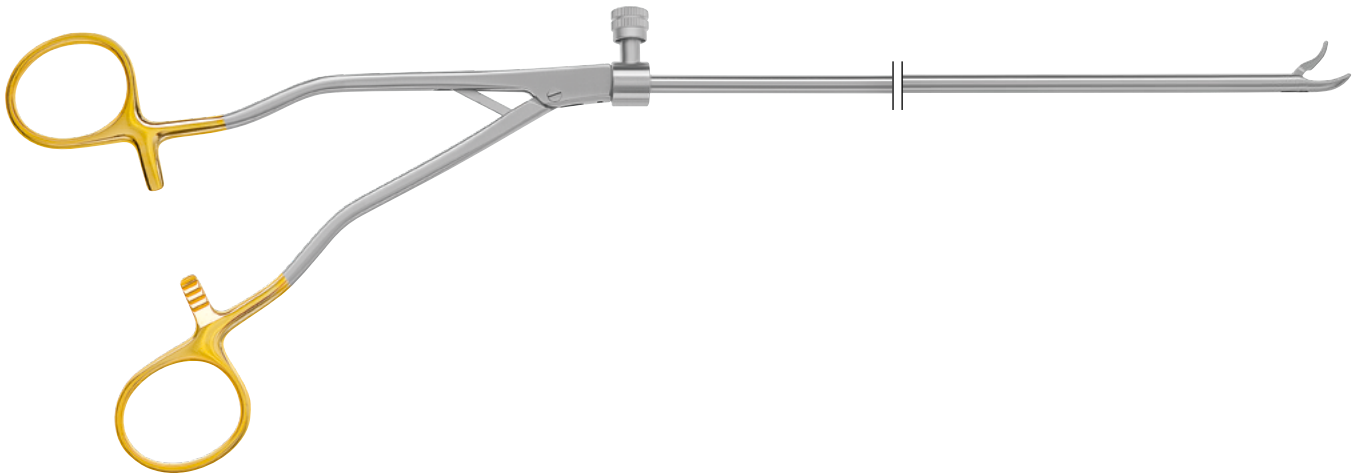

360mm





Parrot design jaw

300-101-593

MATHIEU TC ENDOSCOPIC NEEDLE HOLDER

- For intra- & extracorporal suturing
- Jaw with TC inserts: firm & reliable grip of suturing needles
- Ergonomic designed handle: easy posture by alignment of the surgeon's hand with the suturing needle
- Curved, fine tapered jaw
- Ø 5 mm



		330mm	450mm
	Curved left	300-330-033	300-330-045
	Curved right	300-332-033	
	Straight jaw	300-334-033	

TOBIAS & TOBIAS II FASCIA SUTURING INSTRUMENTS

- Self-closing spring mechanism
- For closing trocar incisions under vision



Shaft diameter	2.0mm
Working length	150mm
Tip Geometry	sharp conical tip, detachable
Cleaning	LuerLock flush port

300-151-000* Tobias Fascia Suturing Instrument with slim 2.0mm shaft and detachable conical tip



300-152-000 Tip only, set with 5 pieces



Shaft diameter	2.8mm
Working length	150mm
Tip Geometry	sharp conical tip, detachable
Cleaning	LuerLock flush port

300-153-000* Tobias II Fascia Suturing Instrument with strong 2.8mm shaft and fixed pyramidal tip

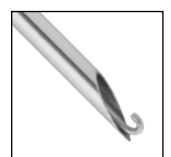

300-151-100 Rainer Fascia Suturing Device, Ø 2.3mm, 140mm working length

KNOT TIERS



Classic knot tier with slit and eye for extra corporal knotting, \varnothing 4 mm

300-030-001* 330 mm working length

300-030-003 450 mm working length

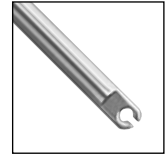

Knot tier with eye for extra corporal knotting, \varnothing 4 mm

300-030-004 330 mm working length

300-030-006 450 mm working length

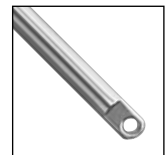

300-030-000* Knot tier with longitudinal conical form for secure holding of extracorporal knots to suture site, \varnothing 4 mm, 330 mm working length

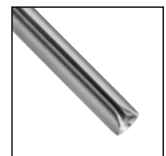

300-012-405* Reducer Sleeve, \varnothing 5 - 4mm, 175mm, red

KNOT PUSHER WITH SCISSORS



Consists of:

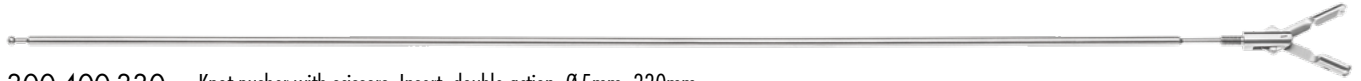

300-400-330 Knot pusher with scissors, Insert, double action, Ø 5mm, 330mm



300-660-005 Outer Sheath, insulated, Ø 5mm, 330mm, adaptable to all handles

Handles



300-750-101 Carbon Fiber Handle, HF-connection



300-750-105 Carbon Fiber Handle, hook up ratchet, HF-connection

BIPOLAR INSTRUMENTS

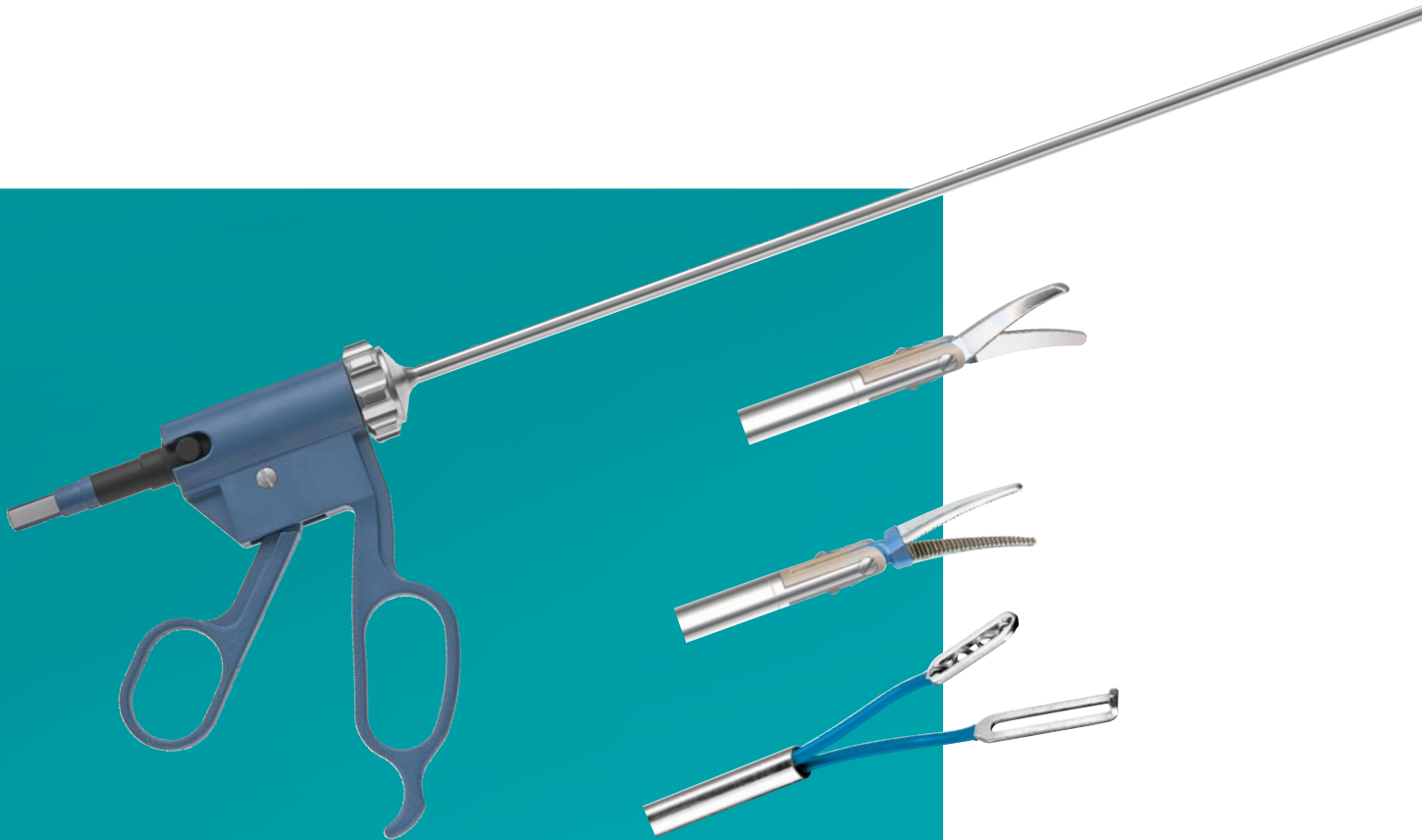

DETACHABLE BIPOLAR FORCEPS

- 360° rotatable
- Consists of forceps body & shaft - without electrode

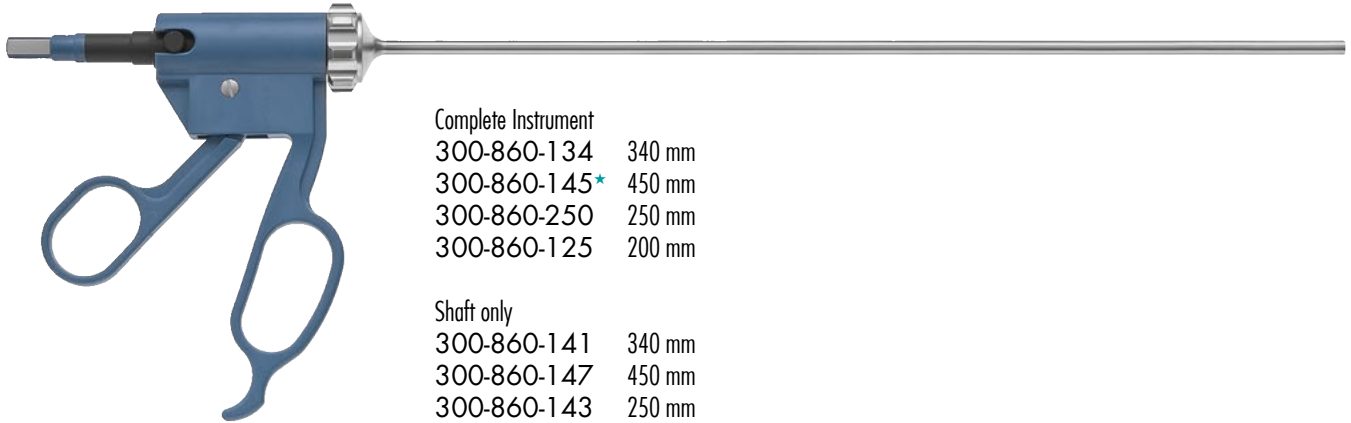

Complete Instrument

300-860-134	340 mm
300-860-145*	450 mm
300-860-250	250 mm
300-860-125	200 mm

Shaft only

300-860-141	340 mm
300-860-147	450 mm
300-860-143	250 mm
300-860-142	200 mm

Handle only

300-860-140

DETACHABLE 720° ROTATABLE BIPOLAR FORCEPS

- 720° rotatable, independently of the shaft
- Consists of forceps body & shaft - without electrode

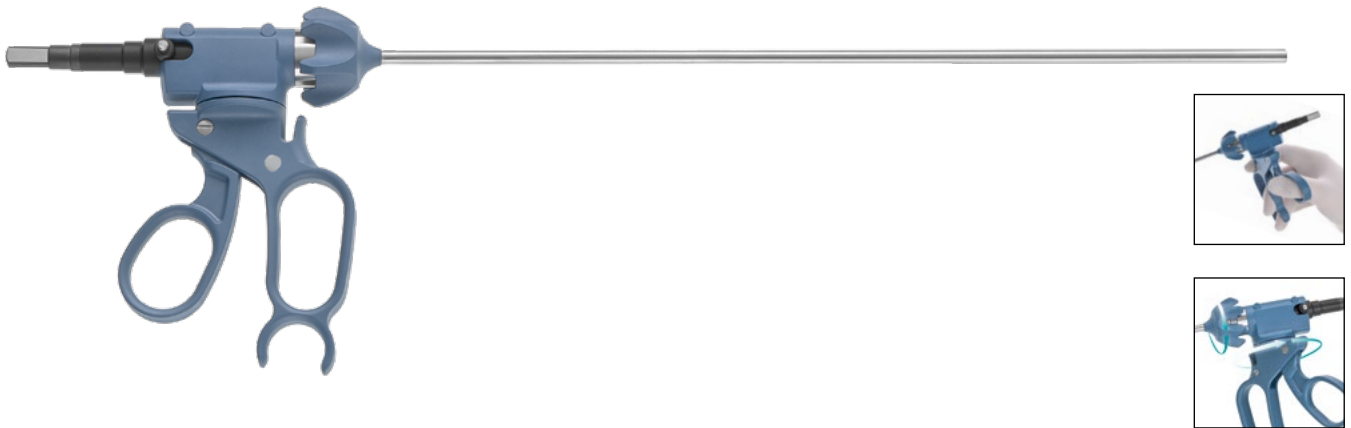

Complete Instrument

300-860-534	340 mm
300-860-545	450 mm

Shaft only









300-560-535	340 mm
300-560-546	450 mm

Handle only, with adjustment (rotating stop)

300-860-500

POWERGRIP BIPOLAR ELECTRODE INSERTS

- Insulated up to the end of the working zone
- Ø 5mm

	Grasping Forceps, fenestrated jaws, curved	300-860-009	340 mm
	Grasping Forceps, fenestrated jaws, serrated	300-860-013* 300-860-023 300-860-063	340 mm 450 mm 200 mm*
	Grasping Forceps, slightly curved	300-860-011 300-860-021 300-860-061	340 mm 450 mm 250 mm*
	Powergrip Bipolar Forceps, 2x3 teeth	300-860-012	340 mm
	Delta Grasping Forceps, double action	300-860-014 300-860-024	340 mm 450mm
	Grasping Forceps, curved	300-860-015 300-860-025 300-860-065	340 mm 450 mm 200 mm*
	Duckbill Forceps	300-860-016 300-860-026	340 mm 450 mm
	TC-Metzenbaum Scissors	300-860-018* 300-860-028 300-860-068	340 mm 450 mm 200 mm*
	Maryland Insert	300-860-019* 300-860-029 300-860-069	340 mm 450 mm 200 mm*

* 20 / 25 cm pattern not available for 720° rotatable Bipolar Forceps

POWERGRIP PREMIUM BIPOLAR ELECTRODE INSERTS



- Joint mechanism stays in place
- Insulated up to the end of the working zone
- Ø 5mm

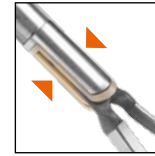

Premium model -
joint mechanism
stays in place



Standard model -
joint mechanism
exposes

	Grasping Forceps, fenestrated, curved	300-860-009	340 mm
	Grasping Forceps, fenestrated, straight	300-860-032	340 mm
	Grasping Forceps, fenestrated, curved	300-860-033	340 mm
	TC Metzenbaum Scissors	300-860-035	340 mm
	Maryland Forceps	300-860-037	340 mm
	Cut and seal forceps, curved	300-860-040	340 mm

3mm DETACHABLE BIPOLAR FORCEPS

- Small diameter, equal performance
- One-finger control of the 360° rotation wheel
- Overload protection and direct force transmission
- Flat plug for common bipolar cables

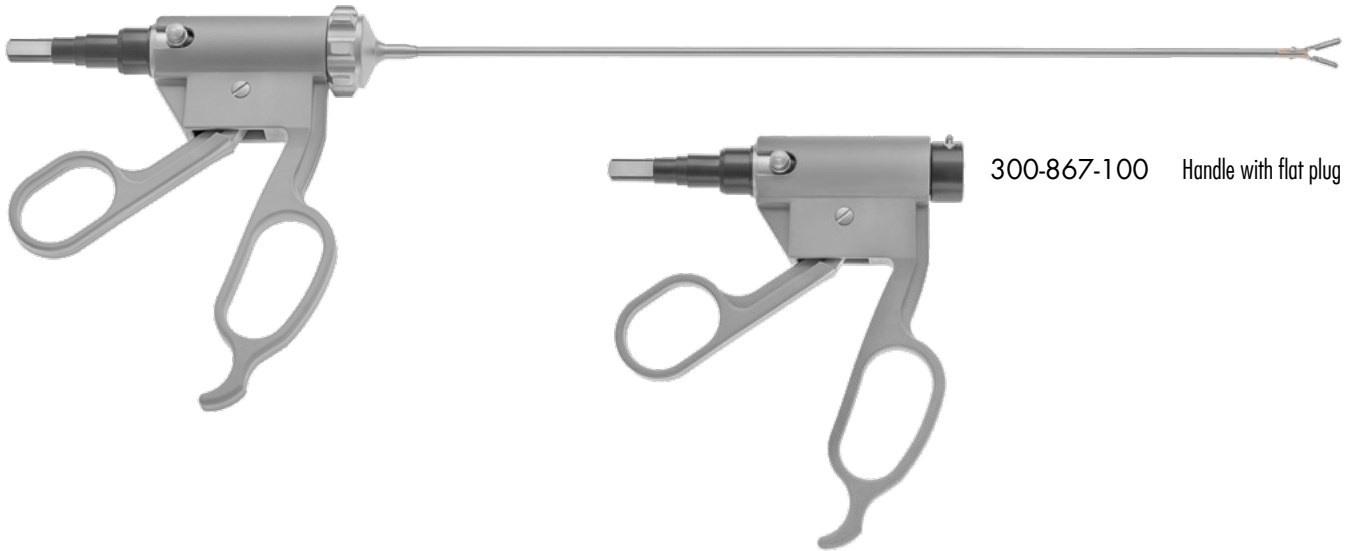

Shaft, \varnothing 3mm
 300-867-129 290mm
 300-867-120 200mm



Grasping Forceps, fenestrated

300-867-529 290mm
 300-867-520 200mm



Maryland Forceps, curved

300-867-929 290 mm
 300-867-620 200 mm



Micro Forceps

300-867-729 290 mm
 300-867-720 200 mm

BIPOLAR FORCEPS SYSTEM, Ø 5mm

- Detachable
- Consists of forceps body, inner & outer tube - without electrode

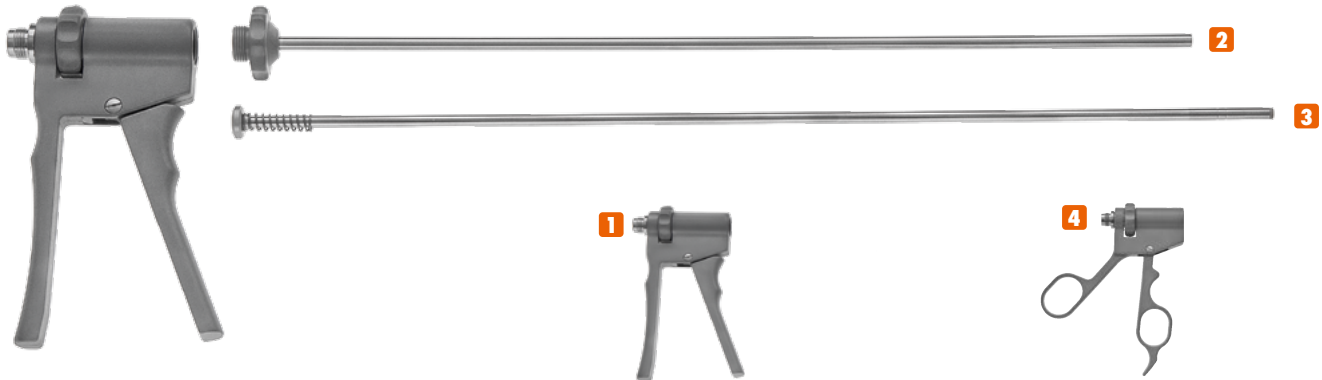

With standard handle **1**

300-855-034	340 mm
300-855-045	450 mm
300-855-020	200 mm

With ring handle **4**

300-855-134	340 mm
300-855-145	450 mm
300-855-120	200 mm



Forceps body standard
300-855-001



Forceps body ring handle
300-855-101

Outer Tube **2**

300-855-007	340 mm
300-855-052	450 mm
300-855-003	200 mm

Inner tube **3**

300-855-006	340 mm
300-855-051	450 mm
300-855-002	200 mm



Bipolar Cables, length: 3m
2 banana plug 300-855-100
Valleylab plug 300-855-105
Martin plug 300-855-102
Erbe plug 300-855-103



Adapter for bipolar cable
300-855-400 with flat plug
300-855-401 with 2-pin-plug

Electrodes / Inserts

	Tubal ligation	300-855-010	340 mm
		300-855-022	450 mm
		300-855-060	200 mm
	Micro jaw, 1 mm	300-855-011	340 mm
		300-855-021	450 mm
		300-855-061	200 mm
	Grasping forceps, 3 mm	300-855-015	340 mm
		300-855-025	450 mm
		300-855-065	200 mm
	Scissors, curved	300-855-017	340 mm
		300-855-027	450 mm
		300-855-067	200 mm
	Kleppinger, serrated	300-855-013	340 mm
		300-855-023	450 mm
		300-855-063	200 mm
	Scissors with TC blades, curved	300-855-018	340 mm
		300-855-028	450 mm
	Dissector Maryland, curved	300-855-019	340 mm
		300-855-029	450 mm
		300-855-069	200 mm

MICRO BIPOLAR SYSTEM, Ø 3mm

- Suits for all operations in Laparoscopy
- Especially for fine coagulation of tissue and small vessels
- Easy detachable for cleaning purposes



300-857-100 Bipolar Micro Coagulation Forceps, Ø 3mm

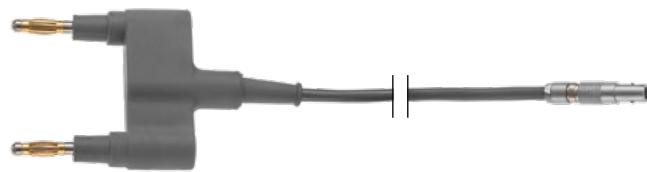

300-857-205
Cable only for 300-857-100

Electrode Inserts



Micro Electrode, rippled bar

300-857-111



Micro Electrode, fluted tip, 1mm

300-857-112



Bipolar Micro Electrodes, 3 mm



Bipolar L-Hook

300-857-301



Bipolar V-Hook

300-857-302



Bipolar Needle

300-857-303

BIPOLAR CABLES



Flat plug



Flat plug, angled



Flat plug, square



2-pin plug

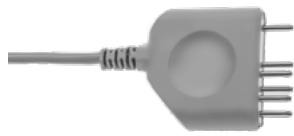

RZ HF Unit
SDS Plug,
programmable

3m	700-500-300
5m	700-500-500



2-Banana*

3m	700-350-030	300-860-100	700-350-130	700-351-030
5m	700-350-050	300-860-111	700-350-150	700-351-050



Erbe

3m	700-101-001	700-100-130	700-101-130	700-100-102
5m	700-100-101	700-100-150	700-101-150	700-100-103



Martin, Aesculap
Berchtold

3m	700-287-030	700-200-130	700-287-130	700-200-132
5m	700-287-050	700-200-150	700-287-150	700-200-152



RZ, Valleylab,
Lamidey, EMC

3m	700-351-031*	700-300-003	700-351-131	700-300-203
5m	700-351-051	700-300-005	700-351-151	700-300-205



Erbe
EMC/Dolley

3m	700-400-050	700-400-003	700-400-103	700-400-203
5m	700-400-055		700-400-105	

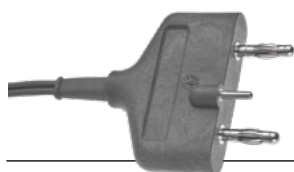

Valleylab
autobipolar

3m	700-400-030	700-400-130
5m		

* Not available with CE marking within Europe



2-pin plug, angled

2-pin plug, angled

Round plug

R. Wolf plug

Karl Storz plug

Ethicon Scissors plug

Aesculap Plug

700-345-403	700-345-003	700-739-003	700-630-003	700-351-047	700-351-053	700-200-030
700-345-405	700-345-005	700-739-005		700-351-048	700-351-055	700-200-050

700-101-230		700-100-202	700-100-104	700-100-302	700-100-402	700-100-502
700-101-250		700-100-303	700-100-105	700-100-305	700-100-405	700-100-505

700-287-230		700-200-232	700-390-030	700-200-332	700-200-432	700-200-532
700-287-250		700-200-252	700-390-050	700-200-352	700-200-452	700-200-552

700-351-231	700-300-403	700-736-003	700-300-503	700-300-603	700-300-703	
700-351-251	700-300-405	700-736-005	700-300-505		700-300-705	700-300-805

700-400-303	700-400-403	700-400-503		700-400-603		
		700-400-205				

BARIATRIC INSTRUMENTS

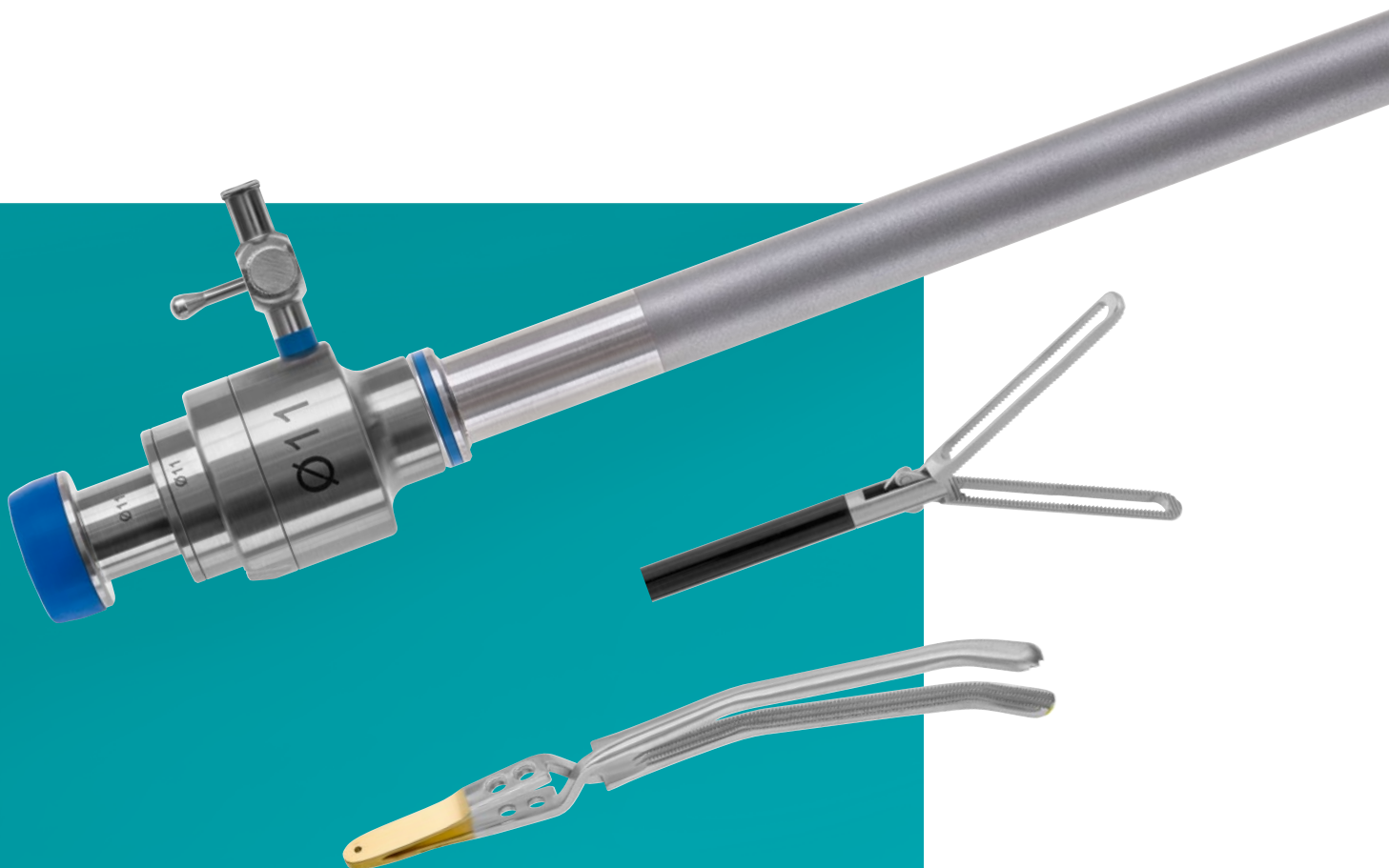



Stainless steel valve, XL smooth stainless steel sleeve,
150mm working length
300-220-155 Ø 5.5mm
300-220-111 Ø 11.0mm
300-220-113 Ø 13.0mm



Synthetic valve, XL smooth stainless steel sleeve
150mm working length
300-230-155 Ø 5.5mm
300-230-111 Ø 11.0mm
300-230-113 Ø 13.0mm

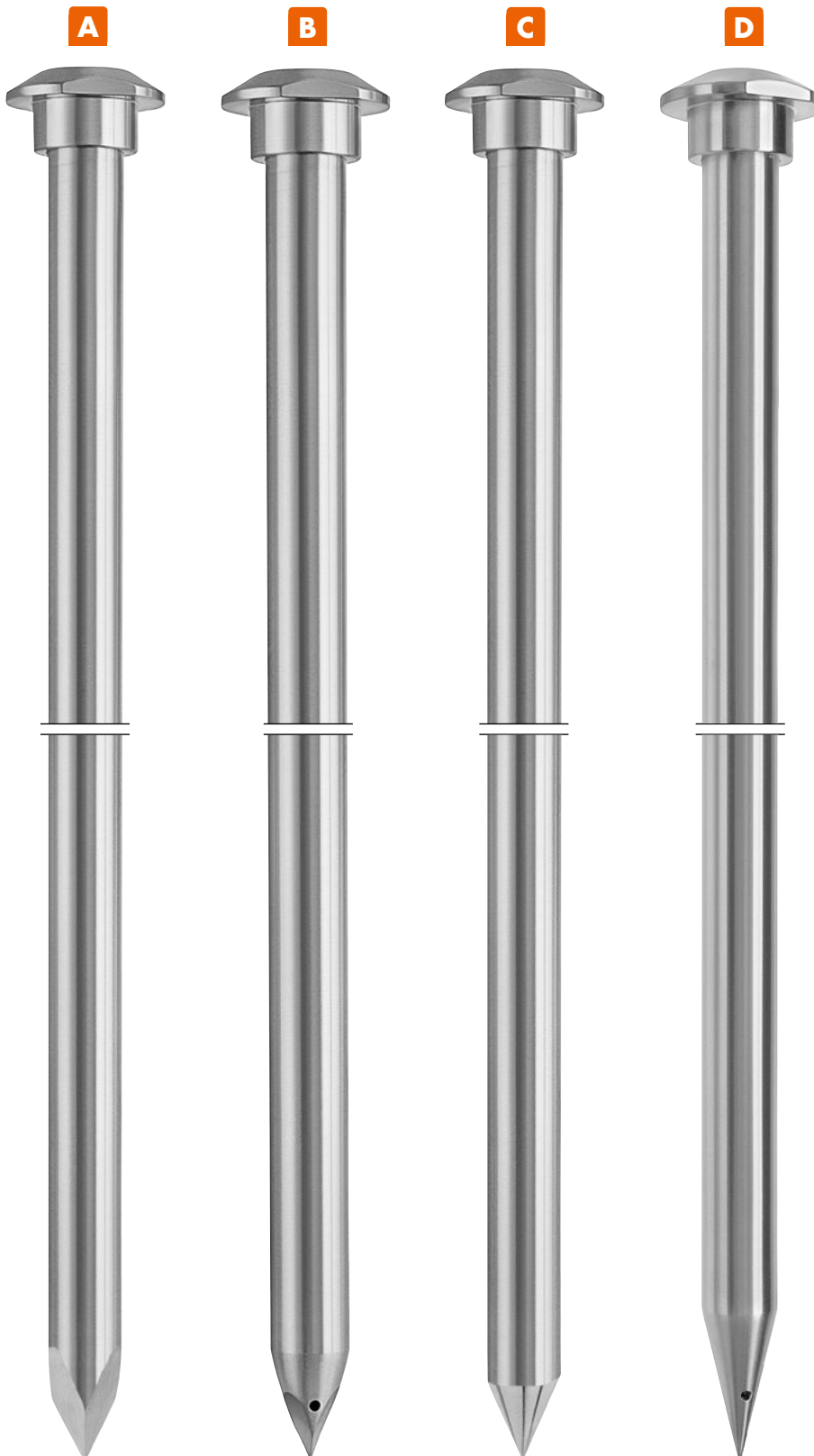

A

With pyramidal tip, reusable, cutting
 150mm working length
 300-241-155 Ø 5.5mm
 300-241-111 Ø 11.0mm
 300-241-113 Ø 13.0mm

B

Cannulated with hole, pyramidal tip
 150mm working length
 300-244-155 Ø 5.5mm
 300-244-111 Ø 11.0mm
 300-244-113 Ø 13.0mm

C

With conical tip, reusable, cutting
 150mm working length
 300-240-155 Ø 5.5mm
 300-240-111 Ø 11.0mm
 300-240-113 Ø 13.0mm

D

Cannulated with hole, conical tip
 150mm working length
 300-243-155 Ø 5.5mm
 300-243-111 Ø 11.0mm
 300-243-113 Ø 13.0mm



Suction and irrigation tube with 4 x 4 holes for handles 300-019-501 and 300-019-601
 300-019-805 Ø 5mm, 450mm
 300-019-810 Ø 10 mm, 450mm

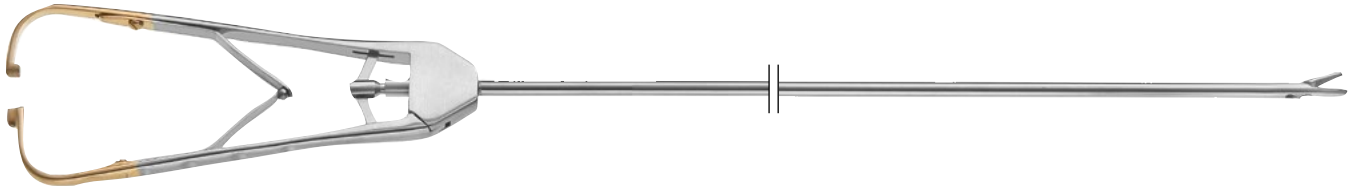

300-330-045 **MATHIEU** Endoscopic TC needle holder, traditional ratchet design, spring-loaded, curved left, Ø 5 mm, 450 mm working length

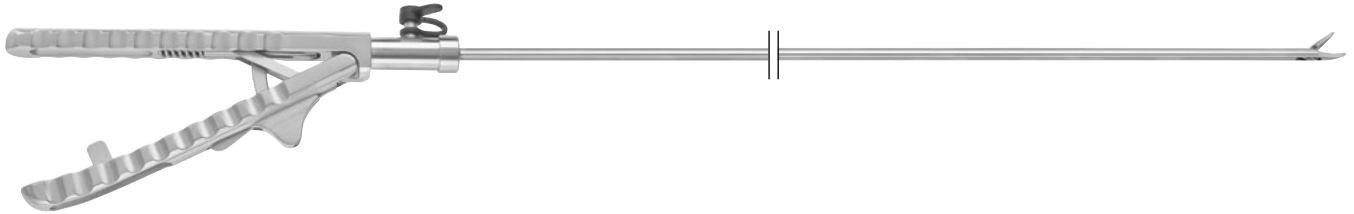

Endoscopic TC needle holder, strong axial handle, automatic locking mechanism, Ø 5 mm, 450 mm working length

- 300-100-697 straight jaw
- 300-100-698 left curved jaw

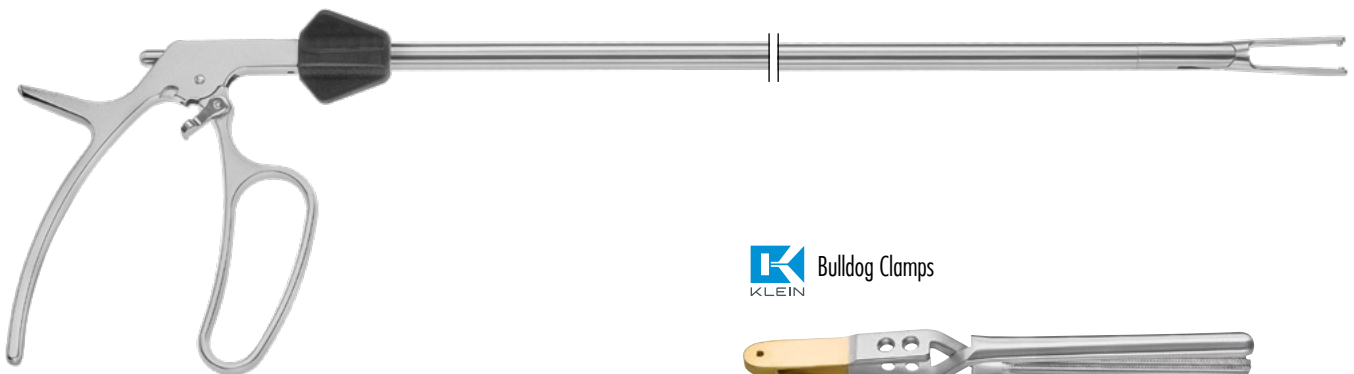

300-111-775 Endoscopic Bulldog Clamp Applier, detachable, Ø 10mm, 360° rotating, 450mm working length



300-100-772 60 mm jaws
Endoscopic Bulldog Clamp for bowel surgery, straight, with DeBaKey serration



300-100-786 60 mm jaws
Endoscopic Satinsky Bulldog Clamp, with DeBaKey serration, to be used with 12.5 mm trocar system



300-100-789 60 mm jaws
Endoscopic Satinsky Bulldog Clamp, curved, with atraumatic DeBaKey serration, to be used with 12.5 mm trocar system



Ø 5 mm

insert only

300-401-732



Complete Instrument with handle 300-750-001

300-411-732

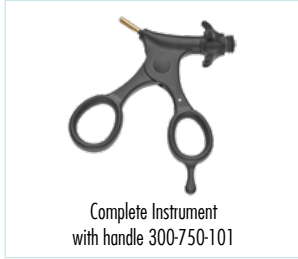

Complete Instrument with handle 300-750-101

300-421-732

KELLY

Dissecting forceps curved, fine-tapered, cross-serrated jaws with wide opening, double action, Ø 5 mm, 450 mm



Ø 5 mm

300-401-738

300-411-738

300-421-738

MIXTER

Fine dissecting forceps 90° angled, fine serrated jaws, double action, Ø 5 mm, 450 mm

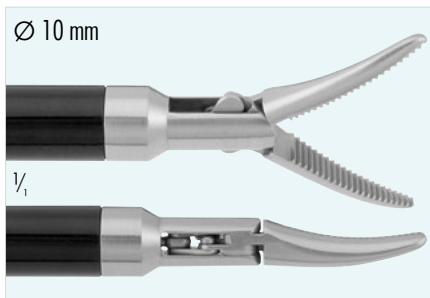

Ø 10 mm

300-401-730

300-411-730

300-421-730

MARYLAND

Dissecting forceps curved, blunt jaws, double action, Ø 10 mm, 450 mm

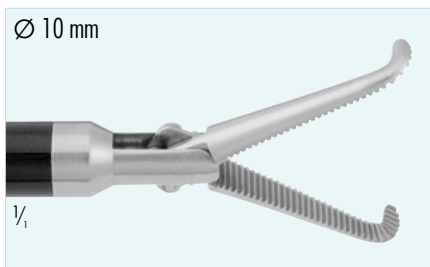

Ø 10 mm

300-401-739

300-411-739

300-421-739

MIXTER

Dissecting forceps 90° angled, serrated jaws, double action, Ø 10 mm, 450 mm

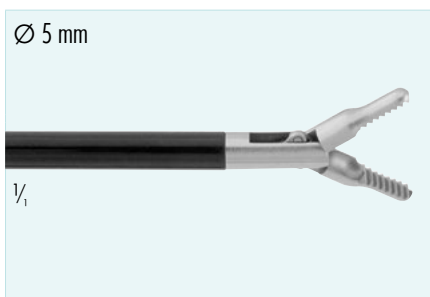

Ø 5 mm

300-401-025

300-411-025

300-421-025

DOLPHIN

Grasping and dissecting forceps, fine serrated and tapered jaws, double action, Ø 5 mm, 450 mm

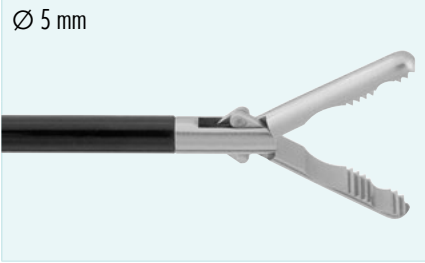
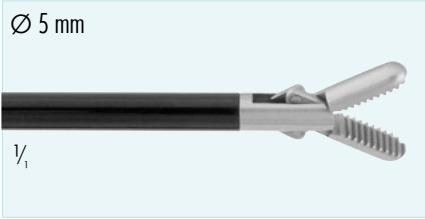
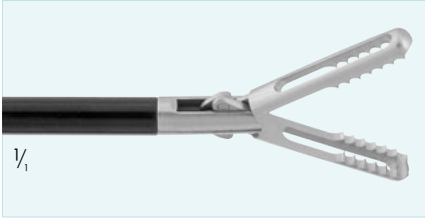
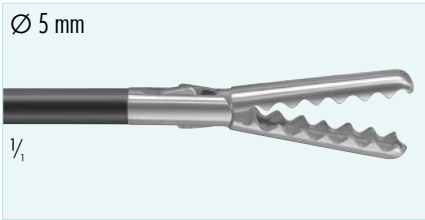
	insert only	Complete Instrument with handle 300-750-003	Complete Instrument with handle 300-750-103
<p>Ø 5 mm</p>  <p>FUNDUS Grasping forceps with 2 cups and serrated jaws, double action, Ø 5 mm, 450 mm</p>	300-401-015	300-431-015	300-441-015
<p>Ø 5 mm</p>  <p>BULLNOSE Grasping forceps, heavy pattern, standard serrated jaws, double action, Ø 5 mm, 450 mm</p>	300-401-001	300-431-001	300-441-001
<p>Ø 5 mm</p>  <p>GRIPPER #1 Grasping forceps with coarse serration and fenestration, double action, Ø 5 mm, 450 mm</p>	300-401-017	300-431-017	300-441-017
<p>Ø 5 mm</p>  <p>PRESTIGE Grasping forceps with long, bevelled-edge jaws and deep cup for large tissue collection, double action, Ø 5 mm, 450 mm</p>	300-401-013	300-431-013	300-441-013



insert only

300-401-201



300-431-201

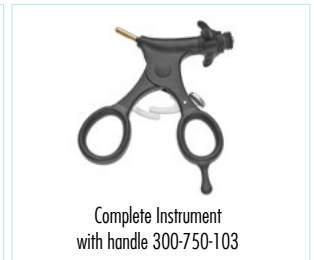

300-441-201

COBRA

Grasping forceps with sharp 2 x 4 teeth and serrated inner jaws, double action, Ø 5 mm, 450 mm



300-401-710

300-431-710

300-441-710

CLAW GRASPER

Grasping forceps, aggressive 2 x 3 teeth and smooth inner jaws, single action, Ø 10 mm, 450 mm

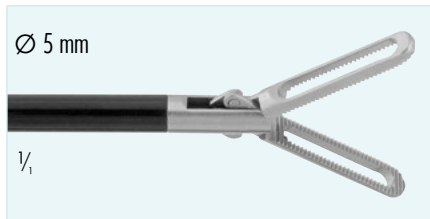

300-401-289

300-431-289

300-441-289

JOHANS

Grasping forceps with 20 mm fenestrated jaws, double action, Ø 5 mm, 450 mm



300-401-291

300-431-291

300-441-291

LONG JOHANS

Grasping forceps with 40 mm fenestrated jaws, double action, Ø 5 mm, 450 mm



insert only

300-401-082



300-411-082

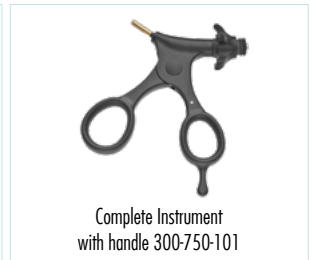

300-421-082

Biopsy forceps with sharp oval cups, double action, Ø 5 mm, 450 mm

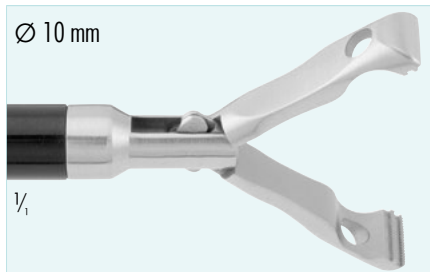

insert only

300-401-079

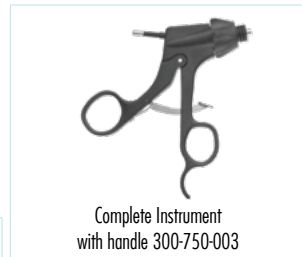

300-431-079



300-441-079

DEBAKEY BABCOCK

Traditional style Babcock grasping forceps, fenestrated jaws with atraumatic DeBakey serration, double action, Ø 10 mm, 450 mm

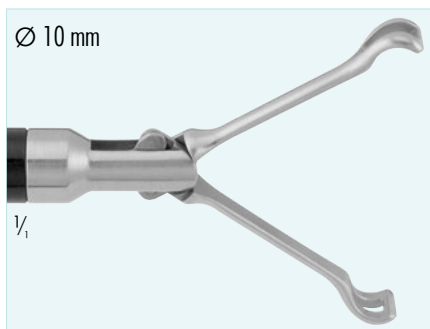

300-401-078

300-431-078

300-441-078

BABCOCK

Traditional style Babcock grasping forceps, fenestrated jaws with fine serration, double action, Ø 10 mm, 450 mm

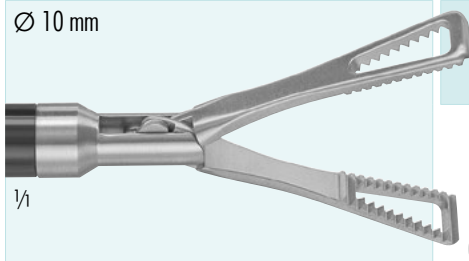

insert only

300-401-085



300-431-085



300-441-085

COLLIN

Grasping forceps, V-shaped tip with deep serrations for a firm grip, double action, Ø 10 mm, 450 mm

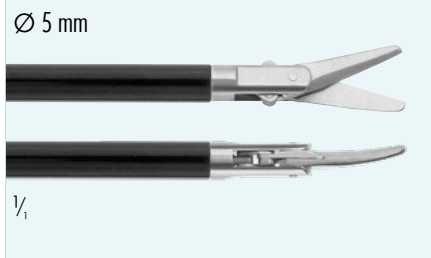

insert only

300-401-067



300-411-067



300-421-067

ORIGINAL METZENBAUM

Scissors, short blades (12 mm), slightly curved, double action, Ø 5 mm, 450 mm

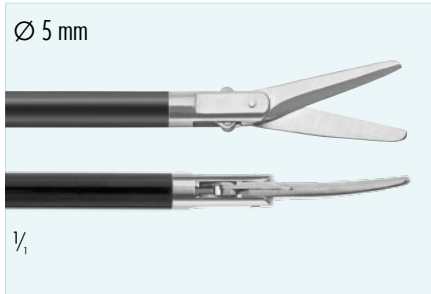

300-401-070

300-411-070

300-431-070

METZENBAUM

Scissors, long blades (18 mm), slightly curved, double action, Ø 5 mm, 450 mm

DETACHABLE XL BIPOLAR FORCEPS

- 360° rotatable
- Consists of forceps body & shaft - without electrode



300-860-145 Bipolar Coagulation Forceps, 450mm

POWERGRIP XL BIPOLAR ELECTRODE INSERTS

- Insulated up to the end of the working zone
- Ø 5mm



	Grasping Forceps, fenestrated jaws, serrated, 5 mm	300-860-023	450 mm
	Grasping Forceps, slightly curved	300-860-021	450 mm
	Delta Grasping Forceps	300-860-024	450 mm
	Grasping Forceps, curved	300-860-025	450 mm
	TC-Metzenbaum Scissors	300-860-028	450 mm
	Maryland Insert	300-860-029	450 mm

PEDIATRIC AND MINI INSTRUMENTS

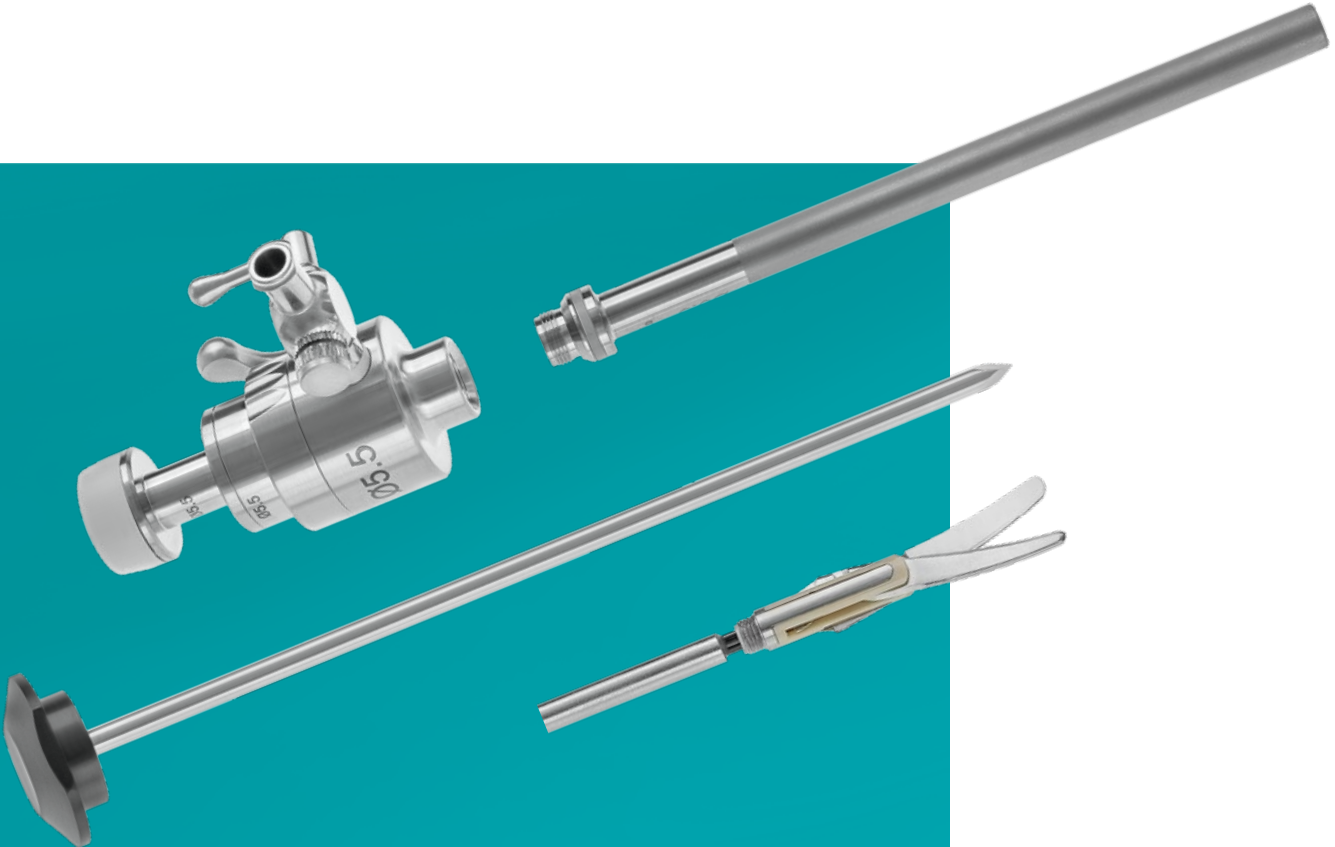

PEDIATRIC TROCAR SYSTEM

- 100mm working length
- Ø 5.5mm



MultiPort Trocar System



SiliPort Trocar System



- 1** Stainless steel sleeve, smooth
- 2** Stainless steel sleeve, thread
- 3** Stainless steel sleeve, oblique
- 4** Synthetic sleeve, smooth
- 5** Synthetic sleeve, thread

MultiPort Trocar System

- 300-220-055*
- 300-221-055
- 300-222-055*
- 300-223-055
- 300-224-055

Siliport Trocar System

- 300-230-055
- 300-231-055
- 300-232-055
- 300-233-055
- 300-234-055



300-112-035 Stainless steel trocar with smooth sleeve, 70mm working length, Ø 3.5mm

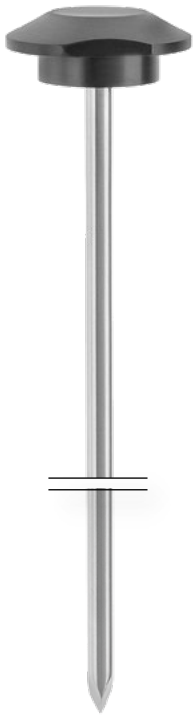

With pyramidal tip, reusable, cutting
 300-241-035 Ø 3.5mm
 300-241-055* Ø 5.5mm



With conical tip, reusable, cutting
 300-240-035 Ø 3.5mm
 300-240-055 Ø 5.5mm



Hasson Obturator with blunt ball tip,
 reusable, atraumatic
 300-242-035 Ø 3.5mm
 300-242-055 Ø 5.5mm



Safety Trocar
 300-152-055 5.5 mm



Sealing caps, color-coded, 10 pieces
 300-250-035 Ø 3.5mm (red)
 300-250-055* Ø 5.5mm (white)



Gaskets for MultiPort Trocar System, 10 pieces
 300-250-235 Ø 3.5mm (black)
 300-250-255* Ø 5.5mm (white)

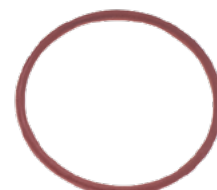

Gaskets for MultiPort Trocar System, 10 pieces
 300-250-135 Ø 3.5mm
 300-250-155* Ø 5.5mm

RZ EASYCLEAN MINI SUCTION AND IRRIGATION SYSTEM

- 2 color coded trumped valves
- Universal suction channel
- Lateral LuerLock irrigation channel



Suction and irrigation set

300-019-700 suction tube 300-019-735 and big valve body 300-019-501

300-019-701 suction tube 300-019-735 and small valve body 300-019-601

Spare Parts for **RZ EasyClean** Mini Suction and Irrigation System

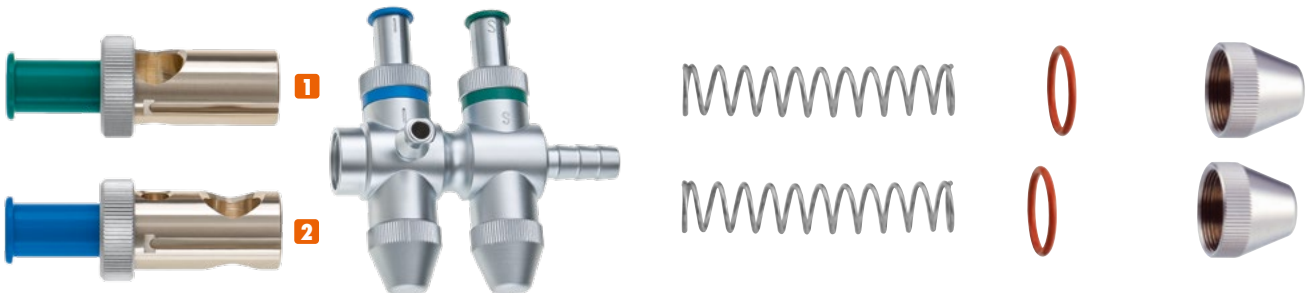

2 300-019-750
Suction piston
1 unit

1 300-019-760
Irrigation piston
1 unit

300-501-730 big
300-601-731 small
Single Valve Body

300-019-770
Spring
1 set with 10 pieces

300-019-780
Gasket O-Ring
1 set with 10 pieces

300-019-790
Screw cap
1 unit



300-019-735 Suction and irrigation tube with 4x4 holes, \varnothing 3.5mm
for handles 300-019-501 and 300-019-601, 240mm



300-165-100 Suction and irrigation handle with 2 trumpet valves. Suction channel with large universal tube connector, irrigation channel with lateral LuerLock connection. Removable ergonomic handle plate for easy cleaning and maintenance.



300-166-100* Pistol-shaped suction and irrigation handle with 2-way valve and 2 big universal tube connectors for suction and irrigation. Ergonomic handle design for optimal operating convenience.



Suction and irrigation cannula with 4 holes, Ø 3 mm
300-172-003 340 mm working length
300-172-253 250 mm working length



Suction and irrigation cannula with 16 holes, Ø 3 mm
300-173-003 340 mm working length
300-173-253 250 mm working length



300-192-000 Suction and irrigation handle with rotating 2-way lever mechanism and 2 big universal tube adapter



Suction and irrigation tube with 4 holes on the tip for use with handle 300-192-000

300-192-003 340 mm working length

300-192-253 250 mm working length



Suction and irrigation tube with 4 x 4 holes on the tip for use with handle 300-192-000

300-193-003 340 mm working length

300-193-253 250 mm working length



Palpation Probe, graduated, \varnothing 2.8 mm

300-193-303 330 mm working length

300-195-253 250 mm working length



Injection and puncture needle, 2.8 mm, 1.2 mm sharp needle tip

300-194-303 330 mm working length

300-194-253 250 mm working length



TC ENDOSCOPIC NEEDLE HOLDERS, Ø 3mm



STRAIGHT HANDLE

300-300-330	straight	330mm
300-300-340	left curved	330mm
300-300-341	right curved	330mm
300-300-430	straight	450mm
300-300-440	left curved	450mm
300-300-441	right curved	450mm

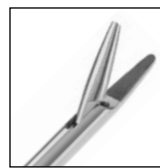

Straight

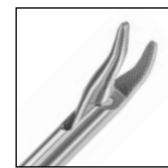

Left curved



Right curved



ANGLED HANDLE

300-300-360	straight	330mm
300-300-370	left curved	330mm
300-300-371	right curved	330mm
300-300-460	straight	450mm
300-300-470	left curved	450mm
300-300-471	right curved	450mm

LAPAROSCOPIC MICRO INSTRUMENTS, 2-PIECE

- Ø 3 mm shaft
- LuerLock irrigation channel



Metzenbaum Scissors
straight, short blade: 8mm, double action

300-503-069 330mm
300-505-069 210mm



Hook Scissors
round cutting blade, single action

300-503-060 330mm
300-505-060 210mm



Peritoneal Scissors
straight, delicate, fine serrated, single action

300-503-063 330mm
300-505-063 210mm



Micro Scissors
straight, sharp, single action

300-503-570 330mm
300-505-570 210mm



Metzenbaum Scissors
slightly curved, short blade: 12mm, double action

300-503-067 330mm
300-505-067 210mm



Biopsy Cup Forceps
sharp, oval cups, double action

300-503-082 330mm
300-505-082 210mm



Biopsy Cup Forceps
sharp, oval cups, 1 pin, 1 hole, double action

300-503-080 330mm
300-505-080 210mm



Fundus Grasping Forceps
serrated, double action

300-503-015
300-505-015

330mm
210mm



Dolphin Dissecting Forceps
fine serrated, biopsy cup, conical shape, double action

300-503-025
300-505-025

330mm
210mm



Maryland fine Dissector
serrated, curved, conical shape, double action

300-503-731
300-505-731

330mm
210mm



Dolphin Dissecting Forceps
fine serrated, double action

300-503-021
300-505-021

330mm
210mm



Johans atraumatic Grasping Forceps
fenestrated, serrated, double action

300-503-052
300-505-052

330mm
210mm



„Needle Nose“ Dissecting & Grasping Forceps
fine, conical shape, cross serrated, double action

300-503-016
300-505-016

330mm
210mm



Standard Grasping Forceps
biopsy cup, serrated, double action

300-503-000
300-505-000

330mm
210mm



Claw Grasper Forceps
2x3 teeth, smooth, single action

300-503-710
300-505-710

330mm
210mm

3.5mm LAPAROSCOPIC INSTRUMENTS

- Stronger 3-piece detachable instruments, less invasive & scarless surgery
- Very simple cleaning, assembling and disassembling
- 3.5mm mini instruments designed for pediatric (250mm) and mini Laparoscopy use



300-750-101*
PEEK Polymer Handle with
HF - connection



300-750-103*
PEEK Polymer Handle with ratchet
and HF - connection



Outer Sheath, insulated, adaptable to all handles
300-660-035 330mm
300-550-035 250mm



Metzenbaum Scissors
straight, short blade: 12mm, double action

300-403-069 330mm
300-404-069 250mm



Hook Scissors
round cutting blade, single action

300-403-060 330mm
300-404-060 250mm



Biopsy Cup Forceps
sharp, oval cups, double action

300-403-082 330mm
300-404-082 250mm



Maryland Dissecting Forceps
gently curved, double action

300-403-732 330mm
300-404-732 250mm



Mixer Dissecting Forceps
90° angled, fine serrated jaws, double action

300-403-738 330mm
300-404-738 250mm



Fundus Grasping Forceps
2 cups, serrated, double action

300-403-015 330mm
300-404-015 250mm



DeBaKey Grasping Forceps
25mm long, atraumatic, double action

300-403-244 330mm
300-404-244 250mm



Johans Grasping Forceps
20mm long, fenestrated, single action

300-403-284 330mm
300-404-284 250mm



Johans Grasping Forceps
17mm long, fenestrated, double action



300-403-289 330mm
300-404-289 250mm

3mm DETACHABLE BIPOLAR FORCEPS

- Small diameter, equal performance
- One-finger control of the 360° rotation wheel
- Overload protection and direct force transmission
- Flat plug for common bipolar cables



Shaft, Ø 3mm
 300-867-129 290mm
 300-867-120 200mm

	Grasping Forceps, fenestrated	300-867-529 290mm 300-867-520 200mm
	Maryland Forceps, curved	300-867-929 290 mm 300-867-620 200 mm
	Micro Forceps	300-867-729 290 mm 300-867-720 200 mm

MICRO BIPOLAR SYSTEM, Ø 3mm

- Suits for all operations in Laparoscopy
- Especially for fine coagulation of tissue and small vessels
- Easy detachable for cleaning purposes



300-857-100 Bipolar Micro Coagulation Forceps, Ø 3mm

300-857-205
Cable only for 300-857-100

Electrode Inserts



Micro Electrode, rippled bar

300-857-111



Micro Electrode, fluted tip, 1mm

300-857-112



Bipolar Micro Electrodes, 3 mm



Bipolar L-Hook

300-857-301



Bipolar V-Hook

300-857-302







Bipolar Needle

300-857-303

MONOPOLAR COAGULATION ELECTRODES, Ø 2.8mm





	J-hook	300-200-132 300-200-232	330 mm 250 mm
	L-hook	300-200-133 300-200-233	330 mm 250 mm
	Ballpoint	300-200-134 300-200-234	330 mm 250 mm
	Spatula	300-200-131 300-200-231	330 mm 250 mm
	Needle	300-200-137 300-200-237	330 mm 250 mm

BIPOLAR COAGULATION ELECTRODES



Bipolar Micro Electrodes, Ø 3 mm, 340mm working length

	Bipolar L-Hook	300-257-002
	Bipolar V-Hook	300-257-004
	Bipolar Needle	300-257-015

CONTAINER AND CLEANING

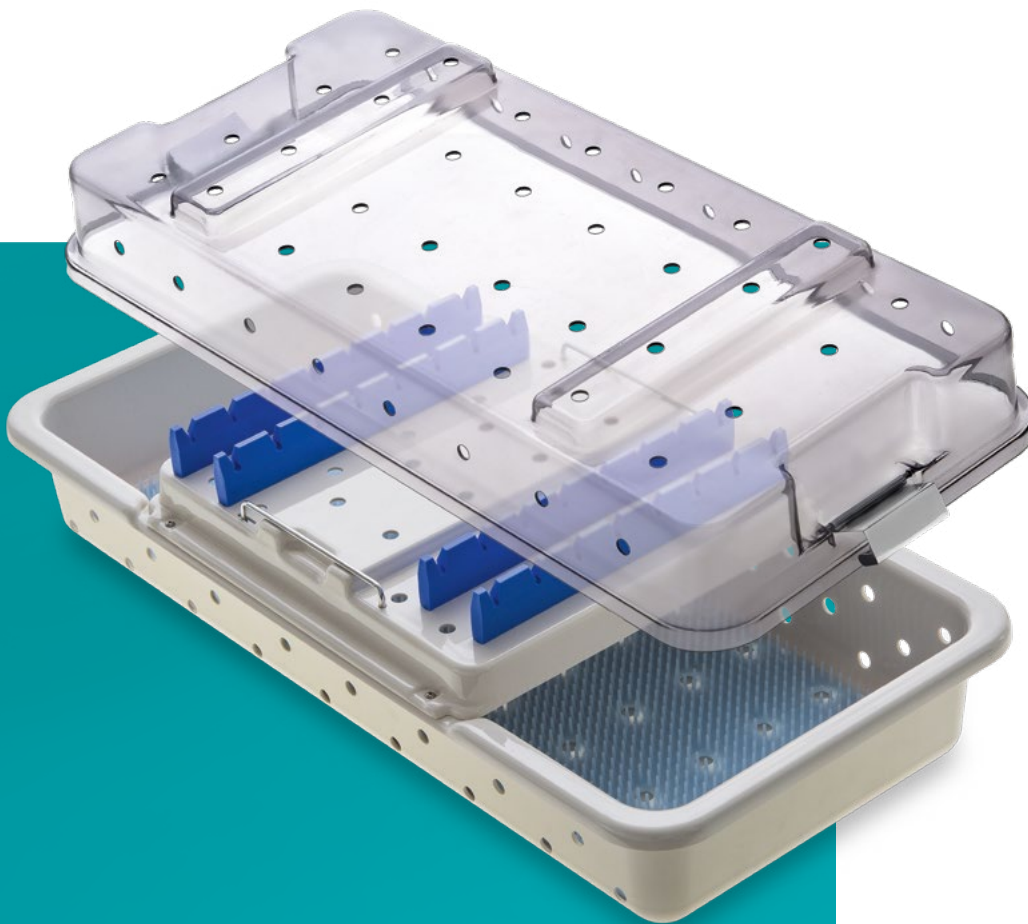

SAFE + CLEAN ENDOSCOPE PLASTIC CONTAINER with silicone bars on base and lid

600-505-000

Endoscopes	1 (∅ 1-10mm)
Endoscope length	max. 270mm
Dimensions	271 x 70 x 35mm

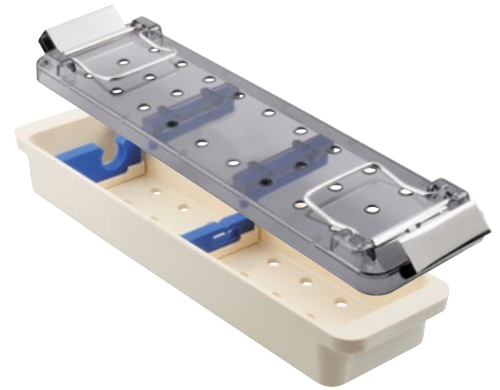

600-505-002

Endoscopes	max. 2
Endoscope length	max. 190mm
Dimensions	271 x 70 x 35mm

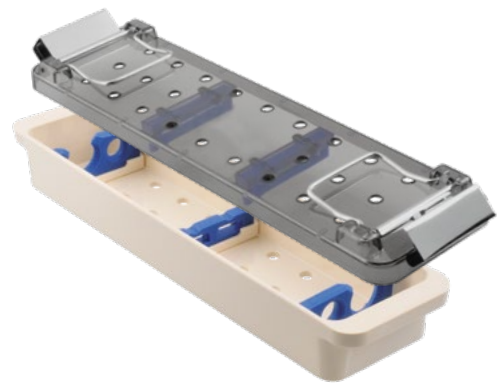

600-506-002*

Endoscopes	max. 2
Endoscope length	max. 390mm
Dimensions	394 x 70 x 35mm

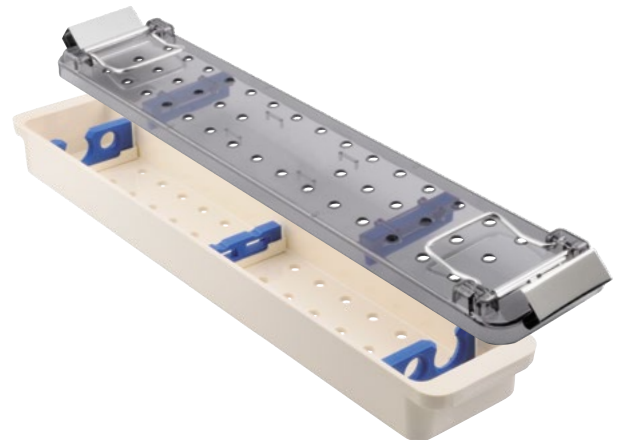

600-501-000

Endoscopes 1

600-501-002

Endoscopes max. 2

Endoscope length	max. 450mm
Dimensions	457 x 70 x 35mm

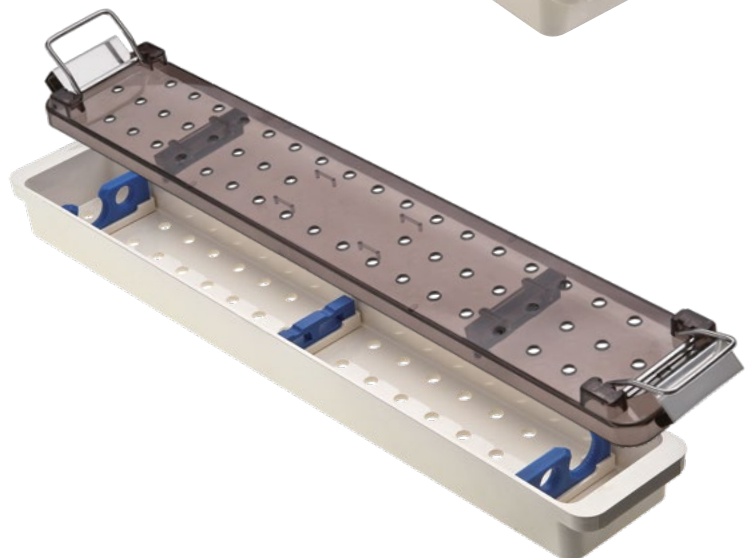

ENDOSCOPE & INSTRUMENT CONTAINERS

600-508-000	for scopes and light guide cables
Endoscopes	max. 3 (Ø 5-10mm)
Fiber Optic Light Cable	1
Endoscope length	max. 450mm
Dimensions	465 x 212 x 51mm

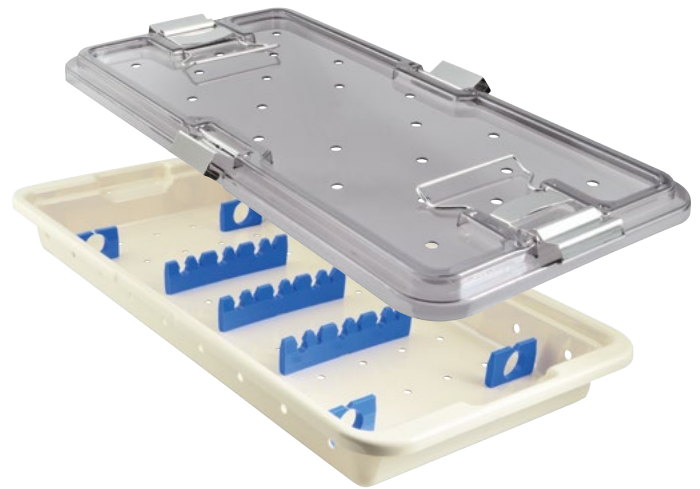

600-464-229	for fixation of instruments with rubber ties
Dimensions	464 x 229 x 51mm

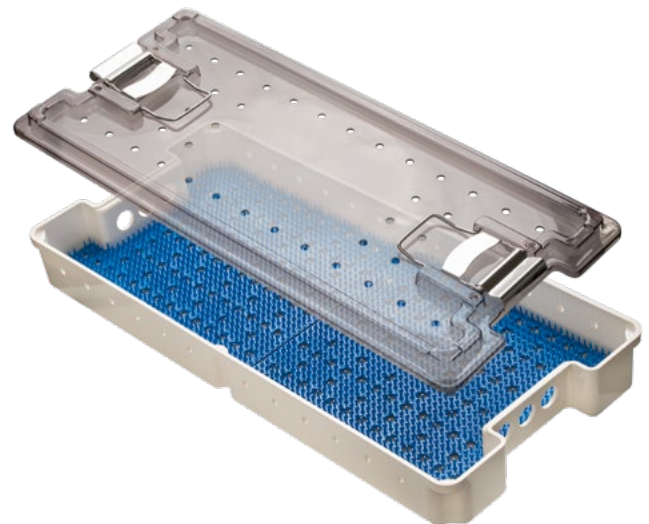

600-511-000	for instruments with rubber ties on 2 levels
Dimensions	502 x 239 x 102mm



ENDOSCOPE CLEANING BASKETS & CONTAINERS with silicone bars on base and lid

600-292-052*

Endoscopes	max. 2
Endoscope length	max. 190mm
Dimensions	290 x 80 x 52mm

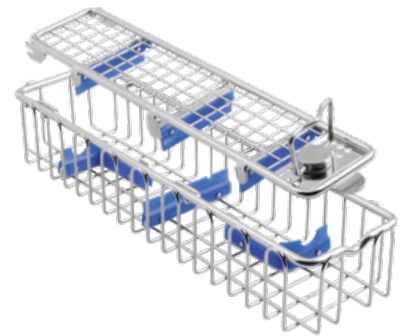

600-462-052*

Endoscopes	max. 2
Endoscope length	max. 350mm
Dimensions	460 x 80 x 52mm

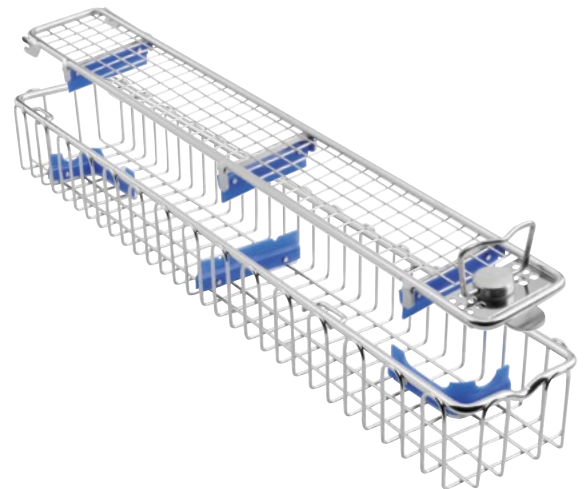

600-460-055	Endoscopes 1
600-460-056	Endoscopes max. 2
Endoscope length	max. 340mm
Dimensions	455 x 86 x 43mm

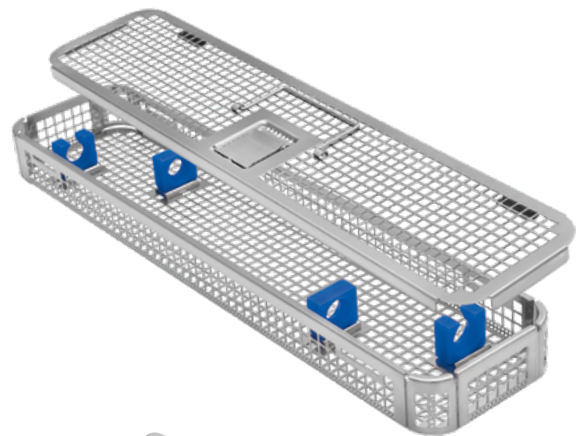

600-450-070

Endoscopes	max. 2
Endoscope length	max. 330mm
Dimensions	450 x 70 x 70mm

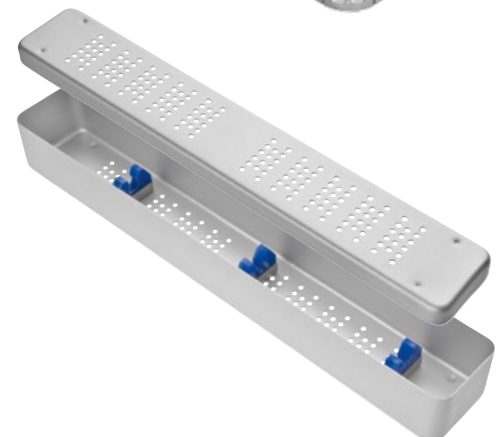

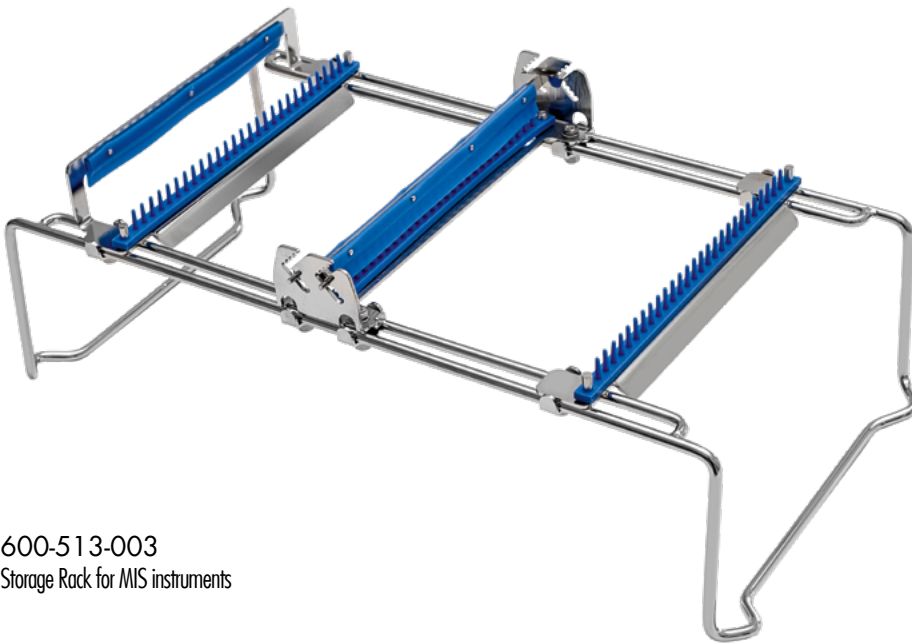

600-513-003
Storage Rack for MIS instruments

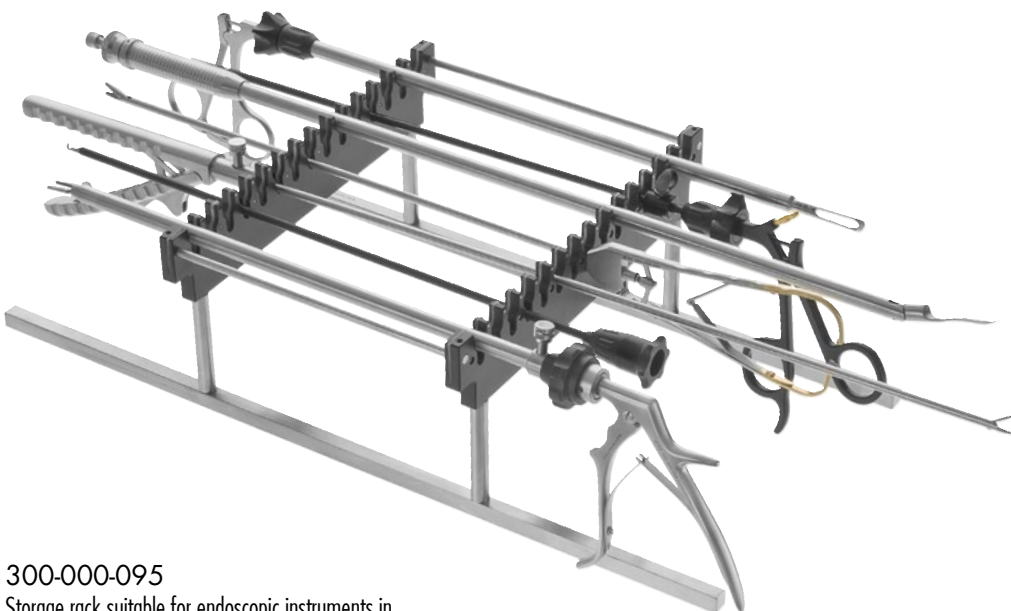

300-000-095
Storage rack suitable for endoscopic instruments in
Standard Container "Safety Model"
(without Instruments)

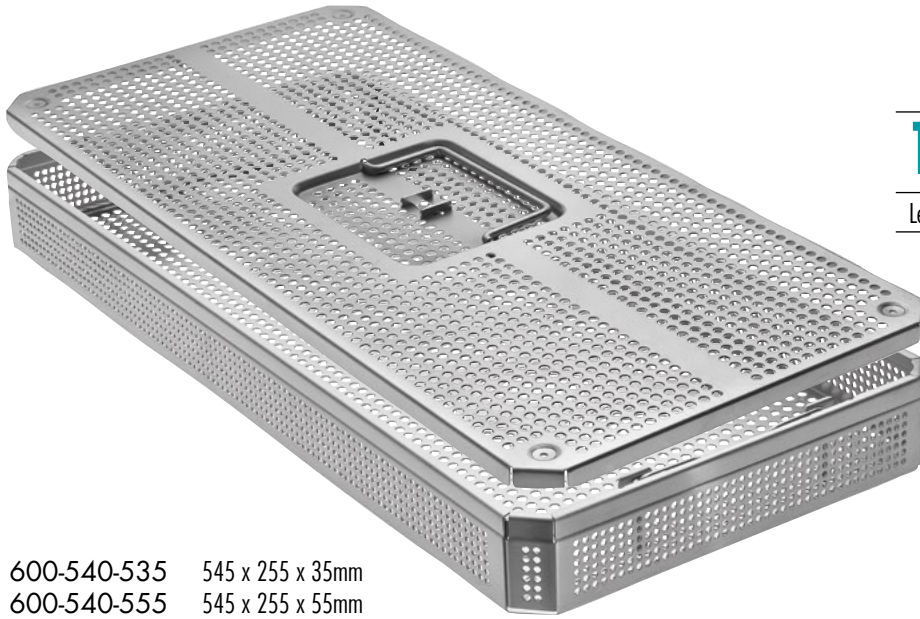

1/1

Stainless Steel Basket,
round perforation, with lid

Length

545mm

- 600-540-535 545 x 255 x 35mm
- 600-540-555 545 x 255 x 55mm
- 600-540-575 545 x 255 x 75mm
- 600-540-605 545 x 255 x 105mm



- Lid only
- 600-540-500 545 x 255 mm



- Bottom only
- 600-540-530 545 x 255 x 30mm
- 600-540-550 545 x 255 x 50mm
- 600-540-570 545 x 255 x 70mm
- 600-540-600 545 x 255 x 100mm

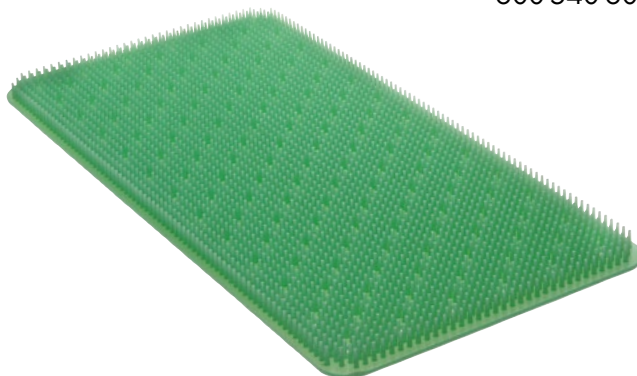

- 600-281-004 Silicone Mat green, 520 x 230mm

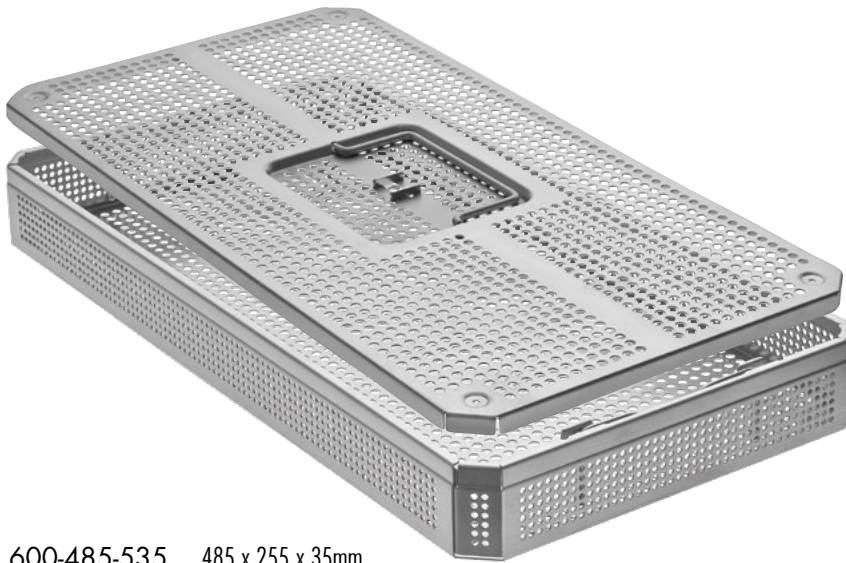

1/1

Stainless Steel Basket,
round perforation, with lid

Length

485mm

600-485-535 485 x 255 x 35mm
 600-485-555 485 x 255 x 55mm
 600-485-575 485 x 255 x 75mm
 600-485-605 485 x 255 x 105mm



Lid only
 600-485-500 485 x 255 mm

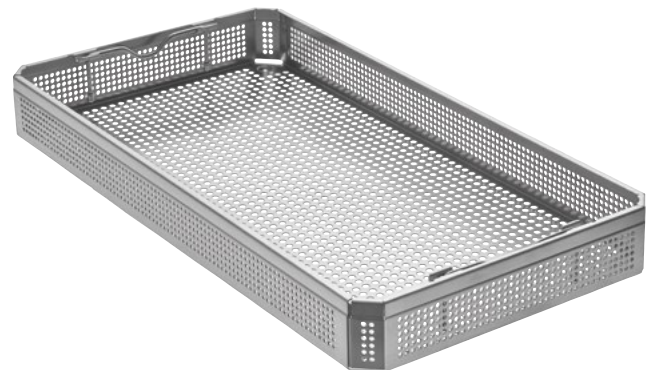

Bottom only
 600-485-530 485 x 255 x 30mm
 600-485-550 485 x 255 x 50mm
 600-485-570 485 x 255 x 70mm
 600-485-600 485 x 255 x 100mm



600-281-003 Silicone Mat green, 440 x 230mm

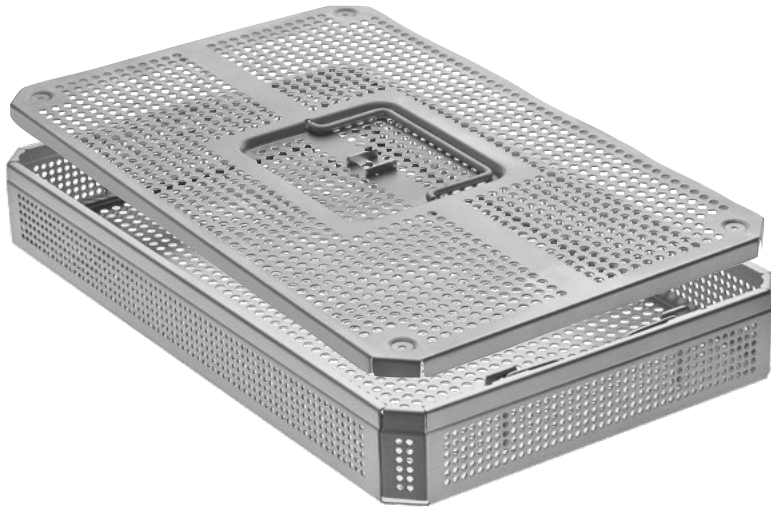

3/4

Stainless Steel Basket,
round perforation, with lid

Length

405mm

600-405-535 405 x 255 x 35mm
 600-405-555 405 x 255 x 55mm
 600-405-575 405 x 255 x 75mm
 600-405-605 405 x 255 x 105mm

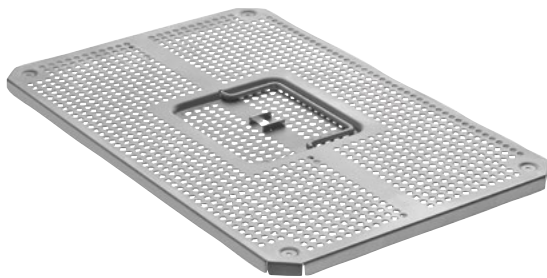

Lid only
 600-405-500 405 x 255 mm

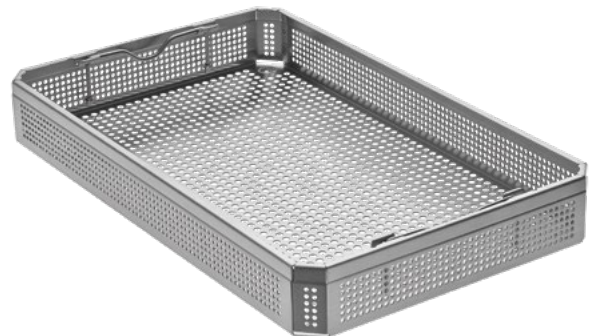

Bottom only
 600-405-530 405 x 255 x 30mm
 600-405-550 405 x 255 x 50mm
 600-405-570 405 x 255 x 70mm
 600-405-600 405 x 255 x 100mm

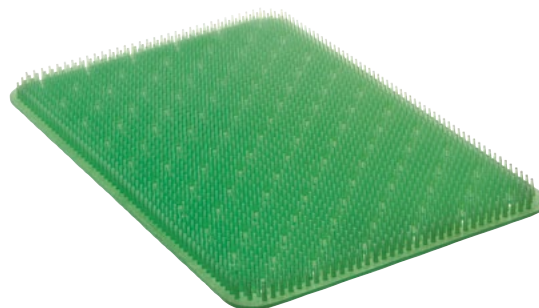

600-281-002 Silicone Mat green, 380 x 230mm



1/2

Stainless Steel Basket,
round perforation, with lid

Length

255mm

600-255-535 255 x 245 x 35mm
 600-255-555 255 x 245 x 55mm
 600-255-575 255 x 245 x 75mm
 600-255-605 255 x 245 x 105mm

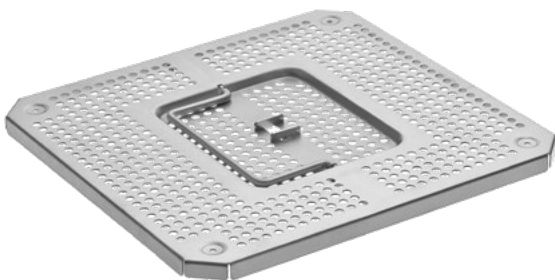

Lid only

600-255-500 255 x 245 mm



Bottom only

600-255-530 255 x 245 x 30mm
 600-255-550 255 x 245 x 50mm
 600-255-565 255 x 245 x 70mm
 600-255-600 255 x 245 x 100mm



600-281-001 Silicone Mat green, 220 x 230mm



SIZE (LXWXH)



580 x 280 x 100mm	● 600-580-101	600-579-101
	● 600-580-102	600-579-102
	● 600-580-103	600-579-103
	● 600-580-104	600-579-104
	● 600-580-105	600-579-105
	● 600-580-106	600-579-106



580 x 280 x 135mm	● 600-580-131	600-579-131
	● 600-580-132	600-579-132
	● 600-580-133	600-579-133
	● 600-580-134	600-579-134
	● 600-580-135	600-579-135
	● 600-580-136	600-579-136



580 x 280 x 150mm	● 600-580-151	600-579-151
	● 600-580-152	600-579-152
	● 600-580-153	600-579-153
	● 600-580-154	600-579-154
	● 600-580-155	600-579-155
	● 600-580-156	600-579-156



580 x 280 x 200mm	● 600-580-201	600-579-201
	● 600-580-202	600-579-202
	● 600-580-203	600-579-203
	● 600-580-204	600-579-204
	● 600-580-205	600-579-205
	● 600-580-206	600-579-206



580 x 280 x 260mm	● 600-580-261	600-579-261
	● 600-580-262	600-579-262
	● 600-580-263	600-579-263
	● 600-580-264	600-579-264
	● 600-580-265	600-579-265
	● 600-580-266	600-579-266

SIZE (LXWXH)



465 x 280 x 100mm

●	600-469-101	600-470-101
●	600-469-102	600-470-102
●	600-469-103	600-470-103
●	600-469-104	600-470-104
●	600-469-105	600-470-105
●	600-469-106	600-470-106



465 x 280 x 135mm

●	600-469-131	600-470-131
●	600-469-132	600-470-132
●	600-469-133	600-470-133
●	600-469-134	600-470-134
●	600-469-135	600-470-135
●	600-469-136	600-470-136



465 x 280 x 150mm

●	600-469-151	600-470-151
●	600-469-152	600-470-152
●	600-469-153	600-470-153
●	600-469-154	600-470-154
●	600-469-155	600-470-155
●	600-469-156	600-470-156

SIZE (LXWXH)



285 x 280 x 100mm	●	600-280-101	600-279-101
	●	600-280-102	600-279-102
	●	600-280-103	600-279-103
	●	600-280-104	600-279-104
	●	600-280-105	600-279-105
	●	600-280-106	600-279-106



285 x 280 x 135mm	●	600-280-131	600-279-131
	●	600-280-132	600-279-132
	●	600-280-133	600-279-133
	●	600-280-134	600-279-134
	●	600-280-135	600-279-135
	●	600-280-136	600-279-136



285 x 280 x 150mm	●	600-280-151	600-279-151
	●	600-280-152	600-279-152
	●	600-280-153	600-279-153
	●	600-280-154	600-279-154
	●	600-280-155	600-279-155
	●	600-280-156	600-279-156



285 x 280 x 200mm	●	600-280-201	600-279-201
	●	600-280-202	600-279-202
	●	600-280-203	600-279-203
	●	600-280-204	600-279-204
	●	600-280-205	600-279-205
	●	600-280-206	600-279-206



285 x 280 x 260mm	●	600-280-261	600-279-261
	●	600-280-262	600-279-262
	●	600-280-263	600-279-263
	●	600-280-264	600-279-264
	●	600-280-265	600-279-265
	●	600-280-266	600-279-266



Identification label, 100 pieces per package

① 600-908-100 STANDARD

② 600-908-000 SMALL



600-909-000
Plastic security seal,
100 pieces per package



Identification label

with hole for snap hook

56x17mm

50x17mm

	56x17mm	50x17mm
unmarked	600-900-040	600-900-041
	600-900-050	600-900-051
	600-900-060	600-900-061
	600-900-070	600-900-071
	600-900-080	600-900-081
	600-900-090	600-900-091
	600-900-100	600-900-101
	600-900-108	600-900-109
marked	600-900-110	600-900-111
	600-900-120	600-900-121
	600-900-130	600-900-131
	600-900-140	600-900-141
	600-900-150	600-900-151
	600-900-160	600-900-161

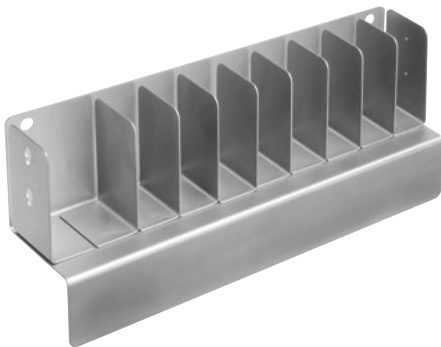

600-900-210

Dispenser for identification labels
(8 small compartments and 1 double compartment)
as table or wall model



600-380-100

PTFE (TEFLON) Filter, round, STANDARD



600-290-630

Filter Dispenser for disposable Filter,
round, 195x195mm



600-100-000
RZ-Aquajet
Water Jet Pistol complete
with 9 tips and 1m pressure
tubing, with strap and
suspension hook



600-050-000
Hand brush, autoclavable
(10 pcs. per box)



600-950-100
RZ - Brush dispenser
for 10 brushes with suspension hook



700-900-220 Special Cotton for polishing metal sheaths and instruments



700-900-160
Instrument Oil in 50ml bottle



700-900-250
Oil Dispenser, 140mm



Cleaning brush (1 piece per box), 500mm length
300-135-905 for \varnothing 5 mm
300-135-910 for \varnothing 10 mm



300-215-000 Cleaning Brush, \varnothing 13mm, 215mm length, 60mm brush length



300-420-065 Cleaning Brush, \varnothing 3mm, 420mm length, 65mm brush length

DEVICES



INSUFFLATOR



Features:

- User-friendly interface
- Highest safety standard for patients
- All units are available with or without CO₂ heating system
- Pre-insufflation mode for use with Verres Cannulas
- Non-heating unit have the same gasflow rates as heating unit models

DELIVERY CONTAINS:

- Main Unit (300-900-020/-021/030/-031/-040/-041)
- Sterile Filter (300-902-007)* (TP Product)
- Wrench Set (300-902-006)
- CO₂ High Pressure Tube (300-902-003)
- Standard Silicone Tube (300-902-005)
- Silicone Tube (300-902-004), only Heater-Version
- Gas Heater with tube (300-902-001), only Heater-Version
- Operating manual
- Mains cable

Airflow Insufflator A2/A3/A4

- 300-900-020 20L/min
- 300-900-021 20L/min, with heating unit
- 300-900-030 30L/min
- 300-900-031 30L/min, with heating unit
- 300-900-040 45L/min
- 300-900-041 45L/min, with heating unit

Technical data

Line voltage	100-240 VAC
Power consumption	25 - 40W 25-105W (with gas heating) max. 0.4A (max. 1A with gas heating)
Frequency	50 - 60Hz
Insufflation pressure	1 - 30mmHG
Gas flow	1-20L/min (300-900-020 / -021) 1-30L/min (300-900-030 / -031) 1-45L/min (300-900-040 / -041)

Gas connection	UNF 7/16" male
Gas type	Medical Grade Carbon Dioxide
Dimensions	380 x 120 x 360 mm (WxHxD)
Weight	11kg



Insufflation needle, matt chrome, Ø 2 mm

- 300-195-080 80 mm
- 300-195-100 100 mm*
- 300-195-120* 120 mm*
- 300-195-150 150 mm*
- 300-195-170 170 mm
- 300-195-200 200 mm

Insufflation needle, polished chrome, Ø 2.7 mm, High-Flow

- 300-195-300 100 mm
- 300-195-320 120 mm*
- 300-195-350 150 mm*
- 300-195-370 170 mm*

* standard length

Accessories (included):



Wrench Set (SW30/SW17)
300-902-006



Sterile Filter*
300-902-007



Standard Silicone Tube
300-902-005



Gas heater with tube (only Heater-Version)
300-902-001



CO2 High Pressure Tube
300-902-003



Silicone Tube (only Heater-Version)
300-902-004



Optional available:
300-902-008
CO2 Bottle, 0.75kg, empty

* Trade Product:
Products marked with this TradeProduct-Symbol are not available with RZ-Marking and not with the CE-number of RZ.

SUCTION & IRRIGATION PUMP

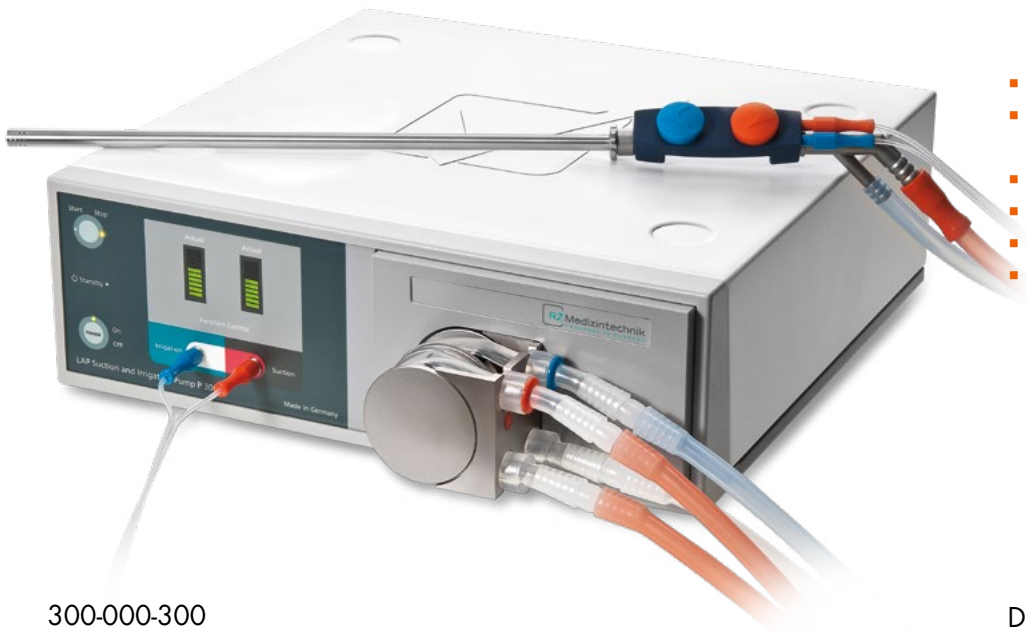

Features:

- Double roll pump for precise suction and irrigation during Laparoscopic surgeries
- Optional footswitch available
- Digital display of actual suction and irrigation pressures
- High flow rates up to 3L/min
- Color coded tubing sets
- Standby function
- Hand remote controlled

DELIVERY CONTAINS:

- Pump device (300-000-300)
- Cannula 5mm (300-000-302)
- Cannula 10mm (300-000-303)
- Silicone Tubing Set (300-000-301)
- Tube Adapter (300-000-304)
- Pneumatic Control Handle (300-000-305)
- Double-Lumen Control Tube (300-000-306)
- Mains cable
- 2 Spare fuses
- Operating manual

300-000-300

LAP Suction and Irrigation Pump P 3000, complete set

Technical data

Line voltage	100-240 VAC
Power input	36W
Irrigation power	0 - 3.000ml/min
Suction power	0 - 3.000ml/min
Max. pressure	0 - 750mmHg
Measurements	380 x 130 x 400mm (WxHxD)
Weight	approx. 11kg

Accessories



300-000-304

Adapter with instrument connector, autoclavable

300-000-307

Pneumatic double footswitch

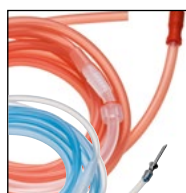

300-000-301 (included)

Tubing Set, non-sterile, autoclavable

300-000-301S (optional)

Tubing Set, single-use, sterile, moq: 50 pcs.

SUCTION & IRRIGATION PUMP

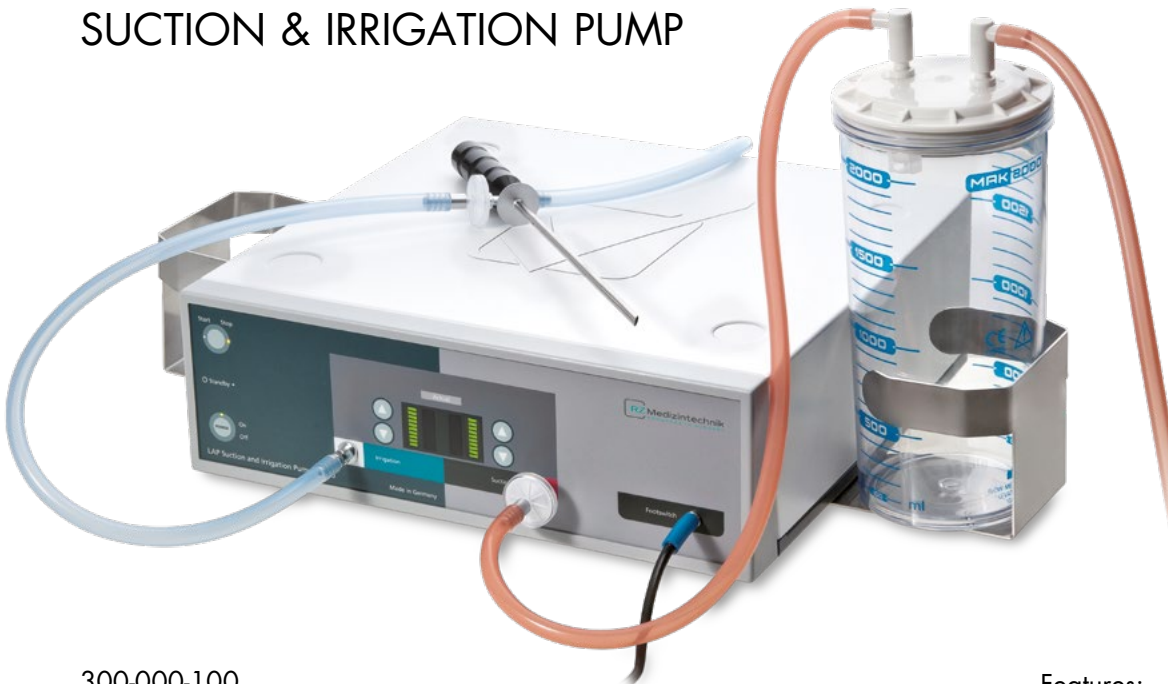

300-000-100
LAP Suction and Irrigation Pump P1000, complete set

Technical data

Line voltage	100-240 VAC
Power input	80VA
Irrigation power	3L/min
Suction power	3L/min
Max. vacuum	- 525mmHG
Max. pressure	0 - 750mmHG
Measurements	380 x 120 x 360mm (WxHxD) with Aspiration Bottle Retainers approx. 440 x 120 x 360mm
Weight	Device: approx. 11kg Aspiration Bottle-Retainer: (for 1 Liter = 0.34kg, for 2 Liter = 0.44kg)

Features:

- Dual suction and irrigation vacuum pump
- Digital display of suction and irrigation pressures
- High rates up to 3L/min
- Color coded tubing sets
- Standby function
- Low noise level
- Hydrophobic disposable filters

DELIVERY CONTAINS:

- Pump device (300-000-100)
- Suction and irrigation tubing set (300-000-102)
- Aspiration bottle 2L with overflow valve (300-000-101)
- Puncture tube 235mm (300-001-521)
- 2 Hydrophobic disposable sterile filters (300-000-103)
- 2 Bottle holders with screws
- Mains cable
- 2 Spare fuses
- Operating manual

Accessories (optional available)



300-000-110
Start/Stop - Footswitch

4K CAMERA SYSTEM



Features:

- 4K UHD resolution with 3-chip technology
- Image algorithm enhancement of color and structure
- 4K video recording
- 4K image saving
- Camera head with 4 programmable buttons
- Boost function
- Fog reduction
- Freeze function
- 2.5x digital zoom
- 10 USER mode configurations
- Multilingual on screen menu
- SDI 4K Output
- Text generator (optional with keyboard)

300-001-840 4K 3-Chip UHD-Camera K 4000

DELIVERY CONTAINS:

- Main Unit (300-001-840)
- Camera head (300-001-841)
- HDMI cable
- USB Pen Drive
- Mains cable
- Operating manual

4K

Technical data

Line voltage	100-240 VAC
Power consumption	60VA
Image sensor	3 MOS
Resolution	3840 x 2160 pixels (4K)
Index ratio	16:9
N/N ratio	54db

Video outputs	1x HDMI 4K 1x HDMI FullHD 1x SDI 4K 1x SDI FullHD
Dimensions	Control unit: 355 x 103 x 350mm (WxHxD) Weight control unit: 6.2kg Weight camera head: 145g

Accessories



300-001-841
UHD 3-Chip Camera Head
(included in the set)



300-001-615
Title generator keyboard, waterproof IP68
US-Layout, cable 1.8m, color: grey,
305x140x15mm, 600gr.



300-001-610
Footswitch for HD Cameras
cable length: 2m

FULL HD CAMERA SYSTEM



Features:

- Full HD camera with 3-chip MOS technology
- Pure Natural Colors technology
- Full HD video recording (F4 only)
- Full HD image saving (F4 only)
- Camera head with 3 programmable buttons
- Boost function
- Freeze function
- 2.5x digital zoom
- 3 USER mode configurations
- Multilingual on screen menu
- Different digital video outputs
- Text generator (optional with keyboard)

300-001-800 3 Chip HD-Camera F3
 300-001-804 3 Chip HD-Camera F4 (with recording function)

FULL HD

Technical data

Line voltage	100-240 VAC
Power input	20W
Image sensor	3 MOS
Resolution	1920 x 1080 pixels (FullHD)
Image resolution	>1000 TV lines, horizontal
Index ratio	16:9
Min. sensitivity	< 3lx (1/1.4)
Shutter speed	1/50 (1/60) to 1/100.000sec

Video outputs (F4)	2 x HD SDI 1x HDMI / DVI 2x CVBS 1 x YPbPr / RGB 1 x Y/C (Pal/NTSC) 1x CVBS (Pal/NTSC)
Video outputs (F3)	1 x HDMI / DVI 1 x YPbPr (Component) 1 x Y/C (Pal/NTSC) 1x CVBS (Pal/NTSC)
Dimensions	Control unit: 380 x 120 x 360mm (WxHxD) Weight control unit: 11kg Weight camera head: 145g

Accessories



300-001-802
 High-End 3-MOS Camera Head
 FullHD (included in the set)



300-001-615
 Title generator keyboard, waterproof IP68
 US-Layout, cable 1.8m, color: grey,
 305x140x15mm, 600gr.



300-001-610
 Footswitch for HD Cameras
 cable length: 2m

FULL HD CAMERA SYSTEM



Features:

- Full HD camera with 1-chip MOS technology
- Natural color technology
- Full HD video recording (F2 Pro only)
- Full HD image saving (F2 Pro only)
- Camera head with 3 programmable buttons
- Boost function
- Freeze function
- 2.5x digital zoom
- 3 USER mode configurations
- Multilingual on screen menu
- HDMI video outputs
- Text generator (optional with keyboard)

- 300-001-600 HD-Camera F1
 300-001-601 HD-Camera F2 Pro (with recording function)

DELIVERY CONTAINS:

- Main Unit
- Camera head
- 2x BNC cable
- HDMI - DVI cable
- HDMI cable
- S-Video cable
- USB Pen Drive (F2 Pro only)
- Operating manual
- Mains cable

FULL HD

Technical data

Line voltage	100-240 VAC
Power input	F2 Pro: 30W / F1: 20W
Image sensor	1/3" MOS
Resolution	1920 x 1080 pixels (FullHD)
Image resolution	>1000 TV lines, horizontal
Index ratio	16:9
Min. sensitivity	< 3lx (1/1.4)

Video outputs (F2 Pro)	2 x HD SDI (optional) 1 x HDMI / DVI 1 x Y-Pb-Pr (Component) 1 x Video (PAL/NTSC) 1 x S-Video (PAL/NTSC)
Video outputs (F1)	1 x HDMI 1 x YPbPr / RGB 1 x S-Video (Y/C; Pal / NTSC) 1 x Video (CVBS; Pal / NTSC)
Dimensions	Control unit: 380 x 120 x 360mm (WxHxD) Weight control unit: 11kg Weight camera head: 105g

Accessories



300-001-602
 High-End 1/3" MOS Camera Head
 Full HD (included in the set)



300-001-615
 Title generator keyboard, waterproof IP68
 US-Layout, cable 1.8m, color: grey,
 305x140x15mm, 600gr.



300-001-610
 Footswitch for HD Cameras
 cable length: 2m

TV COUPLER



4K
FULL HD

300-001-823 f=14mm
300-001-824 f=25mm
300-001-825 f=28mm
c-mount, soakable



4K
FULL HD

250-015-030
Zoom-TV-Adapter
f=15 - 30mm
c-mount, soakable



4K
FULL HD

250-015-036
Zoom-TV-Adapter
f=15 - 36mm
c-mount, soakable



FULL HD

300-001-813 f=14mm
300-001-814 f=25mm
c-mount, soakable



FULL HD

250-020-025 F=25mm (splitting 90/10)
250-020-030 F=30mm (splitting 90/10)
Beamsplitter, allows simultaneous video
and direct views, c-mount, soakable

RZ MEDIA WORKSTATION Innovative Documentation System – the stand alone “all in one” solution

Sophisticated users get a comprehensive tool for creating, documenting and archiving of videos, pictures and findings.

An extensive set of tools gives the ability for easy creation of individual and complex findings reports. Easy integration into IT-environment ensures an optimal workflow. The database provides long-term availability of picture findings with almost no capacity limitation.

Diagnostics & Results

- Recording of videos and pictures
- PACS support DICOM worklist/store
- Playing videos with abstraction of individual images
- Manual input of comments and markers for sessions and recordings
- Graphical markers with individual comments
- Creation of reports incl. patient information, pictures, videos and comments
- Full-text search in data base
- User management including import, adaption and export of patients
- LIVE OR communication via e.g. Zoom, Skype or Teams
- Hospital Safety guidelines
(Windows based network and firewall)



Documentation System 21" touch

300-001-199 OR version with DICOM worklist

300-001-198 without DICOM worklist



LED LIGHT SOURCE



Features:

- 6500K daylight color temperature
- 375 Watt equivalent output power
- > 20.000 hours lifetime
- Turret connector for the most common light cables (Olympus, Wolf, Gyrus ACMI, Storz)
- Manual or automatic light control
- Waterproof touch control panel
- Low heat conduction by improved LED technology
- Boost function: light increase of 20%

300-900-300 LUMEN LED 3 PRO Light Source, 110 - 230V



Technical data

Line voltage	100-240 VAC
Video input	1x Video, BNC
Protection class	1 (acc. IEC 60601-1) 1 (acc. MDD 93/42/EEC)
Safety class	BF
Standard	IEC 60601-1-2
Dimensions	380 x 120 x 360mm (WxHxD)
Weight	approx. 11kg

DELIVERY CONTAINS:

- Main Unit (300-900-300)
- BNC cable (optional)
- Mains cable
- Operating manual



A OLYMPUS

B WOLF

C GYRUS ACMI

D STORZ
KARL STORZ ENDOSKOP

Turret, multi connector

LED LIGHT SOURCE



Features:

- More than 20.000h lamp lifetime
- 180 Watt equivalent power output
- Manual or automatic light control
- Waterproof touch control panel
- Low heat conduction by improved LED technology
- Daylight color temperature 6000 – 6500° K for accurate color representation
- Boost function: light increase of 20%

300-900-180 LUMEN LED 1 Light Source



DELIVERY CONTAINS:

- Main Unit (300-900-180)
- BNC cable
- Mains cable
- Operating manual

Technical data

Line voltage	100-240 VAC
Power consumption	130VA
Video input	1x Video, 1x S-Video (Y/C) (automatic version only)
Protection class	1 (acc. IEC 60601-1) 1 (acc. MDD 93/42/EEC)
Safety class	BF
Dimensions	380 x 120 x 360mm (WxHxD)
Weight	approx. 11kg

HIGH TEMPERATURE LED/XENON LIGHT CABLES



250-042-000
250-042-400 for ICG/NRI
RZ/Storz/Olympus



250-040-000
Wolf



250-041-000
ACMI/British Standard

250-025-230	∅ 2.5mm, 2300 mm
250-025-300	∅ 2.5mm, 3000 mm
250-035-180	∅ 3.5mm, 1800 mm
250-035-230	∅ 3.5mm, 2300 mm
250-035-300	∅ 3.5mm, 3000 mm
250-048-180	∅ 4.8mm, 1800 mm
250-048-230	∅ 4.8mm, 2300 mm
250-048-300	∅ 4.8mm, 3000 mm



250-039-000
250-039-400 for ICG/NRI
RZ/Storz



250-038-000
ACMI/CUDA



250-048-000
Luxtec



250-051-000
Stryker



250-037-000
250-037-400 for ICG/NRI
Wolf



250-044-000
Olympus



250-045-000
Olympus - Standard



250-052-000
Heine



250-059-000
Pentax

ICG/NIR LIGHT CABLE



250-048-234
LED High Transmission Fibre Optic Light Guide Cable
∅ 4.8mm, 2300mm, without adaptor

COMPATIBILITY NOTE:

A fiber optic cable with a large diameter should not be connected to a smaller diameter scope.
For example: ∅ 4.8mm fiber optic cables connected to a ∅ 2.9mm may risk high temperature at the light entry of the endoscope and may risk patient safety.

ELECTROSURGICAL GENERATOR



Features:

- Monopolar/bipolar cutting and coagulation
- Automatic identification of connected instruments
- Powerstart System simplifies the beginning of cutting process
- Automatic power regulation
- 105 different memory locations in 7 groups
- Various output configuration of the sockets available
- 10" Touchscreen
- Tiltable display
- Footswitch (optional)
- Available with Argon and / or the RZeal
- Real-time output monitoring

DELIVERY CONTAINS:

- Main Unit
- Mains Cable
- (Footswitch not included)

700-350-400 230V
 700-350-410 110V
 G400 ElectroSurgical Generator

Technical data

Line voltage	110-230 VAC
Power consumption	500W
Generator operation frequency	333kHz
Display	TFT 10"
Defibrillation impulse resistance	acc. to EN 60601-1
NEM system	neutral electrode control optical indication 7 levels required resistance < 240 Ω
Gas type	pure argon 4.8 (99,998%) or higher
Inlet gas pressure	0.25-0.4 [MPa]
Monopolar coagulation / cutting	200W / 400W
Bipolar coagulation / cutting	400W / 400W

Gas outflow	0.1-10 l/min, regulated 0.1 l/min in whole range
Pressure range	reducer (0.4 MPa) on argon cylinder
Vessel sealing system	9 effects/300W
AutoStop	automatic stop of sealing process after achieving the optimal effect
Dimensions	495 x 415 x 225mm (LxWxH)
Weight	12.2kg

Accessories



700-350-405
 2-Button-Footswitch, length: 5m
 700-350-402
 3-Button-Footswitch, length: 5m, quick access key



Disposable Neutral Electrode
 hydrogel, split, for adults or children
 10x5 pcs. per package
 700-503-000 Adults
 700-503-001 Children



Cable for Disposable Neutral Electrode
 5m, RZ compatible only
 700-503-003

ELECTROSURGICAL GENERATOR



700-340-400 230V
 700-340-410 110V
 G44 Electrosurgical Generator

Technical data

Line voltage	110-240 VAC
Power consumption	1100VA
Generator operation frequency	333kHz
Display	TFT 7" WVGA
Spectrum result system	automatic power regulation
Monopolar coagulation	max. 200W (200Ω)
Monopolar cutting	max. 400W (100Ω)
Bipolar coagulation	max. 400W (25Ω)
Bipolar cutting	max. 330W (150Ω)

Features:

- Monopolar/bipolar cutting and coagulation
- Automatic instrument detection system
- Intuitive Touchscreen
- Automatic power regulation
- Configurable working modes
- Real-time parameter control
- Special endoscopic modes
- Bipolar resection
- Easy software update

DELIVERY CONTAINS:

- Main Unit
- Mains Cable
- (Footswitch not included)

NEM system	neutral electrode control, optical indication, required resistance < 240 Ω
Dimensions	385 x 305 x 141mm (LxWxH)
Weight	7kg

Accessories



700-350-405
 2-Button-Footswitch, length: 5m

700-350-402
 3-Button-Footswitch, length: 5m, quick access key



Disposable Neutral Electrode hydrogel, split, for adults or children
 10x5 pcs. per package
 700-503-000 Adults
 700-503-001 Children



Cable for Disposable Neutral Electrode
 5m, RZ compatible only
 700-503-003



300-001-168
Endovue 32" HD Monitor

300-001-158
Endovue 24" HD Monitor

Technical data

Screen size	31.5" / 24" diagonal
Resolution	1920 x 1080
Aspect ratio	16:9
Viewing angle	178°
Numbers of colors	16.7 Million (8-bit)
Video Inputs	DVI-D, RGBS/VGA/YPbPr (HD-15 or DVI-I via adapter), S-Video, Composite
Video Outputs	DVI-D
Weight	8.8kg (300-001-168) 6.7kg (300-001-158)



300-001-232
Radiance 32" HD Monitor

300-010-226
Radiance 27" HD Monitor

Technical data

Screen size	32" / 27" diagonal
Resolution	1920 x 1080
Aspect ratio	16:9
Viewing angle	178°
Numbers of colors	1.07 Billion (10-bit)
Video Inputs	DVI-I and 3G-SDI Input/Output
Video Outputs	DVI-D
Weight	11.0kg (300-001-232) 8.9kg (300-010-226)



300-001-031
UHD 4K Monitor, 31"

Technical data

Screen size	31" diagonal
Resolution	4096 x 2160
Aspect ratio	17:9
Viewing angle	178°
Number of colors	1.08 Billion (10-bit)
Video Inputs	1 x HDMI 2.0 1 x DP 1.2 (SST) & 1 x DP 1.2 (MST) 1 x DVI (single link), 4 x SDI (3G)
Video Outputs	1 x DP 1.2 (SST) 1 x DVI (single link), 4 x SDI (3G)
Weight	10.5kg



300-001-055
UHD 4K Monitor, 55"

Technical data

Screen size	55" diagonal
Resolution	3840 x 2160
Aspect ratio	16:9
Viewing angle	178°
Numbers of colors	1.08 Billion (10-bit)
Video Inputs	1 x HDMI 2.0, 2 x DP 1.2 (55T) 1 x DVI (single link), 2 x DVI (dual link) 4 x SOi (3G), 2 x SOi (12G)
Video Outputs	1 x DVI (single link), 1 x DP 1.2 (SST) 4 x SDI (3G), 2x SDI (12G)
Weight	37.35kg



300-001-028
Monitor Table Stand

Technical data

Column height	305mm, 12"
Oriantations	Landscape or page mode
Adjustments	+/- 20°
Max. load	31" / 13.6kg / 30lbs

All monitors will be delivered without table stand - need to be ordered separately.

RZ TROLLEY

- Optional doors and rear panel in order to protect valuable equipment
- Optional main on/off switch
- Power columns for cables
- Endoscope Holder
- Variable height support arms
- Conductive rolls

DIMENSIONS
1600 x 500 x 625mm
Rollers: Ø 125mm

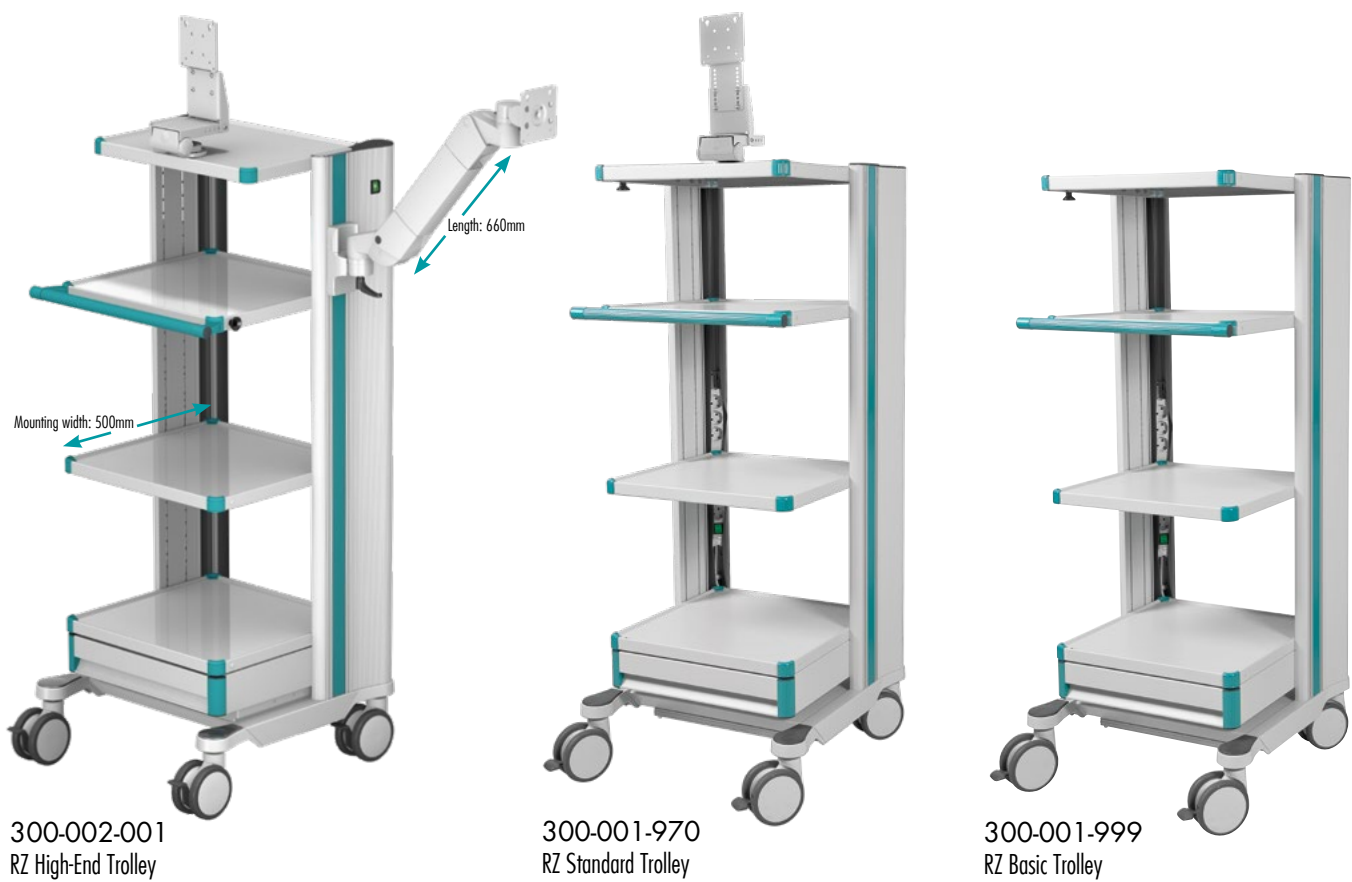



300-001-988
Hydraulic monitor holding, 660mm

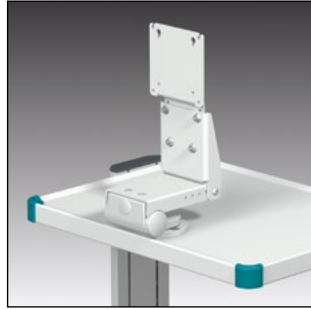

300-001-989
Monitor Shelf with adjustable monitor holding VESA 75/100 up to 14kg

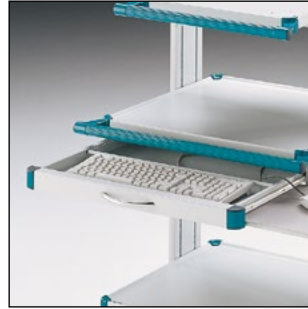

300-001-986
Keyboard Holder



300-001-990
Camera Head Holder with cable suspension



300-001-980 3/5/10 L
300-001-982 20/50 L
CO₂ Bottle Holder

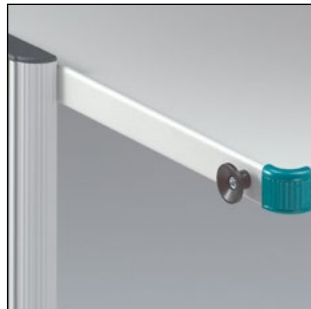

300-001-979
Camera Holder



300-001-978
Cable Holder



300-001-991
Computer Holder, load capacity max. 20kg



300-001-983
Rear Panel



300-001-985
Additional Shelf

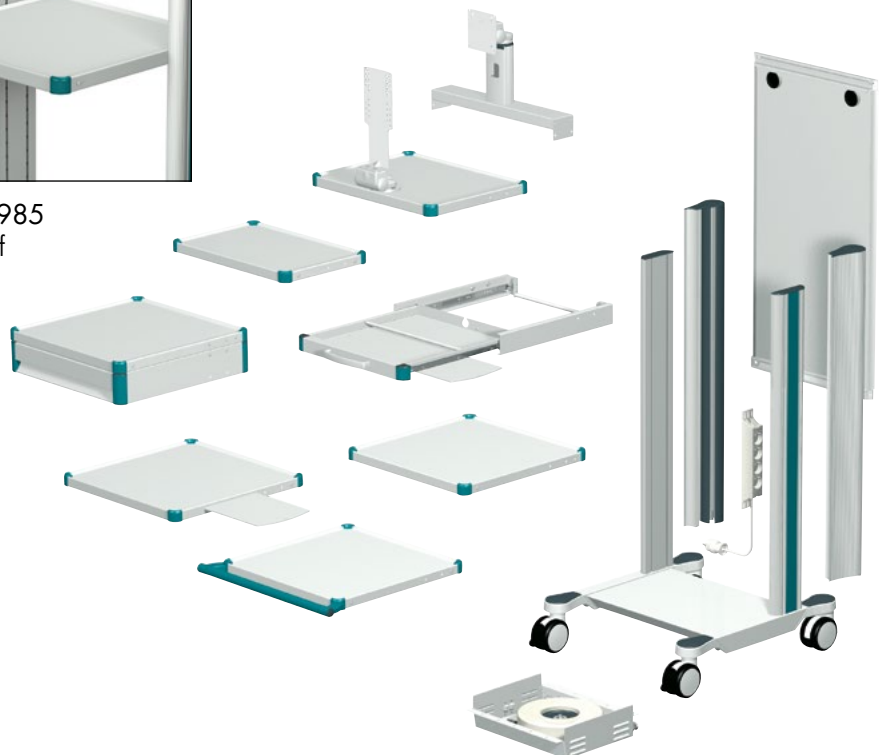

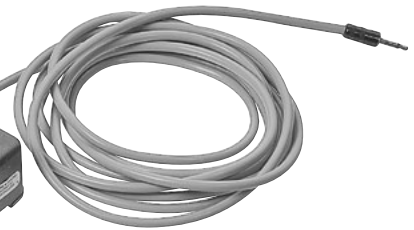

700-999-000 RZ Insulation & Continuity Tester complete, including accessories, carrying case and foot control

SPARE PARTS



700-999-009 Test Plate



700-999-004 Cable male-female



700-999-007 Brush Test Electrode



700-999-010 Foot pedal



700-999-006 Adapter male-alligator



250-930-100 Fiber optic Light cable Testing Unit
for RZ - Fiber optic Light Cables

Fiber optic Cable Testing Unit

250-930-103 for WOLF - Fiber optic Lightcable

250-930-104 for ACMI - Fiber optic Lightcable

250-930-105 for OLYMPUS- Fiber optic Lightcable



Connect Fiber optic Cable's - Instrument end
on the left ("out")



Plug in remaining end of Fiber optic Cable on the
right ("in")

Display 70% - 100% : Cable OK

Display <70% : Cable defect

Order number	Page	Order number	Page	Order number	Page	Order number	Page
110-110-003	7	300-000-301	170	300-013-510	30	300-030-004	116
120-511-145	7	300-000-302	170	300-013-511	30	300-030-006	116
120-611-180	8	300-000-303	170	300-013-512	30	300-032-015	88
130-140-120	7	300-000-304	170	300-013-522	30	300-033-010	88
140-254-125	8	300-000-305	170	300-014-111	30	300-042-000	7
140-573-130	8	300-000-306	170	300-014-113	30	300-042-005	88
150-050-180	8	300-000-307	170	300-014-155	30	300-042-010	88
170-801-500	10	300-001-028	183	300-014-711	30	300-063-000	85
170-801-501	10	300-001-031	183	300-019-500	34	300-065-000	85
170-801-502	10	300-001-055	183	300-019-501	34, 35, 131, 142	300-065-100	85
170-801-503	10, 12	300-001-158	182	300-019-600	34	300-069-000	5, 86
170-801-504	12	300-001-168	182	300-019-601	34, 35, 131, 142	300-069-450	86
170-801-505	12	300-001-198	176	300-019-700	142	300-070-000	86
170-801-506	10, 12	300-001-199	176	300-019-701	142	300-070-450	86
170-801-507	10, 12	300-001-232	182	300-019-705	35	300-071-000	87
170-801-508	12	300-001-521	171	300-019-710	35	300-071-450	87
170-801-510	10, 11	300-001-600	174	300-019-735	35, 142	300-072-000	86
170-801-511	10, 11	300-001-601	174	300-019-740	34	300-072-450	86
170-801-512	10, 11	300-001-602	174	300-019-750	34, 142	300-073-000	86
170-801-515	10, 11	300-001-610	172, 173, 174	300-019-760	34, 142	300-073-450	86
170-802-520	11	300-001-615	172, 173, 174	300-019-770	34, 142	300-075-001	86
170-802-521	11	300-001-800	173	300-019-780	34, 142	300-075-002	86
170-802-522	11	300-001-802	173	300-019-790	34, 142	300-075-101	86
180-550-160	8	300-001-804	173	300-019-805	131	300-075-102	86
250-015-030	175	300-001-813	175	300-019-810	131	300-076-001	87
250-015-036	175	300-001-814	175	300-020-015	24	300-076-101	87
250-020-025	175	300-001-823	175	300-020-020	24	300-077-000	87
250-020-030	175	300-001-824	175	300-020-115	28	300-091-100	6, 15
250-025-230	179	300-001-825	175	300-020-120	28	300-091-130	15
250-025-300	179	300-001-840	172	300-020-211	31	300-091-145	15
250-035-180	179	300-001-841	172	300-020-215	28	300-091-430	15
250-035-230	179	300-001-970	184	300-020-220	28	300-091-433	15
250-035-300	179	300-001-978	185	300-020-255	31	300-091-445	15
250-037-000	179	300-001-979	185	300-020-711	31	300-092-100	16
250-037-400	179	300-001-980	185	300-020-755	31	300-092-130	6, 16
250-038-000	179	300-001-982	185	300-020-915	28	300-092-145	16
250-039-000	7, 179	300-001-983	185	300-020-920	28	300-096-450	16
250-039-400	179	300-001-985	185	300-021-011	4, 29	300-096-453	16
250-040-000	179	300-001-986	185	300-021-111	31	300-096-455	16
250-041-000	179	300-001-988	185	300-021-125	29	300-097-100	16
250-042-000	179	300-001-989	185	300-021-155	31	300-097-130	16
250-042-400	179	300-001-990	185	300-021-305	29	300-098-105	32
250-044-000	179	300-001-991	185	300-021-310	29	300-099-006	17, 90
250-045-000	179	300-001-999	184	300-021-355	29	300-099-033	85
250-048-000	179	300-002-001	184	300-021-380	29	300-099-100	85
250-048-180	179	300-006-305	44	300-021-405	29	300-099-106	17, 90
250-048-230	6, 179	300-006-455	44	300-021-410	29	300-099-133	85
250-048-234	179	300-010-226	182	300-021-455	29	300-099-140	85
250-048-300	179	300-011-500	84	300-021-755	31	300-099-500	17
250-051-000	179	300-011-501	84	300-023-100	32	300-100-120	90
250-052-000	179	300-012-106	29	300-023-111	31	300-100-122	90
250-059-000	179	300-012-116	29	300-023-255	31	300-100-125	90
250-930-100	187	300-012-121	29	300-023-711	31	300-100-126	90
250-930-103	187	300-012-405	4, 29, 116	300-023-755	31	300-100-127	90
250-930-104	187	300-012-410	29	300-024-111	31	300-100-131	41
250-930-105	187	300-012-412	29	300-024-155	31	300-100-132	41
300-000-095	157	300-012-415	29	300-024-711	31	300-100-133	41
300-000-100	171	300-012-416	29	300-024-755	31	300-100-134	41
300-000-101	171	300-012-420	29	300-025-358	28	300-100-400	14
300-000-102	171	300-012-421	29	300-025-359	28	300-100-430	14
300-000-103	171	300-012-425	29	300-030-000	116	300-100-641	84
300-000-110	171	300-012-455	4, 29	300-030-001	7, 116	300-100-687	109
300-000-300	170	300-013-115	30	300-030-003	116	300-100-688	109

Order number	Page	Order number	Page	Order number	Page	Order number	Page
300-100-689	109	300-155-430	14	300-194-309	44	300-230-055	23, 140
300-100-691	109	300-163-100	39	300-194-312	44	300-230-111	130
300-100-692	109	300-163-110	39	300-194-314	7, 44	300-230-113	130
300-100-693	109	300-163-111	41	300-194-318	44	300-230-155	130
300-100-694	109	300-163-120	39	300-194-412	44	300-231-011	23
300-100-695	109	300-163-121	41	300-194-414	44	300-231-013	23
300-100-696	109	300-163-130	39	300-194-418	44	300-231-055	23, 140
300-100-697	109, 132	300-163-131	41	300-195-080	32, 168	300-232-011	23
300-100-698	109, 132	300-163-140	39	300-195-100	32, 168	300-232-013	23
300-100-699	109	300-163-141	41	300-195-120	4, 32, 168	300-232-055	23, 140
300-100-702	109	300-163-150	39	300-195-150	32, 168	300-233-011	23
300-100-703	109	300-163-160	39	300-195-170	32, 168	300-233-013	23
300-100-760	84	300-163-170	39	300-195-200	32, 168	300-233-055	23, 140
300-100-771	98, 100	300-163-180	39	300-195-253	144	300-233-211	25
300-100-772	98, 100, 132	300-163-190	39	300-195-300	32, 168	300-233-213	25
300-100-773	98, 100	300-163-410	43	300-195-320	32, 168	300-233-255	25
300-100-774	98, 100	300-163-420	43	300-195-350	32, 168	300-234-011	23
300-100-776	98	300-163-430	43	300-195-370	32, 168	300-234-013	23
300-100-777	98	300-163-450	43	300-200-131	152	300-234-055	23, 140
300-100-778	98	300-163-460	43	300-200-132	152	300-234-211	25
300-100-779	98	300-163-470	43	300-200-133	152	300-234-213	25
300-100-786	98, 132	300-163-610	43	300-200-134	152	300-234-255	25
300-100-789	98, 132	300-163-620	43	300-200-137	152	300-236-011	23
300-100-798	99	300-163-630	43	300-200-231	152	300-236-013	23
300-100-799	99	300-163-650	43	300-200-232	152	300-236-055	23
300-101-588	112	300-163-660	43	300-200-233	152	300-236-211	25
300-101-589	112	300-163-670	43	300-200-234	152	300-236-213	25
300-101-592	112	300-163-810	40	300-200-237	152	300-236-255	25
300-101-593	113	300-163-820	40	300-200-400	14	300-240-011	26
300-101-594	112	300-163-830	40	300-200-430	14	300-240-013	26
300-101-596	112	300-163-850	40	300-215-000	166	300-240-015	26
300-101-599	112	300-163-860	40	300-220-011	22	300-240-020	26
300-101-775	97, 101	300-163-870	40	300-220-013	22	300-240-035	26, 141
300-101-777	99	300-165-100	36, 37, 143	300-220-055	22, 140	300-240-055	26, 141
300-110-711	89	300-166-000	38	300-220-111	130	300-240-111	131
300-110-712	89	300-166-100	7, 36, 37, 143	300-220-113	130	300-240-113	131
300-110-714	89	300-167-100	36, 37	300-220-155	130	300-240-155	131
300-110-715	89	300-172-003	37, 143	300-220-211	25	300-241-011	4, 26
300-111-013	59	300-172-005	37	300-220-213	25	300-241-013	4, 26
300-111-033	59	300-172-010	37	300-220-255	25	300-241-015	26
300-111-775	97, 132	300-172-253	143	300-221-011	22	300-241-020	26
300-112-035	24, 140	300-173-003	37, 143	300-221-013	22	300-241-035	26, 141
300-135-905	166	300-173-005	7, 37	300-221-055	22, 140	300-241-055	4, 26, 141
300-135-910	166	300-173-010	7, 37	300-221-211	25	300-241-111	131
300-144-002	6, 42	300-173-253	143	300-221-213	25	300-241-113	131
300-144-004	42	300-192-000	34, 35, 144	300-221-255	25	300-241-155	131
300-144-005	6, 42	300-192-003	35, 144	300-222-011	4, 22	300-242-011	26
300-144-006	42	300-192-005	35	300-222-013	4, 22	300-242-035	26, 141
300-145-003	42	300-192-010	35	300-222-055	4, 22, 140	300-242-055	26, 141
300-145-004	42	300-192-253	144	300-222-211	25	300-243-011	27
300-145-005	42	300-193-003	35, 144	300-222-213	25	300-243-013	27
300-145-006	42	300-193-005	35	300-222-255	25	300-243-055	27
300-151-000	7, 115	300-193-010	35	300-223-011	22	300-243-111	131
300-151-100	115	300-193-253	144	300-223-013	22	300-243-113	131
300-152-000	115	300-193-303	144	300-223-055	22, 140	300-243-155	131
300-152-011	27	300-193-305	44	300-224-011	22	300-244-011	27
300-152-012	27	300-193-330	84	300-224-013	22	300-244-013	27
300-152-055	27, 141	300-193-335	7, 44	300-224-055	22, 140	300-244-055	27
300-153-000	115	300-193-405	44	300-226-011	22	300-244-111	131
300-154-011	27	300-193-410	44	300-226-013	22	300-244-113	131
300-154-055	27	300-194-253	144	300-226-055	22	300-244-155	131
300-154-125	27	300-194-303	144	300-230-011	23	300-250-011	28, 31
300-155-400	14	300-194-307	44	300-230-013	23	300-250-013	28

Order number	Page	Order number	Page	Order number	Page	Order number	Page
300-250-035	28, 141	300-303-001	111	300-400-078	67	300-400-713	61
300-250-055	28, 31, 141	300-303-100	111	300-400-079	67	300-400-715	61
300-250-111	28	300-303-101	111	300-400-080	66	300-400-717	61
300-250-113	28	300-303-200	111	300-400-082	66	300-400-720	73
300-250-135	28, 141	300-303-201	111	300-400-084	68	300-400-730	54
300-250-155	28, 141	300-303-500	111	300-400-085	69	300-400-731	52
300-250-211	28	300-303-501	111	300-400-086	66	300-400-732	52
300-250-213	28	300-330-033	114	300-400-097	69	300-400-733	52
300-250-235	28, 141	300-330-045	114, 132	300-400-100	66	300-400-734	54
300-250-255	28, 141	300-332-033	114	300-400-109	55	300-400-735	53
300-255-400	14	300-332-320	112	300-400-165	79	300-400-736	53
300-255-430	14	300-334-033	114	300-400-168	76	300-400-737	54
300-257-002	152	300-400-000	58	300-400-169	77	300-400-738	52
300-257-004	152	300-400-001	58	300-400-170	78, 79	300-400-739	54
300-257-015	152	300-400-002	58	300-400-171	78	300-400-740	53
300-300-000	111	300-400-003	56	300-400-172	76	300-400-741	53
300-300-001	111	300-400-004	60	300-400-173	79	300-400-751	73
300-300-100	111	300-400-005	57	300-400-180	78	300-400-753	73
300-300-101	111	300-400-006	60	300-400-181	78	300-400-775	97
300-300-130	107	300-400-008	58	300-400-197	69	300-400-781	73
300-300-131	107	300-400-009	60	300-400-200	74	300-400-900	49
300-300-140	4, 107	300-400-010	62	300-400-201	60	300-400-901	49
300-300-141	4, 107	300-400-011	61	300-400-202	74	300-401-001	134
300-300-142	107	300-400-012	57	300-400-204	75	300-401-013	134
300-300-160	107	300-400-013	59	300-400-206	74	300-401-015	134
300-300-161	107	300-400-014	60	300-400-220	75	300-401-017	134
300-300-170	107	300-400-015	57	300-400-221	75	300-401-025	133
300-300-171	107	300-400-016	56	300-400-234	68	300-401-067	137
300-300-172	107	300-400-017	58	300-400-243	70	300-401-070	137
300-300-200	111	300-400-018	62	300-400-244	70	300-401-078	136
300-300-201	111	300-400-021	57	300-400-245	70	300-401-079	136
300-300-230	107	300-400-023	55	300-400-246	70	300-401-082	136
300-300-231	107	300-400-024	63	300-400-250	67	300-401-085	137
300-300-240	107	300-400-025	56	300-400-251	55	300-401-201	135
300-300-241	107	300-400-026	63	300-400-252	67	300-401-289	135
300-300-242	107	300-400-027	53	300-400-263	71	300-401-291	135
300-300-260	107	300-400-029	58	300-400-264	71	300-401-710	135
300-300-261	107	300-400-030	72	300-400-266	71	300-401-713	61
300-300-270	107	300-400-032	63	300-400-274	71	300-401-730	133
300-300-271	107	300-400-033	59	300-400-275	70	300-401-732	133
300-300-272	107	300-400-040	56	300-400-276	71	300-401-738	133
300-300-330	107, 145	300-400-042	63	300-400-280	68	300-401-739	133
300-300-340	107, 145	300-400-044	55	300-400-284	65	300-401-775	97
300-300-341	107, 145	300-400-045	63	300-400-285	64	300-403-015	149
300-300-360	107, 145	300-400-046	63	300-400-286	72	300-403-060	149
300-300-370	107, 145	300-400-048	62	300-400-287	64	300-403-069	149
300-300-371	107, 145	300-400-049	62	300-400-288	64	300-403-082	149
300-300-430	107, 145	300-400-051	62	300-400-289	64	300-403-244	149
300-300-440	107, 145	300-400-052	65	300-400-291	64	300-403-284	149
300-300-441	107, 145	300-400-053	59	300-400-295	72	300-403-289	149
300-300-460	107, 145	300-400-056	79	300-400-310	65	300-403-732	149
300-300-470	107, 145	300-400-060	80	300-400-311	65	300-403-738	149
300-300-471	107, 145	300-400-062	80	300-400-312	65	300-404-015	149
300-300-500	111	300-400-063	80	300-400-313	65	300-404-060	149
300-300-501	111	300-400-065	79	300-400-314	65	300-404-069	149
300-302-000	111	300-400-067	50, 76	300-400-330	117	300-404-082	149
300-302-001	111	300-400-068	77	300-400-521	66	300-404-244	149
300-302-100	111	300-400-069	76	300-400-570	81	300-404-284	149
300-302-101	111	300-400-070	77	300-400-571	81	300-404-289	149
300-302-200	111	300-400-071	77	300-400-572	81	300-404-330	105
300-302-201	111	300-400-072	77, 79	300-400-610	56	300-404-340	105
300-302-501	111	300-400-074	69	300-400-700	73	300-404-341	105
300-303-000	111	300-400-076	72	300-400-710	61	300-404-732	149

Order number	Page	Order number	Page	Order number	Page	Order number	Page
300-404-738	149	300-410-736	53	300-420-733	52	300-430-276	71
300-405-130	103	300-410-737	54	300-420-734	54	300-430-280	68
300-405-131	103	300-410-738	52	300-420-735	5, 53	300-430-284	65
300-405-140	103	300-410-739	54	300-420-736	53	300-430-285	64
300-405-141	103	300-410-740	53	300-420-737	54	300-430-286	72
300-405-142	103	300-410-741	53	300-420-738	52	300-430-287	64
300-405-330	105	300-410-775	97, 101	300-420-739	54	300-430-288	64
300-405-340	105	300-411-025	133	300-420-740	53	300-430-289	64
300-405-341	105	300-411-067	137	300-420-741	53	300-430-291	64
300-406-130	103	300-411-070	137	300-421-025	133	300-430-295	72
300-406-131	103	300-411-082	136	300-421-067	137	300-430-310	65
300-406-140	103	300-411-730	133	300-421-082	136	300-430-311	65
300-406-141	103	300-411-732	133	300-421-730	133	300-430-312	65
300-406-142	103	300-411-738	133	300-421-732	133	300-430-313	65
300-410-003	56	300-411-739	133	300-421-738	133	300-430-314	65
300-410-016	56	300-411-775	97	300-421-739	133	300-430-610	56
300-410-023	55	300-420-003	56	300-430-000	58	300-430-700	73
300-410-024	63	300-420-016	56	300-430-001	58	300-430-710	61
300-410-025	56	300-420-023	55	300-430-002	58	300-430-713	61
300-410-026	63	300-420-024	63	300-430-004	60	300-430-715	61
300-410-027	53	300-420-025	56	300-430-005	57	300-430-717	61
300-410-032	63	300-420-026	63	300-430-006	60	300-430-720	73
300-410-040	56	300-420-027	53	300-430-008	58	300-430-751	73
300-410-042	63	300-420-032	63	300-430-009	60	300-430-753	73
300-410-044	55	300-420-040	56	300-430-010	62	300-430-781	73
300-410-045	63	300-420-042	63	300-430-011	61	300-431-001	134
300-410-046	63	300-420-044	55	300-430-012	57	300-431-013	134
300-410-056	79	300-420-045	63	300-430-013	59	300-431-015	134
300-410-060	80	300-420-046	63	300-430-014	60	300-431-017	134
300-410-062	80	300-420-056	79	300-430-015	57	300-431-070	137
300-410-063	80	300-420-060	5, 80	300-430-017	58	300-431-078	136
300-410-064	79	300-420-062	80	300-430-018	62	300-431-079	136
300-410-067	50, 76	300-420-063	80	300-430-021	57	300-431-085	137
300-410-068	77	300-420-064	79	300-430-025	56	300-431-201	135
300-410-069	76	300-420-065	166	300-430-029	58	300-431-289	135
300-410-070	77	300-420-067	5, 50, 76	300-430-030	72	300-431-291	135
300-410-071	77	300-420-068	77	300-430-033	59	300-431-710	135
300-410-072	77, 79	300-420-068	77	300-430-033	59	300-431-713	61
300-410-080	66	300-420-069	76	300-430-048	62	300-440-000	58
300-410-082	66	300-420-070	77	300-430-049	62	300-440-001	58
300-410-086	66	300-420-071	77	300-430-051	62	300-440-002	58
300-410-100	66	300-420-072	77, 79	300-430-052	65	300-440-004	60
300-410-109	55	300-420-080	66	300-430-053	59	300-440-004	60
300-410-165	79	300-420-082	66	300-430-074	69	300-440-005	57
300-410-168	76	300-420-086	66	300-430-076	72	300-440-006	60
300-410-169	77	300-420-100	66	300-430-078	67	300-440-008	58
300-410-170	78, 79	300-420-109	55	300-430-079	67	300-440-009	60
300-410-171	78	300-420-165	79	300-430-084	68	300-440-010	62
300-410-172	76	300-420-168	76	300-430-085	69	300-440-011	61
300-410-173	79	300-420-169	77	300-430-097	69	300-440-012	57
300-410-180	78	300-420-170	78, 79	300-430-197	69	300-440-013	59
300-410-181	78	300-420-171	78	300-430-201	60	300-440-014	60
300-410-251	55	300-420-172	76	300-430-234	68	300-440-015	57
300-410-521	66	300-420-173	79	300-430-243	70	300-440-017	58
300-410-570	81	300-420-180	78	300-430-244	70	300-440-018	62
300-410-571	81	300-420-181	78	300-430-245	70	300-440-021	57
300-410-572	81	300-420-251	55	300-430-246	70	300-440-025	56
300-410-730	54	300-420-521	66	300-430-250	67	300-440-029	58
300-410-731	52	300-420-570	81	300-430-252	67	300-440-030	72
300-410-732	52	300-420-571	81	300-430-263	71	300-440-033	59
300-410-733	52	300-420-572	81	300-430-264	71	300-440-048	62
300-410-734	54	300-420-730	54	300-430-266	71	300-440-049	62
300-410-735	53	300-420-731	52	300-430-274	71	300-440-051	62
		300-420-732	5, 52	300-430-275	70	300-440-052	65

Order number	Page	Order number	Page	Order number	Page	Order number	Page
300-440-053	59	300-450-173	83	300-470-284	65	300-490-221	75
300-440-074	69	300-450-174	83	300-470-285	64	300-501-730	142
300-440-076	72	300-450-176	83	300-470-287	64	300-503-000	147
300-440-078	67	300-450-177	83	300-470-288	64	300-503-015	147
300-440-079	67	300-450-289	83	300-470-289	5, 64	300-503-016	147
300-440-084	68	300-450-300	82	300-470-291	64	300-503-021	147
300-440-085	69	300-450-731	83	300-470-310	65	300-503-025	147
300-440-097	69	300-460-000	58	300-470-311	65	300-503-052	147
300-440-197	69	300-460-001	5, 58	300-470-312	65	300-503-060	146
300-440-201	60	300-460-002	58	300-470-313	65	300-503-063	146
300-440-234	68	300-460-004	60	300-470-314	65	300-503-067	146
300-440-243	70	300-460-006	60	300-480-000	104	300-503-069	146
300-440-244	70	300-460-008	58	300-480-001	104	300-503-080	146
300-440-245	70	300-460-009	60	300-480-002	104	300-503-082	146
300-440-246	70	300-460-010	62	300-480-033	104	300-503-570	146
300-440-250	67	300-460-011	5, 61	300-480-045	104	300-503-710	147
300-440-252	67	300-460-013	59	300-480-130	103	300-503-731	147
300-440-263	71	300-460-014	60	300-480-131	103	300-505-000	147
300-440-264	71	300-460-017	5, 58	300-480-140	103	300-505-015	147
300-440-266	71	300-460-018	62	300-480-141	103	300-505-016	147
300-440-274	71	300-460-029	58	300-480-142	103	300-505-021	147
300-440-275	70	300-460-030	72	300-480-160	103	300-505-025	147
300-440-276	71	300-460-033	59	300-480-161	103	300-505-052	147
300-440-280	68	300-460-048	62	300-480-170	103	300-505-060	146
300-440-284	65	300-460-049	62	300-480-171	103	300-505-063	146
300-440-285	64	300-460-051	62	300-480-172	103	300-505-067	146
300-440-286	72	300-460-053	59	300-480-230	103	300-505-069	146
300-440-287	64	300-460-076	72	300-480-231	103	300-505-080	146
300-440-288	64	300-460-201	60	300-480-240	103	300-505-082	146
300-440-289	64	300-460-243	70	300-480-241	103	300-505-570	146
300-440-291	64	300-460-244	70	300-480-242	103	300-505-710	147
300-440-295	72	300-460-245	70	300-480-260	103	300-505-731	147
300-440-310	65	300-460-246	70	300-480-261	103	300-550-005	49
300-440-311	65	300-460-263	71	300-480-270	103	300-550-010	49
300-440-312	65	300-460-264	71	300-480-271	103	300-550-035	148
300-440-313	65	300-460-266	71	300-480-272	103	300-550-105	49
300-440-314	65	300-460-274	71	300-480-330	105	300-550-110	49
300-440-610	56	300-460-275	70	300-480-340	105	300-560-535	120
300-440-700	73	300-460-276	71	300-480-341	105	300-560-546	120
300-440-710	61	300-460-286	72	300-480-360	105	300-601-731	142
300-440-713	61	300-460-295	72	300-480-370	105	300-660-005	49, 117
300-440-715	61	300-460-700	73	300-480-371	105	300-660-010	49
300-440-717	61	300-460-710	61	300-480-530	105	300-660-015	78
300-440-720	73	300-460-713	61	300-480-540	105	300-660-035	148
300-440-751	73	300-460-715	61	300-480-541	105	300-660-105	49
300-440-753	73	300-460-717	61	300-480-560	105	300-660-110	49
300-440-781	73	300-460-720	73	300-480-570	105	300-661-004	49
300-441-001	134	300-460-751	73	300-480-571	105	300-661-005	49
300-441-013	134	300-460-753	73	300-480-630	103	300-661-006	49
300-441-015	134	300-460-781	73	300-480-631	103	300-661-007	49
300-441-017	134	300-461-713	61	300-480-640	103	300-661-008	49
300-441-078	136	300-470-052	65	300-480-641	103	300-661-009	49
300-441-079	136	300-470-074	69	300-480-642	103	300-661-010	49
300-441-085	137	300-470-078	67	300-480-730	103	300-700-400	15
300-441-201	135	300-470-079	67	300-480-731	103	300-700-430	15
300-441-289	135	300-470-084	68	300-480-740	103	300-750-001	48 - 81, 133, 136, 137
300-441-291	135	300-470-085	69	300-480-741	103	300-750-003	48 - 73, 134 - 137
300-441-710	135	300-470-097	69	300-480-742	103	300-750-015	48, 74, 75
300-441-713	61	300-470-197	69	300-490-200	74	300-750-101	48 - 81, 117, 133, 136, 137, 148
300-450-005	82	300-470-234	68	300-490-202	74	300-750-103	48 - 73, 134 - 137, 148
300-450-006	82	300-470-250	67	300-490-204	75	300-750-105	48 - 73, 117
300-450-049	83	300-470-252	67	300-490-206	74	300-750-106	48
300-450-171	83	300-470-280	68	300-490-220	75		

Order number	Page	Order number	Page	Order number	Page	Order number	Page
300-750-115	48	300-820-413	95	300-855-069	124	300-867-620	123, 150
300-750-215	48	300-820-414	95	300-855-100	124	300-867-720	123, 150
300-750-315	48	300-820-415	96	300-855-101	124	300-867-729	123, 150
300-755-400	15	300-820-451	95	300-855-102	124	300-867-929	123, 150
300-755-430	15	300-820-452	95	300-855-103	124	300-900-020	168
300-760-005	49	300-820-456	96	300-855-105	124	300-900-021	168
300-760-010	49	300-830-005	94, 96	300-855-120	124	300-900-030	168
300-760-105	49	300-830-010	92, 93, 94, 96, 97	300-855-134	124	300-900-031	168
300-760-110	49	300-830-013	94	300-855-145	124	300-900-040	168
300-800-001	92	300-830-014	94	300-855-400	124	300-900-041	168
300-800-002	92	300-830-015	96	300-855-401	124	300-900-180	178
300-800-004	92	300-830-051	94	300-857-100	125, 151	300-900-300	177
300-800-006	92	300-830-052	94	300-857-111	125, 151	300-900-902	3
300-800-011	93	300-830-056	96	300-857-112	125, 151	300-902-001	168, 169
300-800-012	93	300-830-113	94	300-857-205	125, 151	300-902-003	168, 169
300-800-014	93	300-830-114	94	300-857-301	125, 151	300-902-004	168, 169
300-800-016	93	300-830-115	96	300-857-302	125, 151	300-902-005	168, 169
300-800-401	92	300-830-151	94	300-857-303	125, 151	300-902-006	168, 169
300-800-402	92	300-830-152	94	300-860-009	121, 122	300-902-007	168, 169
300-800-404	92	300-830-156	96	300-860-011	121	300-902-008	169
300-800-406	92	300-830-405	94, 96	300-860-012	121	350-400-250	88
300-800-411	93	300-830-410	92, 93, 94, 96, 97	300-860-013	6, 121	350-660-100	88
300-800-412	93	300-830-413	94	300-860-014	121	350-660-111	88
300-800-414	93	300-830-414	94	300-860-015	121	350-660-112	88
300-800-416	93	300-830-415	96	300-860-016	121	350-660-113	88
300-810-001	92	300-830-451	94	300-860-018	6, 121	350-660-114	88
300-810-002	92	300-830-452	94	300-860-019	6, 121	350-660-115	88
300-810-004	92	300-830-456	96	300-860-021	121, 138	350-660-116	88
300-810-006	92	300-830-513	94	300-860-022	121, 138	350-750-000	88
300-810-011	93	300-830-514	94	300-860-024	121, 138	350-750-001	88
300-810-012	93	300-830-515	96	300-860-025	121, 138	350-750-002	88
300-810-014	93	300-830-551	94	300-860-026	121	350-755-007	89
300-810-016	93	300-830-552	94	300-860-028	121, 138	350-755-011	89
300-810-101	92	300-830-556	96	300-860-029	121, 138	350-755-017	89
300-810-102	92	300-855-001	124	300-860-032	122	600-050-000	166
300-810-104	92	300-855-002	124	300-860-033	122	600-100-000	166
300-810-106	92	300-855-003	124	300-860-035	122	600-255-500	161
300-810-111	93	300-855-006	124	300-860-037	122	600-255-530	161
300-810-112	93	300-855-007	124	300-860-040	122	600-255-535	161
300-810-114	93	300-855-010	124	300-860-061	121	600-255-550	161
300-810-116	93	300-855-011	124	300-860-063	121	600-255-555	161
300-810-401	92	300-855-013	124	300-860-065	121	600-255-565	161
300-810-402	92	300-855-015	124	300-860-068	121	600-255-575	161
300-810-404	92	300-855-017	124	300-860-069	121	600-255-600	161
300-810-406	92	300-855-018	124	300-860-100	126	600-255-605	161
300-810-411	93	300-855-019	124	300-860-111	126	600-279-101	164
300-810-412	93	300-855-020	124	300-860-125	120	600-279-102	164
300-810-414	93	300-855-021	124	300-860-134	6, 120	600-279-103	164
300-810-416	93	300-855-022	124	300-860-140	120	600-279-104	164
300-810-501	92	300-855-023	124	300-860-141	120	600-279-105	164
300-810-502	92	300-855-025	124	300-860-142	120	600-279-106	164
300-810-504	92	300-855-027	124	300-860-143	120	600-279-131	164
300-810-506	92	300-855-028	124	300-860-145	120, 138	600-279-132	164
300-810-511	93	300-855-029	124	300-860-147	120	600-279-133	164
300-810-512	93	300-855-034	124	300-860-250	120	600-279-134	164
300-810-514	93	300-855-045	124	300-860-500	120	600-279-135	164
300-810-516	93	300-855-051	124	300-860-534	120	600-279-136	164
300-820-013	95	300-855-052	124	300-860-545	120	600-279-151	164
300-820-014	95	300-855-060	124	300-867-100	123, 150	600-279-152	164
300-820-015	96	300-855-061	124	300-867-120	123, 150	600-279-153	164
300-820-051	95	300-855-063	124	300-867-129	123, 150	600-279-154	164
300-820-052	95	300-855-065	124	300-867-520	123, 150	600-279-155	164
300-820-056	96	300-855-067	124	300-867-529	123, 150	600-279-156	164

Order number	Page				
600-279-201	164	600-469-101	163	600-579-102	162
600-279-202	164	600-469-102	163	600-579-103	162
600-279-203	164	600-469-103	163	600-579-104	162
600-279-204	164	600-469-104	163	600-579-105	162
600-279-205	164	600-469-105	163	600-579-106	162
600-279-206	164	600-469-106	163	600-579-131	162
600-279-261	164	600-469-131	163	600-579-132	162
600-279-262	164	600-469-132	163	600-579-133	162
600-279-263	164	600-469-133	163	600-579-134	162
600-279-264	164	600-469-134	163	600-579-135	162
600-279-265	164	600-469-135	163	600-579-136	162
600-279-266	164	600-469-136	163	600-579-151	162
600-280-101	164	600-469-151	163	600-579-152	162
600-280-102	164	600-469-152	163	600-579-153	162
600-280-103	164	600-469-153	163	600-579-154	162
600-280-104	164	600-469-154	163	600-579-155	162
600-280-105	164	600-469-155	163	600-579-156	162
600-280-106	164	600-469-156	163	600-579-201	162
600-280-131	164	600-470-101	163	600-579-202	162
600-280-132	164	600-470-102	163	600-579-203	162
600-280-133	164	600-470-103	163	600-579-204	162
600-280-134	164	600-470-104	163	600-579-205	162
600-280-135	164	600-470-105	163	600-579-206	162
600-280-136	164	600-470-106	163	600-579-261	162
600-280-151	164	600-470-131	163	600-579-262	162
600-280-152	164	600-470-132	163	600-579-263	162
600-280-153	164	600-470-133	163	600-579-264	162
600-280-154	164	600-470-134	163	600-579-265	162
600-280-155	164	600-470-135	163	600-579-266	162
600-280-156	164	600-470-136	163	600-580-101	162
600-280-201	164	600-470-151	163	600-580-102	162
600-280-202	164	600-470-152	163	600-580-103	162
600-280-203	164	600-470-153	163	600-580-104	162
600-280-204	164	600-470-154	163	600-580-105	162
600-280-205	164	600-470-155	163	600-580-106	162
600-280-206	164	600-470-156	163	600-580-131	162
600-280-261	164	600-485-500	159	600-580-132	162
600-280-262	164	600-485-530	159	600-580-133	162
600-280-263	164	600-485-535	159	600-580-134	162
600-280-264	164	600-485-550	159	600-580-135	162
600-280-265	164	600-485-555	159	600-580-136	162
600-280-266	164	600-485-570	159	600-580-151	162
600-281-001	161	600-485-575	159	600-580-152	162
600-281-002	160	600-485-600	159	600-580-153	162
600-281-003	8, 159	600-485-605	159	600-580-154	162
600-281-004	158	600-501-000	154	600-580-155	162
600-290-630	165	600-501-002	154	600-580-156	162
600-292-052	156	600-505-000	154	600-580-201	162
600-380-100	165	600-505-002	154	600-580-202	162
600-405-500	160	600-506-002	154	600-580-203	162
600-405-530	160	600-508-000	155	600-580-204	162
600-405-535	160	600-511-000	155	600-580-205	5, 8, 162
600-405-550	160	600-513-003	5, 157	600-580-206	162
600-405-555	160	600-540-500	158	600-580-261	162
600-405-570	160	600-540-530	158	600-580-262	162
600-405-575	160	600-540-535	8, 158	600-580-263	162
600-405-600	160	600-540-550	5, 158	600-580-264	162
600-405-605	160	600-540-555	8, 158	600-580-265	162
600-450-070	156	600-540-570	158	600-580-266	162
600-460-055	156	600-540-575	158	600-900-040	165
600-460-056	8, 156	600-540-600	158	600-900-041	165
600-462-052	156	600-540-605	158	600-900-050	165
600-464-229	155	600-579-101	162	600-900-051	165
				600-900-060	165
				600-900-061	165
				600-900-070	165
				600-900-071	165
				600-900-080	165
				600-900-081	165
				600-900-090	165
				600-900-091	165
				600-900-100	165
				600-900-101	165
				600-900-108	165
				600-900-109	165
				600-900-110	165
				600-900-111	165
				600-900-120	165
				600-900-121	165
				600-900-130	165
				600-900-131	165
				600-900-140	165
				600-900-141	165
				600-900-150	165
				600-900-151	165
				600-900-160	165
				600-900-161	165
				600-900-210	165
				600-908-000	165
				600-908-100	165
				600-909-000	165
				600-950-100	166
				700-100-101	126
				700-100-102	126
				700-100-103	126
				700-100-104	127
				700-100-105	127
				700-100-130	126
				700-100-150	126
				700-100-202	127
				700-100-302	127
				700-100-303	127
				700-100-305	127
				700-100-402	127
				700-100-405	127
				700-100-502	127
				700-100-505	127
				700-101-001	126
				700-101-030	45
				700-101-050	45
				700-101-130	126
				700-101-150	126
				700-101-230	127
				700-101-250	127
				700-102-030	45
				700-103-030	45
				700-103-050	45
				700-104-050	45
				700-200-030	127
				700-200-050	127
				700-200-130	126
				700-200-132	126
				700-200-150	126
				700-200-152	126
				700-200-232	127
				700-200-252	127

700-200-332	127	700-351-231	127
700-200-352	127	700-351-251	127
700-200-432	127	700-360-031	6, 45
700-200-452	127	700-360-051	45
700-200-532	127	700-361-030	45
700-200-552	127	700-361-050	45
700-280-030	45	700-362-030	45
700-280-050	45	700-362-050	45
700-285-030	45	700-363-030	45
700-285-050	45	700-363-050	45
700-286-030	45	700-364-030	45
700-286-050	45	700-370-030	45
700-286-130	45	700-370-050	45
700-286-230	45	700-390-030	127
700-287-030	126	700-390-050	127
700-287-050	126	700-400-003	126
700-287-130	126	700-400-030	126
700-287-150	126	700-400-050	126
700-287-230	127	700-400-055	126
700-287-250	127	700-400-103	126
700-290-030	45	700-400-105	126
700-290-050	45	700-400-130	126
700-291-030	45	700-400-203	126
700-291-050	45	700-400-205	127
700-292-030	45	700-400-303	127
700-293-033	45	700-400-403	127
700-293-035	45	700-400-503	127
700-300-003	126	700-400-603	127
700-300-005	126	700-500-300	126
700-300-203	126	700-500-500	126
700-300-205	126	700-501-300	45
700-300-403	127	700-501-303	45
700-300-405	127	700-501-500	45
700-300-503	127	700-501-503	45
700-300-505	127	700-503-000	180, 181
700-300-603	127	700-503-001	180, 181
700-300-703	127	700-503-003	180, 181
700-300-705	127	700-630-003	127
700-300-805	127	700-736-003	127
700-340-400	181	700-736-005	127
700-340-410	181	700-739-003	127
700-345-003	127	700-739-005	127
700-345-005	127	700-900-160	166
700-345-403	127	700-900-220	166
700-345-405	127	700-900-250	166
700-350-030	126	700-999-000	186
700-350-050	126	700-999-004	186
700-350-130	126	700-999-006	186
700-350-150	126	700-999-007	186
700-350-400	180	700-999-009	186
700-350-402	180, 181	700-999-010	186
700-350-405	180, 181		
700-350-410	180		
700-351-030	126		
700-351-031	126		
700-351-047	127		
700-351-048	127		
700-351-050	126		
700-351-051	126		
700-351-053	127		
700-351-055	127		
700-351-131	6, 126		
700-351-151	126		

