

## INDEX

Sets & Retractors	1 - 12
Laparoscopes	13 - 18
Advanced Trocar Systems	19 - 32
Suction & Irrigation	33 - 46
Ring Handle Instruments	47 - 90
Clip Applying, Bulldog Clamps, Needle Holders	91 - 118
Bipolar Instruments	119 - 128
Bariatric Instruments	129 - 138
Pediatric & Mini Instruments	139 - 152
Container & Cleaning	153 - 166
Equipment	167 - 187





# CONTAINER SETS

## Small Incision, fast recovery.

Innovations in high-precision instrumentation or high class optical scopes we offer a broad spectrum of laparoscopic instruments and devices for your minimal invasive surgeries.

We work hand-in-hand with clinical partners and produce under high quality standards in Germany which makes our instrument your choice for minimally invasive surgery.

Our portfolio includes instruments and trocars as well as different specialties, endoscopes and advanced energy solutions. Together with our clinical partners we have defined a complete Laparoscopic Set which fulfill the requirements for minimal invasive surgery from the first cut till the last stitch.

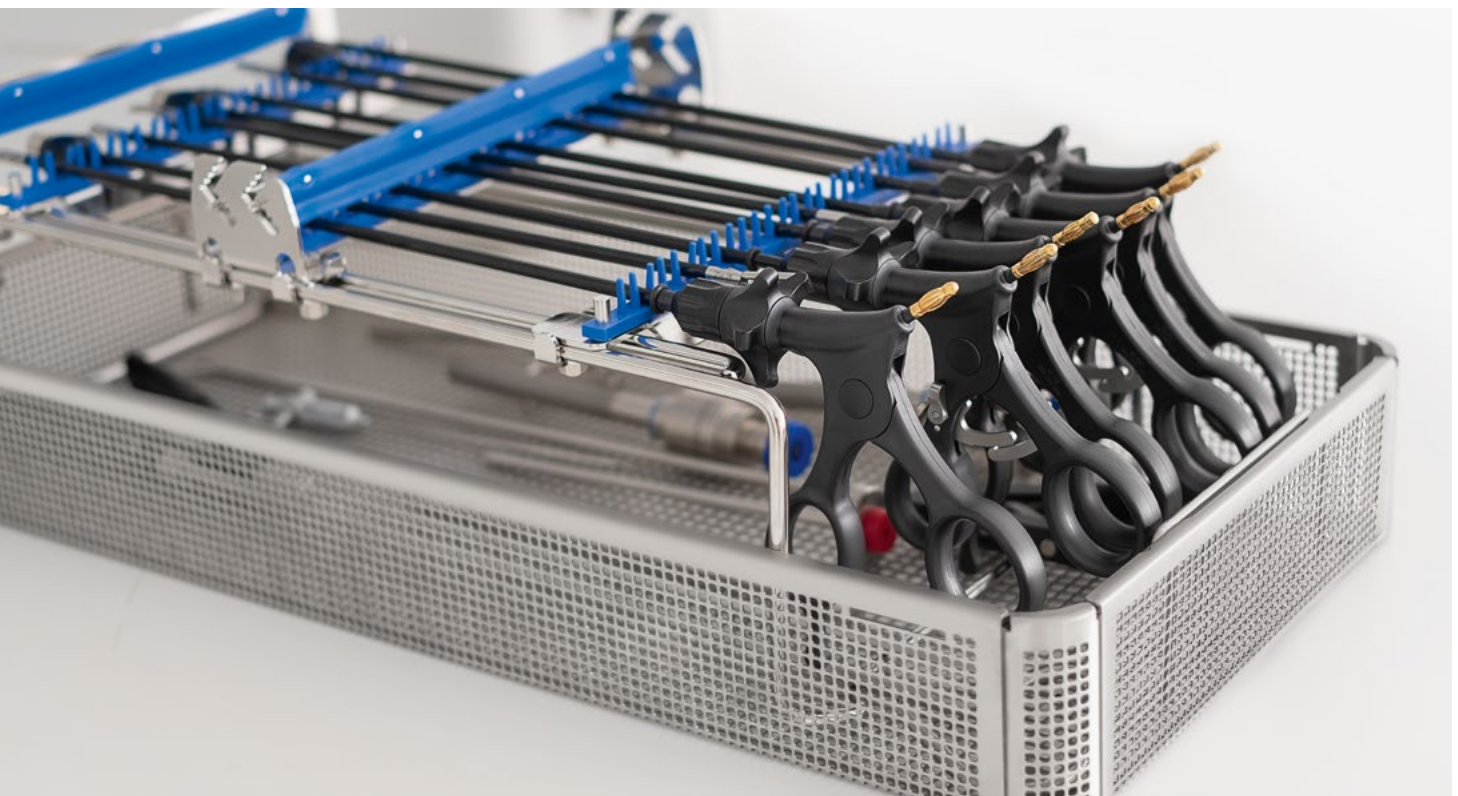

# CONTAINER SET #1

Grasping and Dissecting Forceps, Needle Holders, Scissors, Trocars and other specialities makes the first Container fully equipped with the instruments you need.

Open the tray and start working without missing your favorite instrument.



300-900-902 (Set #1 + Set #2)

# CONTAINER SET #2







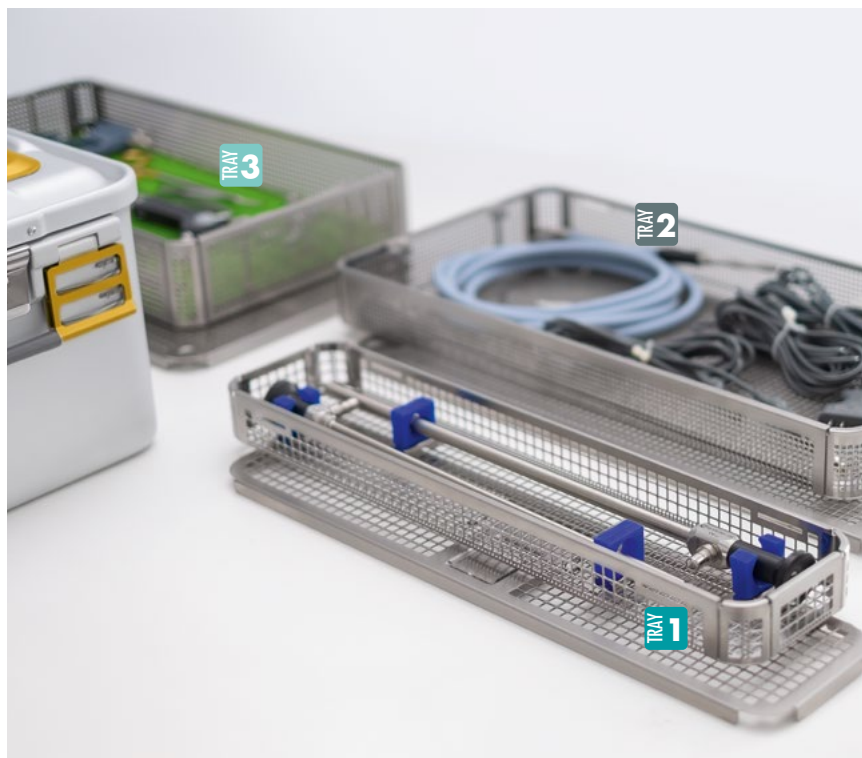





The second container includes high class scopes, instruments, monopolar and bipolar solutions and many accessories.



















Everything stored in trays for easy cleaning and reprocessing.

Your CSSD department will like it.



### CONTAINER SET #1



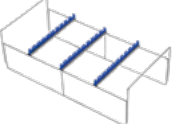







	Reducer Sleeve $\varnothing$ 10 - 5mm, 180mm	300-012-455	1 pc.
	Reducer Sleeve $\varnothing$ 5 - 4mm, 175mm, red	300-012-405	1 pc.
	Reducer Clip, for all modular trocar sleeves, 11.0 / 5.5mm	300-021-011	1 pc.
	Veress Needle, $\varnothing$ 2mm, 120mm chrome, matt	300-195-120	1 pc.
	Multiport Multifunctional Trocar System $\varnothing$ 11mm, 105mm working length blue metal trocar sleeve, smooth, oblique	300-222-011	2 pcs.
	Multiport Multifunctional Trocar System $\varnothing$ 13mm, 102mm working length green metal trocar sleeve, smooth, oblique	300-222-013	1 pc.
	Multiport Multifunctional Trocar System $\varnothing$ 5.5mm, 103mm working length white metal trocar sleeve, smooth, oblique	300-222-055	3 pcs.
	Trocar, $\varnothing$ 11mm, pyramidal tip for 300-22X-011 & 300-23X-011	300-241-011	1 pc.
	Trocar, $\varnothing$ 13mm, triangular, for 300-22X-013 & 300-23X-013	300-241-013	1 pc.
	Trocar, $\varnothing$ 5.5mm, triangular, for 300-22X-055 & 300-23X-055	300-241-055	1 pc.
	Dick III Lightweight Needle Holder, TC, $\varnothing$ 5mm, straight handle, 330mm working length, left curved jaw	300-300-140	1 pc.
	Dick III Lightweight Needle Holder, TC, $\varnothing$ 5mm, straight handle, 330mm working length, right curved jaw	300-300-141	1 pc.

		Bullnose Grasping Forceps, heavy insert, deep serrated, double action Ø 5mm, 330mm working length, complete*	300-460-001	1 pc.
		Martin Grasping Forceps, multiple serrated, 4.8mm wide, single action Ø 5mm, 330mm working length, complete*	300-460-011	1 pc.
		Gripper #1 Grasping Forceps, fenestrated coarse serrated, double action Ø 5mm, 330mm working length, complete*	300-460-017	1 pc.
		Hook Scissors, round cutting blade, single action Ø 5mm, 330mm working length, complete*	300-420-060	1 pc.
		Metzenbaum Scissors, slightly curved 12mm short blade, double action Ø 5mm, 330mm working length, complete*	300-420-067	1 pc.
		Johans Grasping Forceps, 20mm fenestrated, double action Ø 5mm, 330mm working length, complete*	300-470-289	1 pc.
		Kelly Dissecting Forceps, cross-serrated slightly tapered, double action Ø 5mm, 330mm working length, complete*	300-420-732	1 pc.
		Dissecting & Grasping Forceps, right angled fine serrated, double action Ø 5mm, 330mm working length, complete*	300-420-735	1 pc.
		Articulating Triangular Retractor, straight, 60mm width, 330mm working length	300-069-000	1 pc.
		1/1 Sterilization Container, safety model, bottom non-perforated, yellow lid 580 x 280 x 200mm	600-580-205	1 pc.
		1/1 Stainless Steel Tray, perforated, 540 x 253 x 47mm	600-540-550	1 pc.
		Storage rack for MIS instruments	600-513-003	1 pc.



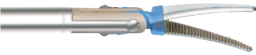

















\* complete MIC Instrument, consists of insert, handle and shaft

### CONTAINER SET #2

	TRAY 1	Laparoscope, 0°, Ø 10mm, 330mm working length	300-091-100	1 pc.
	TRAY 1	Laparoscope, 30°, Ø 5mm, 302mm working length	300-092-130	1 pc.
	TRAY 2	Monopolar Electrode, ceramic tip Ø 5mm, 360mm, spatula shaped	300-144-002	1 pc.
	TRAY 2	Monopolar Electrode, ceramic tip Ø 5mm, 360mm, L-Hook	300-144-005	1 pc.
	TRAY 3	RZ Power Handle Bipolar Forceps, Ø 5mm, detachable, flat plug	300-860-134	1 pc.
	TRAY 3	Powergrip Bipolar Grasping Forceps Ø 5mm, 340mm	300-860-013	1 pc.
	TRAY 3	Powergrip Bipolar TC Metzenbaum Scissors Ø 5mm, 340mm	300-860-018	1 pc.
	TRAY 3	Powergrip Bipolar Maryland Forceps Ø 5mm, 340mm	300-860-019	1 pc.
	TRAY 2	HF Cable, monopolar Valleylab/Lamiday/EMC, 3m	700-360-031	3 pcs.
	TRAY 2	HF Cable, bipolar RZ/Valleylab/ Lamiday/EMC, 3m	700-351-131	1 pc.
	TRAY 2	Fibre Optic Light Guide Cable, Ø 4.8mm, 230cm	250-048-230	1 pc.

		Adapter for fibre optic light guide RZ/Storz (unit)	250-039-000	1 pc.
		Adapter for fibre optic light guide RZ/Storz (endoscope)	300-042-000	1 pc.
		Knot Pusher with slit and eye, Ø 4mm, 330mm	300-030-001	1 pc.
		Tobias Fascia Needle Holder, spring handle 2mm tip, 150mm	300-151-000	1 pc.
		Suction/Irrigation Pistol Handle, 2-way-valve, 2x universal tube connector	300-166-100	1 pc.
		Suction/Irrigation Tube Ø 5mm, 4x4 holes, 340mm working length	300-173-005	1 pc.
		Suction/Irrigation Tube Ø 10mm, 4x4 holes, 340mm working length	300-173-010	1 pc.
		Palpation Probe, graduated Ø 5mm, 330mm working length	300-193-335	1 pc.
		Puncture and Injection Tube Ø 1.4mm tip, 20mm tip, Ø 5mm, 330mm working length	300-194-314	1 pc.
		Scalpel Handle No. 3, 130mm	110-110-003	1 pc.
		TC Metzenbaum Scissors, Fig. 1 curved, blunt/blunt, 145mm	120-511-145	1 pc.
		Adson Tissue Forceps, 1x2 teeth, 120mm	130-140-120	1 pc.

### CONTAINER SET #2

		Halsted-Mosquito Hemostatic Forceps, straight, 125mm	140-254-125	2 pcs.
		TC Ligature Scissors, curved, serrated, 180mm	120-611-180	1 pc.
		Backhaus Towel Forceps, 130mm	140-573-130	4 pcs.
		Foerster Swab Forceps, straight, smooth jaw, 180mm	150-050-180	2 pcs.
		TC Mayo Hegar Needle Holder, straight, serrated, 160mm	180-550-160	1 pc.
		1/1 Sterilization Container, safety model, bottom non-perforated, yellow lid 580 x 280 x 200mm	600-580-205	1 pc.
		1/1 Stainless Steel Tray, perforated, 540 x 254 x 35mm	600-540-535	1 pc.
		1/1 Stainless Steel Tray, perforated, 540 x 254 x 55mm	600-540-555	1 pc.
		Silicone Mat, green 440 x 230mm	600-281-003	1 pc.
		Tray for 2 Endoscopes until 340mm	600-460-056	1 pc.





All you need in two containers  
stored in different trays.

## NATHANSON LIVER RETRACTOR SET

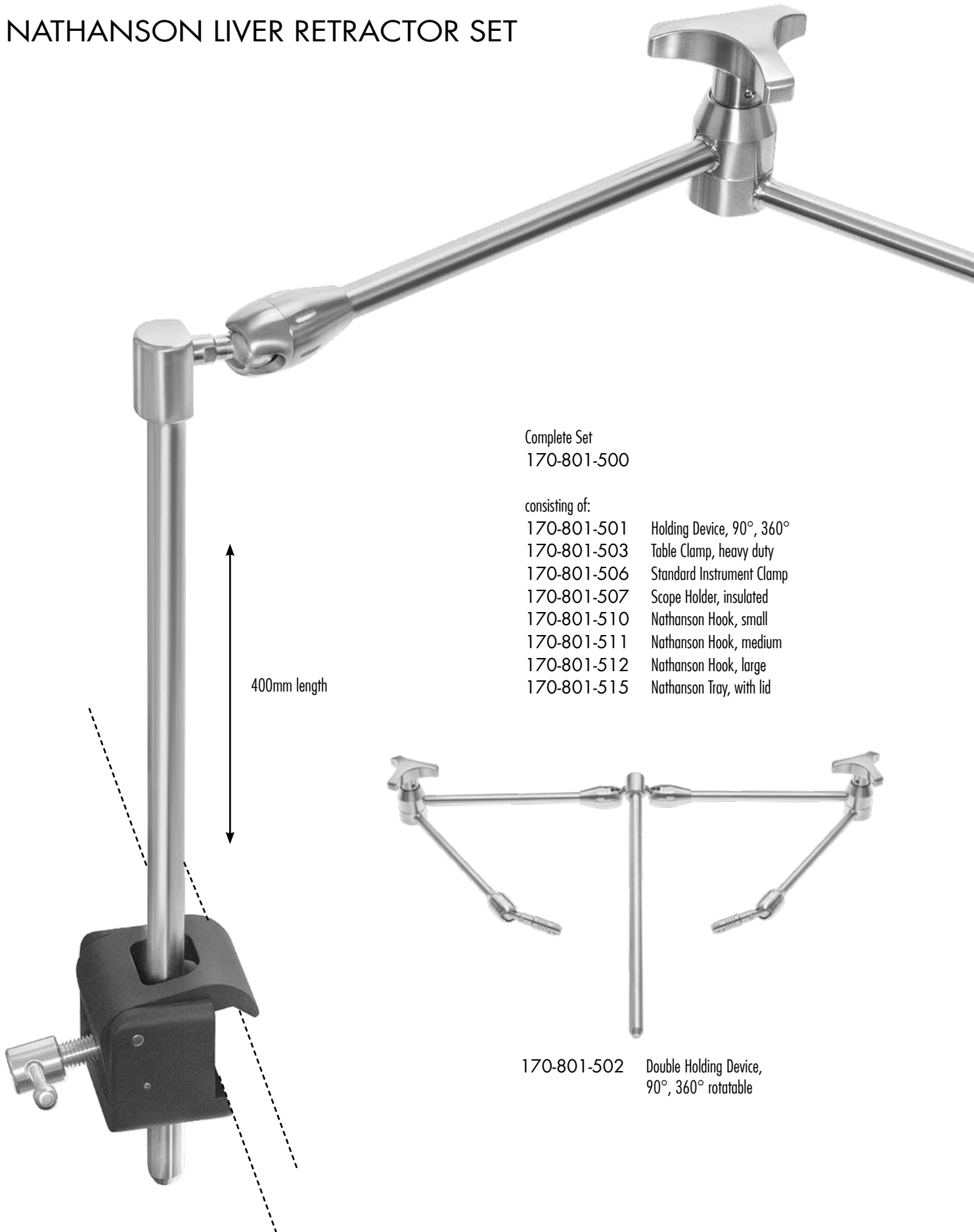

Complete Set  
170-801-500

consisting of:

- 170-801-501 Holding Device, 90°, 360°
- 170-801-503 Table Clamp, heavy duty
- 170-801-506 Standard Instrument Clamp
- 170-801-507 Scope Holder, insulated
- 170-801-510 Nathanson Hook, small
- 170-801-511 Nathanson Hook, medium
- 170-801-512 Nathanson Hook, large
- 170-801-515 Nathanson Tray, with lid

170-801-502 Double Holding Device,  
90°, 360° rotatable

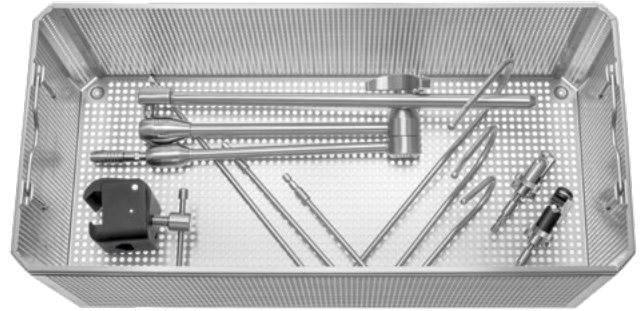

170-801-515  
Tray, with lid, 540 x 253 x 197mm



Quick lock mechanism

Hook,  $\varnothing$  6.5mm  
 170-801-510 Small  
 170-801-511 Medium  
 170-801-512 Large

Hook,  $\varnothing$  3.0mm  
 170-802-520 Small  
 170-802-521 Medium  
 170-802-522 Large

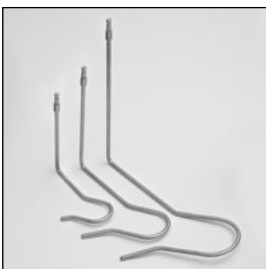



170-801-503 Table Clamp, heavy duty



170-801-507 Scope Holder, insulated



170-801-506 Standard Instrument Clamp

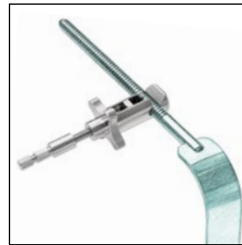

170-801-504 Universal Retractor Holder



170-801-505 Frame Clamp for Retractor Frames

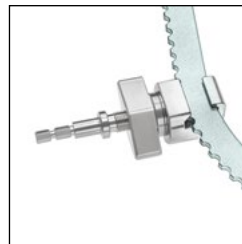

170-801-508 Ratchet mechanism



# LAPAROSCOPES

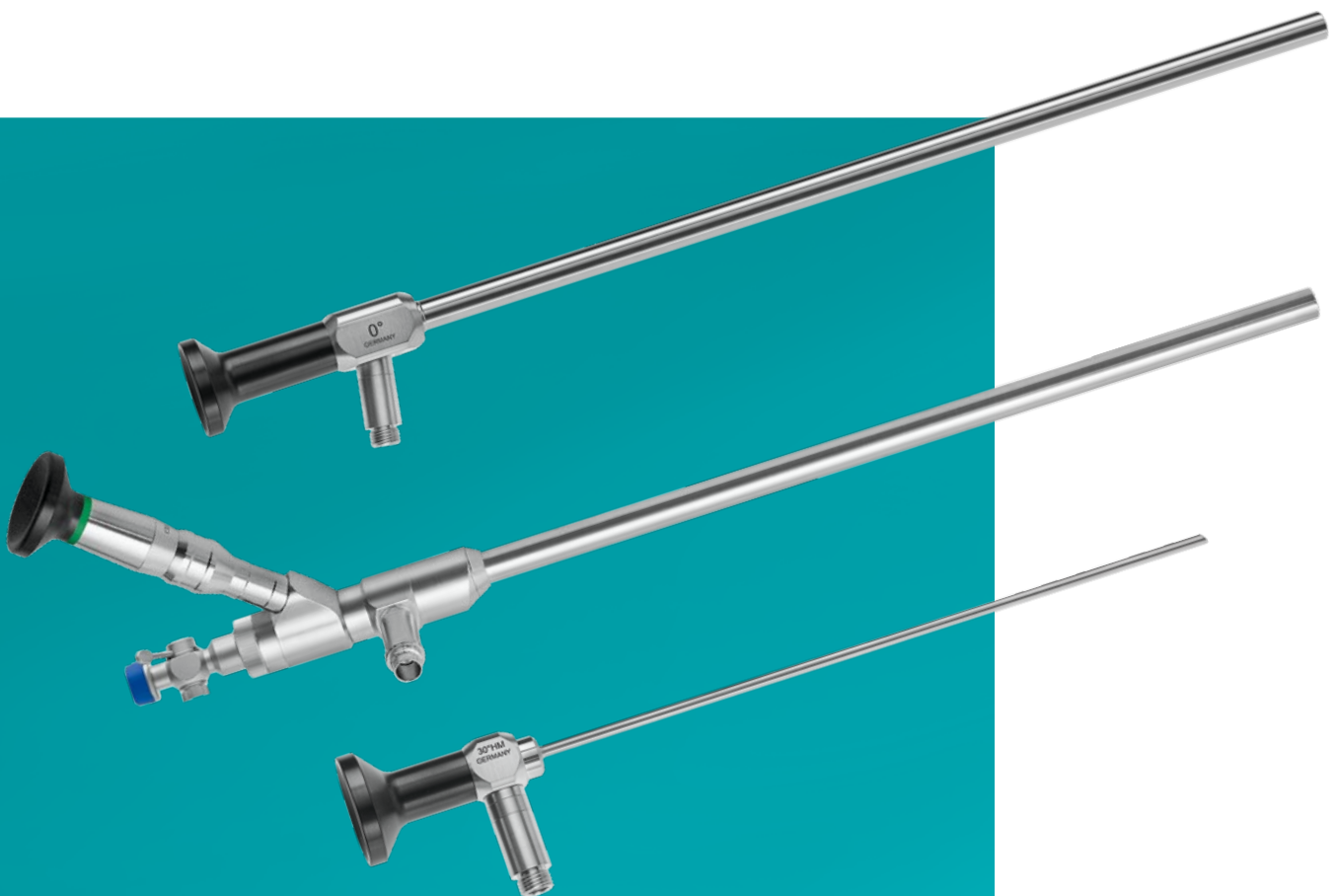

## 4K LAPAROSCOPES

State-of-the-art Laparoscopes to achieve excellent image quality and finest details in Ultra High Definition.

# 4K

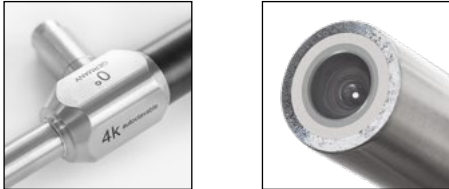

Ø  
10 mm



### 0° DIRECTION OF VIEW

330mm working length 405mm overall length	300-100-400*
450mm working length 532mm overall length	300-200-400

### 30° DIRECTION OF VIEW

330mm working length 405mm overall length	300-100-430*
450mm working length 532mm overall length	300-200-430



Ø  
5.5 mm

### 0° DIRECTION OF VIEW

300mm working length 356mm overall length	300-155-400*
424mm working length 480mm overall length	300-255-400

### 30° DIRECTION OF VIEW

300mm working length 356mm overall length	300-155-430*
424mm working length 480mm overall length	300-255-430

## ICG/NIR 4K LAPAROSCOPES

Endoscopes for Indocyanine Green (ICG) and Near Infrared (NIR) Laparoscopy procedures in 4K Ultra High Definition.

# 4K

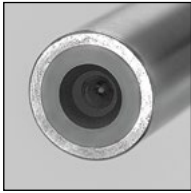

### 0° DIRECTION OF VIEW 300mm working length

Ø 10mm	300-700-400
Ø 5mm	300-755-400

### 30° DIRECTION OF VIEW 300mm working length

Ø 10mm	300-700-430
Ø 5mm	300-755-430

## FULL HD LAPAROSCOPES

High definition pictures with significant detail-resolution through newest CAD - designed rod - lens systems.

# FULL HD



### 0° DIRECTION OF VIEW

330mm working length 405mm overall length	300-091-100*
450mm working length 532mm overall length	300-091-430



### 30° DIRECTION OF VIEW

330mm working length 405mm overall length	300-091-130*
450mm working length 532mm overall length	300-091-433



### 45° DIRECTION OF VIEW

330mm working length 405mm overall length	300-091-145
450mm working length 532mm overall length	300-091-445

## FULL HD LAPAROSCOPES

High definition pictures with significant detail-resolution through newest CAD - designed rod - lens systems.

# FULL HD



∅  
5.5 mm



### 0° DIRECTION OF VIEW

300mm working length	300-092-100*
356mm overall length	
424mm working length	300-096-455
480mm overall length	



### 30° DIRECTION OF VIEW

300mm working length	300-092-130*
356mm overall length	
424mm working length	300-096-453
480mm overall length	



### 45° DIRECTION OF VIEW

300mm working length	300-092-145
356mm overall length	
424mm working length	300-096-450
480mm overall length	



∅  
2.9 mm

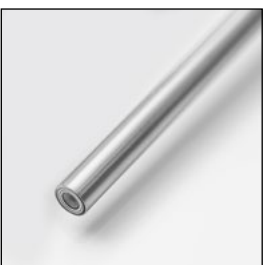

### 0° DIRECTION OF VIEW

207mm working length	300-097-100
270mm overall length	



### 30° DIRECTION OF VIEW

207mm working length	300-097-130
270mm overall length	



## FULL HD OPERATING LAPAROSCOPES

For 11 mm trocar systems and single puncture,  
6mm instrument channel

# FULL HD



Ø  
10 mm

### 0° DIRECTION OF VIEW

Parallel eye piece  
270mm length

300-099-006



Stopcock with 6mm instrument channel

for 300-099-006  
and 300-099-106  
(included)

300-099-500



Ø  
10 mm

### 0° DIRECTION OF VIEW

Lateral eye piece  
270mm length

300-099-106



## RECOMMENDATIONS FOR RZ LAPAROSCOPES

- Sterilization Containers and Trays for safe usage and storage:  
pages 157-167
- Ø 3.5mm, Ø 4.8mm light cables and adapter pieces to be used with all RZ Laparoscopes:  
page 179

# ADVANCED TROCAR SYSTEMS

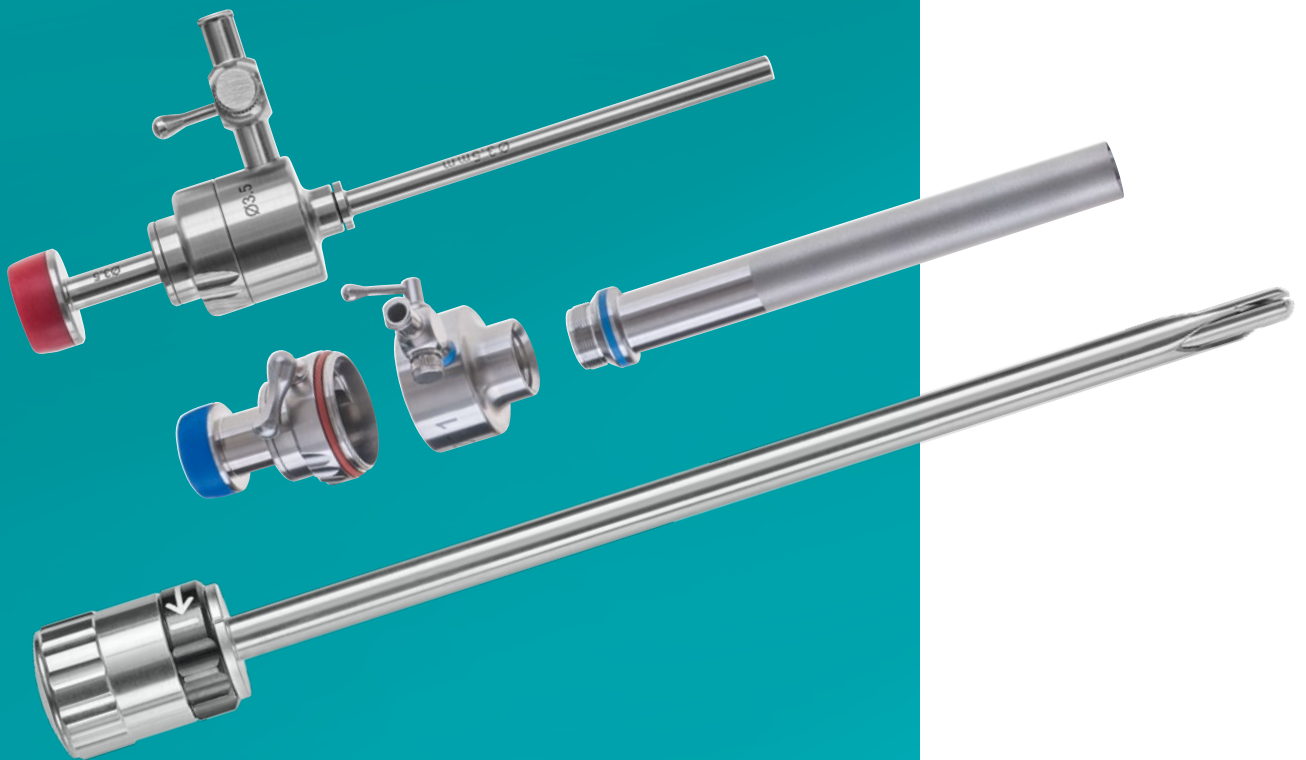



- 1 Reusable and autoclavable seals
- 2 Easy opening by pushing the lever
- 3 Stainless steel stopcock
- 4 Ergonomic stainless steel housing
- 5 Self-centering conical sleeve
- 6 Smooth stainless steel sleeve



Easy opening MultiPort System



Improved trap-door valves

## SILIPORT TROCAR SYSTEM



- 1 Reusable and autoclavable seals
- 2 Reusable and autoclavable silicon valve
- 3 Stainless steel stopcock
- 4 Lightweight synthetic housing
- 5 Self-centering conical sleeve
- 6 Synthetic threaded lightweight sleeve

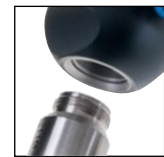

Highest safety due to stainless steel connections

Color code	∅
<span style="display: inline-block; width: 10px; height: 10px; background-color: gray; border-radius: 50%;"></span>	5.5mm
<span style="display: inline-block; width: 10px; height: 10px; background-color: blue; border-radius: 50%;"></span>	11.0mm
<span style="display: inline-block; width: 10px; height: 10px; background-color: green; border-radius: 50%;"></span>	13.0mm

MultiPort Trocar System



SiliPort Trocar System



## Multiport Trocar Sleeves, 100mm working length

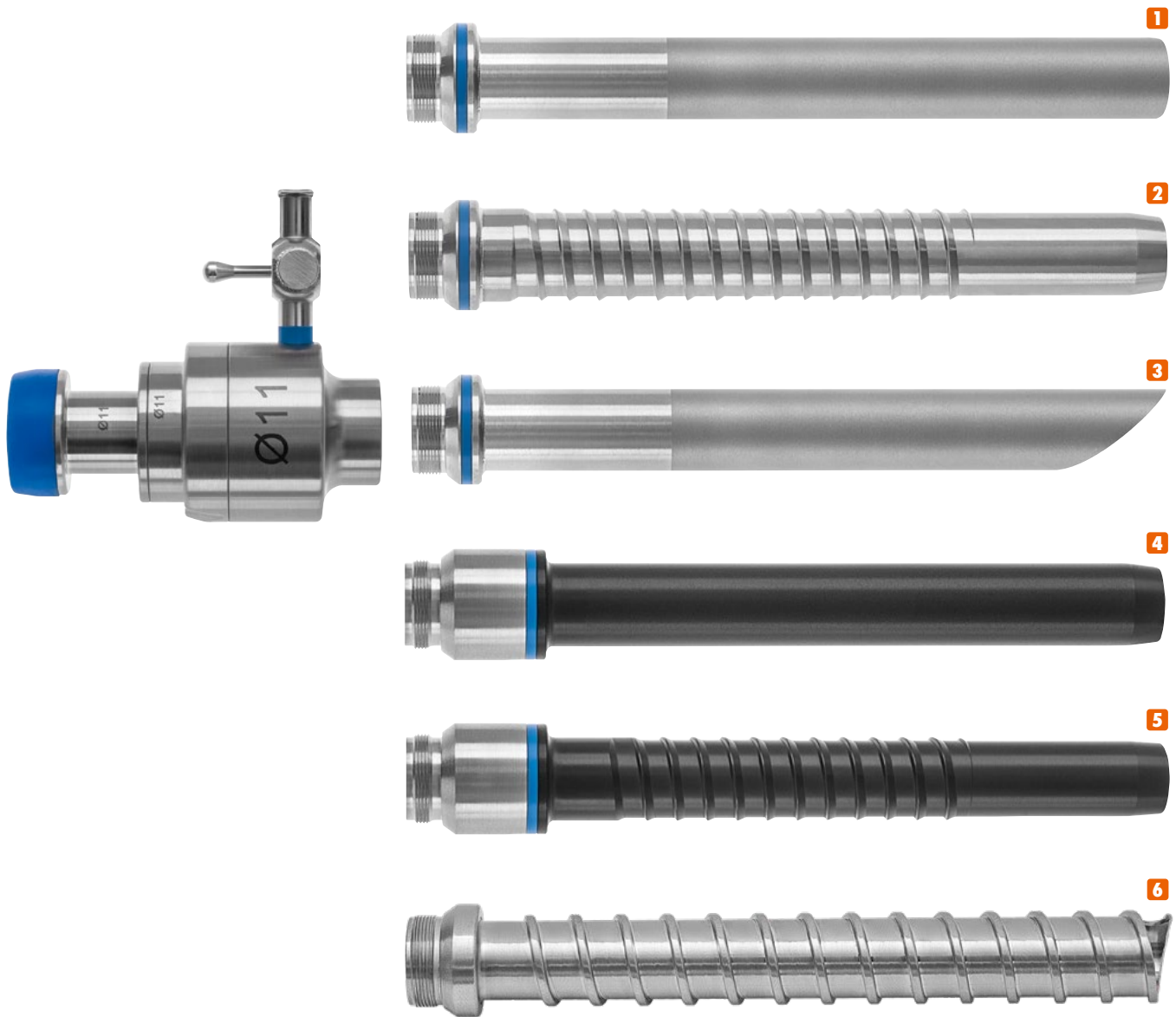

- 1** Stainless steel sleeve, smooth
- 2** Stainless steel sleeve, thread
- 3** Stainless steel sleeve, oblique
- 4** Synthetic sleeve, smooth
- 5** Synthetic sleeve, thread
- 6** Stainless Steel Sleeve, self-cutting

	Ø 5.5mm	Ø 11mm	Ø 13mm
1	300-220-055*	300-220-011*	300-220-013*
2	300-221-055	300-221-011	300-221-013
3	300-222-055*	300-222-011*	300-222-013*
4	300-223-055	300-223-011	300-223-013
5	300-224-055	300-224-011	300-224-013
6	300-226-055	300-226-011	300-226-013

Siliport Trocar Sleeves, 100mm working length

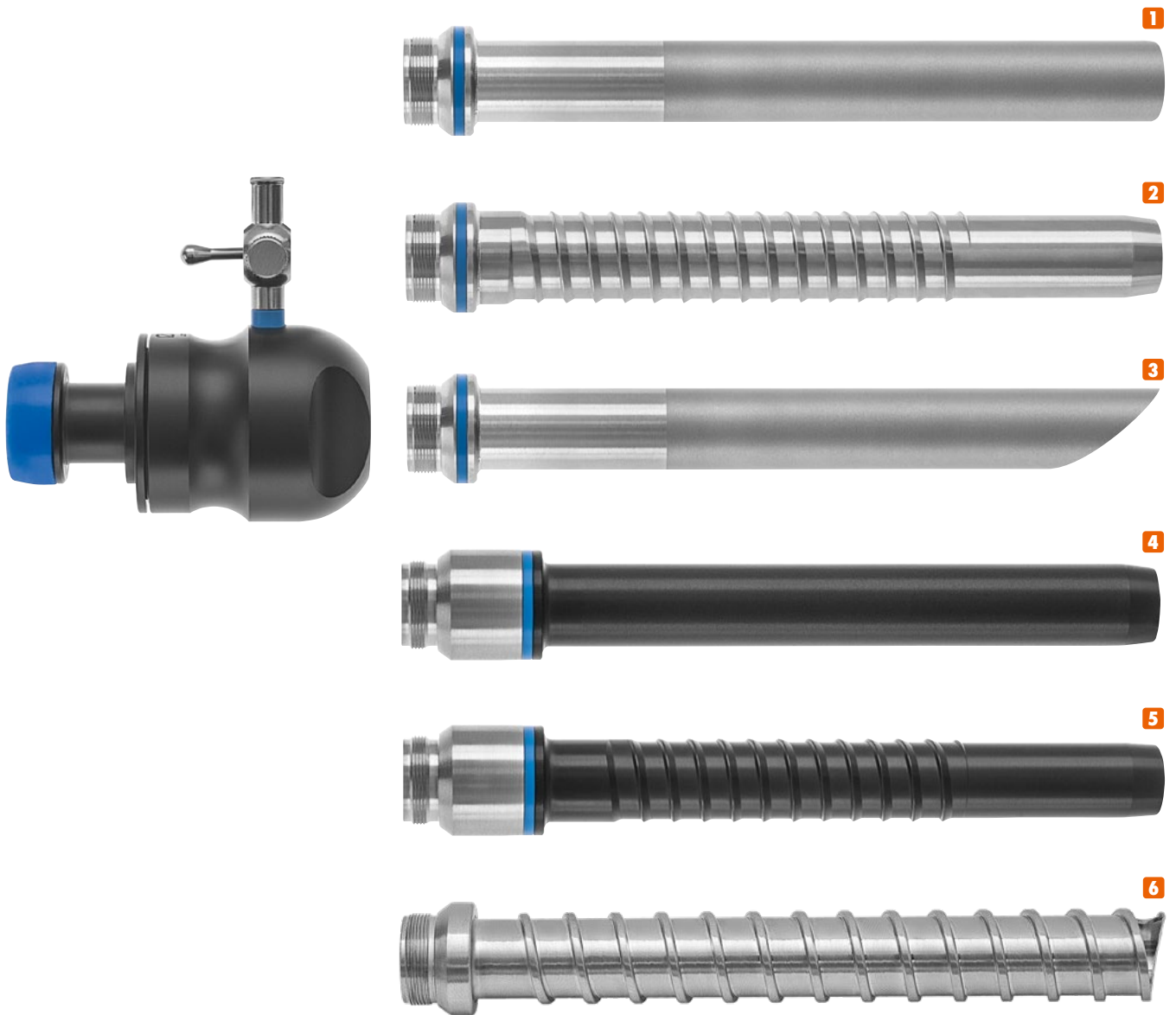

- 1** Stainless steel sleeve, smooth
- 2** Stainless steel sleeve, thread
- 3** Stainless steel sleeve, oblique
- 4** Synthetic sleeve, smooth
- 5** Synthetic sleeve, thread
- 6** Stainless Steel Sleeve, self-cutting

	Ø 5.5mm	Ø 11mm	Ø 13mm
1	300-230-055	300-230-011	300-230-013
2	300-231-055	300-231-011	300-231-013
3	300-232-055	300-232-011	300-232-013
4	300-233-055	300-233-011	300-233-013
5	300-234-055	300-234-011	300-234-013
6	300-236-055	300-236-011	300-236-013

## SPECIAL SIZED TROCAR SYSTEM



Stainless steel trocar with oblique sleeve, 109.9mm working length  
Ø 15mm 300-020-015

Stainless steel trocar with oblique sleeve, 118.7mm working length  
Ø 20mm 300-020-020

## PEDIATRIC TROCAR SYSTEM



Stainless steel trocar with smooth sleeve, 70mm working length  
Ø 3.5mm 300-112-035



## SPARE TROCAR SLEEVES



	Ø 5.5mm	Ø 11mm	Ø 13mm
<b>1</b> Stainless steel sleeve, smooth	300-220-255	300-220-211	300-220-213
<b>2</b> Stainless steel sleeve, thread	300-221-255	300-221-211	300-221-213
<b>3</b> Stainless steel sleeve, oblique	300-222-255	300-222-211	300-222-213
<b>4</b> Synthetic sleeve, smooth	300-233-255	300-233-211	300-233-213
<b>5</b> Synthetic sleeve, thread	300-234-255	300-234-211	300-234-213
<b>6</b> Stainless Steel Sleeve, self-cutting	300-236-255	300-236-211	300-236-213

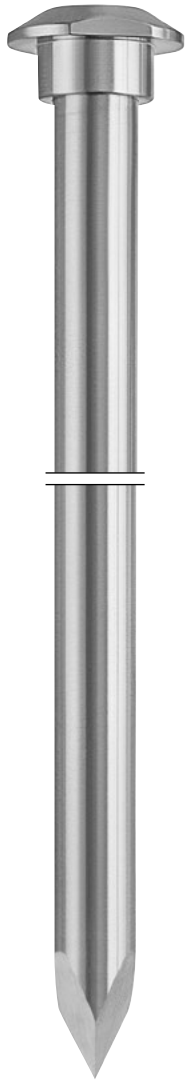

Standard trocar  
with pyramidal tip, reusable, cutting

300-241-035	Ø 3.5mm
300-241-055*	Ø 5.5mm
300-241-011*	Ø 11mm
300-241-013*	Ø 13mm
300-241-015	Ø 15mm
300-241-020	Ø 20mm

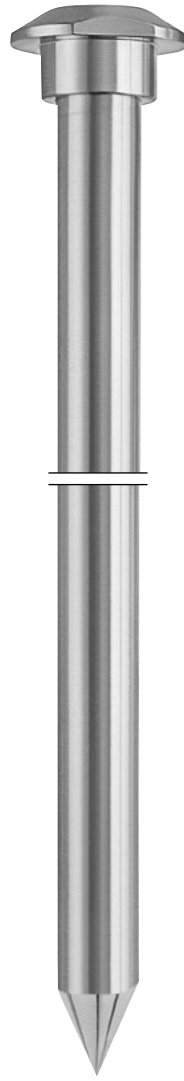

Standard trocar  
with conical tip, reusable, cutting

300-240-035	Ø 3.5mm
300-240-055*	Ø 5.5mm
300-240-011*	Ø 11mm
300-240-013*	Ø 13mm
300-240-015	Ø 15mm
300-240-020	Ø 20mm

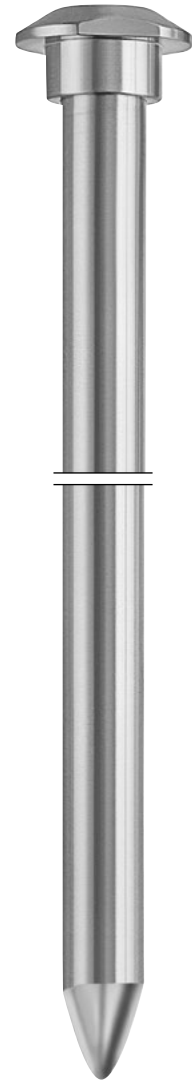

Hasson Obturator with blunt ball tip,  
reusable, atraumatic

300-242-035	Ø 3.5mm
300-242-055	Ø 5.5mm
300-242-011	Ø 11mm

### SAFETY TROCARS

- Avoids injuries in the abdomen
- Automatic self-locking shielding
- Shield covers the cutting edges
- Minimal Puncture wound due to rounded cutting edges



300-152-055\* 5.5 mm  
 300-152-011\* 11.0 mm  
 300-152-012 12.5 mm



Shielded trocar tip



Sharp trocar tip



Safety mechanism

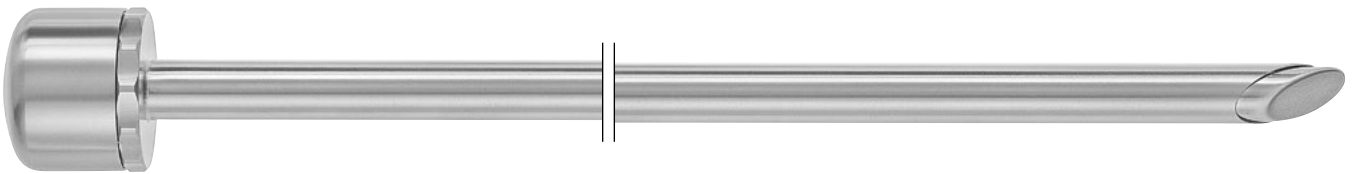

Safety trocar with oblique cutting edge

300-154-055 5.5 mm  
 300-154-011 11.0 mm  
 300-154-125 12.5 mm

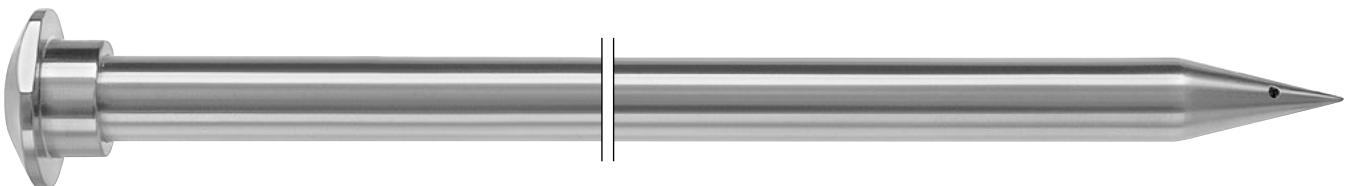

Cannulated trocars with hole, conical tip

300-243-055 5.5 mm  
 300-243-011 11.0 mm  
 300-243-013 13.0 mm

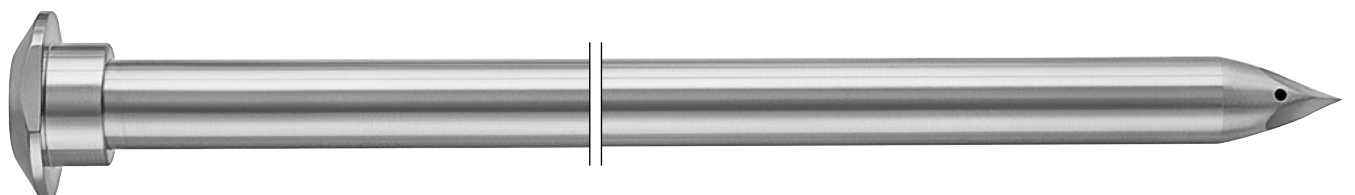

Cannulated trocars with hole, trocar point

300-244-055 5.5 mm  
 300-244-011 11.0 mm  
 300-244-013 13.0 mm

### SPARE PARTS



**1**  
Silicone seal insert for SiliPort  
Trocar System, 5 pieces  
300-025-358\* Ø 5.5mm  
300-025-359\* Ø 11mm  
300-025-359 Ø 13mm



**2**  
Sealing caps, color-coded, 10 pieces  
300-250-035 Ø 3.5mm (red)  
300-250-055\* Ø 5.5mm (white)  
300-250-011\* Ø 11mm (blue)  
300-250-013\* Ø 13mm (green)  
300-020-915 Ø 15mm (grey)  
300-020-920 Ø 20mm (grey)



**3**  
Gaskets for MultiPort Trocar System, 10 pieces  
300-250-235 Ø 3.5mm (black)  
300-250-255 Ø 5.5mm (white)  
300-250-211 Ø 11mm (blue)  
300-250-211 Ø 11mm (blue)  
300-250-213 Ø 13mm (green)  
300-020-215 Ø 15mm (blue)  
300-020-220 Ø 20mm (blue)

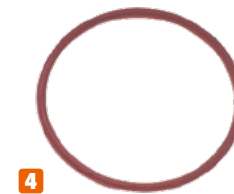

**4**  
Gaskets for MultiPort Trocar System, 10 pieces  
300-250-135 Ø 3.5mm / 5.5mm  
300-250-111 Ø 11mm / 13mm  
300-020-115 Ø 15mm  
300-020-120 Ø 20mm



Reducer clip with silicone band

for all RZ trocar systems

300-021-011\* Ø 11mm → 5.5 mm

300-021-125 Ø 12.5mm → 5.5 mm



Reducer clip with silicone band for

all RZ trocar systems

300-021-355\* Ø 11mm → 5.5 mm

300-021-380 Ø 11mm → 8.0 mm

300-021-305 Ø 13mm → 5.5 mm

300-021-310 Ø 13mm → 10.0 mm



Slide-reducer for all RZ Trocar Systems

300-021-455 Ø 11mm → 5.5 mm

300-021-405 Ø 13mm → 5.5 mm

300-021-410 Ø 13mm → 10.0 mm



Reducer Sleeve short, for all RZ modular trocar systems, 60mm

300-012-106 Ø 10mm → 5.0 mm

300-012-116 Ø 11mm → 5.5 mm

300-012-121 Ø 12.5mm → 5.5 mm

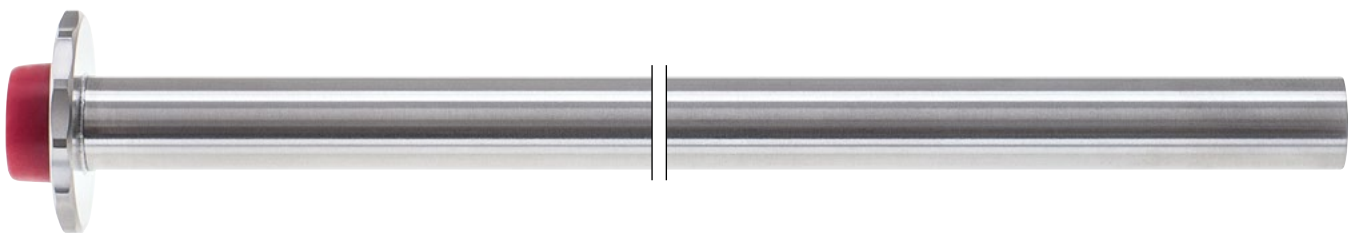

Reducer Sleeve long, for all RZ modular trocar systems, 190mm

300-012-405\* Ø 5.0mm → 4.0mm (red)\*

300-012-455\* Ø 10.0/11.0mm → 5.5mm (red)

300-012-410 Ø 12.5mm → 10.0mm (blue)

300-012-412 Ø 12.5mm → 5.5mm (red)

300-012-415 Ø 15.0mm → 10.0mm (blue)

300-012-416 Ø 15.0mm → 5.5mm (red)

300-012-425 Ø 20.0mm → 15.0mm (grey)

300-012-420 Ø 20.0mm → 10.0mm (blue)

300-012-421 Ø 20.0mm → 5.5mm (red)

\* 175mm



RZ Dilation Set

- 300-013-511 for 5.5 → 11.0 mm
- 300-013-510 for 5.5 → 10.0 mm
- 300-013-115 for 11.0 → 15.0 mm
- 300-013-512 for 5.5 → 12.5 mm
- 300-013-522 for 11.0 → 20.0 mm



Fixable sliding Hasson Cone with suture fixation device, for all RZ Modular Trocar Systems with smooth metal sleeves

- 300-014-155 Ø 5.5mm
- 300-014-111 Ø 11mm
- 300-014-113 Ø 13mm



Fixable sliding Hasson cone with suture fixation device, for all RZ Modular Trocar Systems with smooth metal sleeves

- 300-014-711 Ø 11mm

### FLEXIBLE TROCAR SYSTEM FOR THE USE OF CURVED INSTRUMENTS

- Complete Thorax trocar system
- For inserting curved or strongly curved jaws
- For 5mm and 10mm instruments

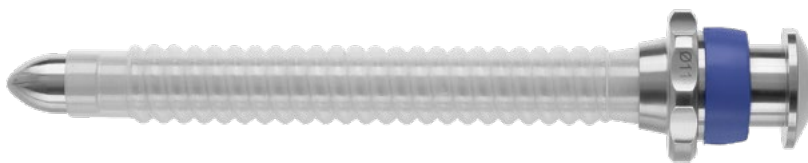
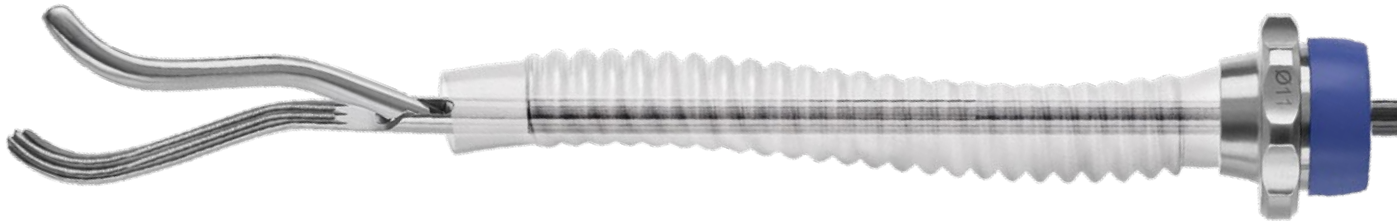

Thorax Trocar System, flexible, complete, Ø 11 mm  
 300-020-211 100 mm working length  
 300-020-711 70 mm working length



Thorax Trocar Sheath, Ø 11 mm,  
 for 100 mm  
 300-021-111



Thorax Trocar System, flexible, complete, Ø 5.5 mm  
 300-020-255 100 mm working length  
 300-020-755 70 mm working length



Thorax Trocar Sheath, Ø 5.5 mm  
 300-021-155 for 100 mm  
 300-021-755 for 70 mm



Obturator for flexible Thorax Trocar System  
 300-023-111 Ø 11.0mm, 100mm  
 300-023-711 Ø 11.0mm, 70mm  
 300-023-255 Ø 5.5mm, 100mm  
 300-023-755 Ø 5.5mm, 70mm



Gasket for Thorax Trocar System  
 Ø 11mm (package of 10 pcs.)  
 300-250-011 blue  
 300-250-055 white



Plastic Trocar Sleeve, flexible, package of 5 pieces  
 300-024-111 Ø 11.0mm, 100mm  
 300-024-711 Ø 11.0mm, 70mm  
 300-024-155 Ø 5.5mm, 100mm  
 300-024-755 Ø 5.5mm, 70mm



300-023-100 Endo Dilator Speculum, 195mm, with 3 blades, for symmetric dilation of the tissue during heavy tissue removal



300-098-105 Tissue retractor, S-shaped, pair with 2 pieces to expose anatomical layers

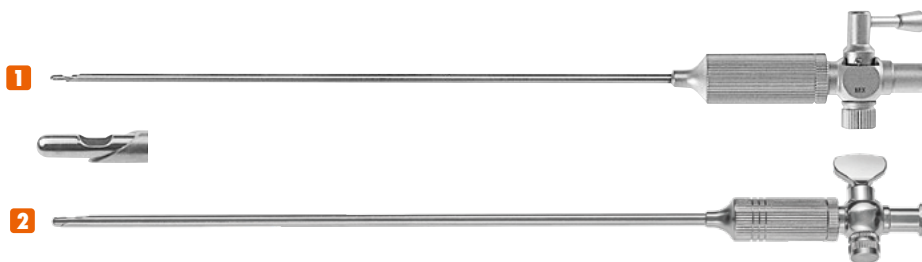

**1** Insufflation needle, matt chrome, Ø 2 mm

300-195-080	80 mm
300-195-100	100 mm*
300-195-120*	120 mm*
300-195-150	150 mm*
300-195-170	170 mm
300-195-200	200 mm

**2** Insufflation needle, polished chrome, Ø 2.7 mm, High-Flow

300-195-300	100 mm
300-195-320	120 mm*
300-195-350	150 mm*
300-195-370	170 mm*

\* standard length



# SUCTION AND IRRIGATION

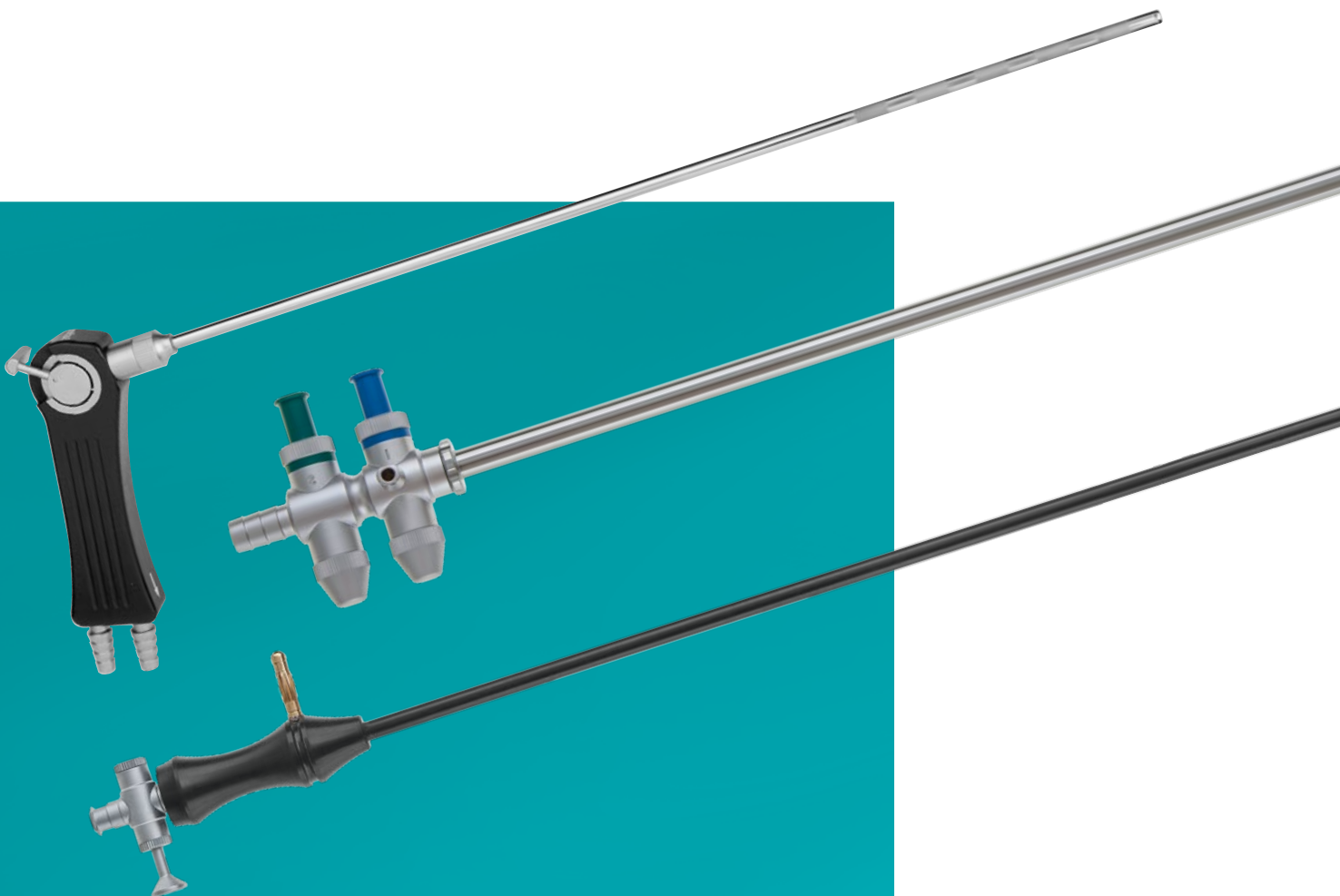

### RZ EASYCLEAN SUCTION AND IRRIGATION SYSTEM

- 2 color coded trumped valves
- Universal suction channel
- Lateral LuerLock irrigation channel



- 300-019-500\* Set with 5mm and 10mm suction tubes and large suction channel
- 300-019-501 Handle only, with large suction channel
- 300-019-600 Set with 5 mm and 10 mm suction tubes and small suction channel
- 300-019-601 Handle only, with small suction channel



- Suction and irrigation handle  
 300-019-501 large suction channel  
 300-019-601 small suction channel



- 300-019-780 Gasket O-Ring  
 1 set with 10 pieces



- 300-019-770 Spring  
 1 set with 10 pieces



Suction and irrigation tubes  
 for 300-019-500/501/600/601



4x 4 holes, 340mm working length



Ø 3mm

300-019-735



Ø 5mm

300-019-705



Ø 10mm

300-019-710



**300-165-100** Suction and irrigation handle with 2 trumpet valves, suction channel with large universal tube connector, irrigation channel with lateral LuerLock connection, removable ergonomic handle plate



**300-166-100\*** Pistol-shaped suction and irrigation handle with 2-way valve and 2 large universal tube connectors for suction and irrigation



**300-167-100** Suction and irrigation handle with 1 trumpet valve and large universal tube adapter

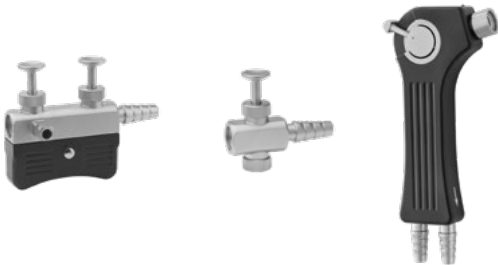

Suction and irrigation tubes, for 300-165-100, 300-166-100 and 300-167-100



4 holes, with markings, 340 mm working length



Ø 3mm

300-172-003



Ø 5mm

300-172-005\*



Ø 10mm

300-172-010\*



4x 4 holes, with markings, 340mm working length



Ø 3mm

300-173-003



Ø 5mm

300-173-005\*



Ø 10mm

300-173-010\*



300-192-000\* Suction and irrigation handle with rotating 2-way lever mechanism and 2 large universal tube adapters with LuerLock connector



Suction and irrigation tubes for 300-192-000



4 holes on the tip, with markings and LuerLock, 340 mm working length



Ø 3mm

300-192-003



Ø 5mm

300-192-005\*



Ø 10mm

300-192-010\*



4x 4 holes, with markings and LuerLock, 340mm working length



Ø 3mm

300-193-003



Ø 5mm

300-193-005\*



Ø 10mm

300-193-010\*



Suction or irrigation tube with LuerLock, 4 x 4 holes and stopcock, Ø 5 mm

300-006-305 330 mm working length  
300-006-455 450 mm working length

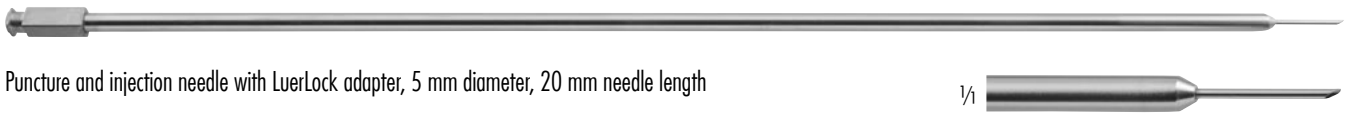

Puncture and injection needle with LuerLock adapter, 5 mm diameter, 20 mm needle length

	Needle tip	Working length	Needle length
300-194-307*	0.7 mm	330 mm	12mm
300-194-309*	0.9 mm	330 mm	20mm
300-194-312*	1.2 mm	330 mm	20mm
300-194-412	1.2 mm	450 mm	20mm
300-194-314*	1.4 mm	330 mm	20mm
300-194-414	1.4 mm	450 mm	20mm
300-194-318*	1.8 mm	330 mm	20mm
300-194-418	1.8 mm	450 mm	20mm



Palpation probe with markings and small handle

	Working length	Ø
300-193-305	330 mm	5mm
300-193-335*	330 mm	5mm
300-193-405	400 mm	5mm
300-193-410	400 mm	10mm













300-166-000 Pistol-shaped suction and irrigation handle with 2-way valve.  
Additional rotating HF connector for monopolar cables.  
2 large universal tube connectors for suction and irrigation.

## ELECTRODES

340mm working length



	J-hook Electrode, thin wire	300-163-100
	J-hook Electrode, thick wire	300-163-110
	L-hook Electrode	300-163-120
	Spatula Electrode	300-163-130
	Ballpoint Electrode	300-163-140
	Knife Electrode	300-163-150
	45° Needle Electrode	300-163-160
	Needle Electrode	300-163-170
	Cone Electrode	300-163-180
	Irrigation tube for use without HF	300-163-190

## ELECTRODES

with ceramic tip, 340mm working length



J-hook Electrode

300-163-810



L-hook Electrode

300-163-820



Spatula Electrode

300-163-830



Knife Electrode

300-163-850



45° Electrode

300-163-860



Needle Electrode

300-163-870



## COAGULATION ELECTRODES

with 4mm HF connector, Ø 5mm, 330mm working length



J-hook Electrode

300-100-132



L-hook Electrode

300-100-133\*



Spatula Electrode

300-100-131\*



Ballpoint Electrode

300-100-134

### HANDLE ELECTRODES

∅ 5mm, 360mm working length

- Large and ergonomic handle design
- Very fine tips
- Ceramic tip and PEEK shaft
- Suction connection optionally available



Without suction

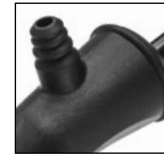

With suction



Spatula Electrode

300-144-002\*

300-145-003\*



J-hook Electrode

300-144-004

300-145-004\*



L-hook Electrode

300-144-005\*

300-145-005\*



Needle Electrode

300-144-006\*







300-145-006\*

### ELECTRODES

with 4mm HF connector, Ø 5mm, 340mm / 440mm working length

- Coagulation Suction / Irrigation Electrode
- Ergonomic handle
- Ceramic tip



		340mm	440mm
	J-hook Electrode	300-163-410	300-163-610
	L-hook Electrode	300-163-420	300-163-620*
	Spatula Electrode	300-163-430	300-163-630
	Knife Electrode	300-163-450	300-163-650
	45° Needle Electrode	300-163-460	300-163-660
	Needle Electrode	300-163-470	300-163-670

### MONOPOLAR CABLES



Generator end



RZ HF Unit Standard Plug

	4mm socket	4mm socket, angled	2mm plug	4mm plug	3mm socket	4mm plug
3m	700-501-303*					
5m	700-501-503					



RZ HF Unit SDS Plug

3m	700-501-300*					
5m	700-501-500*					



Erbe, Martin, Berchtold

3m	700-280-030*	700-290-030	700-291-030		700-292-030	700-293-033
5m	700-280-050*	700-290-050	700-291-050			700-293-035



Bovie, Valleylab, Conmed

3m	700-360-031*	700-361-030	700-362-030	700-363-030	700-364-030	700-370-030
5m	700-360-051*	700-361-050	700-362-050	700-363-050		700-370-050



Martin, Berchtold

3m	700-285-030*		700-286-030	700-286-130	700-286-230	
5m	700-285-050*		700-286-050			



Erbe ACC/ICC

3m	700-101-030	700-102-030	700-103-030		700-286-230	
5m	700-101-050		700-103-050		700-104-050	

## RING HANDLE INSTRUMENTS

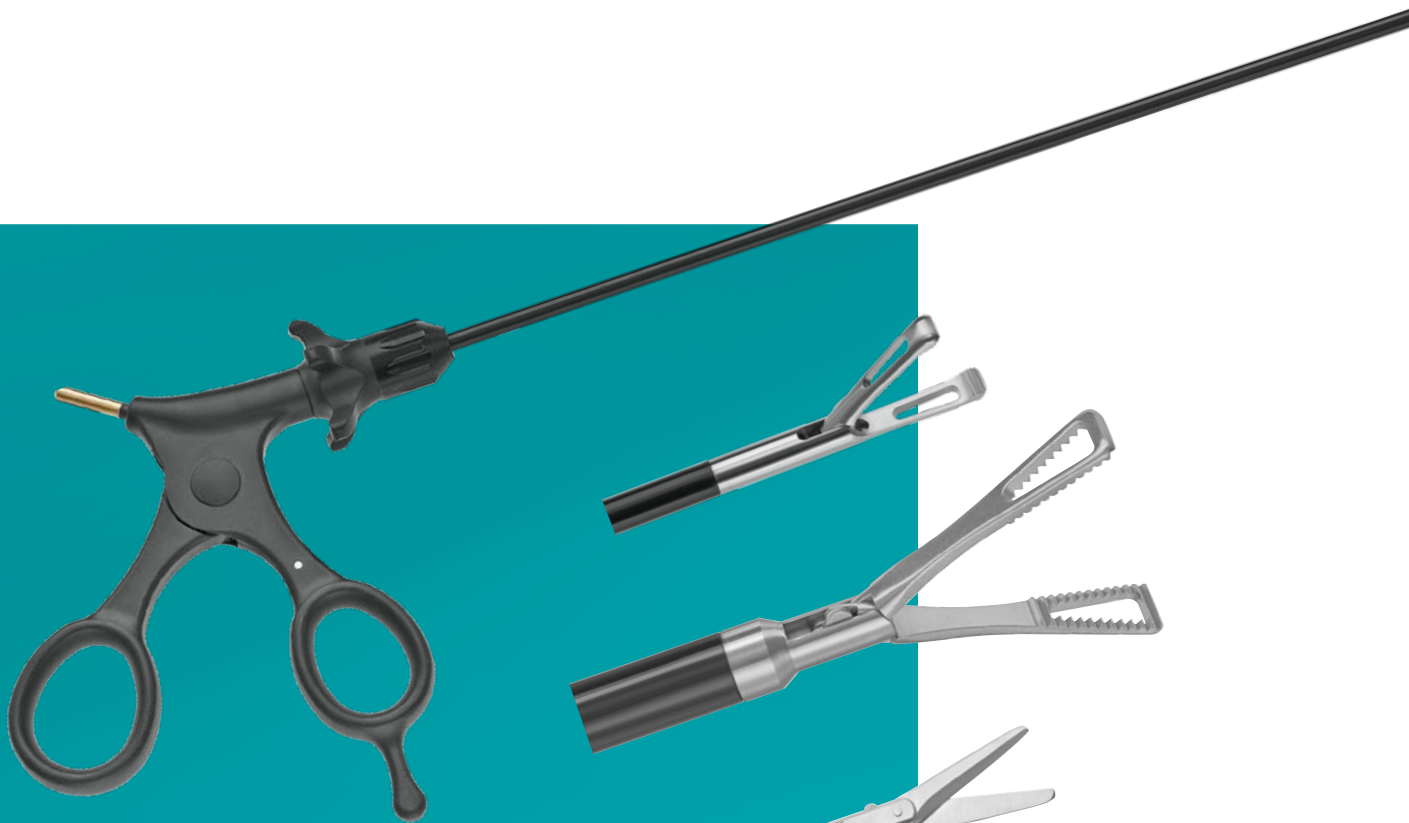

## Handles



300-750-101\*  
PEEK Polymer Handle with  
HF - connection



300-750-103\*  
PEEK Polymer Handle with ratchet  
and HF - connection



300-750-105\*  
PEEK Polymer Handle with hook up  
ratchet and HF - connection



300-750-106\*  
PEEK Polymer Handle with swing-away  
ratchet, rotatable and HF - connection



300-750-001  
Carbon Fiber Handle, rotating,  
HF - connection



300-750-003  
Carbon Fiber Handle, rotating,  
with ratchet, HF - connection



300-750-015  
Axial Handle with catch for needle holder  
fixed, for all needle holder inserts,  
with two gold rings

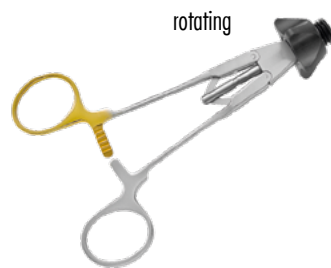

300-750-115  
Axial Handle with catch, rotating,  
for standard instrument,  
with one golden ring



300-750-215  
Axial Handle without catch,  
non rotating, for standard instrument,  
with two gold rings

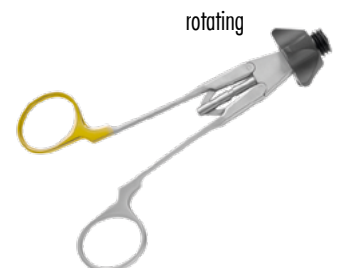

300-750-315  
Axial Handle without catch, rotating,  
for standard instrument, with one gold ring



Outer Sheath, insulated, adaptable to all handles, Ø 5 mm

210 mm 300-550-005  
 330 mm 300-660-005\*  
 450 mm 300-760-005\*

- exchangeable color coding locking nuts
- advantages in handling and cleaning
- strengthening of the shaft through a partial thickening at the proximal end



Outer Sheath, insulated, adaptable to all handles, Ø 10 mm

210 mm 300-550-010  
 330 mm 300-660-010\*  
 450 mm 300-760-010\*



Outer Sheath, insulated, adaptable to all handles, with LuerLock

Ø 5 mm 210 mm 300-550-105  
 Ø 10 mm 210 mm 300-550-110  
 Ø 5 mm 330 mm 300-660-105  
 Ø 10 mm 330 mm 300-660-110  
 Ø 5 mm 450 mm 300-760-105  
 Ø 10 mm 450 mm 300-760-110



300-400-900  
 Rubber Seals for LuerLock connectors  
 sales unit: 5 pcs.

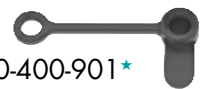

300-400-901\*  
 Rubber Seals for LuerLock connectors  
 sales unit: 5 pcs.



Locking Nuts

300-661-005 5mm ●  
 300-661-010 10mm ●  
 300-661-006 5mm ●  
 300-661-007 5mm ●  
 300-661-008 5mm ●  
 300-661-004 5mm ●  
 300-661-009 3.5mm\* ●



300-661-006OR  
 Sealing ring, package of  
 10 pieces,  
 autoclavable

\* for 3.5mm Mini Laparoscopy instruments



## 3-PIECE MODULAR INSTRUMENT

- Long-life and reliable materials
- Large variety of handle designs
- Ratchet mechanism / deactivation

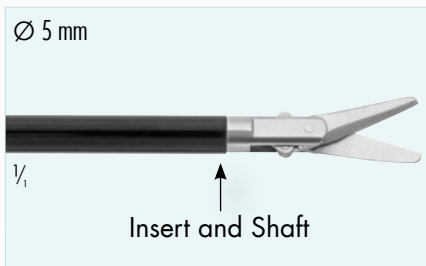

insert only

300-400-067

↑  
Insert's Catalogue-No.

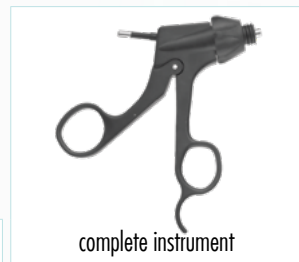

complete instrument  
300-410-067

↑  
Catalogue-No. of the  
complete Instrument

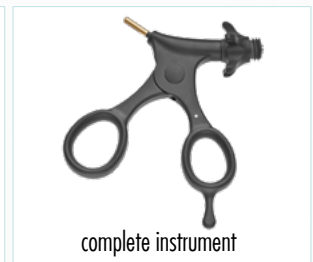

complete instrument  
300-420-067

↑  
Catalogue-No. of the  
complete Instrument

\*Each piece can be ordered separately

\*Each piece can be ordered separately





Watch the video on  
YouTube



The RZ spherical head locking system for fast assembling / disassembling



Modular 3-piece detachable instrument system consists of:



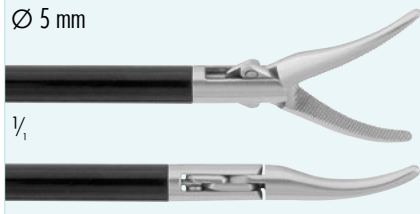

Catalogue-No. for insert only

300-400-732\*



Complete Instrument  
with handle 300-750-001

300-410-732



Complete Instrument  
with handle 300-750-101

300-420-732\*

### KELLY

Dissecting forceps curved, slightly tapered, cross-serrated jaws, wide opening, double action, Ø 5 mm, 330 mm

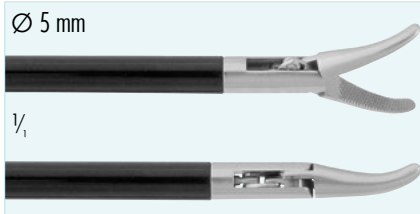

300-400-733

300-410-733

300-420-733

### BABY KELLY

Short dissecting and suturing forceps, curved, tapered, cross-serrated jaws, wide opening, double action, Ø 5 mm, 330 mm

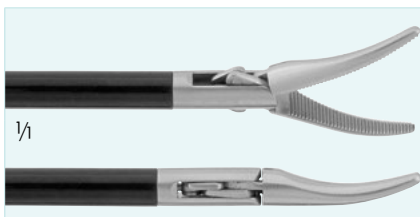

300-400-731\*

300-410-731

300-420-731\*

### MARYLAND

Extra fine dissector with slightly tapered tip and gently curved for precise dissection, Ø 5 mm, 330 mm



300-400-738\*

300-410-738

300-420-738\*

### MIXTER

Fine dissecting forceps, 90° angled, fine serrated jaws, double action, Ø 5 mm, 330 mm

Ø 5 mm



1/1

insert only

300-400-735\*



Complete Instrument  
with handle 300-750-001

300-410-735



Complete Instrument  
with handle 300-750-101

300-420-735\*

### RIGHT ANGLE

Dissecting grasping forceps, fine serrated jaws, double action, Ø 5 mm, 330 mm

Ø 10 mm

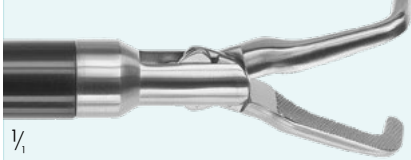

1/1

300-400-736\*

300-410-736

300-420-736\*

### RIGHT ANGLE

Dissecting grasping forceps, fine serrated jaws, double action, Ø 10 mm, 330 mm

Ø 10 mm

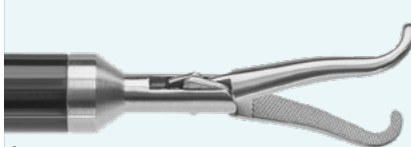

1/1

300-400-741

300-410-741

300-420-741

### OVERHOLT

Dissecting forceps 90° angled jaws, double action, Ø 10 mm, 330 mm

Ø 10 mm

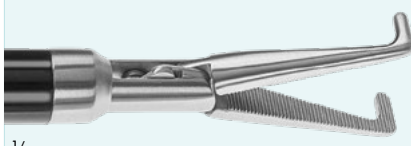

1/1

300-400-740

300-410-740

300-420-740

### MIXTER

Dissecting forceps, 10 mm long tip, 90° angled jaws, double action, Ø 10 mm, 330 mm

Ø 5 mm



1/1

300-400-027

300-410-027

300-420-027

### PETELIN

Dissecting forceps, single action jaws, angled 60° left. deep serrations, Ø 5 mm, 330 mm

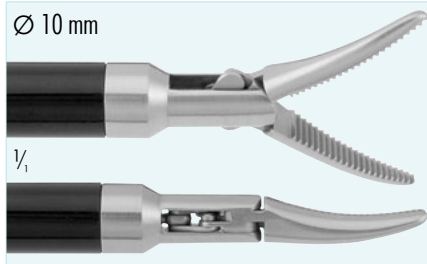

insert only  
300-400-730

Complete Instrument  
with handle 300-750-001  
300-410-730

Complete Instrument  
with handle 300-750-101  
300-420-730

### MARYLAND

Dissecting forceps curved left, blunt jaws, double action, Ø 10 mm, 330 mm

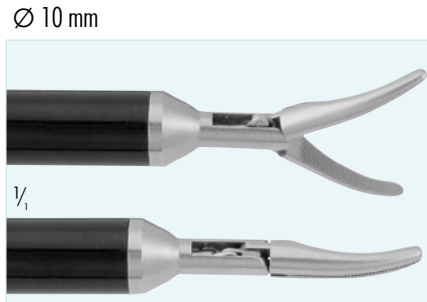

300-400-734

300-410-734

300-420-734

### MIXTER 45°

Dissecting forceps curved with long fine serrated jaws, double action, Ø 10 mm, 330 mm

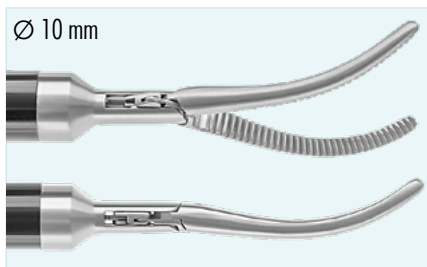

300-400-737

300-410-737

300-420-737

### OVERHOLT-MIXTER

Dissecting forceps curved with slim long serrated jaws, double action, Ø 10 mm, 330 mm



300-400-739\*

300-410-739

300-420-739\*

### MIXTER 90°

Dissecting forceps 90° angled, serrated jaws, double action, Ø 10 mm, 330 mm



insert only  
300-400-044



Complete Instrument  
with handle 300-750-001  
300-410-044



Complete Instrument  
with handle 300-750-101  
300-420-044

### ADHESION FORCEPS

Serrated jaws, one fenestrated, double action, ∅ 5 mm, 330 mm

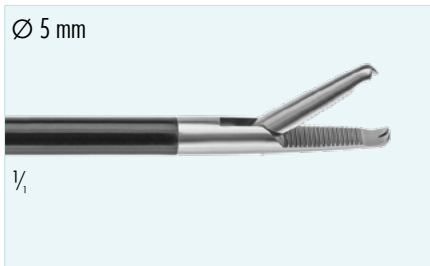

300-400-109

300-410-109

300-420-109

### GRASPING FORCEPS

1x2 teeth, single action, ∅ 5 mm, 330 mm



300-400-251\*

300-410-251

300-420-251\*

### BABCOCK

Grasping forceps, single action, ∅ 5 mm, 330 mm

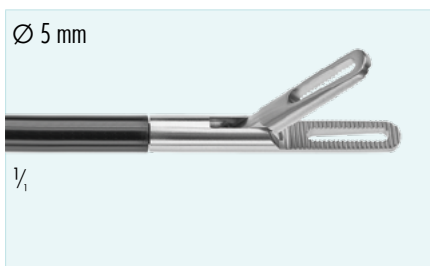

300-400-023

300-410-023

300-420-023

### JOHANS

Grasping forceps, fenestrated jaws, serrated, 12mm, single action, ∅ 5 mm, 330 mm

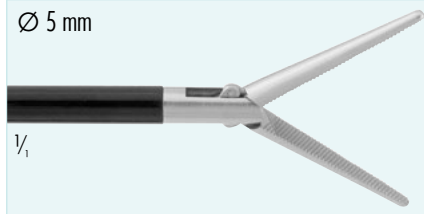

insert only
300-400-016*



300-410-016
-------------



300-420-016*
--------------

### NEEDLE NOSE

Dissecting and grasping forceps with tapered and fine, cross-serrated jaws, double action, Ø 5 mm, 330 mm



300-400-003
-------------

300-410-003
-------------

300-420-003
-------------

### NEEDLE NOSE

Dissecting and grasping forceps with tapered and fine, cross-serrated jaws, single action, Ø 5 mm, 330 mm



300-400-040
-------------

300-410-040
-------------

300-420-040
-------------

### FENESTRATED BULLNOSE

Dissecting and grasping forceps with delicate, fenestrated and flat jaws, deep serration, double action, Ø 5 mm, 330 mm

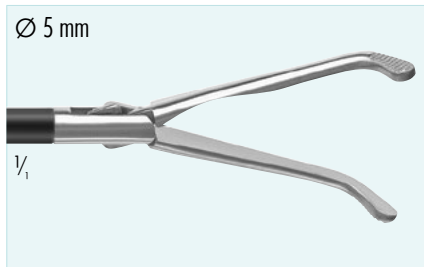

300-400-610
-------------

300-430-610
-------------

300-440-610
-------------

### PYLORUS

Spreader, double action, Ø 5 mm, 330 mm



insert only
-------------



300-400-025*
--------------

300-410-025
-------------

300-420-025*
--------------

300-430-025
-------------

300-440-025*
--------------

### DOLPHIN

Dissecting and grasping forceps with biopsy cup and fine serrated and tapered jaws, double action, Ø 5 mm, 330 mm



insert only  
300-400-012\*

Complete Instrument with handle 300-750-003  
300-430-012

Complete Instrument with handle 300-750-103  
300-440-012\*

**JAEGER**  
Grasping forceps with fenestrated jaws, DeBakey serration, 20 mm, double action, Ø 5 mm, 330 mm

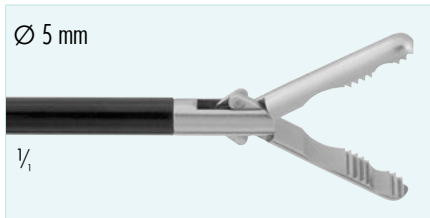

300-400-015\*

300-430-015

300-440-015\*

**FUNDUS**  
Grasping forceps with 2 cups and serrated jaws, double action, Ø 5 mm, 330 mm



300-400-005

300-430-005

300-440-005

**BULLDOG**  
Grasping forceps with fine serrated jaws, single action, Ø 5 mm, 330 mm

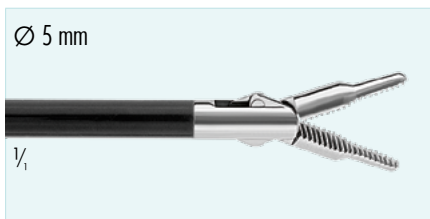





300-400-021

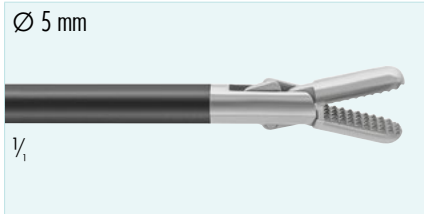

300-430-021

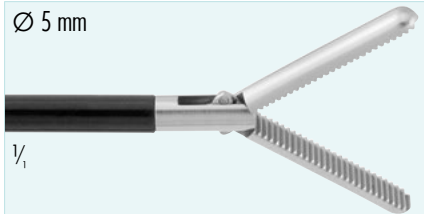
300-440-021

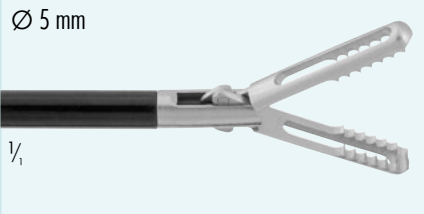
**DOLPHIN**  
Grasping and dissecting forceps with fine serrated tapered jaws, double action, Ø 5 mm, 330 mm

	insert only	Complete Instrument with handle 300-750-003	Complete Instrument with handle 300-750-103	Complete Instrument with handle 300-750-105
 <p>Ø 5 mm 1/1</p>	300-400-001*	300-430-001	300-440-001*	300-460-001*
<b>BULLNOSE</b> Grasping forceps, heavy pattern, standard serrated jaws, double action, Ø 5 mm, 330 mm				
 <p>Ø 5 mm 1/1</p>	300-400-008	300-430-008	300-440-008	300-460-008
<b>STRONG TC GRASPER</b> Grasping forceps with Tungsten Carbide jaw inserts, heavy pattern, pyramidal tip, serrated jaws, double action, Ø 5 mm, 330 mm				
 <p>Ø 5 mm 1/1</p>	300-400-029*	300-430-029	300-440-029*	300-460-029*
<b>STRONG TC GRASPER</b> Grasping forceps with Tungsten Carbide jaw inserts, heavy pattern, pyramidal tip, serrated, 15 mm long jaws, double action, Ø 5 mm, 330 mm				
 <p>Ø 5 mm 1/1</p>	300-400-002	300-430-002	300-440-002	300-460-002
<b>XL BULLNOSE</b> Grasping forceps, standard serrated jaws, double action, Ø 5 mm, 330 mm				
 <p>Ø 5 mm 1/1</p>	300-400-000	300-430-000	300-440-000	300-460-000
<b>STANDARD</b> Grasping forceps with biopsy cup, heavy pattern, standard serrated jaws, double action, Ø 5 mm, 330 mm				
 <p>Ø 5 mm 1/1</p>	300-400-017*	300-430-017	300-440-017*	300-460-017*
<b>GRIPPER #1</b> Grasping forceps with coarse-serrated, fenestrated jaws, double action, Ø 5 mm, 330 mm				

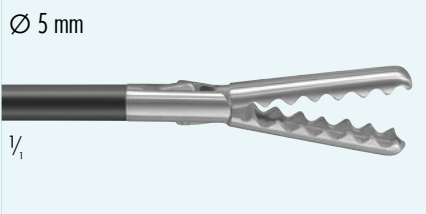

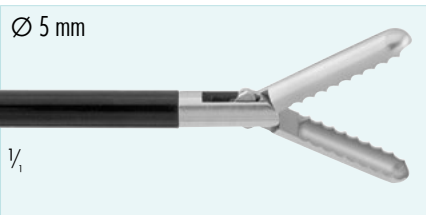

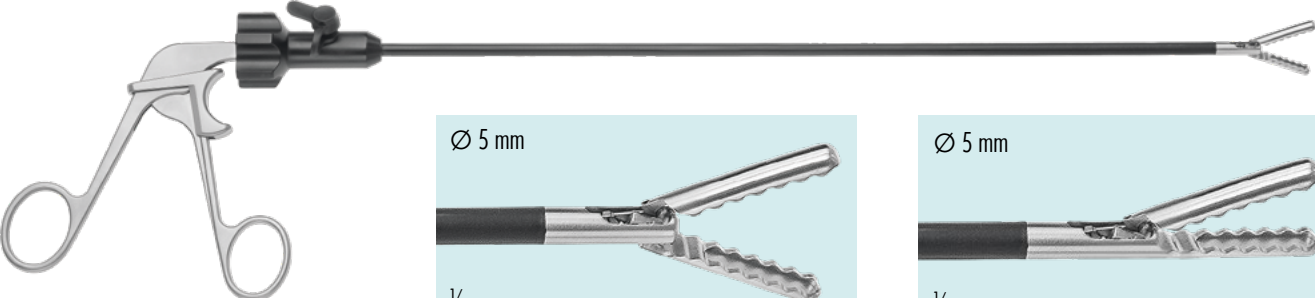
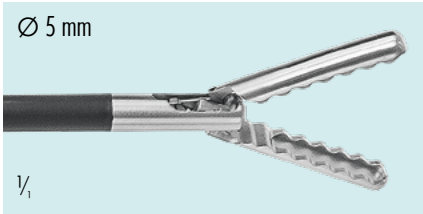
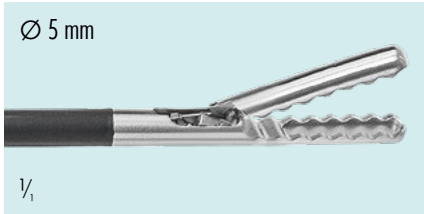

	insert only	Complete Instrument with handle 300-750-003	Complete Instrument with handle 300-750-103	Complete Instrument with handle 300-750-105
 <p>Ø 5 mm 1/1</p> <p><b>PRESTIGE</b> Atraumatic grasping forceps with long, wave shaped jaws and deep cup with lateral serration, double action, Ø 5 mm, 330 mm</p>	300-400-013*	300-430-013	300-440-013*	300-460-013*
 <p>Ø 5 mm 1/1</p> <p><b>PRESTIGE</b> Grasping Forceps, wave-shaped lateral serration, and deep cup, single action, atraumatic, Ø 5 mm, 330 mm</p>	300-400-033*	300-430-033	300-440-033*	300-460-033*
 <p>Ø 5 mm 1/1</p> <p><b>ALLIGATOR</b> Grasping forceps with fine sharp lateral teeth and deep cup, double action, Ø 5 mm, 330 mm</p>	300-400-053	300-430-053	300-440-053	300-460-053

## NON-DETACHABLE PRESTIGE FORCEPS

Complete Instrument, rotating, insulated, with prestige handle and Luer-Lock connection, 330mm working length

	 <p>Ø 5 mm 1/1</p> <p>300-111-013 Double action jaws</p>	 <p>Ø 5 mm 1/1</p> <p>300-111-033 Single action jaws</p>
--	---	---

	insert only	Complete Instrument with handle 300-750-003	Complete Instrument with handle 300-750-103	Complete Instrument with handle 300-750-105
 <p>Ø 5 mm 1/1</p> <p><b>KOCHER</b> Grasping forceps with aggressive 3 x 4 teeth and serrated inner jaws, double action, Ø 5 mm, 330 mm</p>	300-400-004*	300-430-004	300-440-004*	300-460-004*
 <p>Ø 5 mm 1/1</p> <p><b>KOCHER</b> Grasping forceps with aggressive 2 x 4 teeth and serrated inner jaws, single action, Ø 5 mm, 330 mm</p>	300-400-006	300-430-006	300-440-006	300-460-006
 <p>Ø 5 mm 1/1</p> <p><b>ALLIS</b> Grasping forceps with 1 x 2 teeth and smooth inner jaws, single action, Ø 5 mm, 330 mm</p>	300-400-014	300-430-014	300-440-014	300-460-014
 <p>Ø 5 mm 1/1</p> <p><b>ALLIS</b> Grasping forceps with 1 x 2 teeth and serrated inner jaws, double action, Ø 5 mm, 330 mm</p>	300-400-009	300-430-009	300-440-009	300-460-009
 <p>Ø 5 mm 1/1</p> <p><b>COBRA</b> Grasping forceps with sharp 2 x 4 teeth and serrated inner jaws, double action, Ø 5 mm, 330 mm</p>	300-400-201*	300-430-201	300-440-201*	300-460-201*



insert only  
300-400-011\*

Complete Instrument  
with handle 300-750-003  
300-430-011

Complete Instrument  
with handle 300-750-103  
300-440-011\*

Complete Instrument  
with handle 300-750-105  
300-460-011\*

### MARTIN

Grasping forceps with multiple fine serrations, 4.8 mm wide jaws, single action, Ø 5 mm, 330 mm



300-400-713\*

300-430-713

300-440-713\*

300-460-713\*

### CLAW GRASPER

Grasping forceps, aggressive 2 x 3 teeth and smooth inner jaws, single action, Ø 5 mm, 330 mm



300-401-713

300-431-713

300-441-713

300-461-713

### CLAW GRASPER

Grasping forceps, aggressive 2 x 3 teeth and smooth inner jaws, single action, Ø 5 mm, 450 mm

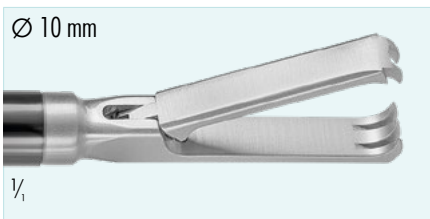

300-400-710\*

300-430-710

300-440-710\*

300-460-710\*

### CLAW GRASPER

Grasping forceps, aggressive 2 x 3 teeth and smooth inner jaws, single action, Ø 10 mm, 330 mm



300-400-717

300-430-717

300-440-717

300-460-717

### DAVIS

Grasping forceps, blunt interlocking 2 x 3 teeth and long ridged inner jaws, double action, Ø 5 mm, 330 mm

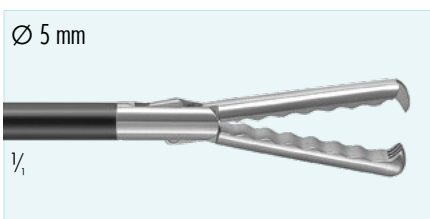

300-400-715

300-430-715





300-440-715

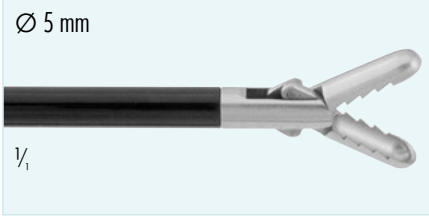
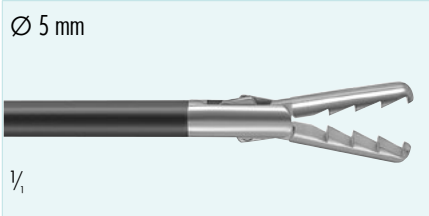
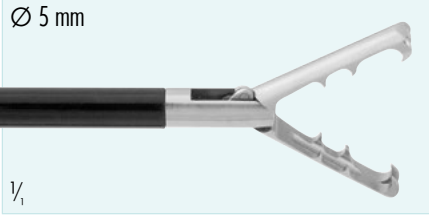
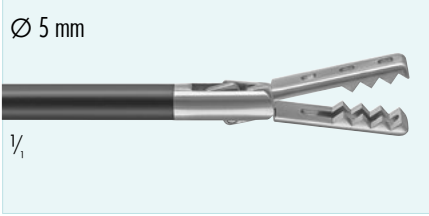
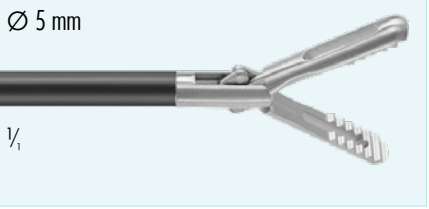

300-460-715

### ST. ANDREWS

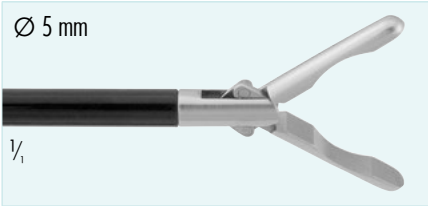
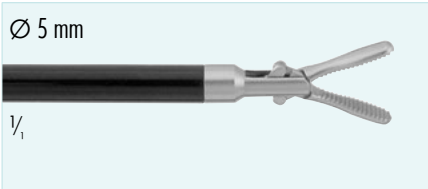
Grasping forceps, with sharp 2 x 4 teeth and wave shaped inner jaws, double action, Ø 5 mm, 330 mm

	insert only	Complete Instrument with handle 300-750-003	Complete Instrument with handle 300-750-103	Complete Instrument with handle 300-750-105
 <p>Ø 5 mm 1/1</p>	300-400-051	300-430-051	300-440-051	300-460-051
<p><b>ALLIGATOR SPOON</b></p> <p>Grasping forceps with cupped jaws, aggressive retrograde lateral teeth, double action, Ø 5 mm, 330 mm</p>				
 <p>Ø 5 mm 1/1</p>	300-400-010*	300-430-010	300-440-010*	300-460-010*
<p><b>ALLIGATOR</b></p> <p>Grasping forceps with strong retrograde serrations, double action, Ø 5 mm, 330 mm</p>				
 <p>Ø 5 mm 1/1</p>	300-400-048	300-430-048	300-440-048	300-460-048
<p><b>SHARK</b></p> <p>Grasping forceps with very sharp and aggressive lateral retrograde teeth, double action, Ø 5 mm, 330 mm</p>				
 <p>Ø 5 mm 1/1</p>	300-400-018	300-430-018	300-440-018	300-460-018
<p><b>CLINCH</b></p> <p>Grasping forceps with strong serration and fenestrated jaws, double action, Ø 5 mm, 330 mm</p>				
 <p>Ø 5 mm 1/1</p>	300-400-049	300-430-049	300-440-049	300-460-049
<p><b>ENDOCLINCH</b></p> <p>Grasping forceps, wave-shaped, fenestrated, double action, Ø 5 mm, 330 mm</p>				

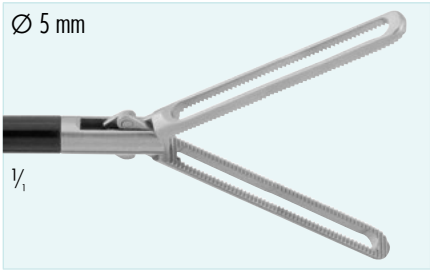
	insert only	Complete Instrument with handle 300-750-003	Complete Instrument with handle 300-750-103
 <p>Ø 5 mm 1/1</p> <p><b>PIN GRASPER</b> Grasping Forceps with fine 1x2 teeth, smooth inner jaws, double action, Ø 5 mm, 330 mm</p>	300-400-042	300-410-042	300-420-042
 <p>Ø 5 mm 1/1</p> <p><b>OVARY</b> Grasping forceps with fine serrated, wave shaped jaws, double action, Ø 5 mm, 330 mm</p>	300-400-045	300-410-045	300-420-045
 <p>Ø 5 mm 1/1</p> <p><b>TUBAL</b> Dissecting and grasping forceps with smooth jaws, double action, Ø 5 mm, 330 mm</p>	300-400-046	300-410-046	300-420-046
 <p>Ø 5 mm 1/1</p> <p><b>DUCKBILL</b> Grasping and dissecting forceps with flat jaws, fine serrations, double action, Ø 5 mm, 330 mm</p>	300-400-024	300-410-024	300-420-024
 <p>Ø 5 mm 1/1</p> <p><b>PETITE</b> Micro Grasping Forceps, double action, fenestrated, fine jaw, fine serration</p>	300-400-032	300-410-032	300-420-032
 <p>Ø 5 mm 1/1</p> <p><b>PETELIN</b> Grasping and Dissecting Forceps with serrated jaws, curved left, single action, Ø 5 mm, 330 mm</p>	300-400-026	300-410-026	300-420-026

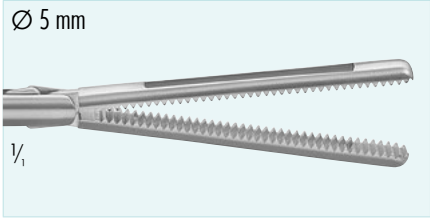
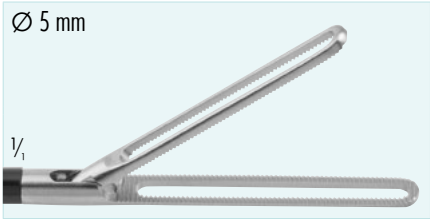
	insert only	Complete Instrument with handle 300-750-003	Complete Instrument with handle 300-750-103	Complete Instrument with handle 300-750-105
 <p>Ø 5 mm 1/1</p> <p><b>JOHANS</b> Grasping forceps with 20 mm fenestrated jaws, double action, Ø 5 mm, 330 mm</p>	300-400-289*	300-430-289	300-440-289*	300-470-289*
 <p>Ø 5 mm 1/1</p> <p><b>LONG JOHANS</b> Grasping forceps with 40 mm fenestrated jaws, double action, Ø 5 mm, 330 mm</p>	300-400-291*	300-430-291	300-440-291*	300-470-291*
 <p>Ø 5 mm 1/1</p> <p><b>DORSEY</b> Grasping forceps with 12 mm fenestrated jaws, double action, Ø 5 mm, 330 mm</p>	300-400-285*	300-430-285	300-440-285*	300-470-285*
 <p>Ø 5 mm 1/1</p> <p><b>LONG DORSEY</b> Grasping forceps with 45 mm fenestrated jaws, double action, Ø 5 mm, 330 mm</p>	300-400-287	300-430-287	300-440-287	300-470-287
 <p>Ø 5 mm 1/1</p> <p><b>LONG JOHANS</b> Grasping forceps with 40 mm fenestrated jaws, single action, Ø 5 mm, 330 mm</p>	300-400-288	300-430-288	300-440-288	300-470-288



insert only
300-400-284*

Complete Instrument with handle 300-750-003
300-430-284

Complete Instrument with handle 300-750-103
300-440-284*

Complete Instrument with handle 300-750-105
300-470-284*

**JOHANS**  
Grasping forceps with 20 mm fenestrated jaws, single action, Ø 5 mm, 330 mm



300-400-310*
300-400-312**

300-430-310
300-430-312*

300-440-310*
300-440-312**

300-470-310*
300-470-312**

**MARQUES**  
Grasping forceps with 2 fenestrations, single action, Ø 5 mm, 330 mm  
\* with 3 fenestrations



300-400-314*
--------------

300-430-314
-------------

300-440-314*
--------------

300-470-314*
--------------

**MARQUES**  
Grasping forceps with 2 fenestrations, bent up, single action, Ø 5 mm, 330 mm

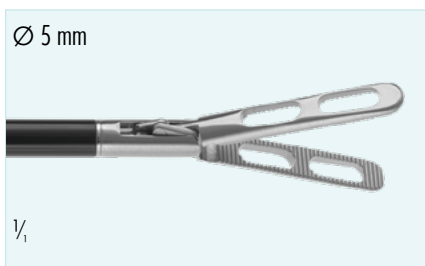

300-400-311
300-400-313*

300-430-311
300-430-313*

300-440-311
300-440-313*

300-470-311
300-470-313*

**MARQUES**  
Grasping forceps with 2 fenestrations, double action, Ø 5 mm, 330 mm  
\* with 3 fenestrations

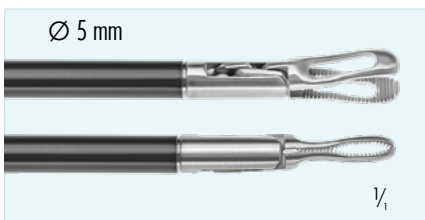







300-400-052*
--------------

300-430-052
-------------

300-440-052*
--------------

300-470-052*
--------------

**GRASPER**  
Atraumatic Grasping forceps with fenestrated jaws, fine serrations, double action, Ø 5 mm, 330 mm

<p>Ø 5 mm</p>  <p>1/1</p>	<p>insert only</p>	 <p>Complete Instrument with handle 300-750-001</p>	 <p>Complete Instrument with handle 300-750-101</p>
	<p>300-400-080*</p>	<p>300-410-080</p>	<p>300-420-080*</p>
<p>Biopsy forceps with 2 pinholes, sharp oval cups, double action, Ø 5 mm, 330 mm</p>			
<p>Ø 5 mm</p>  <p>1/1</p>	<p>300-400-082</p>	<p>300-410-082</p>	<p>300-420-082</p>
<p>Biopsy forceps with sharp oval cups, double action, Ø 5 mm, 330 mm</p>			
<p>Ø 5 mm</p>  <p>1/1</p>	<p>300-400-521</p>	<p>300-410-521</p>	<p>300-420-521</p>
<p>Biopsy forceps with 2 pins, sharp oval cups, single action, Ø 5 mm, 330 mm</p>			
<p>Ø 5 mm</p>  <p>1/1</p>	<p>300-400-086</p>	<p>300-410-086</p>	<p>300-420-086</p>
<p><b>BLAKESLEY</b> Biopsy forceps with sharp cups, single action, Ø 5 mm, 330 mm</p>			
<p>Ø 5 mm</p>  <p>1/1</p>	<p>300-400-100</p>	<p>300-410-100</p>	<p>300-420-100</p>
<p>Hook punch forceps, thru-cutting, single action, Ø 5 mm, 330 mm</p>			



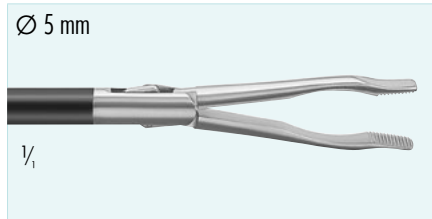

insert only
300-400-250



300-400-250	300-430-250	300-440-250	300-470-250
-------------	-------------	-------------	-------------

**BABCOCK PADDLE**  
Grasping forceps with flat paddles and fine serration for atraumatic grip of delicate tissue, double action, Ø 5 mm, 330 mm

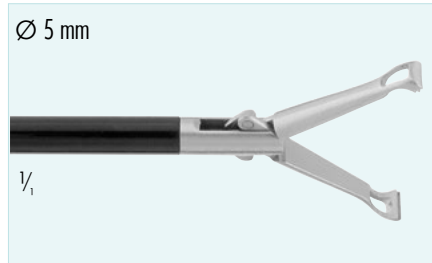

300-400-252*	300-430-252	300-440-252*	300-470-252*
--------------	-------------	--------------	--------------

**BABCOCK**  
Traditional style Babcock grasping forceps, rounded jaws with fine serrations, double action, Ø 5 mm, 330 mm

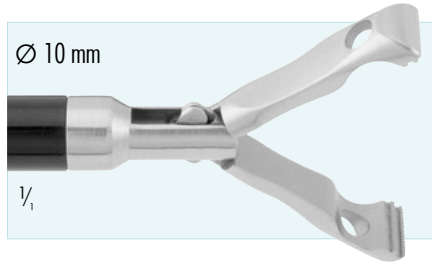

300-400-079	300-430-079	300-440-079	300-470-079
-------------	-------------	-------------	-------------

**DEBAKEY BABCOCK**  
Traditional style Babcock grasping forceps, rounded jaws with atraumatic DeBaKey serration, double action, Ø 10 mm, 330 mm

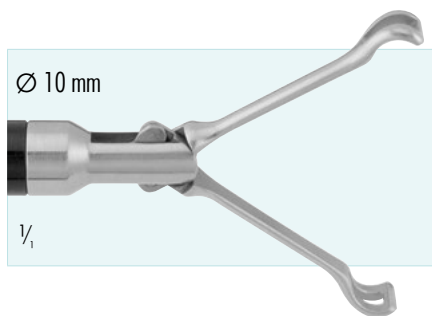

300-400-078*	300-430-078	300-440-078*	300-470-078*
--------------	-------------	--------------	--------------

**BABCOCK**  
Traditional style Babcock grasping forceps with medium jaws, rounded jaws with fine serrations, double action, Ø 10 mm, 330 mm

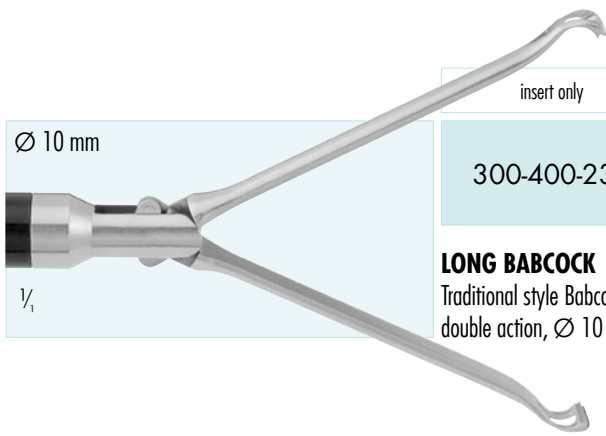

insert only  
300-400-234

Complete Instrument  
with handle 300-750-003  
300-430-234

Complete Instrument  
with handle 300-750-103  
300-440-234

Complete Instrument  
with handle 300-750-105  
300-470-234

### LONG BABCOCK

Traditional style Babcock grasping forceps with long jaws, rounded jaws with fine serrations, double action, ∅ 10 mm, 330 mm

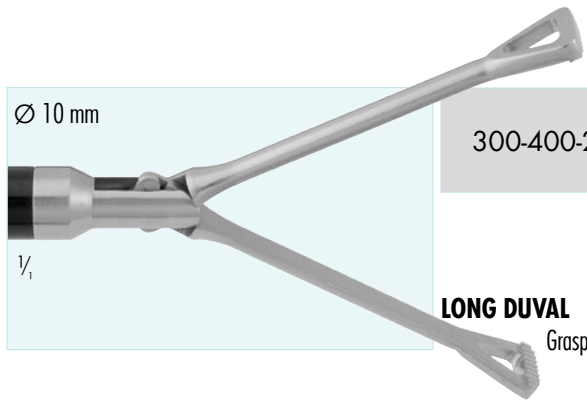

300-400-280

300-430-280

300-440-280

300-470-280

### LONG DUVAL

Grasping forceps with long jaws, V-shaped tip with fine serrations, double action, ∅ 10 mm, 330 mm

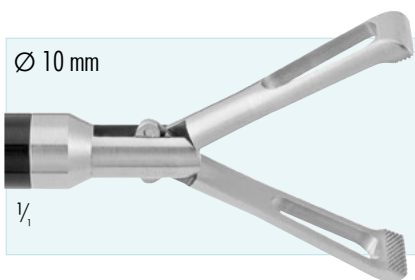

300-400-084





300-430-084

300-440-084

300-470-084

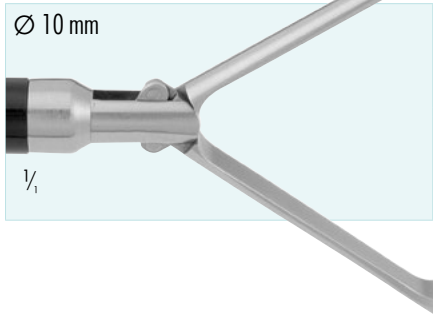
### COLLIN-DUVAL

Grasping forceps, V-shaped tip with fine serrations on the tip, double action, ∅ 10 mm, 330 mm

 <p>Ø 10 mm</p> <p>1/1</p>	insert only	 <p>Complete Instrument with handle 300-750-003</p>	 <p>Complete Instrument with handle 300-750-103</p>	 <p>Complete Instrument with handle 300-750-105</p>
	300-400-074	300-430-074	300-440-074	300-470-074

**ALLIS**

Traditional Allis grasping forceps, with fine serrations on the tip, double action, Ø 10 mm, 330 mm

 <p>Ø 5 mm</p> <p>1/1</p>	300-400-097	300-430-097	300-440-097	300-470-097
---	-------------	-------------	-------------	-------------

**SLIM ALLIS**

Grasping forceps with delicate jaws and with fine serrations on the tip, double action, Ø 5 mm, 330 mm

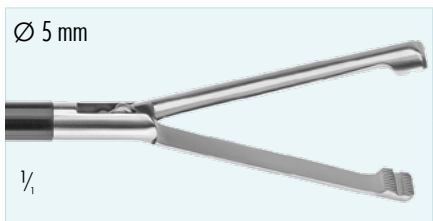
 <p>Ø 5 mm</p> <p>1/1</p>	300-400-197	300-430-197	300-440-197	300-470-197
--	-------------	-------------	-------------	-------------

**ALLIS**

Bowell grasping forceps, 4 mm x 35 mm, double action, Ø 5 mm, 330 mm

 <p>Ø 10 mm</p> <p>1/1</p>	300-400-085*	300-430-085	300-440-085*	300-470-085*
---	--------------	-------------	--------------	--------------

**COLLIN**

Grasping forceps, V-shaped tip with deep serrations for firm grip, double action, Ø 10 mm, 330 mm



insert only  
300-400-243

Complete Instrument  
with handle 300-750-003  
300-430-243

Complete Instrument  
with handle 300-750-103  
300-440-243

Complete Instrument  
with handle 300-750-105  
300-460-243

**DEBAKEY**

Pick-up forceps with fine 22 mm long atraumatic serrations, 38 mm jaws, double action, Ø 5 mm, 330 mm

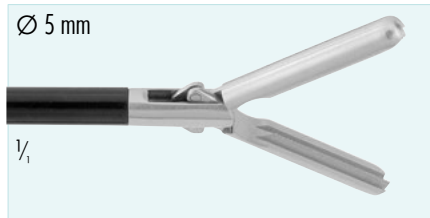

300-400-244

300-430-244

300-440-244

300-460-244

**DEBAKEY**

Atraumatic grasping forceps, fine atraumatic serrations, double action, 25 mm jaws, Ø 5 mm, 330 mm



300-400-245

300-430-245

300-440-245

300-460-245

**DEBAKEY**

Atraumatic grasping forceps, fine atraumatic serrations, double action, 40 mm jaws, Ø 5 mm, 330 mm

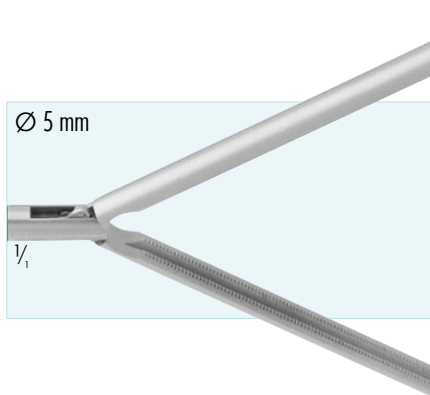

300-400-246

300-430-246

300-440-246

300-460-246

**DEBAKEY**

Atraumatic grasping forceps, fine atraumatic serrations, double action, 60 mm jaws, Ø 5 mm, 330 mm

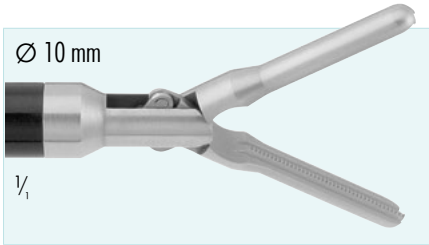

insert only
300-400-263

Complete Instrument with handle 300-750-003
300-430-263

Complete Instrument with handle 300-750-103
300-440-263

Complete Instrument with handle 300-750-105
300-460-263

**DEBAKEY**  
Atraumatic grasping forceps, fine atraumatic serrations, double action, 25 mm jaws, Ø 10 mm, 330 mm

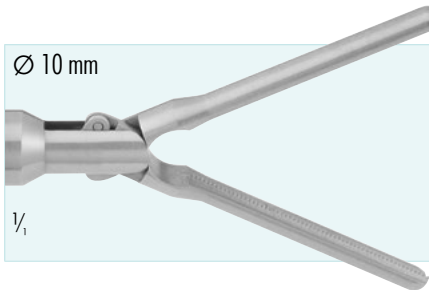

300-400-264
-------------

300-430-264
-------------

300-440-264
-------------

300-460-264
-------------

**DEBAKEY**  
Atraumatic grasping forceps, fine atraumatic serrations, double action, 40 mm jaws, Ø 10 mm, 330 mm

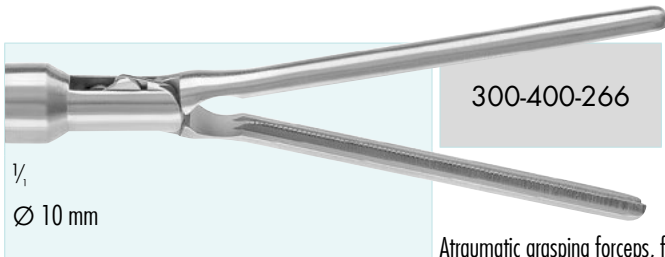

300-400-266
-------------

300-430-266
-------------

300-440-266
-------------

300-460-266
-------------

**DEBAKEY**  
Atraumatic grasping forceps, fine atraumatic serrations, double action, 60 mm jaws, Ø 10 mm, 330 mm

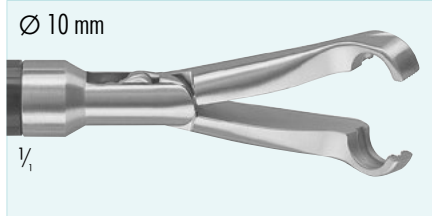

insert only  
300-400-295



300-430-295



300-440-295



300-460-295

**ANVIL**  
Grasping forceps with specially shaped jaws to grasp and hold the anvil of a circular stapler, double action, Ø 10 mm, 330 mm



300-400-286

300-430-286

300-440-286

300-460-286

**DORSEY**  
Grasping forceps, fenestrated jaws with medium serrations, double action, Ø 10 mm, 330 mm

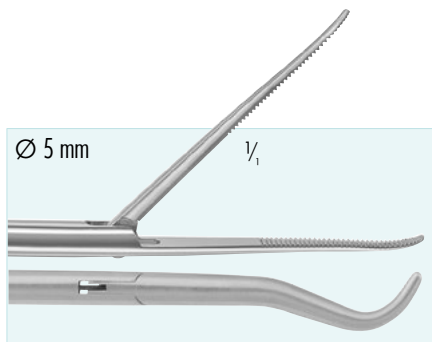

300-400-030

300-430-030

300-440-030

300-460-030

**GEEGEE**  
Dissecting and grasping forceps with fine jaws, strongly curved and fine serrations, single action, Ø 5 mm, 330 mm

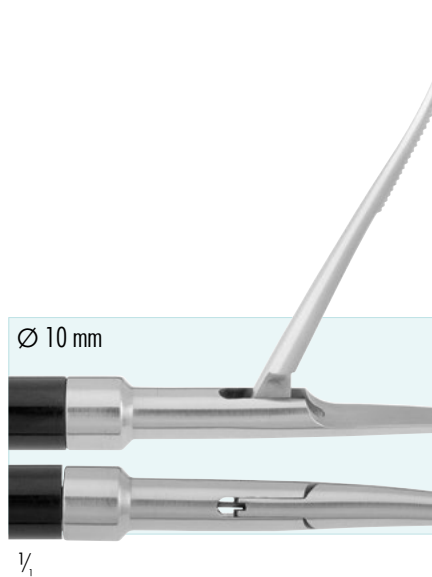

300-400-076

300-430-076

300-440-076

300-460-076

**GEEGEE**  
Dissector and grasping forceps with fine jaws, strongly curved and fine serration, single action, Ø 10 mm, 330 mm

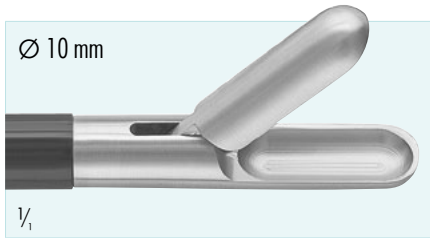

insert only  
300-400-720\*

Complete Instrument  
with handle 300-750-003  
300-430-720

Complete Instrument  
with handle 300-750-103  
300-440-720\*

Complete Instrument  
with handle 300-750-105  
300-460-720\*

### SPOON

Forceps with sharp, cup-shaped jaws for tissue or stone removal, **single action**, Ø 10 mm, 330 mm

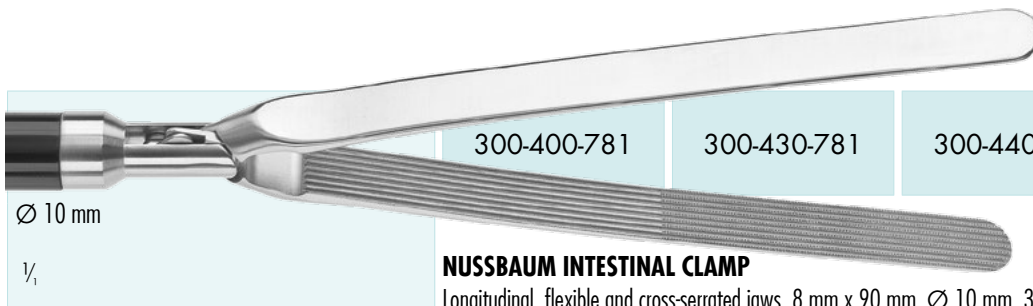

300-400-781

300-430-781

300-440-781

300-460-781

### NUSSBAUM INTESTINAL CLAMP

Longitudinal, flexible and cross-serrated jaws, 8 mm x 90 mm, Ø 10 mm, 330 mm

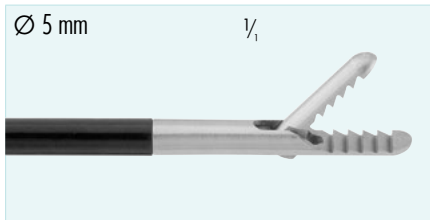

300-400-700

300-430-700

300-440-700

300-460-700

### RETROGRADE

Grasping and extracting forceps with deep retrograde serration for a secure grip of tissue, **single action**, Ø 5 mm, 330 mm

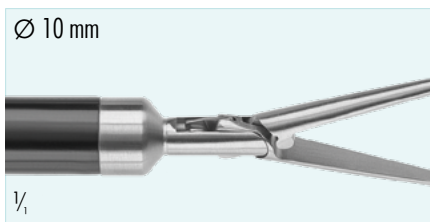

300-400-753\*

300-430-753

300-440-753\*

300-460-753\*

### TENACULUM FORCEPS

35mm long jaws, **double action**, Ø 10 mm, 330 mm

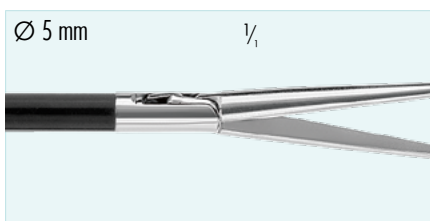

300-400-751\*

300-430-751

300-440-751\*

300-460-751\*

### TENACULUM FORCEPS

35mm long jaws, **double action**, Ø 5 mm, 330 mm



Complete Instrument  
with handle 300-750-015

insert only

Ø 5 mm

300-400-200\*

300-490-200

1/1

### SATINSKY

Grasping Forceps, 50 mm atraumatic jaws, Ø 5 mm, 330 mm

Ø 5 mm

300-400-202

300-490-202

1/1

### SATINSKY

Grasping Forceps, 40 mm atraumatic jaws, Ø 5 mm, 330 mm

Ø 5 mm

300-400-206



300-490-206

1/1

### CRAFOORD

Thorax clamp, 50 mm atraumatic jaws, Ø 5 mm, 330 mm



 <p>Ø 5 mm</p> <p>1/1</p>	<p>insert only</p> <p>300-400-204</p>	 <p>Complete Instrument with handle 300-750-015</p> <p>300-490-204</p>
	<p><b>CRAFOORD</b> Thorax clamp, 35 mm atraumatic jaws, Ø 5 mm, 330 mm</p>	

 <p>Ø 5 mm</p> <p>1/1</p>	<p>300-400-220*</p>	<p>300-490-220</p>
	<p><b>DEBAKEY</b> Pulmonary atraumatic Clamp, curved shape, Ø 5 mm, 330 mm</p>	

 <p>Ø 5 mm</p> <p>1/1</p>	<p>300-400-221</p>	<p>300-490-221</p>
	<p><b>DEBAKEY</b> Pulmonary atraumatic Clamp, s-shaped, Ø 5 mm, 330 mm</p>	

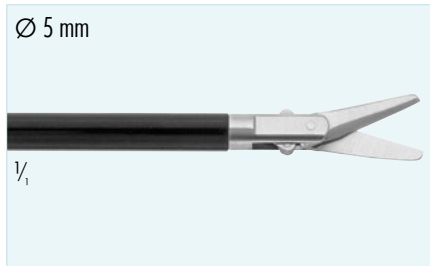

insert only

300-400-067\*



300-410-067



300-420-067\*

### ORIGINAL METZENBAUM

Scissors, short blades (12 mm), slightly curved, double action, Ø 5 mm, 330 mm

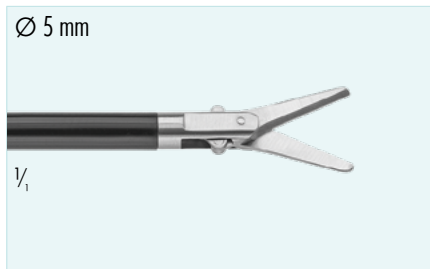

300-400-069\*

300-410-069

300-420-069\*

### METZENBAUM

Scissors, short blades (12 mm), straight, double action, Ø 5 mm, 330 mm



300-400-172

300-410-172

300-420-172

### METZENBAUM

Scissors, short, with **Diamond Dusted** blades (12 mm), curved, double action, Ø 5 mm, 330 mm



300-400-168

300-410-168

300-420-168

### METZENBAUM

Scissors, medium, with **Diamond Dusted** blades (15 mm), straight, double action, Ø 5 mm, 330 mm

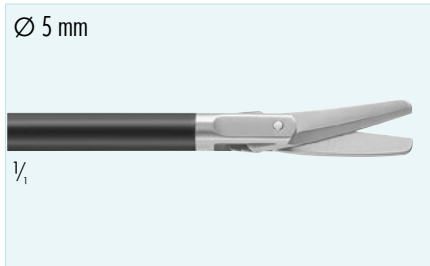

insert only

300-400-072\*

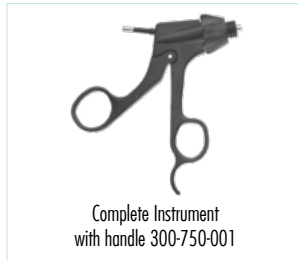

300-410-072

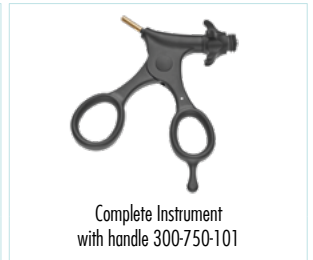

300-420-072\*

### METZENBAUM

Scissors, medium blades (15 mm), slightly curved, double action, Ø 5 mm, 330 mm

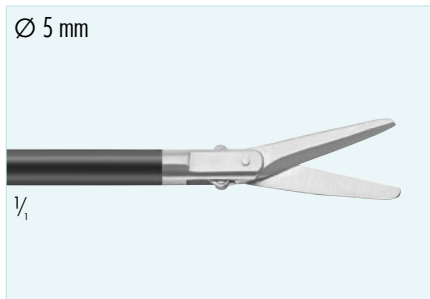

300-400-070\*

300-410-070

300-420-070\*

### METZENBAUM

Scissors, long blades (18 mm), slightly curved, double action, Ø 5 mm, 330 mm

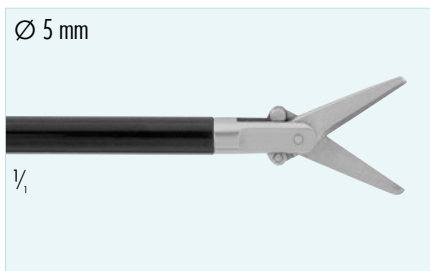

300-400-068\*

300-410-068

300-420-068\*

### METZENBAUM

Scissors, medium blades (15 mm), straight, double action, Ø 5 mm, 330 mm

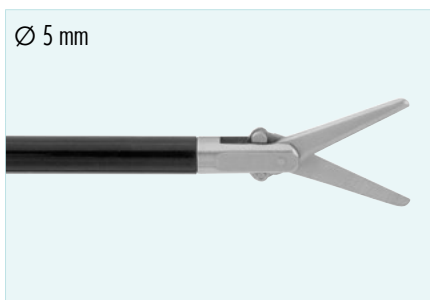

300-400-071

300-410-071

300-420-071

### METZENBAUM

Scissors, long blades (18 mm), straight, double action, Ø 5 mm, 330 mm

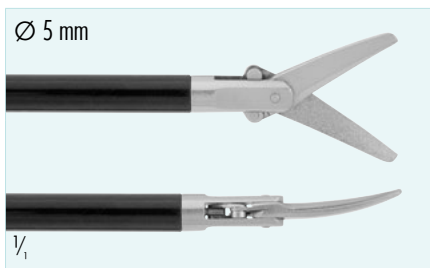

300-400-169

300-410-169

300-420-169

### METZENBAUM

Scissors, medium blades (15 mm) coated with **Diamond Dust**, slightly curved, double action, Ø 5 mm, 330 mm, **DD-Coating** gives the scissors' blades a more durable cutting performance.

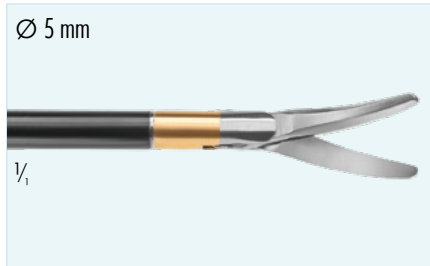

insert only

300-400-170



300-410-170



300-420-170

### TC METZENBAUM

Scissors, long blades (18 mm) with **Tungsten Carbide** inserts, strong curved, double action, Ø 5 mm, 330 mm

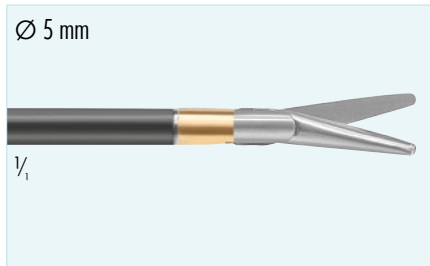

300-400-171

300-410-171

300-420-171

### TC METZENBAUM

Scissors, short blades (12 mm) with **Tungsten Carbide** inserts, slight curved, double action, Ø 5 mm, 330 mm

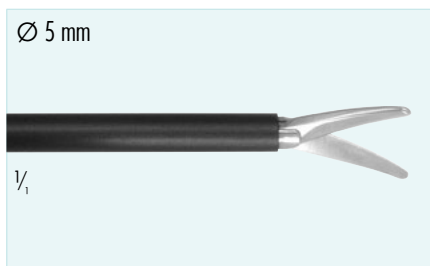

300-400-180

300-410-180

300-420-180

### HINGELESS TC METZENBAUM

Scissors, long blades (18 mm), curved, double action, Ø 5 mm, 330 mm, with **Tungsten Carbide** inserts  
For use with shaft 300-660-015 only



300-400-181

300-410-181

300-420-181

### HINGELESS TC METZENBAUM

Scissors, short blades (12 mm), curved, double action, Ø 5 mm, 330 mm, with **Tungsten Carbide** inserts  
For use with shaft 300-660-015 only

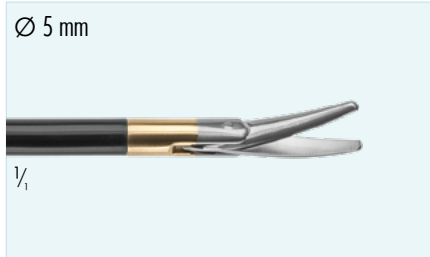

insert only

300-400-173



300-410-173

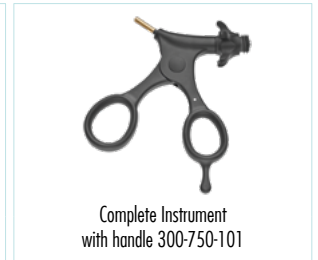

300-420-173

### METZENBAUM TC

TC Scissors, medium blades (15 mm), curved, double action, Ø 5 mm, 330 mm



300-400-065

300-410-064

300-420-064

### METZENBAUM

Scissors, bow shape curved, 16mm blades, fine serrated, double action, Ø 5 mm, 330 mm

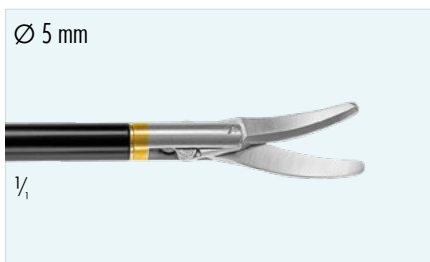

300-400-165\*

300-410-165

300-420-165\*

### METZENBAUM TC

TC Scissors, bow shape curved, 16mm blades, fine serrated, double action, Ø 5 mm, 330 mm



300-400-056

300-410-056

300-420-056

### METZENBAUM

Scissors, slightly curved, double action, Ø 10 mm, 330 mm

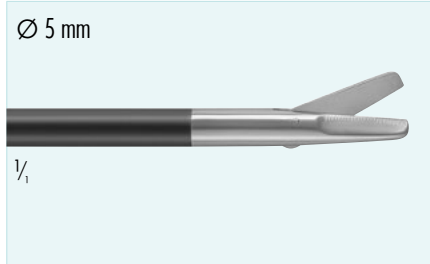

insert only

300-400-063



300-410-063



300-420-063

### PERITONEAL

Scissors, delicate with fine serrated blades, straight, single action, Ø 5 mm, 330 mm

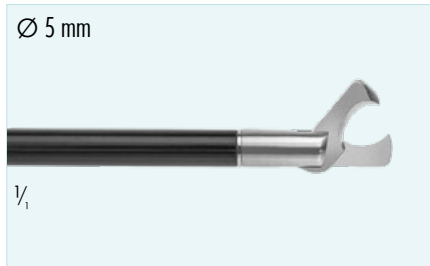

300-400-060\*

300-410-060

300-420-060\*

### HOOK

Scissors with round cutting blades, single action, Ø 5 mm, 330 mm



300-400-062

300-410-062

300-420-062

### HOOK

Scissors with round cutting blades, fine serrated lower blade, single action, Ø 5 mm, 330 mm

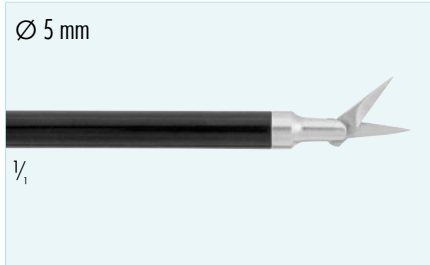

insert only

300-400-570



300-410-570

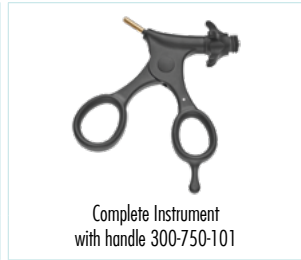

300-420-570

**MICRO**

Scissors with straight sharp blades, single action, Ø 5 mm, 330 mm

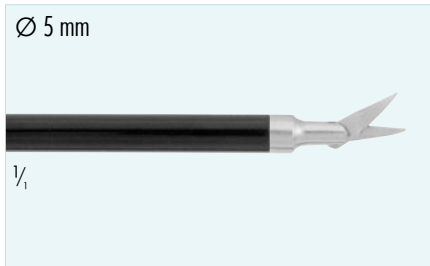

300-400-571

300-410-571

300-420-571

**MICRO**

Scissors with curved sharp blades, single action, Ø 5 mm, 330 mm

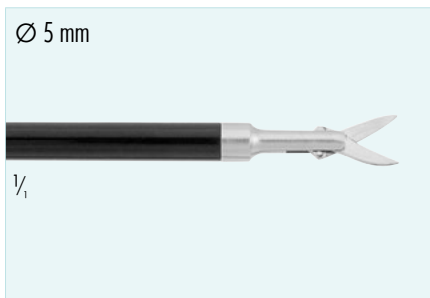

300-400-572

300-410-572

300-420-572

**MICRO**

Scissors with curved sharp blades, double action, Ø 5 mm, 330 mm



### 4-PIECE ENDO TIP SYSTEM

- Reusable handle and shaft, disposable tip
- Always having a sharp tip
- Ecological and economical - reduces waste and saves budget

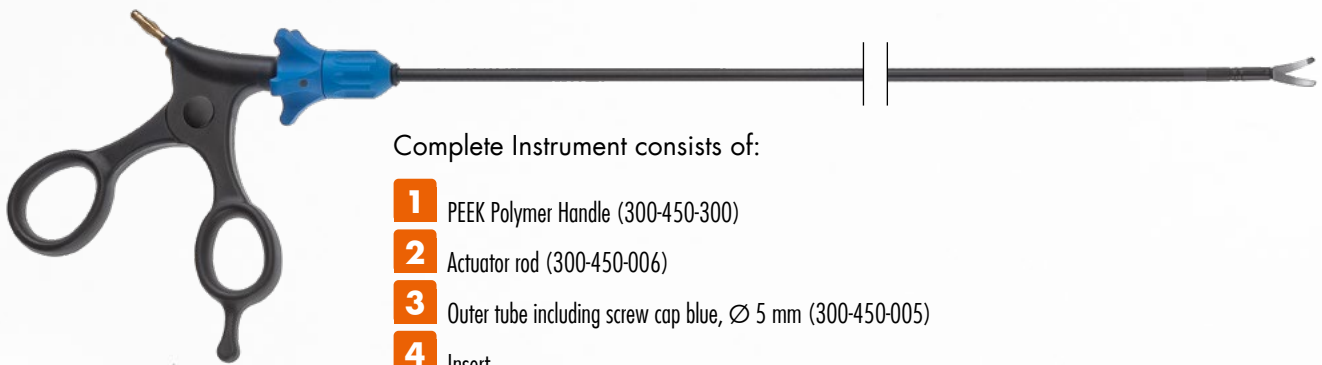

Complete Instrument consists of:

- 1** PEEK Polymer Handle (300-450-300)
- 2** Actuator rod (300-450-006)
- 3** Outer tube including screw cap blue,  $\varnothing$  5 mm (300-450-005)
- 4** Insert

#### 1 PEEK POLYMER HANDLES



300-450-300 PEEK Polymer Handle, blue rotating wheel, without ratchet







The EndoTip system allows to reuse the handle and the sheath of the Instrument, but gives the opportunity to easily change the tip. That provides an always sharp scissors without creating the waste of a complete single use instrument.

4



**METZENBAUM** non-sterile, limited reusable  
 300-450-177 medium, 15mm curved  
 300-450-171 short, 10mm, curved  
 300-450-173 long, 18 mm, curved  
 300-450-174 long, 18 mm, straight  
 300-450-176 medium, 15mm, straight



**JOHANS** Grasper, fenestrated  
 300-450-289 non-sterile (limited reusable)



**MARYLAND** Grasper, curved  
 300-450-731 non-sterile (limited reusable)



**METZENBAUM** sterile, single use  
 300-450-177S medium, 15mm curved



**ENDOCLINCH** Grasper, fenestrated  
 300-450-049 non-sterile (limited reusable)

## CHOLANGIOGRAPHY SYSTEM



300-100-760 Cholangiography fixation clamp with channel for 6 Fr. catheters,  
Ø 5 mm, 330 mm working length, with ratchet and LuerLock, double action jaws



300-193-330 Guide tube for Cholangiography catheter,  
Ø 5 mm, 330 mm working length



### RZ FAN RETRACTORS

- One-piece instrument with flush port
- 50° vertical adjustment
- Available in Ø 5mm and 10mm

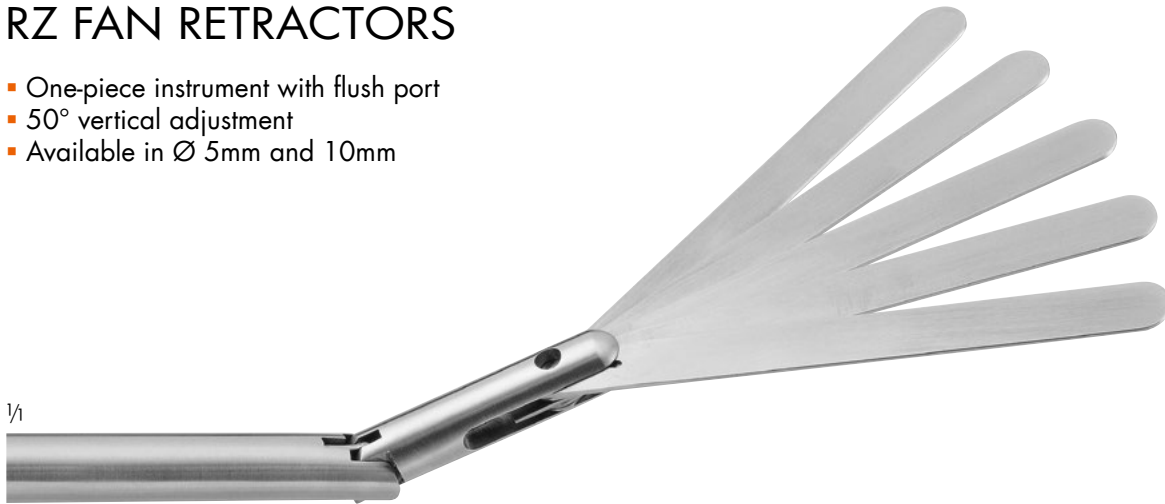

1/1



RZ Fan Retractor, 330mm working length

300-065-000\* 10 mm, with 5 prongs

300-063-000\* 5 mm, with 3 prongs



Esophagus Retractor with cleaning port, vertical up 90°, with distal hole

300-099-033 5 mm, 330 mm working length

300-099-100 5 mm, 440 mm working length

300-099-133 10 mm, 330 mm working length

300-099-140 10 mm, 440 mm working length



300-065-100 Advanced Fan Retractor, 10 mm, 5 prongs,  
angulation: max. 80°, spread: max. 60°, length: 330 mm

### ARTICULATING LAPAROSCOPIC RETRACTORS & BAND-PASSER

- 5mm shaft
- For use with 5.0 or 5.5mm trocars
- With LuerLock



Carbon handle with overload protection



Atraumatic segments, jamming is prevented



The nitinol wire straightens the working end to allow easy introduction and extraction

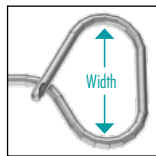

#### TRIANGULAR

Straight	Width	Working length	
	60mm	330mm	300-069-000*
	60mm	450mm	300-069-450
	80mm	330mm	300-070-000*
	80mm	450mm	300-070-450

30° angled	Width	Working length	
	60mm	330mm	300-072-000*
	60mm	450mm	300-072-450
	80mm	330mm	300-073-000*
	80mm	450mm	300-073-450*



#### HOOK

90° upwards	Shape	Working length	
	Curved right	340mm	300-075-001
	Curved left	340mm	300-075-002

45° angled	Shape	Working length	
	Curved right	340mm	300-075-101
	Curved left	340mm	300-075-102

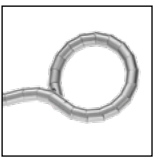
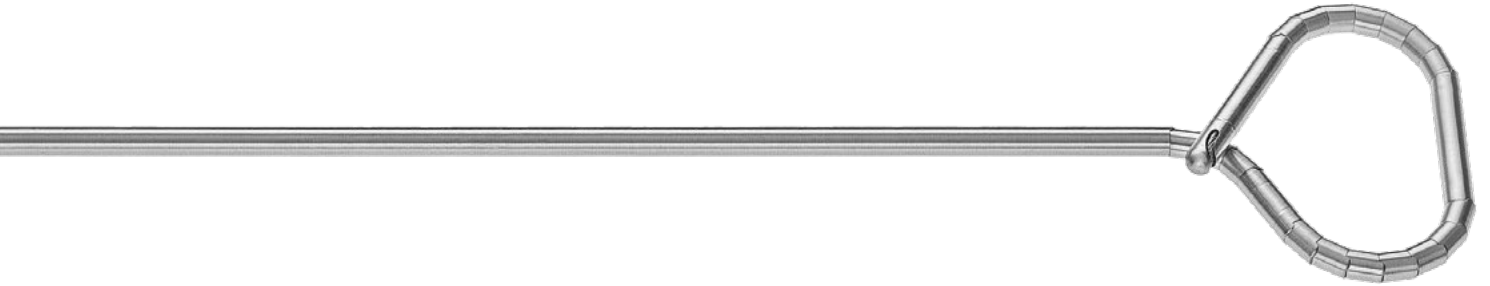

### CIRCLE

	Width	Working length	
Straight	40mm	340mm	300-076-001
Angled	40mm	340mm	300-076-101

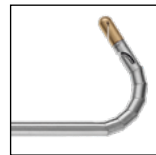

### BAND-PASSER

Working length	
330mm	300-071-000*
450mm	300-071-450*



### J-RETRACTOR

Working length	
340mm	300-077-000

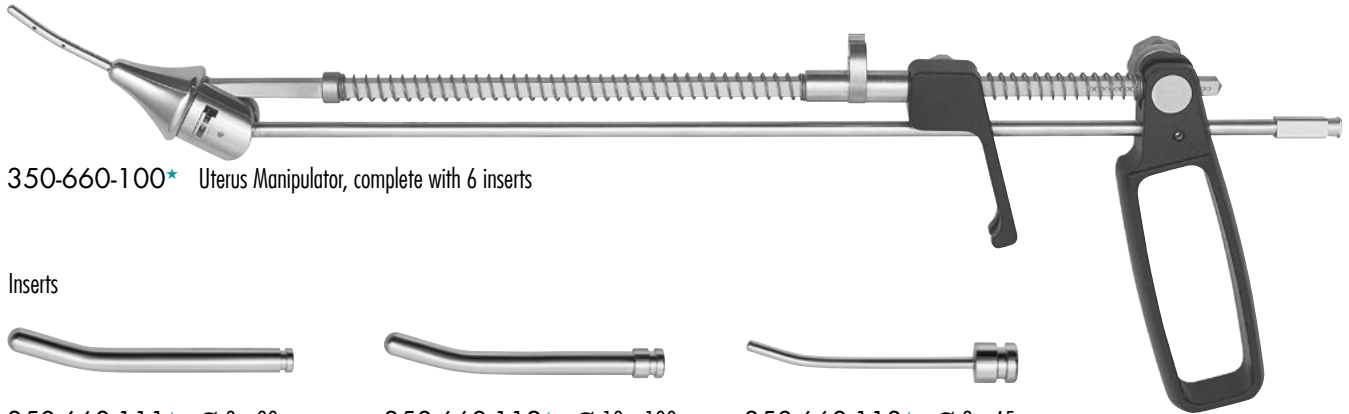

350-660-100\* Uterus Manipulator, complete with 6 inserts

Inserts



350-660-111\* Ø 8 x 80 mm



350-660-112\* Ø 10 x 100 mm



350-660-113\* Ø 3 x 45 mm



350-660-114\* Ø 3 x 55 mm



350-660-115\* Ø 3.2 x 35 mm



350-660-116\* Ø 3.2 x 45 mm



**COHEN**

Self retaining Cannula complete with 2 interchangeable acorns

350-750-000\*

Acorn only

350-750-002 large

350-750-001 small

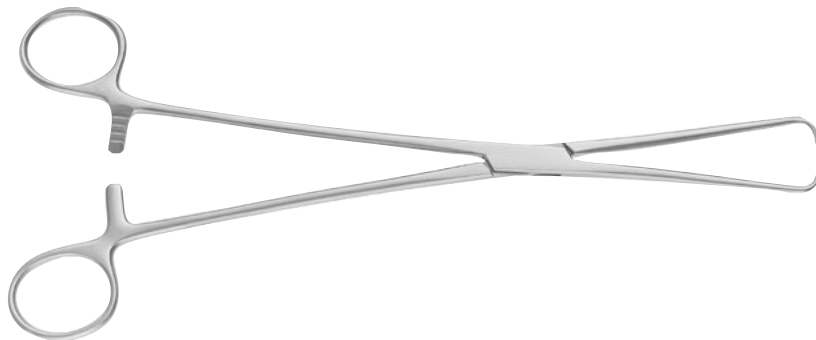

350-400-250\* **SCHROEDER** tenaculum forceps



Myoma screw

300-032-015\* Ø 5mm, 330mm working length

300-042-005 Ø 5mm, 420mm working length

300-033-010 Ø 10mm, 330mm working length

300-042-010 Ø 10mm, 420mm working length

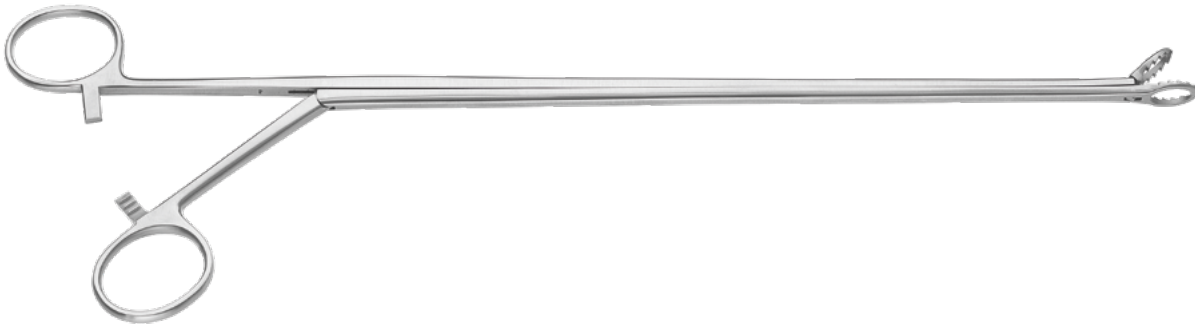

RZ Myoma Grasping Forceps, 330 mm working length

350-755-007 7 mm jaws

350-755-011\* 11 mm jaws

350-755-017 17 mm jaws

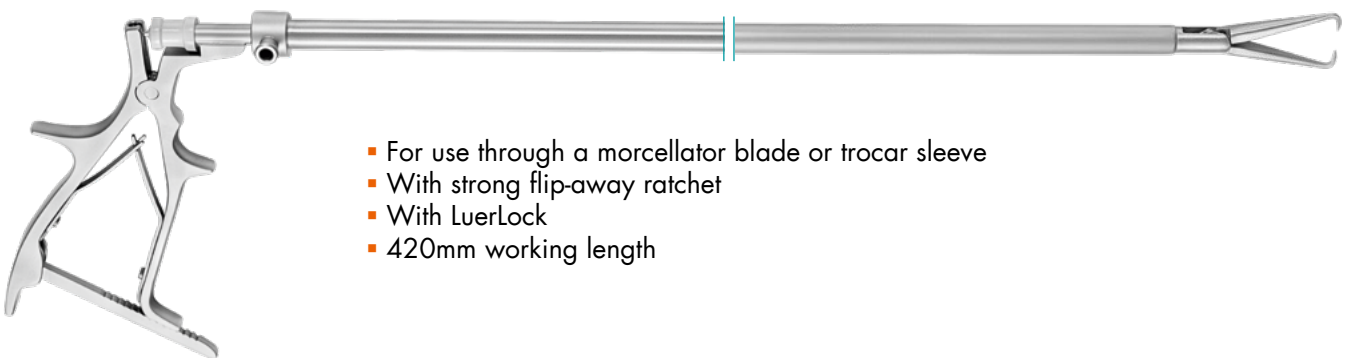

- For use through a morcellator blade or trocar sleeve
- With strong flip-away ratchet
- With LuerLock
- 420mm working length



300-110-714  
Tenaculum Forceps, Ø10mm



300-110-711  
Claw Forceps, Ø10mm



300-110-715  
Tenaculum Forceps, Ø5mm

## RZ RING APPLICATORS

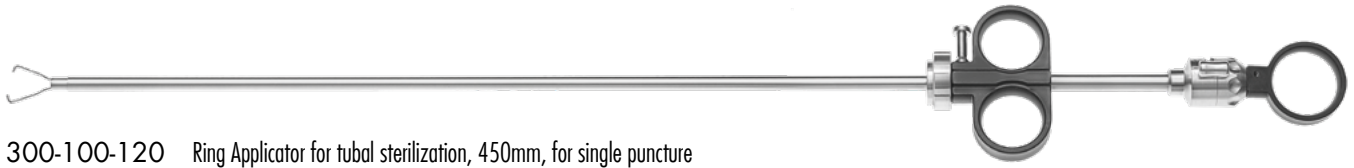

300-100-120 Ring Applicator for tubal sterilization, 450mm, for single puncture for use with Operating Laparoscopes with  $\varnothing$  6mm instrument channels (300-099-006 and 300-099-106).  
A knurled screw is fixing the Ring Applicator securely to the telescope

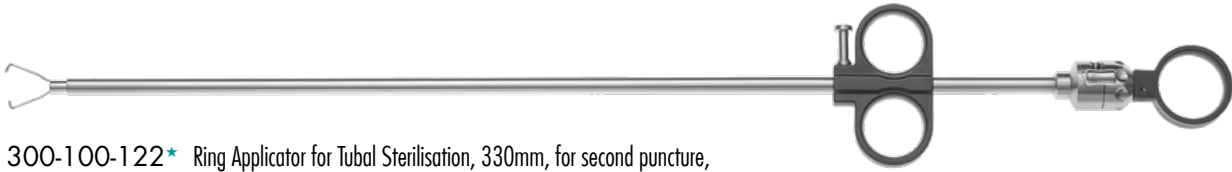

300-100-122\* Ring Applicator for Tubal Sterilisation, 330mm, for second puncture, for use with Trocar sleeves  $\varnothing$  7.0mm



300-100-125 Cone for Ring Applicator



300-100-127 Loading Device for Ring Applicator



# CLIP APPLYING BULLDOG CLAMPS NEEDLE HOLDERS

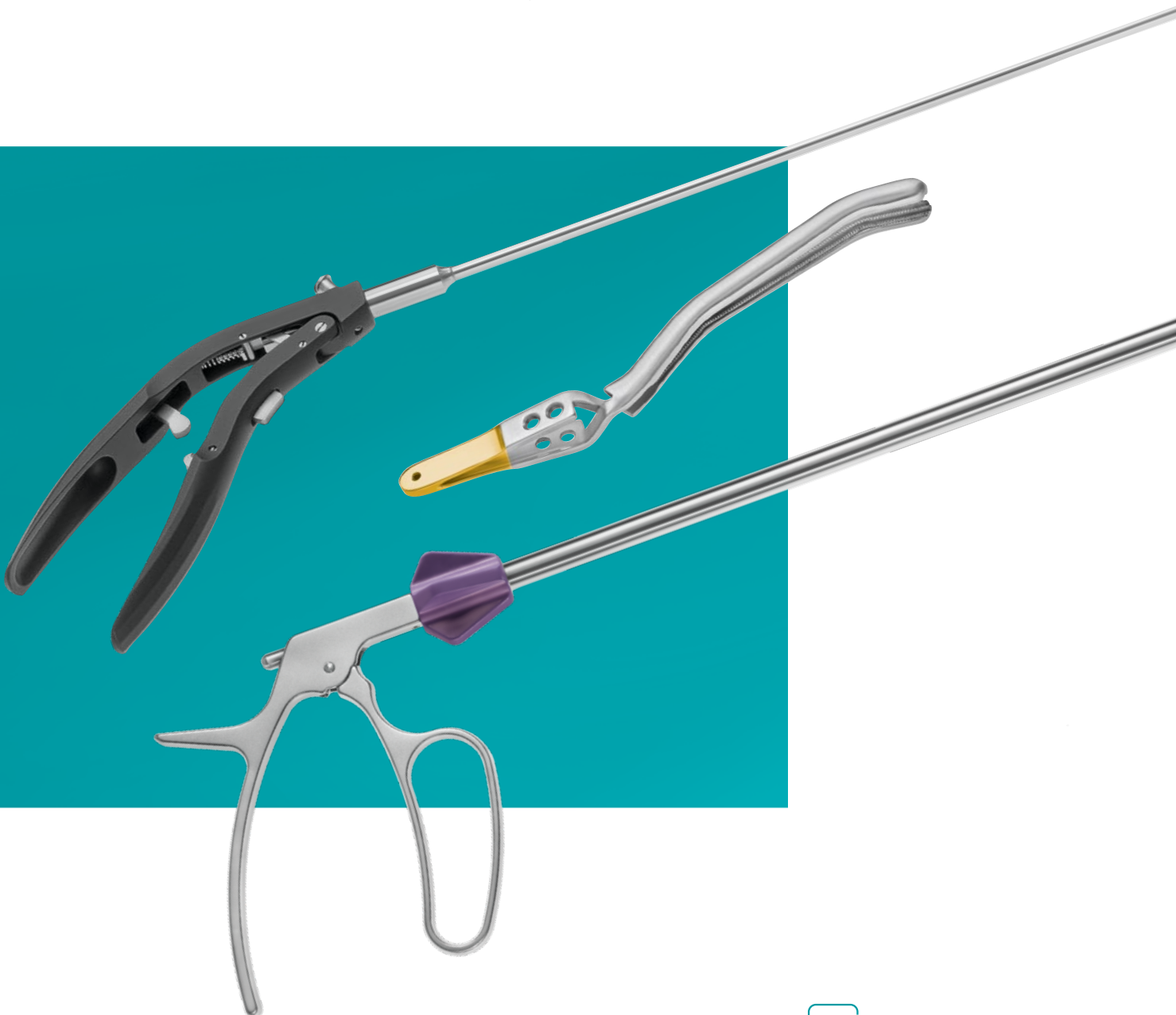

### ENDOSCOPIC CLIP APPLYING FORCEPS - TITAN CLIPS

- 360° rotatable
- Color-coded
- Detachable and non-detachable models



**TYPE ETHICON, TITANIUM**

Size / color code	detachable, 330mm	A insert only, 330mm	B shaft only
S (blue) ■	300-810-001	300-810-101	300-830-010
M (white) □	300-810-002	300-810-102	300-830-010
M/L (green) ■	300-810-004*	300-810-104	300-830-010
L (yellow) ■	300-810-006*	300-810-106	300-830-010

Size / color code	detachable, 450mm	A insert only, 450mm	B shaft only
S (blue) ■	300-810-401	300-810-501	300-830-410
M (white) □	300-810-402	300-810-502	300-830-410
M/L (green) ■	300-810-404	300-810-504	300-830-410
L (yellow) ■	300-810-406	300-810-506	300-830-410





Size / color code	non detachable, 330mm	non detachable, 450mm
S (blue) ■	300-800-001	300-800-401
M (white) □	300-800-002	300-800-402
M/L (green) ■	300-800-004*	300-800-404
L (yellow) ■	300-800-006*	300-800-406

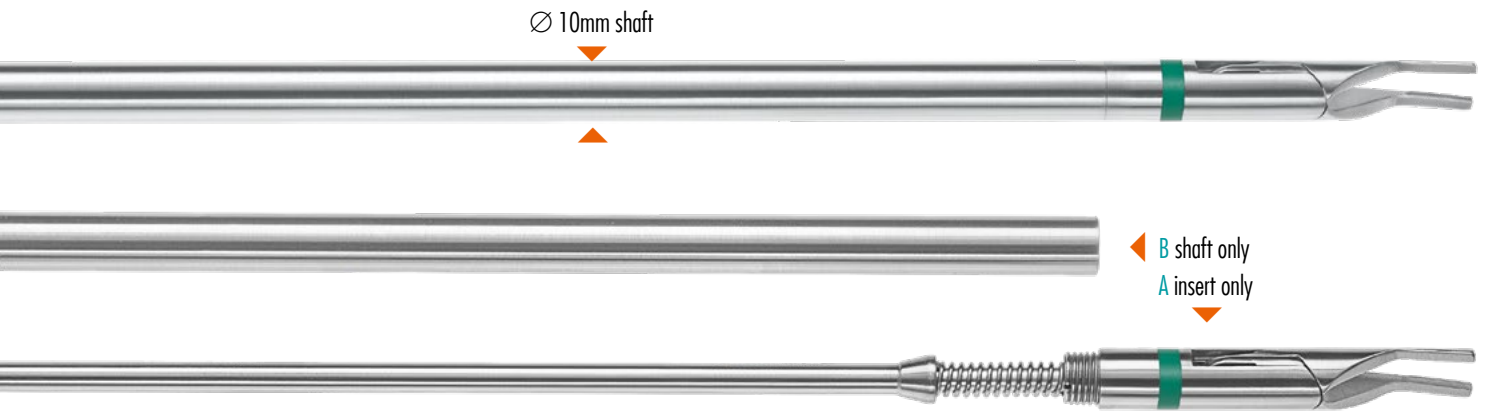

### TYPE HORIZON, TITANIUM





Titan Clips,  
Ethicon and  
Horizon type

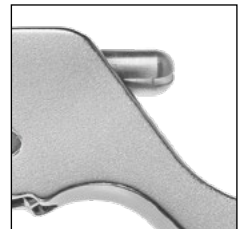

Size / color code	detachable, 330mm	A insert only, 330mm	B shaft only
S (yellow) 	300-810-011	300-810-111	300-830-010
M (blue) 	300-810-012	300-810-112	300-830-010
M/L (green) 	300-810-014	300-810-114	300-830-010
L (orange) 	300-810-016	300-810-116	300-830-010





Detachable Forceps  
without LuerLock

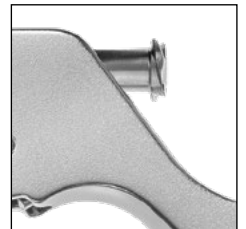

Size / color code	detachable, 450mm	A insert only, 450mm	B shaft only
S (yellow) 	300-810-411	300-810-511	300-830-410
M (blue) 	300-810-412	300-810-512	300-830-410
M/L (green) 	300-810-414	300-810-514	300-830-410
L (orange) 	300-810-416	300-810-516	300-830-410

Non-detachable Forceps  
with LuerLock



Size / color code	non detachable, 330mm	non detachable, 450mm
S (yellow) 	300-800-011	300-800-411
M (blue) 	300-800-012	300-800-412
M/L (green) 	300-800-014	300-800-414
L (orange) 	300-800-016	300-800-416

### ENDOSCOPIC CLIP APPLYING FORCEPS - POLYMER CLIPS

- 360° rotatable
- Color-coded
- Detachable and non-detachable models

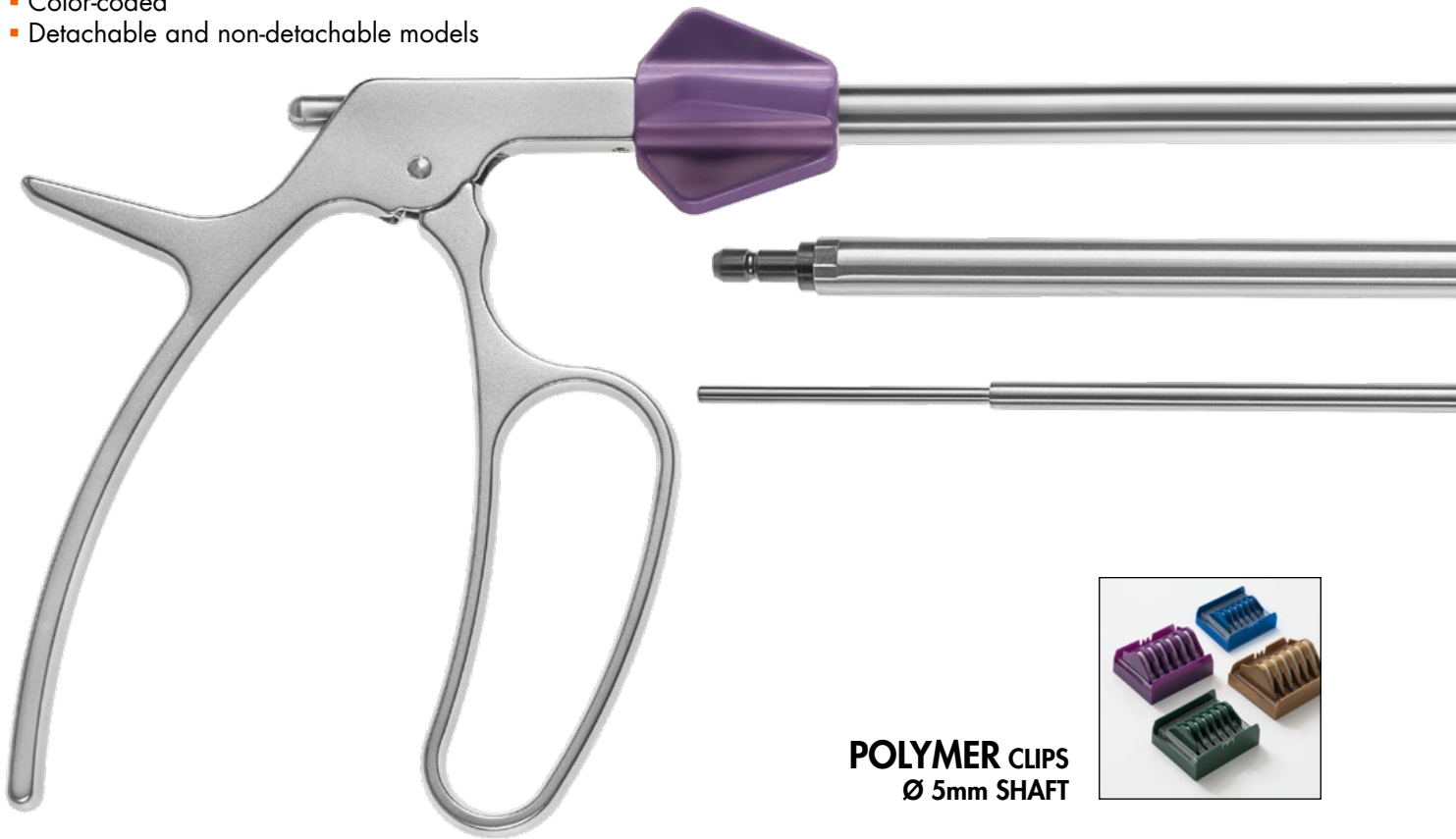

#### POLYMER CLIPS Ø 5mm SHAFT

Size / color code	detachable, 330mm	A insert only, 330mm	B shaft only
M (blue) ■	300-830-051	300-830-151	300-830-005
M/L (green) ■	300-830-052	300-830-152	300-830-005

#### Ø 10mm SHAFT

Size / color code	detachable, 330mm	A insert only, 330mm	B shaft only
L (purple) ■	300-830-013	300-830-113	300-830-010
XL (yellow) ■	300-830-014	300-830-114	300-830-010

#### Ø 5mm SHAFT

Size / color code	detachable, 450mm	A insert only, 450mm	B shaft only
M (blue) ■	300-830-451	300-830-551	300-830-405
M/L (green) ■	300-830-452	300-830-552	300-830-405

#### Ø 10mm SHAFT

Size / color code	detachable, 450mm	A insert only, 450mm	B shaft only
L (purple) ■	300-830-413	300-830-513	300-830-410
XL (yellow) ■	300-830-414	300-830-514	300-830-410

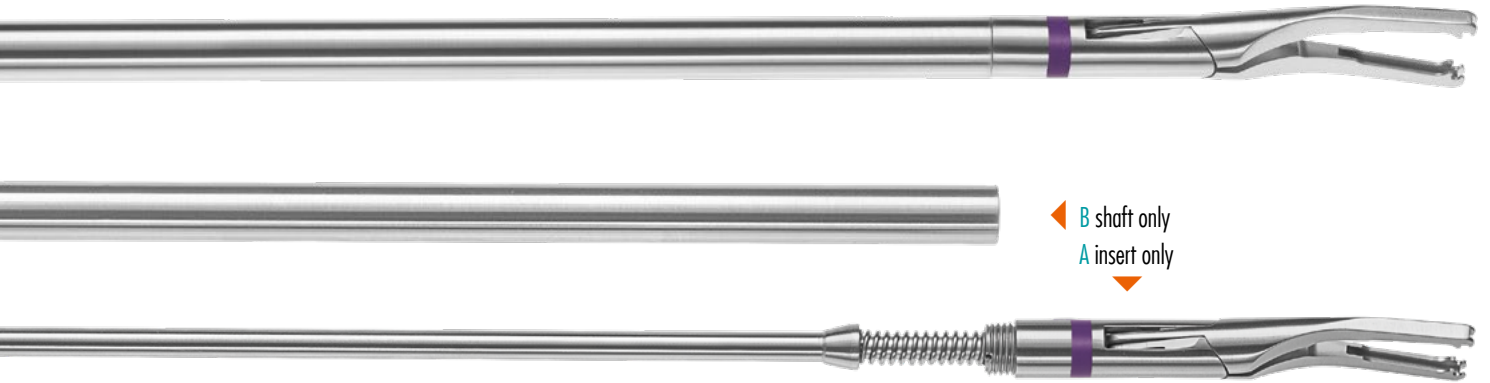

### Ø 5mm SHAFT

Size / color code	non-detachable, 330mm	non-detachable, 450mm
M (blue) <span style="color: blue;">■</span>	300-820-051	300-820-451
M/L (green) <span style="color: green;">■</span>	300-820-052*	300-820-452*

### Ø 10mm SHAFT

Size / color code	non-detachable, 330mm	non-detachable, 450mm
L (purple) <span style="color: purple;">■</span>	300-820-013*	300-820-413*
XL (yellow) <span style="color: yellow;">■</span>	300-820-014*	300-820-414*

Polymer Clips  
Applying Forceps



Detachable Forceps  
without LuerLock

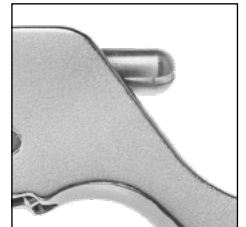

Non-detachable Forceps  
with LuerLock

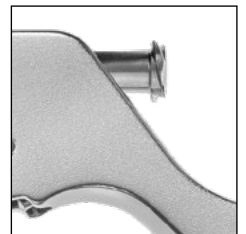

### POLYMER CLIP REMOVING FORCEPS

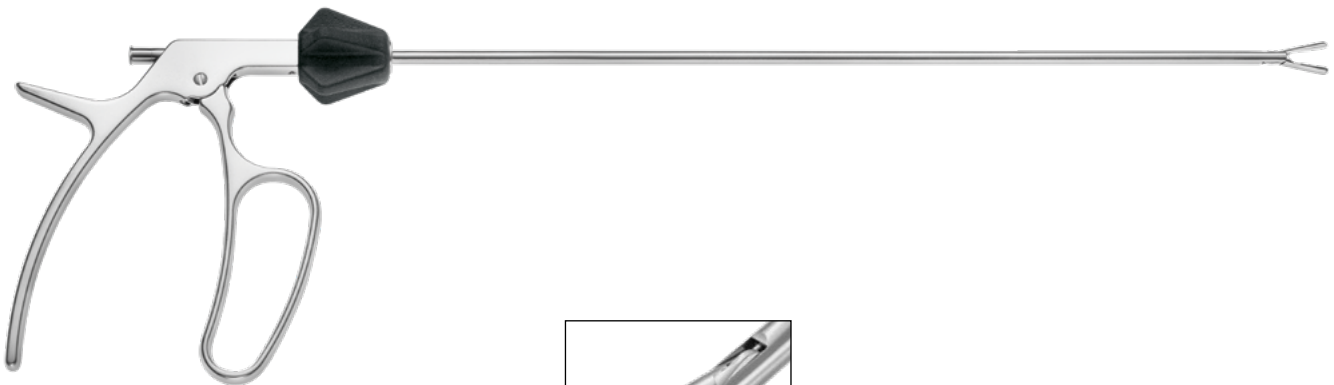

**Ø 5mm SHAFT**

Size / color code	detachable, 330mm	insert only, 330mm	shaft only
M & M/L (black) ■	300-830-056	300-830-156	300-830-005

**Ø 10mm SHAFT**

Size / color code	detachable, 330mm	insert only, 330mm	shaft only
L & XL (black) ■	300-830-015	300-830-115	300-830-010

**Ø 5mm SHAFT**

Size / color code	detachable, 450mm	insert only, 450mm	shaft only
M & M/L (black) ■	300-830-456	300-830-556	300-830-405

**Ø 10mm SHAFT**

Size / color code	detachable, 450mm	insert only, 450mm	shaft only
L & XL (black) ■	300-830-415	300-830-515	300-830-410

**Ø 5mm SHAFT**

Size / color code	non detachable, 330mm	non detachable, 450mm
M & M/L (black) ■	300-820-056*	300-820-456

**Ø 10mm SHAFT**

Size / color code	non detachable, 450mm	non detachable, 450mm
L & XL (black) ■	300-820-015*	300-820-415



Polymer Clips Removal Forceps

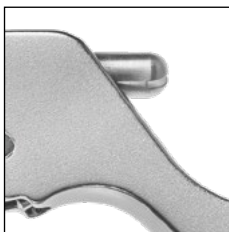

Detachable Forceps without LuerLock

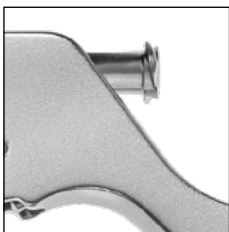

Non-detachable Forceps with LuerLock

## ENDOSCOPIC BULLDOG CLAMP APPLIER

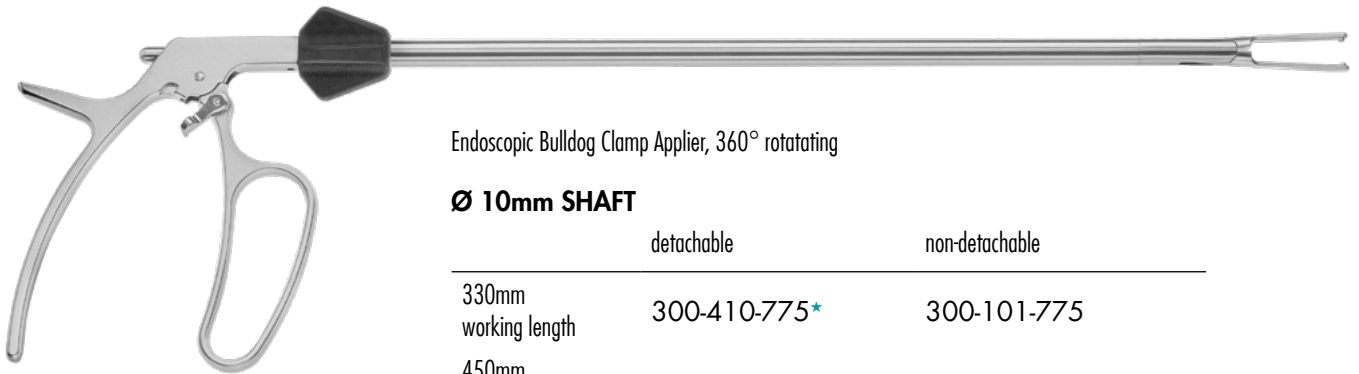

Endoscopic Bulldog Clamp Applier, 360° rotating

**Ø 10mm SHAFT**

	detachable	non-detachable
330mm working length	300-410-775*	300-101-775
450mm working length	300-411-775	300-111-775



Shaft only, for detachable Bulldog Clamp Applier

- 300-830-010 330 mm working length
- 300-830-410 450 mm working length



Insert only, for detachable Bulldog Clamp Applier

- 300-400-775 330 mm working length
- 300-401-775 450 mm working length



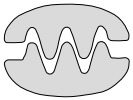

2 x 3 rows of teeth



Endoscopic Vascular Bulldog Clamp, straight, with DeBakey serration

300-100-773\* 17 mm jaws

300-100-774\* 25 mm jaws



Endoscopic Bulldog Clamp for bowel surgery, straight, with DeBakey serration

300-100-771\* 45 mm jaws

300-100-772\* 60 mm jaws



Endoscopic Vascular Bulldog Clamp, curved, with DeBakey serration

300-100-776 17 mm jaws

300-100-777\* 25 mm jaws



Endoscopic Bulldog Clamp for bowel surgery, curved, with DeBakey serration

300-100-778\* 45 mm jaws

300-100-779 60 mm jaws



Endoscopic Satinsky Bulldog Clamp, with DeBakey serration golden spring, to be used with 12.5 mm trocar system

300-100-786 60 mm jaws



300-100-789 60 mm jaws

Endoscopic Satinsky Bulldog Clamp, curved, with atraumatic DeBakey serration, to be used with 12.5 mm trocar system

### Endoscopic Bulldog Clamps with DeBakey serration

- Secure holding of tissue structure
- Occlusion of vessel and other tissue without an additional port
- Atraumatic cross clamping of the colon
- 450-475g closing pressure (300-100-771 - 779)



## ROBOTIC BULLDOG CLAMP

- Specifically designed for use with robotic surgical system
- Single surgeon placement via Pro-Grasp® instrument
- Full control for optimal clamp placement
- Atraumatic DeBakey clamp design
- Introduced through 12.5mm cannula
- Suture hole for easy retrieval



Robotic Bulldog Clamp, bayonet shape,  
with suture hole, blunt teeth  
500g closing pressure  
300-100-799\* 30mm  
300-100-798\* 25mm

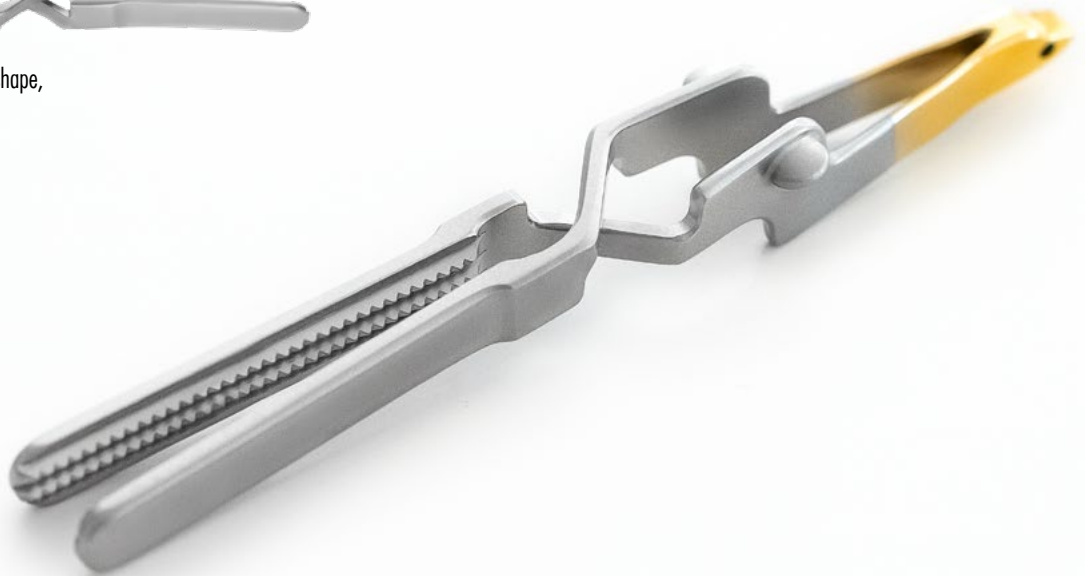

300-101-777  
Robotic Bulldog Clamp Remover  
Ø 10mm, rotatable, with LuerLock

## TITANIUM ARTERIAL &amp; VENOUS BULLDOG CLAMPS

- Different pressure color coding (A-Artery / V-Vein)
- Lightweight
- Non-magnetic
- Highest biocompatibility and corrosion resistance
- Mechanical strength
- DeBaKey serration



CLOSING PRESSURE

300 - 375g



Titanium Bulldog Clamp, straight, Code V (Vein),  
blue

300-100-773TV 17mm jaw  
300-100-774TV 25mm jaw  
300-100-771TV 45mm jaw  
300-100-772TV 60mm jaw



CLOSING PRESSURE

475 - 500g



Titanium Bulldog Clamp, straight, Code A (Artery), red

300-100-773TA 17mm jaw  
300-100-774TA 25mm jaw  
300-100-771TA 45mm jaw  
300-100-772TA 60mm jaw



Applier recommendation:  
300-101-775  
300-410-775 (detachable)



### DETACHABLE NEEDLE HOLDERS

- Detachable 2- and 3-part system
- Easy cleaning
- Handle can be used with different inserts

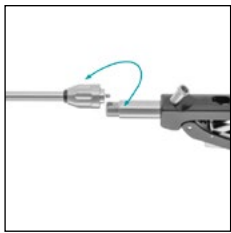

Detachable shaft from handle:  
convertible system, better  
cleaning possibilities

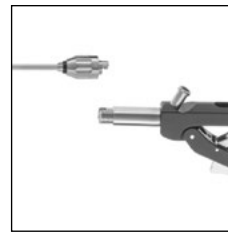

2-piece system:  
An extra thin  $\varnothing$  3mm System  
with 250mm and 330mm length  
for Pediatric and Mini-Laparoscopy

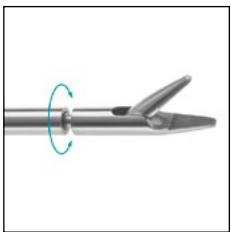

Secure screwing on the insert:  
Perfect fit of the insert and  
single cleaning  
(only 3-piece system)

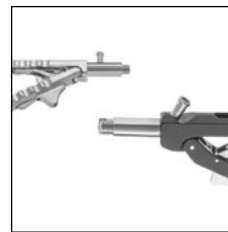

Modular handles:  
Axial and straight handles  
available to fulfill the surgeon's  
needs and provide ergonomical  
comfort

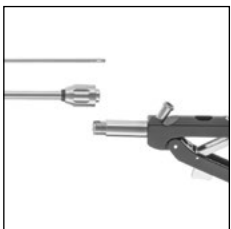



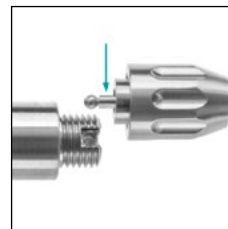

3-piece system:  
Needle holder can be fitted  
with different shafts and  
inserts, different lengths  
available

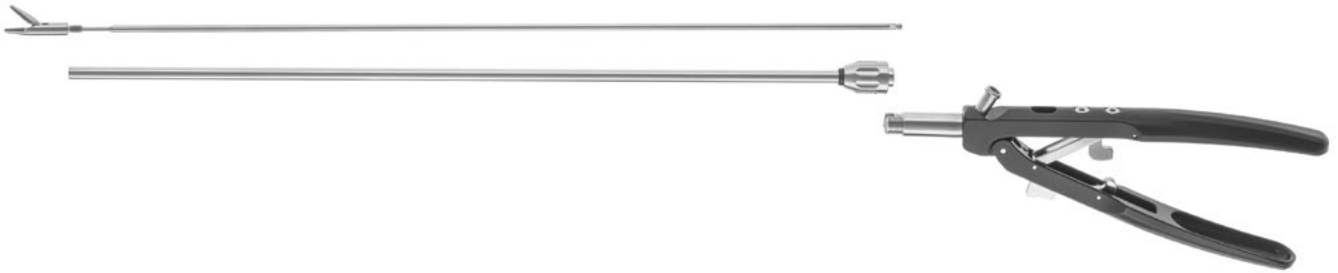

Anti-rotation feature:  
due to an extra rectangular  
connector, wrong insertion of  
the insert is excluded

### 3-PIECE INSTRUMENT $\varnothing$ 5mm



Insert only	Complete instrument  with axial handle	Complete instrument  with straight handle	Complete instrument  with angled handle
-------------	---	---	--



Straight jaw, TC

330mm	300-405-130	300-480-630	300-480-130	300-480-160
450mm	300-406-130	300-480-730	300-480-230	300-480-260



Left curved jaw, TC

330mm	300-405-140	300-480-640	300-480-140	300-480-170
450mm	300-406-140	300-480-740	300-480-240	300-480-270



Right curved jaw, TC

330mm	300-405-141	300-480-641	300-480-141	300-480-171
450mm	300-406-141	300-480-741	300-480-241	300-480-271



Diamond dusted jaw,  
self-aligning

330mm	300-405-142	300-480-642	300-480-142	300-480-172
450mm	300-406-142	300-480-742	300-480-242	300-480-272



1x2 teeth jaw, TC

330mm	300-405-131	300-480-631	300-480-131	300-480-161
450mm	300-406-131	300-480-731	300-480-231	300-480-261

## SINGLE PARTS FOR DETACHABLE NEEDLE HOLDER



Axial Handle, strong, straight  
300-480-002



Axial Handle, straight  
300-480-000



Axial Handle, angled  
300-480-001



Outer Sheath, for combination with  
shaft and insert, three-pieces

330mm	300-480-033
450mm	300-480-045

### 2-PIECE INSTRUMENT $\varnothing$ 3mm



Insert and shaft	Complete instrument  with straight handle	Complete instrument  with angled handle
------------------	--	--

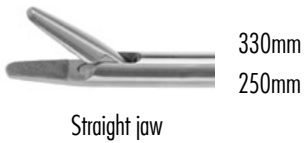

300-405-330  
300-404-330

300-480-330  
300-480-530

300-480-360  
300-480-560



300-405-340  
300-404-340

300-480-340  
300-480-540

300-480-370  
300-480-570

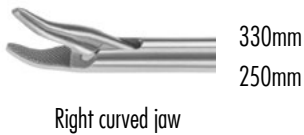

300-405-341  
300-404-341

300-480-341  
300-480-541

300-480-371  
300-480-571

### 1-PIECE NEEDLE HOLDER

- Extremely light
- Aluminium anodized handle



Lightweight design with satin black surface



65° LuerLock flushing port for optimal accessibility

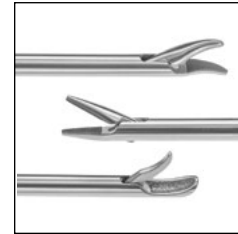

5 different jaw designs available



Rubber sealing cap included



6-tooth ratchet for always optimal positioning, with overload protection



Straight



Left curved



Right curved



1x2 teeth



Concave/convex





### Ø 5mm STRAIGHT HANDLE

300-300-130*	straight	TC serrated	330mm
300-300-131	straight, 1x2 teeth	TC serrated	330mm
300-300-140*	left curved	TC serrated	330mm
300-300-141 *	right curved	TC serrated	330mm
300-300-142*	concave/convex	diamond dusted	330mm
300-300-230	straight	TC serrated	450mm
300-300-231	straight, 1x2 teeth	TC serrated	450mm
300-300-240	left curved	TC serrated	450mm
300-300-241	right curved	TC serrated	450mm
300-300-242	concave/convex	diamond dusted	450mm

### Ø 5mm ANGLED HANDLE

300-300-160*	straight	TC serrated	330mm
300-300-161	straight, 1x2 teeth	TC serrated	330mm
300-300-170*	left curved	TC serrated	330mm
300-300-171 *	right curved	TC serrated	330mm
300-300-172*	concave/convex	diamond dusted	330mm
300-300-260	straight	TC serrated	450mm
300-300-261	straight, 1x2 teeth	TC serrated	450mm
300-300-270	left curved	TC serrated	450mm
300-300-271	right curved	TC serrated	450mm
300-300-272	concave/convex	diamond dusted	450mm

### Ø 3mm STRAIGHT HANDLE

300-300-330	straight	TC serrated	330mm
300-300-340	left curved	TC serrated	330mm
300-300-341	right curved	TC serrated	330mm
300-300-430	straight	TC serrated	450mm
300-300-440	left curved	TC serrated	450mm
300-300-441	right curved	TC serrated	450mm

### Ø 3mm ANGLED HANDLE

300-300-360	straight	TC serrated	330mm
300-300-370	left curved	TC serrated	330mm
300-300-371	right curved	TC serrated	330mm
300-300-460	straight	TC serrated	450mm
300-300-470	left curved	TC serrated	450mm
300-300-471	right curved	TC serrated	450mm

### STAINLESS STEEL NEEDLE HOLDERS

- Automatic mechanism
- Smoothly releasing interlock



Smooth release lock, very robust handle design

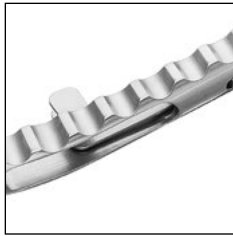

Ergonomic and reliable handle design



Straight LuerLock flushing port (sealing cap included)



Straight



Left curved



Right curved



Diamond dusted, self aligning



### Ø 5mm STRAIGHT HANDLE

300-100-694*	right curved	330mm	serration TC
300-100-695*	straight	330mm	serration TC
300-100-696*	left curved	330mm	serration TC
300-100-697	straight	450mm	serration TC
300-100-698	left curved	450mm	serration TC
300-100-699	right curved	450mm	serration TC
300-100-702	straight	330mm	diamond dusted
300-100-703	straight	450mm	diamond dusted

### Ø 3mm STRAIGHT HANDLE

300-100-687	left curved	250mm	serration TC
300-100-688	right curved	250mm	serration TC
300-100-689	straight	250mm	serration TC
300-100-691	left curved	330mm	serration TC
300-100-692	right curved	330mm	serration TC
300-100-693	straight	330mm	serration TC

### WERNER NEEDLE HOLDERS

- Detachable and single-piece option
- 3-piece model for efficient cleaning

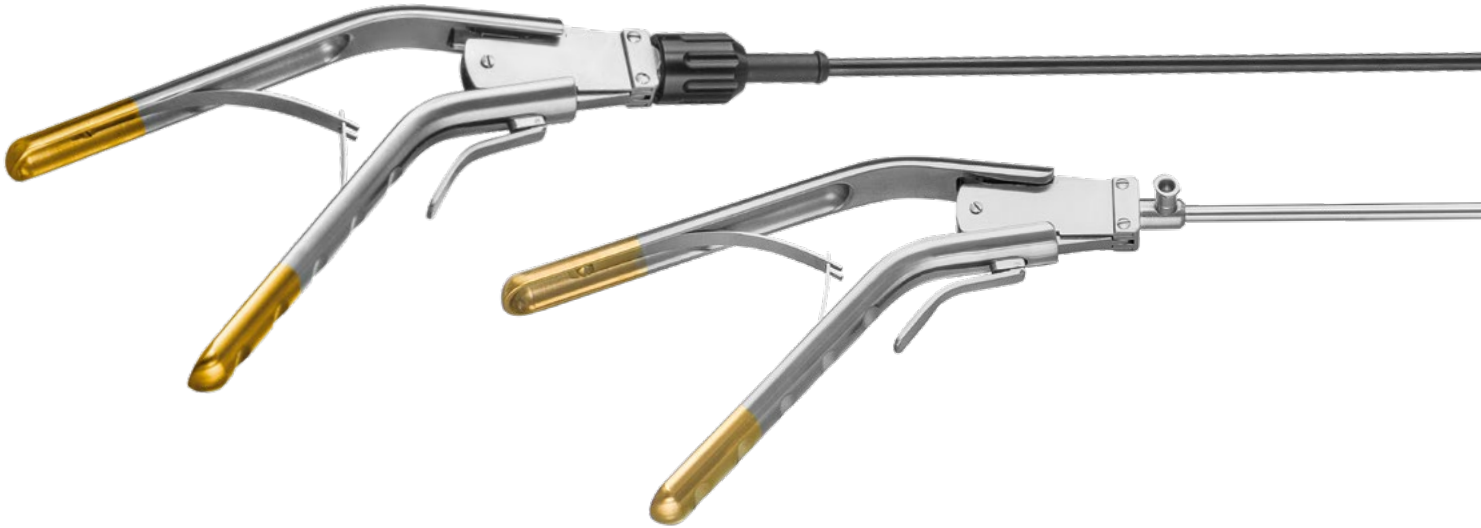

Ergonomic axial handle design  
for effortless working

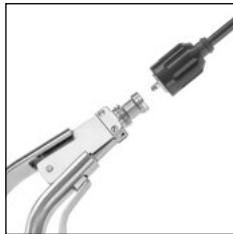

Detachable 3-piece system



Smooth and ergonomic ratchet

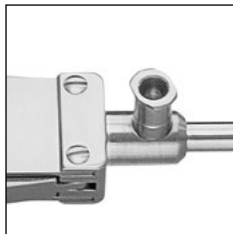

Straight LuerLock flushing port  
(sealing cap included)



### Ø 5mm DETACHABLE

300-300-001	straight	TC serrated	330mm
300-300-101	left curved	TC serrated	330mm
300-300-201	right curved	TC serrated	330mm
300-300-501	convex/concave	toothed	330mm
300-302-001	straight	TC serrated	450mm
300-302-101	left curved	TC serrated	450mm
300-302-201	right curved	TC serrated	450mm
300-302-501	convex/concave	toothed	450mm

### Ø 5mm SINGLE-PIECE

300-300-000	straight	TC serrated	330mm
300-300-100	left curved	TC serrated	330mm
300-300-200	right curved	TC serrated	330mm
300-300-500	convex/concave	toothed	330mm
300-302-000	straight	TC serrated	450mm
300-302-100	left curved	TC serrated	450mm
300-302-200	right curved	TC serrated	450mm

### Ø 3mm DETACHABLE

300-303-001	straight	TC serrated	330mm
300-303-101	left curved	TC serrated	330mm
300-303-201	right curved	TC serrated	330mm
300-303-501	convex/concave	toothed	330mm

### Ø 3mm SINGLE-PIECE

300-303-000	straight	TC serrated	330mm
300-303-100	left curved	TC serrated	330mm
300-303-200	right curved	TC serrated	330mm
300-303-500	convex/concave	toothed	330mm

### TC ENDOSCOPIC NEEDLE HOLDER

- Axial ring handle
- For intra- & extracorporal suturing
- Jaw with TC inserts: firm & reliable grip of suturing needles, long lifetime of the needle holder
- Ø 5 mm



330mm

450mm



Curved left

300-101-588\*

300-101-589



Curved right

300-101-592

300-101-599



Straight jaw

300-101-594\*



Bullnose, straight jaw

300-101-596\*

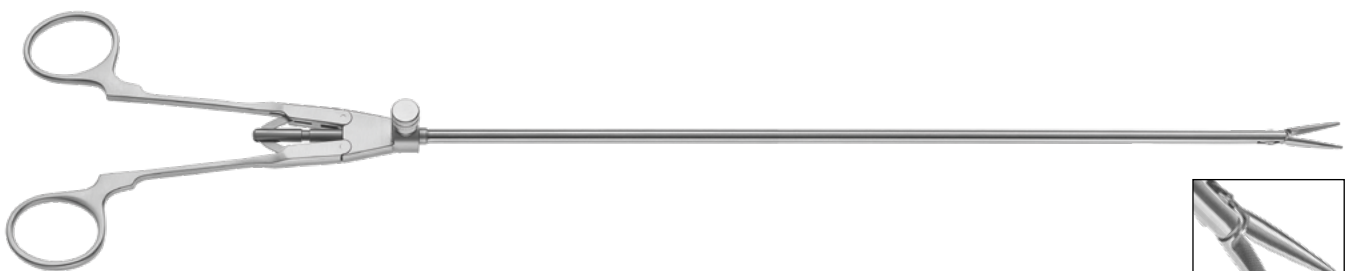

300-332-320 **LIONS** Needle forceps Ø 5 mm, 330 mm without ratchet, with LuerLock, double-action



## ROMEO DIAMOND DUSTED NEEDLE HOLDER

- Auto-aligning of needles
- Concave shaped jaw: aligns curved endoscopic needles by itself in 90° position to the jaw's horizontal line
- Diamond dusted jaw: keeps needle securely in place
- Ø 5 mm

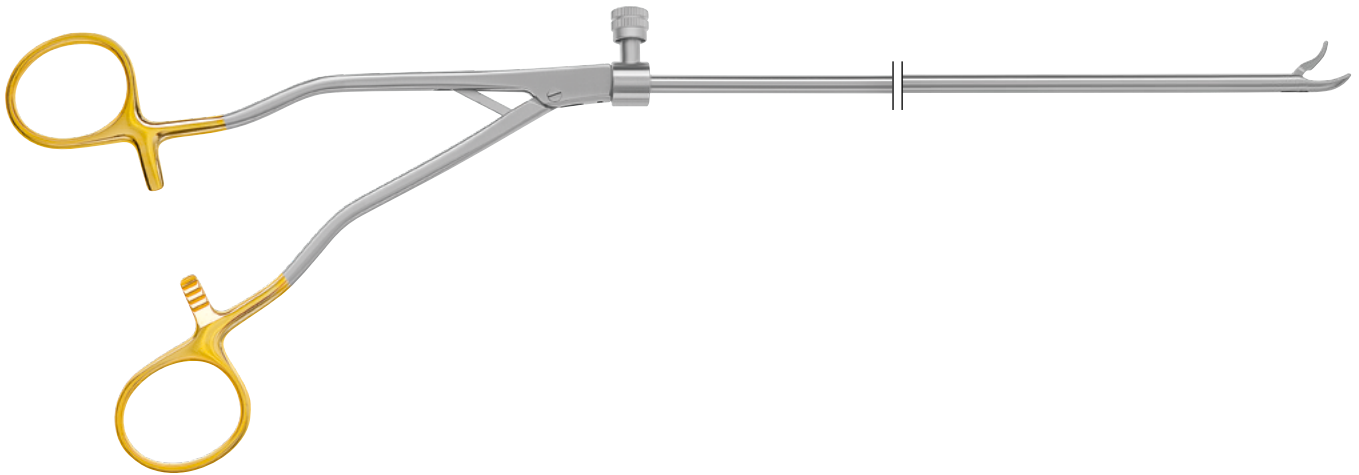

360mm





Parrot design jaw

300-101-593

### MATHIEU TC ENDOSCOPIC NEEDLE HOLDER

- For intra- & extracorporal suturing
- Jaw with TC inserts: firm & reliable grip of suturing needles
- Ergonomic designed handle: easy posture by alignment of the surgeon's hand with the suturing needle
- Curved, fine tapered jaw
- Ø 5 mm



		330mm	450mm
	Curved left	300-330-033	300-330-045
	Curved right	300-332-033	
	Straight jaw	300-334-033	



### TOBIAS & TOBIAS II FASCIA SUTURING INSTRUMENTS

- Self-closing spring mechanism
- For closing trocar incisions under vision



Shaft diameter	2.0mm
Working length	150mm
Tip Geometry	sharp conical tip, detachable
Cleaning	LuerLock flush port

300-151-000\* Tobias Fascia Suturing Instrument with slim 2.0mm shaft and detachable conical tip



300-152-000 Tip only, set with 5 pieces



Shaft diameter	2.8mm
Working length	150mm
Tip Geometry	sharp conical tip, detachable
Cleaning	LuerLock flush port

300-153-000\* Tobias II Fascia Suturing Instrument with strong 2.8mm shaft and fixed pyramidal tip

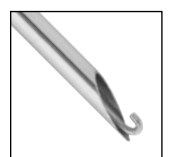

300-151-100 Rainer Fascia Suturing Device, Ø 2.3mm, 140mm working length

## KNOT TIERS



Classic knot tier with slit and eye for extra corporal knotting,  $\varnothing$  4 mm

300-030-001\* 330 mm working length

300-030-003 450 mm working length

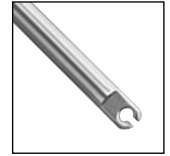

Knot tier with eye for extra corporal knotting,  $\varnothing$  4 mm

300-030-004 330 mm working length

300-030-006 450 mm working length

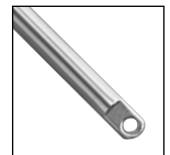

300-030-000\* Knot tier with longitudinal conical form for secure holding of extracorporal knots to suture site,  $\varnothing$  4 mm, 330 mm working length

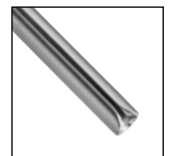

300-012-405\* Reducer Sleeve,  $\varnothing$  5 - 4mm, 175mm, red

### KNOT PUSHER WITH SCISSORS



Consists of:

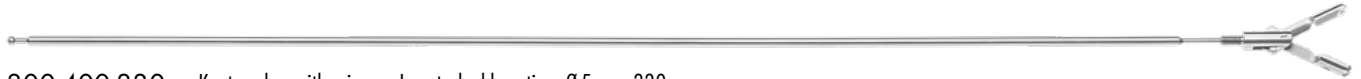

300-400-330 Knot pusher with scissors, Insert, double action, Ø 5mm, 330mm



300-660-005 Outer Sheath, insulated, Ø 5mm, 330mm, adaptable to all handles

Handles



300-750-101 Carbon Fiber Handle, HF-connection



300-750-105 Carbon Fiber Handle, hook up ratchet, HF-connection



# BIPOLAR INSTRUMENTS

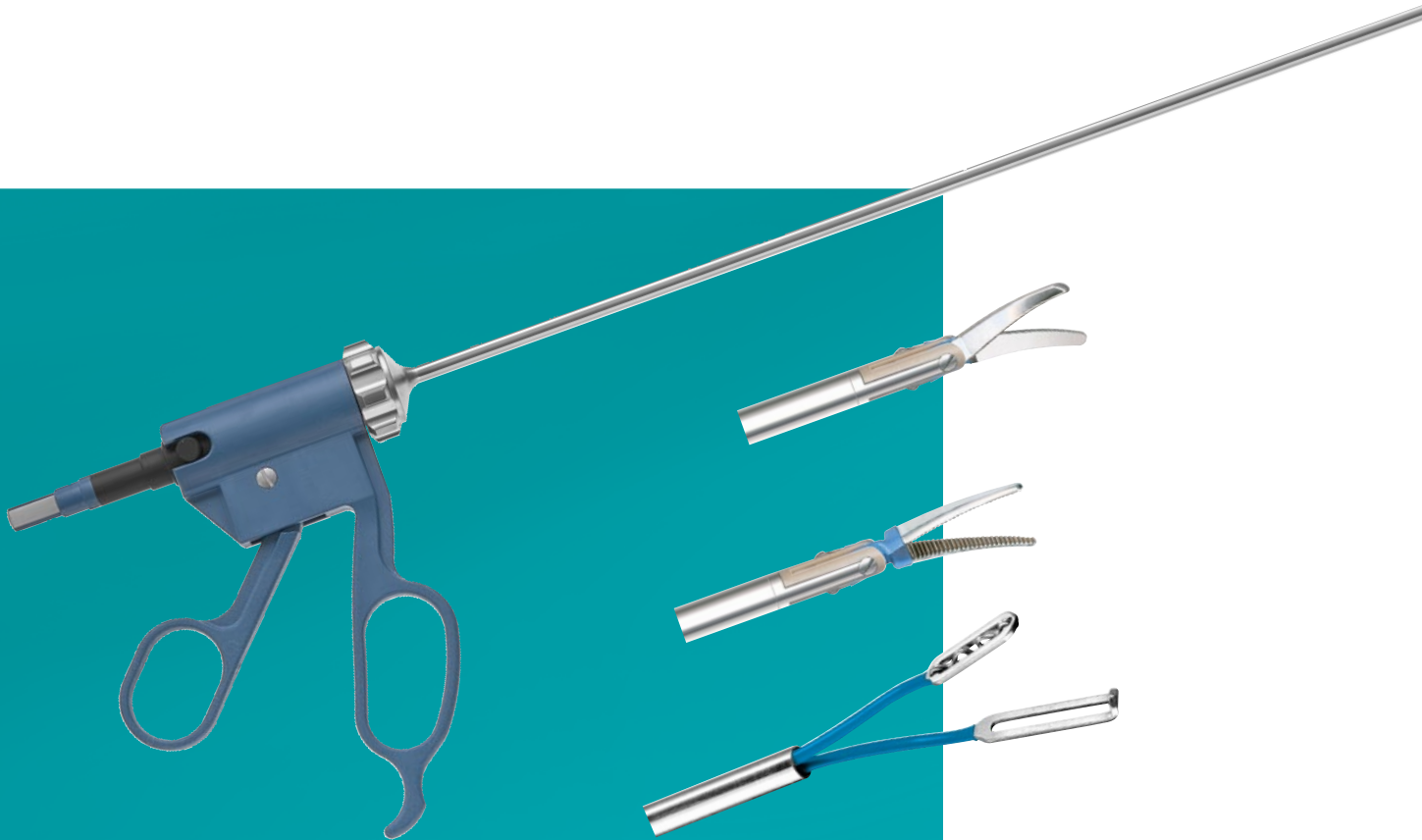

## DETACHABLE BIPOLAR FORCEPS

- 360° rotatable
- Consists of forceps body & shaft - without electrode

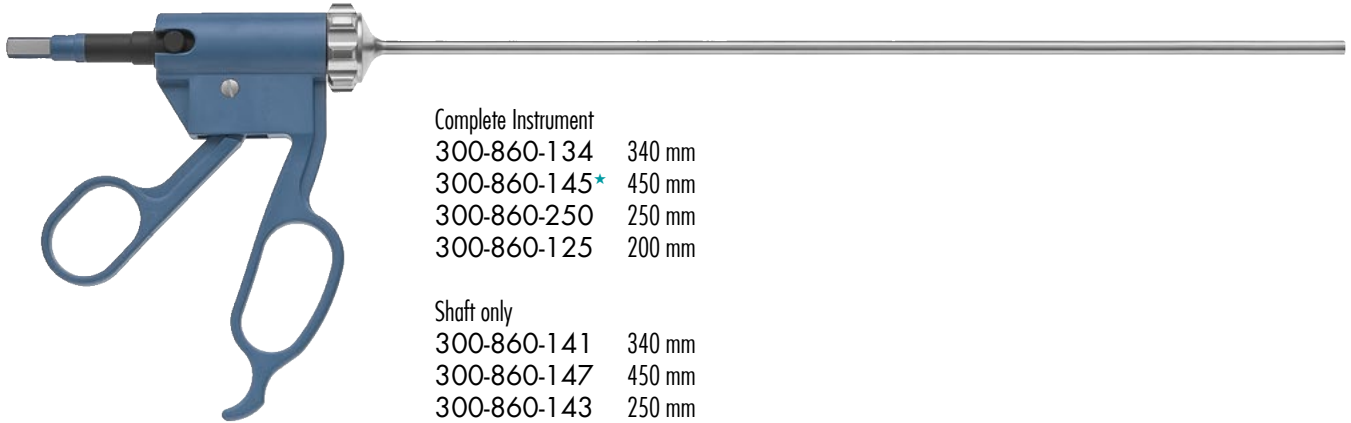

### Complete Instrument

300-860-134	340 mm
300-860-145*	450 mm
300-860-250	250 mm
300-860-125	200 mm

### Shaft only

300-860-141	340 mm
300-860-147	450 mm
300-860-143	250 mm
300-860-142	200 mm

### Handle only

300-860-140

## DETACHABLE 720° ROTATABLE BIPOLAR FORCEPS

- 720° rotatable, independently of the shaft
- Consists of forceps body & shaft - without electrode

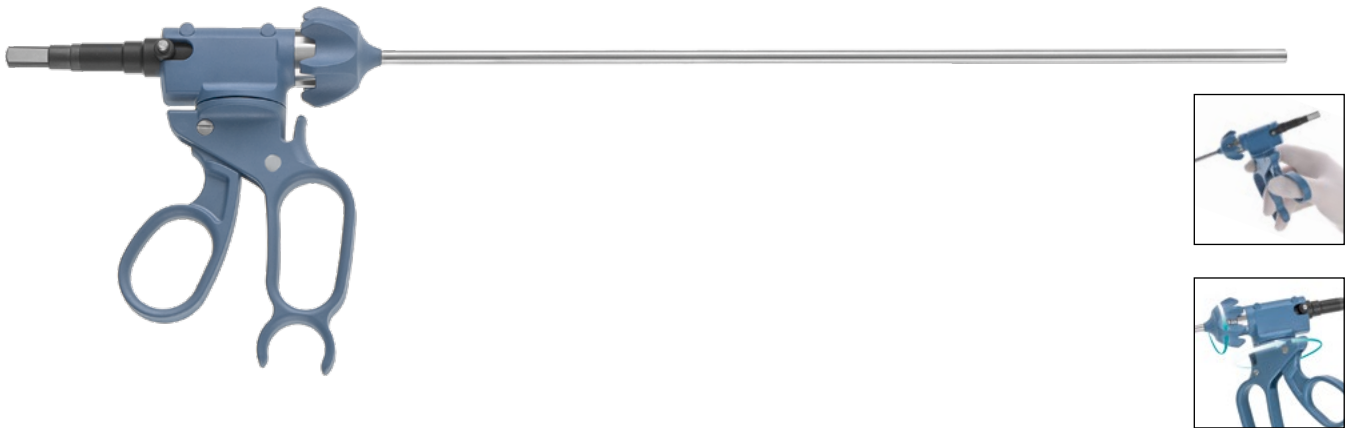

### Complete Instrument

300-860-534	340 mm
300-860-545	450 mm

### Shaft only









300-560-535	340 mm
300-560-546	450 mm

### Handle only, with adjustment (rotating stop)

300-860-500

## POWERGRIP BIPOLAR ELECTRODE INSERTS

- Insulated up to the end of the working zone
- Ø 5mm

	Grasping Forceps, fenestrated jaws, curved	300-860-009	340 mm
	Grasping Forceps, fenestrated jaws, serrated	300-860-013* 300-860-023 300-860-063	340 mm 450 mm 200 mm*
	Grasping Forceps, slightly curved	300-860-011 300-860-021 300-860-061	340 mm 450 mm 250 mm*
	Powergrip Bipolar Forceps, 2x3 teeth	300-860-012	340 mm
	Delta Grasping Forceps, double action	300-860-014 300-860-024	340 mm 450mm
	Grasping Forceps, curved	300-860-015 300-860-025 300-860-065	340 mm 450 mm 200 mm*
	Duckbill Forceps	300-860-016 300-860-026	340 mm 450 mm
	TC-Metzenbaum Scissors	300-860-018* 300-860-028 300-860-068	340 mm 450 mm 200 mm*
	Maryland Insert	300-860-019* 300-860-029 300-860-069	340 mm 450 mm 200 mm*

\* 20 / 25 cm pattern not available for 720° rotatable Bipolar Forceps

### POWERGRIP PREMIUM BIPOLAR ELECTRODE INSERTS



- Joint mechanism stays in place
- Insulated up to the end of the working zone
- Ø 5mm

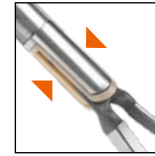

Premium model -  
joint mechanism  
stays in place



Standard model -  
joint mechanism  
exposes

	Grasping Forceps, fenestrated, curved	300-860-009	340 mm
	Grasping Forceps, fenestrated, straight	300-860-032	340 mm
	Grasping Forceps, fenestrated, curved	300-860-033	340 mm
	TC Metzenbaum Scissors	300-860-035	340 mm
	Maryland Forceps	300-860-037	340 mm
	Cut and seal forceps, curved	300-860-040	340 mm



### 3mm DETACHABLE BIPOLAR FORCEPS

- Small diameter, equal performance
- One-finger control of the 360° rotation wheel
- Overload protection and direct force transmission
- Flat plug for common bipolar cables



Shaft,  $\varnothing$  3mm  
 300-867-129 290mm  
 300-867-120 200mm



Grasping Forceps, fenestrated

300-867-529 290mm  
 300-867-520 200mm



Maryland Forceps, curved

300-867-929 290 mm  
 300-867-620 200 mm



Micro Forceps

300-867-729 290 mm  
 300-867-720 200 mm

### BIPOLAR FORCEPS SYSTEM, Ø 5mm

- Detachable
- Consists of forceps body, inner & outer tube - without electrode

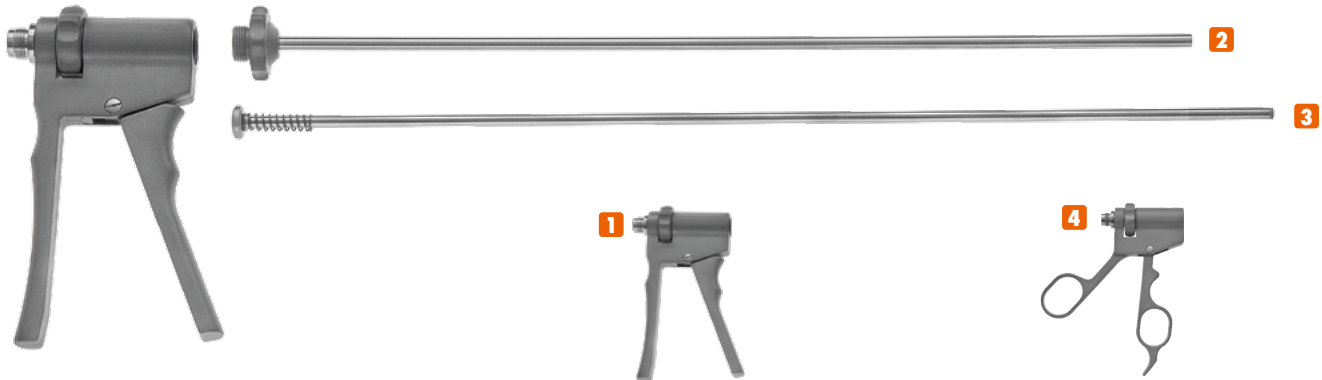

With standard handle **1**

300-855-034	340 mm
300-855-045	450 mm
300-855-020	200 mm

With ring handle **4**

300-855-134	340 mm
300-855-145	450 mm
300-855-120	200 mm



Forceps body standard  
300-855-001



Forceps body ring handle  
300-855-101

Outer Tube **2**

300-855-007	340 mm
300-855-052	450 mm
300-855-003	200 mm

Inner tube **3**

300-855-006	340 mm
300-855-051	450 mm
300-855-002	200 mm



Bipolar Cables, length: 3m  
2 banana plug 300-855-100  
Valleylab plug 300-855-105  
Martin plug 300-855-102  
Erbe plug 300-855-103



Adapter for bipolar cable  
300-855-400 with flat plug  
300-855-401 with 2-pin-plug

#### Electrodes / Inserts

	Tubal ligation	300-855-010	340 mm
		300-855-022	450 mm
		300-855-060	200 mm
	Micro jaw, 1 mm	300-855-011	340 mm
		300-855-021	450 mm
		300-855-061	200 mm
	Grasping forceps, 3 mm	300-855-015	340 mm
		300-855-025	450 mm
		300-855-065	200 mm
	Scissors, curved	300-855-017	340 mm
		300-855-027	450 mm
		300-855-067	200 mm
	Kleppinger, serrated	300-855-013	340 mm
		300-855-023	450 mm
		300-855-063	200 mm
	Scissors with TC blades, curved	300-855-018	340 mm
		300-855-028	450 mm
	Dissector Maryland, curved	300-855-019	340 mm
		300-855-029	450 mm
		300-855-069	200 mm

### MICRO BIPOLAR SYSTEM, Ø 3mm

- Suits for all operations in Laparoscopy
- Especially for fine coagulation of tissue and small vessels
- Easy detachable for cleaning purposes



300-857-100 Bipolar Micro Coagulation Forceps, Ø 3mm

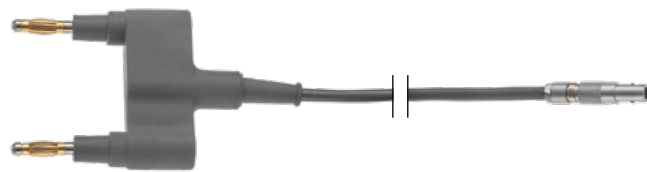

300-857-205  
Cable only for 300-857-100

#### Electrode Inserts



Micro Electrode, rippled bar

300-857-111



Micro Electrode, fluted tip, 1mm

300-857-112



#### Bipolar Micro Electrodes, 3 mm



Bipolar L-Hook

300-857-301



Bipolar V-Hook

300-857-302



Bipolar Needle

300-857-303

### BIPOLAR CABLES



Flat plug



Flat plug, angled



Flat plug, square



2-pin plug



RZ HF Unit  
SDS Plug,  
programmable

3m	700-500-300
5m	700-500-500



2-Banana\*

3m	700-350-030	300-860-100	700-350-130	700-351-030
5m	700-350-050	300-860-111	700-350-150	700-351-050



Erbe

3m	700-101-001	700-100-130	700-101-130	700-100-102
5m	700-100-101	700-100-150	700-101-150	700-100-103



Martin, Aesculap  
Berchtold

3m	700-287-030	700-200-130	700-287-130	700-200-132
5m	700-287-050	700-200-150	700-287-150	700-200-152



RZ, Valleylab,  
Lamidey, EMC

3m	700-351-031*	700-300-003	700-351-131	700-300-203
5m	700-351-051	700-300-005	700-351-151	700-300-205



Erbe  
EMC/Dolley

3m	700-400-050	700-400-003	700-400-103	700-400-203
5m	700-400-055		700-400-105	

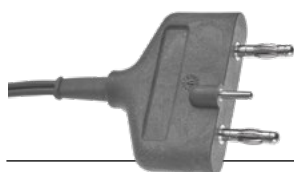

Valleylab  
autobipolar

3m	700-400-030	700-400-130
5m		

\* Not available with CE marking within Europe



2-pin plug, angled

2-pin plug, angled

Round plug

R. Wolf plug

Karl Storz plug

Ethicon Scissors plug

Aesculap Plug

700-345-403	700-345-003	700-739-003	700-630-003	700-351-047	700-351-053	700-200-030
700-345-405	700-345-005	700-739-005		700-351-048	700-351-055	700-200-050
700-101-230		700-100-202	700-100-104	700-100-302	700-100-402	700-100-502
700-101-250		700-100-303	700-100-105	700-100-305	700-100-405	700-100-505
700-287-230		700-200-232	700-390-030	700-200-332	700-200-432	700-200-532
700-287-250		700-200-252	700-390-050	700-200-352	700-200-452	700-200-552
700-351-231	700-300-403	700-736-003	700-300-503	700-300-603	700-300-703	
700-351-251	700-300-405	700-736-005	700-300-505		700-300-705	700-300-805
700-400-303	700-400-403	700-400-503		700-400-603		
		700-400-205				



# BARIATRIC INSTRUMENTS

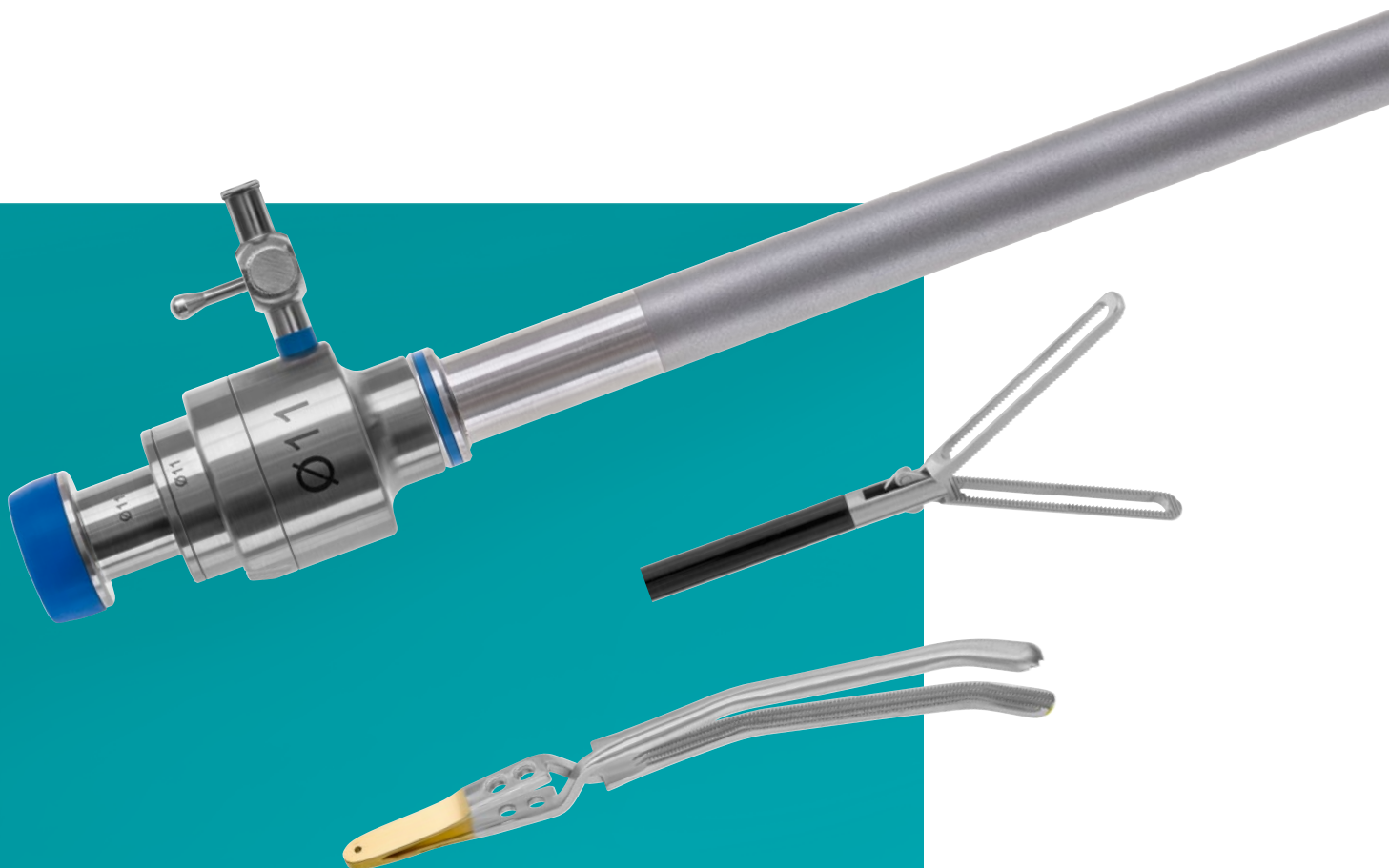



Stainless steel valve, XL smooth stainless steel sleeve,  
150mm working length  
300-220-155 Ø 5.5mm  
300-220-111 Ø 11.0mm  
300-220-113 Ø 13.0mm



Synthetic valve, XL smooth stainless steel sleeve  
150mm working length  
300-230-155 Ø 5.5mm  
300-230-111 Ø 11.0mm  
300-230-113 Ø 13.0mm



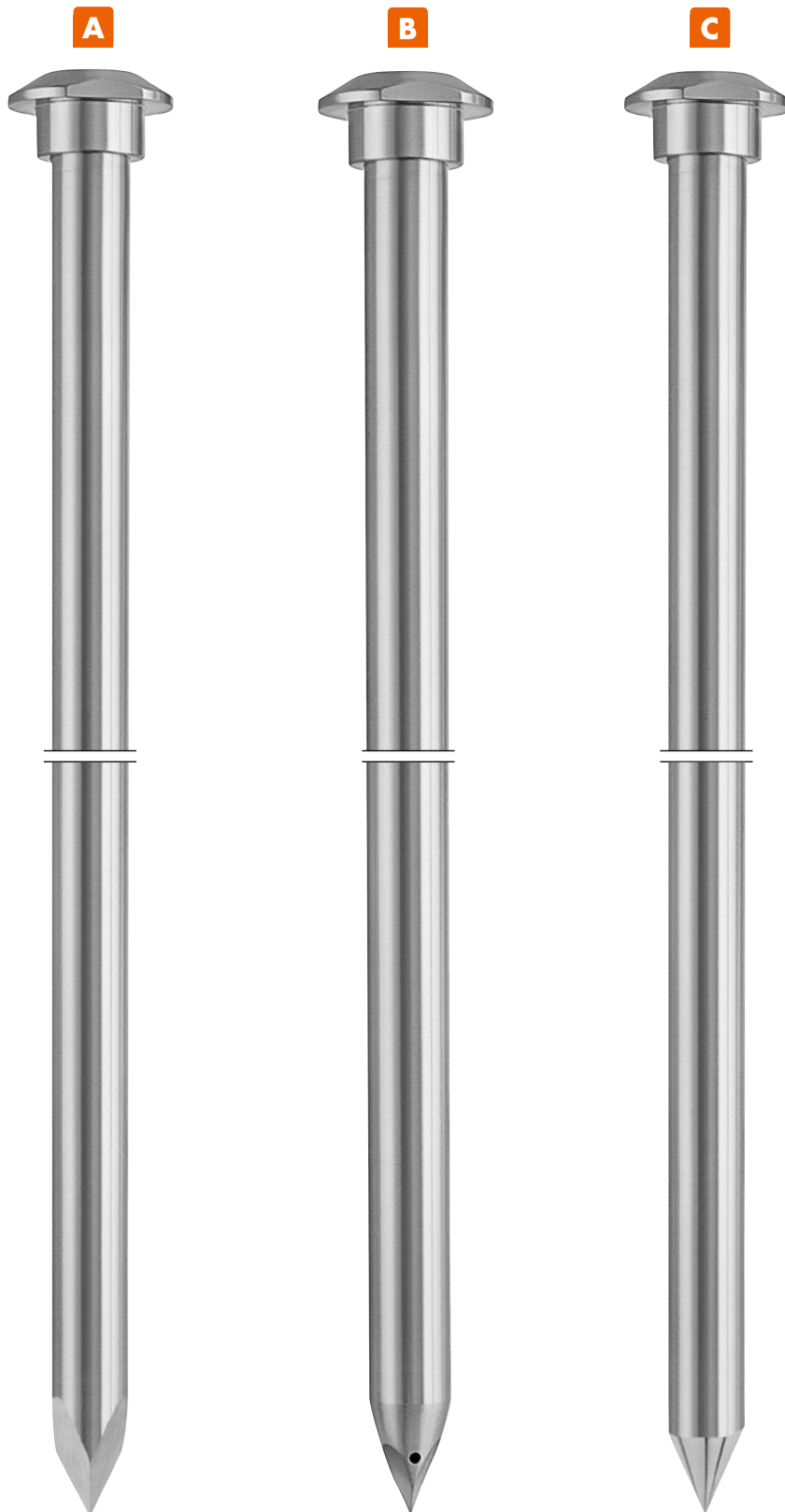

**A**

With pyramidal tip, reusable, cutting  
150mm working length  
300-241-155 Ø 5.5mm  
300-241-111 Ø 11.0mm  
300-241-113 Ø 13.0mm

**B**

Cannulated with hole, pyramidal tip  
150mm working length  
300-244-155 Ø 5.5mm  
300-244-111 Ø 11.0mm  
300-244-113 Ø 13.0mm

**C**

With conical tip, reusable, cutting  
150mm working length  
300-240-155 Ø 5.5mm  
300-240-111 Ø 11.0mm  
300-240-113 Ø 13.0mm



Suction and irrigation tube with 4 x 4 holes for handles 300-019-501 and 300-019-601  
300-019-805 Ø 5mm, 450mm  
300-019-810 Ø 10 mm, 450mm

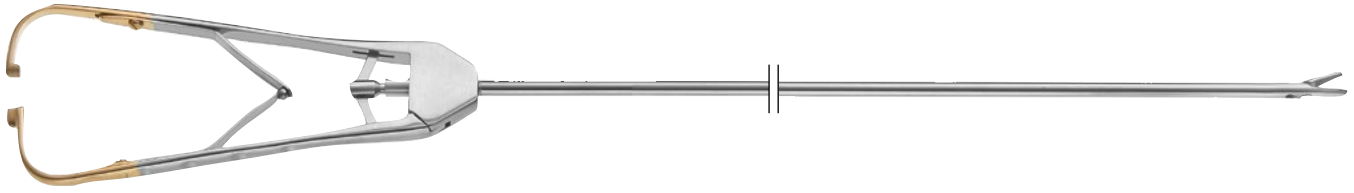

300-330-045 **MATHIEU** Endoscopic TC needle holder, traditional ratchet design, spring-loaded, curved left, Ø 5 mm, 450 mm working length

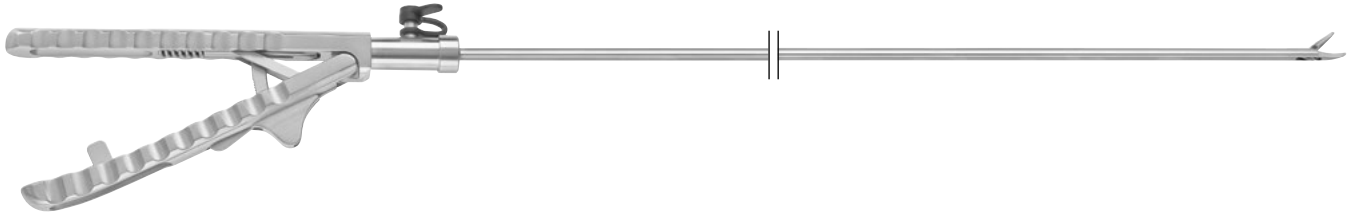

Endoscopic TC needle holder, strong axial handle, automatic locking mechanism, Ø 5 mm, 450 mm working length

- 300-100-697 straight jaw
- 300-100-698 left curved jaw

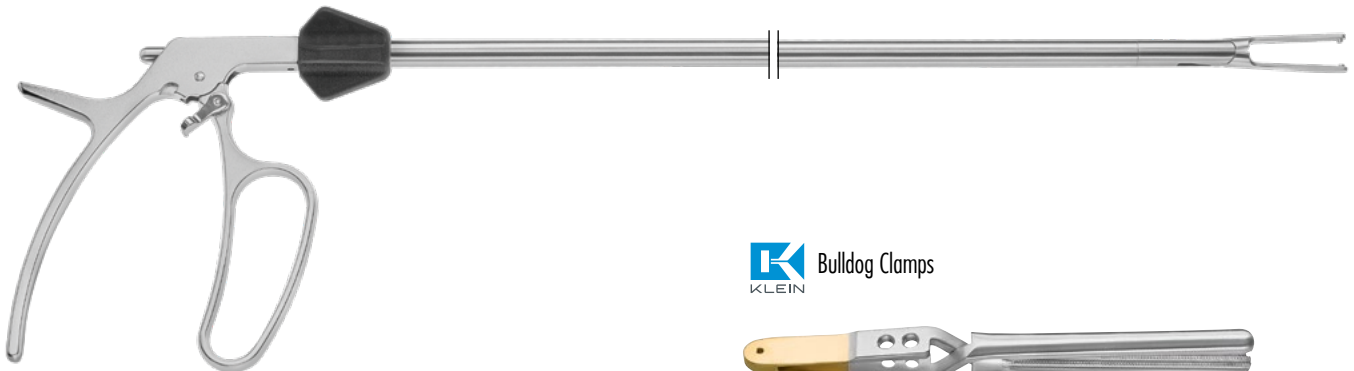

300-111-775 Endoscopic Bulldog Clamp Applier, detachable, Ø 10mm, 360° rotating, 450mm working length



300-100-772 60 mm jaws  
Endoscopic Bulldog Clamp for bowel surgery, straight, with DeBaKey serration



300-100-786 60 mm jaws  
Endoscopic Satinsky Bulldog Clamp, with DeBaKey serration, to be used with 12.5 mm trocar system



300-100-789 60 mm jaws  
Endoscopic Satinsky Bulldog Clamp, curved, with atraumatic DeBaKey serration, to be used with 12.5 mm trocar system



insert only

300-401-732



300-411-732



300-421-732

### KELLY

Dissecting forceps curved, fine-tapered, cross-serrated jaws with wide opening, double action, Ø 5 mm, 450 mm

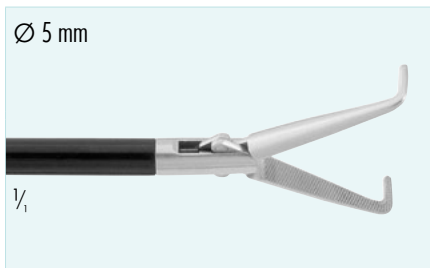

300-401-738

300-411-738

300-421-738

### MIXTER

Fine dissection forceps 90° angled, fine serrated jaws, double action, Ø 5 mm, 450 mm

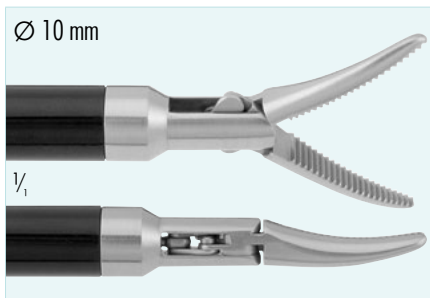

300-401-730

300-411-730

300-421-730

### MARYLAND

Dissecting forceps curved, blunt jaws, double action, Ø 10 mm, 450 mm

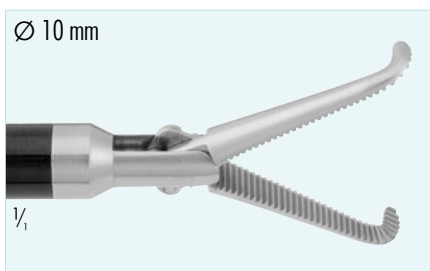

300-401-739

300-411-739

300-421-739

### MIXTER

Dissecting forceps 90° angled, serrated jaws, double action, Ø 10 mm, 450 mm

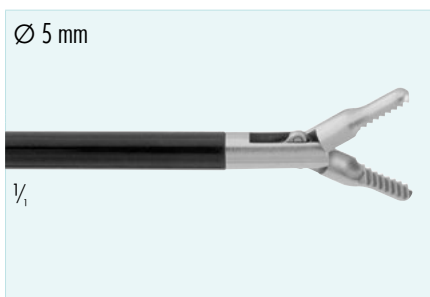

300-401-025

300-411-025

300-421-025

### DOLPHIN

Grasping and dissection forceps, fine serrated and tapered jaws, double action, Ø 5 mm, 450 mm

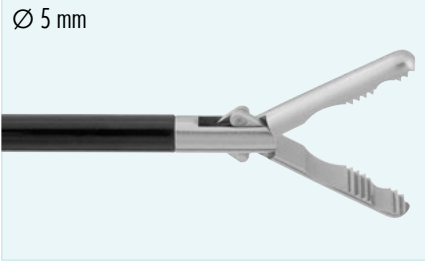
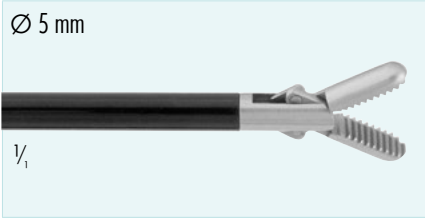
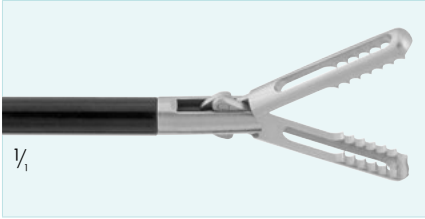
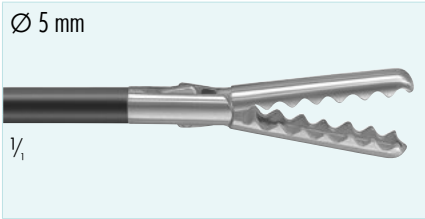
	insert only	Complete Instrument with handle 300-750-003	Complete Instrument with handle 300-750-103
<p>Ø 5 mm</p>  <p><b>FUNDUS</b> Grasping forceps with 2 cups and serrated jaws, double action, Ø 5 mm, 450 mm</p>	300-401-015	300-431-015	300-441-015
<p>Ø 5 mm</p>  <p><b>BULLNOSE</b> Grasping forceps, heavy pattern, standard serrated jaws, double action, Ø 5 mm, 450 mm</p>	300-401-001	300-431-001	300-441-001
<p>Ø 5 mm</p>  <p><b>GRIPPER #1</b> Grasping forceps with coarse serration and fenestration, double action, Ø 5 mm, 450 mm</p>	300-401-017	300-431-017	300-441-017
<p>Ø 5 mm</p>  <p><b>PRESTIGE</b> Grasping forceps with long, bevelled-edge jaws and deep cup for large tissue collection, double action, Ø 5 mm, 450 mm</p>	300-401-013	300-431-013	300-441-013



insert only

300-401-201



300-431-201



300-441-201

### COBRA

Grasping forceps with sharp 2 x 4 teeth and serrated inner jaws, double action, Ø 5 mm, 450 mm



300-401-710

300-431-710

300-441-710

### CLAW GRASPER

Grasping forceps, aggressive 2 x 3 teeth and smooth inner jaws, single action, Ø 10 mm, 450 mm

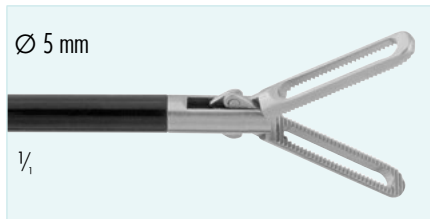

300-401-289

300-431-289

300-441-289

### JOHANS

Grasping forceps with 20 mm fenestrated jaws, double action, Ø 5 mm, 450 mm



300-401-291

300-431-291

300-441-291

### LONG JOHANS

Grasping forceps with 40 mm fenestrated jaws, double action, Ø 5 mm, 450 mm



insert only

300-401-082



300-411-082



300-421-082

Biopsy forceps with sharp oval cups, double action, Ø 5 mm, 450 mm

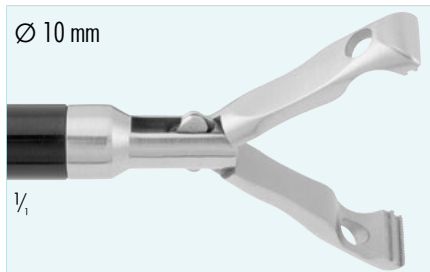

insert only

300-401-079



300-431-079



300-441-079

### DEBAKEY BABCOCK

Traditional style Babcock grasping forceps, fenestrated jaws with atraumatic DeBakey serration, double action, Ø 10 mm, 450 mm

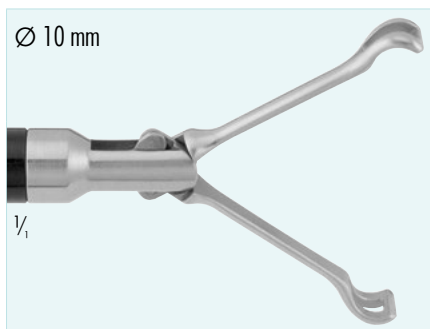

300-401-078

300-431-078

300-441-078

### BABCOCK

Traditional style Babcock grasping forceps, fenestrated jaws with fine serration, double action, Ø 10 mm, 450 mm

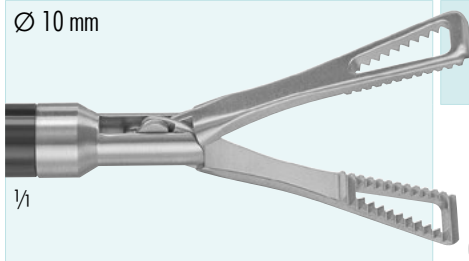

insert only

300-401-085



300-431-085



300-441-085

**COLLIN**

Grasping forceps, V-shaped tip with deep serrations for a firm grip, double action, Ø 10 mm, 450 mm

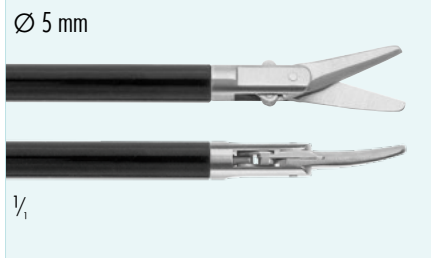

insert only

300-401-067



300-411-067



300-421-067

**ORIGINAL METZENBAUM**

Scissors, short blades (12 mm), slightly curved, double action, Ø 5 mm, 450 mm

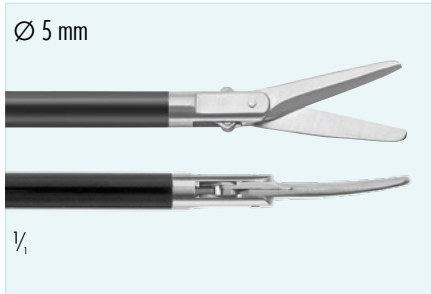

300-401-070

300-411-070

300-431-070

**METZENBAUM**

Scissors, long blades (18 mm), slightly curved, double action, Ø 5 mm, 450 mm

## DETACHABLE XL BIPOLAR FORCEPS

- 360° rotatable
- Consists of forceps body & shaft - without electrode



300-860-145 Bipolar Coagulation Forceps, 450mm

## POWERGRIP XL BIPOLAR ELECTRODE INSERTS

- Insulated up to the end of the working zone
- Ø 5mm



	Grasping Forceps, fenestrated jaws, serrated, 5 mm	300-860-023	450 mm
	Grasping Forceps, slightly curved	300-860-021	450 mm
	Delta Grasping Forceps	300-860-024	450 mm
	Grasping Forceps, curved	300-860-025	450 mm
	TC-Metzenbaum Scissors	300-860-028	450 mm
	Maryland Insert	300-860-029	450 mm



# PEDIATRIC AND MINI INSTRUMENTS

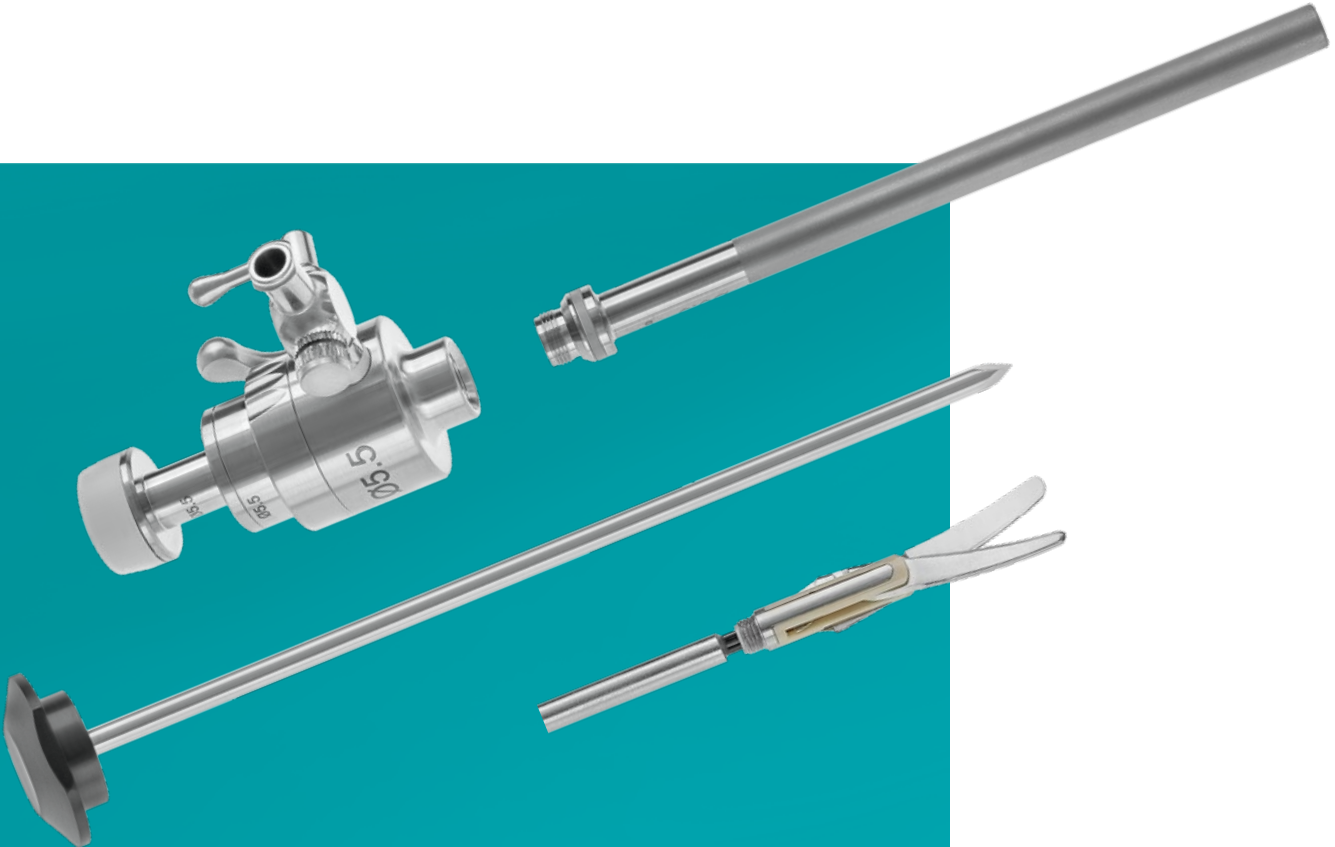

## PEDIATRIC TROCAR SYSTEM

- 100mm working length
- Ø 5.5mm



MultiPort Trocar System



SiliPort Trocar System

- 1** Stainless steel sleeve, smooth
- 2** Stainless steel sleeve, thread
- 3** Stainless steel sleeve, oblique
- 4** Synthetic sleeve, smooth
- 5** Synthetic sleeve, thread

MultiPort Trocar System

- 300-220-055\*
- 300-221-055
- 300-222-055\*
- 300-223-055
- 300-224-055

Siliport Trocar System

- 300-230-055
- 300-231-055
- 300-232-055
- 300-233-055
- 300-234-055



300-112-035 Stainless steel trocar with smooth sleeve, 70mm working length, Ø 3.5mm

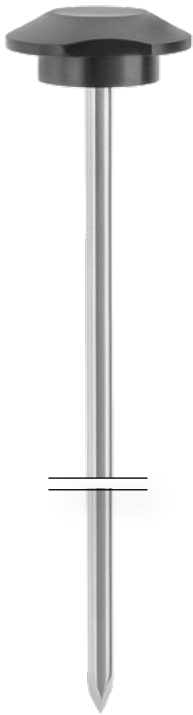

With pyramidal tip, reusable, cutting  
 300-241-035 Ø 3.5mm  
 300-241-055\* Ø 5.5mm



With conical tip, reusable, cutting  
 300-240-035 Ø 3.5mm  
 300-240-055 Ø 5.5mm



Hasson Obturator with blunt ball tip,  
 reusable, atraumatic  
 300-242-035 Ø 3.5mm  
 300-242-055 Ø 5.5mm



Safety Trocar  
 300-152-055 5.5 mm



Sealing caps, color-coded, 10 pieces  
 300-250-035 Ø 3.5mm (red)  
 300-250-055\* Ø 5.5mm (white)



Gaskets for MultiPort Trocar System, 10 pieces  
 300-250-235 Ø 3.5mm (black)  
 300-250-255\* Ø 5.5mm (white)



Gaskets for MultiPort Trocar System, 10 pieces  
 300-250-135 Ø 3.5mm  
 300-250-155\* Ø 5.5mm

## RZ EASYCLEAN MINI SUCTION AND IRRIGATION SYSTEM

- 2 color coded trumped valves
- Universal suction channel
- Lateral LuerLock irrigation channel



Suction and irrigation set  
 300-019-700 suction tube 300-019-735 and big valve body 300-019-501

### Spare Parts for RZ EasyClean Mini Suction and Irrigation System

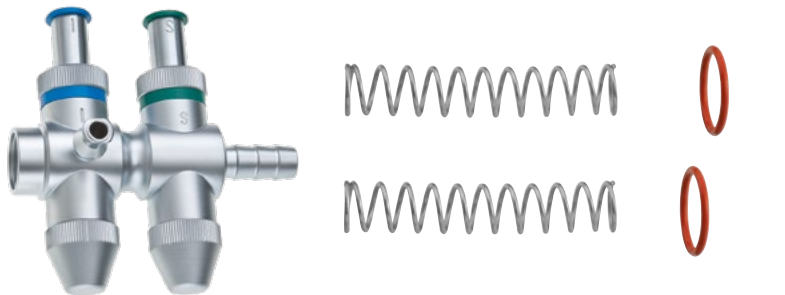

300-501-730 big  
 300-601-731 small  
 Single Valve Body

300-019-770  
 Spring  
 1 set with 10 pieces

300-019-780  
 Gasket O-Ring  
 1 set with 10 pieces



300-019-735 Suction and irrigation tube with 4x4 holes,  $\varnothing$  3.5mm  
 for handles 300-019-501 and 300-019-601, 240mm



300-165-100 Suction and irrigation handle with 2 trumpet valves. Suction channel with large universal tube connector, irrigation channel with lateral LuerLock connection. Removable ergonomic handle plate for easy cleaning and maintenance.



300-166-100\* Pistol-shaped suction and irrigation handle with 2-way valve and 2 big universal tube connectors for suction and irrigation. Ergonomic handle design for optimal operating convenience.



Suction and irrigation tubes,  
for 300-165-100 and 300-166-100



4 holes, with markings,  $\varnothing$  3 mm



340mm working length  
250mm working length

300-172-003  
300-172-253



16 holes, with markings,  $\varnothing$  3 mm



340mm working length  
250mm working length

300-173-003  
300-173-253

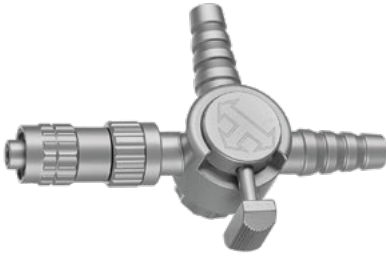

300-192-000 Suction and irrigation handle with rotating 2-way lever mechanism and 2 big universal tube adapter



Suction tubes, probes and irrigation tubes, for 300-192-000



4 holes, with markings, Ø 3 mm



340mm working length  
250mm working length

300-192-003  
300-192-253



4 x 4 holes, with markings, Ø 3 mm



340mm working length  
250mm working length

300-193-003  
300-193-253



Palpation Probe, graduated, Ø 2.8 mm



340mm working length  
250mm working length

300-193-303  
300-193-353



Injection and puncture needle, Ø 2.8mm, 1.2mm sharp needle tip



340mm working length  
250mm working length

300-194-303  
300-194-353

## TC ENDOSCOPIC NEEDLE HOLDERS, Ø 3mm



## STRAIGHT HANDLE

300-300-330	straight	330mm
300-300-340	left curved	330mm
300-300-341	right curved	330mm
300-300-430	straight	450mm
300-300-440	left curved	450mm
300-300-441	right curved	450mm



Straight

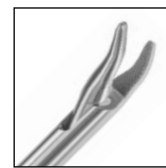

Left curved



Right curved



## ANGLED HANDLE

300-300-360	straight	330mm
300-300-370	left curved	330mm
300-300-371	right curved	330mm
300-300-460	straight	450mm
300-300-470	left curved	450mm
300-300-471	right curved	450mm

### LAPAROSCOPIC MICRO INSTRUMENTS, 2-PIECE

- Ø 3 mm shaft
- LuerLock irrigation channel
- To be used with standard RZ handles



Metzenbaum Scissors  
straight, short blade: 8mm, double action

300-503-069 330mm  
300-505-069 210mm



Hook Scissors  
round cutting blade, single action

300-503-060 330mm  
300-505-060 210mm



Peritoneal Scissors  
straight, delicate, fine serrated, single action

300-503-063 330mm  
300-505-063 210mm



Micro Scissors  
straight, sharp, single action

300-503-570 330mm  
300-505-570 210mm



Metzenbaum Scissors  
slightly curved, short blade: 12mm, double action

300-503-067 330mm  
300-505-067 210mm



Biopsy Cup Forceps  
sharp, oval cups, double action

300-503-082 330mm  
300-505-082 210mm



Biopsy Cup Forceps  
sharp, oval cups, 1 pin, 1 hole, double action

300-503-080 330mm  
300-505-080 210mm





Fundus Grasping Forceps  
serrated, double action

300-503-015  
300-505-015

330mm  
210mm



Dolphin Dissecting Forceps  
fine serrated, biopsy cup, conical shape, double action

300-503-025  
300-505-025

330mm  
210mm



Maryland fine Dissector  
serrated, curved, conical shape, double action

300-503-731  
300-505-731

330mm  
210mm



Dolphin Dissecting Forceps  
fine serrated, double action

300-503-021  
300-505-021

330mm  
210mm



Johans atraumatic Grasping Forceps  
fenestrated, serrated, double action

300-503-052  
300-505-052

330mm  
210mm



„Needle Nose“ Dissecting & Grasping Forceps  
fine, conical shape, cross serrated, double action

300-503-016  
300-505-016

330mm  
210mm



Standard Grasping Forceps  
biopsy cup, serrated, double action

300-503-000  
300-505-000

330mm  
210mm



Claw Grasper Forceps  
2x3 teeth, smooth, single action

300-503-710  
300-505-710

330mm  
210mm

## 3.5mm LAPAROSCOPIC INSTRUMENTS

- Stronger 3-piece detachable instruments, less invasive & scarless surgery
- Very simple cleaning, assembling and disassembling
- 3.5mm mini instruments designed for pediatric (250mm) and mini Laparoscopy use



300-750-101\*  
PEEK Polymer Handle with  
HF - connection



300-750-103\*  
PEEK Polymer Handle with ratchet  
and HF - connection



Outer Sheath, insulated, adaptable to all handles  
300-660-035 330mm  
300-550-035 250mm



Metzenbaum Scissors  
straight, short blade: 12mm, double action

300-403-069 330mm  
300-404-069 250mm



Hook Scissors  
round cutting blade, single action

300-403-060 330mm  
300-404-060 250mm



Biopsy Cup Forceps  
sharp, oval cups, double action

300-403-082 330mm  
300-404-082 250mm



Maryland Dissecting Forceps  
gently curved, double action

300-403-732 330mm  
300-404-732 250mm



Mixer Dissecting Forceps  
90° angled, fine serrated jaws, double action

300-403-738 330mm  
300-404-738 250mm



Fundus Grasping Forceps  
2 cups, serrated, double action

300-403-015 330mm  
300-404-015 250mm



DeBaKey Grasping Forceps  
25mm long, atraumatic, double action

300-403-244 330mm  
300-404-244 250mm



Johans Grasping Forceps  
20mm long, fenestrated, single action

300-403-284 330mm  
300-404-284 250mm



Johans Grasping Forceps  
17mm long, fenestrated, double action

300-403-289 330mm  
300-404-289 250mm

## 3mm DETACHABLE BIPOLAR FORCEPS

- Small diameter, equal performance
- One-finger control of the 360° rotation wheel
- Overload protection and direct force transmission
- Flat plug for common bipolar cables

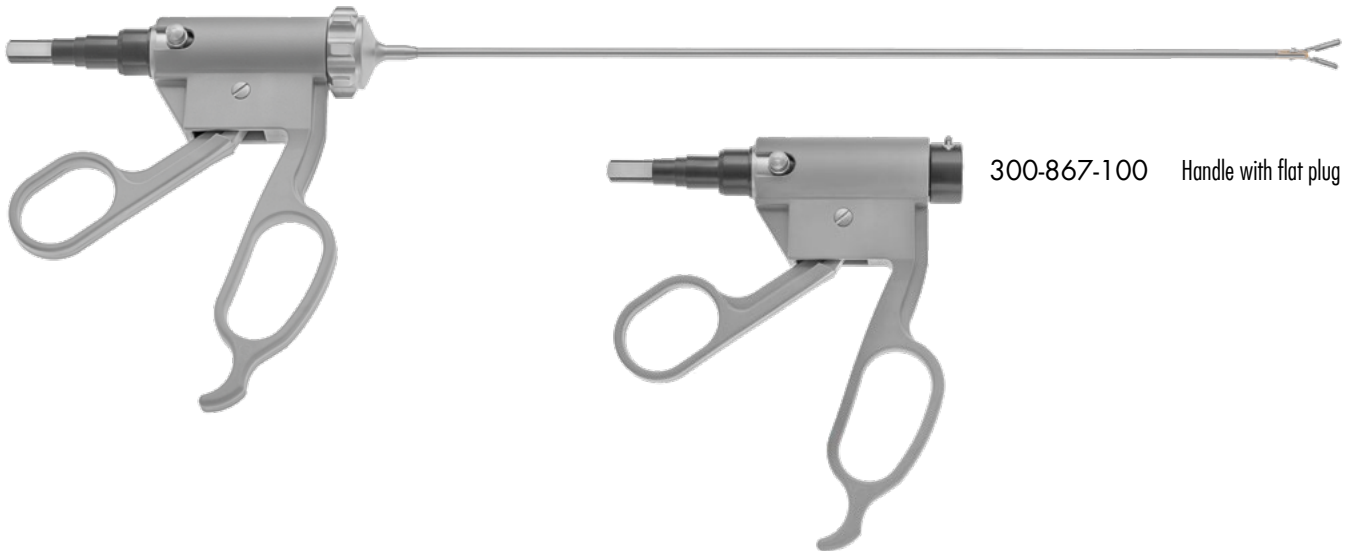

Shaft, Ø 3mm  
 300-867-129 290mm  
 300-867-120 200mm

	Grasping Forceps, fenestrated	300-867-529 290mm 300-867-520 200mm
	Maryland Forceps, curved	300-867-929 290 mm 300-867-620 200 mm
	Micro Forceps	300-867-729 290 mm 300-867-720 200 mm

## MICRO BIPOLAR SYSTEM, Ø 3mm

- Suits for all operations in Laparoscopy
- Especially for fine coagulation of tissue and small vessels
- Easy detachable for cleaning purposes



300-857-100 Bipolar Micro Coagulation Forceps, Ø 3mm

300-857-205  
Cable only for 300-857-100

### Electrode Inserts



Micro Electrode, rippled bar

300-857-111



Micro Electrode, fluted tip, 1mm

300-857-112



### Bipolar Micro Electrodes, 3 mm



Bipolar L-Hook

300-857-301



Bipolar V-Hook

300-857-302







Bipolar Needle

300-857-303

## MONOPOLAR COAGULATION ELECTRODES, Ø 2.8mm





	J-hook	300-200-132 300-200-232	330 mm 250 mm
	L-hook	300-200-133 300-200-233	330 mm 250 mm
	Ballpoint	300-200-134 300-200-234	330 mm 250 mm
	Spatula	300-200-131 300-200-231	330 mm 250 mm
	Needle	300-200-137 300-200-237	330 mm 250 mm

## BIPOLAR COAGULATION ELECTRODES



Bipolar Micro Electrodes, Ø 3 mm, 340mm working length

	Bipolar L-Hook	300-257-002
	Bipolar V-Hook	300-257-004
	Bipolar Needle	300-257-015

## CONTAINER AND CLEANING

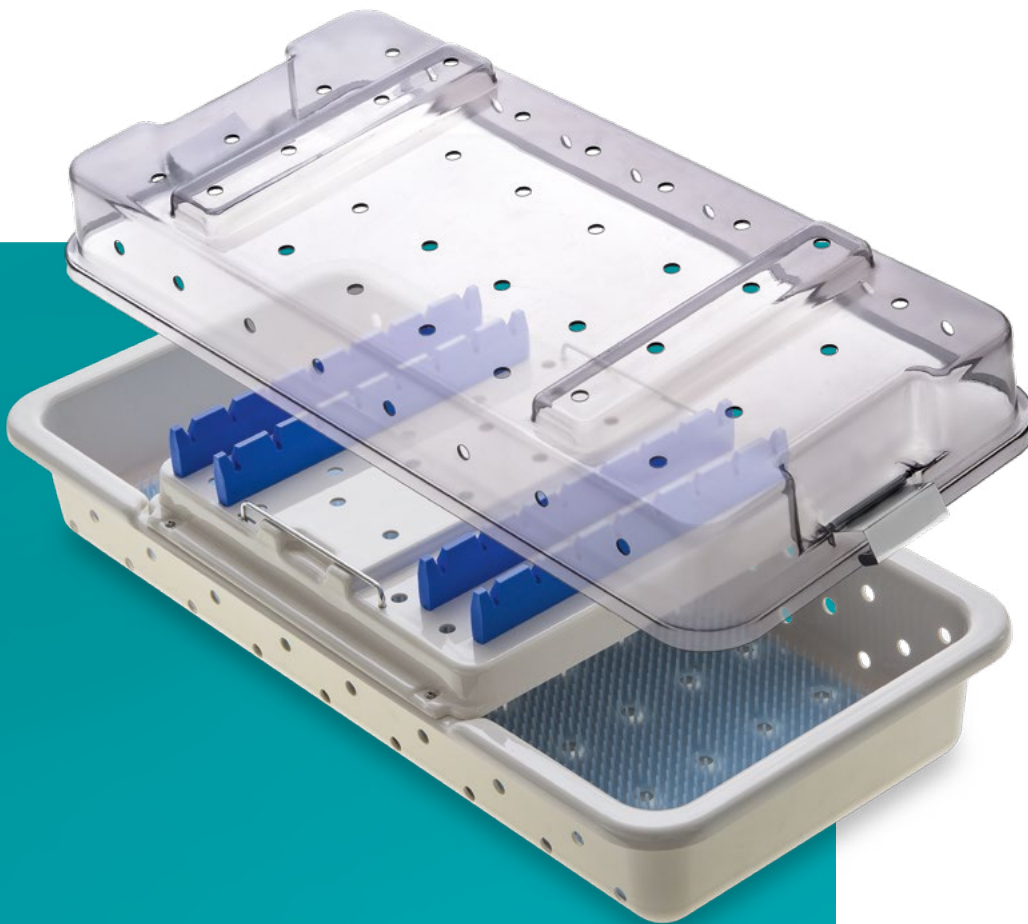

### SAFE + CLEAN ENDOSCOPE PLASTIC CONTAINER with silicone bars on base and lid

#### 600-505-000

Endoscopes	1 (∅ 1-10mm)
Endoscope length	max. 270mm
Dimensions	271 x 70 x 35mm

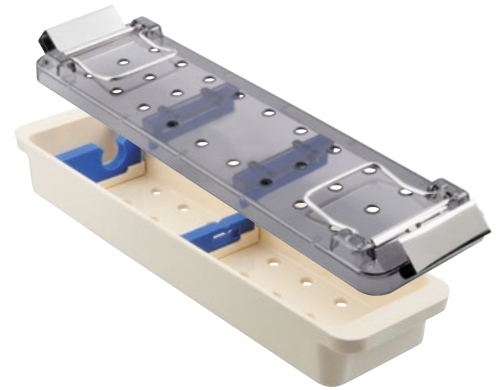

#### 600-505-002

Endoscopes	max. 2
Endoscope length	max. 190mm
Dimensions	271 x 70 x 35mm

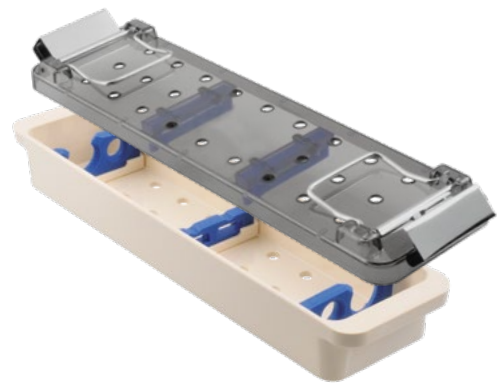

#### 600-506-002\*

Endoscopes	max. 2
Endoscope length	max. 390mm
Dimensions	394 x 70 x 35mm

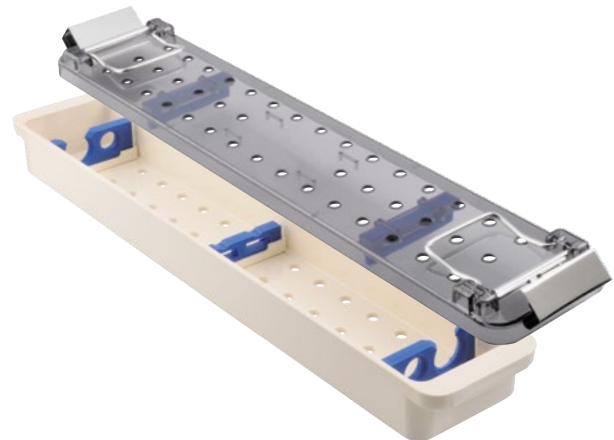

600-501-000	Endoscopes 1
600-501-002	Endoscopes max. 2
Endoscope length	max. 450mm
Dimensions	457 x 70 x 35mm

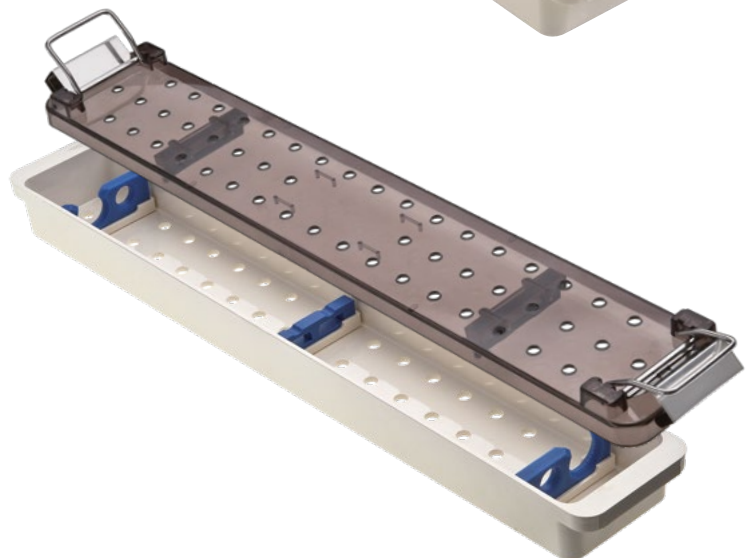



### ENDOSCOPE & INSTRUMENT CONTAINERS

600-508-000	for scopes and light guide cables
Endoscopes	max. 3 (Ø 5-10mm)
Fiber Optic Light Cable	1
Endoscope length	max. 450mm
Dimensions	465 x 212 x 51mm

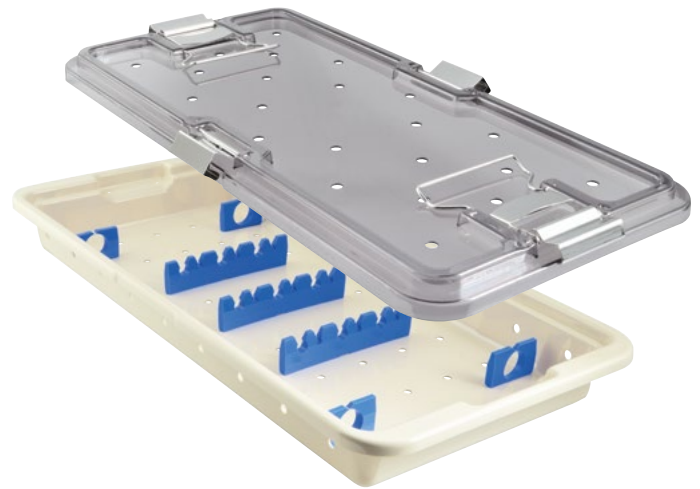

600-464-229	for fixation of instruments with rubber ties
Dimensions	464 x 229 x 51mm

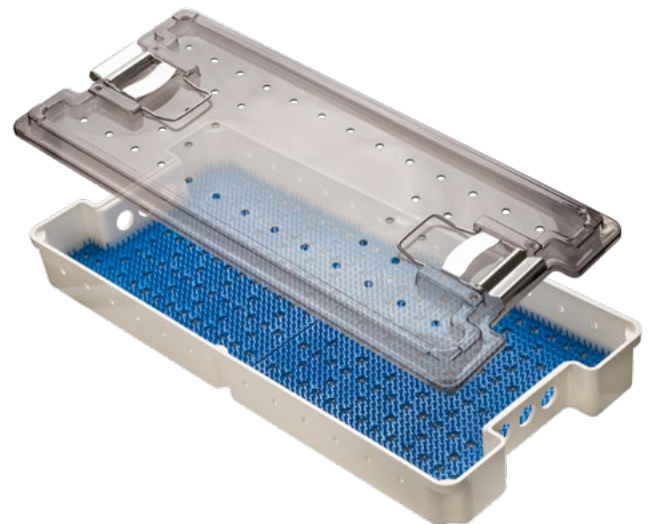

600-511-000	for instruments with rubber ties on 2 levels
Dimensions	502 x 239 x 102mm



### ENDOSCOPE CLEANING BASKETS & CONTAINERS with silicone bars on base and lid

#### 600-292-052\*

Endoscopes	max. 2
Endoscope length	max. 190mm
Dimensions	290 x 80 x 52mm

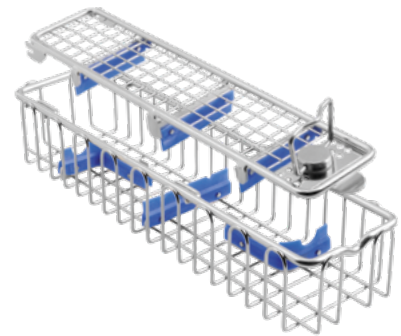

#### 600-462-052\*

Endoscopes	max. 2
Endoscope length	max. 350mm
Dimensions	460 x 80 x 52mm

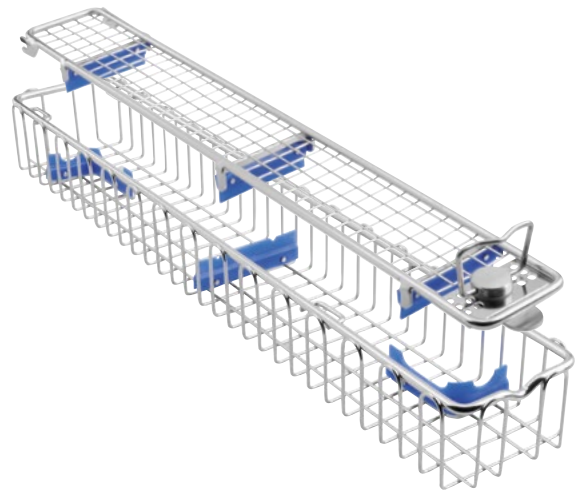

600-460-055	Endoscopes 1
600-460-056	Endoscopes max. 2
Endoscope length	max. 340mm
Dimensions	455 x 86 x 43mm

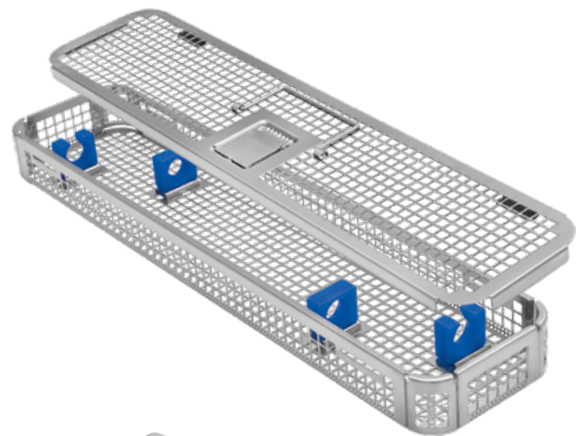

#### 600-450-070

Endoscopes	max. 2
Endoscope length	max. 330mm
Dimensions	450 x 70 x 70mm

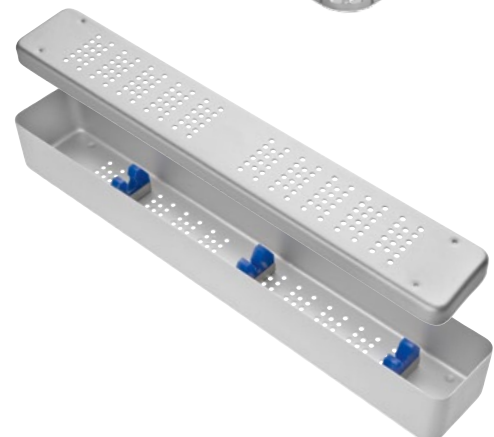

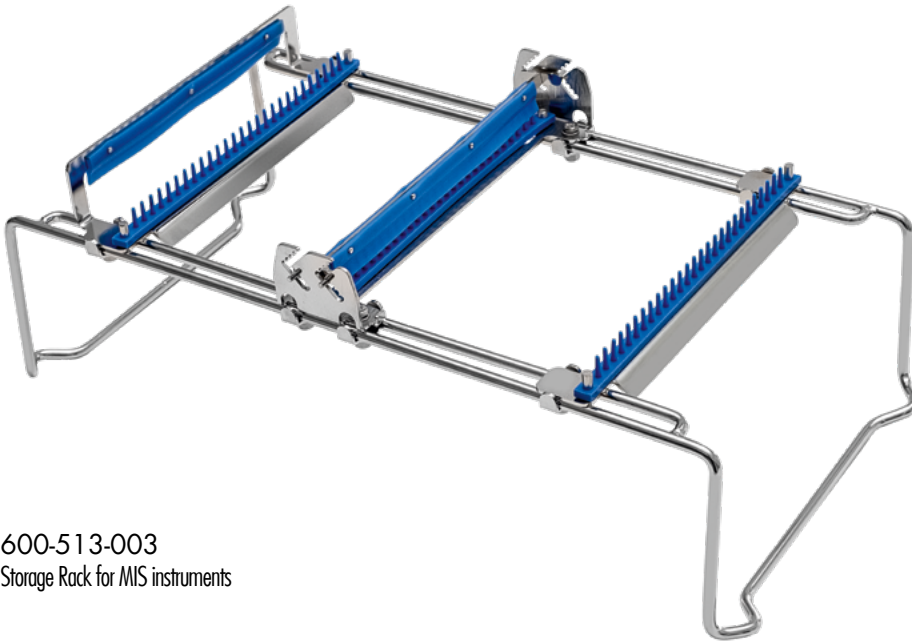

600-513-003  
Storage Rack for MIS instruments

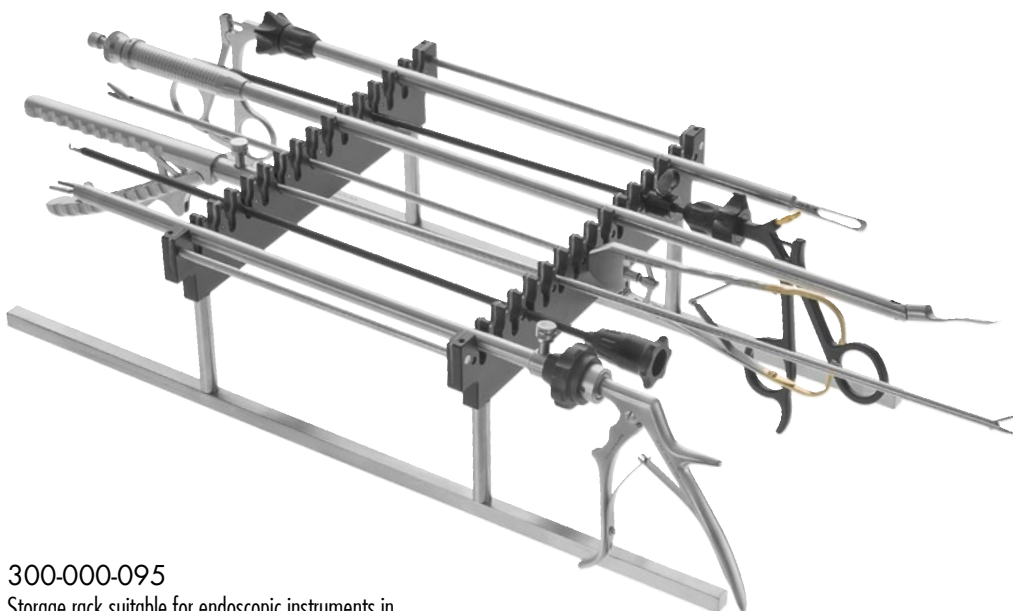

300-000-095  
Storage rack suitable for endoscopic instruments in  
Standard Container "Safety Model"  
(without Instruments)

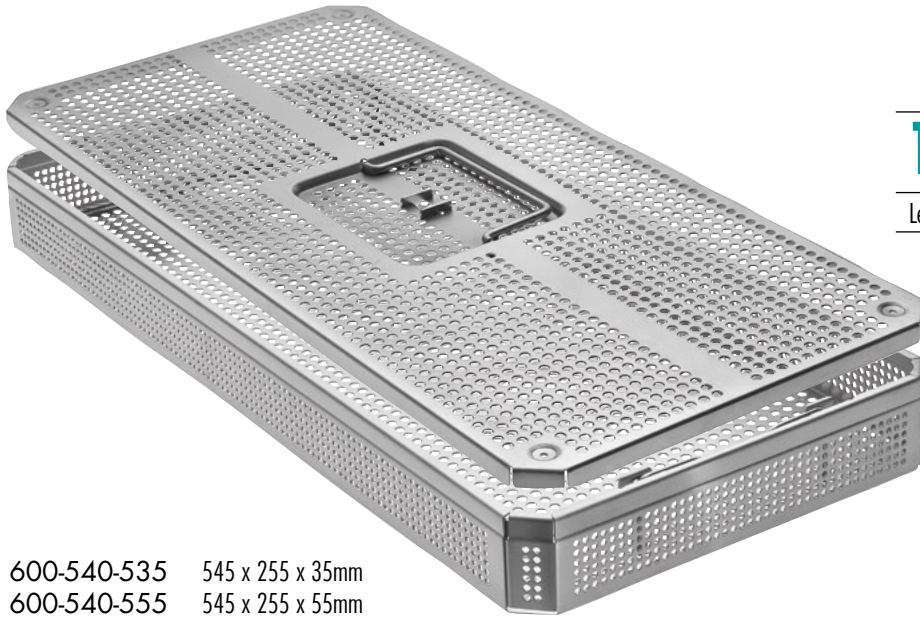

**1/1**

Stainless Steel Basket,  
round perforation, with lid

Length

545mm

- 600-540-535 545 x 255 x 35mm
- 600-540-555 545 x 255 x 55mm
- 600-540-575 545 x 255 x 75mm
- 600-540-605 545 x 255 x 105mm



- Lid only
- 600-540-500 545 x 255 mm



- Bottom only
- 600-540-530 545 x 255 x 30mm
- 600-540-550 545 x 255 x 50mm
- 600-540-570 545 x 255 x 70mm
- 600-540-600 545 x 255 x 100mm

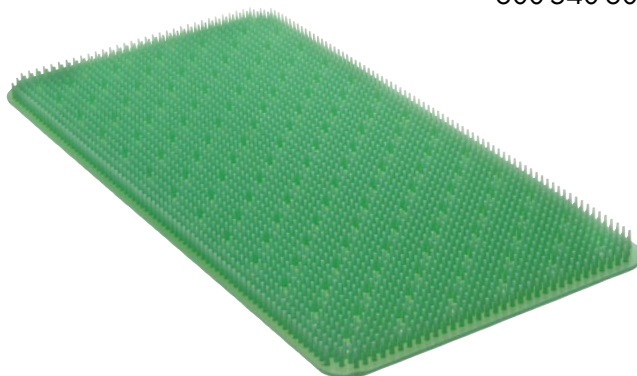

- 600-281-004 Silicone Mat green, 520 x 230mm

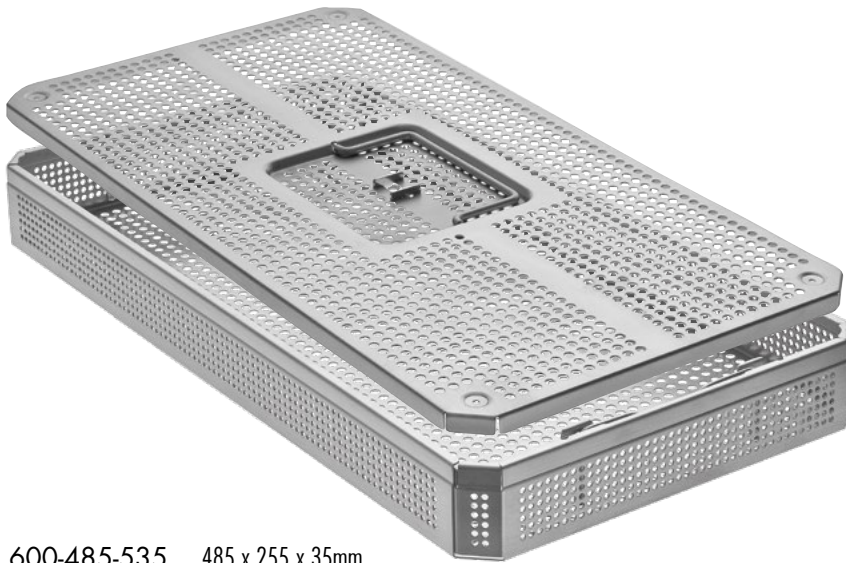

1/1

Stainless Steel Basket,  
round perforation, with lid

Length

485mm

600-485-535 485 x 255 x 35mm  
 600-485-555 485 x 255 x 55mm  
 600-485-575 485 x 255 x 75mm  
 600-485-605 485 x 255 x 105mm



Lid only  
 600-485-500 485 x 255 mm

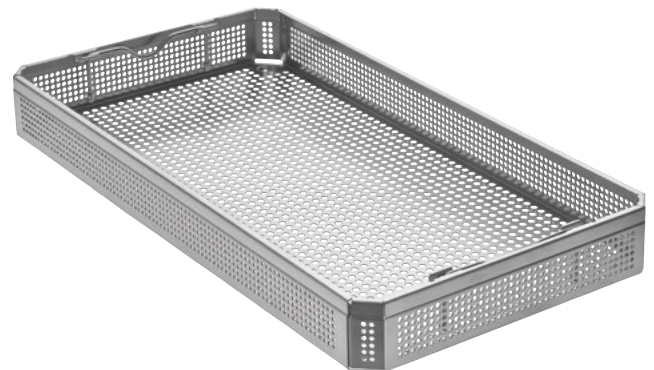

Bottom only  
 600-485-530 485 x 255 x 30mm  
 600-485-550 485 x 255 x 50mm  
 600-485-570 485 x 255 x 70mm  
 600-485-600 485 x 255 x 100mm



600-281-003 Silicone Mat green, 440 x 230mm

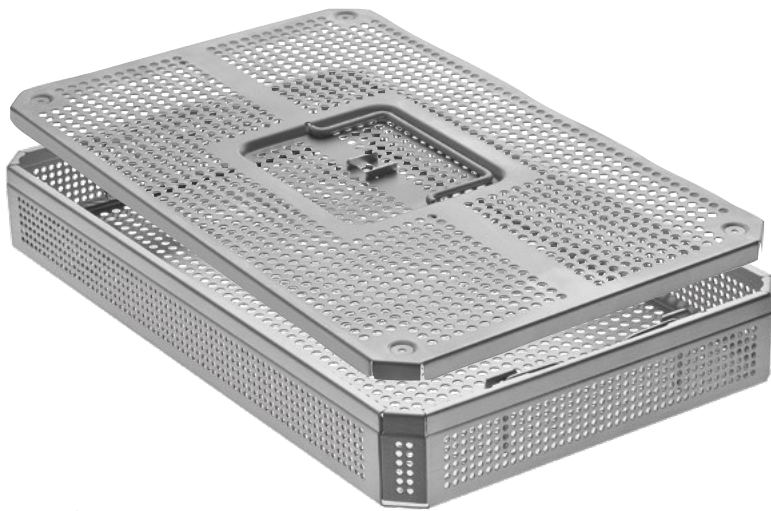

### 3/4

Stainless Steel Basket,  
round perforation, with lid

Length

405mm

600-405-535 405 x 255 x 35mm  
 600-405-555 405 x 255 x 55mm  
 600-405-575 405 x 255 x 75mm  
 600-405-605 405 x 255 x 105mm

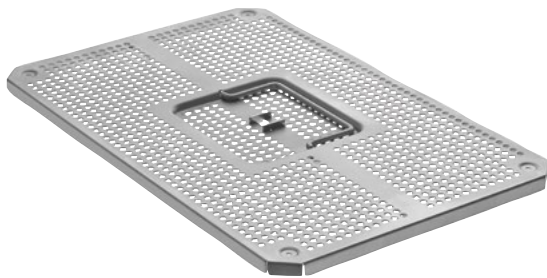

Lid only  
 600-405-500 405 x 255 mm

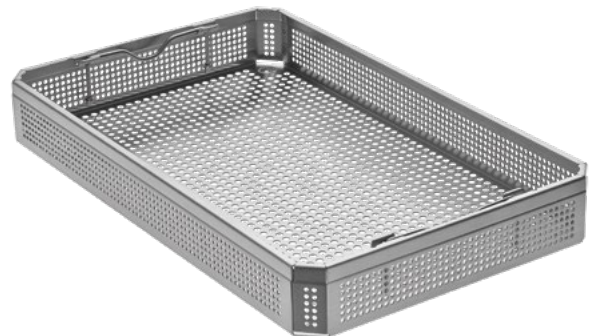

Bottom only  
 600-405-530 405 x 255 x 30mm  
 600-405-550 405 x 255 x 50mm  
 600-405-570 405 x 255 x 70mm  
 600-405-600 405 x 255 x 100mm

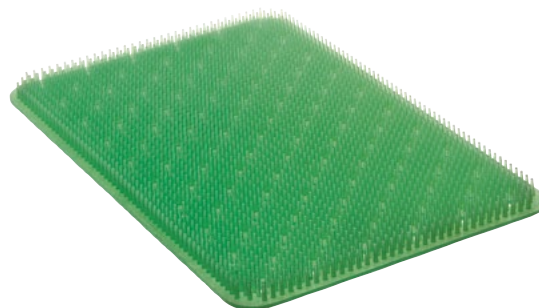

600-281-002 Silicone Mat green, 380 x 230mm



# 1/2

Stainless Steel Basket,  
round perforation, with lid

Length

255mm

600-255-535 255 x 245 x 35mm  
 600-255-555 255 x 245 x 55mm  
 600-255-575 255 x 245 x 75mm  
 600-255-605 255 x 245 x 105mm

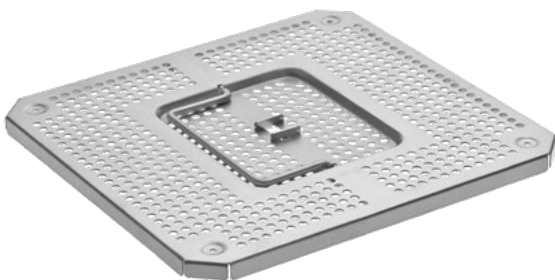

Lid only

600-255-500 255 x 245 mm



Bottom only

600-255-530 255 x 245 x 30mm  
 600-255-550 255 x 245 x 50mm  
 600-255-565 255 x 245 x 70mm  
 600-255-600 255 x 245 x 100mm



600-281-001 Silicone Mat green, 220 x 230mm



### SIZE (LXWXH)



580 x 280 x 100mm	● 600-580-101	600-579-101
	● 600-580-102	600-579-102
	● 600-580-103	600-579-103
	● 600-580-104	600-579-104
	● 600-580-105	600-579-105
	● 600-580-106	600-579-106



580 x 280 x 135mm	● 600-580-131	600-579-131
	● 600-580-132	600-579-132
	● 600-580-133	600-579-133
	● 600-580-134	600-579-134
	● 600-580-135	600-579-135
	● 600-580-136	600-579-136



580 x 280 x 150mm	● 600-580-151	600-579-151
	● 600-580-152	600-579-152
	● 600-580-153	600-579-153
	● 600-580-154	600-579-154
	● 600-580-155	600-579-155
	● 600-580-156	600-579-156



580 x 280 x 200mm	● 600-580-201	600-579-201
	● 600-580-202	600-579-202
	● 600-580-203	600-579-203
	● 600-580-204	600-579-204
	● 600-580-205	600-579-205
	● 600-580-206	600-579-206



580 x 280 x 260mm	● 600-580-261	600-579-261
	● 600-580-262	600-579-262
	● 600-580-263	600-579-263
	● 600-580-264	600-579-264
	● 600-580-265	600-579-265
	● 600-580-266	600-579-266



SIZE (LXWXH)



465 x 280 x 100mm

●	600-469-101	600-470-101
●	600-469-102	600-470-102
●	600-469-103	600-470-103
●	600-469-104	600-470-104
●	600-469-105	600-470-105
●	600-469-106	600-470-106



465 x 280 x 135mm

●	600-469-131	600-470-131
●	600-469-132	600-470-132
●	600-469-133	600-470-133
●	600-469-134	600-470-134
●	600-469-135	600-470-135
●	600-469-136	600-470-136



465 x 280 x 150mm

●	600-469-151	600-470-151
●	600-469-152	600-470-152
●	600-469-153	600-470-153
●	600-469-154	600-470-154
●	600-469-155	600-470-155
●	600-469-156	600-470-156

### SIZE (LXWXH)



285 x 280 x 100mm	●	600-280-101	600-279-101
	●	600-280-102	600-279-102
	●	600-280-103	600-279-103
	●	600-280-104	600-279-104
	●	600-280-105	600-279-105
	●	600-280-106	600-279-106



285 x 280 x 135mm	●	600-280-131	600-279-131
	●	600-280-132	600-279-132
	●	600-280-133	600-279-133
	●	600-280-134	600-279-134
	●	600-280-135	600-279-135
	●	600-280-136	600-279-136



285 x 280 x 150mm	●	600-280-151	600-279-151
	●	600-280-152	600-279-152
	●	600-280-153	600-279-153
	●	600-280-154	600-279-154
	●	600-280-155	600-279-155
	●	600-280-156	600-279-156



285 x 280 x 200mm	●	600-280-201	600-279-201
	●	600-280-202	600-279-202
	●	600-280-203	600-279-203
	●	600-280-204	600-279-204
	●	600-280-205	600-279-205
	●	600-280-206	600-279-206



285 x 280 x 260mm	●	600-280-261	600-279-261
	●	600-280-262	600-279-262
	●	600-280-263	600-279-263
	●	600-280-264	600-279-264
	●	600-280-265	600-279-265
	●	600-280-266	600-279-266



Identification label, 100 pieces per package  
**1** 600-908-100 STANDARD  
**2** 600-908-000 SMALL



600-909-000  
 Plastic security seal,  
 100 pieces per package



Identification label

with hole for snap hook  
 56x17mm

50x17mm

unmarked	●	600-900-040	600-900-041	
	●	600-900-050	600-900-051	
	●	600-900-060	600-900-061	
	●	600-900-070	600-900-071	
	●	600-900-080	600-900-081	
	●	600-900-090	600-900-091	
	●	600-900-100	600-900-101	
	marked	●	600-900-108	600-900-109
		●	600-900-110	600-900-111
		●	600-900-120	600-900-121
●		600-900-130	600-900-131	
●		600-900-140	600-900-141	
●		600-900-150	600-900-151	
	●	600-900-160	600-900-161	

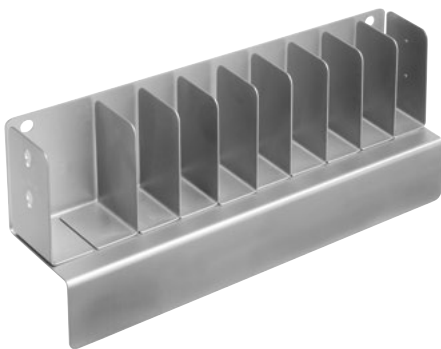

600-900-210  
 Dispenser for identification labels  
 (8 small compartments and 1 double compartment)  
 as table or wall model



600-380-100  
 PTFE (TEFLON) Filter, round, STANDARD



600-290-630  
 Filter Dispenser for disposable Filter,  
 round, 195x195mm



600-100-000  
RZ-Aquajet  
Water Jet Pistol complete  
with 9 tips and 1m pressure  
tubing, with strap and  
suspension hook



600-050-000  
Hand brush, autoclavable  
(10 pcs. per box)



600-950-100  
RZ - Brush dispenser  
for 10 brushes with suspension hook



700-900-220 Special Cotton for polishing metal sheaths and instruments



700-900-160  
Instrument Oil in 50ml bottle



700-900-250  
Oil Dispenser, 140mm



Cleaning brush (1 piece per box), 500mm length  
300-135-905 for  $\varnothing$  5 mm  
300-135-910 for  $\varnothing$  10 mm



300-215-000 Cleaning Brush,  $\varnothing$  13mm, 215mm length, 60mm brush length



300-420-065 Cleaning Brush,  $\varnothing$  3mm, 420mm length, 65mm brush length

# DEVICES



### INSUFFLATOR



#### Features:

- User-friendly interface
- Highest safety standard for patients
- All units are available with or without CO<sub>2</sub> heating system
- Pre-insufflation mode for use with Verres Cannulas
- Non-heating unit have the same gasflow rates as heating unit models

#### DELIVERY CONTAINS:

- Main Unit (300-900-020/-021/030/-031/-040/-041)
- Sterile Filter (300-902-007)\* (TP Product)
- Wrench Set (300-902-006)
- CO<sub>2</sub> High Pressure Tube (300-902-003)
- Standard Silicone Tube (300-902-005)
- Silicone Tube (300-902-004), only Heater-Version
- Gas Heater with tube (300-902-001), only Heater-Version
- Operating manual
- Mains cable

#### Airflow Insufflator A2/A3/A4

- 300-900-020 20L/min
- 300-900-021 20L/min, with heating unit
- 300-900-030 30L/min
- 300-900-031 30L/min, with heating unit
- 300-900-040 45L/min
- 300-900-041 45L/min, with heating unit

#### Technical data

Line voltage	100-240 VAC
Power consumption	25 - 40W 25-105W (with gas heating) max. 0.4A (max. 1A with gas heating)
Frequency	50 - 60Hz
Insufflation pressure	1 - 30mmHG
Gas flow	1-20L/min (300-900-020 / -021) 1-30L/min (300-900-030 / -031) 1-45L/min (300-900-040 / -041)

Gas connection	UNF 7/16" male
Gas type	Medical Grade Carbon Dioxide
Dimensions	380 x 120 x 360 mm (WxHxD)
Weight	11kg



- 1** Insufflation needle, matt chrome,  $\varnothing$  2 mm
- 300-195-080 80 mm
  - 300-195-100 100 mm\*
  - 300-195-120\* 120 mm\*
  - 300-195-150 150 mm\*
  - 300-195-170 170 mm
  - 300-195-200 200 mm

- 2** Insufflation needle, polished chrome,  $\varnothing$  2.7 mm, High-Flow
- 300-195-300 100 mm
  - 300-195-320 120 mm\*
  - 300-195-350 150 mm\*
  - 300-195-370 170 mm\*

\* standard length

Accessories (included):



Wrench Set (SW30/SW17)  
300-902-006



Sterile Filter\*  
300-902-007



Standard Silicone Tube  
300-902-005



Gas heater with tube (only Heater-Version)  
300-902-001



CO2 High Pressure Tube  
300-902-003



Silicone Tube (only Heater-Version)  
300-902-004



Optional available:  
300-902-008  
CO2 Bottle, 0.75kg, empty

\* Trade Product:  
Products marked with this TradeProduct-Symbol are not available with RZ-Marking and not with the CE-number of RZ.

### SUCTION & IRRIGATION PUMP

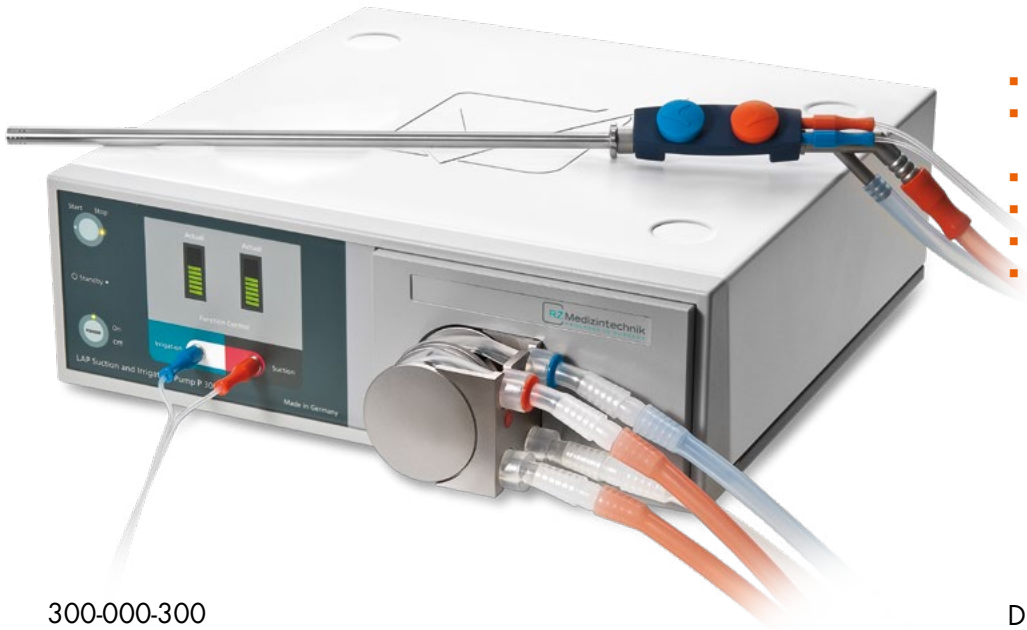

#### Features:

- Double roll pump for precise suction and irrigation during Laparoscopic surgeries
- Optional footswitch available
- Digital display of actual suction and irrigation pressures
- High flow rates up to 3L/min
- Color coded tubing sets
- Standby function
- Hand remote controlled

#### DELIVERY CONTAINS:

- Pump device (300-000-300)
- Cannula 5mm (300-000-302)
- Cannula 10mm (300-000-303)
- Silicone Tubing Set (300-000-301)
- Tube Adapter (300-000-304)
- Pneumatic Control Handle (300-000-305)
- Double-Lumen Control Tube (300-000-306)
- Mains cable
- 2 Spare fuses
- Operating manual

300-000-300

LAP Suction and Irrigation Pump P 3000, complete set

#### Technical data

Line voltage	100-240 VAC
Power input	36W
Irrigation power	0 - 3.000ml/min
Suction power	0 - 3.000ml/min
Max. pressure	0 - 750mmHg
Measurements	380 x 130 x 400mm (WxHxD)
Weight	approx. 11kg

#### Accessories



300-000-304

Adapter with instrument connector, autoclavable

300-000-307

Pneumatic double footswitch

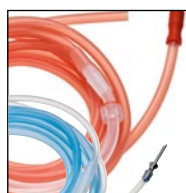

300-000-301 (included)

Tubing Set, non-sterile, autoclavable

300-000-301S (optional)

Tubing Set, single-use, sterile, moq: 50 pcs.



## SUCTION & IRRIGATION PUMP

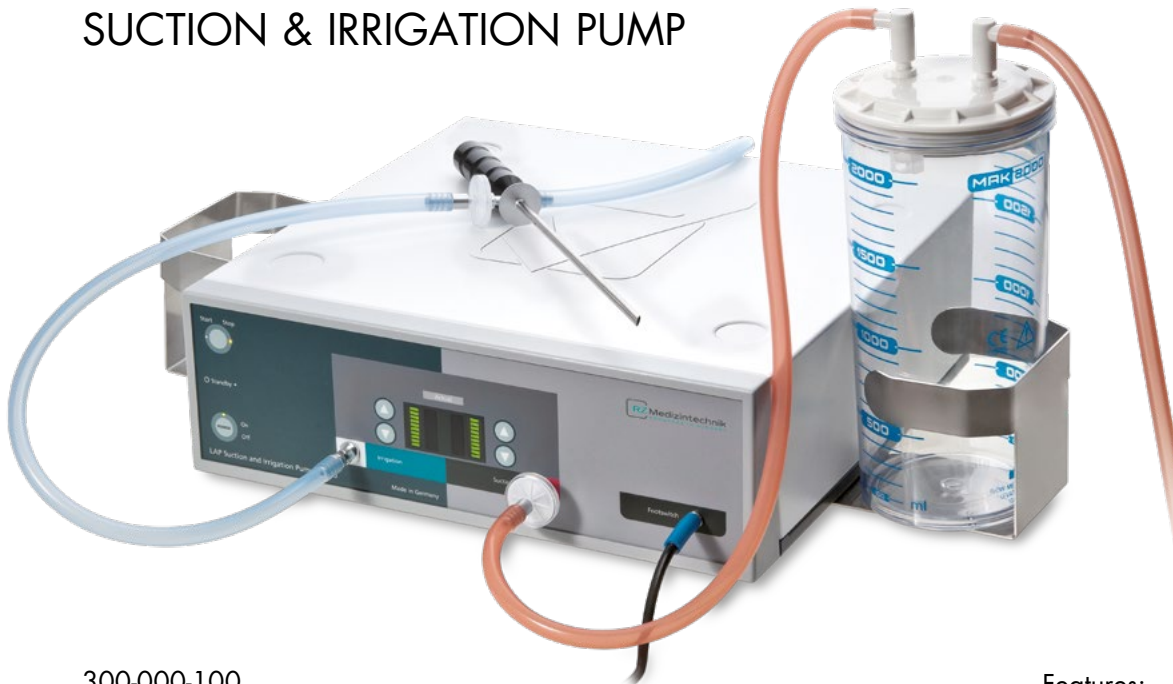

300-000-100  
LAP Suction and Irrigation Pump P1000, complete set

### Technical data

<b>Line voltage</b>	100-240 VAC
<b>Power input</b>	80VA
<b>Irrigation power</b>	3L/min
<b>Suction power</b>	3L/min
<b>Max. vacuum</b>	- 525mmHG
<b>Max. pressure</b>	0 - 750mmHG
<b>Measurements</b>	380 x 120 x 360mm (WxHxD) with Aspiration Bottle Retainers approx. 440 x 120 x 360mm
<b>Weight</b>	Device: approx. 11kg Aspiration Bottle-Retainer: (for 1 Liter = 0.34kg, for 2 Liter = 0.44kg)

### Features:

- Dual suction and irrigation vacuum pump
- Digital display of suction and irrigation pressures
- High rates up to 3L/min
- Color coded tubing sets
- Standby function
- Low noise level
- Hydrophobic disposable filters

### DELIVERY CONTAINS:

- Pump device (300-000-100)
- Suction and irrigation tubing set (300-000-102)
- Aspiration bottle 2L with overflow valve (300-000-101)
- Puncture tube 235mm (300-001-521)
- 2 Hydrophobic disposable sterile filters (300-000-103)
- 2 Bottle holders with screws
- Mains cable
- 2 Spare fuses
- Operating manual

### Accessories (optional available)



300-000-110  
Start/Stop - Footswitch

### 4K CAMERA SYSTEM



#### Features:

- 4K UHD resolution with 3-chip technology
- Image algorithm enhancement of color and structure
- 4K video recording
- 4K image saving
- Camera head with 4 programmable buttons
- Boost function
- Fog reduction
- Freeze function
- 2.5x digital zoom
- 10 USER mode configurations
- Multilingual on screen menu
- SDI 4K Output
- Text generator (optional with keyboard)

300-001-840 4K 3-Chip UHD-Camera K 4000

#### DELIVERY CONTAINS:

- Main Unit (300-001-840)
- Camera head (300-001-841)
- HDMI cable
- USB Pen Drive
- Mains cable
- Operating manual

# 4K

#### Technical data

Line voltage	100-240 VAC
Power consumption	60VA
Image sensor	3 MOS
Resolution	3840 x 2160 pixels (4K)
Index ratio	16:9
N/N ratio	54db

Video outputs	1x HDMI 4K 1x HDMI FullHD 1x SDI 4K 1x SDI FullHD
Dimensions	Control unit: 355 x 103 x 350mm (WxHxD) Weight control unit: 6.2kg Weight camera head: 145g

#### Accessories



300-001-841  
UHD 3-Chip Camera Head  
(included in the set)



300-001-615  
Title generator keyboard, waterproof IP68  
US-Layout, cable 1.8m, color: grey,  
305x140x15mm, 600gr.



300-001-610  
Footswitch for HD Cameras  
cable length: 2m

### FULL HD CAMERA SYSTEM



300-001-800 3 Chip HD-Camera F3  
 300-001-804 3 Chip HD-Camera F4 (with recording function)

# FULL HD

#### Technical data

Line voltage	100-240 VAC
Power input	20W
Image sensor	3 MOS
Resolution	1920 x 1080 pixels (FullHD)
Image resolution	>1000 TV lines, horizontal
Index ratio	16:9
Min. sensitivity	< 3lx (1/1.4)
Shutter speed	1/50 (1/60) to 1/100.000sec

<b>Video outputs (F4)</b>	2 x HD SDI 1x HDMI / DVI 2x CVBS 1 x YPbPr / RGB 1 x Y/C (Pal/NTSC) 1x CVBS (Pal/NTSC)
<b>Video outputs (F3)</b>	1 x HDMI / DVI 1 x YPbPr (Component) 1 x Y/C (Pal/NTSC) 1x CVBS (Pal/NTSC)
<b>Dimensions</b>	Control unit: 380 x 120 x 360mm (WxHxD) Weight control unit: 11kg Weight camera head: 145g

#### Features:

- Full HD camera with 3-chip MOS technology
- Pure Natural Colors technology
- Full HD video recording (F4 only)
- Full HD image saving (F4 only)
- Camera head with 3 programmable buttons
- Boost function
- Freeze function
- 2.5x digital zoom
- 3 USER mode configurations
- Multilingual on screen menu
- Different digital video outputs
- Text generator (optional with keyboard)

#### DELIVERY CONTAINS:

- Main Unit
- Camera head
- 2x BNC cable
- HDMI - DVI cable
- HDMI cable
- S-Video cable (F3 only)
- USB Pen Drive (F4 only)
- Mains cable
- Operating manual

#### Accessories



300-001-802  
 High-End 3-MOS Camera Head  
 FullHD (included in the set)



300-001-615  
 Title generator keyboard, waterproof IP68  
 US-Layout, cable 1.8m, color: grey,  
 305x140x15mm, 600gr.



300-001-610  
 Footswitch for HD Cameras  
 cable length: 2m

### FULL HD CAMERA SYSTEM



#### Features:

- Full HD camera with 1-chip MOS technology
- Natural color technology
- Full HD video recording (F2 Pro only)
- Full HD image saving (F2 Pro only)
- Camera head with 3 programmable buttons
- Boost function
- Freeze function
- 2.5x digital zoom
- 3 USER mode configurations
- Multilingual on screen menu
- HDMI video outputs
- Text generator (optional with keyboard)

- 300-001-600 HD-Camera F1
- 300-001-601 HD-Camera F2 Pro (with recording function)

#### DELIVERY CONTAINS:

- Main Unit
- Camera head
- 2x BNC cable
- HDMI - DVI cable
- HDMI cable
- S-Video cable
- USB Pen Drive (F2 Pro only)
- Operating manual
- Mains cable

# FULL HD

#### Technical data

Line voltage	100-240 VAC
Power input	F2 Pro: 30W / F1: 20W
Image sensor	1/3" MOS
Resolution	1920 x 1080 pixels (FullHD)
Image resolution	>1000 TV lines, horizontal
Index ratio	16:9
Min. sensitivity	< 3lx (1/1.4)

<b>Video outputs (F2 Pro)</b>	2 x HD SDI (optional) 1 x HDMI / DVI 1 x Y-Pb-Pr (Component) 1 x Video (PAL/NTSC) 1 x S-Video (PAL/NTSC)
<b>Video outputs (F1)</b>	1 x HDMI 1 x YPbPr / RGB 1 x S-Video (Y/C; Pal / NTSC) 1 x Video (CVBS; Pal / NTSC)
<b>Dimensions</b>	Control unit: 380 x 120 x 360mm (WxHxD) Weight control unit: 11kg Weight camera head: 105g

#### Accessories



300-001-602  
High-End 1/3" MOS Camera Head  
Full HD (included in the set)



300-001-615  
Title generator keyboard, waterproof IP68  
US-Layout, cable 1.8m, color: grey,  
305x140x15mm, 600gr.



300-001-610  
Footswitch for HD Cameras  
cable length: 2m

## TV COUPLER



**4K**  
**FULL HD**

300-001-823 f=14mm  
 300-001-824 f=25mm  
 300-001-825 f=28mm  
 c-mount, soakable



**4K**  
**FULL HD**

250-015-030  
 Zoom-TV-Adapter  
 f=15 - 30mm  
 c-mount, soakable



**4K**  
**FULL HD**

250-015-036  
 Zoom-TV-Adapter  
 f=15 - 36mm  
 c-mount, soakable



**FULL HD**

300-001-813 f=14mm  
 300-001-814 f=25mm  
 c-mount, soakable



**FULL HD**

250-020-025 F=25mm (splitting 90/10)  
 250-020-030 F=30mm (splitting 90/10)  
 Beamsplitter, allows simultaneous video  
 and direct views, c-mount, soakable

## RZ MEDIA WORKSTATION Innovative Documentation System – the stand alone “all in one” solution

Sophisticated users get a comprehensive tool for creating, documenting and archiving of videos, pictures and findings.

An extensive set of tools gives the ability for easy creation of individual and complex findings reports. Easy integration into IT-environment ensures an optimal workflow. The database provides long-term availability of picture findings with almost no capacity limitation.

### Diagnostics & Results

- Recording of videos and pictures
- PACS support DICOM worklist/store
- Playing videos with abstraction of individual images
- Manual input of comments and markers for sessions and recordings
- Graphical markers with individual comments
- Creation of reports incl. patient information, pictures, videos and comments
- Full-text search in data base
- User management including import, adaption and export of patients
- LIVE OR communication via e.g. Zoom, Skype or Teams
- Hospital Safety guidelines  
(Windows based network and firewall)



Documentation System 21" touch

300-001-199 OR version with DICOM worklist

300-001-198 without DICOM worklist



## LED LIGHT SOURCE



### Features:

- 6500K daylight color temperature
- 375 Watt equivalent output power
- > 20.000 hours lifetime
- Turret connector for the most common light cables (Olympus, Wolf, Gyrus ACMI, Storz)
- Manual or automatic light control
- Waterproof touch control panel
- Low heat conduction by improved LED technology
- Boost function: light increase of 20%

300-900-300 LUMEN LED 3 PRO Light Source, 110 - 230V



### Technical data

Line voltage	100-240 VAC
Video input	1x Video, BNC
Protection class	1 (acc. IEC 60601-1) 1 (acc. MDD 93/42/EEC)
Safety class	BF
Standard	IEC 60601-1-2
Dimensions	380 x 120 x 360mm (WxHxD)
Weight	approx. 11kg

### DELIVERY CONTAINS:

- Main Unit (300-900-300)
- BNC cable (optional)
- Mains cable
- Operating manual



A OLYMPUS

B WOLF

C GYRUS ACMI

D STORZ  
KARL STORZ ENDOSKOP

Turret, multi connector

## LED LIGHT SOURCE



## Features:

- More than 20.000h lamp lifetime
- 180 Watt equivalent power output
- Manual or automatic light control
- Waterproof touch control panel
- Low heat conduction by improved LED technology
- Daylight color temperature 6000 – 6500° K for accurate color representation
- Boost function: light increase of 20%

300-900-180 LUMEN LED 1 Light Source



## DELIVERY CONTAINS:

- Main Unit (300-900-180)
- BNC cable
- Mains cable
- Operating manual

## Technical data

Line voltage	100-240 VAC
Power consumption	130VA
Video input	1x Video, 1x S-Video (Y/C) (automatic version only)
Protection class	1 (acc. IEC 60601-1) 1 (acc. MDD 93/42/EEC)
Safety class	BF
Dimensions	380 x 120 x 360mm (WxHxD)
Weight	approx. 11kg



## HIGH TEMPERATURE LED/XENON LIGHT CABLES

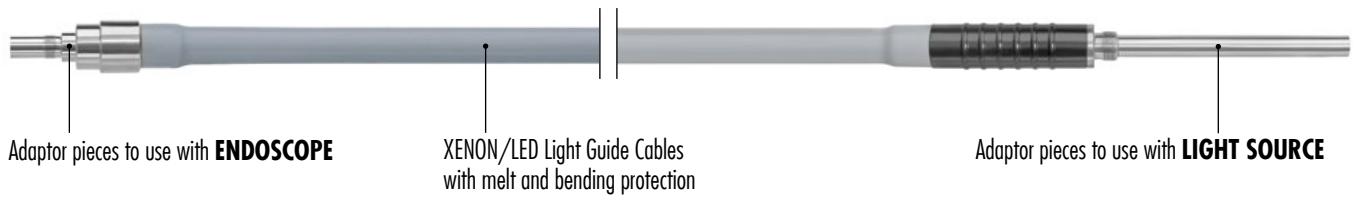

250-042-000  
250-042-400 for ICG/NRI  
RZ/Storz/Olympus



250-040-000  
Wolf



250-041-000  
ACMI/British Standard

250-025-230	Ø 2.5mm, 2300 mm
250-025-300	Ø 2.5mm, 3000 mm
250-035-180	Ø 3.5mm, 1800 mm
250-035-230	Ø 3.5mm, 2300 mm
250-035-300	Ø 3.5mm, 3000 mm
250-048-180	Ø 4.8mm, 1800 mm
250-048-230	Ø 4.8mm, 2300 mm
250-048-300	Ø 4.8mm, 3000 mm



250-039-000  
250-039-400 for ICG/NRI  
RZ/Storz



250-038-000  
ACMI/CUDA



250-048-000  
Luxtec



250-051-000  
Stryker



250-037-000  
250-037-400 for ICG/NRI  
Wolf



250-044-000  
Olympus



250-045-000  
Olympus - Standard



250-052-000  
Heine



250-059-000  
Pentax

## ICG/NIR LIGHT CABLE



250-048-234  
LED High Transmission Fibre Optic Light Guide Cable  
Ø 4.8mm, 2300mm, without adaptor

### COMPATIBILITY NOTE:

A fiber optic cable with a large diameter should not be connected to a smaller diameter scope.  
For example: Ø 4.8mm fiber optic cables connected to a Ø 2.9mm may risk high temperature at the light entry of the endoscope and may risk patient safety.

### ELECTROSURGICAL GENERATOR



#### Features:

- Monopolar/bipolar cutting and coagulation
- Automatic identification of connected instruments
- Powerstart System simplifies the beginning of cutting process
- Automatic power regulation
- 105 different memory locations in 7 groups
- Various output configuration of the sockets available
- 10" Touchscreen
- Tiltable display
- Footswitch (optional)
- Available with Argon and / or the RZeal
- Real-time output monitoring

#### DELIVERY CONTAINS:

- Main Unit
- Mains Cable
- (Footswitch not included)

700-350-400 230V  
 700-350-410 110V  
 G400 ElectroSurgical Generator

#### Technical data

Line voltage	110-230 VAC
Power consumption	500W
Generator operation frequency	333kHz
Display	TFT 10"
Defibrillation impulse resistance	acc. to EN 60601-1
NEM system	neutral electrode control optical indication 7 levels required resistance < 240 Ω
Gas type	pure argon 4.8 (99,998%) or higher
Inlet gas pressure	0.25-0.4 [MPa]
Monopolar coagulation / cutting	200W / 400W
Bipolar coagulation / cutting	400W / 400W

Gas outflow	0.1-10 l/min, regulated 0.1 l/min in whole range
Pressure range	reducer (0.4 MPa) on argon cylinder
Vessel sealing system	9 effects/300W
AutoStop	automatic stop of sealing process after achieving the optimal effect
Dimensions	495 x 415 x 225mm (LxWxH)
Weight	12.2kg

#### Accessories



700-350-405  
 2-Button-Footswitch, length: 5m  
 700-350-402  
 3-Button-Footswitch, length: 5m, quick access key



Disposable Neutral Electrode  
 hydrogel, split, for adults or children  
 10x5 pcs. per package  
 700-503-000 Adults  
 700-503-001 Children



Cable for Disposable Neutral Electrode  
 5m, RZ compatible only  
 700-503-003

## ELECTROSURGICAL GENERATOR



700-340-400 230V  
 700-340-410 110V  
 G44 Electrosurgical Generator

### Technical data

Line voltage	110-240 VAC
Power consumption	1100VA
Generator operation frequency	333kHz
Display	TFT 7" WVGA
Spectrum result system	automatic power regulation
Monopolar coagulation	max. 200W (200Ω)
Monopolar cutting	max. 400W (100Ω)
Bipolar coagulation	max. 400W (25Ω)
Bipolar cutting	max. 330W (150Ω)

### Features:

- Monopolar/bipolar cutting and coagulation
- Automatic instrument detection system
- Intuitive Touchscreen
- Automatic power regulation
- Configurable working modes
- Real-time parameter control
- Special endoscopic modes
- Bipolar resection
- Easy software update

### DELIVERY CONTAINS:

- Main Unit
  - Mains Cable
- (Footswitch not included)

NEM system	neutral electrode control, optical indication, required resistance < 240 Ω
Dimensions	385 x 305 x 141mm (LxWxH)
Weight	7kg

### Accessories



700-350-405  
 2-Button-Footswitch, length: 5m

700-350-402  
 3-Button-Footswitch, length: 5m, quick access key



Disposable Neutral Electrode hydrogel, split, for adults or children  
 10x5 pcs. per package  
 700-503-000 Adults  
 700-503-001 Children



Cable for Disposable Neutral Electrode  
 5m, RZ compatible only  
 700-503-003



300-001-168  
Endovue 32" HD Monitor

300-001-158  
Endovue 24" HD Monitor

### Technical data

Screen size	31.5" / 24" diagonal
Resolution	1920 x 1080
Aspect ratio	16:9
Viewing angle	178°
Numbers of colors	16.7 Million (8-bit)
Video Inputs	DVI-D, RGBS/VGA/YPbPr (HD-15 or DVI-I via adapter), S-Video, Composite
Video Outputs	DVI-D
Weight	8.8kg (300-001-168) 6.7kg (300-001-158)



300-001-232  
Radiance 32" HD Monitor

300-010-226  
Radiance 27" HD Monitor

### Technical data

Screen size	32" / 27" diagonal
Resolution	1920 x 1080
Aspect ratio	16:9
Viewing angle	178°
Numbers of colors	1.07 Billion (10-bit)
Video Inputs	DVI-I and 3G-SDI Input/Output
Video Outputs	DVI-D
Weight	11.0kg (300-001-232) 8.9kg (300-010-226)



300-001-031  
UHD 4K Monitor, 31"

### Technical data

Screen size	31" diagonal
Resolution	4096 x 2160
Aspect ratio	17:9
Viewing angle	178°
Number of colors	1.08 Billion (10-bit)
Video Inputs	1 x HDMI 2.0 1 x DP 1.2 (SST) & 1 x DP 1.2 (MST) 1 x DVI (single link), 4 x SDI (3G)
Video Outputs	1 x DP 1.2 (SST) 1 x DVI (single link), 4 x SDI (3G)
Weight	10.5kg



300-001-055  
UHD 4K Monitor, 55"

### Technical data

Screen size	55" diagonal
Resolution	3840 x 2160
Aspect ratio	16:9
Viewing angle	178°
Numbers of colors	1.08 Billion (10-bit)
Video Inputs	1 x HDMI 2.0, 2 x DP 1.2 (55T) 1 x DVI (single link), 2 x DVI (dual link) 4 x SOi (3G), 2 x SOi (12G)
Video Outputs	1 x DVI (single link), 1 x DP 1.2 (SST) 4 x SDI (3G), 2x SDI (12G)
Weight	37.35kg



300-001-028  
Monitor Table Stand

### Technical data

Column height	305mm, 12"
Oriantations	Landscape or page mode
Adjustments	+/- 20°
Max. load	31" / 13.6kg / 30lbs

All monitors will be delivered without table stand - need to be ordered separately.

## RZ TROLLEY

- Optional doors and rear panel in order to protect valuable equipment
- Optional main on/off switch
- Power columns for cables
- Endoscope Holder
- Variable height support arms
- Conductive rolls

DIMENSIONS  
1600 x 500 x 625mm  
Rollers: Ø 125mm

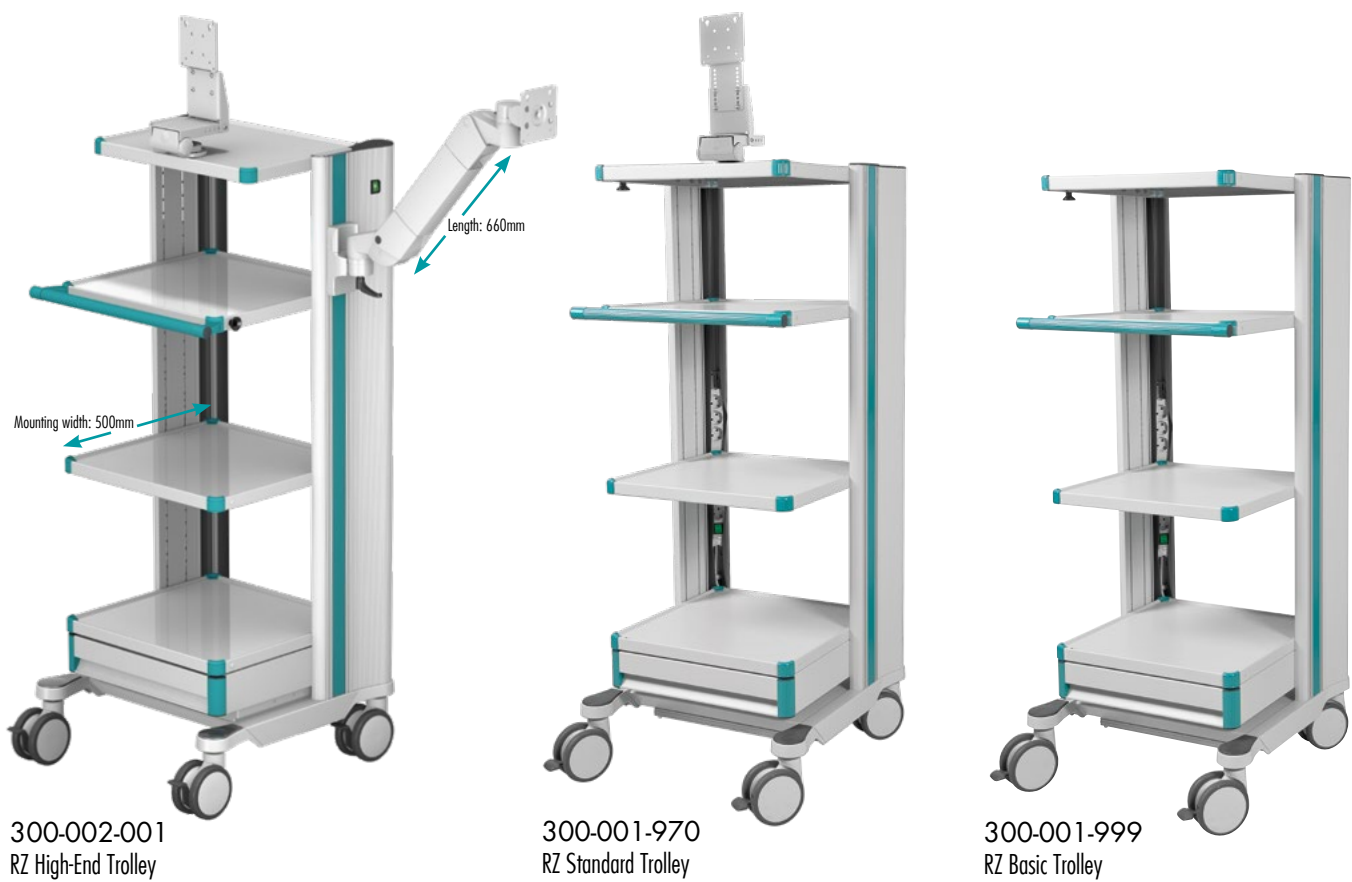



300-001-988  
Hydraulic monitor holding, 660mm

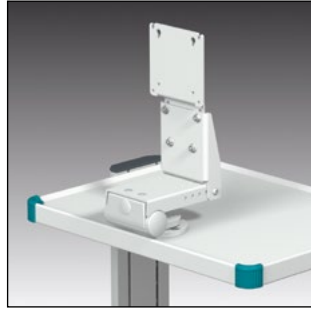

300-001-989  
Monitor Shelf with adjustable monitor holding VESA 75/100 up to 14kg



300-001-986  
Keyboard Holder



300-001-990  
Camera Head Holder with cable suspension



300-001-980 3/5/10 L  
300-001-982 20/50 L  
CO<sub>2</sub> Bottle Holder

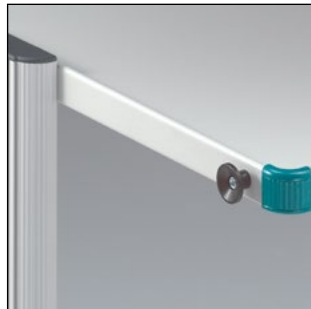

300-001-979  
Camera Holder



300-001-978  
Cable Holder

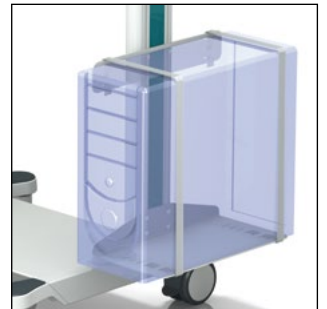

300-001-991  
Computer Holder, load capacity max. 20kg



300-001-983  
Rear Panel



300-001-985  
Additional Shelf

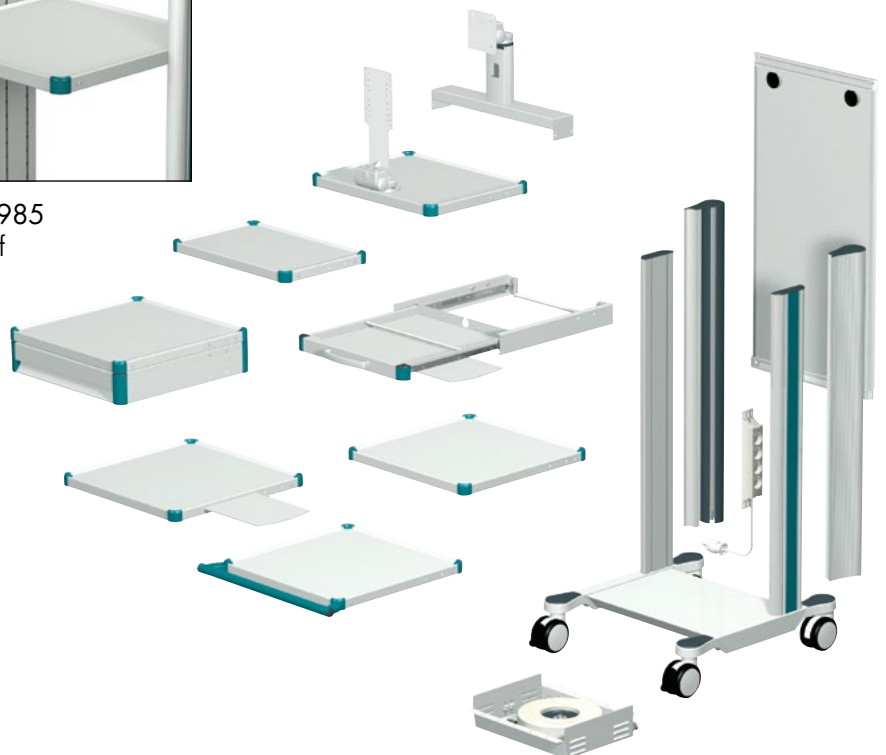

110-110-003	7	250-048-230	6, 177	300-001-979	183
120-511-145	7	250-048-234	177	300-001-980	183
120-611-180	8	250-048-300	177	300-001-982	183
130-140-120	7	250-051-000	177	300-001-983	183
140-254-125	8	250-052-000	177	300-001-985	183
140-573-130	8	250-059-000	177	300-001-986	183
150-050-180	8	300-000-095	155	300-001-988	183
170-801-500	10	300-000-100	169	300-001-989	183
170-801-501	10	300-000-101	169	300-001-990	183
170-801-502	10	300-000-102	169	300-001-991	183
170-801-503	10, 12	300-000-103	169	300-001-999	182
170-801-504	12	300-000-110	169	300-002-001	182
170-801-505	12	300-000-300	168	300-006-305	37
170-801-506	10, 12	300-000-301	168	300-006-455	37
170-801-507	10, 12	300-000-302	168	300-010-226	180
170-801-508	12	300-000-303	168	300-012-106	29
170-801-510	10, 11	300-000-304	168	300-012-116	29
170-801-511	10, 11	300-000-305	168	300-012-121	29
170-801-512	10, 11	300-000-306	168	300-012-405	4, 29, 114
170-801-515	10, 11	300-000-307	168	300-012-410	29
170-802-520	11	300-001-028	181	300-012-412	29
170-802-521	11	300-001-031	181	300-012-415	29
170-802-522	11	300-001-055	181	300-012-416	29
180-550-160	8	300-001-158	180	300-012-420	29
250-015-030	173	300-001-168	180	300-012-421	29
250-015-036	173	300-001-198	174	300-012-425	29
250-020-025	173	300-001-199	174	300-012-455	4, 29
250-020-030	173	300-001-232	180	300-013-115	30
250-025-230	177	300-001-521	169	300-013-510	30
250-025-300	177	300-001-600	172	300-013-511	30
250-035-180	177	300-001-601	172	300-013-512	30
250-035-230	177	300-001-602	172	300-013-522	30
250-035-300	177	300-001-610	170, 171, 172	300-014-111	30
250-037-000	177	300-001-615	170, 171, 172	300-014-113	30
250-037-400	177	300-001-800	171	300-014-155	30
250-038-000	177	300-001-802	171	300-014-711	30
250-039-000	7, 177	300-001-804	171	300-019-500	34
250-039-400	177	300-001-813	173	300-019-501	34, 129, 140
250-040-000	177	300-001-814	173	300-019-600	34
250-041-000	177	300-001-823	173	300-019-601	34, 129, 140
250-042-000	177	300-001-824	173	300-019-700	140
250-042-400	177	300-001-825	173	300-019-705	34
250-044-000	177	300-001-840	170	300-019-710	34
250-045-000	177	300-001-841	170	300-019-735	34, 140
250-048-000	177	300-001-970	182	300-019-770	34, 140
250-048-180	177	300-001-978	183	300-019-780	34, 140



300-019-805	129	300-042-010	86	300-100-127	88
300-019-810	129	300-063-000	83	300-100-131	41
300-020-015	24	300-065-000	83	300-100-132	41
300-020-020	24	300-065-100	83	300-100-133	41
300-020-115	28	300-069-000	5, 84	300-100-134	41
300-020-120	28	300-069-450	84	300-100-400	14
300-020-211	31	300-070-000	84	300-100-430	14
300-020-215	28	300-070-450	84	300-100-687	107
300-020-220	28	300-071-000	85	300-100-688	107
300-020-255	31	300-071-450	85	300-100-689	107
300-020-711	31	300-072-000	84	300-100-691	107
300-020-755	31	300-072-450	84	300-100-692	107
300-020-915	28	300-073-000	84	300-100-693	107
300-020-920	28	300-073-450	84	300-100-694	107
300-021-011	4, 29	300-075-001	84	300-100-695	107
300-021-111	31	300-075-002	84	300-100-696	107
300-021-125	29	300-075-101	84	300-100-697	107, 130
300-021-155	31	300-075-102	84	300-100-698	107, 130
300-021-305	29	300-076-001	85	300-100-699	107
300-021-310	29	300-076-101	85	300-100-702	107
300-021-355	29	300-077-000	85	300-100-703	107
300-021-380	29	300-091-100	6, 15	300-100-760	82
300-021-405	29	300-091-130	15	300-100-771	96, 98
300-021-410	29	300-091-145	15	300-100-772	96, 98, 130
300-021-455	29	300-091-430	15	300-100-773	96, 98
300-021-755	31	300-091-433	15	300-100-774	96, 98
300-023-100	32	300-091-445	15	300-100-776	96
300-023-111	31	300-092-100	16	300-100-777	96
300-023-255	31	300-092-130	6, 16	300-100-778	96
300-023-711	31	300-092-145	16	300-100-779	96
300-023-755	31	300-096-450	16	300-100-786	96, 130
300-024-111	31	300-096-453	16	300-100-789	96, 130
300-024-155	31	300-096-455	16	300-100-798	97
300-024-711	31	300-097-100	16	300-100-799	97
300-024-755	31	300-097-130	16	300-101-588	110
300-025-358	28	300-098-105	32	300-101-589	110
300-025-359	28	300-099-006	17, 88	300-101-592	110
300-030-000	114	300-099-033	83	300-101-593	111
300-030-001	7, 114	300-099-100	83	300-101-594	110
300-030-003	114	300-099-106	17, 88	300-101-596	110
300-030-004	114	300-099-133	83	300-101-599	110
300-030-006	114	300-099-140	83	300-101-775	95, 99
300-032-015	86	300-099-500	17	300-101-777	97
300-033-010	86	300-100-120	88	300-110-711	87
300-042-000	7	300-100-122	88	300-110-714	87
300-042-005	86	300-100-125	88	300-110-715	87

300-111-013	57	300-163-660	43	300-195-080	32, 166
300-111-033	57	300-163-670	43	300-195-100	32, 166
300-111-775	95, 130	300-163-810	40	300-195-120	4, 32, 166
300-112-035	24, 138	300-163-820	40	300-195-150	32, 166
300-135-905	164	300-163-830	40	300-195-170	32, 166
300-135-910	164	300-163-850	40	300-195-200	32, 166
300-144-002	6, 42	300-163-860	40	300-195-300	32, 166
300-144-004	42	300-163-870	40	300-195-320	32, 166
300-144-005	6, 42	300-165-100	35, 141	300-195-350	32, 166
300-144-006	42	300-166-000	38	300-195-370	32, 166
300-145-003	42	300-166-100	7, 35, 141	300-200-131	150
300-145-004	42	300-167-100	35	300-200-132	150
300-145-005	42	300-172-003	35, 141	300-200-133	150
300-145-006	42	300-172-005	35	300-200-134	150
300-151-000	7, 113	300-172-010	35	300-200-137	150
300-151-100	113	300-172-253	141	300-200-231	150
300-152-000	113	300-173-003	35, 141	300-200-232	150
300-152-011	27	300-173-005	7, 35	300-200-233	150
300-152-012	27	300-173-010	7, 35	300-200-234	150
300-152-055	27, 139	300-173-253	141	300-200-237	150
300-153-000	113	300-192-000	36, 142	300-200-400	14
300-154-011	27	300-192-003	36, 142	300-200-430	14
300-154-055	27	300-192-005	36	300-215-000	164
300-154-125	27	300-192-010	36	300-220-011	22
300-155-400	14	300-192-253	142	300-220-013	22
300-155-430	14	300-193-003	36, 142	300-220-055	22, 138
300-163-100	39	300-193-005	36	300-220-111	128
300-163-110	39	300-193-010	36	300-220-113	128
300-163-120	39	300-193-253	142	300-220-155	128
300-163-130	39	300-193-303	142	300-220-211	25
300-163-140	39	300-193-305	37	300-220-213	25
300-163-150	39	300-193-330	82	300-220-255	25
300-163-160	39	300-193-335	7, 37	300-221-011	22
300-163-170	39	300-193-353	142	300-221-013	22
300-163-180	39	300-193-405	37	300-221-055	22, 138
300-163-190	39	300-193-410	37	300-221-211	25
300-163-410	43	300-194-303	142	300-221-213	25
300-163-420	43	300-194-307	37	300-221-255	25
300-163-430	43	300-194-309	37	300-222-011	4, 22
300-163-450	43	300-194-312	37	300-222-013	4, 22
300-163-460	43	300-194-314	7, 37	300-222-055	4, 22, 138
300-163-470	43	300-194-318	37	300-222-211	25
300-163-610	43	300-194-353	142	300-222-213	25
300-163-620	43	300-194-412	37	300-222-255	25
300-163-630	43	300-194-414	37	300-223-011	22
300-163-650	43	300-194-418	37	300-223-013	22

300-223-055	22, 138	300-241-011	4, 26	300-300-160	105
300-224-011	22	300-241-013	4, 26	300-300-161	105
300-224-013	22	300-241-015	26	300-300-170	105
300-224-055	22, 138	300-241-020	26	300-300-171	105
300-226-011	22	300-241-035	26, 139	300-300-172	105
300-226-013	22	300-241-055	4, 26, 139	300-300-200	109
300-226-055	22	300-241-111	129	300-300-201	109
300-230-011	23	300-241-113	129	300-300-230	105
300-230-013	23	300-241-155	129	300-300-231	105
300-230-055	23, 138	300-242-011	26	300-300-240	105
300-230-111	128	300-242-035	26, 139	300-300-241	105
300-230-113	128	300-242-055	26, 139	300-300-242	105
300-230-155	128	300-243-011	27	300-300-260	105
300-231-011	23	300-243-013	27	300-300-261	105
300-231-013	23	300-243-055	27	300-300-270	105
300-231-055	23, 138	300-244-011	27	300-300-271	105
300-232-011	23	300-244-013	27	300-300-272	105
300-232-013	23	300-244-055	27	300-300-330	105, 143
300-232-055	23, 138	300-244-111	129	300-300-340	105, 143
300-233-011	23	300-244-113	129	300-300-341	105, 143
300-233-013	23	300-244-155	129	300-300-360	105, 143
300-233-055	23, 138	300-250-011	28, 31	300-300-370	105, 143
300-233-211	25	300-250-013	28	300-300-371	105, 143
300-233-213	25	300-250-035	28, 139	300-300-430	105, 143
300-233-255	25	300-250-055	28, 31, 139	300-300-440	105, 143
300-234-011	23	300-250-111	28	300-300-441	105, 143
300-234-013	23	300-250-135	28, 139	300-300-460	105, 143
300-234-055	23, 138	300-250-155	139	300-300-470	105, 143
300-234-211	25	300-250-211	28	300-300-471	105, 143
300-234-213	25	300-250-213	28	300-300-500	109
300-234-255	25	300-250-235	28, 139	300-300-501	109
300-236-011	23	300-250-255	28, 139	300-302-000	109
300-236-013	23	300-255-400	14	300-302-001	109
300-236-055	23	300-255-430	14	300-302-100	109
300-236-211	25	300-257-002	150	300-302-101	109
300-236-213	25	300-257-004	150	300-302-200	109
300-236-255	25	300-257-015	150	300-302-201	109
300-240-011	26	300-300-000	109	300-302-501	109
300-240-013	26	300-300-001	109	300-303-000	109
300-240-015	26	300-300-100	109	300-303-001	109
300-240-020	26	300-300-101	109	300-303-100	109
300-240-035	26, 139	300-300-130	105	300-303-101	109
300-240-055	26, 139	300-300-131	105	300-303-200	109
300-240-111	129	300-300-140	4, 105	300-303-201	109
300-240-113	129	300-300-141	4, 105	300-303-500	109
300-240-155	129	300-300-142	105	300-303-501	109

300-330-033	112	300-400-063	78	300-400-264	69
300-330-045	112, 130	300-400-065	77	300-400-266	69
300-332-033	112	300-400-067	48, 74	300-400-280	66
300-332-320	110	300-400-068	75	300-400-284	63
300-334-033	112	300-400-069	74	300-400-285	62
300-400-000	56	300-400-070	75	300-400-286	70
300-400-001	56	300-400-071	75	300-400-287	62
300-400-002	56	300-400-072	75	300-400-288	62
300-400-003	54	300-400-074	67	300-400-289	62
300-400-004	58	300-400-076	70	300-400-291	62
300-400-005	55	300-400-078	65	300-400-295	70
300-400-006	58	300-400-079	65	300-400-310	63
300-400-008	56	300-400-080	64	300-400-311	63
300-400-009	58	300-400-082	64	300-400-312	63
300-400-010	60	300-400-084	66	300-400-313	63
300-400-011	59	300-400-085	67	300-400-314	63
300-400-012	55	300-400-086	64	300-400-330	115
300-400-013	57	300-400-097	67	300-400-521	64
300-400-014	58	300-400-100	64	300-400-570	79
300-400-015	55	300-400-109	53	300-400-571	79
300-400-016	54	300-400-165	77	300-400-572	79
300-400-017	56	300-400-168	74	300-400-610	54
300-400-018	60	300-400-169	75	300-400-700	71
300-400-021	55	300-400-170	76	300-400-710	59
300-400-023	53	300-400-171	76	300-400-713	59
300-400-024	61	300-400-172	74	300-400-715	59
300-400-025	54	300-400-173	77	300-400-717	59
300-400-026	61	300-400-180	76	300-400-720	71
300-400-027	51	300-400-181	76	300-400-730	52
300-400-029	56	300-400-197	67	300-400-731	50
300-400-030	70	300-400-200	72	300-400-732	50
300-400-032	61	300-400-201	58	300-400-733	50
300-400-033	57	300-400-202	72	300-400-734	52
300-400-040	54	300-400-204	73	300-400-735	51
300-400-042	61	300-400-206	72	300-400-736	51
300-400-044	53	300-400-220	73	300-400-737	52
300-400-045	61	300-400-221	73	300-400-738	50
300-400-046	61	300-400-234	66	300-400-739	52
300-400-048	60	300-400-243	68	300-400-740	51
300-400-049	60	300-400-244	68	300-400-741	51
300-400-051	60	300-400-245	68	300-400-751	71
300-400-052	63	300-400-246	68	300-400-753	71
300-400-053	57	300-400-250	65	300-400-775	95
300-400-056	77	300-400-251	53	300-400-781	71
300-400-060	78	300-400-252	65	300-400-900	47
300-400-062	78	300-400-263	69	300-400-901	47

300-401-001	132	300-405-142	101	300-410-181	76
300-401-013	132	300-405-330	103	300-410-251	53
300-401-015	132	300-405-340	103	300-410-521	64
300-401-017	132	300-405-341	103	300-410-570	79
300-401-025	131	300-406-130	101	300-410-571	79
300-401-067	135	300-406-131	101	300-410-572	79
300-401-070	135	300-406-140	101	300-410-730	52
300-401-078	134	300-406-141	101	300-410-731	50
300-401-079	134	300-406-142	101	300-410-732	50
300-401-082	134	300-410-003	54	300-410-733	50
300-401-085	135	300-410-016	54	300-410-734	52
300-401-201	133	300-410-023	53	300-410-735	51
300-401-289	133	300-410-024	61	300-410-736	51
300-401-291	133	300-410-025	54	300-410-737	52
300-401-710	133	300-410-026	61	300-410-738	50
300-401-713	59	300-410-027	51	300-410-739	52
300-401-730	131	300-410-032	61	300-410-740	51
300-401-732	131	300-410-040	54	300-410-741	51
300-401-738	131	300-410-042	61	300-410-775	95, 99
300-401-739	131	300-410-044	53	300-411-025	131
300-401-775	95	300-410-045	61	300-411-067	135
300-403-015	147	300-410-046	61	300-411-070	135
300-403-060	147	300-410-056	77	300-411-082	134
300-403-069	147	300-410-060	78	300-411-730	131
300-403-082	147	300-410-062	78	300-411-732	131
300-403-244	147	300-410-063	78	300-411-738	131
300-403-284	147	300-410-064	77	300-411-739	131
300-403-289	147	300-410-067	48, 74	300-411-775	95
300-403-732	147	300-410-068	75	300-420-003	54
300-403-738	147	300-410-069	74	300-420-016	54
300-404-015	147	300-410-070	75	300-420-023	53
300-404-060	147	300-410-071	75	300-420-024	61
300-404-069	147	300-410-072	75	300-420-025	54
300-404-082	147	300-410-080	64	300-420-026	61
300-404-244	147	300-410-082	64	300-420-027	51
300-404-284	147	300-410-086	64	300-420-032	61
300-404-289	147	300-410-100	64	300-420-040	54
300-404-330	103	300-410-109	53	300-420-042	61
300-404-340	103	300-410-165	77	300-420-044	53
300-404-341	103	300-410-168	74	300-420-045	61
300-404-732	147	300-410-169	75	300-420-046	61
300-404-738	147	300-410-170	76	300-420-056	77
300-405-130	101	300-410-171	76	300-420-060	5, 78
300-405-131	101	300-410-172	74	300-420-062	78
300-405-140	101	300-410-173	77	300-420-063	78
300-405-141	101	300-410-180	76	300-420-064	77

300-420-065	164	300-430-001	56	300-430-285	62
300-420-067	5, 48, 74	300-430-002	56	300-430-286	70
300-420-068	75	300-430-004	58	300-430-287	62
300-420-069	74	300-430-005	55	300-430-288	62
300-420-070	75	300-430-006	58	300-430-289	62
300-420-071	75	300-430-008	56	300-430-291	62
300-420-072	75	300-430-009	58	300-430-295	70
300-420-080	64	300-430-010	60	300-430-310	63
300-420-082	64	300-430-011	59	300-430-311	63
300-420-086	64	300-430-012	55	300-430-312	63
300-420-100	64	300-430-013	57	300-430-313	63
300-420-109	53	300-430-014	58	300-430-314	63
300-420-165	77	300-430-015	55	300-430-610	54
300-420-168	74	300-430-017	56	300-430-700	71
300-420-169	75	300-430-018	60	300-430-710	59
300-420-170	76	300-430-021	55	300-430-713	59
300-420-171	76	300-430-025	54	300-430-715	59
300-420-172	74	300-430-029	56	300-430-717	59
300-420-173	77	300-430-030	70	300-430-720	71
300-420-180	76	300-430-033	57	300-430-751	71
300-420-181	76	300-430-048	60	300-430-753	71
300-420-251	53	300-430-049	60	300-430-781	71
300-420-521	64	300-430-051	60	300-431-001	132
300-420-570	79	300-430-052	63	300-431-013	132
300-420-571	79	300-430-053	57	300-431-015	132
300-420-572	79	300-430-074	67	300-431-017	132
300-420-730	52	300-430-076	70	300-431-070	135
300-420-731	50	300-430-078	65	300-431-078	134
300-420-732	5, 50	300-430-079	65	300-431-079	134
300-420-733	50	300-430-084	66	300-431-085	135
300-420-734	52	300-430-085	67	300-431-201	133
300-420-735	5, 51	300-430-097	67	300-431-289	133
300-420-736	51	300-430-197	67	300-431-291	133
300-420-737	52	300-430-201	58	300-431-710	133
300-420-738	50	300-430-234	66	300-431-713	59
300-420-739	52	300-430-243	68	300-440-000	56
300-420-740	51	300-430-244	68	300-440-001	56
300-420-741	51	300-430-245	68	300-440-002	56
300-421-025	131	300-430-246	68	300-440-004	58
300-421-067	135	300-430-250	65	300-440-005	55
300-421-082	134	300-430-252	65	300-440-006	58
300-421-730	131	300-430-263	69	300-440-008	56
300-421-732	131	300-430-264	69	300-440-009	58
300-421-738	131	300-430-266	69	300-440-010	60
300-421-739	131	300-430-280	66	300-440-011	59
300-430-000	56	300-430-284	63	300-440-012	55

300-440-013	57	300-440-313	63	300-460-017	5, 56
300-440-014	58	300-440-314	63	300-460-018	60
300-440-015	55	300-440-610	54	300-460-029	56
300-440-017	56	300-440-700	71	300-460-030	70
300-440-018	60	300-440-710	59	300-460-033	57
300-440-021	55	300-440-713	59	300-460-048	60
300-440-025	54	300-440-715	59	300-460-049	60
300-440-029	56	300-440-717	59	300-460-051	60
300-440-030	70	300-440-720	71	300-460-053	57
300-440-033	57	300-440-751	71	300-460-076	70
300-440-048	60	300-440-753	71	300-460-201	58
300-440-049	60	300-440-781	71	300-460-243	68
300-440-051	60	300-441-001	132	300-460-244	68
300-440-052	63	300-441-013	132	300-460-245	68
300-440-053	57	300-441-015	132	300-460-246	68
300-440-074	67	300-441-017	132	300-460-263	69
300-440-076	70	300-441-078	134	300-460-264	69
300-440-078	65	300-441-079	134	300-460-266	69
300-440-079	65	300-441-085	135	300-460-286	70
300-440-084	66	300-441-201	133	300-460-295	70
300-440-085	67	300-441-289	133	300-460-700	71
300-440-097	67	300-441-291	133	300-460-710	59
300-440-197	67	300-441-710	133	300-460-713	59
300-440-201	58	300-441-713	59	300-460-715	59
300-440-234	66	300-450-005	80	300-460-717	59
300-440-243	68	300-450-006	80	300-460-720	71
300-440-244	68	300-450-049	81	300-460-751	71
300-440-245	68	300-450-171	81	300-460-753	71
300-440-246	68	300-450-173	81	300-460-781	71
300-440-250	65	300-450-174	81	300-461-713	59
300-440-252	65	300-450-176	81	300-470-052	63
300-440-263	69	300-450-177	81	300-470-074	67
300-440-264	69	300-450-289	81	300-470-078	65
300-440-266	69	300-450-300	80	300-470-079	65
300-440-280	66	300-450-731	81	300-470-084	66
300-440-284	63	300-460-000	56	300-470-085	67
300-440-285	62	300-460-001	5, 56	300-470-097	67
300-440-286	70	300-460-002	56	300-470-197	67
300-440-287	62	300-460-004	58	300-470-234	66
300-440-288	62	300-460-006	58	300-470-250	65
300-440-289	62	300-460-008	56	300-470-252	65
300-440-291	62	300-460-009	58	300-470-280	66
300-440-295	70	300-460-010	60	300-470-284	63
300-440-310	63	300-460-011	5, 59	300-470-285	62
300-440-311	63	300-460-013	57	300-470-287	62
300-440-312	63	300-460-014	58	300-470-288	62

300-470-289	5, 62	300-480-640	101	300-550-010	47
300-470-291	62	300-480-641	101	300-550-035	146
300-470-310	63	300-480-642	101	300-550-105	47
300-470-311	63	300-480-730	101	300-550-110	47
300-470-312	63	300-480-731	101	300-560-535	118
300-470-313	63	300-480-740	101	300-560-546	118
300-470-314	63	300-480-741	101	300-601-731	140
300-480-000	102	300-480-742	101	300-660-005	47, 115
300-480-001	102	300-490-200	72	300-660-010	47
300-480-002	102	300-490-202	72	300-660-015	76
300-480-033	102	300-490-204	73	300-660-035	146
300-480-045	102	300-490-206	72	300-660-105	47
300-480-130	101	300-490-220	73	300-660-110	47
300-480-131	101	300-490-221	73	300-661-004	47
300-480-140	101	300-501-730	140	300-661-005	47
300-480-141	101	300-503-000	145	300-661-006	47
300-480-142	101	300-503-015	145	300-661-007	47
300-480-160	101	300-503-016	145	300-661-008	47
300-480-161	101	300-503-021	145	300-661-009	47
300-480-170	101	300-503-025	145	300-661-010	47
300-480-171	101	300-503-052	145	300-700-400	15
300-480-172	101	300-503-060	144	300-700-430	15
300-480-230	101	300-503-063	144	300-750-001	46, 50, 51, 52, 53, 54, 64, 74, 75, 76, 77, 78, 79, 131, 134, 135
300-480-231	101	300-503-067	144	300-750-003	46, 54, 55, 56, 57, 58, 59, 60, 61, 62, 63, 65, 66, 67, 68, 69, 70, 71, 132, 133, 134, 135
300-480-240	101	300-503-069	144	300-750-015	46, 72, 73
300-480-241	101	300-503-080	144	300-750-101	46, 50, 51, 52, 53, 54, 64, 74, 75, 76, 77, 78, 79, 115, 131, 134, 135, 146
300-480-242	101	300-503-082	144	300-750-103	46, 54, 55, 56, 57, 58, 59, 60, 61, 62, 63, 65, 66, 67, 68, 69, 70, 71, 132, 133, 134, 135, 146
300-480-260	101	300-503-570	144	300-750-105	46, 56, 57, 58, 59, 60, 62, 63, 65, 66, 67, 68, 69, 70, 71, 115
300-480-261	101	300-503-710	145	300-750-106	46
300-480-270	101	300-503-731	145	300-750-115	46
300-480-271	101	300-505-000	145	300-750-215	46
300-480-272	101	300-505-015	145	300-750-315	46
300-480-330	103	300-505-016	145	300-755-400	15
300-480-340	103	300-505-021	145	300-755-430	15
300-480-341	103	300-505-025	145	300-760-005	47
300-480-360	103	300-505-052	145	300-760-010	47
300-480-370	103	300-505-060	144	300-760-105	47
300-480-371	103	300-505-063	144	300-760-110	47
300-480-530	103	300-505-067	144		
300-480-540	103	300-505-069	144		
300-480-541	103	300-505-080	144		
300-480-560	103	300-505-082	144		
300-480-570	103	300-505-570	144		
300-480-571	103	300-505-710	145		
300-480-630	101	300-505-731	145		
300-480-631	101	300-550-005	47		



300-800-001	90	300-810-514	91	300-855-007	122
300-800-002	90	300-810-516	91	300-855-010	122
300-800-004	90	300-820-013	93	300-855-011	122
300-800-006	90	300-820-014	93	300-855-013	122
300-800-011	91	300-820-015	94	300-855-015	122
300-800-012	91	300-820-051	93	300-855-017	122
300-800-014	91	300-820-052	93	300-855-018	122
300-800-016	91	300-820-056	94	300-855-019	122
300-800-401	90	300-820-413	93	300-855-020	122
300-800-402	90	300-820-414	93	300-855-021	122
300-800-404	90	300-820-415	94	300-855-022	122
300-800-406	90	300-820-451	93	300-855-023	122
300-800-411	91	300-820-452	93	300-855-025	122
300-800-412	91	300-820-456	94	300-855-027	122
300-800-414	91	300-830-005	92, 94	300-855-028	122
300-800-416	91	300-830-010	90, 91, 92, 94, 95	300-855-029	122
300-810-001	90	300-830-013	92	300-855-034	122
300-810-002	90	300-830-014	92	300-855-045	122
300-810-004	90	300-830-015	94	300-855-051	122
300-810-006	90	300-830-051	92	300-855-052	122
300-810-011	91	300-830-052	92	300-855-060	122
300-810-012	91	300-830-056	94	300-855-061	122
300-810-014	91	300-830-113	92	300-855-063	122
300-810-016	91	300-830-114	92	300-855-065	122
300-810-101	90	300-830-115	94	300-855-067	122
300-810-102	90	300-830-151	92	300-855-069	122
300-810-104	90	300-830-152	92	300-855-100	122
300-810-106	90	300-830-156	94	300-855-101	122
300-810-111	91	300-830-405	92, 94	300-855-102	122
300-810-112	91	300-830-410	90, 91, 92, 94, 95	300-855-103	122
300-810-114	91	300-830-413	92	300-855-105	122
300-810-116	91	300-830-414	92	300-855-120	122
300-810-401	90	300-830-415	94	300-855-134	122
300-810-402	90	300-830-451	92	300-855-145	122
300-810-404	90	300-830-452	92	300-855-400	122
300-810-406	90	300-830-456	94	300-855-401	122
300-810-411	91	300-830-513	92	300-857-100	123, 149
300-810-412	91	300-830-514	92	300-857-111	123, 149
300-810-414	91	300-830-515	94	300-857-112	123, 149
300-810-416	91	300-830-551	92	300-857-205	123, 149
300-810-501	90	300-830-552	92	300-857-301	123, 149
300-810-502	90	300-830-556	94	300-857-302	123, 149
300-810-504	90	300-855-001	122	300-857-303	123, 149
300-810-506	90	300-855-002	122	300-860-009	119, 120
300-810-511	91	300-855-003	122	300-860-011	119
300-810-512	91	300-855-006	122	300-860-012	119

300-860-013	6, 119	300-900-020	166	600-279-106	162
300-860-014	119	300-900-021	166	600-279-131	162
300-860-015	119	300-900-030	166	600-279-132	162
300-860-016	119	300-900-031	166	600-279-133	162
300-860-018	6, 119	300-900-040	166	600-279-134	162
300-860-019	6, 119	300-900-041	166	600-279-135	162
300-860-021	119, 136	300-900-180	176	600-279-136	162
300-860-023	119, 136	300-900-300	175	600-279-151	162
300-860-024	119, 136	300-900-902	3	600-279-152	162
300-860-025	119, 136	300-902-001	166, 167	600-279-153	162
300-860-026	119	300-902-003	166, 167	600-279-154	162
300-860-028	119, 136	300-902-004	166, 167	600-279-155	162
300-860-029	119, 136	300-902-005	166, 167	600-279-156	162
300-860-032	120	300-902-006	166, 167	600-279-201	162
300-860-033	120	300-902-007	166, 167	600-279-202	162
300-860-035	120	300-902-008	167	600-279-203	162
300-860-037	120	350-400-250	86	600-279-204	162
300-860-040	120	350-660-100	86	600-279-205	162
300-860-061	119	350-660-111	86	600-279-206	162
300-860-063	119	350-660-112	86	600-279-261	162
300-860-065	119	350-660-113	86	600-279-262	162
300-860-068	119	350-660-114	86	600-279-263	162
300-860-069	119	350-660-115	86	600-279-264	162
300-860-100	124	350-660-116	86	600-279-265	162
300-860-111	124	350-750-000	86	600-279-266	162
300-860-125	118	350-750-001	86	600-280-101	162
300-860-134	6, 118	350-750-002	86	600-280-102	162
300-860-140	118	350-755-007	87	600-280-103	162
300-860-141	118	350-755-011	87	600-280-104	162
300-860-142	118	350-755-017	87	600-280-105	162
300-860-143	118	600-050-000	164	600-280-106	162
300-860-145	118, 136	600-100-000	164	600-280-131	162
300-860-147	118	600-255-500	159	600-280-132	162
300-860-250	118	600-255-530	159	600-280-133	162
300-860-500	118	600-255-535	159	600-280-134	162
300-860-534	118	600-255-550	159	600-280-135	162
300-860-545	118	600-255-555	159	600-280-136	162
300-867-100	121, 148	600-255-565	159	600-280-151	162
300-867-120	121, 148	600-255-575	159	600-280-152	162
300-867-129	121, 148	600-255-600	159	600-280-153	162
300-867-520	121, 148	600-255-605	159	600-280-154	162
300-867-529	121, 148	600-279-101	162	600-280-155	162
300-867-620	121, 148	600-279-102	162	600-280-156	162
300-867-720	121, 148	600-279-103	162	600-280-201	162
300-867-729	121, 148	600-279-104	162	600-280-202	162
300-867-929	121, 148	600-279-105	162	600-280-203	162

600-280-204	162	600-469-155	161	600-579-101	160
600-280-205	162	600-469-156	161	600-579-102	160
600-280-206	162	600-470-101	161	600-579-103	160
600-280-261	162	600-470-102	161	600-579-104	160
600-280-262	162	600-470-103	161	600-579-105	160
600-280-263	162	600-470-104	161	600-579-106	160
600-280-264	162	600-470-105	161	600-579-131	160
600-280-265	162	600-470-106	161	600-579-132	160
600-280-266	162	600-470-131	161	600-579-133	160
600-281-001	159	600-470-132	161	600-579-134	160
600-281-002	158	600-470-133	161	600-579-135	160
600-281-003	8, 157	600-470-134	161	600-579-136	160
600-281-004	156	600-470-135	161	600-579-151	160
600-290-630	163	600-470-136	161	600-579-152	160
600-292-052	154	600-470-151	161	600-579-153	160
600-380-100	163	600-470-152	161	600-579-154	160
600-405-500	158	600-470-153	161	600-579-155	160
600-405-530	158	600-470-154	161	600-579-156	160
600-405-535	158	600-470-155	161	600-579-201	160
600-405-550	158	600-470-156	161	600-579-202	160
600-405-555	158	600-485-500	157	600-579-203	160
600-405-570	158	600-485-530	157	600-579-204	160
600-405-575	158	600-485-535	157	600-579-205	160
600-405-600	158	600-485-550	157	600-579-206	160
600-405-605	158	600-485-555	157	600-579-261	160
600-450-070	154	600-485-570	157	600-579-262	160
600-460-055	154	600-485-575	157	600-579-263	160
600-460-056	8, 154	600-485-600	157	600-579-264	160
600-462-052	154	600-485-605	157	600-579-265	160
600-464-229	153	600-501-000	152	600-579-266	160
600-469-101	161	600-501-002	152	600-580-101	160
600-469-102	161	600-505-000	152	600-580-102	160
600-469-103	161	600-505-002	152	600-580-103	160
600-469-104	161	600-506-002	152	600-580-104	160
600-469-105	161	600-508-000	153	600-580-105	160
600-469-106	161	600-511-000	153	600-580-106	160
600-469-131	161	600-513-003	5, 155	600-580-131	160
600-469-132	161	600-540-500	156	600-580-132	160
600-469-133	161	600-540-530	156	600-580-133	160
600-469-134	161	600-540-535	8, 156	600-580-134	160
600-469-135	161	600-540-550	5, 156	600-580-135	160
600-469-136	161	600-540-555	8, 156	600-580-136	160
600-469-151	161	600-540-570	156	600-580-151	160
600-469-152	161	600-540-575	156	600-580-152	160
600-469-153	161	600-540-600	156	600-580-153	160
600-469-154	161	600-540-605	156	600-580-154	160

600-580-155	160	600-950-100	164	700-286-050	44
600-580-156	160	700-100-101	124	700-286-130	44
600-580-201	160	700-100-102	124	700-286-230	44
600-580-202	160	700-100-103	124	700-287-030	124
600-580-203	160	700-100-104	125	700-287-050	124
600-580-204	160	700-100-105	125	700-287-130	124
600-580-205	5, 8, 160	700-100-130	124	700-287-150	124
600-580-206	160	700-100-150	124	700-287-230	125
600-580-261	160	700-100-202	125	700-287-250	125
600-580-262	160	700-100-302	125	700-290-030	44
600-580-263	160	700-100-303	125	700-290-050	44
600-580-264	160	700-100-305	125	700-291-030	44
600-580-265	160	700-100-402	125	700-291-050	44
600-580-266	160	700-100-405	125	700-292-030	44
600-900-040	163	700-100-502	125	700-293-033	44
600-900-041	163	700-100-505	125	700-293-035	44
600-900-050	163	700-101-001	124	700-300-003	124
600-900-051	163	700-101-030	44	700-300-005	124
600-900-060	163	700-101-050	44	700-300-203	124
600-900-061	163	700-101-130	124	700-300-205	124
600-900-070	163	700-101-150	124	700-300-403	125
600-900-071	163	700-101-230	125	700-300-405	125
600-900-080	163	700-101-250	125	700-300-503	125
600-900-081	163	700-102-030	44	700-300-505	125
600-900-090	163	700-103-030	44	700-300-603	125
600-900-091	163	700-103-050	44	700-300-703	125
600-900-100	163	700-104-050	44	700-300-705	125
600-900-101	163	700-200-030	125	700-300-805	125
600-900-108	163	700-200-050	125	700-340-400	179
600-900-109	163	700-200-130	124	700-340-410	179
600-900-110	163	700-200-132	124	700-345-003	125
600-900-111	163	700-200-150	124	700-345-005	125
600-900-120	163	700-200-152	124	700-345-403	125
600-900-121	163	700-200-232	125	700-345-405	125
600-900-130	163	700-200-252	125	700-350-030	124
600-900-131	163	700-200-332	125	700-350-050	124
600-900-140	163	700-200-352	125	700-350-130	124
600-900-141	163	700-200-432	125	700-350-150	124
600-900-150	163	700-200-452	125	700-350-400	178
600-900-151	163	700-200-532	125	700-350-402	178, 179
600-900-160	163	700-200-552	125	700-350-405	178, 179
600-900-161	163	700-280-030	44	700-350-410	178
600-900-210	163	700-280-050	44	700-351-030	124
600-908-000	163	700-285-030	44	700-351-031	124
600-908-100	163	700-285-050	44	700-351-047	125
600-909-000	163	700-286-030	44	700-351-048	125

700-351-050	124	700-739-003	125
700-351-051	124	700-739-005	125
700-351-053	125	700-900-160	164
700-351-055	125	700-900-220	164
700-351-131	6, 124	700-900-250	164
700-351-151	124		
700-351-231	125		
700-351-251	125		
700-360-031	6, 44		
700-360-051	44		
700-361-030	44		
700-361-050	44		
700-362-030	44		
700-362-050	44		
700-363-030	44		
700-363-050	44		
700-364-030	44		
700-370-030	44		
700-370-050	44		
700-390-030	125		
700-390-050	125		
700-400-003	124		
700-400-030	124		
700-400-050	124		
700-400-055	124		
700-400-103	124		
700-400-105	124		
700-400-130	124		
700-400-203	124		
700-400-205	125		
700-400-303	125		
700-400-403	125		
700-400-503	125		
700-400-603	125		
700-500-300	124		
700-500-500	124		
700-501-300	44		
700-501-303	44		
700-501-500	44		
700-501-503	44		
700-503-000	178, 179		
700-503-001	178, 179		
700-503-003	178, 179		
700-630-003	125		
700-736-003	125		
700-736-005	125		

