

INDEX

Sets	2 - 20
Cystoscopy	21 - 32
Resectoscopy	33 - 58
Laser Enucleation	59 - 71
Urethrotome	72 - 76
Lithotripsy	77 - 81
Nephroscopy	82 - 90
Uretero - Renoscopy	91 - 96
Pediatric	97 - 106
Devices and Flexible Instruments	107 - 109
Accessories	110 - 115
Cleaning	116 - 124
Equipment	125 - 146



Products marked with this symbol are not available with RZ-marking, and not the CE sign/CE number of RZ.



RZ-Topseller products

All products marked with this green star are available on stock.

CONFIGURATIONS by RZ Cystoscope Set for adults

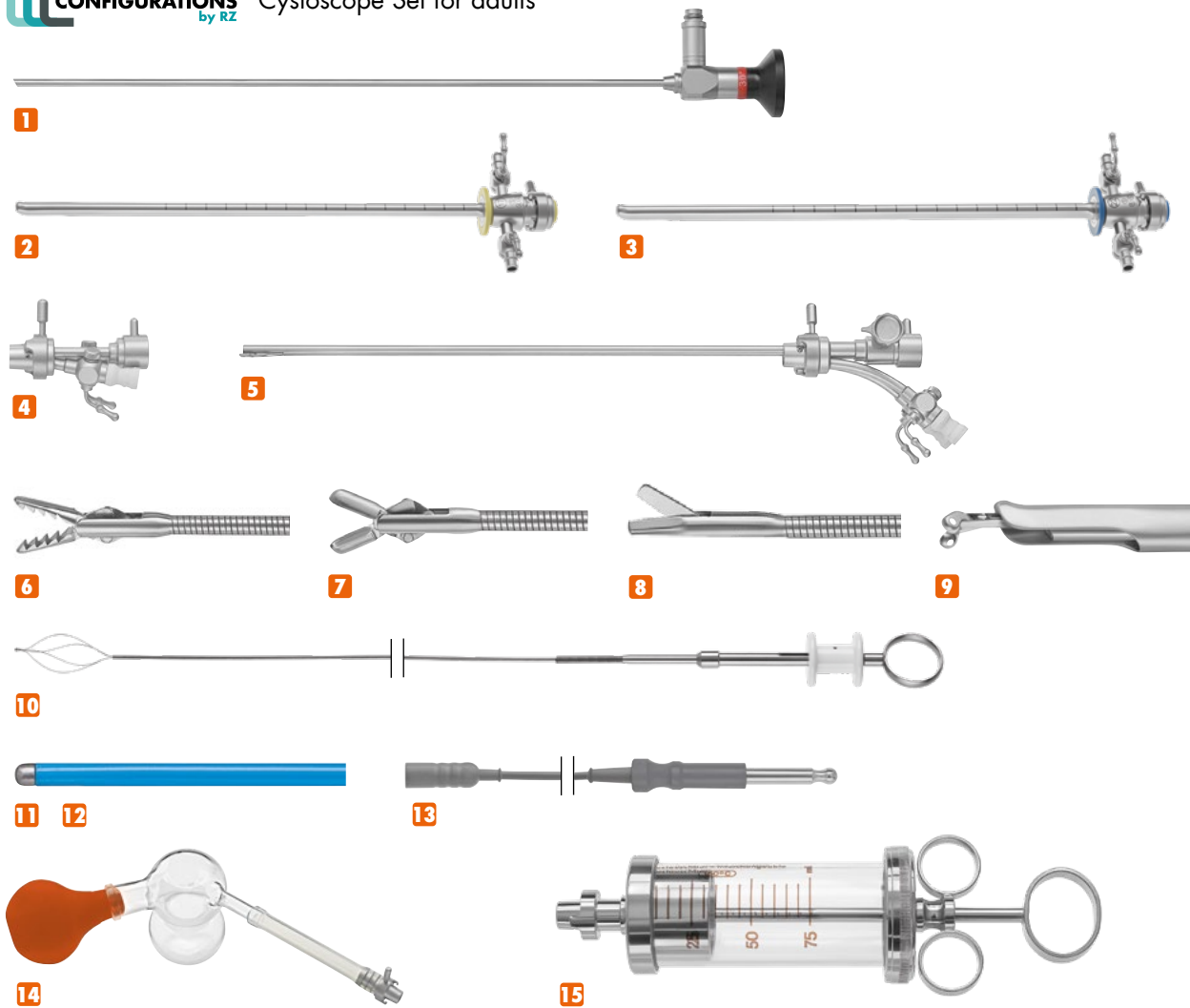

253-900-900 Cystoscope Set for adults

1	RZ Cystoscope, 30°, Ø 4.0mm	253-804-030	1 pc.
2	Cysto-Urethroscope Sheath 17 Charr.	253-300-017	1 pc.
3	Cysto-Urethroscope Sheath 22 Charr.	253-300-022	1 pc.
4	Bridge with 2 channels for 1 instrument with max. 12 Charr. or 2 instruments with max. 8 Charr.	253-000-102	1 pc.
5	Albarran deflecting mechanism with 2 working channels and ratchet	253-000-105	1 pc.
6	Flexible Grasping Forceps, serrated jaws, double action	351-114-107	1 pc.
7	Biopsy Forceps, oval cup, serrated jaws, double action	351-120-107	1 pc.
8	Scissors, single action	351-100-105	1 pc.
9	Spoon Biopsy Forceps with round cup, double action	253-420-100	1 pc.
10	Dormia Metal Stone Basket, flexible, 4 wires, 600mm working length, 5 Charr.	253-585-005	1 pc.
11	Ball Electrode 530mm working length, 5 Charr.	253-370-005	1 pc.
12	Ball Electrode 530mm working length, 7 Charr.	253-370-007	1 pc.
13	Monopolar Cable with 8 mm plug for Valleylab HF-unit	253-610-003	1 pc.
14	Elik Evacuator with turn lock connection	253-500-000	1 pc.
15	Bladder Syringe, 150cc	253-000-950	1 pc.

CONFIGURATIONS by RZ Cystoscope Set for children

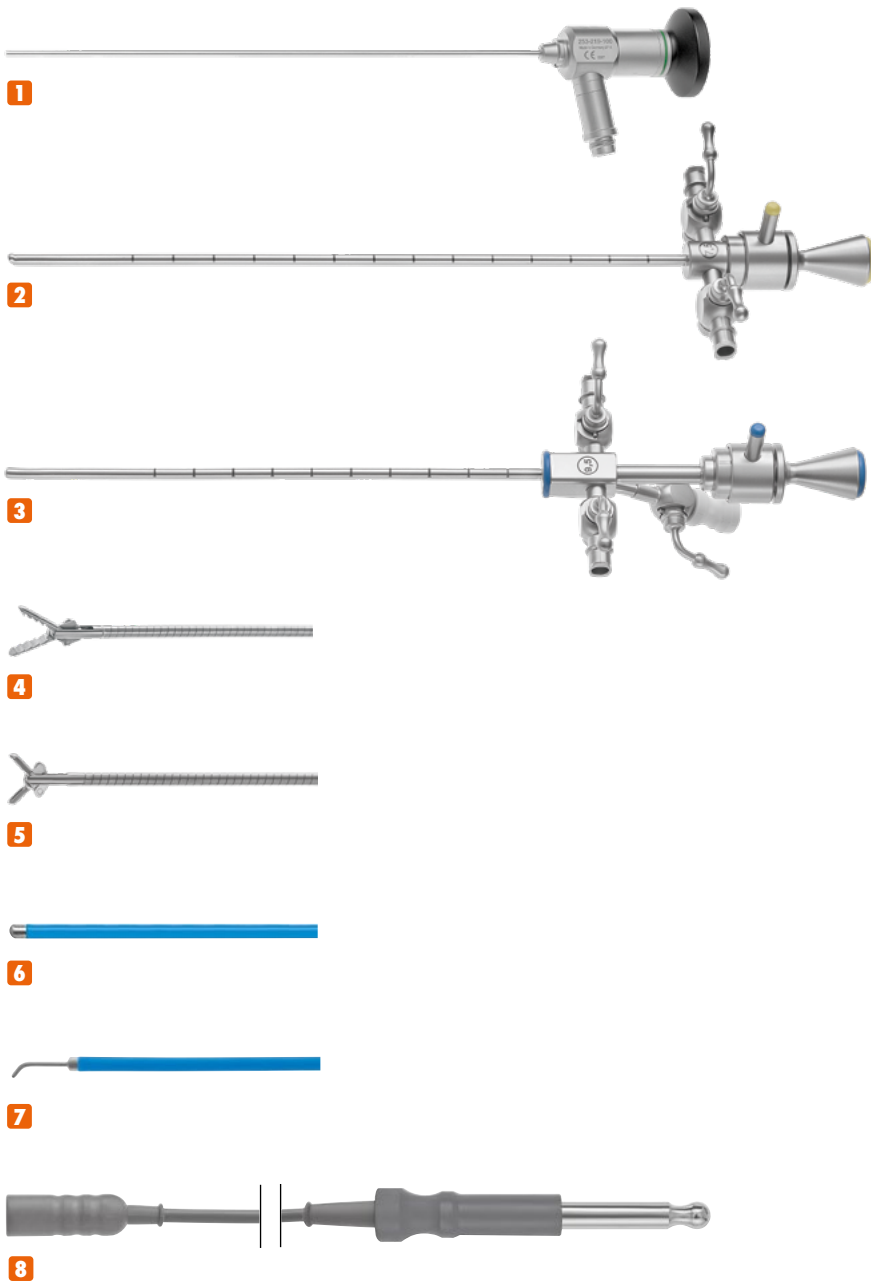

253-900-918 Cystoscope Set for children

1	RZ Pediatric Fiber Cystoscope, 30°, Ø 2.0mm	253-219-130	1 pc.
2	Pediatric Cystoscope Sheath 7.5 Charr.	253-200-075	1 pc.
3	Pediatric Cystoscope Sheath 9.5 Charr.	253-200-095	1 pc.
4	Alligator grasping forceps, 28cm length, 3 Charr.	253-202-003	1 pc.
5	Biopsy forceps, 28cm length, 3 Charr.	253-204-003	1 pc.
6	Ball electrode, 25cm length, 3 Charr.	253-370-253	1 pc.
7	Needle electrode, 25cm length, 3 Charr.	253-371-253	1 pc.
8	Monopolar Cable with 8 mm plug for Valleylab HF-unit	253-610-003	1 pc.

CONFIGURATIONS by RZ Cystoscope Set for (newborn) babies

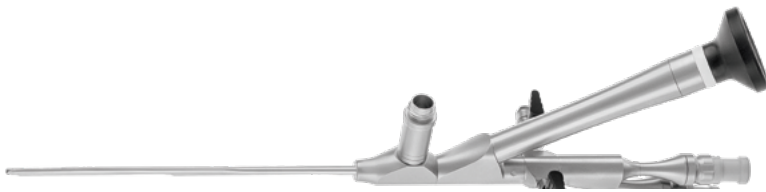

1



2



3



4



5



6



7



8

253-900-919 Cystoscope Set for (newborn) Babies

1	Operating Cysto-Urethrotome 4.5 Charr., 5° direction of view	253-200-600	1 pc.
2	Stone Grasping Forceps, double action, 3 Charr.	253-203-128	1 pc.
3	Biopsy Forceps, double action, 3 Charr.	253-203-328	1 pc.
4	Scissors, single action, 3 Charr.	253-203-428	1 pc.
5	Ball Electrode, 3 Charr.	253-370-253	1 pc.
6	Needle electrode, 3 Charr.	253-371-253	1 pc.
7	Hook Knife, 3 Charr.	253-200-200	1 pc.
8	Injection Cannula, 3 Charr.	253-200-210	1 pc.

CONFIGURATIONS by RZ 26 Charr. Monopolar Resectoscope Set for adults

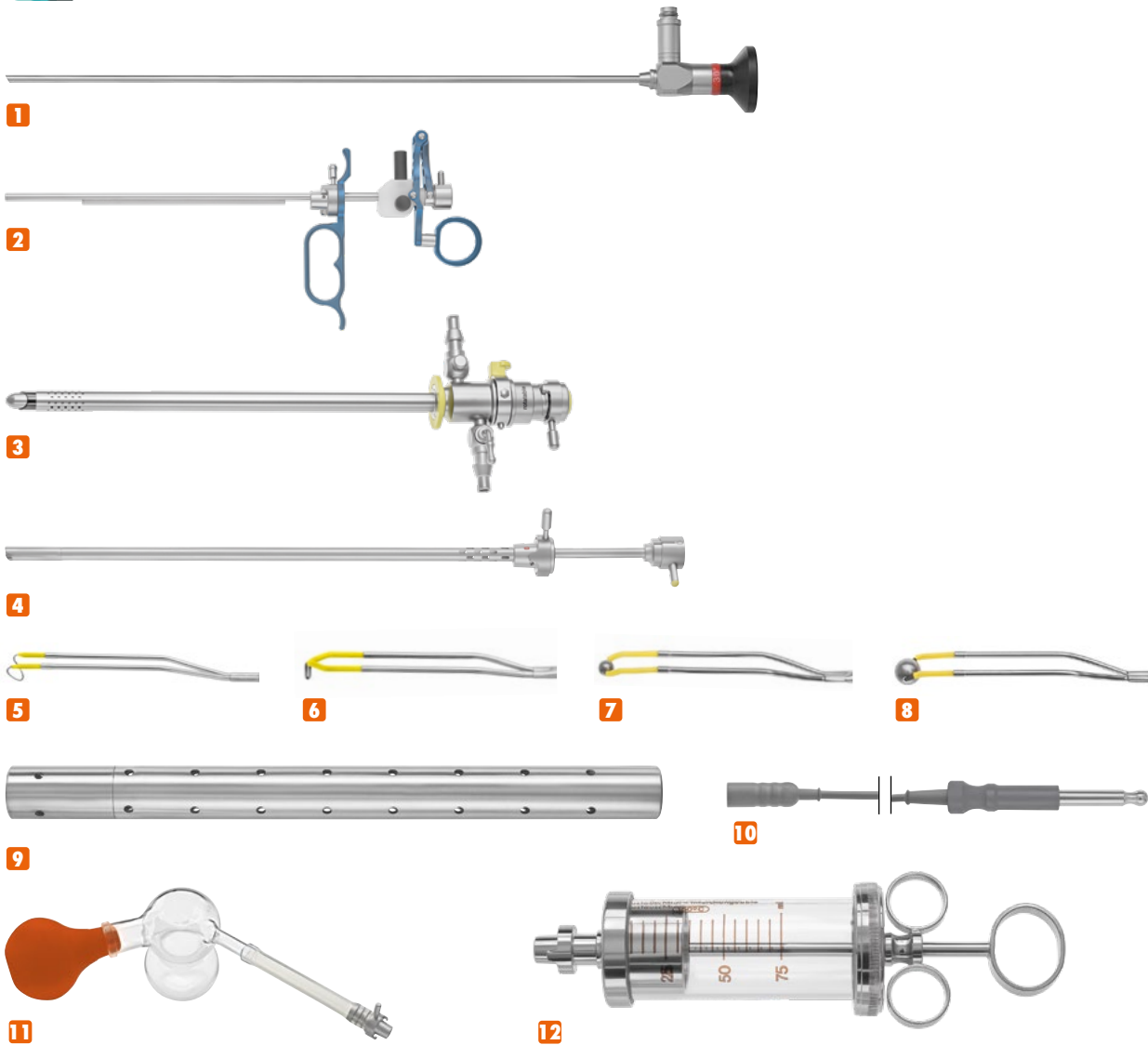

253-900-901 26 Charr. Monopolar Resectoscope Set for adults

1	RZ Cystoscope, 30°, Ø 4.0mm	253-804-030	1 pc.
2	Passive Titanium working element	253-000-200	1 pc.
3	Continuous Flow Resectoscope Sheath, 26 Charr., with obturator	253-000-256	1 pc.
4	Visual Obturator for 4mm RZ Cystoscopes	253-000-084	1 pc.
5	Cutting Loop, angled, for 12°/30° telescope	253-300-201	1 pc.
6	Coagulation Electrode, pointed	253-300-203	1 pc.
7	Coagulation Electrode, ball shape, Ø 3mm	253-300-205	1 pc.
8	Coagulation Electrode, ball shape, Ø 5mm	253-300-206	1 pc.
9	Sterilization tubes for electrodes	253-300-999	1 pc.
10	Monopolar Cable with 8 mm plug for Valleylab HF-unit	253-610-003	1 pc.
11	Ellik Evacuator with turn lock connection	253-500-000	1 pc.
12	Bladder Syringe, 150cc	253-000-950	1 pc.



Monopolar Resectoscope Set for children

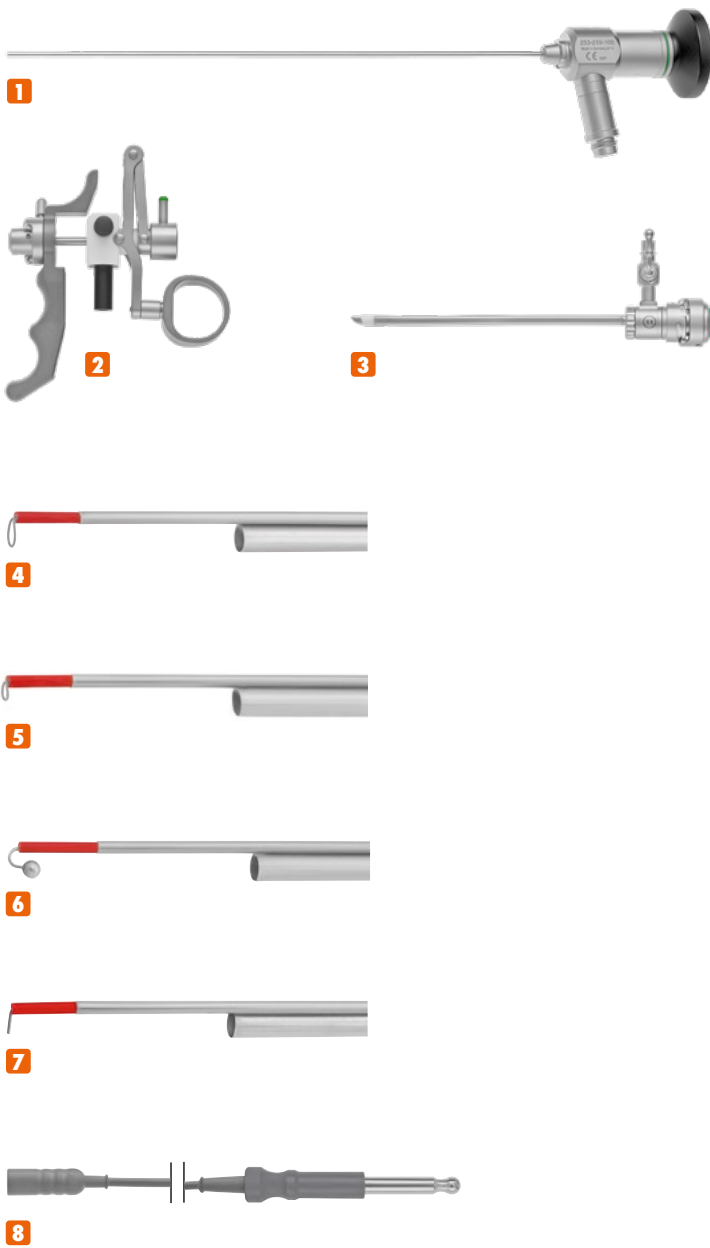

253-900-905 Monopolar Resectoscope Set for children

1	RZ Pediatric Fiber Cystoscope, 0°, Ø 2.0mm	253-219-100	1 pc.
2	Passive Titanium working element	253-250-200	1 pc.
3	Resectoscope Sheath 11 Charr. with obturator	253-250-211	1 pc.
4	Cutting Loop Electrode, 11 Charr.	253-251-111	1 pc.
5	Coagulation Electrode, 11 Charr.	253-251-112	1 pc.
6	Hook Electrode with ball, 11 Charr.	253-251-113	1 pc.
7	Needle Electrode, pointed, 11 Charr.	253-251-115	1 pc.
8	Monopolar Cable with 8 mm plug for Valleylab HF-unit	253-610-003	1 pc.

CONFIGURATIONS by RZ 26 Charr. Bipolar (HYBRID) Resectoscope Set for adults

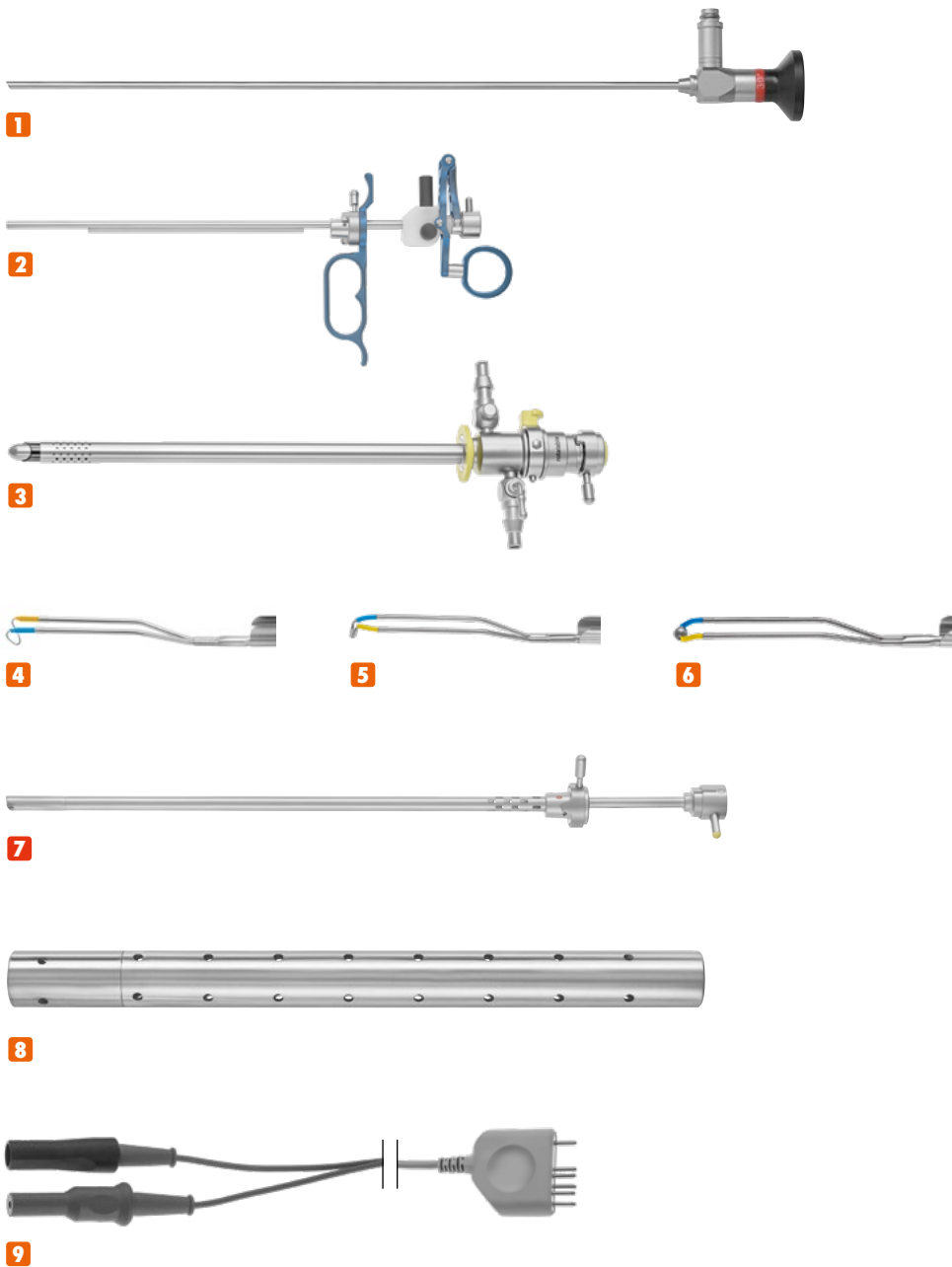

253-900-911 26 Charr. Bipolar (HYBRID) Resectoscope Set for adults

1	RZ Cystoscope, 30°, Ø 4mm	253-804-030	1 pc.
2	Passive HYBRID working element	253-000-400	1 pc.
3	Continuous Flow Resectoscope Sheath, 26 Charr.	253-000-256	1 pc.
4	Cutting Electrode	253-400-201	1 pc.
5	Collins Coagulation Electrode	253-400-203	1 pc.
6	Ball Electrode	253-400-205	1 pc.
7	Visual Obturator, with 6 Charr. working channel	253-000-094	1 pc.
8	Sterilization tube for electrodes	253-300-999	1 pc.
9	SDS Cable, 4.5m, bipolar	700-500-453	1 pc.



22 Charr. Bipolar (HYBRID) Resectoscope Set

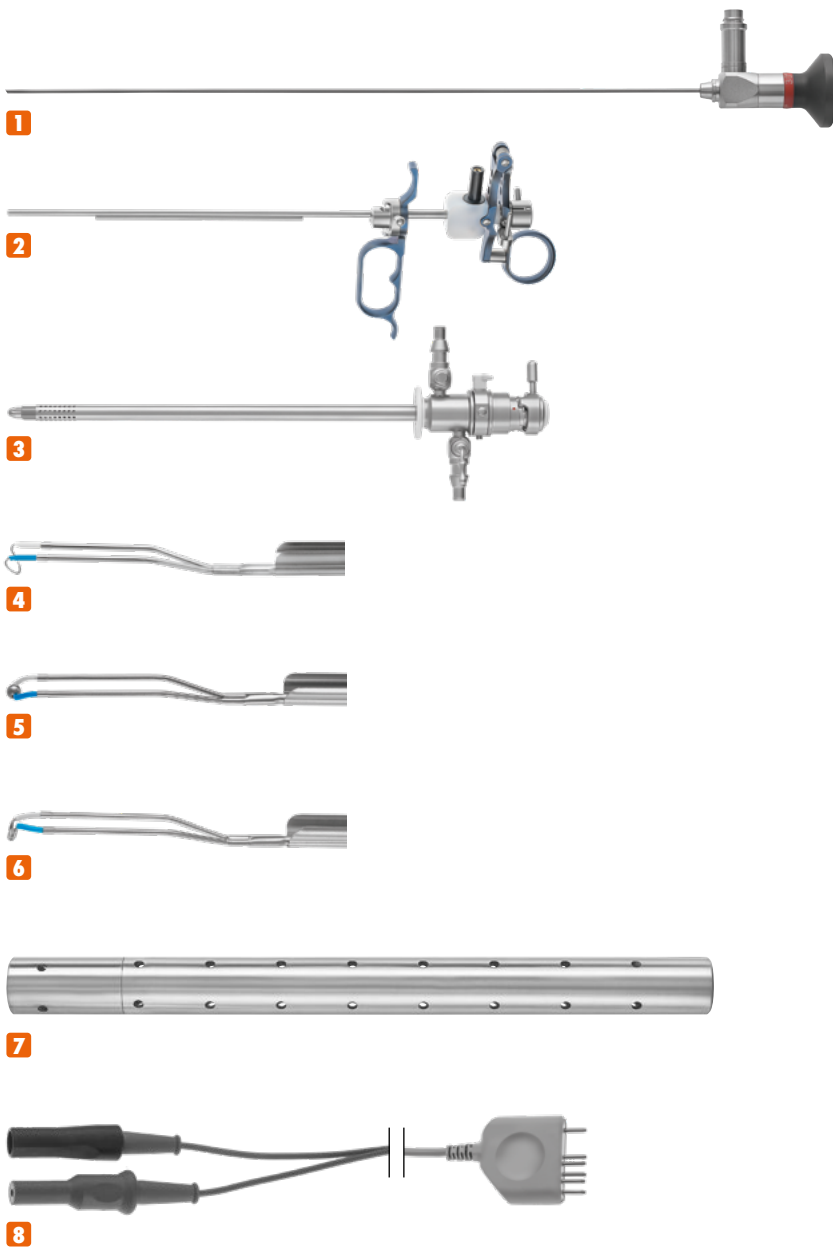

22 Charr. Hybrid Resectoscope Set

1	RZ Rod Lens Cystoscope, 30°, Ø 2.9mm	351-829-030	1 pc.
2	Passive Titanium Working Element	253-000-410	1 pc.
3	Resectoscope Sheath, 22 Charr., rotating inner tube, for continuous suction / irrigation	253-000-352	1 pc.
4	Loop Electrode, 30° angled	253-000-541	1 pc.
5	Ball Electrode	253-000-545	1 pc.
6	Knife Electrode	253-000-543	1 pc.
7	Storage container for knives and electrodes, metal, perforated	253-300-999	1 pc.
8	SDS Cable, 4.5m, bipolar	700-500-453	1 pc.



18.5 Charr. Bipolar (HYBRID) Resectoscope Set

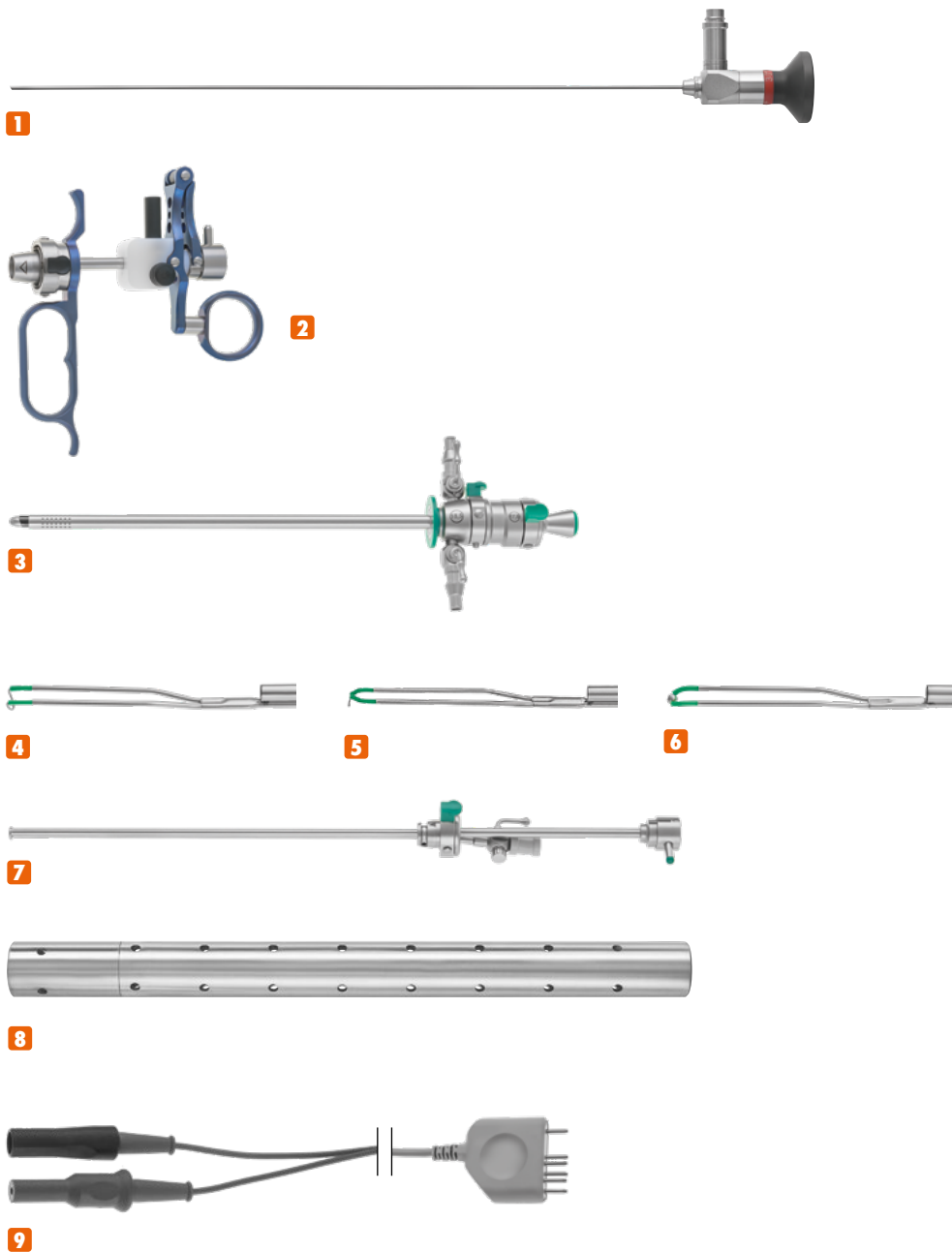

253-900-921 18.5 Charr. Bipolar (HYBRID) Resectoscope Set for adults and adolescents

1	RZ Cystoscope, 30°, Ø 2.9mm	253-829-030	1 pc.
2	Passive HYBRID working element	351-400-200	1 pc.
3	Continuous Flow Resectoscope Sheath, 18.5 Charr.	351-000-185	1 pc.
4	Loop Electrode	351-000-201	1 pc.
5	Knife Electrode	351-000-203	1 pc.
6	Ball Electrode	351-000-205	1 pc.
7	Visual Obturator, with 5 Charr. working channel	351-000-180	1 pc.
8	Sterilization tube for electrodes	253-300-999	1 pc.
9	SDS Cable, 4.5m, bipolar	700-500-453	1 pc.



HoLEP Laser Resectoscope Set according to Dr. Felipe C. A. de Figueiredo

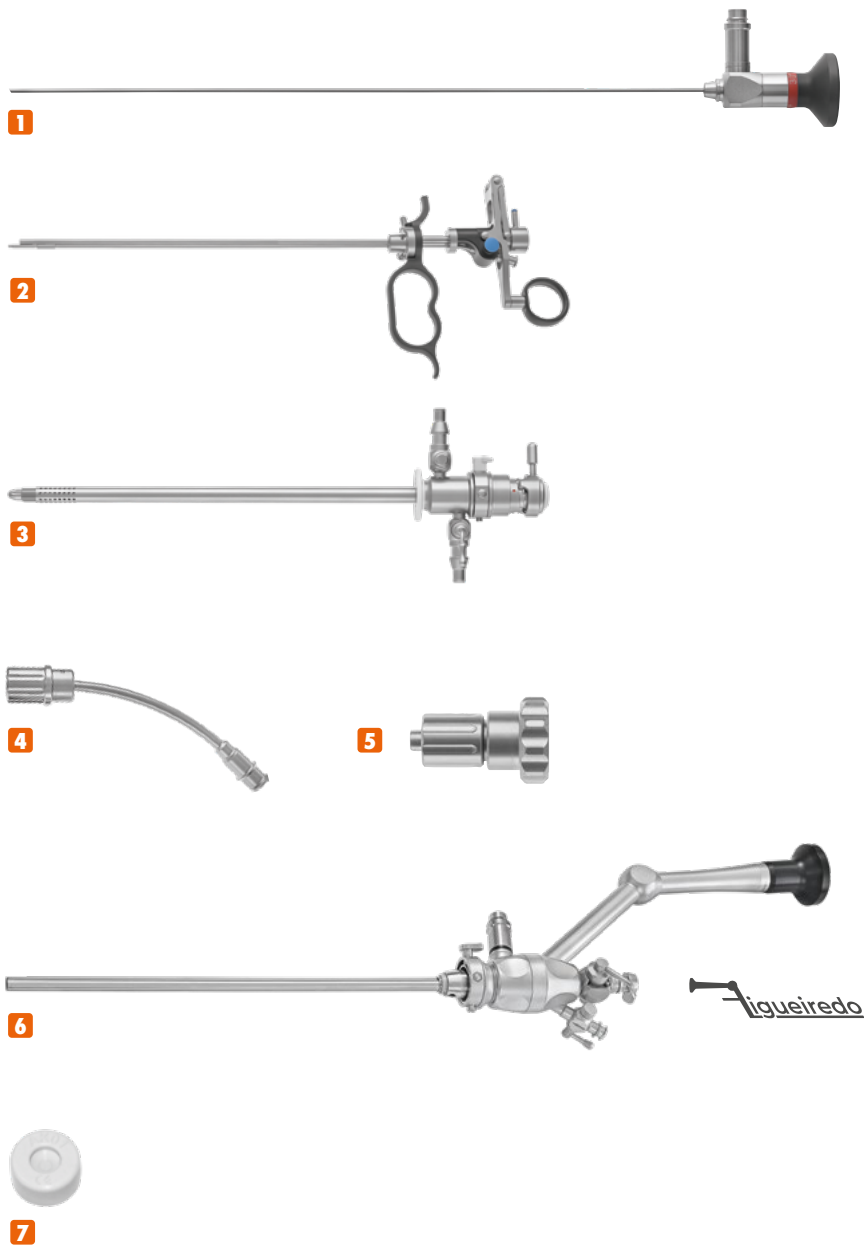

Laser Resectoscope Set according to Dr. Felipe C. A. de Figueiredo

1	RZ Rod Lens Cystoscope, 30°, Ø 2.9mm	351-829-030	1 pc.
2	RZ Laser Working Element, passive, for fibres up to 0.8mm	253-000-319	1 pc.
3	Resectoscope Sheath, 22 Charr., rotating inner tube, for continuous suction / irrigation	253-000-352	1 pc.
4	RZ LL-Connection, rotatable, for use with Laser Probe, short	253-000-301	1 pc.
5	Luer-Lock Tuohy Borst Adapter (Ø 0.6 - 1.4mm)	300-011-184	1 pc.
6	Morcescope, 22 Charr., 220mm working length, 5mm working channel	253-905-220	1 pc.
7	Sealing Cap for Morcescope, package of 10 pieces	253-904-220	1 pc.

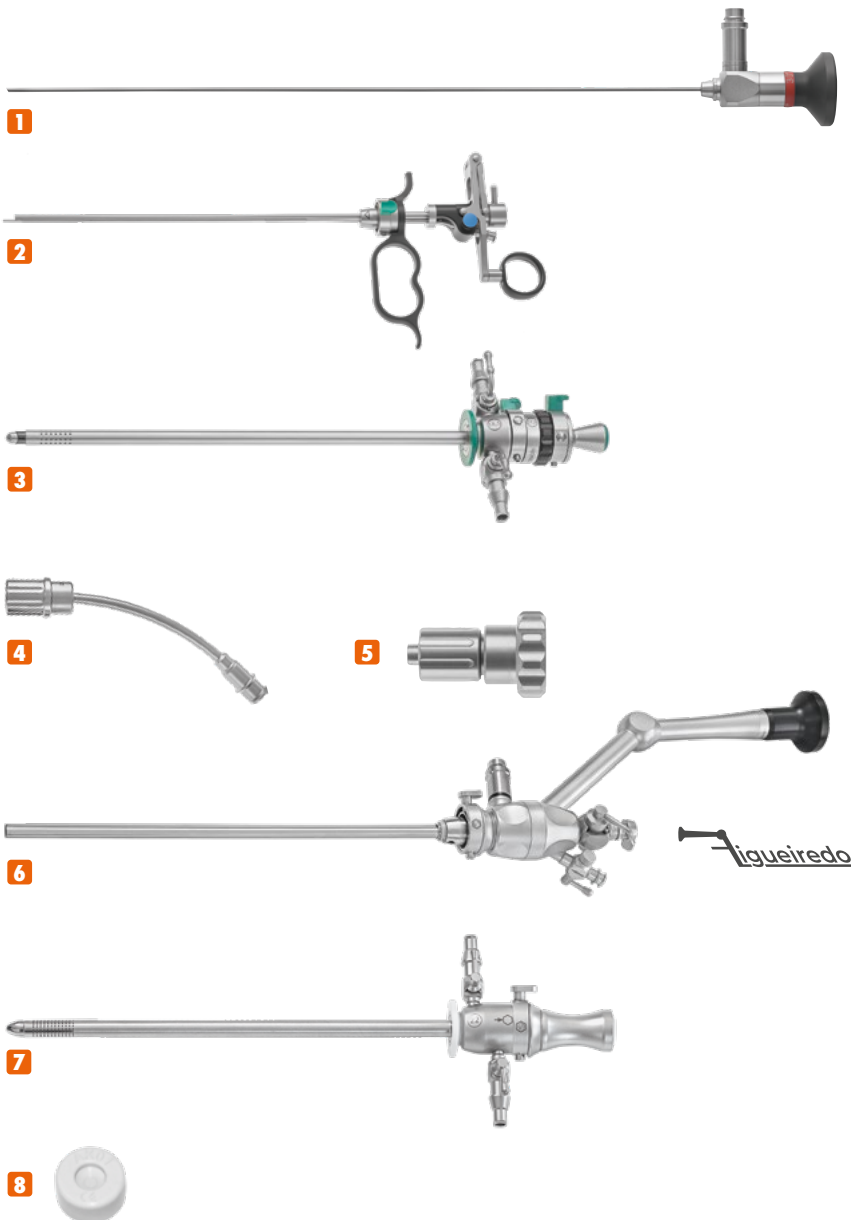

Laser Resectoscope Set according to Dr. Felipe C. A. de Figueiredo

1	RZ Rod Lens Cystoscope, 30°, Ø 2.9mm	351-829-030	1 pc.
2	RZ Laser Working Element, passive, for fibres up to 0.8mm, with push button	253-000-318	1 pc.
3	Resectoscope Continuous Flow Sheath, 18.5 Charr.	351-000-185	1 pc.
4	RZ LL-Connection, rotatable, for use with Laser Probe, short	253-000-301	1 pc.
5	Luer-Lock Tuohy Borst Adapter (Ø 0.6 - 1.4mm)	300-011-184	1 pc.
6	Morcescope, 22 Charr., 220mm working length, 5mm working channel	253-905-220	1 pc.
7	Continuous Flow Sheath, 22 Charr.	253-901-220	1 pc.
8	Sealing Cap for Morcescope, package of 10 pieces	253-904-220	1 pc.



HoLEP Set

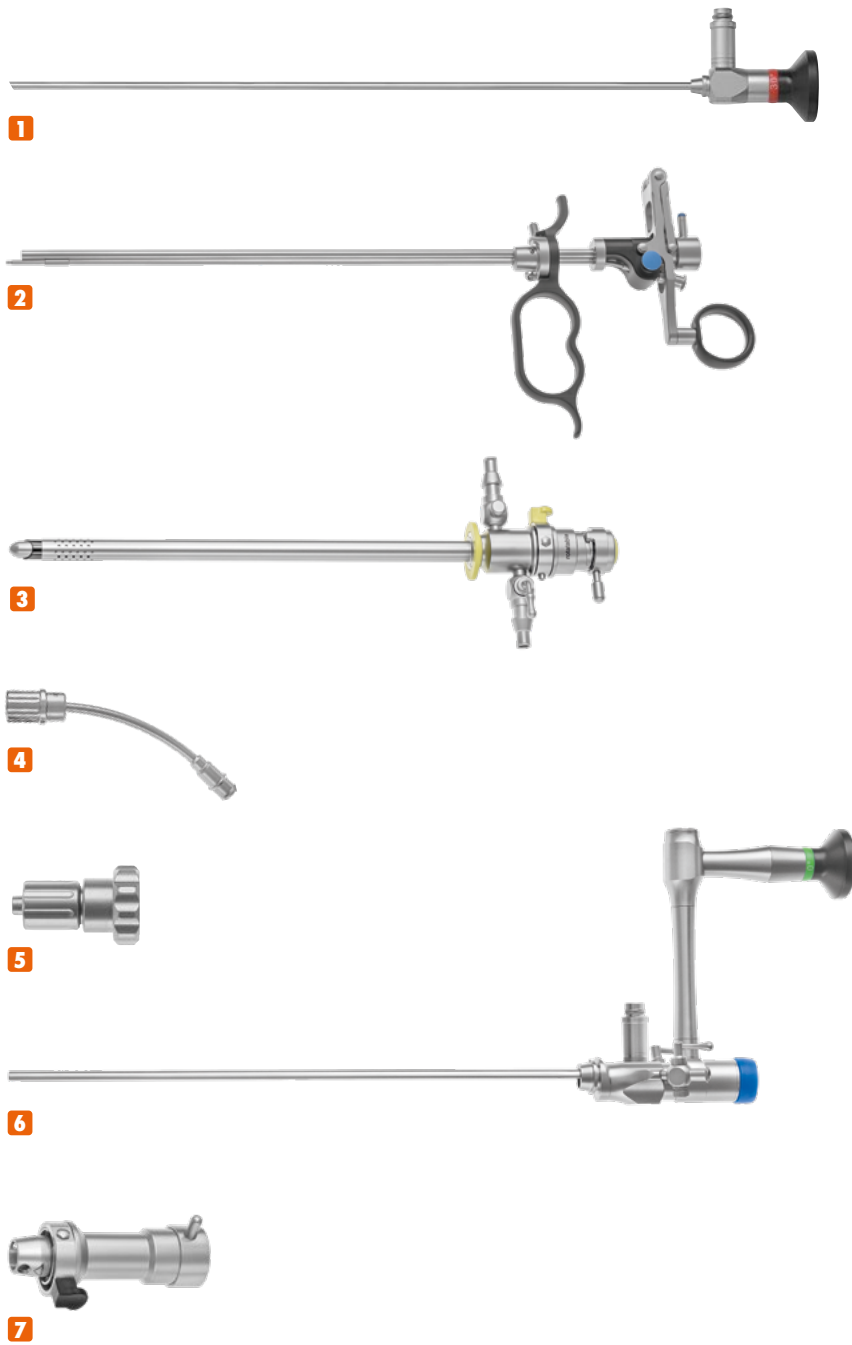

253-900-920 HoLEP Set

1	RZ Cystoscope, 30°, Ø 4.0mm	253-804-030	1 pc.
2	RZ Laser Working Element, passive, for laser-probes	253-000-312	1 pc.
3	Continuous Flow Resectoscope Sheath, 26 Charr.	253-000-256	1 pc.
4	RZ LL-Connection	253-000-302	1 pc.
5	Luer-Lock Tuohy Borst Adapter	300-011-184	1 pc.
6	Nephroscope 6°	253-900-121	1 pc.
7	Adapter for Resectoscope outer sheath 253-000-256	253-428-100	1 pc.

CONFIGURATIONS by RZ Urethrotome Set for adults

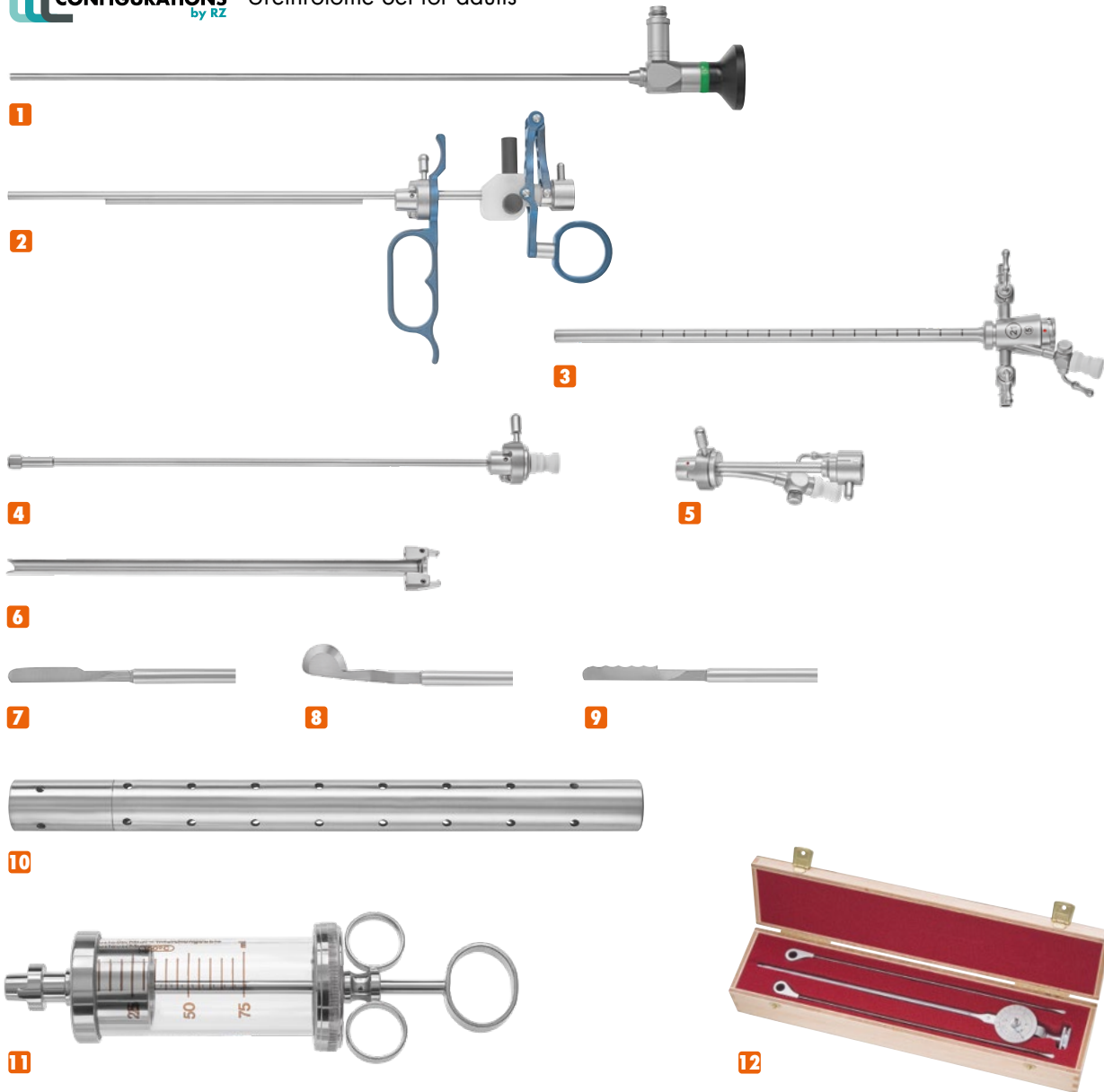

253-900-902 Urethrotome Set for adults

1	RZ Cystoscope, 0°, Ø 4.0mm	253-804-000	1 pc.
2	Passive Titanium Working Element	253-000-200	1 pc.
3	Urethrotome Sheath oval shape, 21 Charr.	253-500-221	1 pc.
4	Hollow Obturator with channel for guide wires	253-500-321	1 pc.
5	Bridge with channel for 5 Charr. accessories	253-500-325	1 pc.
6	Supplementary Sheath, half round	253-500-230	1 pc.
7	Sachse knife, straight	253-500-561	3 pcs.
8	Half round knife, 180° cutting	253-500-563	2 pcs.
9	WaveCut knife, straight	253-500-564	1 pc.
10	Sterilization tube for electrodes	253-300-999	1 pc.
11	Bladder Syringe, 150cc	253-000-950	1 pc.
12	OTIS Dilation Urethrotome, complete	253-500-100	1 pc.



Urethrotome Set for children

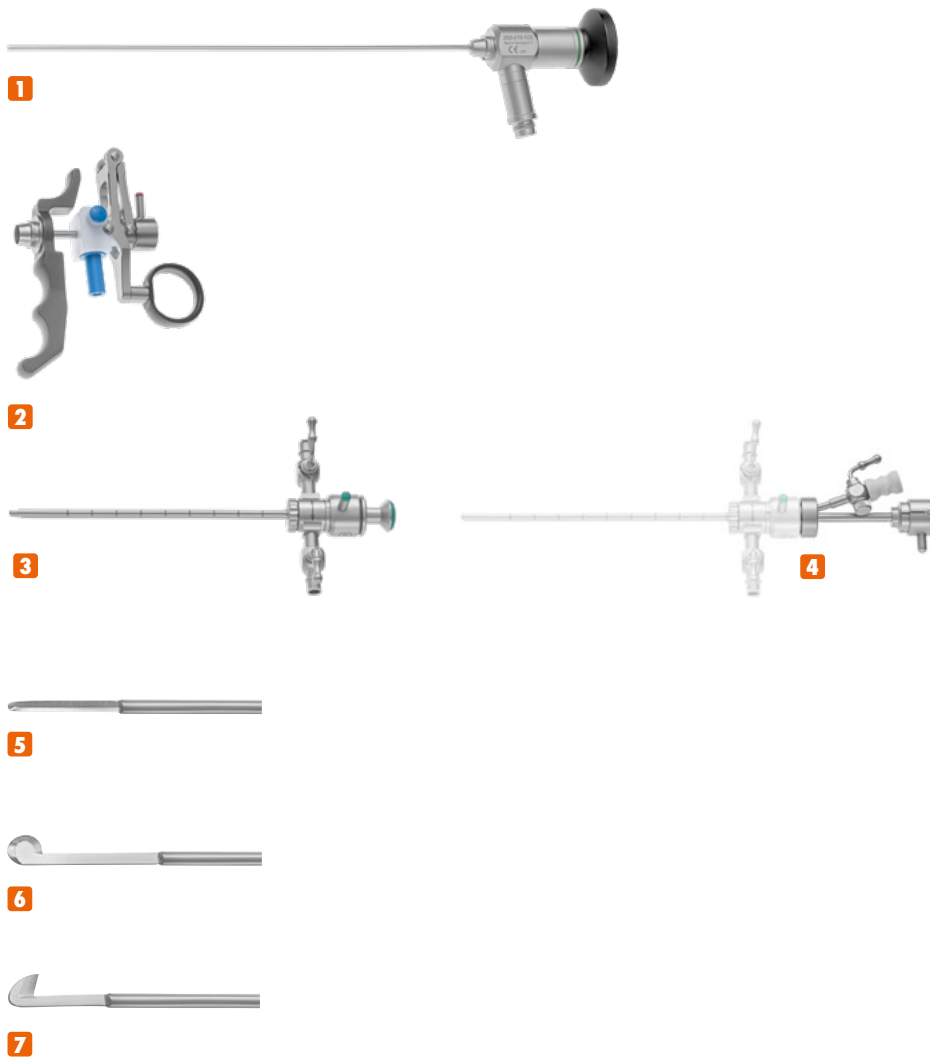

253-900-922 Urethrotome Set for children

1	RZ Pediatric Fiber Cystoscope, 0°, Ø 2.0mm	253-219-100	1 pc.
2	Passive Working Element	253-250-200	1 pc.
3	Pediatric Urethrotome sheath, 10 Charr.	253-265-010	1 pc.
4	Bridge with 1 channel	253-255-001	1 pc.
5	Knife with straight cutting edge	253-265-101	1 pc.
6	Round Knife	253-265-102	1 pc.
7	Hook Knife	253-265-104	1 pc.

CONFIGURATIONS Uretero-Renoscope Set
by RZ

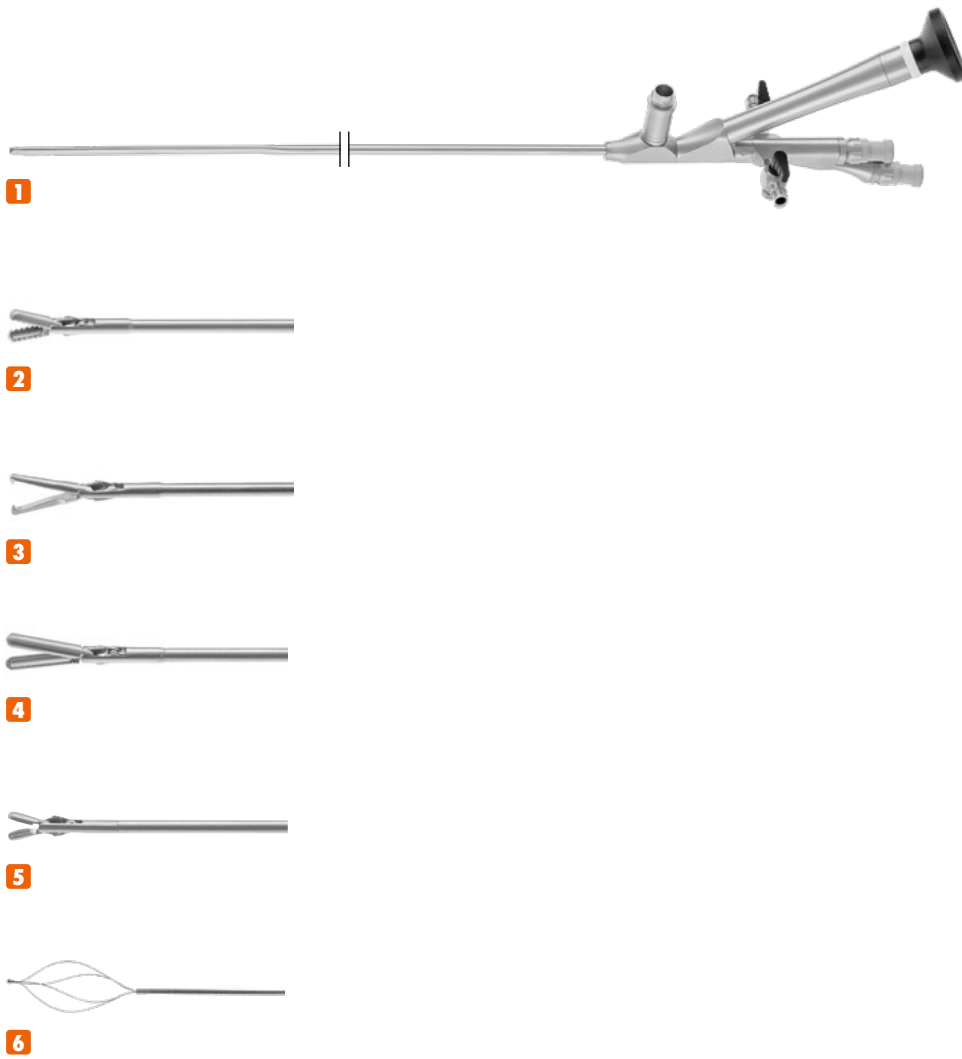

253-900-903 Uretero-Renoscope Set

1	Advanced Semi-Rigid Uretero-Renoscope	253-905-540	1 pc.
2	Stone Grasping Forceps	253-950-005	1 pc.
3	Stone Grasping Forceps for large stones	253-952-005	1 pc.
4	HAMADA Long Stone Grasping Forceps	253-954-005	1 pc.
5	Biopsy Forceps	253-956-005	1 pc.
6	Dormia Metal Stone Basket, flexible	253-585-005	1 pc.



Nephroscope Set, Mini PCNL

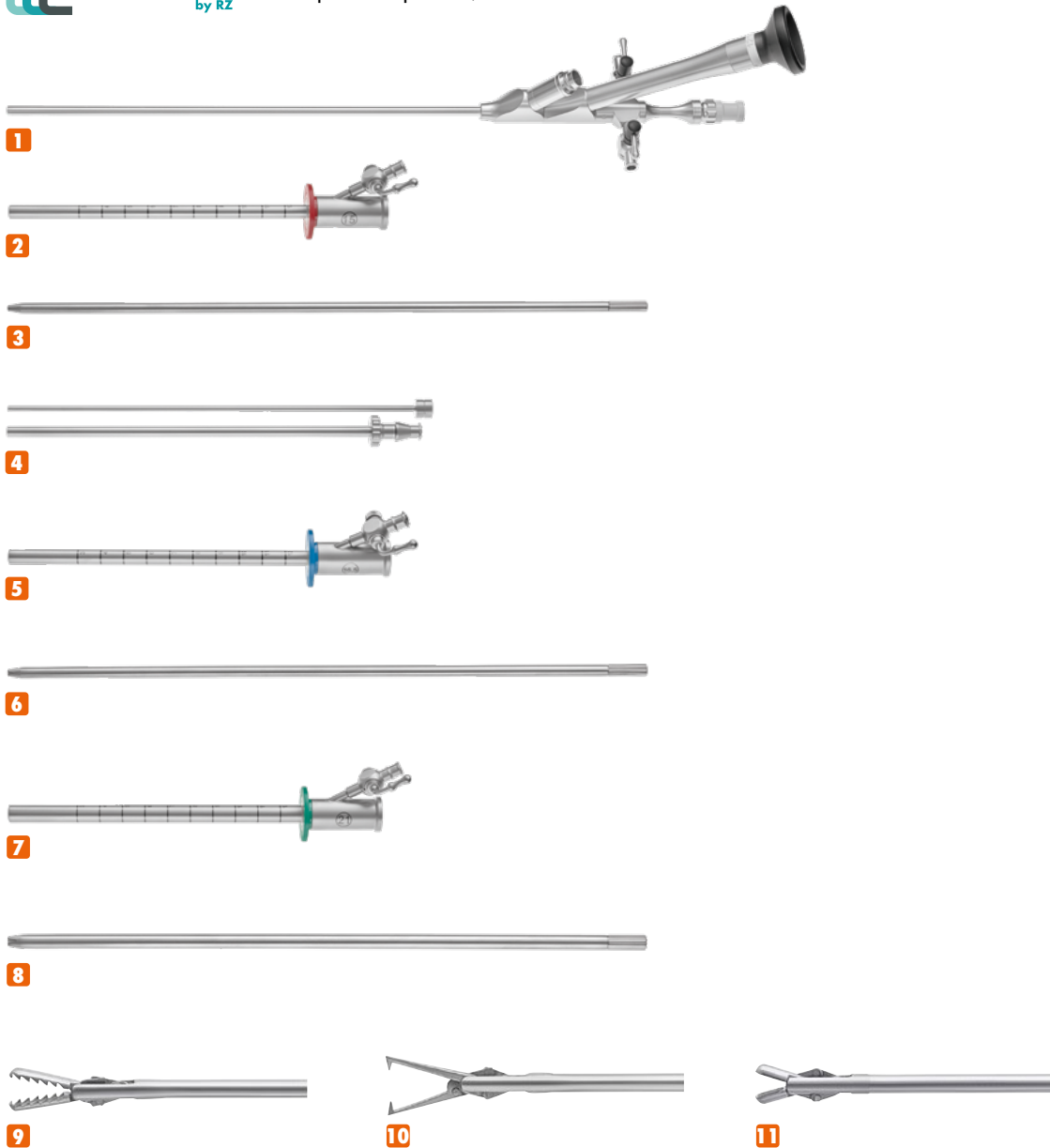

253-900-909 Nephroscope Set, Mini PCNL

1	Mini Nephroscope, 12°	253-900-140	1 pc.
2	15 Charr. Nephroscope Sheath	253-900-141	1 pc.
3	One-Step Dilator	253-900-146	1 pc.
4	2-piece Sealing Adapter	253-900-145	1 pc.
5	16.5 Charr. Nephroscope Sheath	253-900-142	1 pc.
6	One-Step Dilator	253-900-147	1 pc.
7	21 Charr. Nephroscope Sheath	253-900-143	3 pcs.
8	One-step Dilator	253-900-148	3 pcs.
9	Stone Grasping forceps	253-950-455	1 pc.
10	Stone Grasping Forceps for large stones	253-952-455	1 pc.
11	Biopsy Forceps	253-956-455	1 pc.

CONFIGURATIONS by RZ Nephroscope Set, Compact PCNL

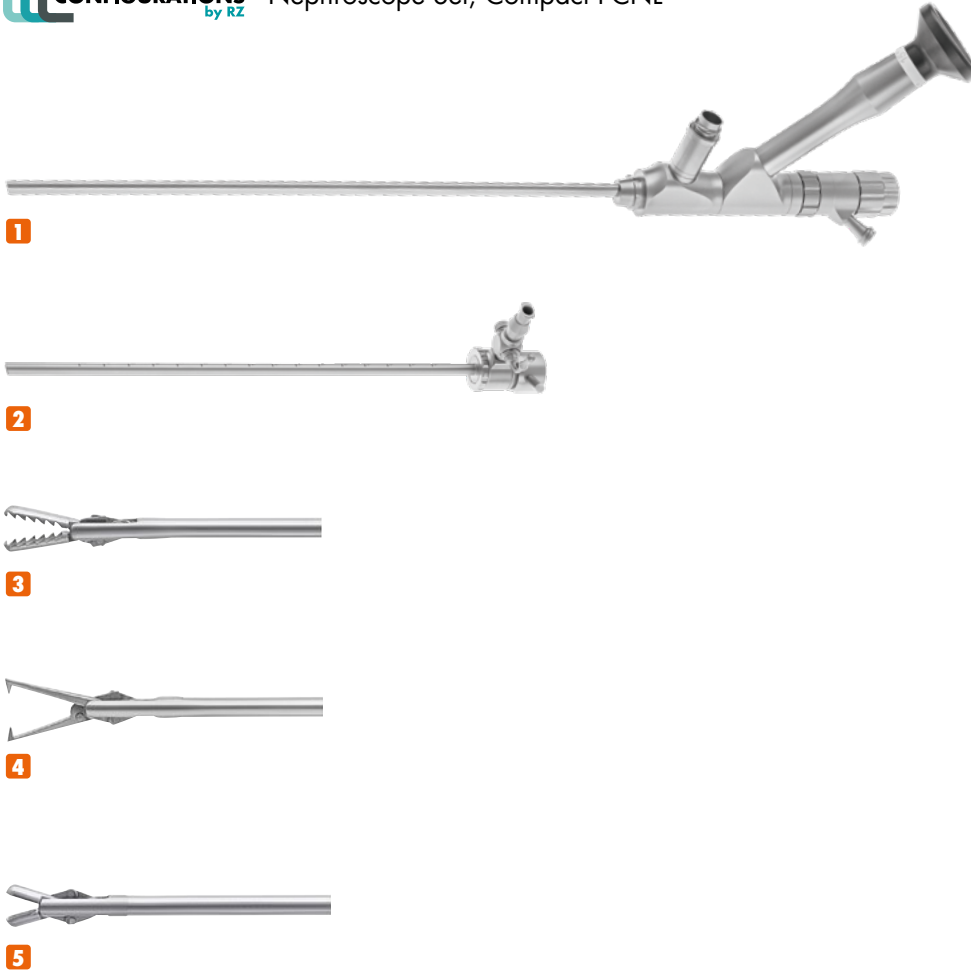

253-900-923 Nephroscope Set, Compact PCNL

1	Compact Nephroscope	253-900-830	1 pc.
2	Shaft with Obturator	253-900-888	1 pc.
3	Stone Grasping forceps	253-950-455	1 pc.
4	Stone Grasping Forceps for large stones	253-952-455	1 pc.
5	Biopsy Forceps	253-956-455	1 pc.



Nephroscope Set, Standard PCNL

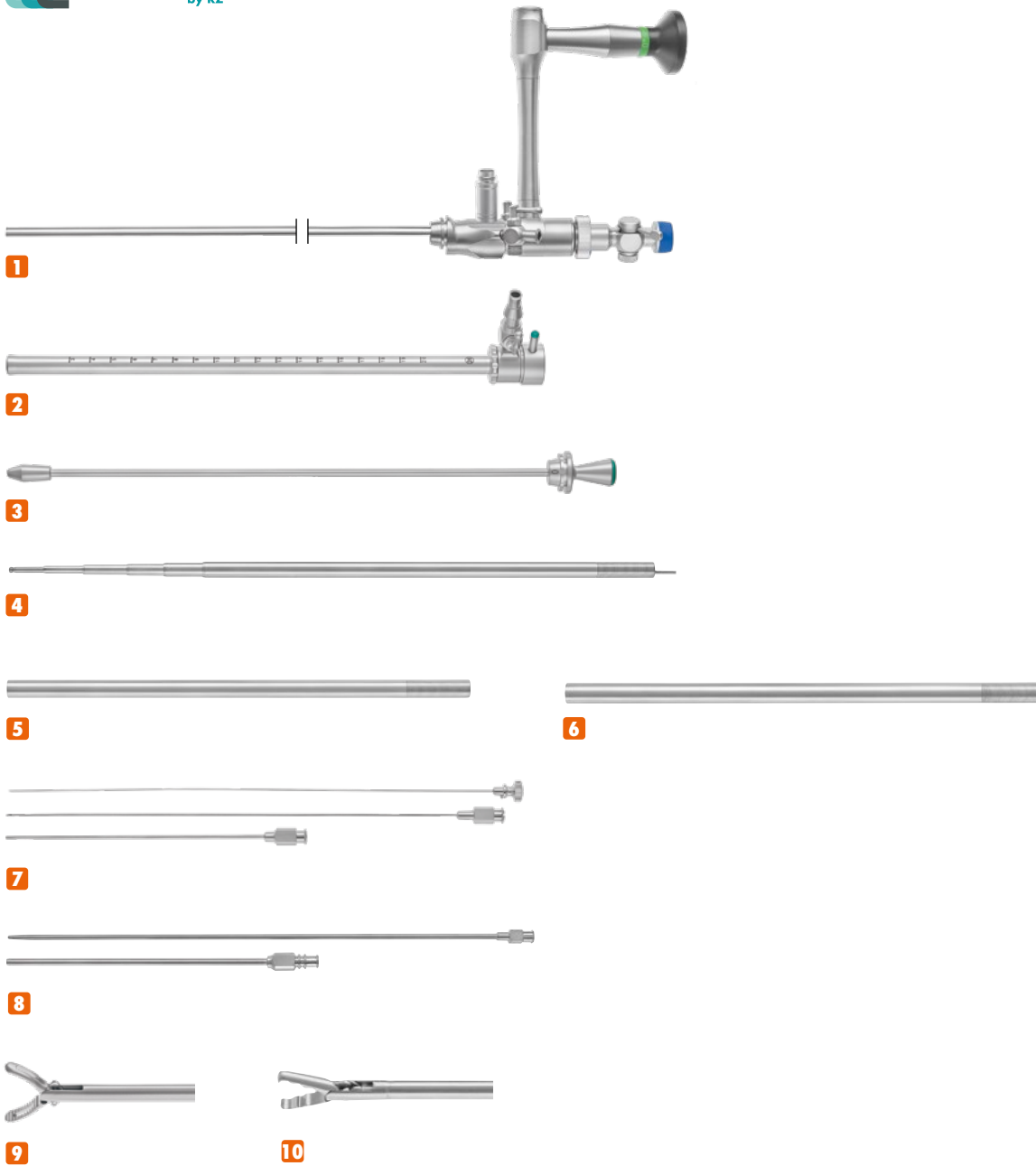

253-900-924 Nephroscope Set, Standard PCNL

1	Nephroscope, 6°	253-900-121	1 pc.
2	Operating Sheath 26 Charr.	253-900-130	1 pc.
3	Hollow Obturator 26 Charr.	253-900-135	1 pc.
4	Amplatz metal Dilator Set	253-900-155	1 pc.
5	Amplatz metal Dilator 27 Charr.	253-900-156	1 pc.
6	Amplatz metal Dilator 30 Charr.	253-900-157	1 pc.
7	Puncture Cannula with inner and outer cannula	253-900-201	3 pcs.
8	Dilation Cannula, Ø 3mm	253-900-202	3 pcs.
9	Stone Grasping Forceps, fenestrated	253-900-250	1 pc.
10	Stone Grasping Forceps, coarse serrated	253-900-252	1 pc.

CONFIGURATIONS by RZ Lithotripsy Set, mechanical

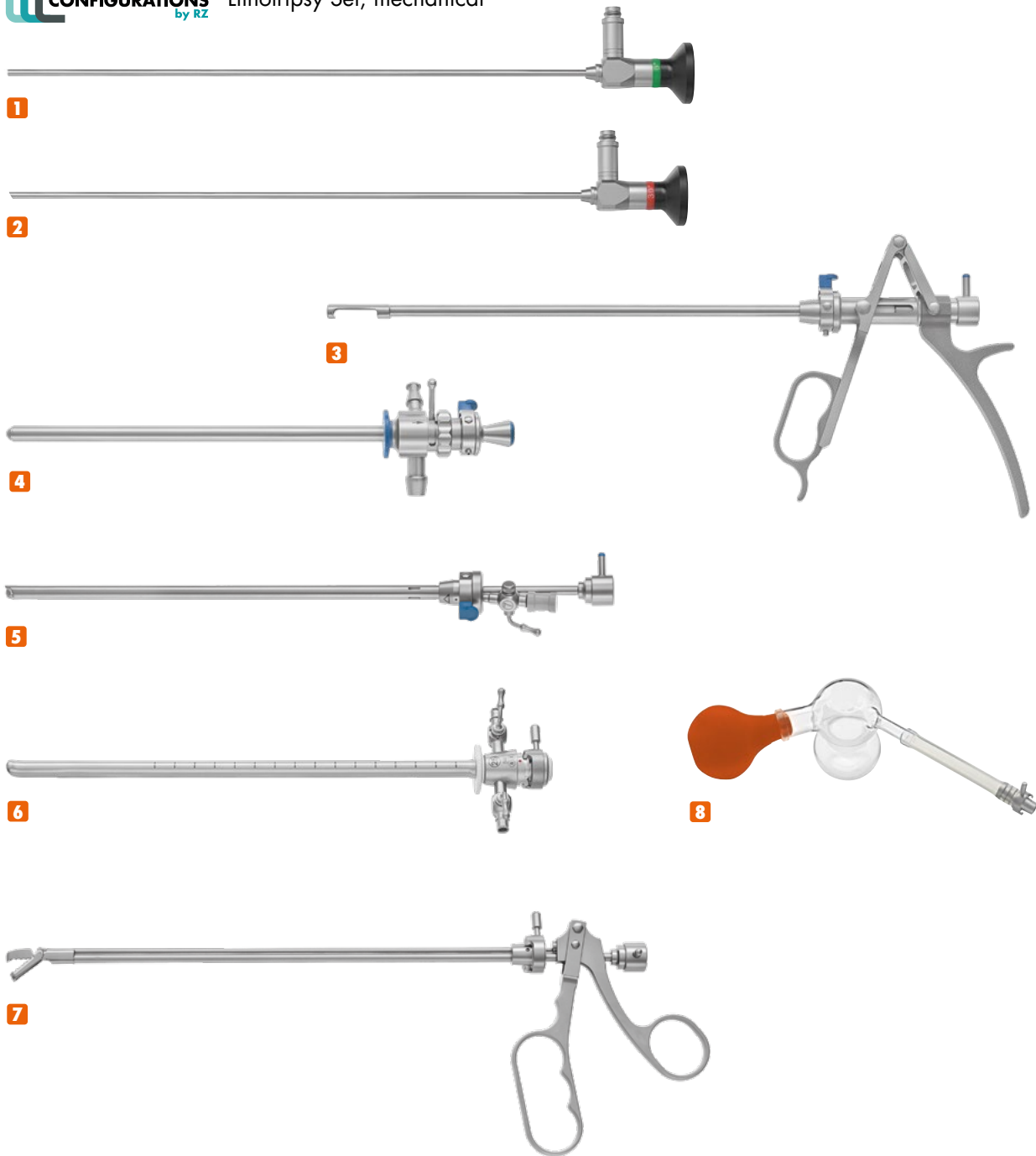

253-900-925 Lithotripsy Set, mechanical

1	RZ Cystoscope, 0°, Ø 4.0mm	253-804-000	1 pc.
2	RZ Cystoscope, 30°, Ø 4.0mm	253-804-030	1 pc.
3	Mauermayer Stone Punch	253-755-010	1 pc.
4	Punch Sheath with Central Valve, 24 Charr.	253-755-020	1 pc.
5	Visual Obturator with 7 Charr. working channel	253-755-030	1 pc.
6	Cysto-Urethroscope Sheath 25 Charr.	253-300-025	1 pc.
7	Stone Crushing Forceps for small stones, single action	253-760-000	1 pc.
8	Ellik Evacuator with turn lock connection	253-500-000	1 pc.



Lithotripsy Set, electro-pneumatic



1



2



3



4 - 9

253-900-926 Lithotripsy Set, electro-pneumatic

1	L 100 Lithotripter	253-750-100	1 pc.
2	Pneumatic Footswitch	253-750-150	1 pc.
3	Hand piece, anodised	253-750-200	1 pc.
4	Litho Probe, 0.6mm	253-850-006	2 pcs.
5	Litho Probe, 0.8mm	253-850-008	2 pcs.
6	Litho Probe, 1.0mm	253-850-010	2 pcs.
7	Litho Probe, 1.2mm	253-850-012	2 pcs.
8	Litho Probe, 1.6mm	253-850-016	2 pcs.
9	Litho Probe, 2.0mm	253-850-020	2 pcs.

CYSTOSCOPY

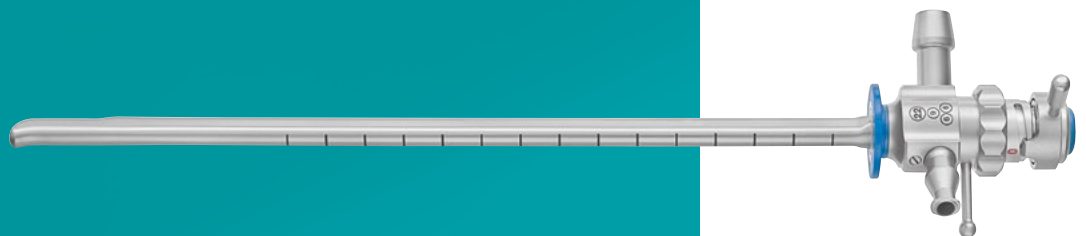

FULL HD CYSTOSCOPES

- Colour coded rings identify the direction of view
- 3-step light post adapters for the most common light cables
- Sapphire glasses to protect lens system
- Optimized glass fibre arrangements for an uniform image brightness
- Fully autoclavable at 134°C and 2.3bar

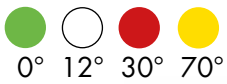

FULL HD

Ø 4mm Endoscopes for Cystoscopy



● 0° DIRECTION OF VIEW
 300mm working length
 356mm overall length 253-804-000*



○ 12° DIRECTION OF VIEW
 300mm working length
 356mm overall length 253-804-012*



● 30° DIRECTION OF VIEW
 300mm working length
 356mm overall length 253-804-030*



● 70° DIRECTION OF VIEW
 300mm working length
 356mm overall length 253-804-070*

Sheaths for use with \varnothing 4mm Cystoscopes

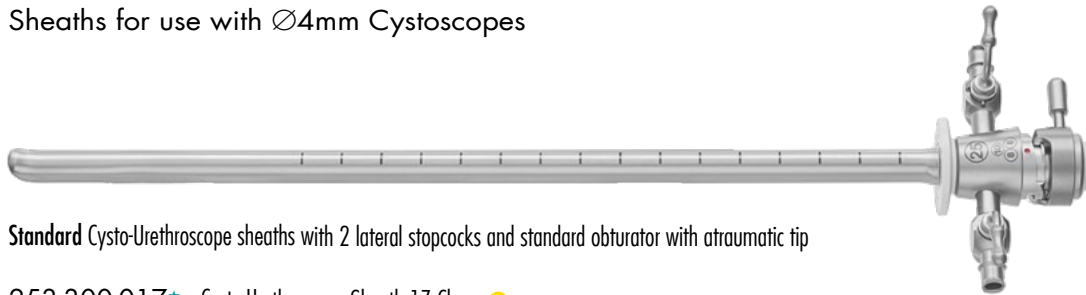

Standard Cysto-Urethroscope sheaths with 2 lateral stopcocks and standard obturator with atraumatic tip

- 253-300-017* Cysto-Urethroscope Sheath 17 Charr. ●
- 253-300-019* Cysto-Urethroscope Sheath 19 Charr. ●
- 253-300-020* Cysto-Urethroscope Sheath 20 Charr. ●
- 253-300-022* Cysto-Urethroscope Sheath 22 Charr. ●
- 253-300-025* Cysto-Urethroscope Sheath 25 Charr. ○

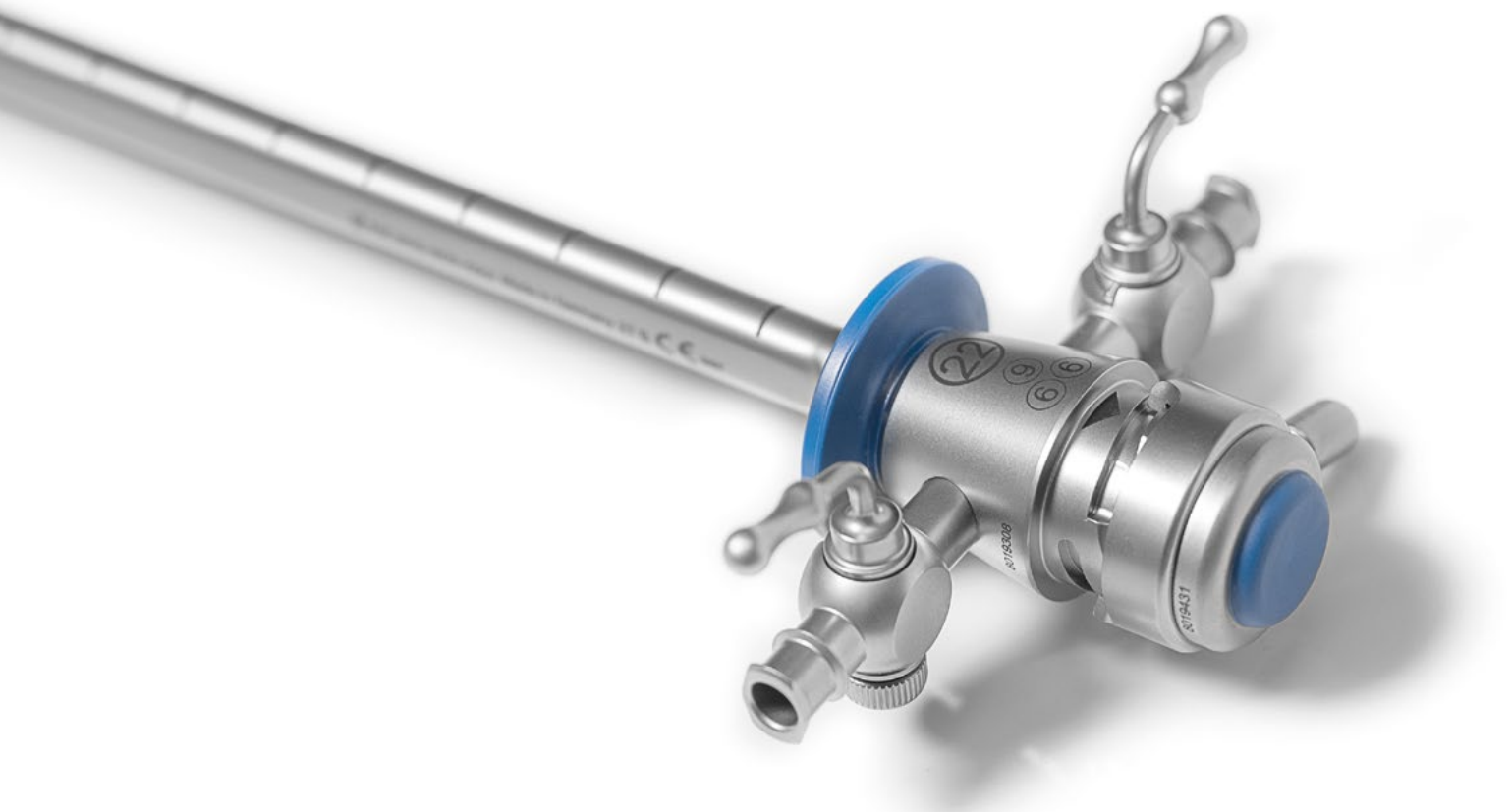

Obturator for use with Cystoscope sheaths



Standard Obturators with atraumatic tip and locking mechanism for all RZ Cysto-Urethroscope sheaths

- 253-000-117 Obturator 17 Charr. ●
- 253-000-119 Obturator 19 Charr. ●
- 253-000-120 Obturator 21 Charr. ●
- 253-000-122 Obturator 23 Charr. ●
- 253-000-125 Obturator 25 Charr. ○



Visual Obturators with locking mechanism for all 4mm RZ Cystoscopes

- 253-000-217 Obturator 17 Charr. ●
- 253-000-219 Obturator 19 Charr. ●
- 253-000-220 Obturator 20 Charr. ●
- 253-000-222 Obturator 22 Charr. ●
- 253-000-225 Obturator 25 Charr. ○



253-315-000
Hamada Cystoscope Adapter for use with RZ Cystoscope sheath

Cystoscope Bridge for use with Cysto-Urethroscope sheaths

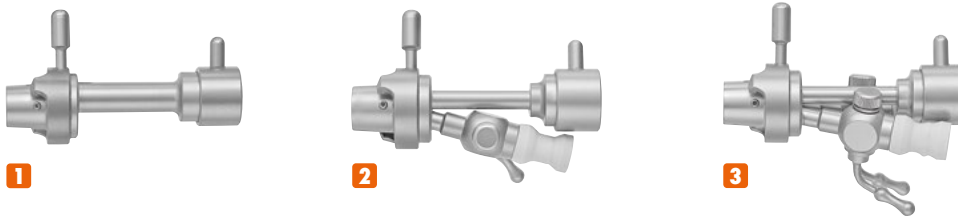

- 1** 253-000-100* without channel
- 2** 253-000-101* with 1 channel for 1 instrument with max. 12 Charr.
- 3** 253-000-102* with 2 channels for 1 instrument with max. 12 Charr. or 2 instruments with max. 8 Charr.

Albarran deflecting mechanism for use with 19-25 Charr. RZ Cysto-Urethroscope sheaths

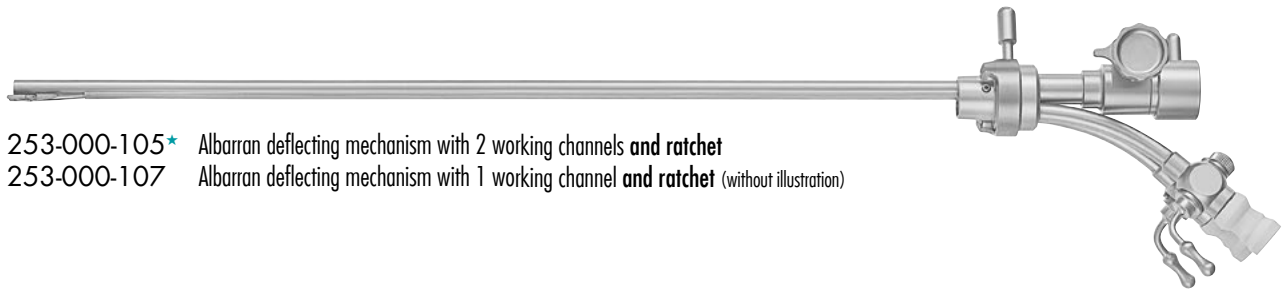

- 253-000-105* Albarran deflecting mechanism with 2 working channels **and ratchet**
- 253-000-107 Albarran deflecting mechanism with 1 working channel **and ratchet** (without illustration)

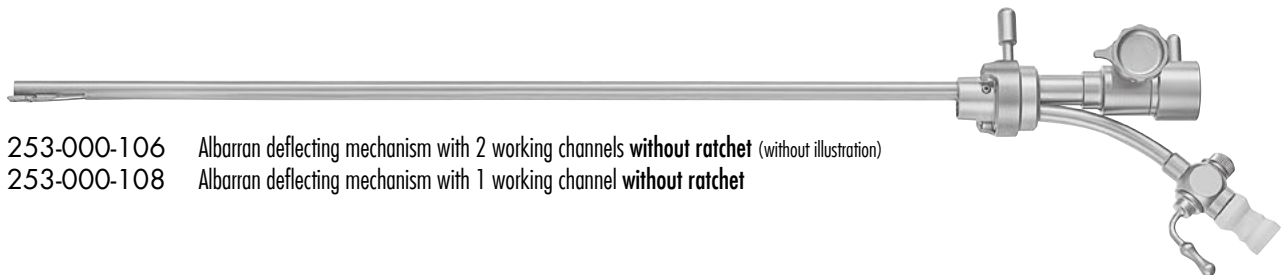

- 253-000-106 Albarran deflecting mechanism with 2 working channels **without ratchet** (without illustration)
- 253-000-108 Albarran deflecting mechanism with 1 working channel **without ratchet**





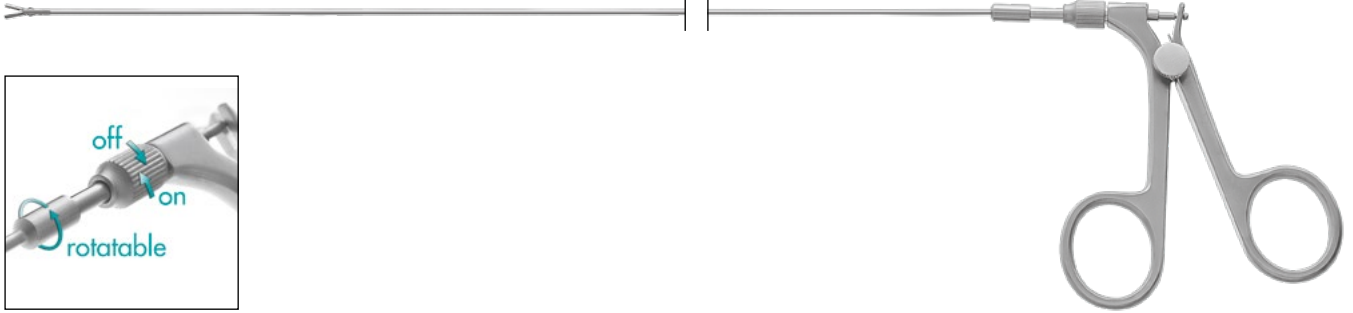

Sheath - Instrument combinations

SHEATHS	COLOR	ALBARRAN		BRIDGE	
		1 working channel	2 working channels	1 working channel	2 working channels
25 Charr.	○	1 x 10 Charr.	2 x 8 Charr.	1 x 12 Charr.	2 x 8 Charr.
22 Charr.	●	1 x 9 Charr.	2 x 6 Charr.	1 x 10 Charr.	2 x 7 Charr.
20 Charr.	●	1 x 6 Charr.	2 x 5 Charr.	1 x 7 Charr.	2 x 6 Charr.
19 Charr.	●	1 x 5 Charr.	2 x 4 Charr.	1 x 6 Charr.	2 x 5 Charr.
17 Charr.	●	-	-	1 x 5 Charr.	-

Flexible Instruments for use with cystoscopes



Working length: 400mm
Rotatable and detachable

	Flexible		Semi-rigid	
 Grasping Forceps, serrated jaws, double action	351-114-105* 5 Charr. 351-114-107* 7 Charr. 351-114-109 9 Charr.		351-114-305 5 Charr. 351-114-307 7 Charr.	
 Biopsy Forceps, oval cup, double action	351-120-105* 5 Charr. 351-120-107* 7 Charr. 351-120-109 9 Charr.		351-120-305 5 Charr. 351-120-307 7 Charr.	
 Serrated Biopsy Forceps, oval cup with aggressive serration, double action	351-124-107 7 Charr.		351-124-307 7 Charr.	
 Scissors, single action	351-100-105* 5 Charr. 351-100-107 7 Charr. 351-100-109 9 Charr.		351-100-305 5 Charr. 351-100-307 7 Charr.	
 DJ Forceps, double action	351-107-107 7 Charr. 351-107-109 9 Charr.		351-107-307 7 Charr.	
 Grasping Forceps, serrated jaw, double action, 730mm working length	253-958-105 5 Charr.			
 Biopsy Forceps, double action, 730mm working length	253-957-105 5 Charr.			

OPTICAL FORCEPS

- for use with \varnothing 4mm Cystoscopes

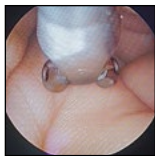
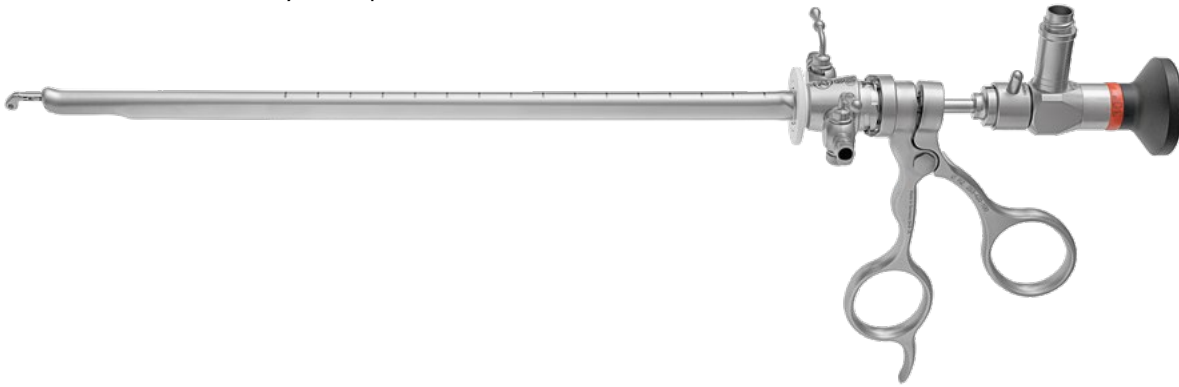

Scope is **below** forceps

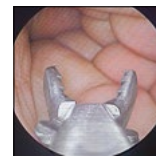

Scope is **above** Forceps



253-420-100*
Spoon Biopsy Forceps with round cup,
double action



253-421-100
Grasping Forceps with serrated jaws,
double action



253-422-100
Biopsy Punch Forceps, thru-cutting,
double action



253-423-100
Scissors, hook type blades,
double action



253-426-100*
Mini Biopsy forceps with oval cup,
double action
for use with 0° cystoscope



253-431-100*
Biopsy forceps with **large** oval cup,
double action
for use with 30° cystoscope



253-425-100
Biopsy forceps with mini oval cup,
double action
for use with 4mm, 70° cystoscope



253-427-100*
Stent Grasping forceps
with serrated jaws, double action
for removal of stents

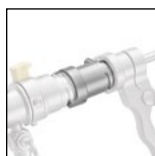

253-429-100* Adapter for use of optical forceps with resectoscope sheaths

FLEXIBLE INSTRUMENTS

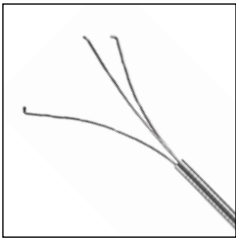

253-940-005 3-Prongs Grasper, flexible, 600mm working length, 5 Charr.

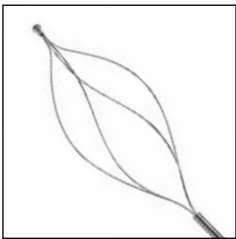

253-585-005 Dormia Metal Stone Basket, flexible, 4 wires, 600mm working length, 5 Charr.

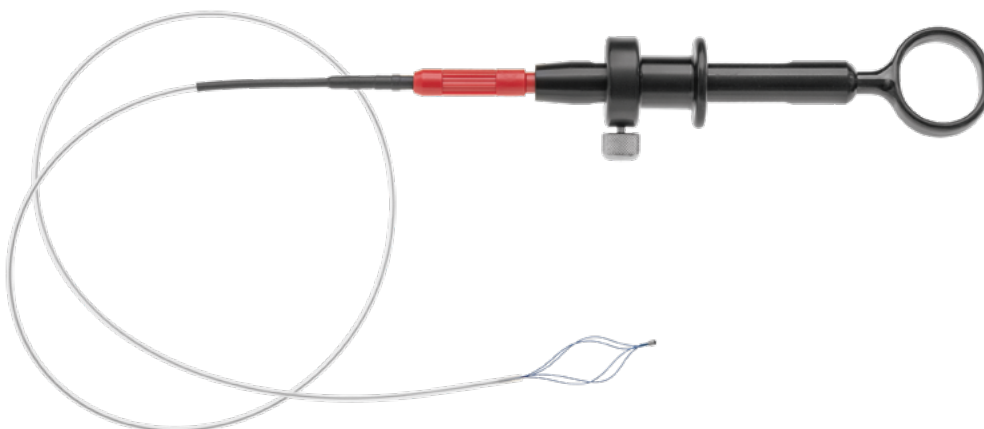

Dormia Nitinol Stone Basket, 600mm working length, 5 Charr.

- 253-581-045 with 4 wires, complete with handle
- 253-582-045 Spare Basket only, 4 wires
- 253-582-055 Spare Basket only, 5 wires
- 253-582-065 Spare Basket only, 6 wires

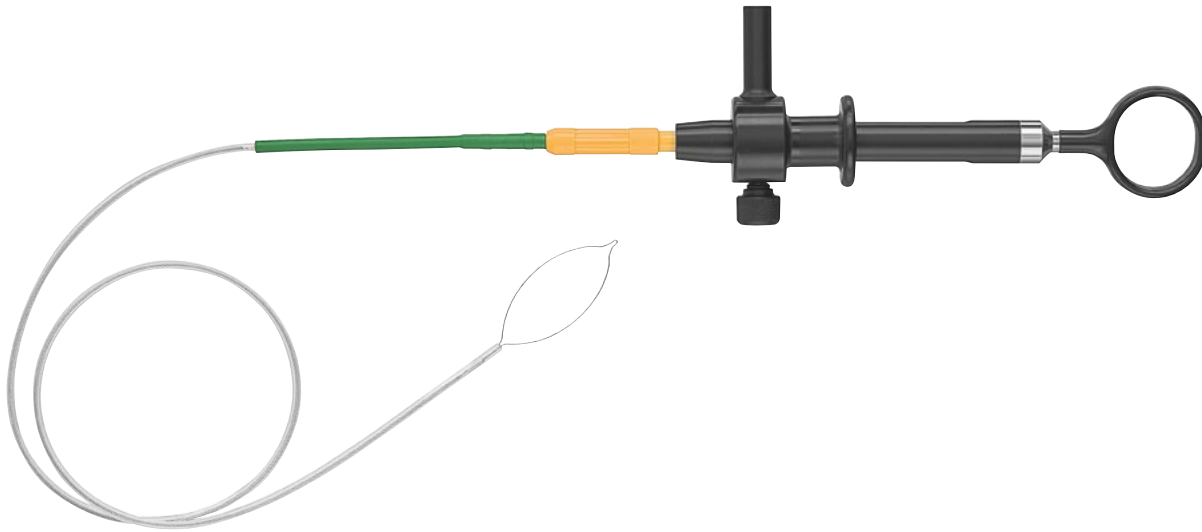

Polyp Snare with teflon tube, 500mm working length with HF connection, 7 Charr.

253-580-007 with handle, complete
253-581-007 Spare Snare only

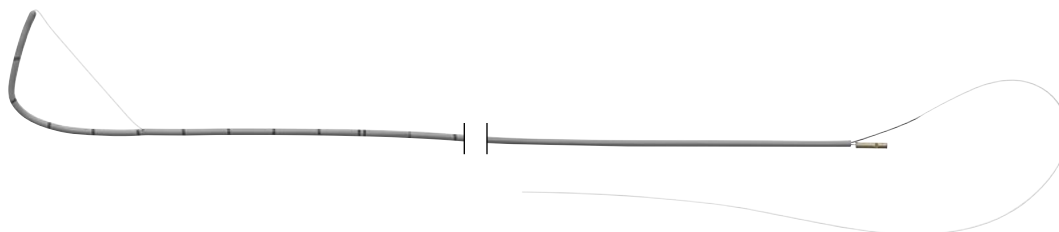

253-584-005 Zeiss Loop Catheter, package with 5 pieces, sterile, single use, 5 Charr.





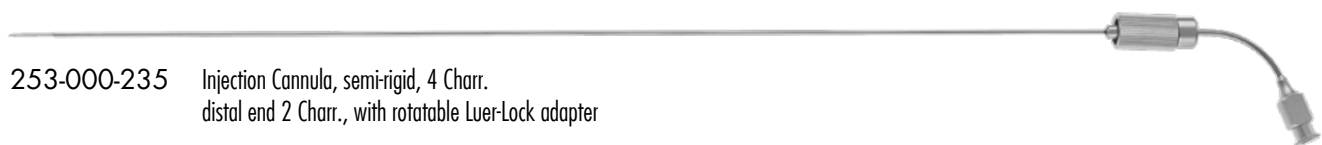

253-000-235 Injection Cannula, semi-rigid, 4 Charr.
distal end 2 Charr., with rotatable Luer-Lock adapter





FLEXIBLE ELECTRODES AND HF CABLES

Ball Electrode, 530mm working length

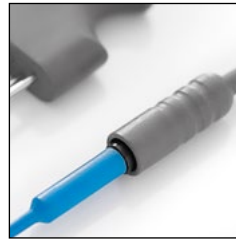
	253-370-003	3 Charr.
	253-370-103	3 Charr., 115mm working length
	253-370-005*	5 Charr.
	253-370-007	7 Charr.
	253-370-010	10 Charr.

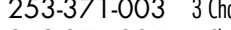

Needle Electrode, 530mm working length

	253-371-003	3 Charr.
	253-371-005	5 Charr.
	253-371-007	7 Charr.

Loop Electrode 530mm working length

	253-372-005	5 Charr.
	253-372-007	7 Charr.



Monopolar High Frequency cables, 4,5mm length

253-610-001*	with 5 mm plug for Erbe HF-unit
253-610-002*	with 4 mm plug for Martin HF-unit
253-610-003*	with 8 mm plug for Valleylab HF-unit
253-610-004*	with 4 mm plug for older HF-units
700-501-453*	SDS plug

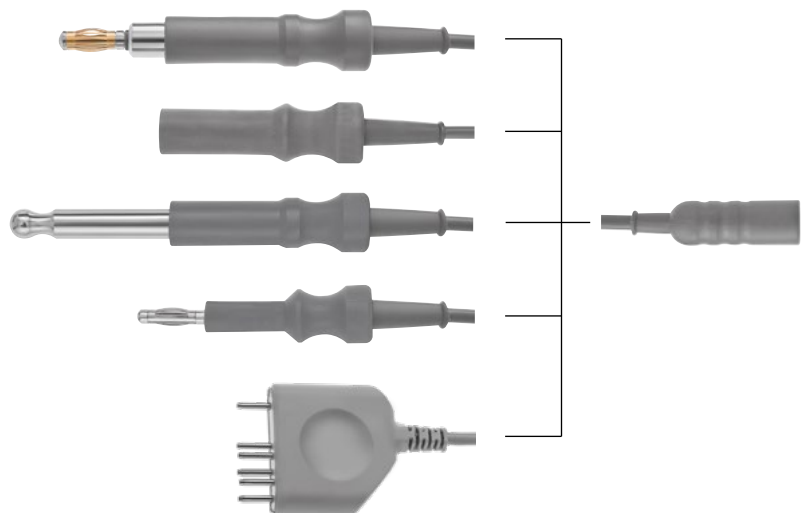

CYSTOSCOPY ACCESSORIES



301-701-100* Grey rubber cap for use on all working channels

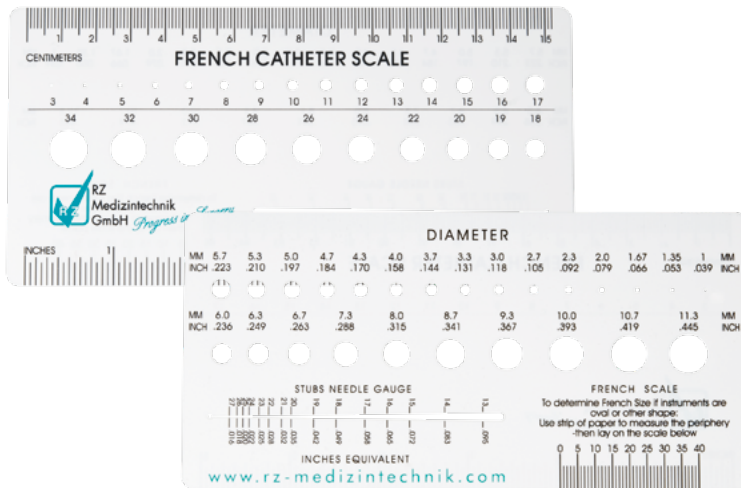

253-990-800 French Catheter Scale



Cleaning Brush, flexible

253-961-103 \varnothing 3mm, 100mm length,
for use in 2.0 - 2.6mm working channels

253-961-102 \varnothing 2.5mm, 120mm length,
for 5 Charr. working channels



300-215-000

Cleaning Brush, \varnothing 13mm, 60mm brush length, 230mm overall length

RESECTOSCOPY

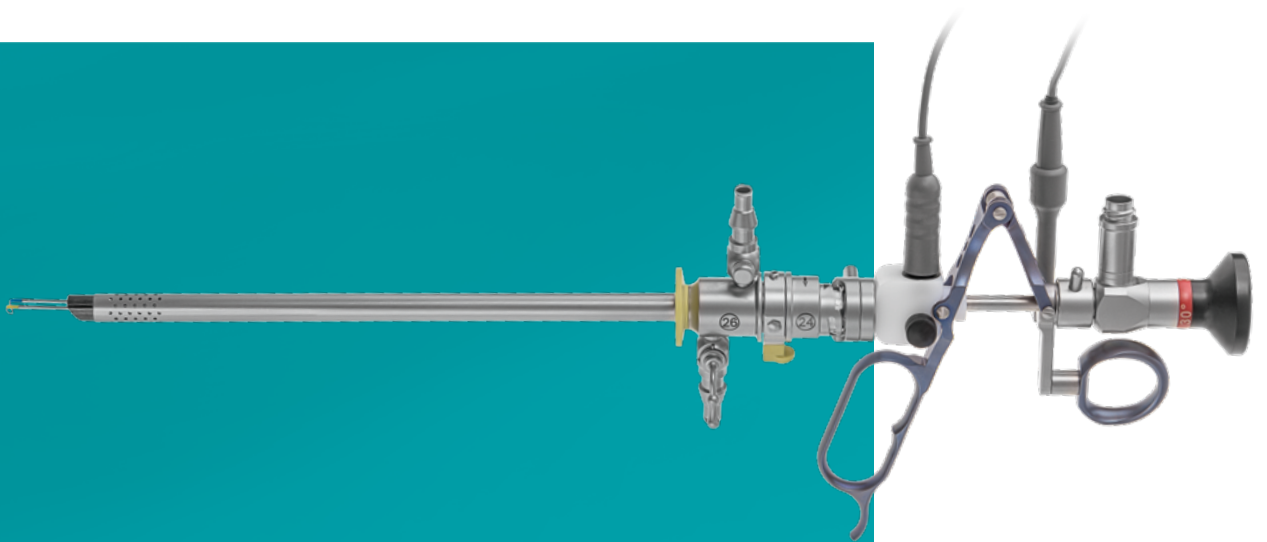

RZ RESECTOSCOPY SETS

Transurethral resection of the prostate (TURP) is a common surgery for BPH (Benign Prostate Hyperplasia). During TURP, the prostate is visualized through the urethra and tissue is removed using electric current. A monopolar or bipolar resectoscope is inserted transurethral and the enlarged prostatic tissue is removed with cutting and sealing electrodes.

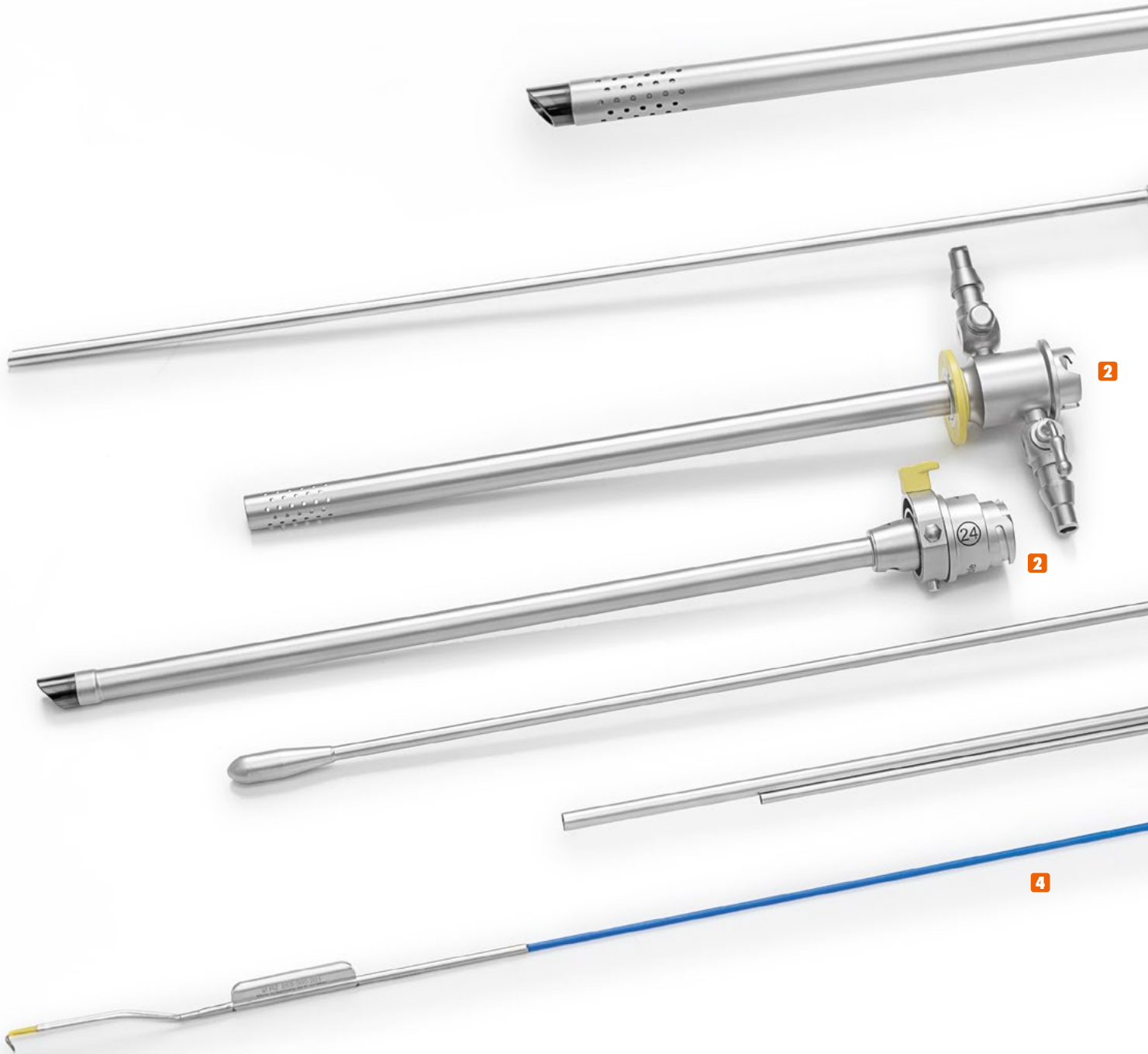

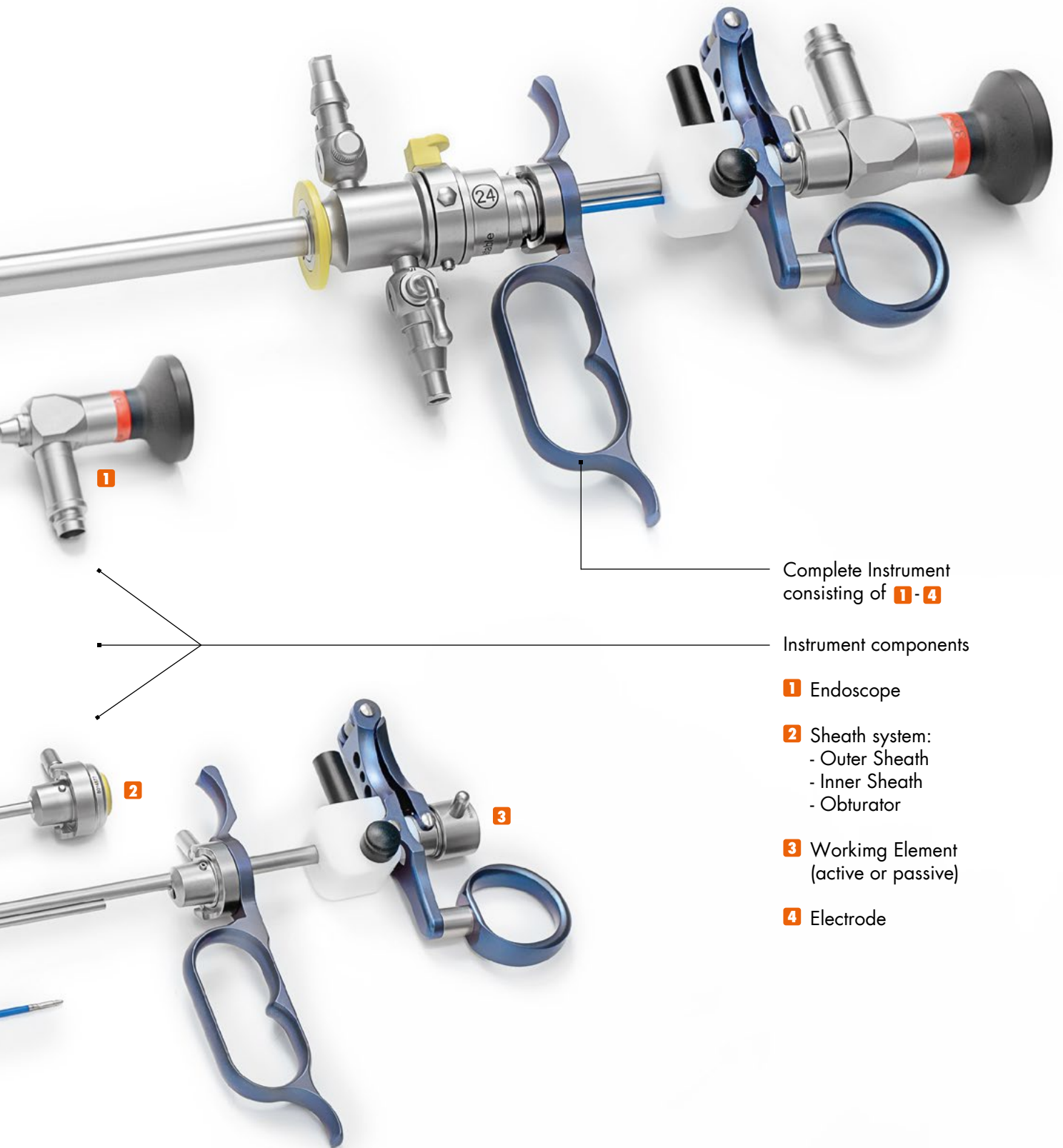

Complete Instrument consisting of **1-4**

Instrument components

- 1** Endoscope
- 2** Sheath system:
 - Outer Sheath
 - Inner Sheath
 - Obturator
- 3** Working Element (active or passive)
- 4** Electrode



RZ **HYBRID** RESECTOSCOPY SYSTEM

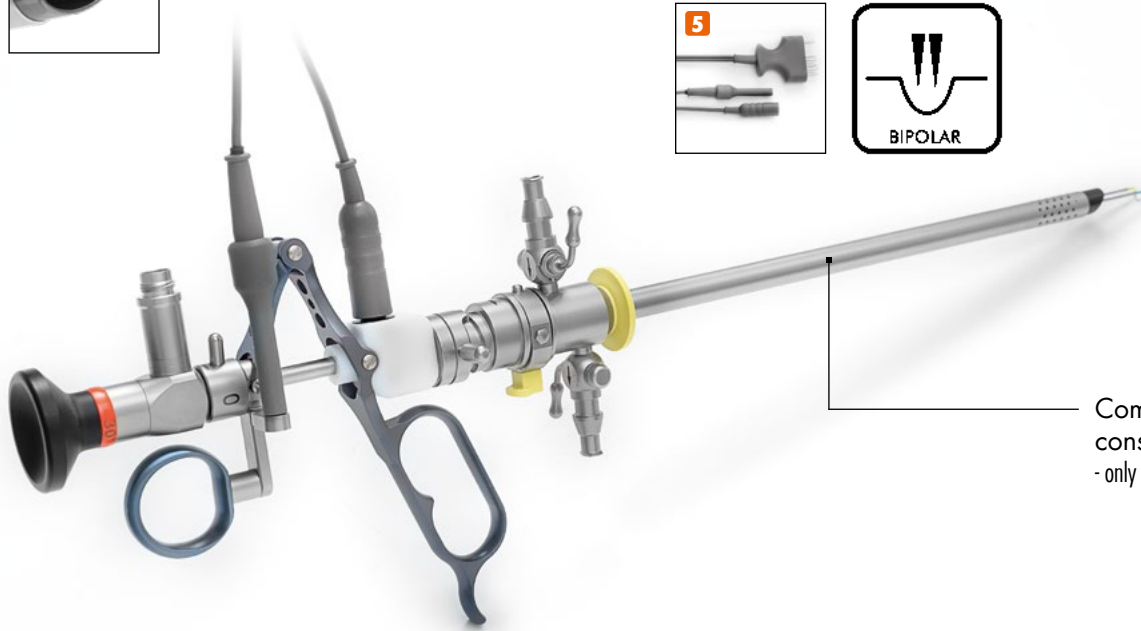
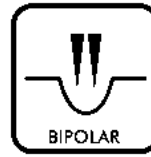

Complete Instrument consisting of **1-5**
- only cable needs to be changed

Instrument components

- 1** Endoscope
- 2** Hybrid Electrode
- 3** Sheath system:
 - Outer Sheath
 - Inner Sheath
 - Obturator
- 4** Working Element (active or passive)
- 5** Monopolar / Bipolar Cable



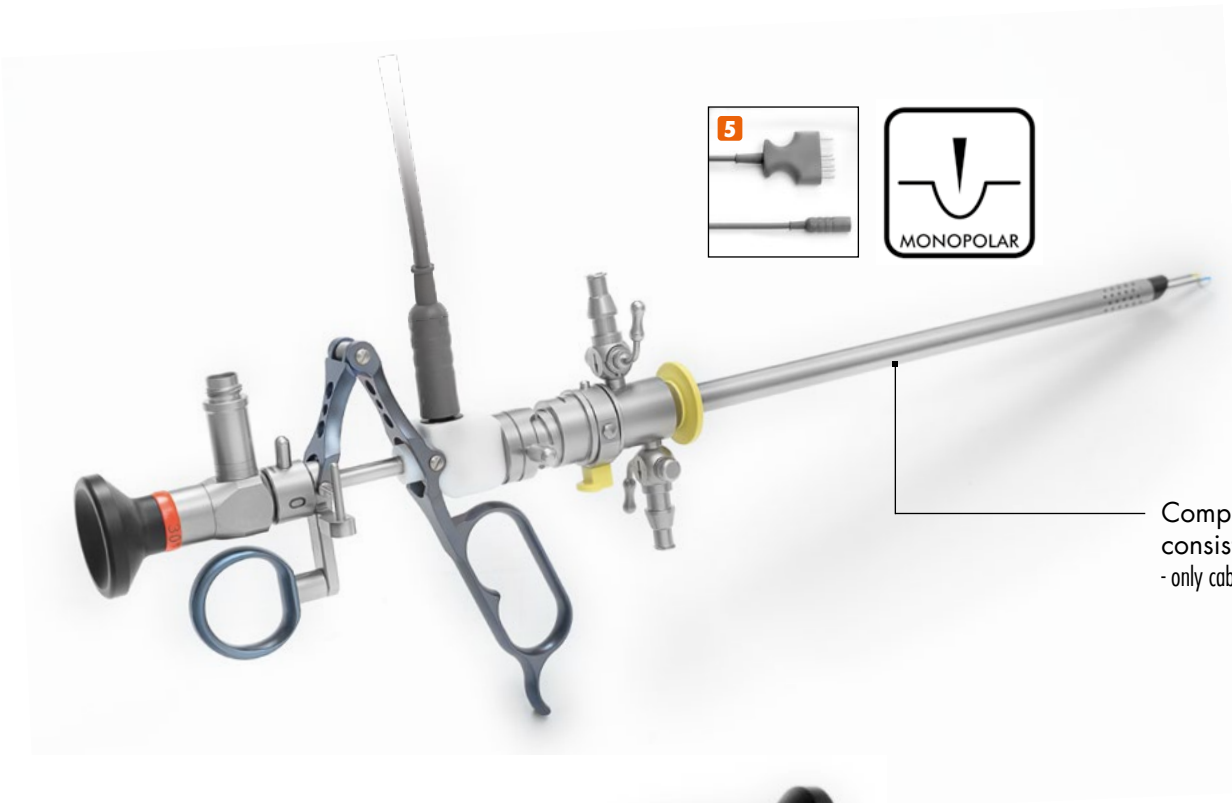

Complete Instrument
consisting of **1-5**
- only cable needs to be changed

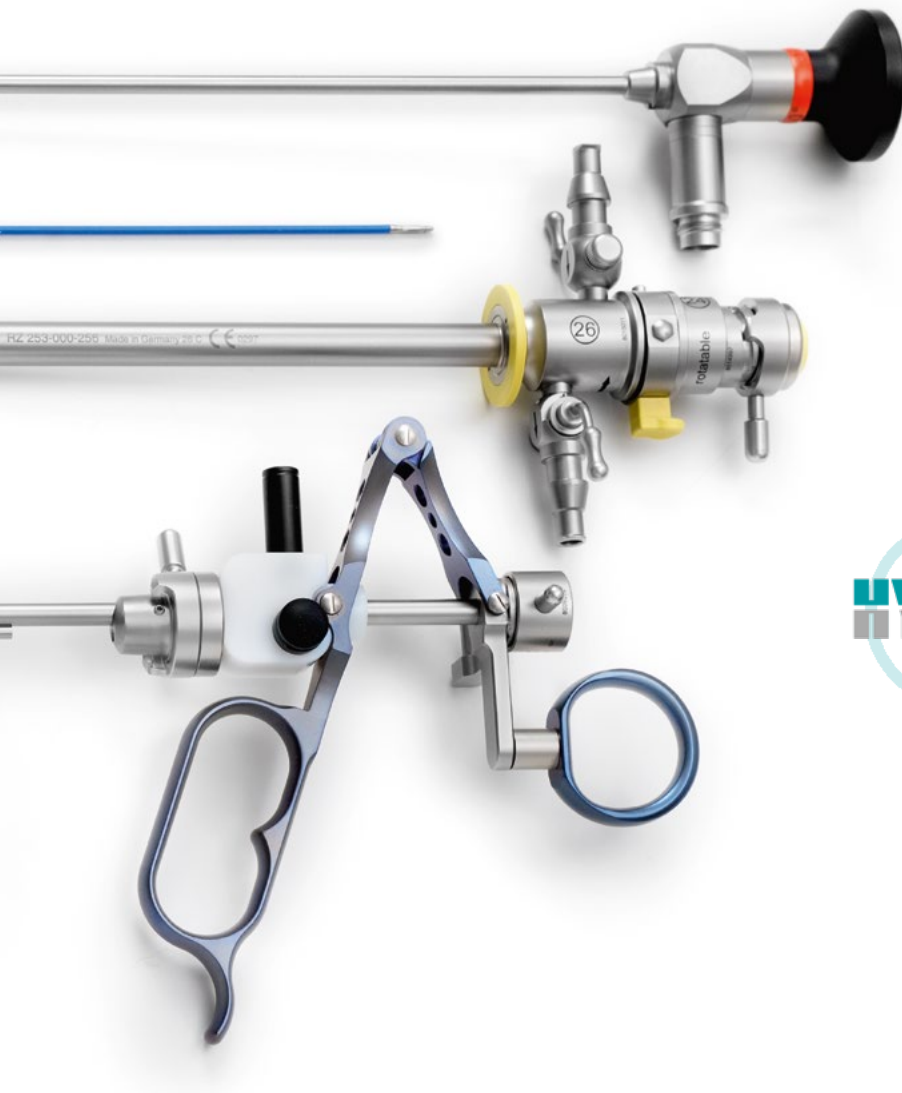

ONE set
TWO techniques

24
CHARR.

Endoscopes, suitable for 24 Charr. System



∅
4 mm

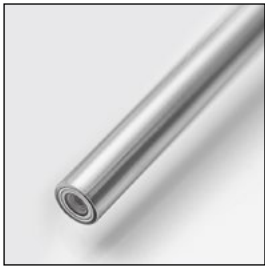

0° DIRECTION OF VIEW

300mm working length
356mm overall length 253-804-000*



12° DIRECTION OF VIEW

300mm working length
356mm overall length 253-804-012*



30° DIRECTION OF VIEW

300mm working length
356mm overall length 253-804-030*



Monopolar working elements suitable for 24 Charr. System

- lightweight, titanium handle parts
- ergonomic handle design with finger rest and rotating titanium thumb ring

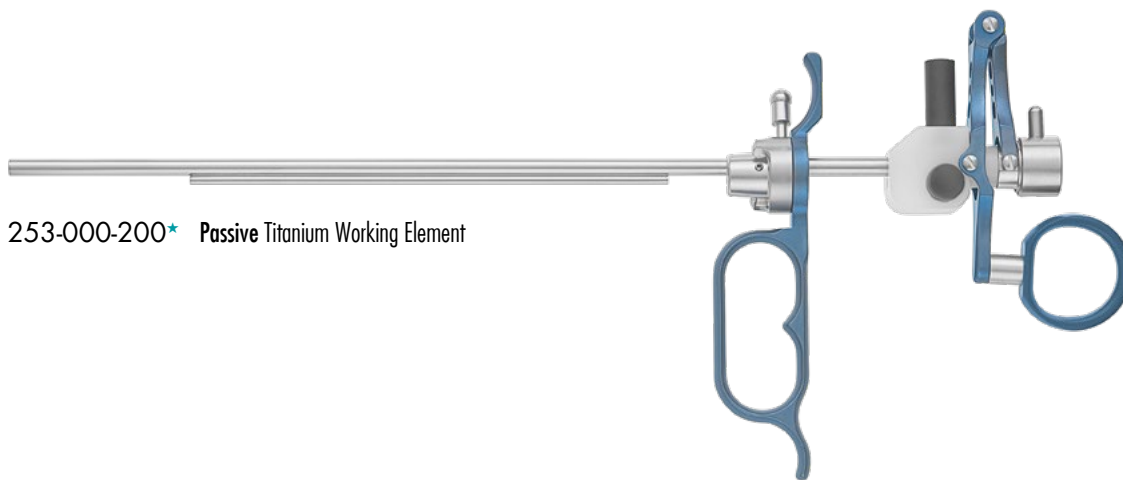

253-000-200* **Passive** Titanium Working Element

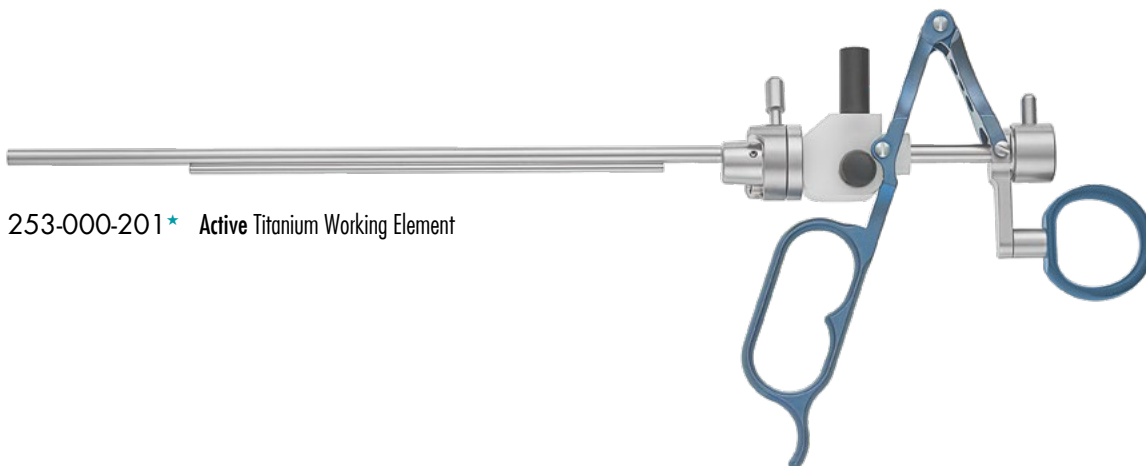

253-000-201* **Active** Titanium Working Element

24
CHARR.

HYBRID
HYBRID



Working elements suitable for HYBRID 24 Charr. system
with bipolar and monopolar cable connection

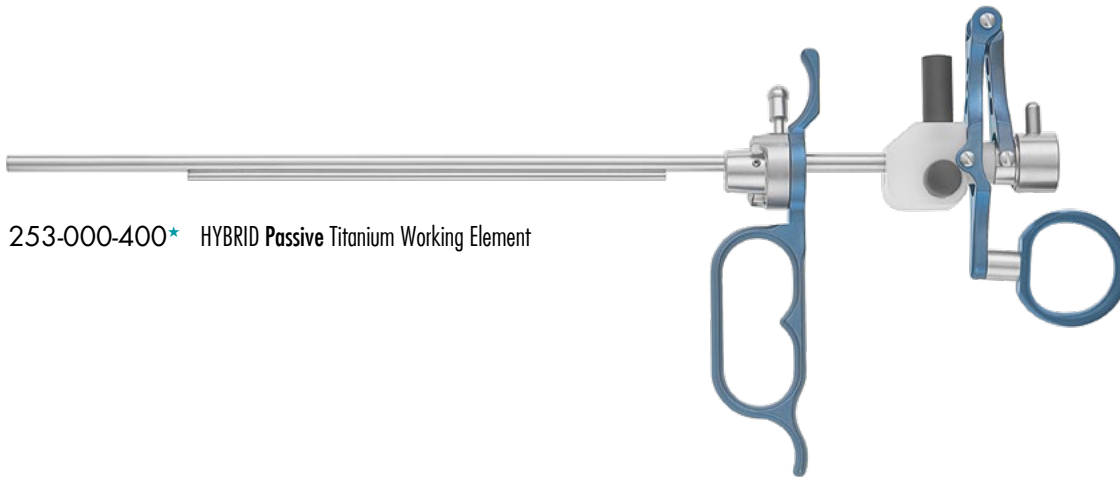

253-000-400* HYBRID Passive Titanium Working Element

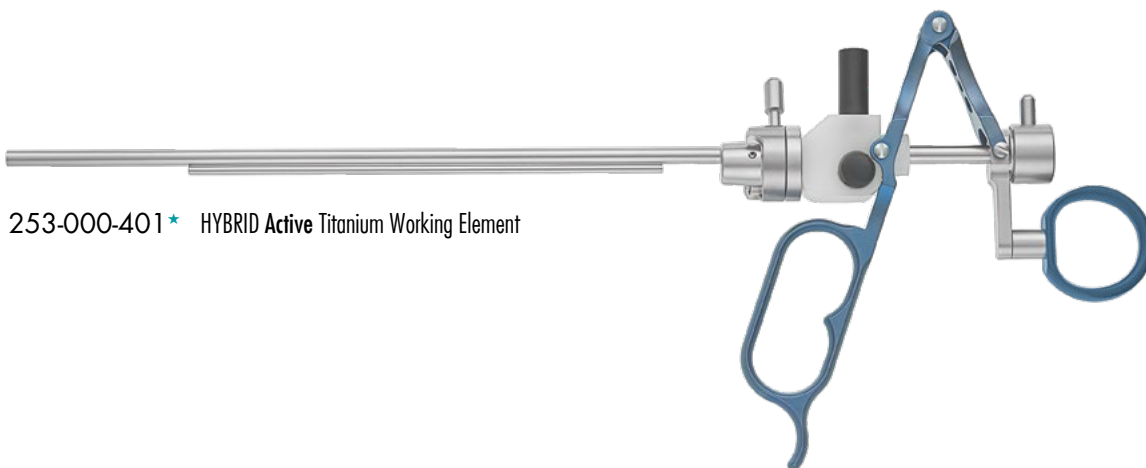

253-000-401* HYBRID Active Titanium Working Element

24
CHARR.

HYBRID



Sheaths, to be used with 24 Charr. system,
monopolar and HYBRID

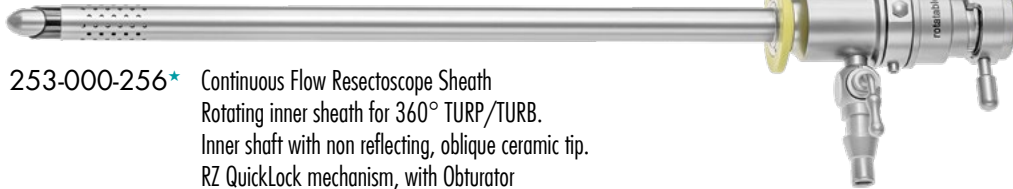

253-000-256* Continuous Flow Resectoscope Sheath
Rotating inner sheath for 360° TURP/TURB.
Inner shaft with non reflecting, oblique ceramic tip.
RZ QuickLock mechanism, with Obturator



253-000-266 Inner Shaft, 24 Charr., with oblique ceramic tip for 253-000-256

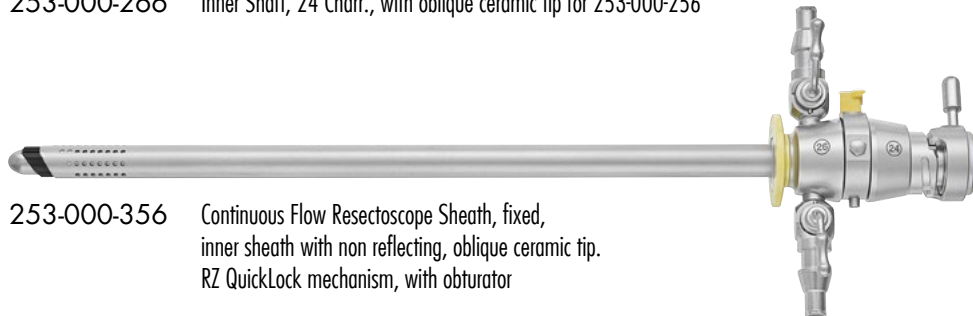

253-000-356 Continuous Flow Resectoscope Sheath, fixed,
inner sheath with non reflecting, oblique ceramic tip.
RZ QuickLock mechanism, with obturator



253-000-366 Inner Shaft with oblique ceramic tip, for 253-000-356

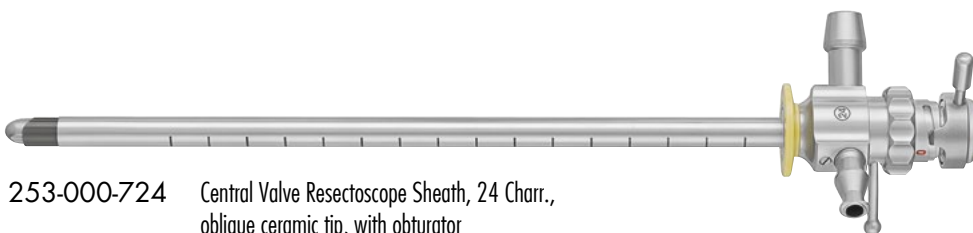

253-000-724 Central Valve Resectoscope Sheath, 24 Charr.,
oblique ceramic tip, with obturator



253-000-524 Resectoscope Sheath, 24 Charr.
oblique ceramic tip, with obturator



253-428-500 Adapter for resectoscope outer sheaths
253-000-256 and -356
and Elik or bladder syringes



Obturator, to be used with 24 Charr. system, monopolar and HYBRID



253-000-044* Standard Obturator, for 24/26 Charr. resectoscope sheaths



253-000-054* Deflecting Obturator, for 24/26 Charr. resectoscope sheaths



253-000-084* Visual Obturator for 4mm RZ Cystoscopes, for 24/26 Charr. resectoscope sheaths



253-000-094* Visual Obturator with 5 Charr. working channel, for 4mm RZ Cystoscopes, for 24/26 Charr. resectoscope sheaths

24
CHARR.



Electrodes, to be used with
24 Charr. system



Cutting Loop, angled, for 12°/30° telescope

253-300-201*



Cutting Loop, 90° angled, for 0° telescope

253-300-222



Cutting Loop, straight in longitudinal direction

253-300-202



Coagulation Electrode, pointed

253-300-203*



Coagulation Electrode, conical

253-300-204



Coagulation Electrode, ball shape, Ø 3mm

253-300-205*



Coagulation Electrode, ball shape, Ø 5mm

253-300-206*



Coagulation Electrode, roller shape, Ø 3mm

253-300-207









Coagulation Electrode, roller shape, Ø 5mm

253-300-208



Electrodes, to be used with
24 Charr. system

	Spike Electrode, Ø 3mm		253-300-210
	Spike Electrode, Ø 5mm		253-300-209
	Roller-Electrode, Ø 3mm		253-300-212
	Roller-Electrode, Ø 5mm		253-300-211
	Band Vapor Electrode, 1.2 mm width		253-300-213
	Band Vapor Electrode, 90° angled		253-300-214
	Band Vapor Electrode		253-300-215
	Curette, sharp, for use without HF		253-300-218
	Needle Electrode		253-300-219

24
CHARR.



Sterile disposable Electrodes,
to be used with 24 Charr. system



STERILE EO

Sales unit: package with 6 pieces,
each individually sterile packed.



Cutting Loop, angled, for 12°/30° telescope

253-300-201S*



Collins knife electrode

253-300-203S*



Ball electrode, Ø 3mm

253-300-205S*



Ball electrode, Ø 5mm

253-300-206S*

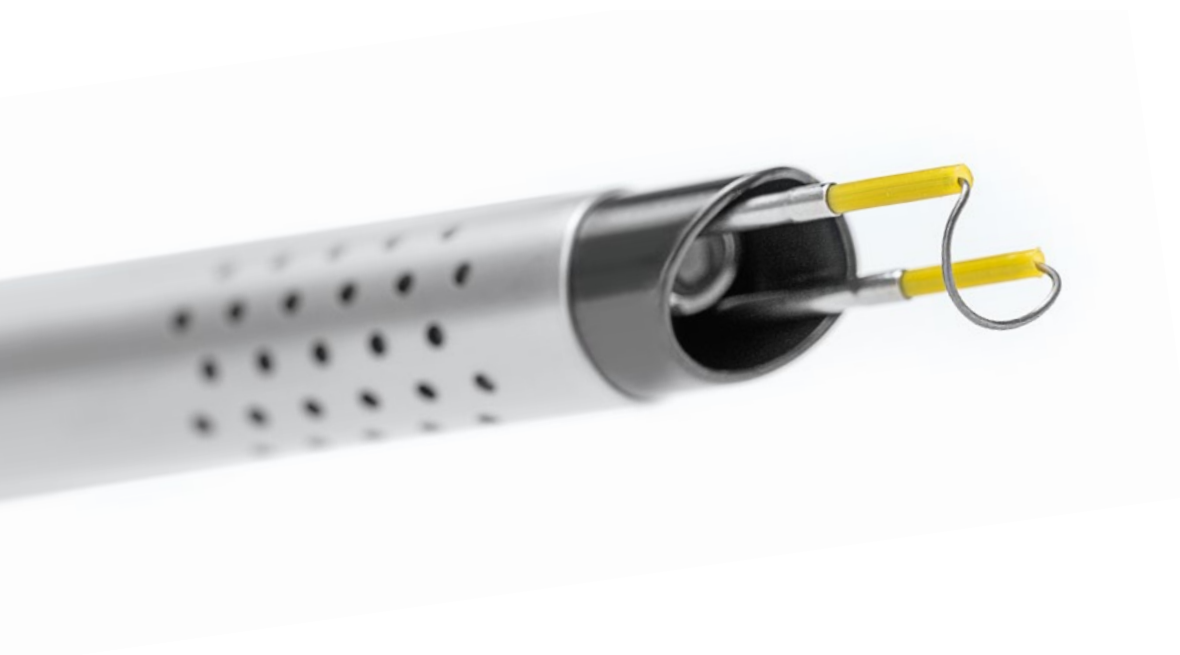

24
CHARR.

HYBRID
HYBRID



HYBRID Electrodes, to be used with 24 Charr. system

- works in bipolar and monopolar mode
- made of a standard wire of \varnothing 0.35mm



Cutting Loop, angled, for 12°/30° telescope

253-400-200



Cutting Loop, angled, for 12°/30° telescope

253-400-201*



Cutting Loop, thick wire, angled, for 12°/30° telescope

253-400-202



Collins Coagulation Electrode, pointed

253-400-203*



Coagulation Electrode, conical

253-400-204



Coagulation Electrode, ball shape, \varnothing 3mm

253-400-205*



Roller-Electrode, \varnothing 3mm

253-400-211



Cutting Loop, 90° angled, for 0° telescope

253-400-222



Coagulation Electrode, ball shape, \varnothing 5mm

253-400-206

24
CHARR.

HYBRID
HYBRID



HYBRID „Mushroom“ Electrodes, to be used with 24 Charr. system, only for bipolar use with NaCl



„Mushroom“ Electrode, blunt/flat

253-400-701

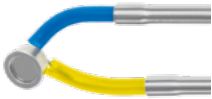

„Mushroom“ Electrode, blunt with slot, concave

253-400-702

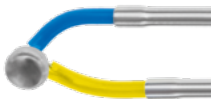

„Mushroom“ Electrode, half-round (convex), Ø 3mm, length 1.9mm

253-400-703

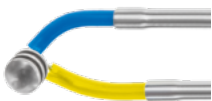

„Mushroom“ Electrode, half-round (convex), Ø 3mm, length 2.5mm

253-400-704

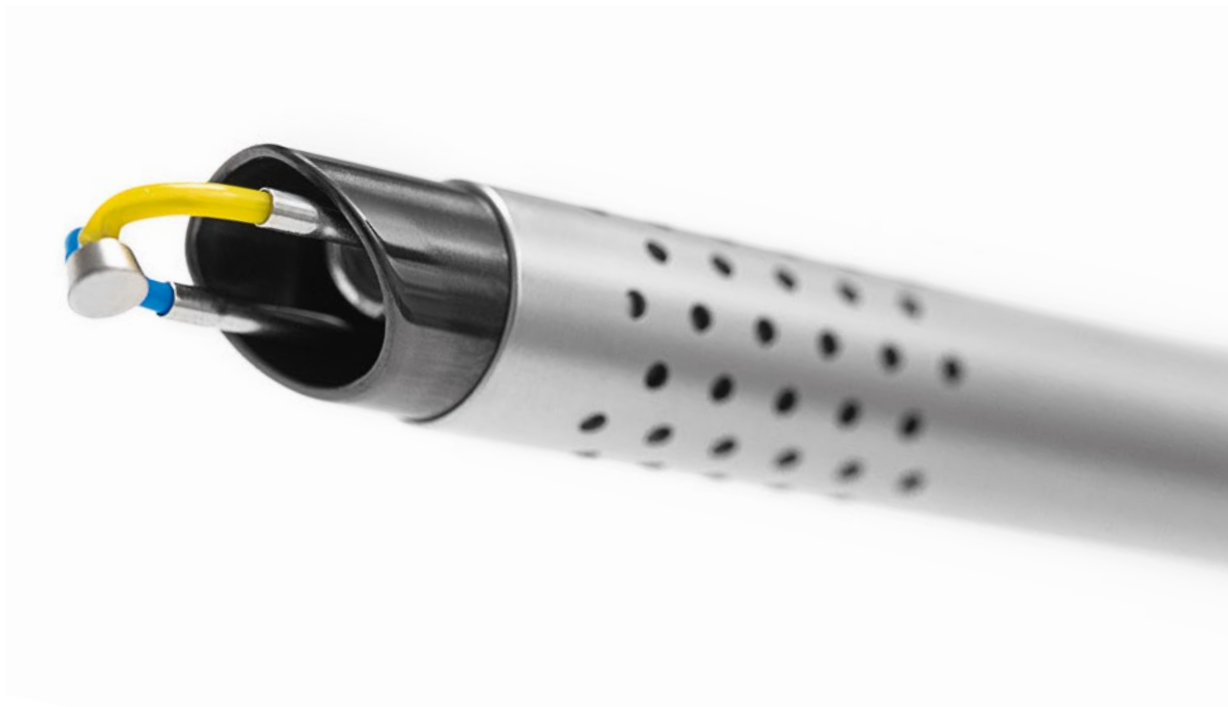

24
CHARR.



XL RESECTOSCOPE

◀ 245mm working length ▶



253-804-530 XL Cystoscope, Ø 4mm, 30° direction of view, 365mm length

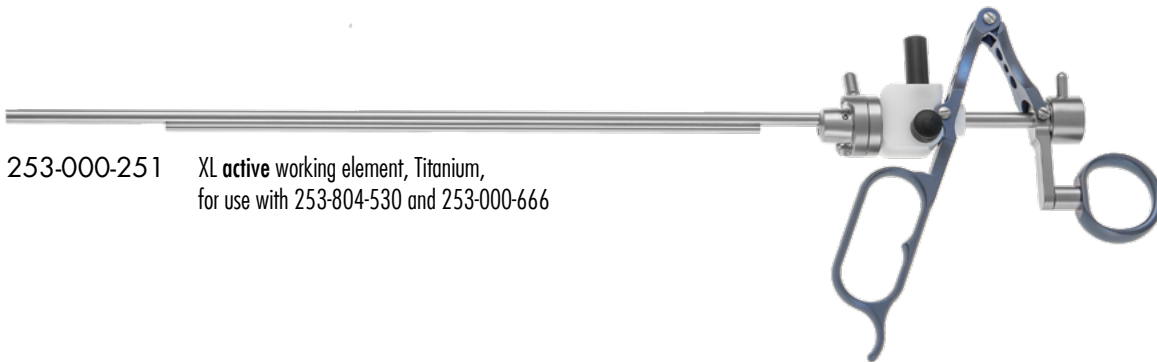

253-000-251 XL active working element, Titanium, for use with 253-804-530 and 253-000-666

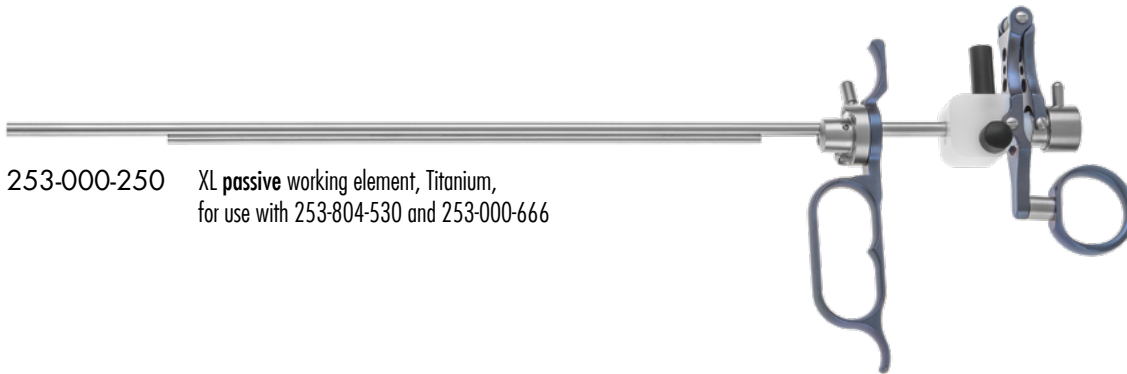



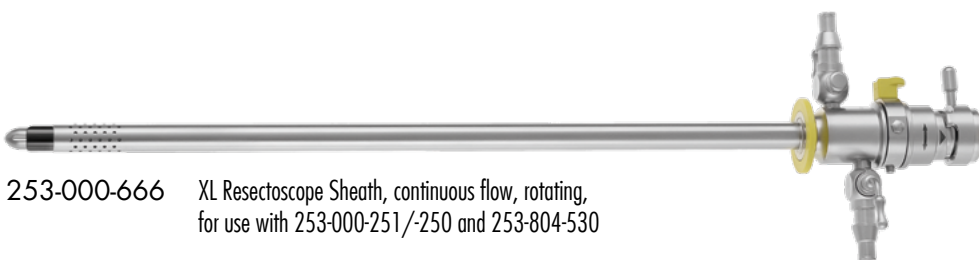



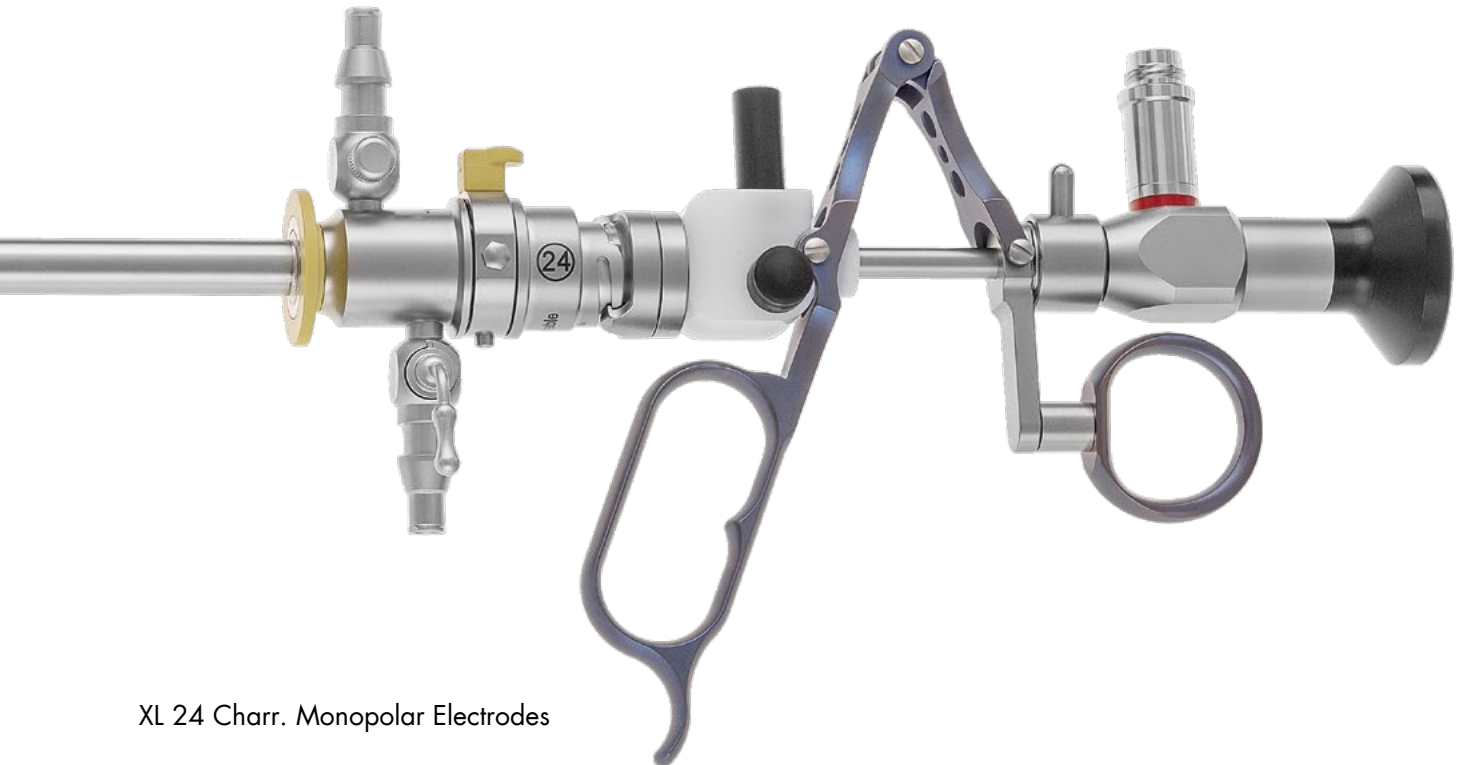

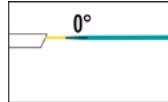

253-000-250 XL passive working element, Titanium, for use with 253-804-530 and 253-000-666

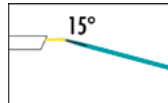

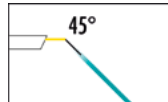
253-000-666 XL Resectoscope Sheath, continuous flow, rotating, for use with 253-000-251/-250 and 253-804-530

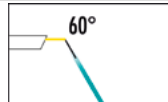

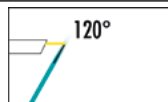
XL 24 Charr. Monopolar Electrodes

	Cutting Loop, straight		253-300-252
	Cutting Loop, 15° angled		253-300-253
	Cutting Loop, 45° angled		253-300-255
	Cutting Loop, 60° angled		253-300-256
	Cutting Loop, 120° angled		253-300-251
	Roller Electrode		253-300-258
	Kife Electrode		253-300-259

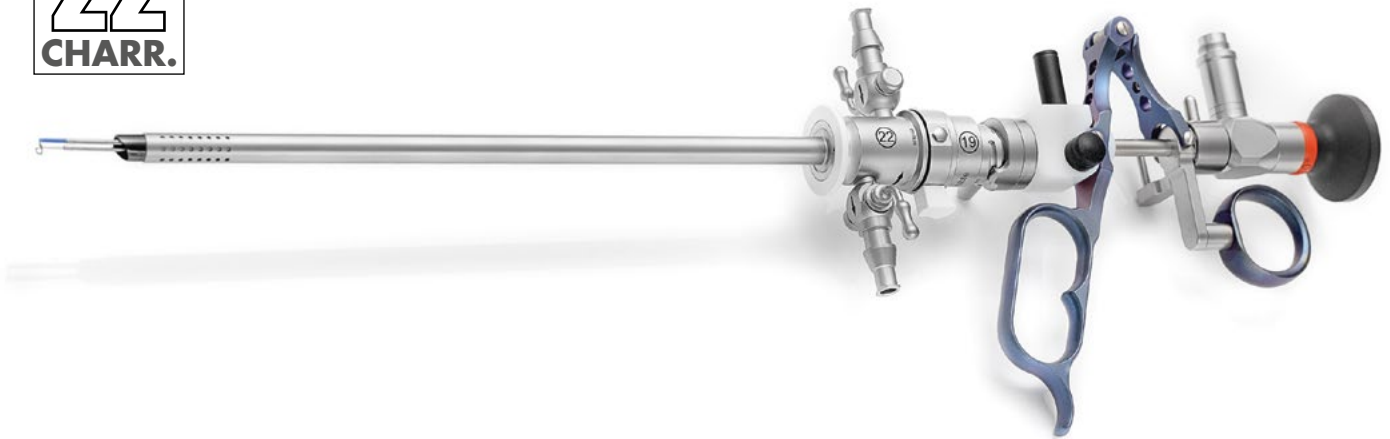

Endoscopes, suitable for HYBRID 22 Charr. System

∅
2.9 mm

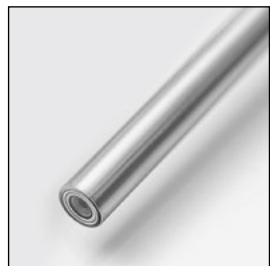

0° DIRECTION OF VIEW

300mm working length
356mm overall length 351-829-000



12° DIRECTION OF VIEW

300mm working length
356mm overall length 351-829-012



30° DIRECTION OF VIEW

300mm working length
356mm overall length 351-829-030



Monopolar Working Elements

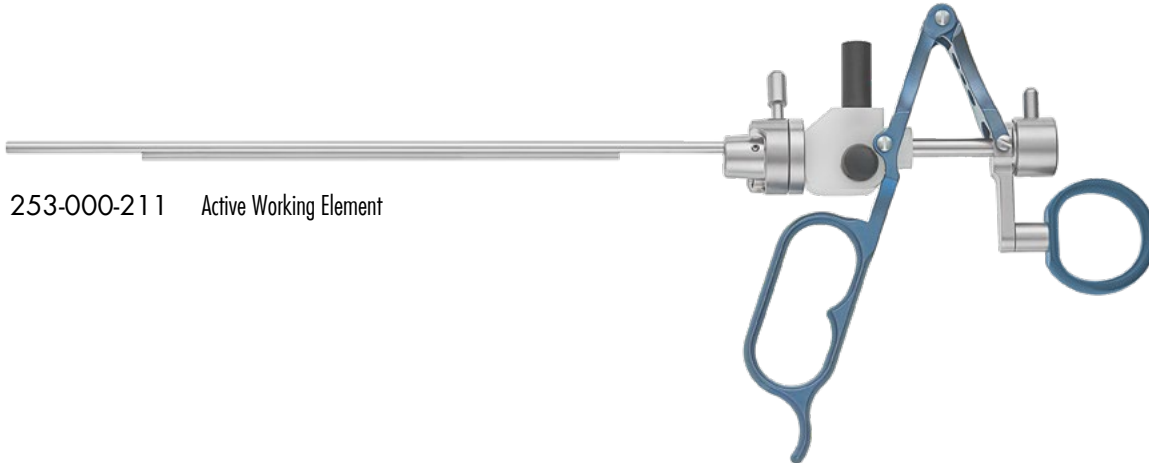
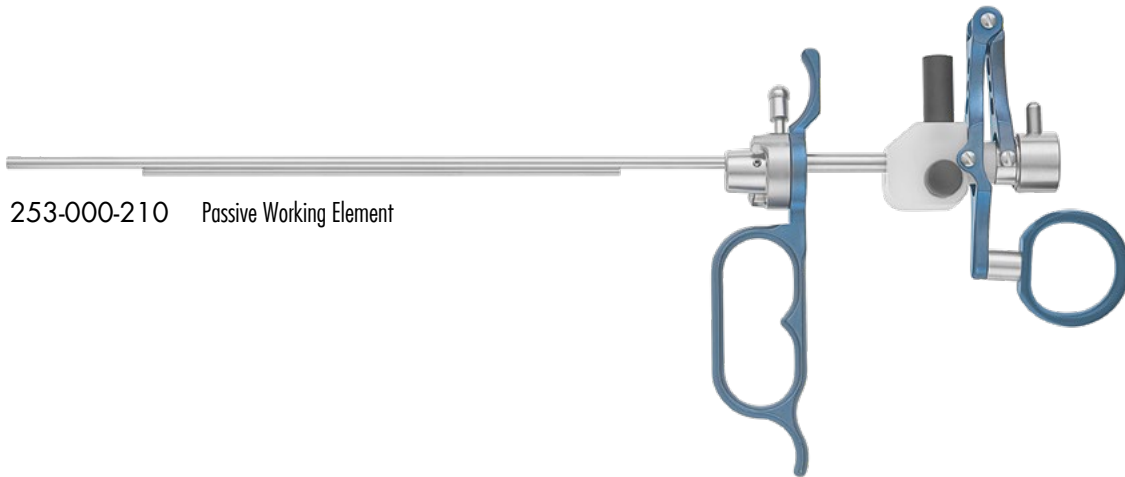

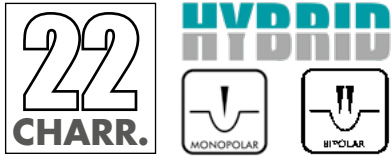

Hybrid Working Elements and Sheath suitable for HYBRID 22 Charr. System

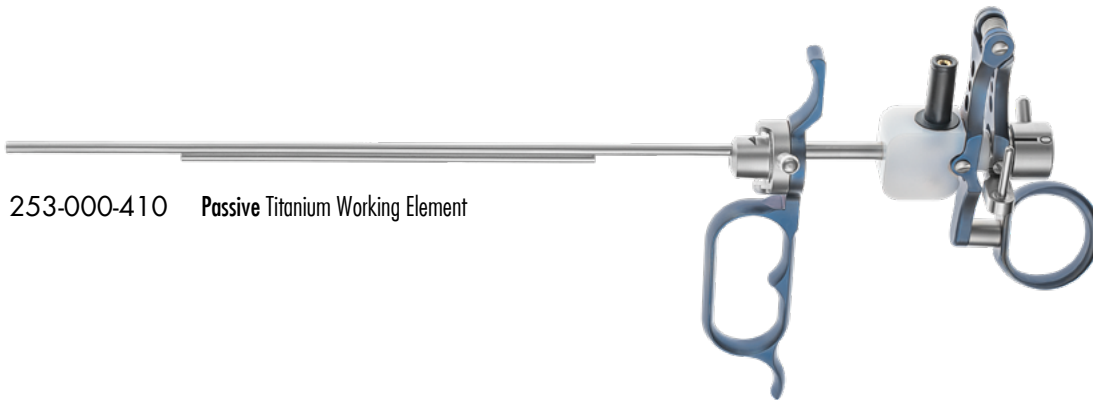

253-000-410 **Passive** Titanium Working Element

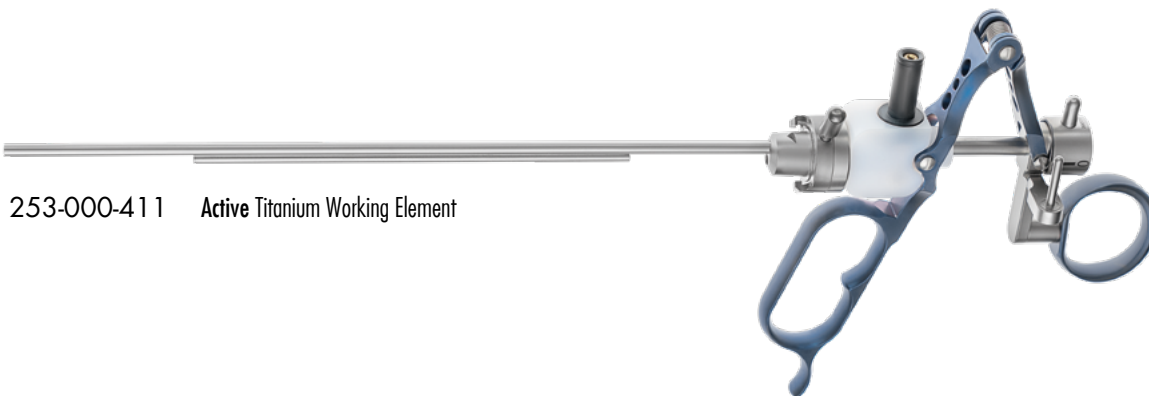

253-000-411 **Active** Titanium Working Element

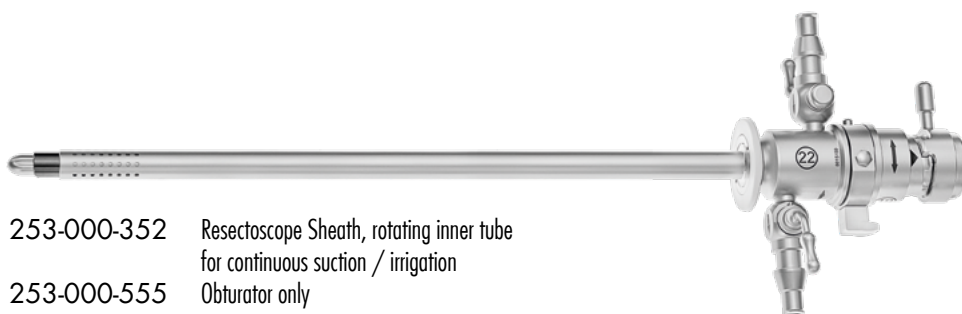





253-000-352 Resectoscope Sheath, rotating inner tube for continuous suction / irrigation







253-000-555 Obturator only



Monopolar Electrodes, suitable for HYBRID 22 Charr. System

	Cutting Loop, angled	253-000-501
	Cutting Loop, straight	253-000-502
	Coagulation Electrode, Knife	253-000-503
	Coagulation Electrode, Ball	253-000-505
	Coagulation Electrode, Roller	253-000-507

Electrodes, suitable for HYBRID 22 Charr. System

		
	Cutting Loop, 30° angled	253-000-541
	Cutting loop, straight	253-000-542
	Knife Electrode	253-000-543
	Ball Electrode	253-000-545
	Roller Electrode, Ø 3mm	253-000-547

18.5
CHARR.

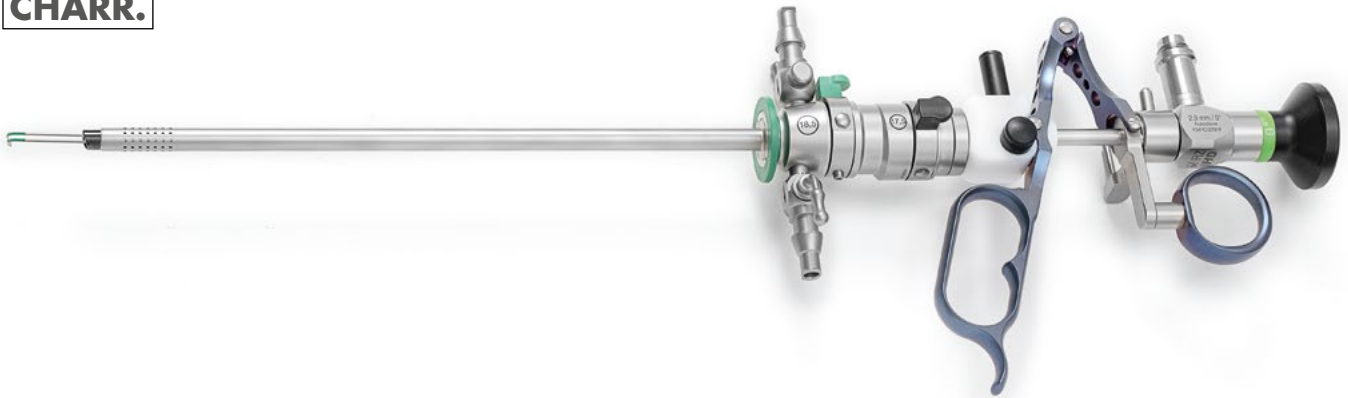

Endoscopes, suitable for HYBRID 18.5 Charr. System

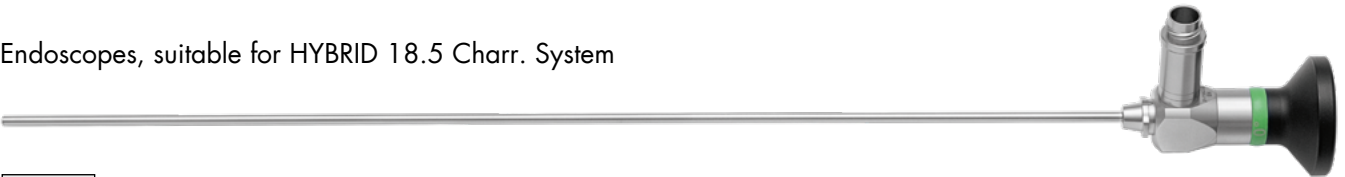

∅
2.9 mm

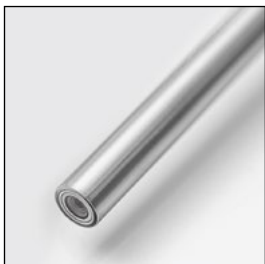

0° DIRECTION OF VIEW

300mm working length
356mm overall length 351-829-000



12° DIRECTION OF VIEW

300mm working length
356mm overall length 351-829-012



30° DIRECTION OF VIEW

300mm working length
356mm overall length 351-829-030



Working Elements and Sheaths,
suitable for HYBRID 18.5 Charr. System



351-400-200 Passive Titanium Working Element



351-400-201 Active Titanium Working Element

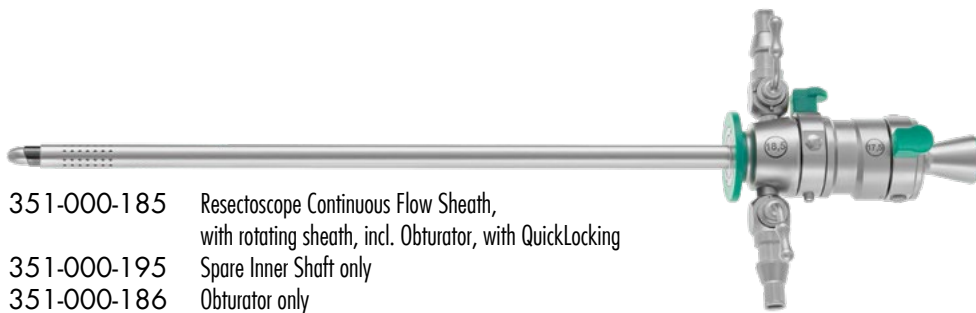

351-000-185 Resectoscope Continuous Flow Sheath,
with rotating sheath, incl. Obturator, with QuickLocking
351-000-195 Spare Inner Shaft only
351-000-186 Obturator only

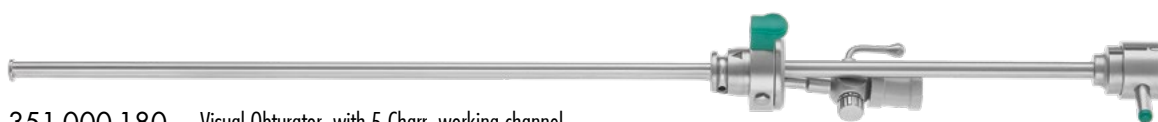

351-000-180 Visual Obturator, with 5 Charr. working channel



Electrodes, 16 Charr., suitable for HYBRID 18.5 Charr. System



Cutting Loop

351-000-201



Cutting loop, straight

351-000-202



Cutting loop, straight

351-000-203



Ball Electrode

351-000-205



Roller Electrode, 2mm

351-000-206



HIGH FREQUENCY CABLES for RZ resectoscope systems, 4.5m length



253-610-001* with 5 mm plug for Erbe HF-unit

253-610-002* with 4 mm plug for Martin HF-unit

253-610-003* with 8 mm plug for Valleylab HF-unit

253-610-004* with 4 mm plug for older HF-units

700-501-453* SDS plug

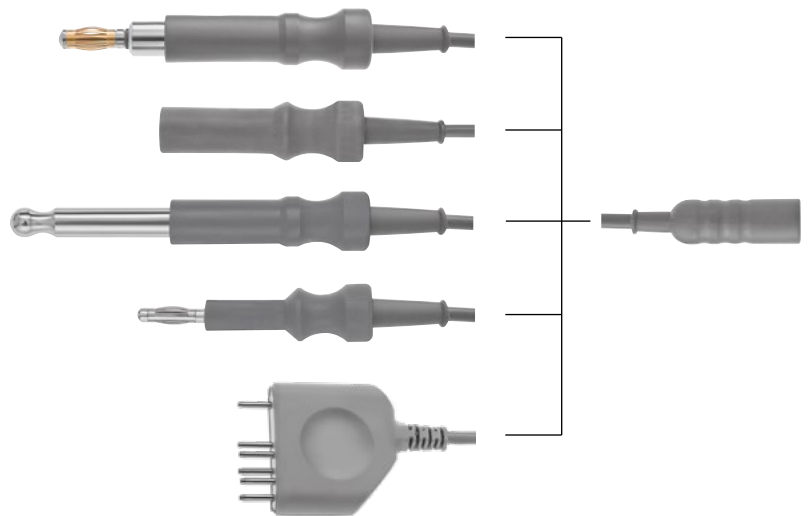

253-400-601 for Erbe HF-unit

253-400-602 for Martin HF-unit

700-500-453 SDS plug

253-400-606 for BOWA

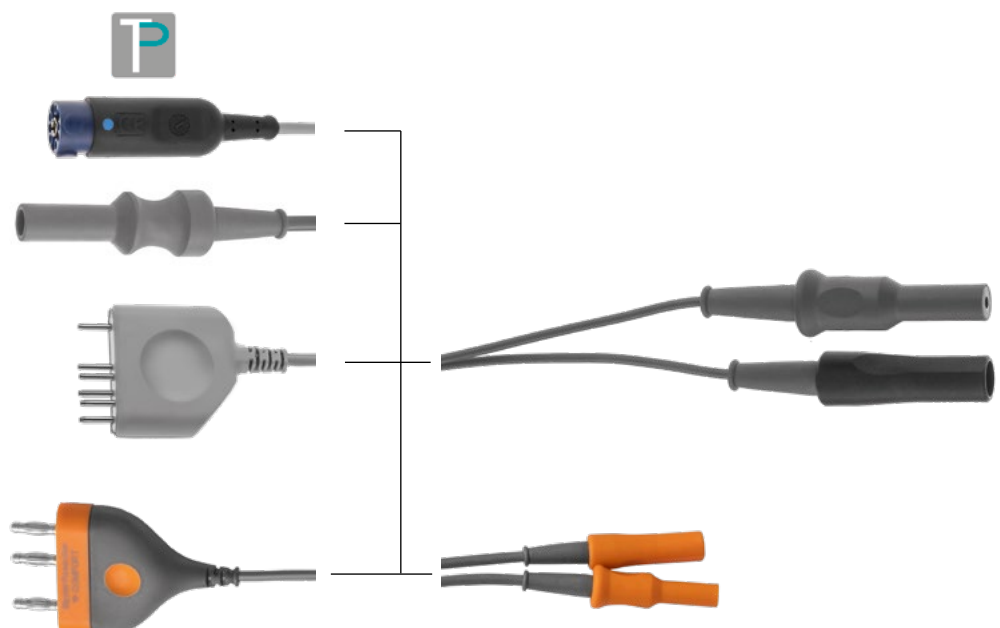

SUPRAPUBIC TROCAR SET

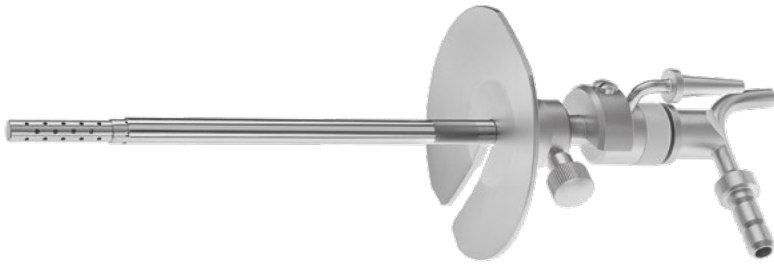

253-400-501 Trocar Sheath, 16 Charr., with pressure channel and spare silicone sealings



253-400-503 Suprapubic Trocar with pyramidal tip



253-400-504 Suprapubic Trocar with cannula tip



253-400-505 Aspiration Cannula



253-400-506 Overflow Cannula



253-400-508 Trocar guide sheath, lateral open

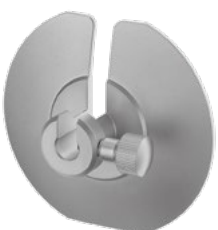

253-400-502 Suprapubic Trocar Stabilizing Plate, lateral open

LASER ENUCLEATION

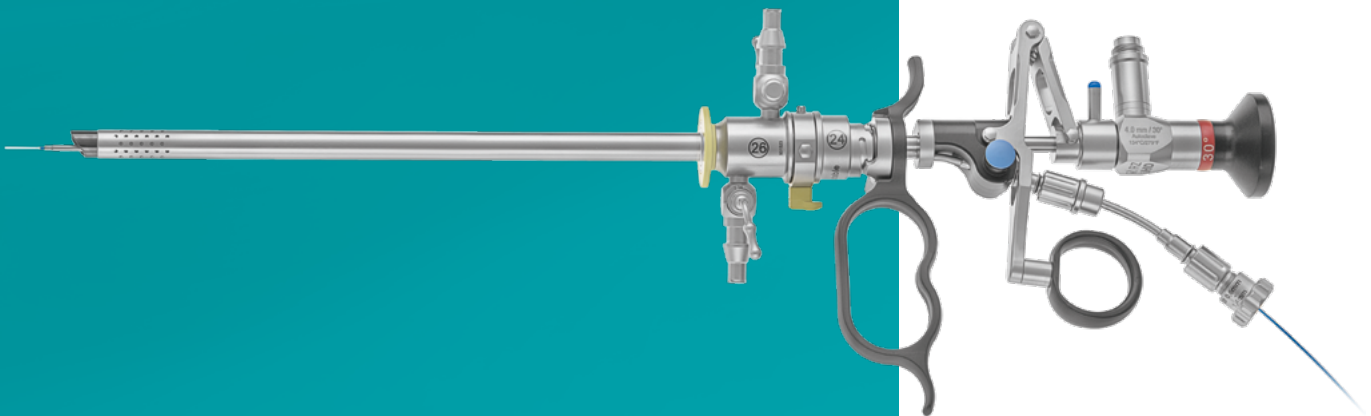

LASER ENUCLEATION

Holmium laser prostate surgery is a minimally invasive treatment for Benign Prostate Hyperplasia (BPH). Laser enucleation of the prostate uses a laser resectoscope to enucleate the prostate tissue that is blocking urine flow. A morcellator which passes through the morcescope is then used to cut the prostate and remove the adenoma.

As with other types of prostate laser surgery, Laser enucleation can offer faster recovery, less risk of bleeding and transfusion and better symptom relief compared to traditional prostate surgery.

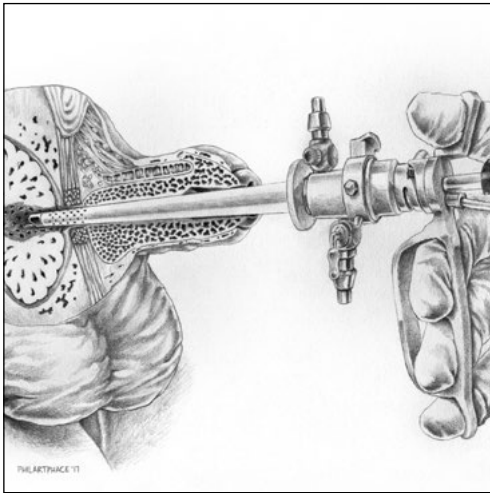

Sheaths for Laser applications
from 26 to 18.5 Charr.



Front Fire Laser resection



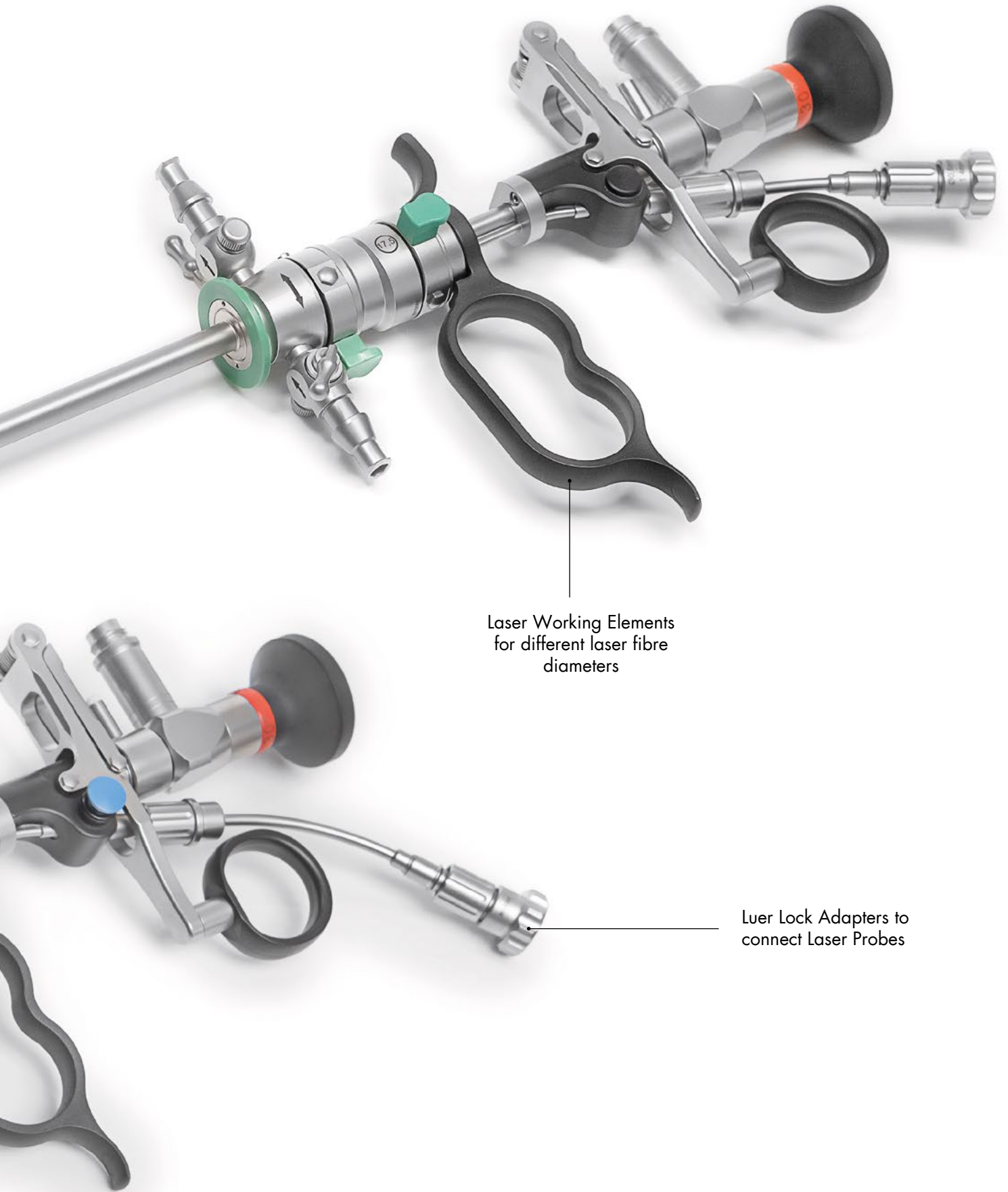

Laser Working Elements
for different laser fibre
diameters

Luer Lock Adapters to
connect Laser Probes

LASER ENUCLEATION SETS FRONT FIRE

HoLEP / ThuLEP / Overview



24
CHARR.

22
CHARR.

18.5
CHARR.



253-804-000 0°
253-804-012 12°
253-804-030 30°



351-829-000 0°
351-829-012 12°
351-829-030 30°



351-829-000 0°
351-829-012 12°
351-829-030 30°

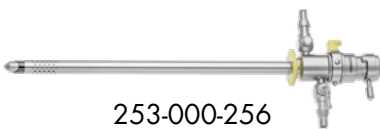

253-000-256

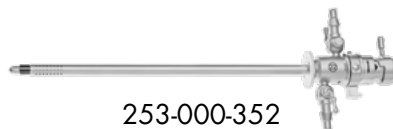

253-000-352

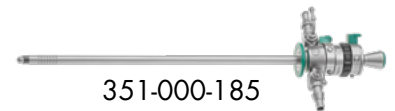

351-000-185

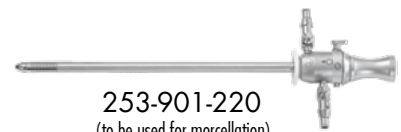

253-901-220
(to be used for morcellation)



253-000-300 fibers up to 0.8mm
253-000-312 fibers up to 1.2mm



253-000-319 fibers up to 0.8mm
253-000-316 fibers up to 1.2mm



253-000-318 fibers up to 0.8mm



253-000-305



253-900-121



253-905-220



253-905-220

24
CHARR.

HoLEP Set

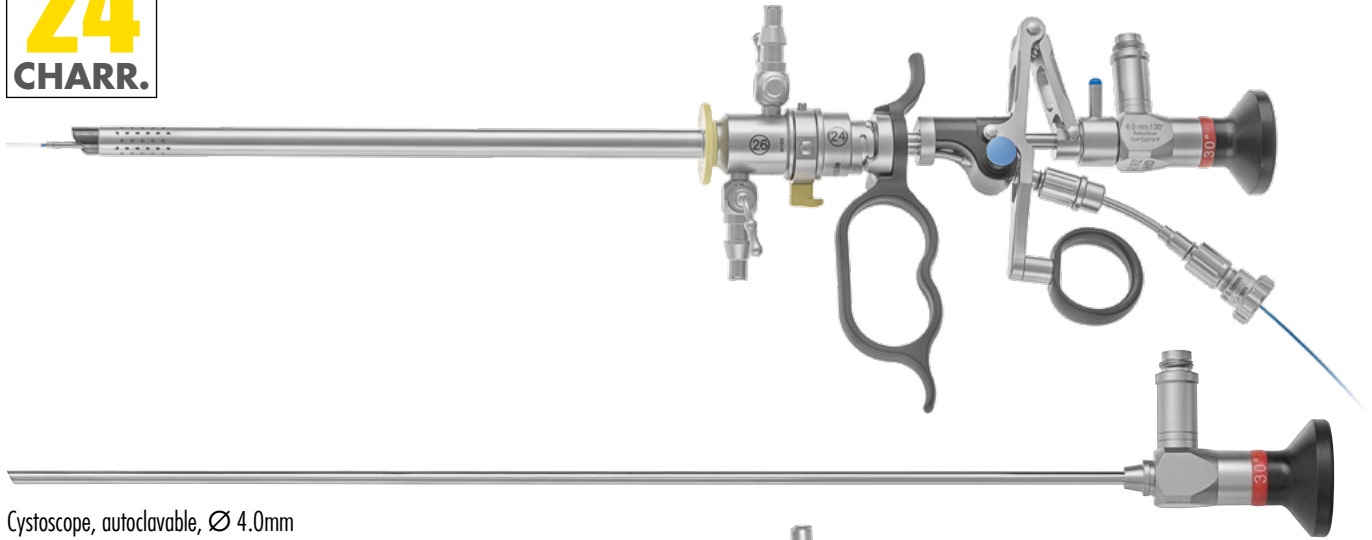

Cystoscope, autoclavable, Ø 4.0mm
 253-804-030 30° direction of view
 253-804-012 12° direction of view

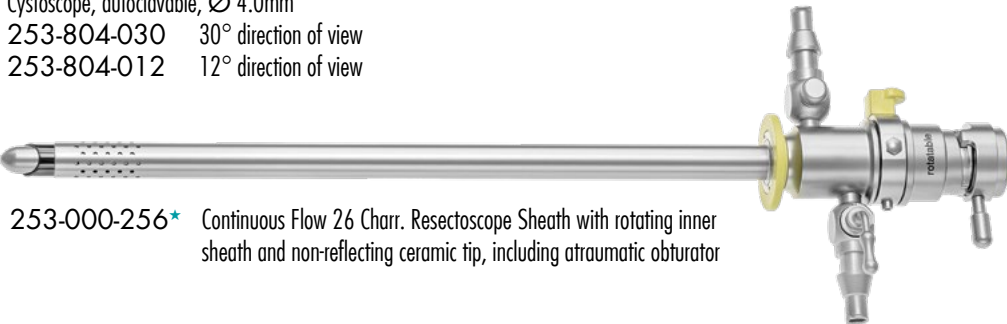

253-000-256* Continuous Flow 26 Charr. Resectoscope Sheath with rotating inner sheath and non-reflecting ceramic tip, including atraumatic obturator



253-000-266 Inner shaft, 24Charr., with oblique ceramic tip for 253-000-256

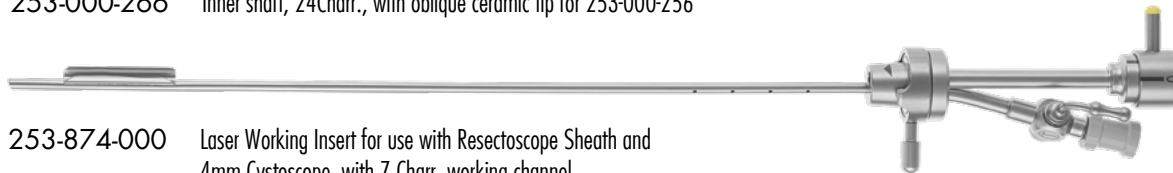

253-874-000 Laser Working Insert for use with Resectoscope Sheath and 4mm Cystoscope, with 7 Charr. working channel



RZ Laser Working Element, passive, for laser-probes
 253-000-300 for fibres up to 0.8mm
 253-000-312* for fibres up to 1.2mm



300-011-184* Luer-Lock Tuohy Borst Adapter (Ø 0.6 - 1.4mm)



RZ LL-Connection, rotatable for use with Laser Probe
 253-000-301* short
 253-000-302 long

24
CHARR.

HoLEP Set

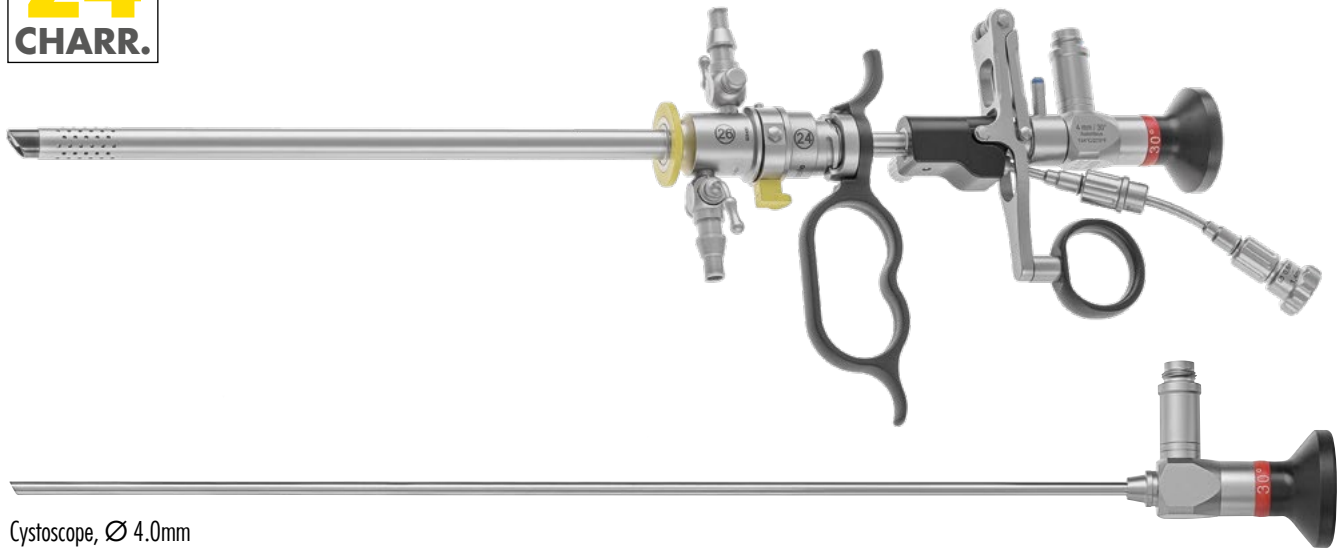

Cystoscope, Ø 4.0mm
 253-804-030 30° direction of view
 253-804-012 12° direction of view

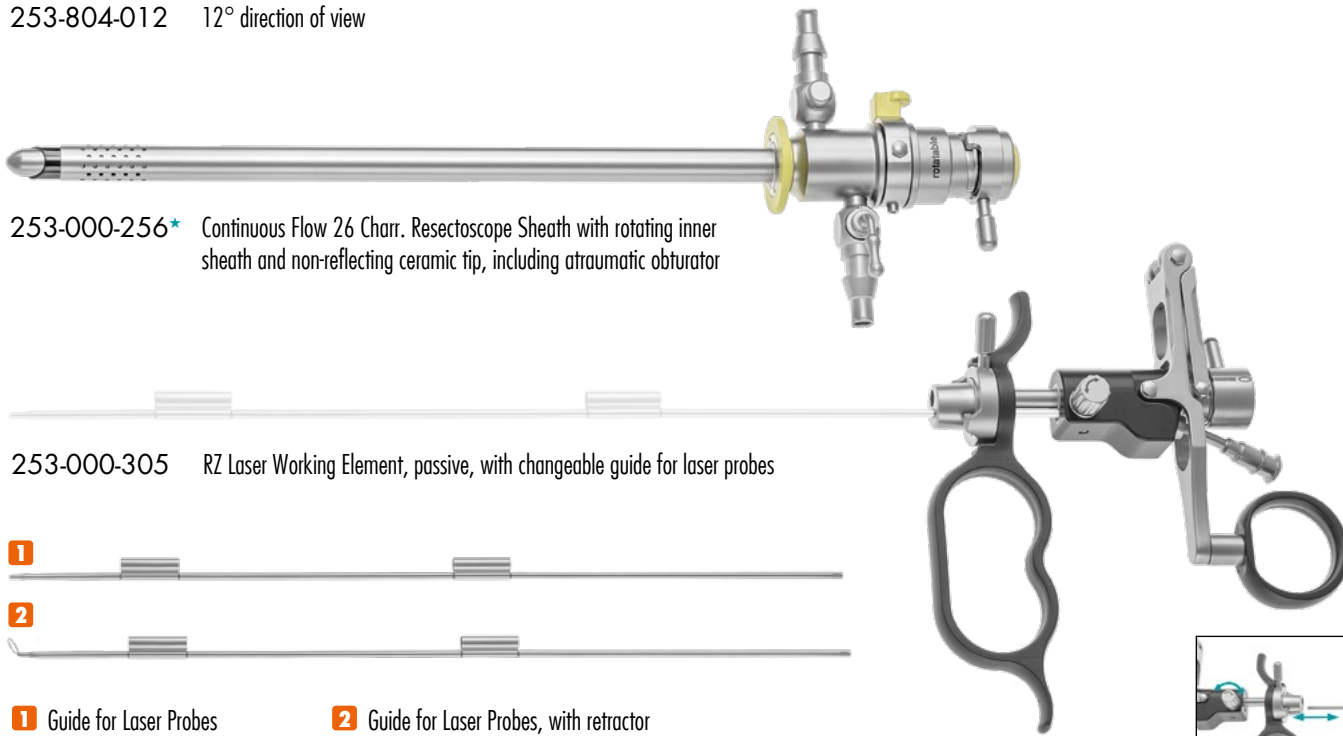

253-000-256* Continuous Flow 26 Charr. Resectoscope Sheath with rotating inner sheath and non-reflecting ceramic tip, including atraumatic obturator

253-000-305 RZ Laser Working Element, passive, with changeable guide for laser probes



1 Guide for Laser Probes	2 Guide for Laser Probes, with retractor
253-000-320 0.8mm	253-000-330 0.8mm
253-000-321 1.0mm	253-000-331 1.0mm
253-000-322 1.2mm	253-000-332 1.2mm
253-000-323 1.4mm	253-000-333 1.4mm

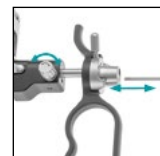

detachable



300-011-184* Luer-Lock Tuohy Borst Adapter (Ø 0.6 - 1.4mm)



(253-000-302)

RZ LL-Connection, rotatable for use with Laser Probe
 253-000-301* short
 253-000-302 long

24
CHARR.

XL Laser Resection

◀ 245mm working length ▶

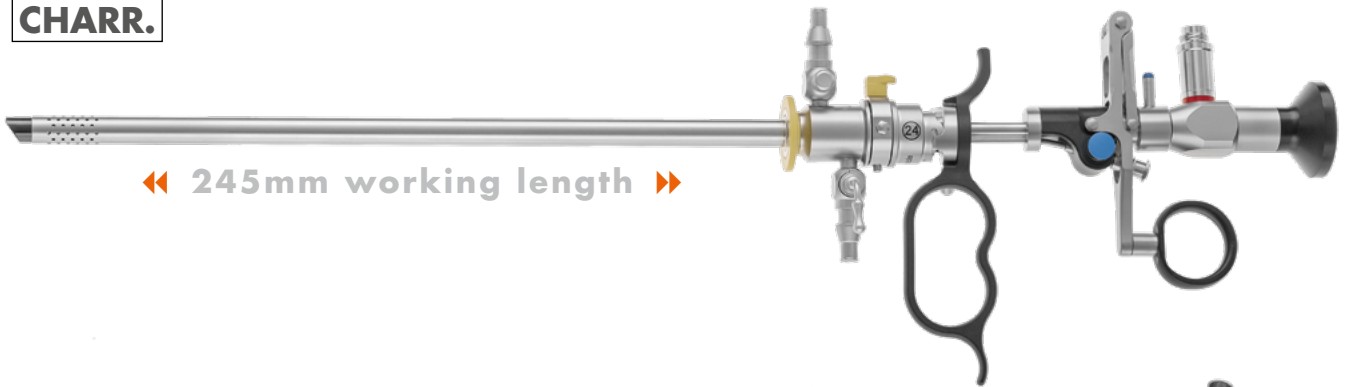

253-804-530 XL Cystoscope, Ø 4mm, 30° direction of view, 365mm length



253-000-666 XL Resectoscope Sheath, continuous flow, rotating, for use with 253-000-251/-250 and 253-804-530

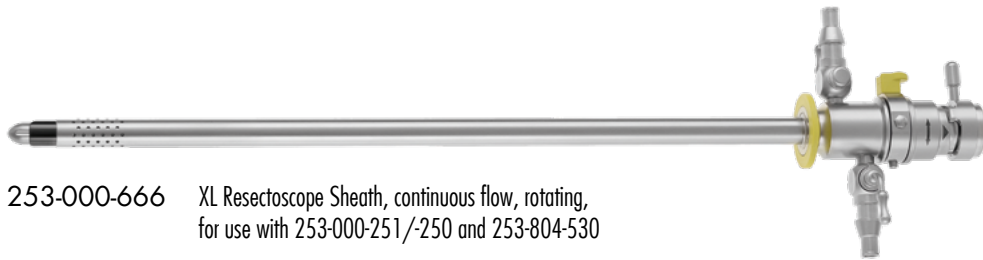

253-000-350 XL Laser Working Element for fibers Ø1.2mm, passive

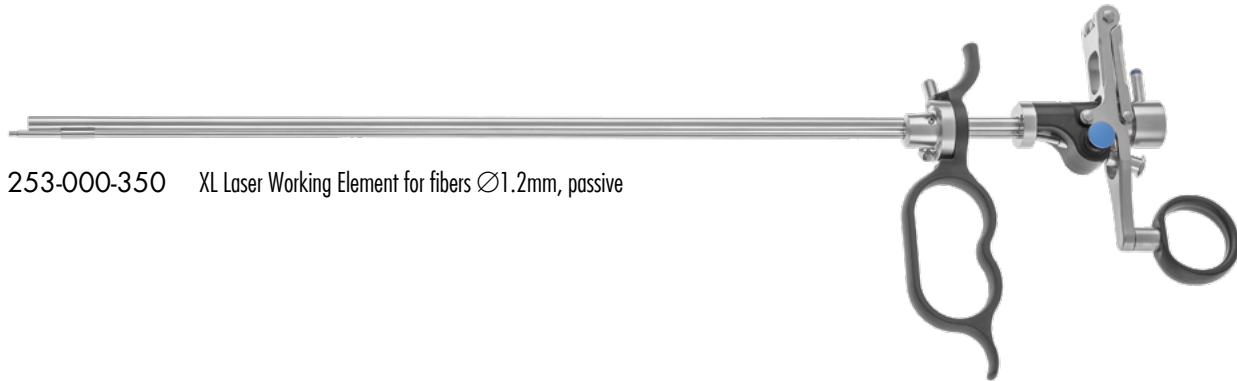



HoLEP[®] MiLEP Set acc. Dr. Felipe C. A. de Figueiredo
 Figueiredo

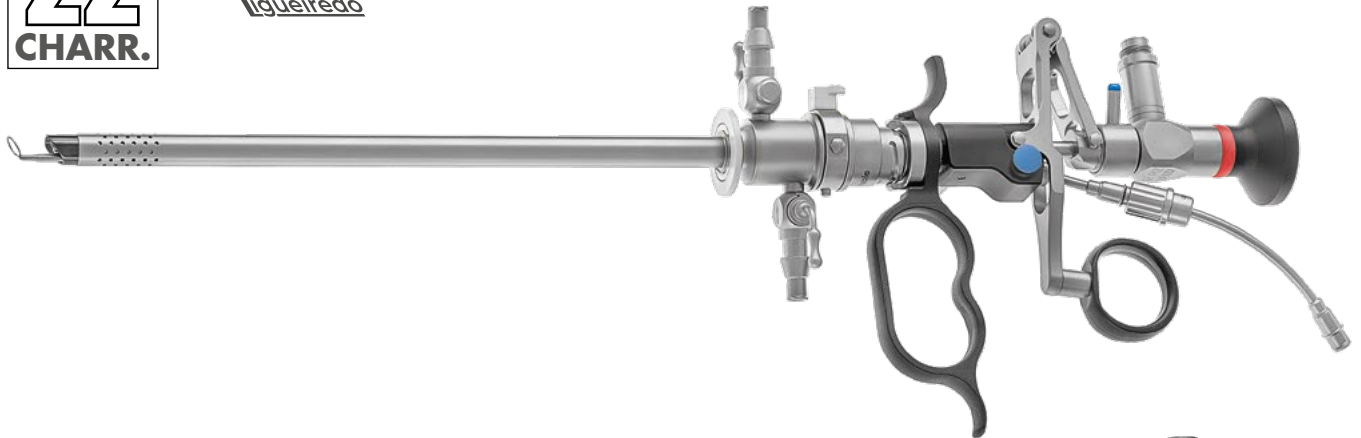

Cystoscope, Ø 2.9mm
 253-829-030 30° direction of view
 253-829-012 12° direction of view

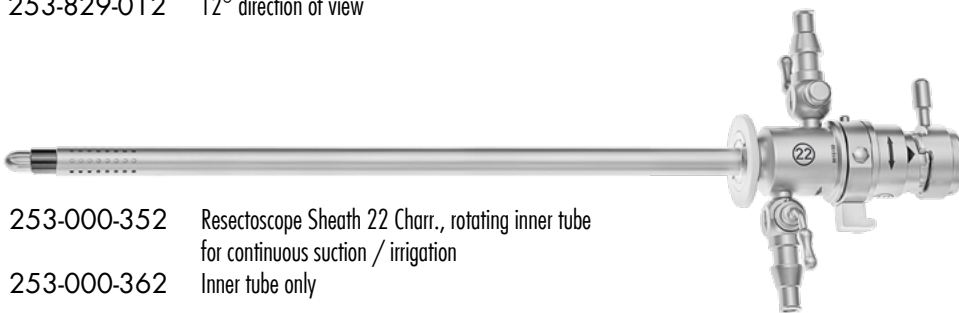

253-000-352 Resectoscope Sheath 22 Charr., rotating inner tube
 for continuous suction / irrigation
 253-000-362 Inner tube only

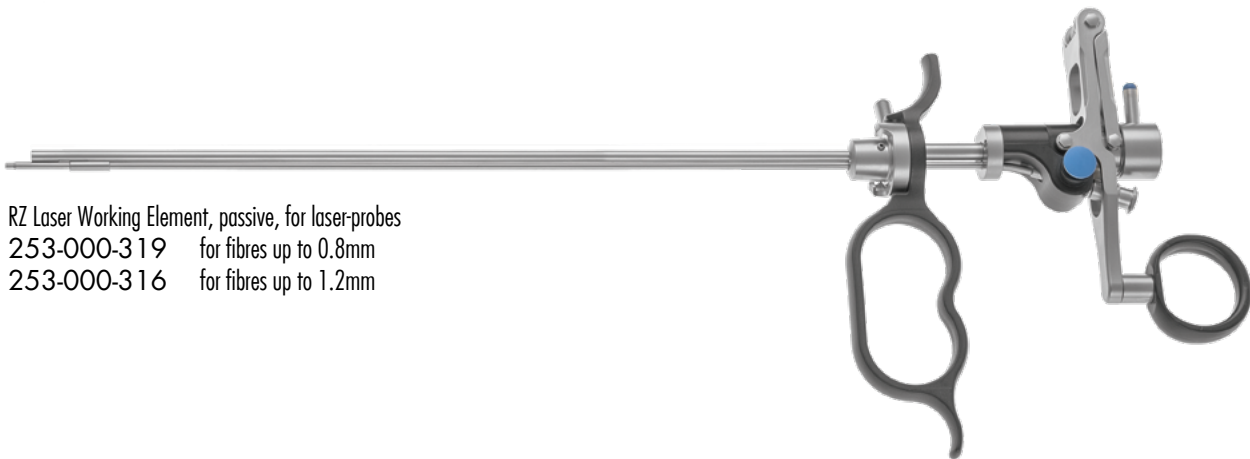

RZ Laser Working Element, passive, for laser-probes
 253-000-319 for fibres up to 0.8mm
 253-000-316 for fibres up to 1.2mm



300-011-184* Luer-Lock Tuohy Borst Adapter (Ø 0.6 - 1.4mm)

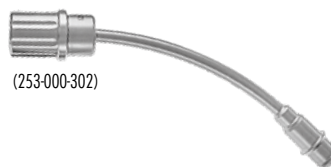

(253-000-302)

RZ LL-Connection, rotatable
 for use with Laser Probe
 253-000-301* short
 253-000-302 long

18.5
CHARR.

HoLEP
Figueiredo

MiLEP Set acc. Dr. Felipe C. A. de Figueiredo

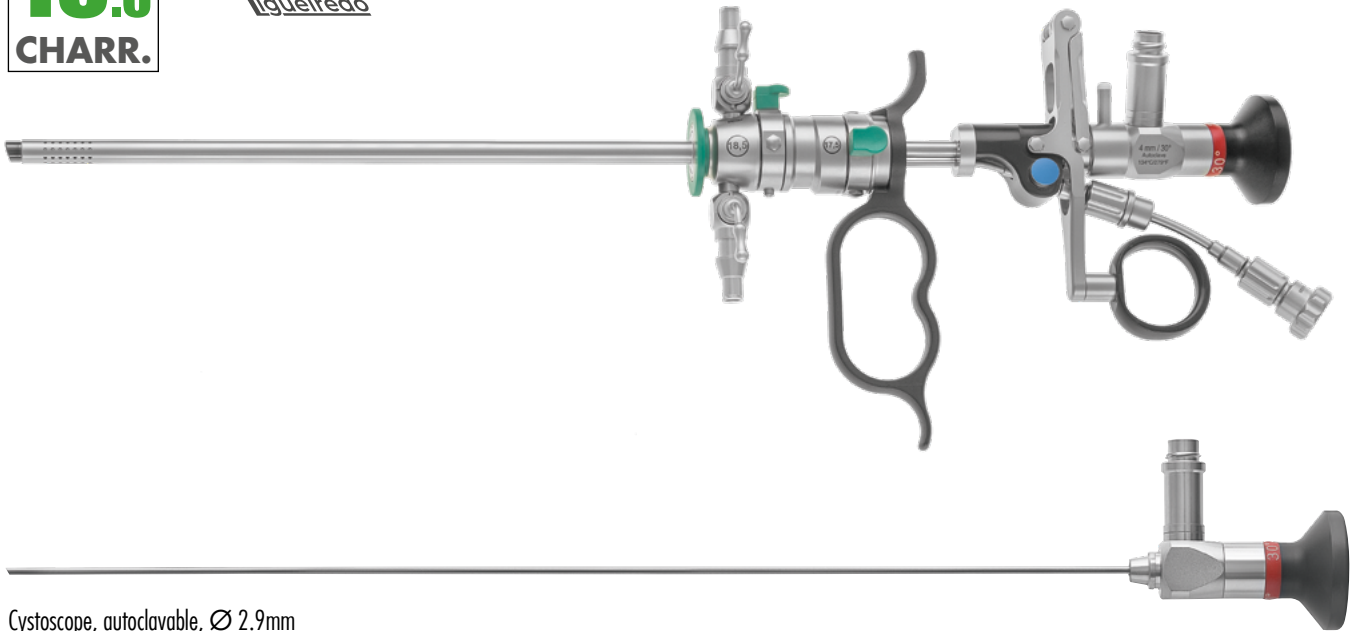

Cystoscope, autoclavable, Ø 2.9mm
253-829-030 30° direction of view
253-829-012 12° direction of view

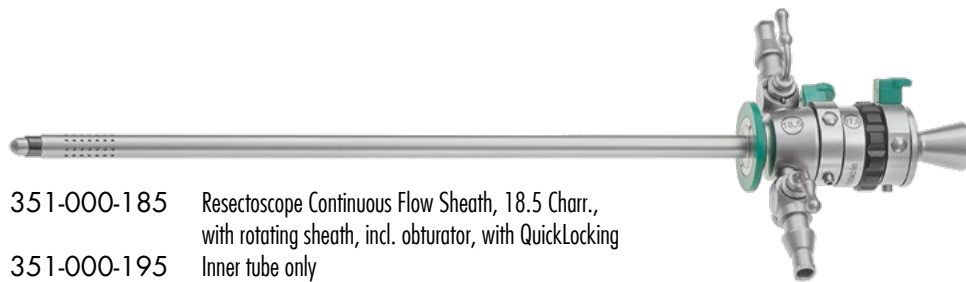

351-000-185 Resectoscope Continuous Flow Sheath, 18.5 Charr.,
with rotating sheath, incl. obturator, with QuickLocking
351-000-195 Inner tube only

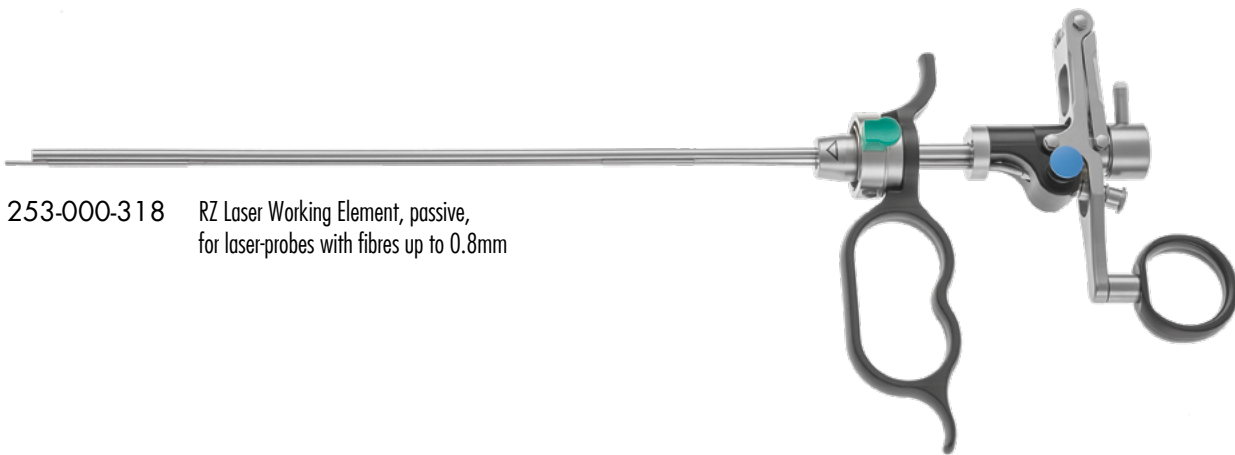

253-000-318 RZ Laser Working Element, passive,
for laser-probes with fibres up to 0.8mm



300-011-184* Luer-Lock Tuohy Borst Adapter (Ø 0.6 - 1.4mm)

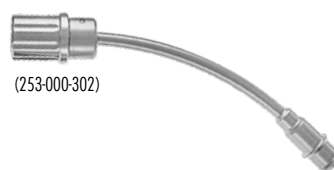

(253-000-302)

RZ LL-Connection, rotatable
for use with Laser Probe
253-000-301* short
253-000-302 long

24
CHARR.

TISSUE MORCELLATION

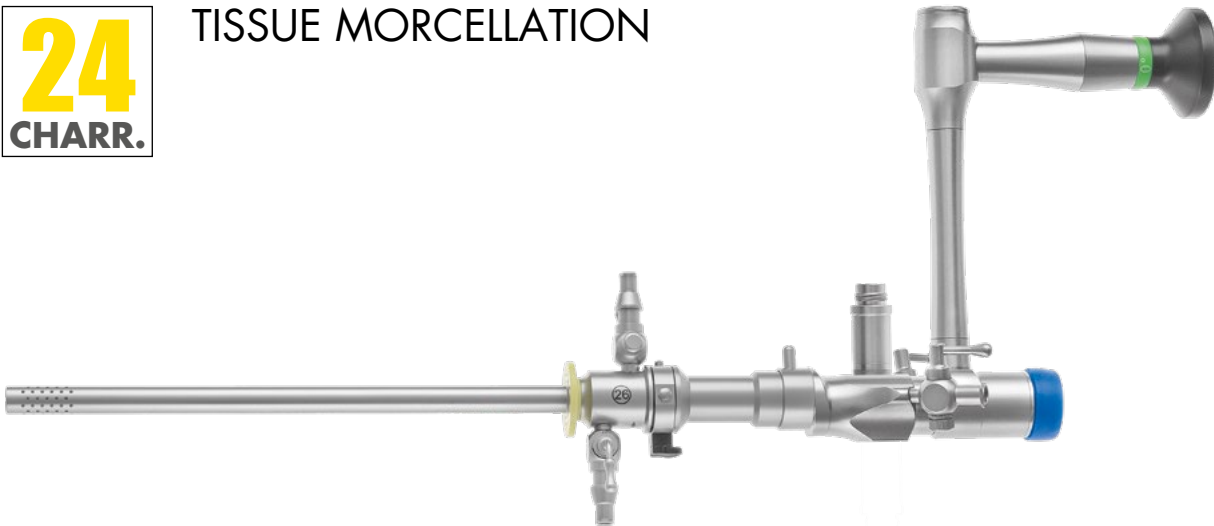

253-900-121* Nephroscope 6°, oval instrument channel, parallel eye piece, 250mm working length

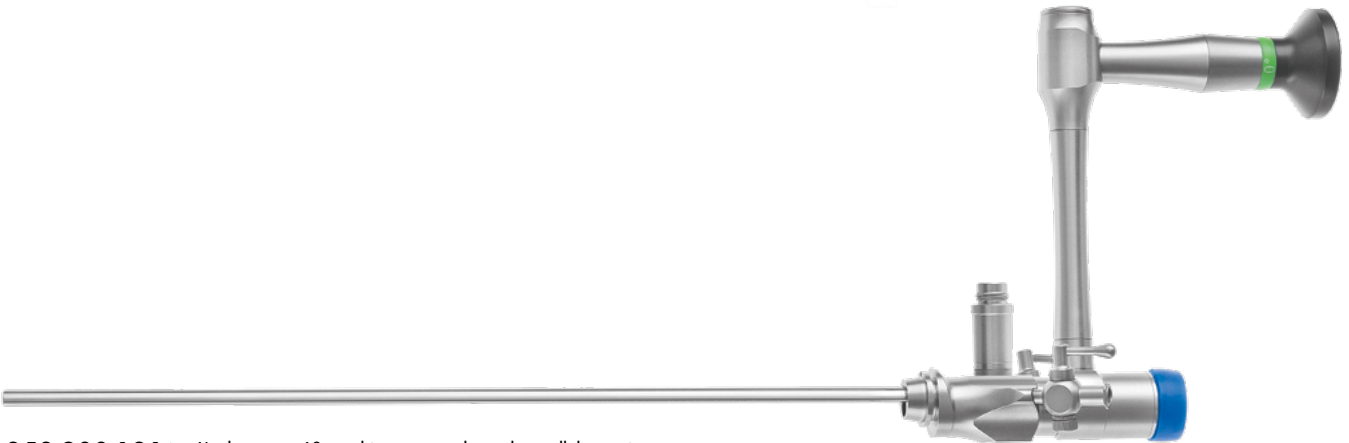

253-000-256* Continuous Flow 26 Charr. Resectoscope Sheath with rotating inner sheath and non-reflecting ceramic tip, including atraumatic obturator

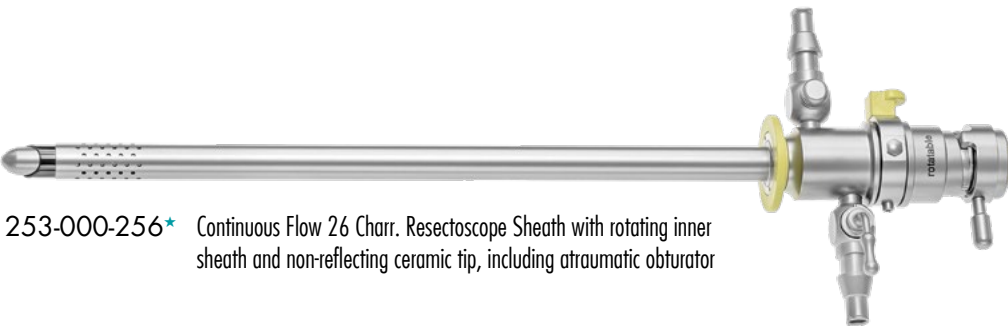

253-428-100* Adapter for use with RZ Nephroscopes and Resectoscope Outer sheaths 253-000-356/-256

22
CHARR.

standard HoLEP_k Morcescope
acc. Dr. Felipe C. A. de Figueiredo

 **figueiredo**

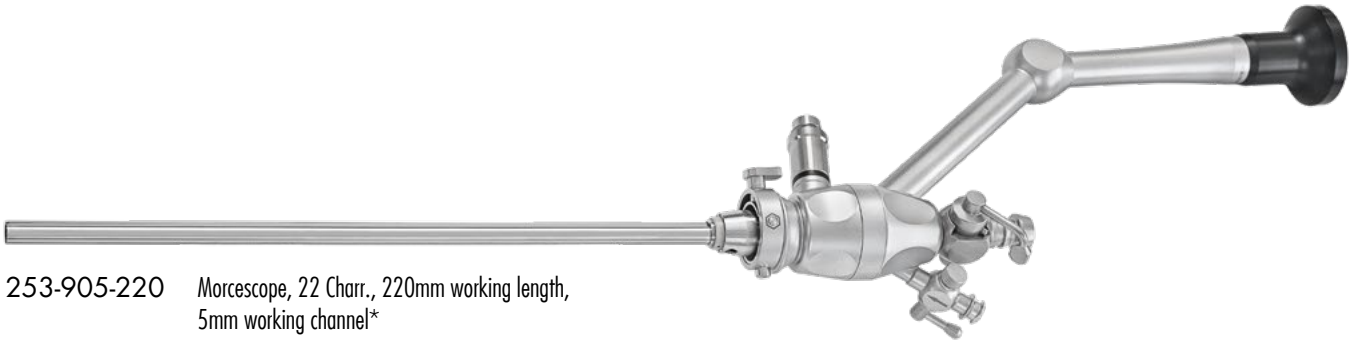

253-905-220 Morcescope, 22 Charr., 220mm working length, 5mm working channel*

18.5
CHARR.

* to be used for morcellation after laser enucleation with 18.5 Charr. Resectoscope

standard HoLEP_k

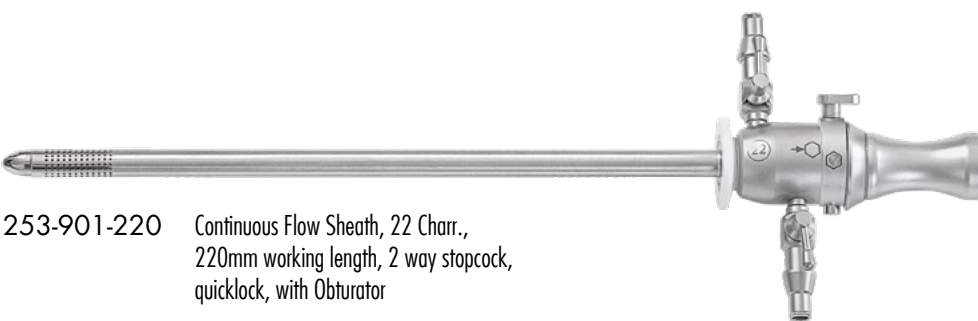

253-901-220 Continuous Flow Sheath, 22 Charr., 220mm working length, 2 way stopcock, quicklock, with Obturator



253-904-220 Sealing Cap for Morcescope, with membrane to puncture through, package of 10 pieces



UNIVERSAL LASER CYSTOSCOPE SET

side fire, compatible with all laser fibres up to 2.5mm
for PVP, HoLEP & ThuVAP

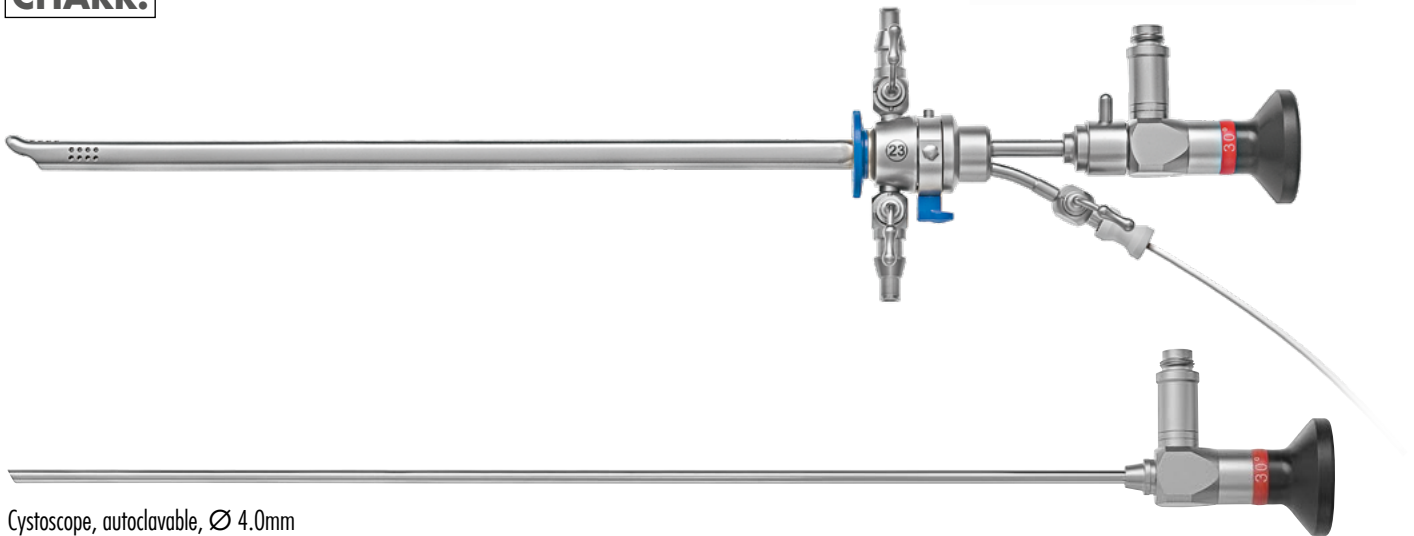

Cystoscope, autoclavable, Ø 4.0mm
253-804-030 30° direction of view
253-804-012 12° direction of view

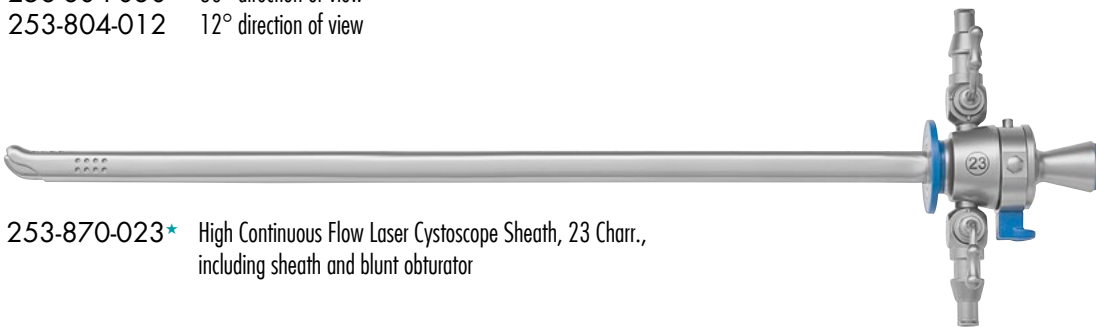

253-870-023* High Continuous Flow Laser Cystoscope Sheath, 23 Charr., including sheath and blunt obturator

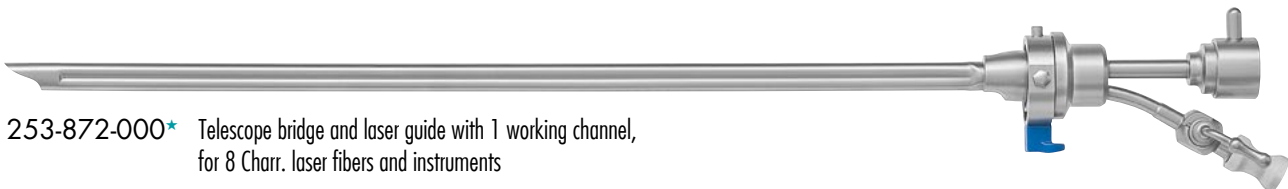

253-872-000* Telescope bridge and laser guide with 1 working channel, for 8 Charr. laser fibers and instruments

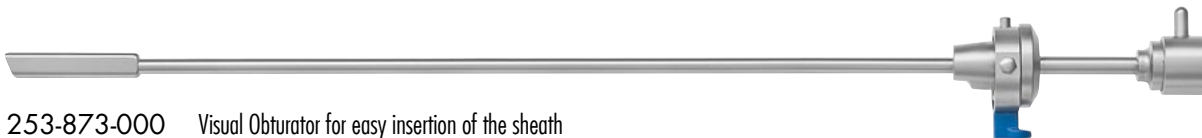

253-873-000 Visual Obturator for easy insertion of the sheath into the urethra and bladder

24
CHARR.

LASER RESECTION SET for PVP, HoLEP & ThuVAP

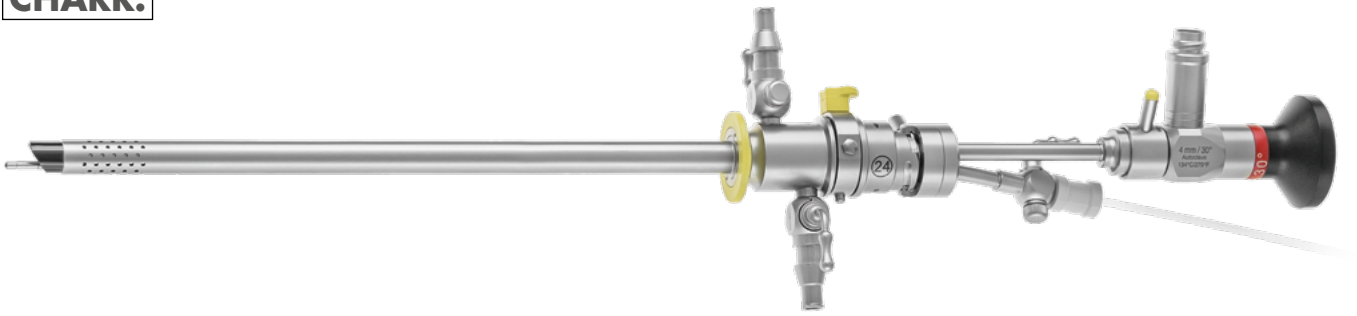

Cystoscope, autoclavable, Ø 4.0mm
253-804-030 30° direction of view
253-804-012 12° direction of view

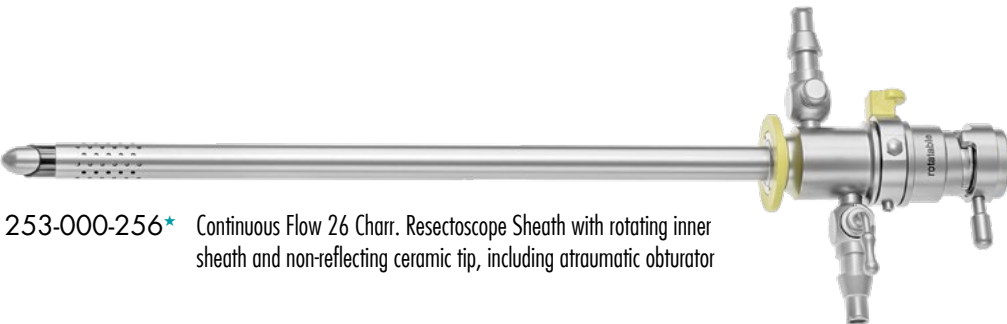

253-000-256* Continuous Flow 26 Charr. Resectoscope Sheath with rotating inner sheath and non-reflecting ceramic tip, including atraumatic obturator



253-874-000 Laser Working Insert with 7 Charr. working channel, for 24/26 Charr. sheaths and 4mm telescope

URETHROTOME

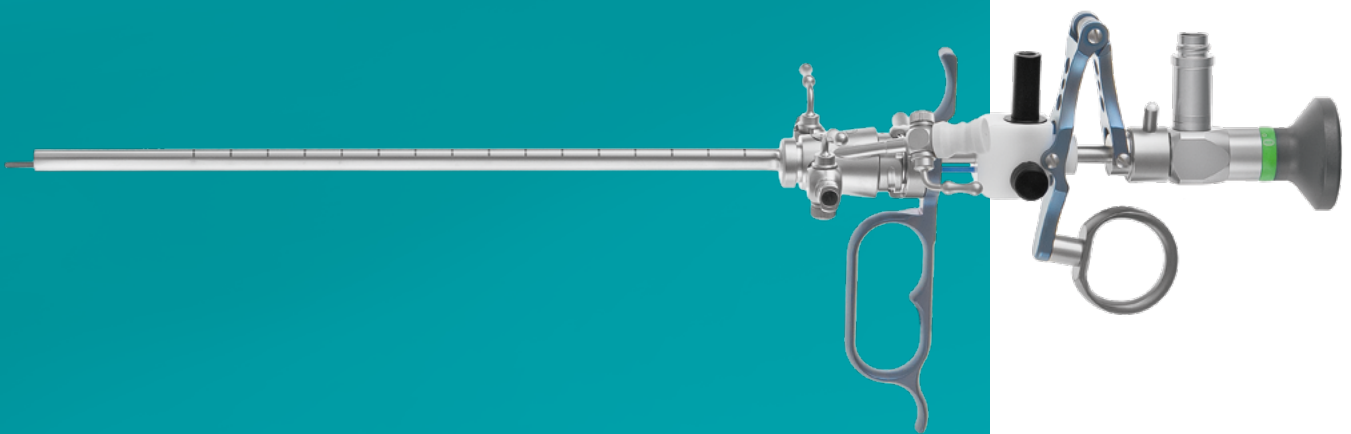

21
CHARR.

URETHROTOME SET

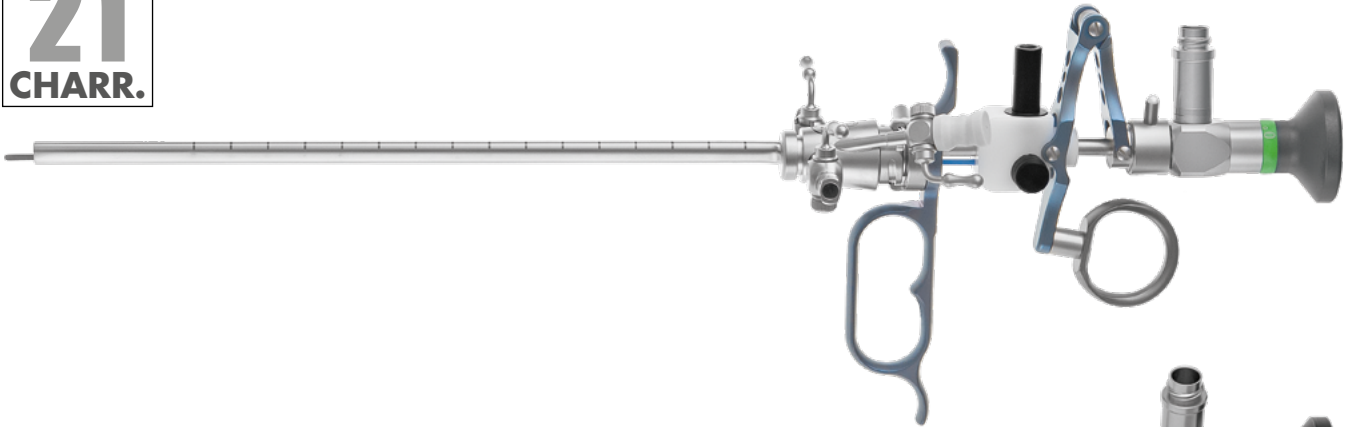

253-804-000* Cystoscope, 0°, Ø 4mm



253-500-221* Urethrotome Sheath oval shape, 21 Charr. with 5 Charr. working channel for catheters, bougies and accessories

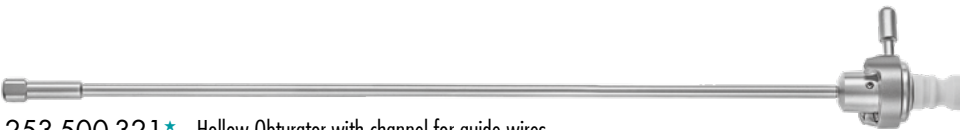

253-500-321* Hollow Obturator with channel for guide wires



253-500-230* Supplementary Sheath, half round, to insert Foley catheters, double Lock for secure fixation on the Urethrotome Sheath



253-500-325 Bridge with channel for 5 Charr. accessories



253-500-229 Continuous Flow supplementary sheath with double lock

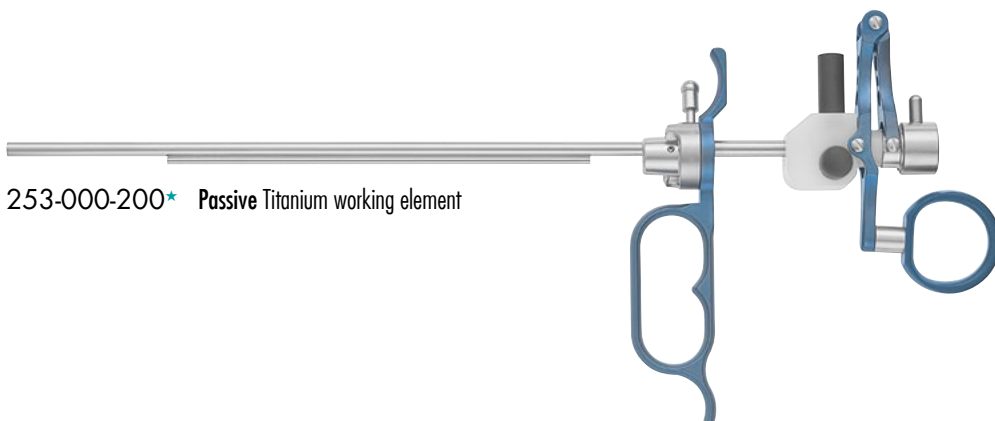

253-000-200* Passive Titanium working element



1 Guide Stem Urethrotome Knives, for use without HF



253-500-561 ★

Sachse knife, straight



253-500-562

Sickle knife, retrograde



253-500-563 ★

Half round knife, 180° cutting



253-500-564

WaveCut knife, straight



253-300-999 ★ Storage container for knives and electrodes, metal, perforated

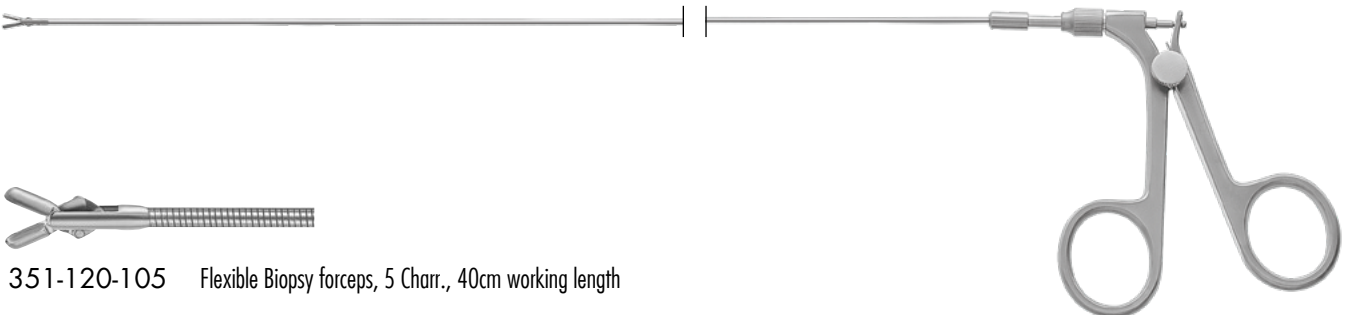

351-120-105 Flexible Biopsy forceps, 5 Charr., 40cm working length

15.5
CHARR.

URETHROTOME SET

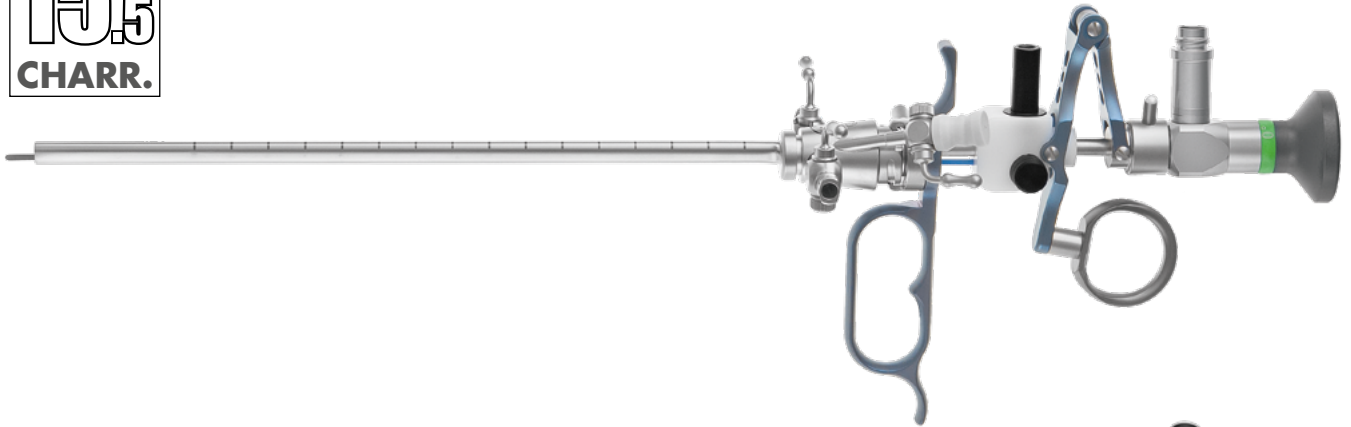

253-829-000 RZ Cystoscope, Ø 2.9mm, 0° direction of view

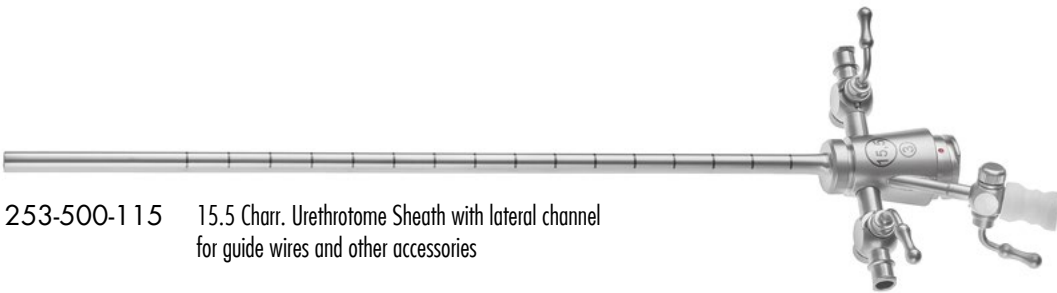

253-500-115 15.5 Charr. Urethrotome Sheath with lateral channel for guide wires and other accessories



253-500-315 Obturator for use with 253-500-115

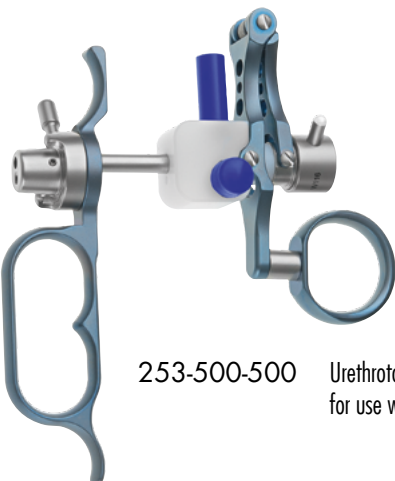

253-500-500 Urethrotome Working Element for use with RZ Cystoscope, Ø 2.9mm, 0°



253-500-125 Urethrotome Bridge 15.5 Charr., with 5 Charr. working channel, for Ø 2.9mm endoscopes

1 Guide Stem Urethrotome knives, for use without HF



253-500-581

Sachse knife, straight, 15 Charr.



253-500-582

Sickle knife, retrograde, 15 Charr.



253-500-101 Urethrotome only



253-500-102 Knife only

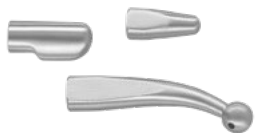

253-500-108 Set with 3 atraumatic tips



KEITZER Urethrotome,
 253-500-104 complete
 253-500-105 Urethrotome only
 253-500-106 Knife only, pointed
 253-500-116 Knife only, blunt

LITHOTRIPSY

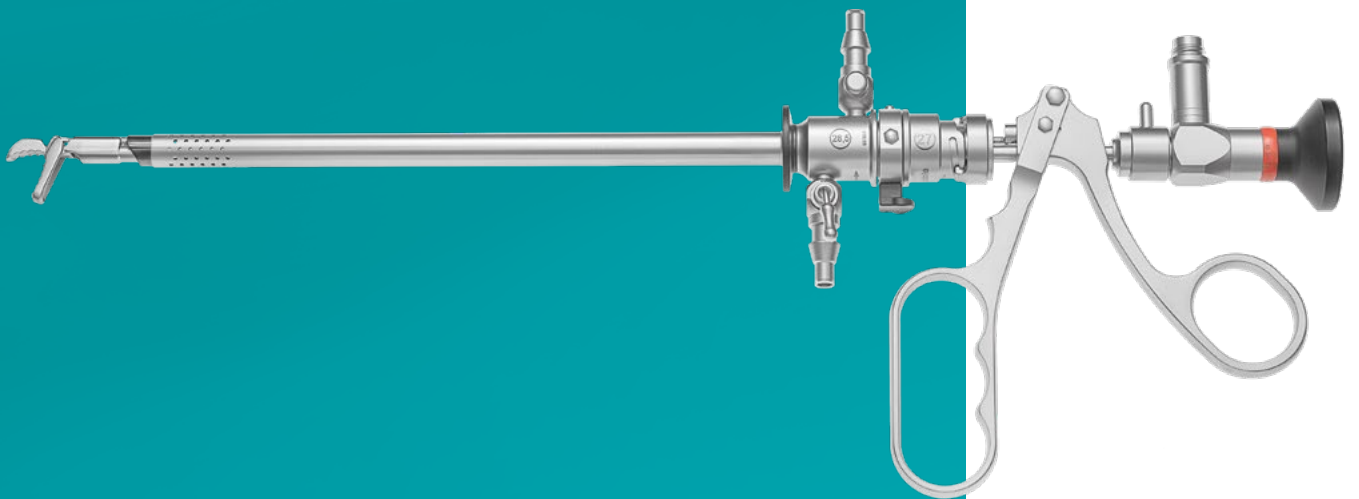

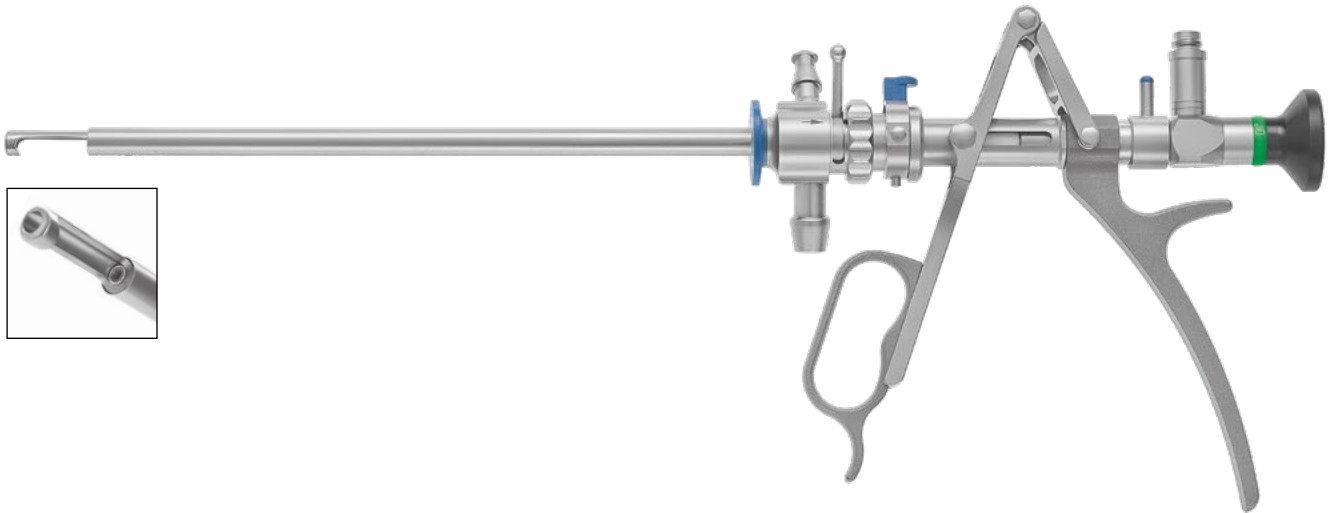

253-804-000* Cystoscope, 0°, Ø 4mm, autoclavable



253-755-020* Punch Sheath with Central Valve, 24 Charr. including Obturator

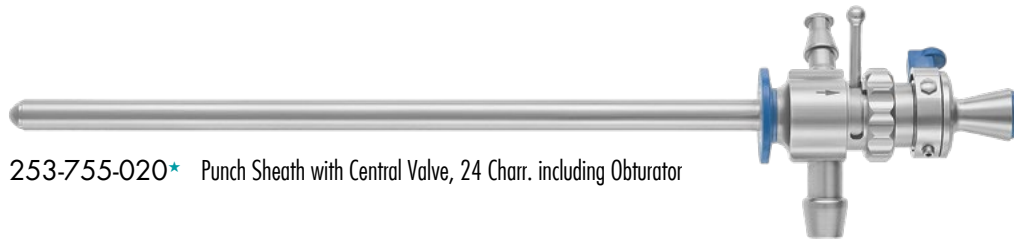

253-755-030 Visual Obturator with 7 Charr. working channel

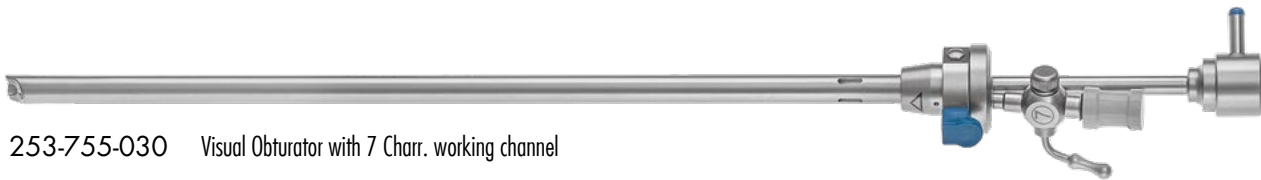

253-755-040 Obturator only



253-755-010* Mauermayer Stone Punch

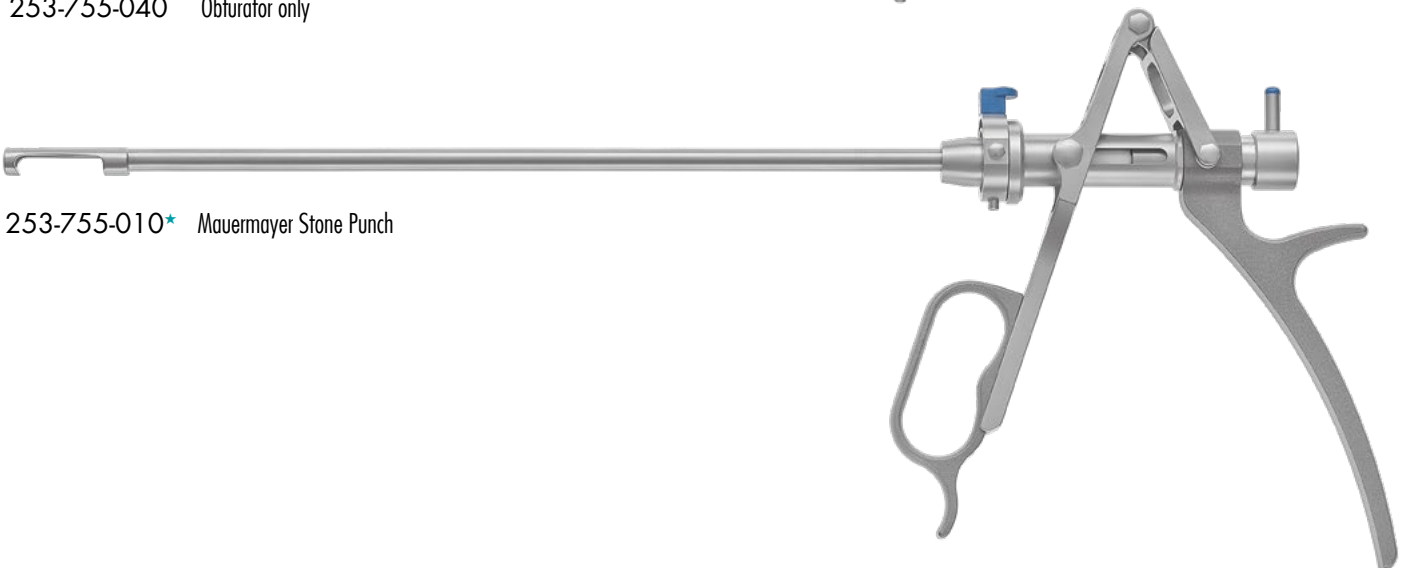

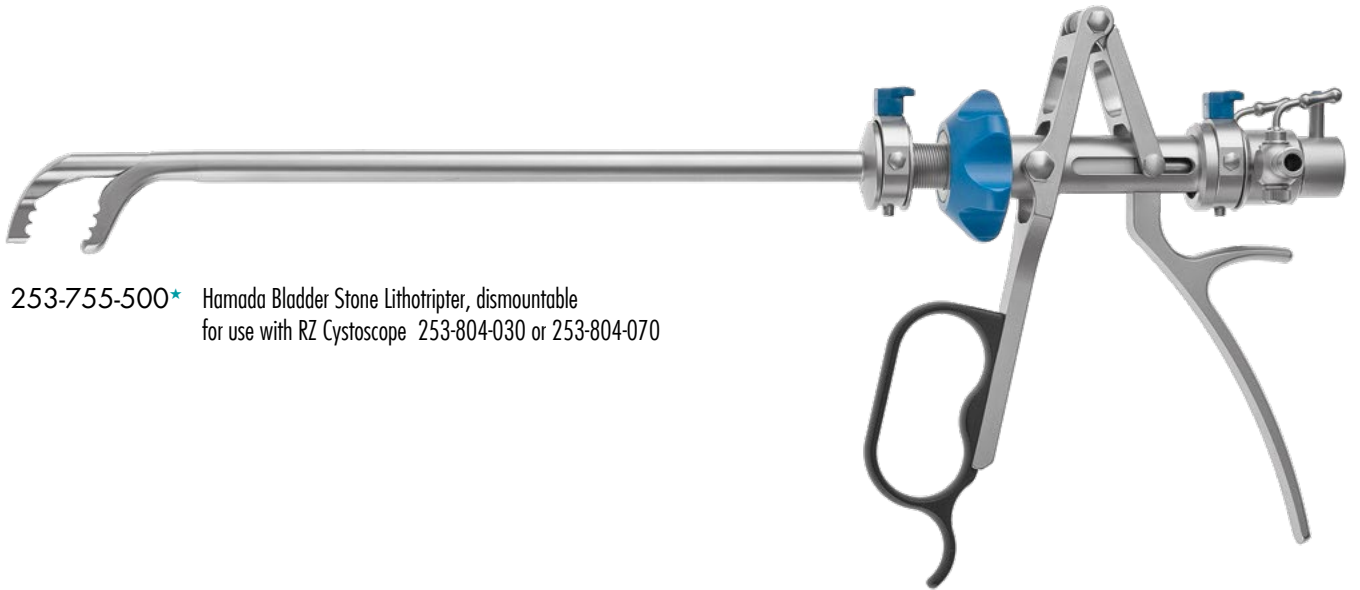

253-755-500* Hamada Bladder Stone Lithotripter, dismantable
for use with RZ Cystoscope 253-804-030 or 253-804-070

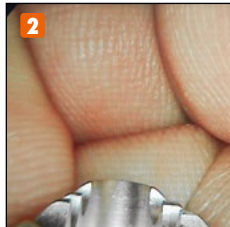
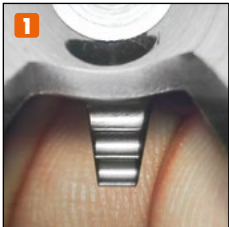

Comparison:
field of view

- 1 with 30° Endoscope
- 2 with 70° Endoscope

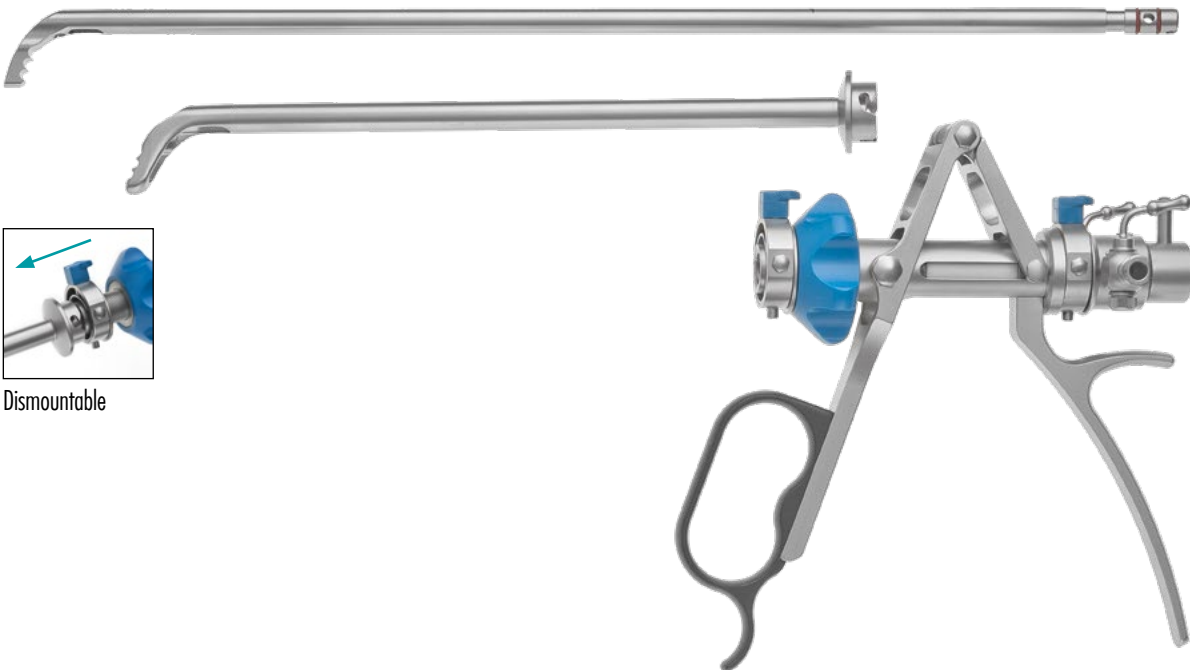

Dismountable

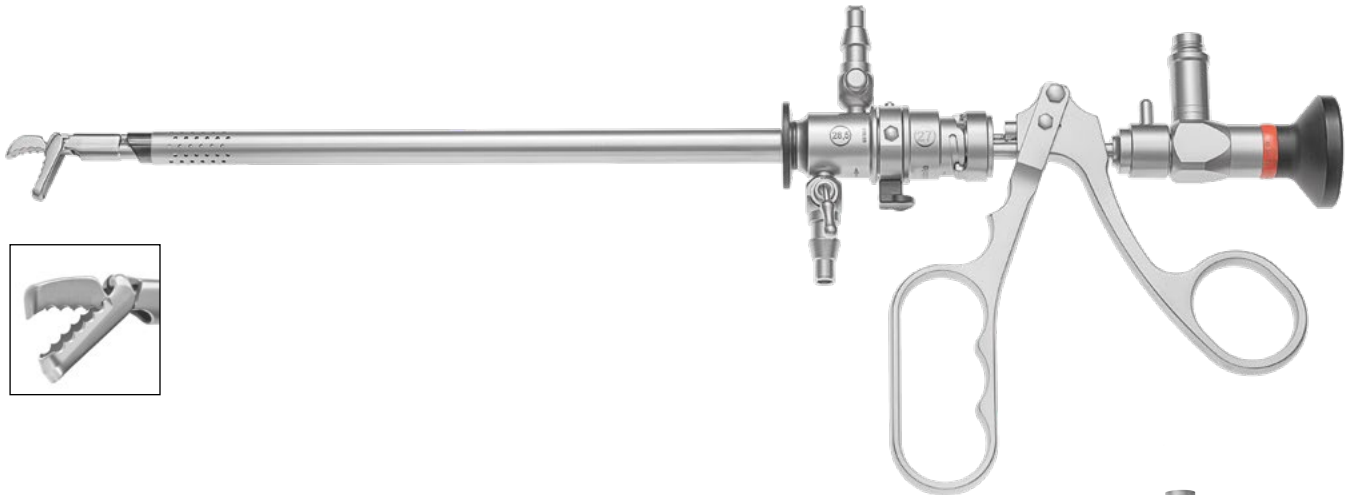

253-804-030 Cystoscope, autoclavable, Ø 4.0mm, 30° direction of view

To be used with Sheaths:

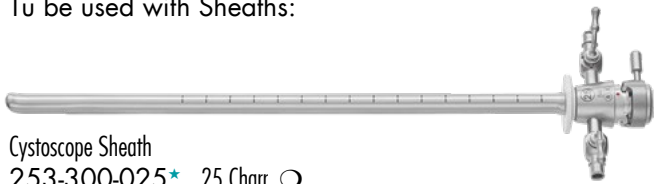

Cystoscope Sheath
253-300-025* 25 Charr. ○

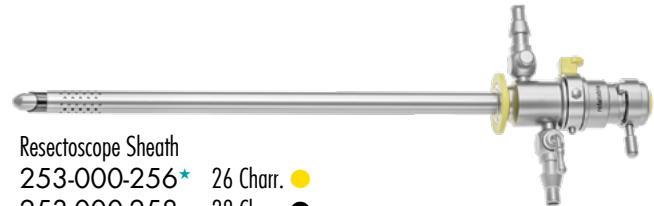

Resectoscope Sheath
253-000-256* 26 Charr. ●
253-000-258 28 Charr. ●



Resectoscope Sheath
253-000-356 Fixed, 26 Charr. ●
253-000-358 Fixed, 28 Charr. ●

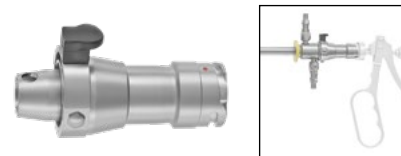

253-430-100* Adapter for use with Outer Resectoscope Sheaths

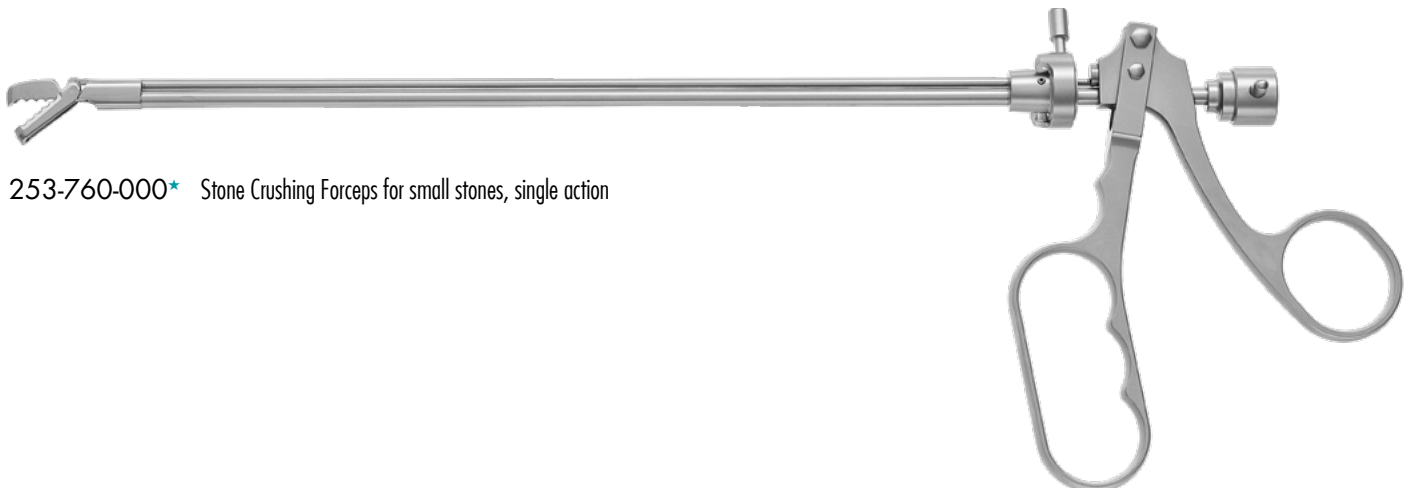

253-760-000* Stone Crushing Forceps for small stones, single action

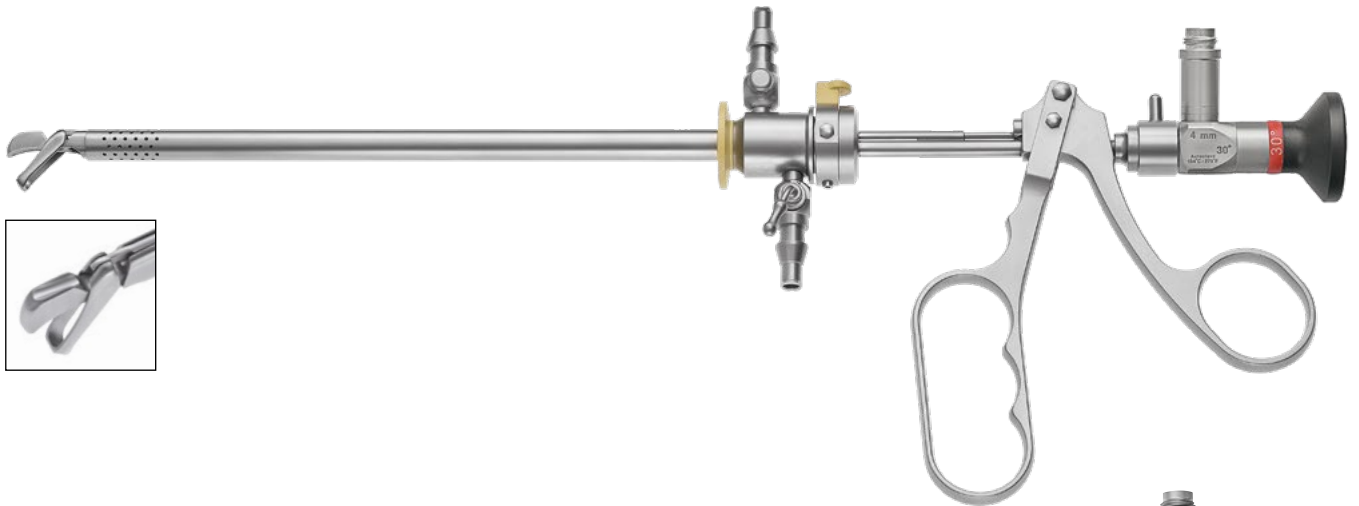

253-804-030 Cystoscope, autoclavable, Ø 4.0mm, 30° direction of view

Suitable Resectoscope Sheaths

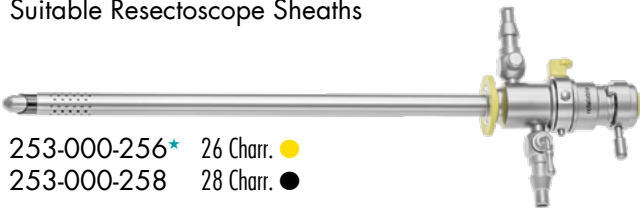

253-000-256* 26 Charr. ●
253-000-258 28 Charr. ●

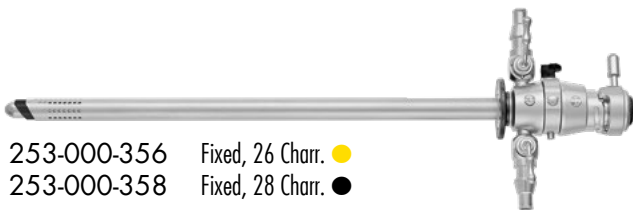

253-000-356 Fixed, 26 Charr. ●
253-000-358 Fixed, 28 Charr. ●

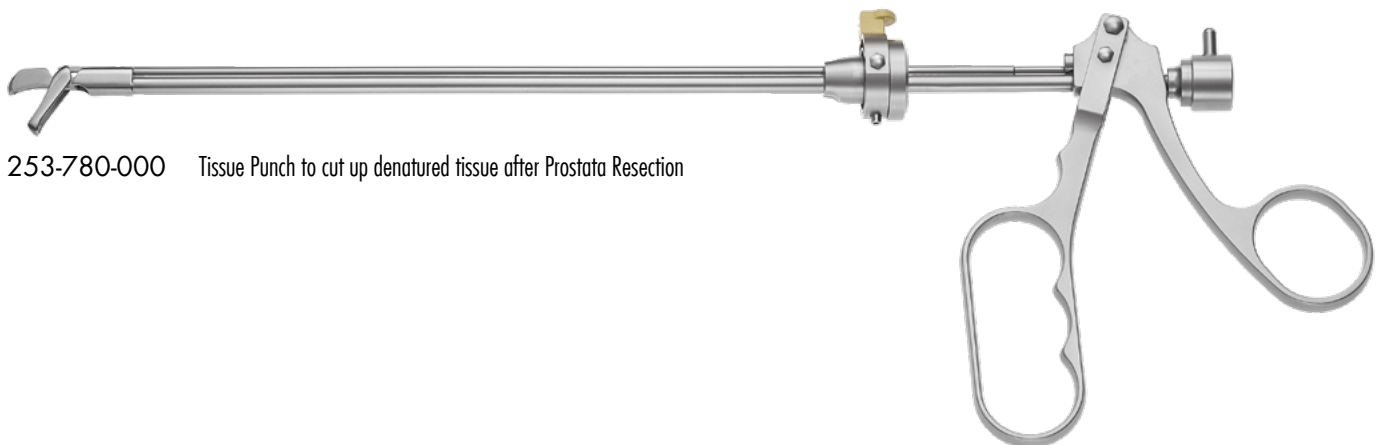

253-780-000 Tissue Punch to cut up denatured tissue after Prostata Resection

NEPHROSCOPY

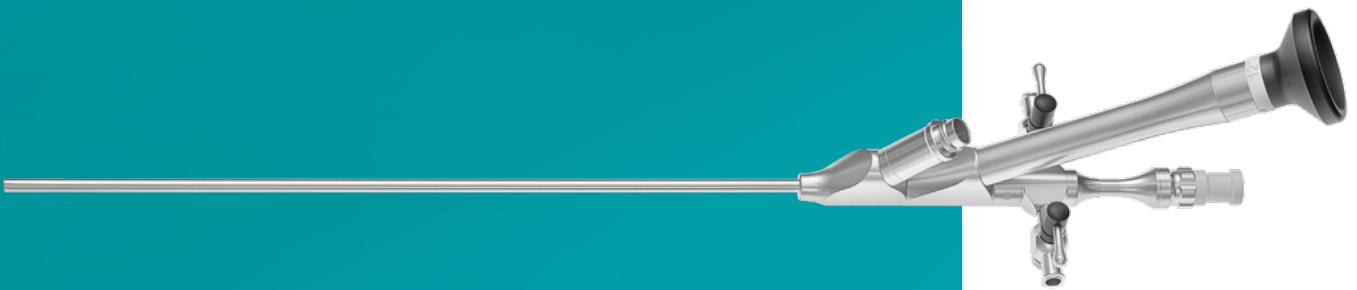



12 Charr. MINI NEPHROSCOPE

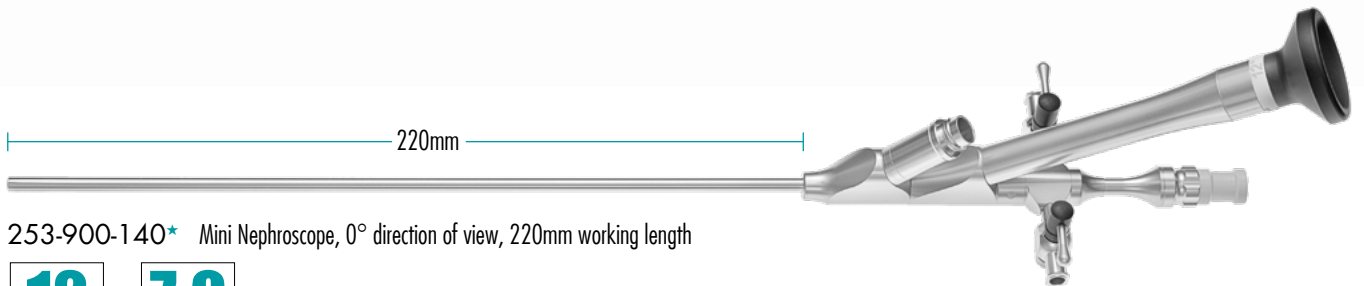
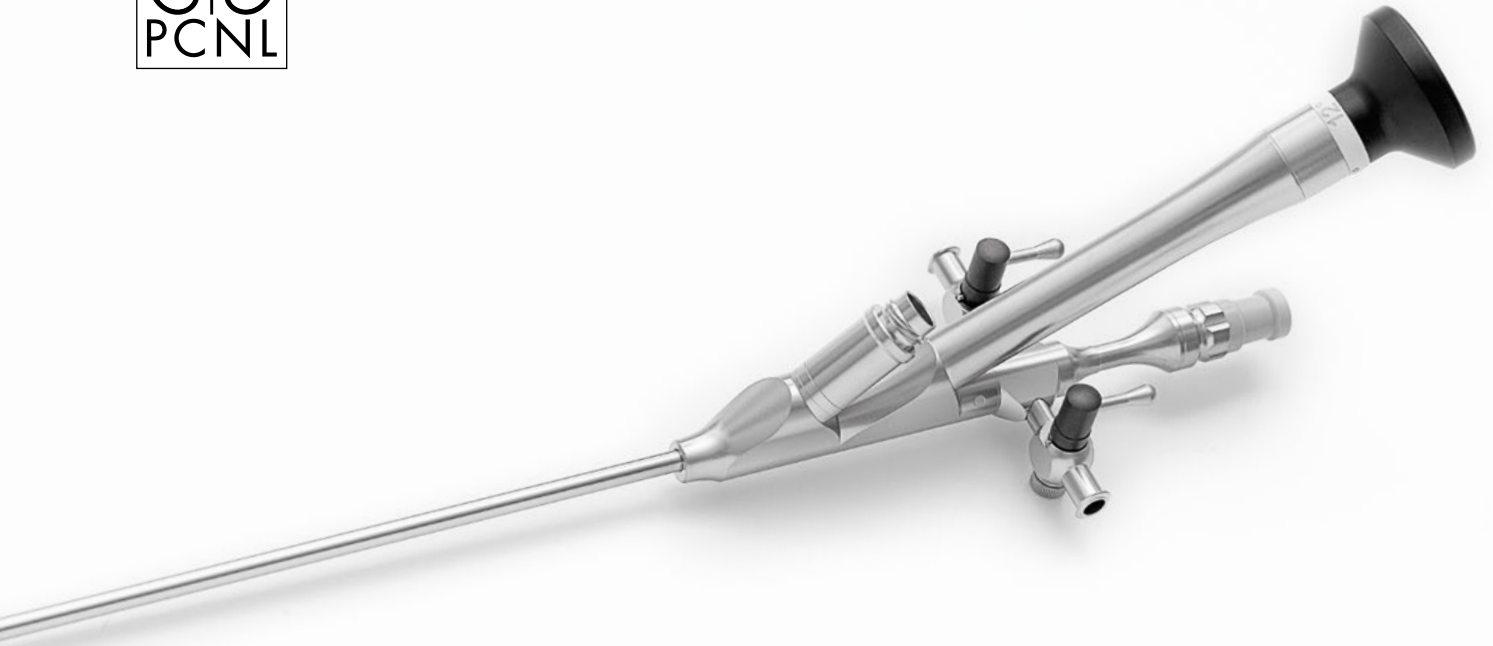

253-900-140* Mini Nephroscope, 0° direction of view, 220mm working length

12
CHARR.
Ø SHAFT

7.0
CHARR.
WORKING CHANNEL*

* for use with instruments up to 5 Charr.



253-905-400
Silicone Valve,
package with 5 pieces



253-900-010
Silicone Valve, package with 10 pieces,
for use with very delicate instruments
from 0.5 – 1.6mm diameter.



OPERATING SHEATHS for use with RZ Mini Nephroscope

Mini PCNL Sheaths with valve

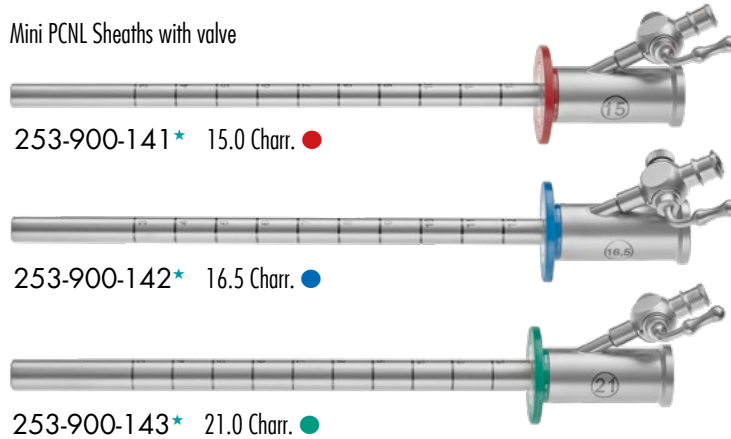

253-900-141* 15.0 Charr. ●

253-900-142* 16.5 Charr. ●

253-900-143* 21.0 Charr. ●

Long Mini PCNL Sheaths

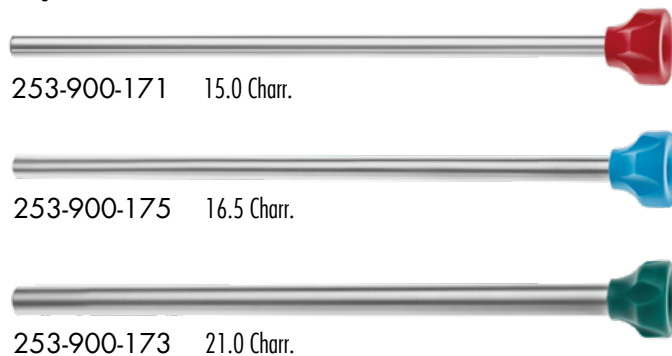

253-900-171 15.0 Charr.

253-900-175 16.5 Charr.

253-900-173 21.0 Charr.

One-Step Dilators with 1 central guide wire channel

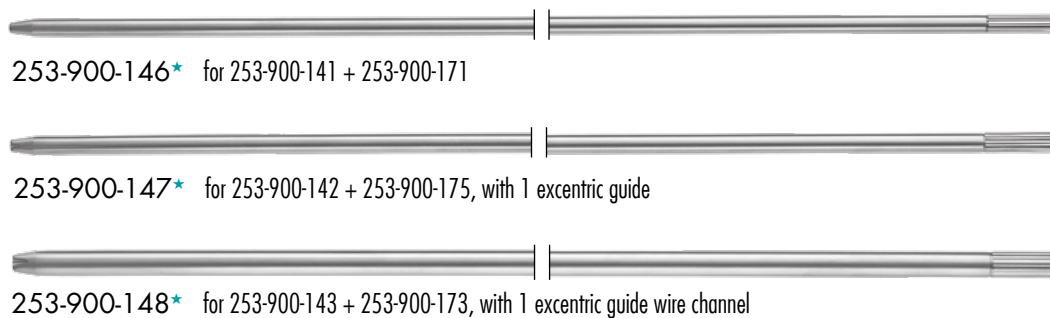

253-900-146* for 253-900-141 + 253-900-171

253-900-147* for 253-900-142 + 253-900-175, with 1 excentric guide

253-900-148* for 253-900-143 + 253-900-173, with 1 excentric guide wire channel

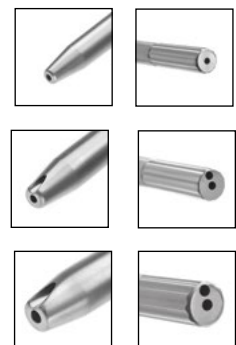

253-900-145* 2-piece Sealing Adapter with sheath and obturator for use with 253-900-141

RZ NEPHROSCOPY INSTRUMENTS

semi-rigid, 5 Charr.

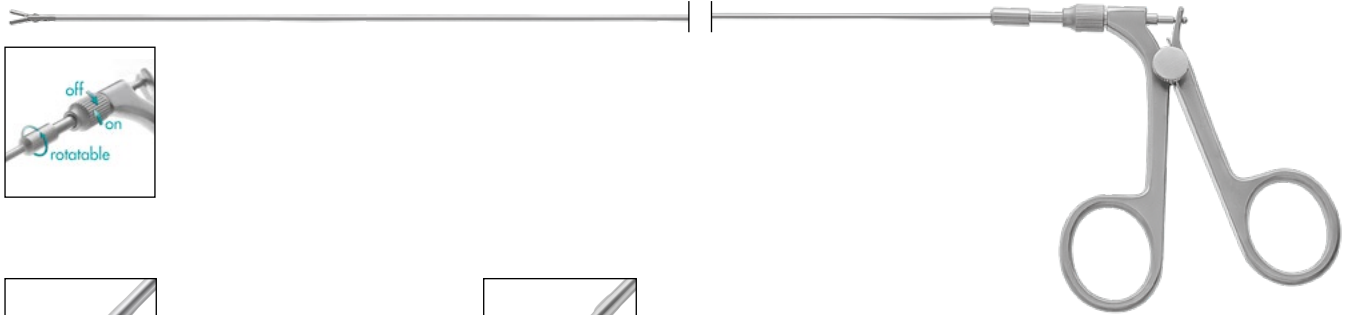

Stone Grasping Forceps,
double action jaws, retrograde serration
253-950-455* 450mm working length

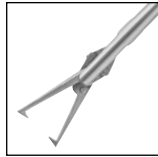

Stone Grasping Forceps
for large stones, double action jaws, 1 x 1 teeth
253-952-455* 450mm working length



Hamada Long Stone Grasping Forceps,
double action jaws, fine serrated
253-954-455 450mm working length

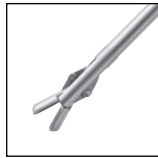

Biopsy Forceps,
double action jaws
253-956-455* 450mm working length

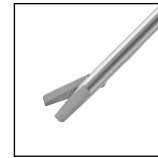

Scissors,
single action jaws
253-958-455 450mm working length

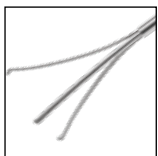

253-960-360* Stone Grasping Forceps, rigid, 5 Charr., 400mm,
for grasping of bigger stones and -fragments
triple toothed jaw, U-spring handle

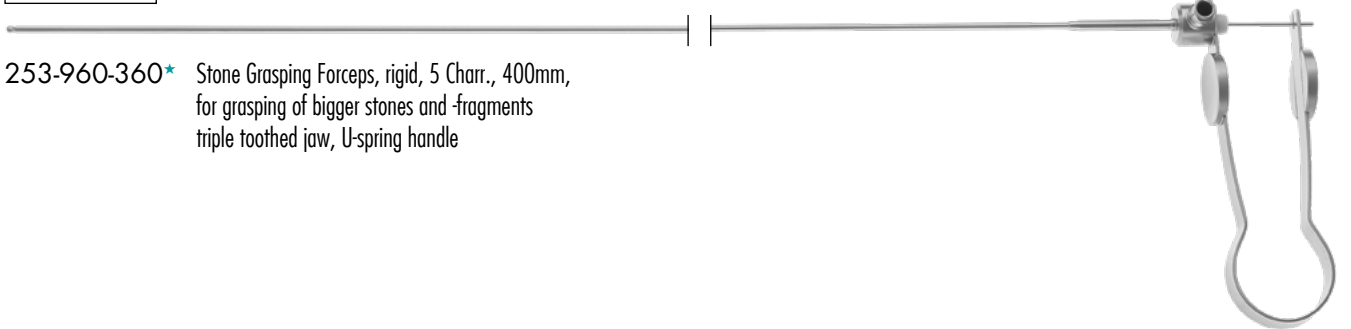

253-900-200 Sterile disposable Guide wire, J-tip, flexible, 150cm length



RZ COMPACT NEPHROSCOPE 220mm working length

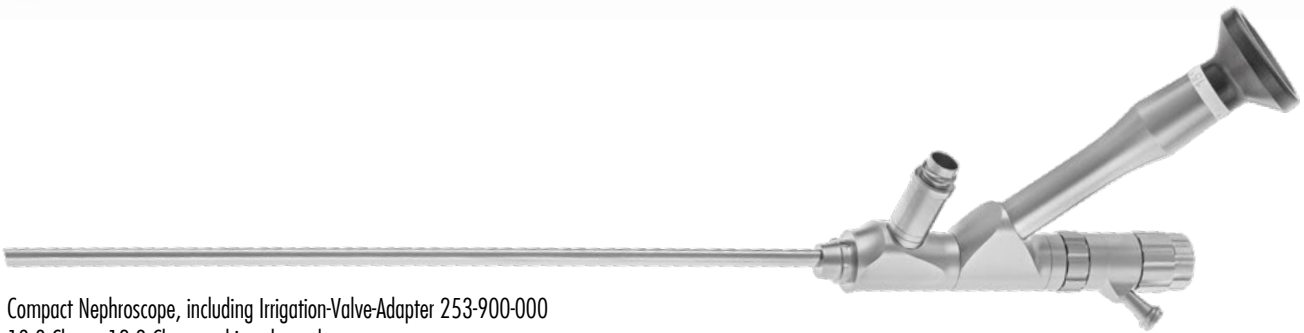

Compact Nephroscope, including Irrigation-Valve-Adapter 253-900-000
 18.8 Charr., 12.9 Charr working channel
 253-900-815 15°
 253-900-830 30°

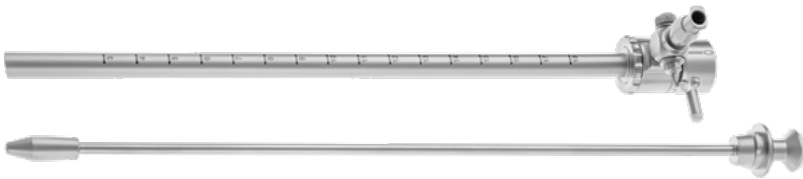

Suitable Shaft, with obturator, 23 Charr., 220mm working length
 253-900-888



253-900-000
 Irrigation-Valve-Adapter

Percutane Nephroscopy, 190mm length



RZ Nephroscope, oblique view, with 2 Luer-Lock stopcocks and detachable instrument stopcock
 253-900-100 6° direction of view
 253-900-150 15° direction of view



253-900-105 Stopcock, only for use with RZ Nephrosopes



RZ Nephroscope, parallel view, with 2 Luer-Lock stopcocks and detachable instrument stopcock
 253-900-101 6° direction of view
 253-900-151 15° direction of view

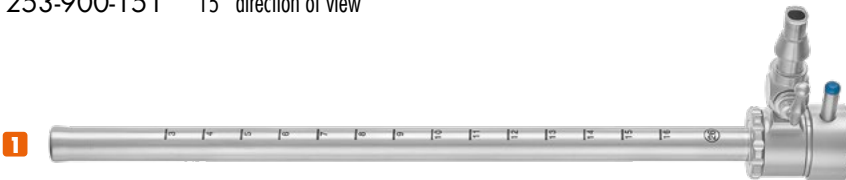

Operating Sheath

1 253-900-110* 26 Charr.

2 253-900-111 24 Charr.



Hollow Obturator

1 253-900-115* 26 Charr.

2 253-900-116 24 Charr.



Percutane Nephroscopy, 250mm length



RZ Nephroscope, oblique view, with 2 Luer-Lock stopcocks and detachable instrument stopcock, 250mm working length

- 253-900-120 6° direction of view
- 253-900-160 15° direction of view



253-900-105 Stopcock, only for use with RZ Nephrosopes (including: 253-900-100 and 253-900-101)

Nephroscope Scope, oval instrument channel, parallel eye piece, 250mm working length

- 253-900-121 6° direction of view
- 253-900-161 15° direction of view



Operating Sheath

- 1** 253-900-130* 26 Charr.
- 2** 253-900-131 24 Charr.



Hollow Obturator

- 1** 253-900-135* 26 Charr.
- 2** 253-900-136 24 Charr.

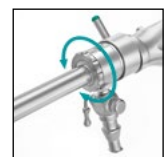



253-900-155* Amplatz Metal Dilator set containing 6 Dilators (9, 12, 15, 18, 21, 24 Charr.)
2 flexible and 2 rigid guide rods for use with guide wires



Amplatz Metal Dilator
253-900-156* 27 Charr.
253-900-157* 30 Charr.

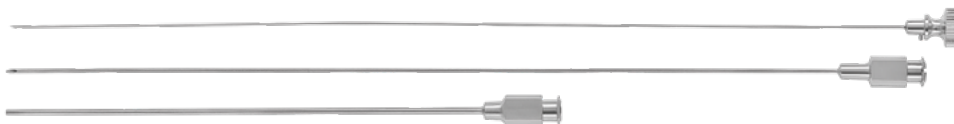

253-900-201* Puncture Cannula with inner and outer cannula



253-900-202* Dilation Cannula, 3mm \varnothing with inner and outer cannula



253-900-200 Sterile disposable Guide wire, J-tip, flexible, 150cm length

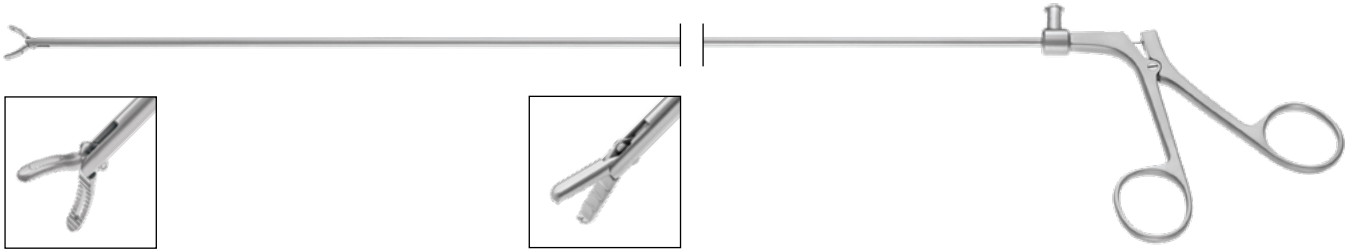

Stone Grasping forceps with fenestrated jaws,
double action, with flushing port
253-900-210* 360mm working length
253-900-250* 430mm working length



Stone Grasping forceps with coarse serrated jaws,
double action
253-900-212* 360mm working length
253-900-252* 430mm working length



Biopsy forceps with sharp cup,
single action
253-900-211 360mm working length
253-900-251 430mm working length



Scissors, sharp tip,
single action
253-900-213 360mm working length
253-900-253 430mm working length

Stone Grasping Forceps with spring handle and finger platform
Ø 4mm, Luer-Lock connection

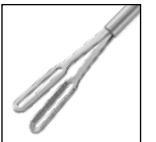
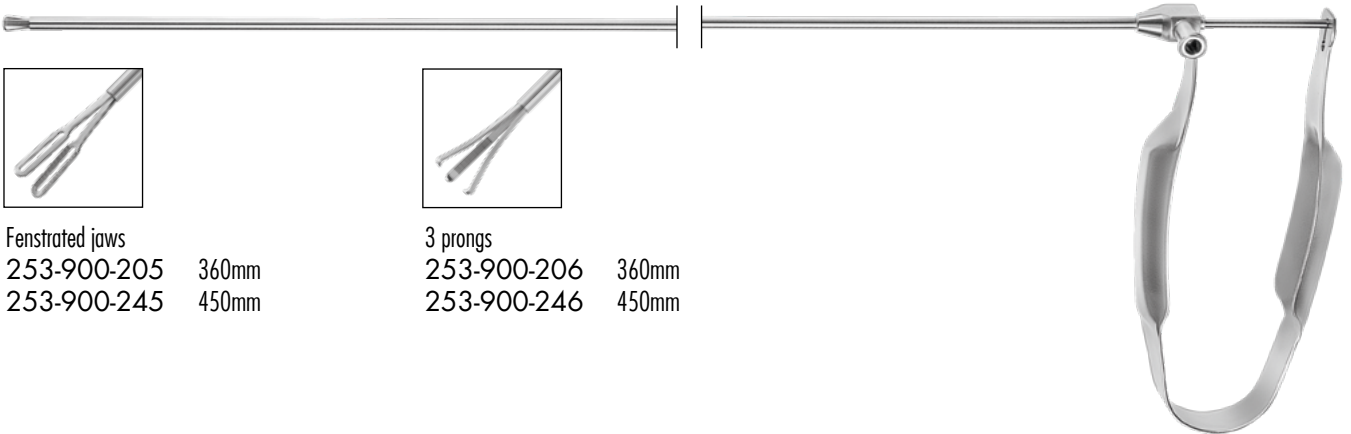

Fenestrated jaws
253-900-205 360mm
253-900-245 450mm



3 prongs
253-900-206 360mm
253-900-246 450mm

Knives, with three-ring-handle, 10.5Charr., 360mm length

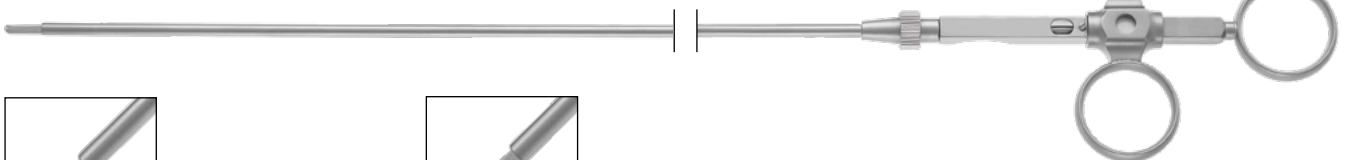

253-900-238
Straight Knife



253-900-239
Sickle Knife

URETERO-RENOSCOPY

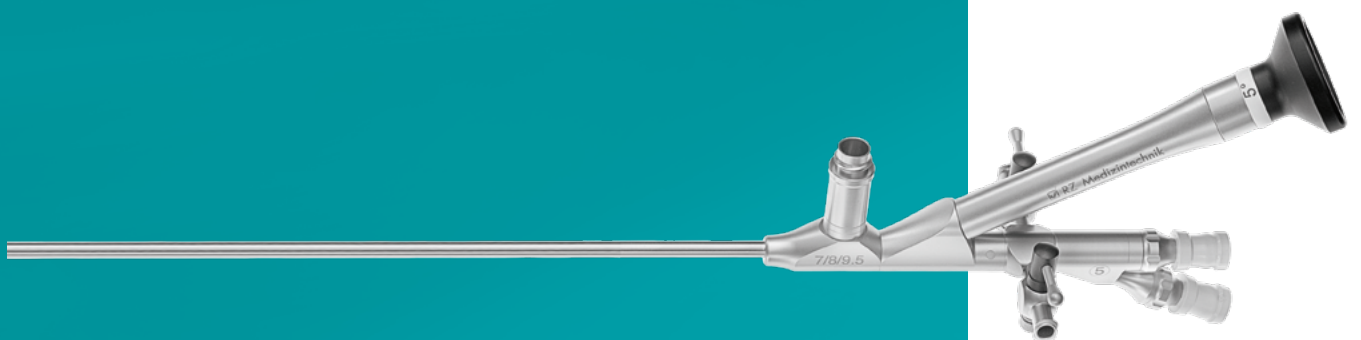

RZ URETERO-RENOSCOPES

- FullHD 50.000 pixel fiber system
- Semi-flexible shaft
- Silicone valve system with 2 parallel sealings
- Large working channels
- Irrigation/suction channels



Sealing caps included
 301-701-060 Ø 0.6mm
 301-701-030 Ø 0.3mm



Atraumatic tip design



Tapered shaft

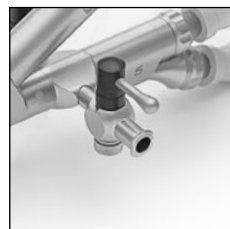

90° stopcocks



5° direction of view
 65° field of view

ADVANCED SEMI-RIGID URETERO-RENSCOPIES

standard LINE

253-905-540* 425mm
253-905-530 310mm

7.5
CHARR.

DISTAL TIP

9.0
CHARR.

DISTAL

13
CHARR.

PROXIMAL

5.8
CHARR.

WORKING
CHANNEL*

* for use with instruments up to 5 Charr.

slim LINE

253-910-540* 425mm
253-910-530 310mm

6.0
CHARR.

DISTAL TIP

7.5
CHARR.

DISTAL

10.5
CHARR.

PROXIMAL

5.0
CHARR.

WORKING
CHANNEL*

* for use with instruments up to 4 Charr.

superslim LINE

253-915-540* 425mm
253-915-530 310mm

5.0
CHARR.

DISTAL TIP

6.5
CHARR.

DISTAL

8.0
CHARR.

PROXIMAL

4.0
CHARR.

WORKING
CHANNEL*

* for use with instruments up to 3 Charr.



5 / 4 Charr. INSTRUMENTS

- 360° rotating mechanism
- Color coded
- Lotus - effect on the surface
- Automatic closing system

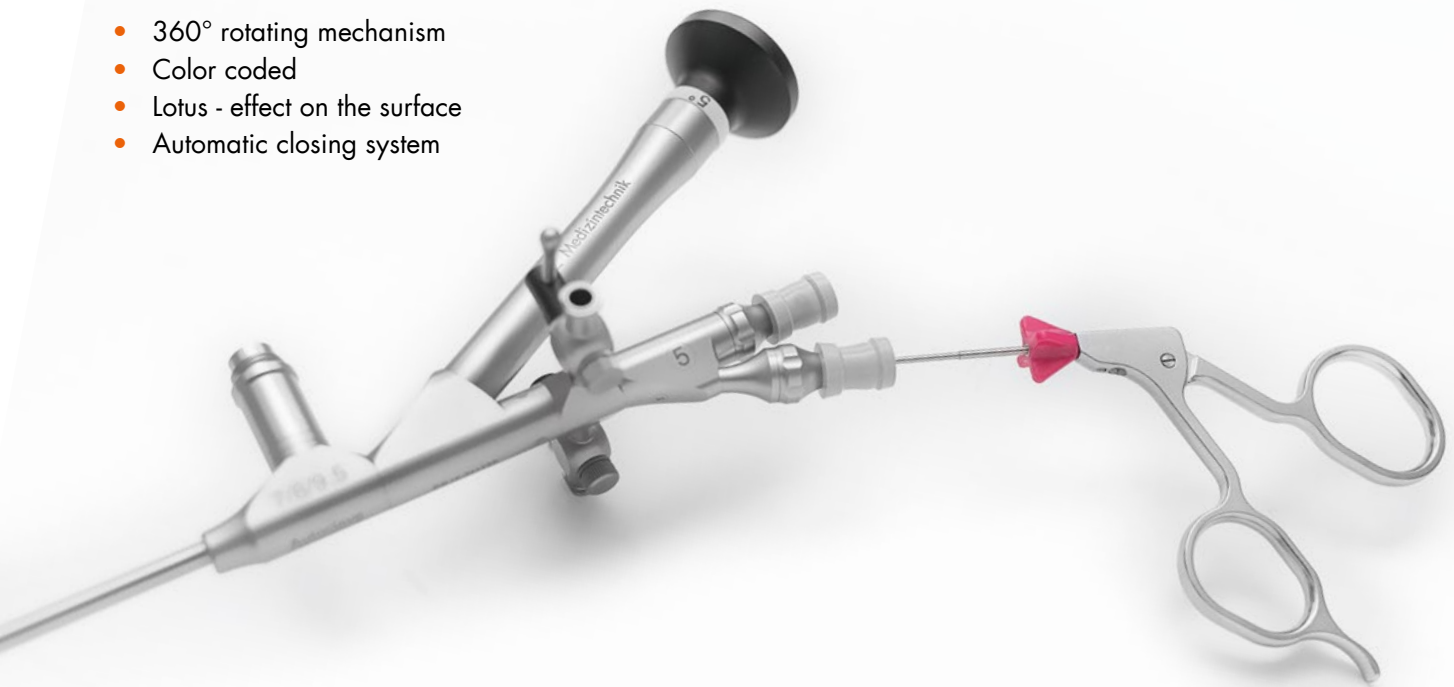

600mm working length



Stone Grasping Forceps,
double action jaws ●
253-950-005* 5 Charr, rigid
253-950-004* 4 Charr, rigid
253-951-005 5 Charr, flexible
253-951-004 4 Charr, flexible



Stone Grasping Forceps for large stones,
double action jaws ●
253-952-005* 5 Charr, rigid
253-952-004* 4 Charr, rigid
253-953-005 5 Charr, flexible
253-953-004 4 Charr, flexible



HAMADA long Stone Grasping Forceps,
double action jaws ●
253-954-005* 5 Charr, rigid
253-954-004* 4 Charr, rigid
253-955-005 5 Charr, flexible
253-955-004 4 Charr, flexible



Biopsy Forceps,
double action jaws ●
253-956-005* 5 Charr, rigid
253-956-004* 4 Charr, rigid
253-957-005 5 Charr, flexible
253-957-004 4 Charr, flexible



Scissors,
single action ●
253-958-005* 5 Charr, rigid
253-958-004* 4 Charr, rigid
253-959-005 5 Charr, flexible
253-957-004 4 Charr, flexible

3 Charr. INSTRUMENTS

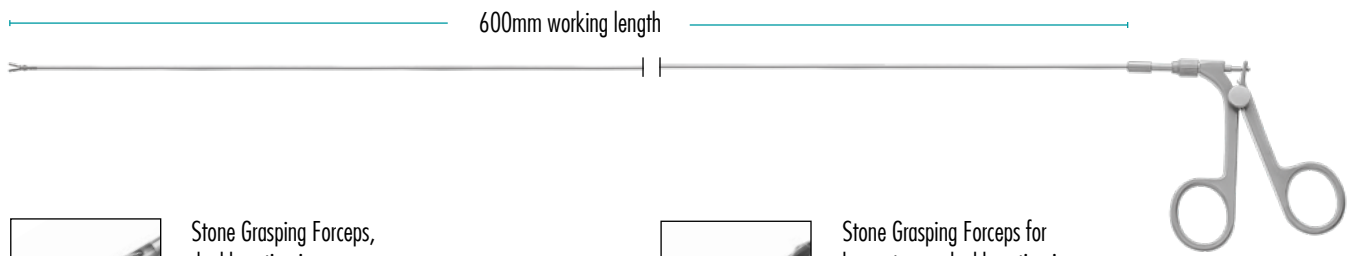

Stone Grasping Forceps,
double action jaws
253-950-003 rigid
253-951-003 flexible



Stone Grasping Forceps for
large stones, double action jaws
253-952-003 rigid
253-953-003 flexible



HAMADA long Stone Grasping
Forceps, double action jaws
253-954-003 rigid
253-955-003 flexible



Biopsy Forceps,
double action jaws
253-956-003 rigid
253-957-003 flexible



Scissors,
single action
253-958-003 rigid
253-959-003 flexible

FLEXIBLE INSTRUMENTS



253-960-025 Stone Basket, 2.5 Charr., sterile, single use, package of 5 pieces



253-962-003 Brush for Cytology, 3.0 Charr., for single use, package of 5 pieces



253-940-005 3-Prongs Grasper, flexible, 600mm working length, 5 Charr.



253-585-005 Dormia Metal Stone Basket, flexible, 4 wires, 600mm working length, 5 Charr.

Accessories



253-905-400
Silicone Valve,
package with 5 pieces



253-900-010
Silicone Valve, package with 10 pieces,
for use with very delicate instruments
from 0.5 – 1.6mm diameter.

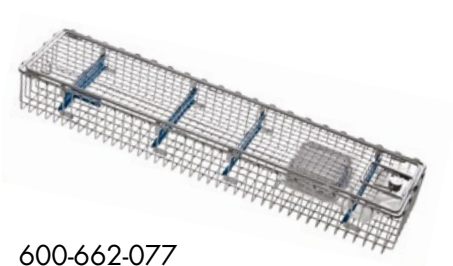

600-662-077
Endoscopic wire basket for URS
640 x 150 x 77mm

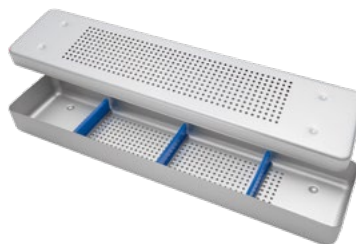

253-905-000
Container for URS with silicone inserts
640 x 140 x 60mm

PEDIATRIC

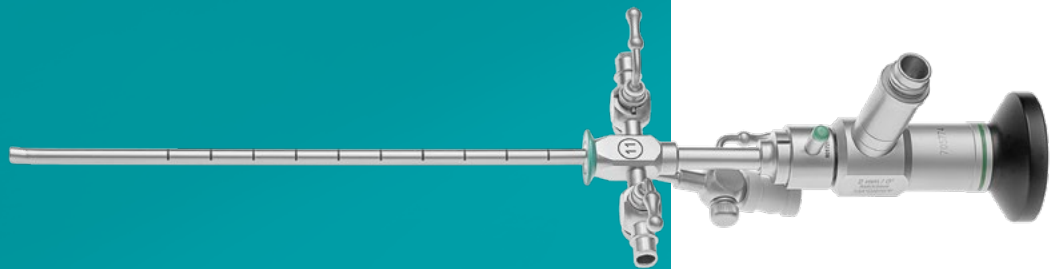

CYSTO-URETHROSCOPE SET FOR NEW BORN



RZ Cystoscope, Ø 2.0mm
 253-221-030 30°
 253-221-000 0°

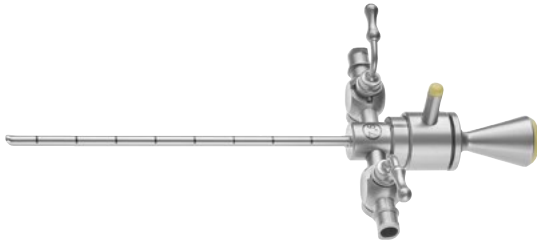

253-200-007 Cysto-Urethroscope Sheath, 7.5 Charr.

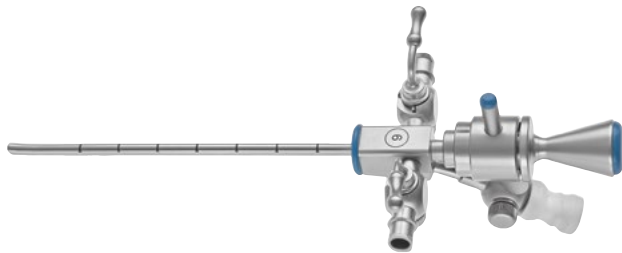

253-200-009 Cysto-Urethroscope Sheath, 9 Charr.,
 with 3 Charr. Instrument Channel

3 Charr. Instruments for new born set

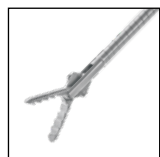
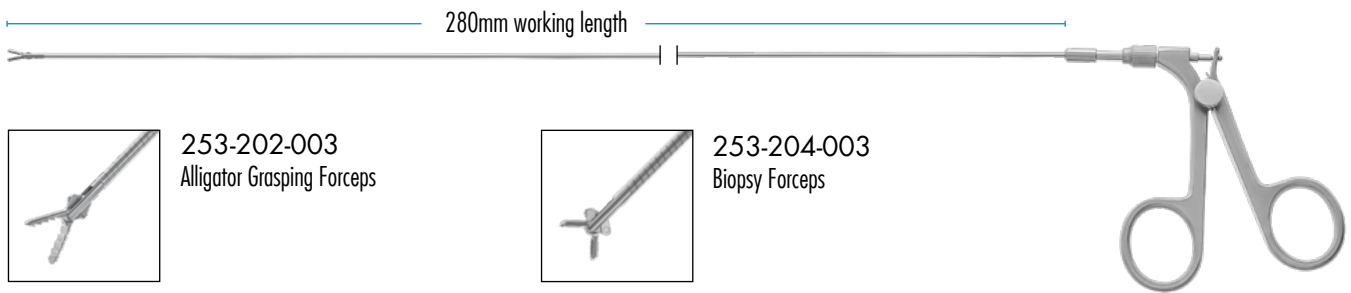

253-202-003
 Alligator Grasping Forceps



253-204-003
 Biopsy Forceps



253-370-253
 Ball Electrode, 250mm length

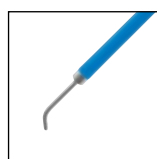

253-371-253
 Needle Electrode, 250mm length

Ø 2.0mm PEDIATRIC CYSTOSCOPY

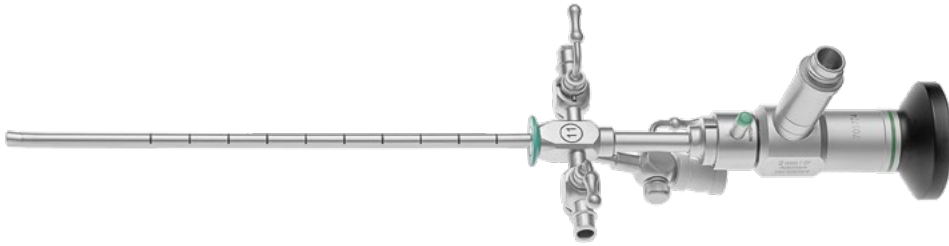

RZ Pediatric Fiber Cystoscope Ø 2.0mm, 187.5mm length
 253-219-100 0°
 253-219-130 30°



253-200-075 Pediatric Cystoscope Sheath, 7.5 Charr.

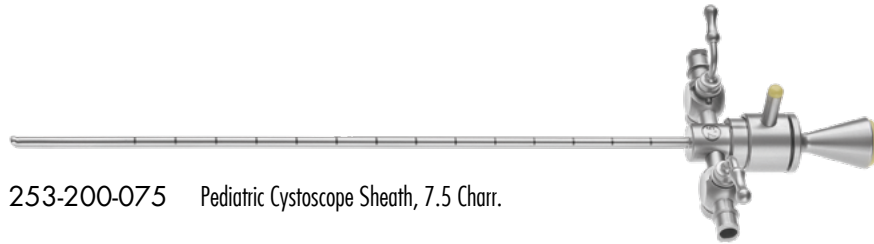

253-200-095 Pediatric Cystoscope Sheath, 9.5 Charr.
 with 4 Charr. instrument channel

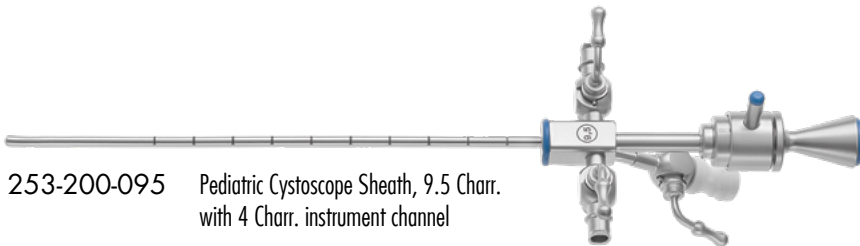

253-200-011 Pediatric Cystoscope Sheath, 11 Charr.
 with 5 Charr. instrument channel

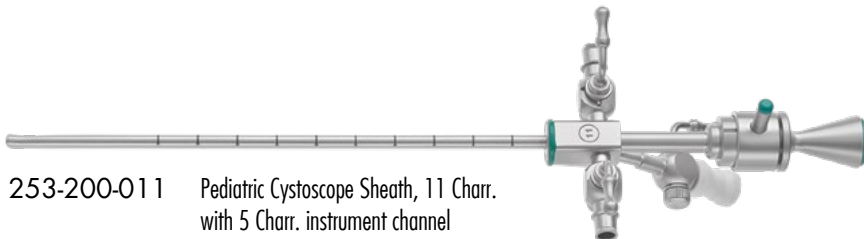

Ø 2.7mm PEDIATRIC CYSTOSCOPY



RZ Pediatric Cystoscope, 2.7mm diameter, 187.5mm working length
 253-227-000 0°
 253-227-030 30°
 253-227-070 70°

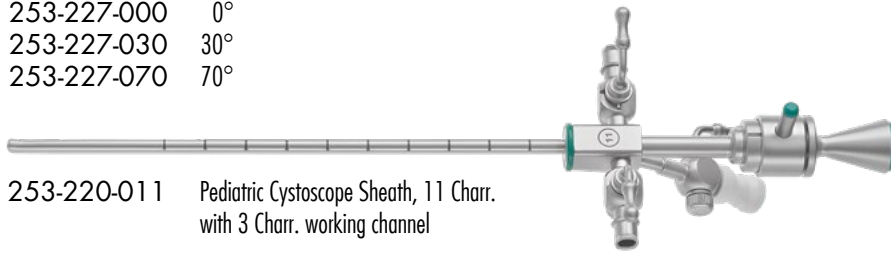

253-220-011 Pediatric Cystoscope Sheath, 11 Charr.
 with 3 Charr. working channel

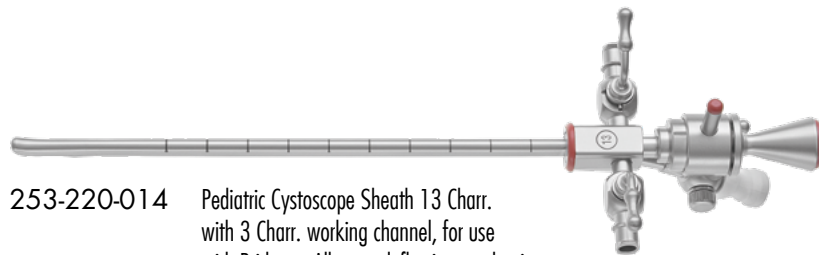

253-220-014 Pediatric Cystoscope Sheath 13 Charr.
 with 3 Charr. working channel, for use
 with Bridge or Albarran deflecting mechanism



253-220-025
 Albarran deflecting mechanism for use with 253-220-014

253-220-030
 Bridge for use with 253-220-014

3 Charr. Instruments for Ø 2.0 / 2.7mm Pediatric Cystoscopy

280mm working length



253-202-003
Alligator Grasping Forceps



253-204-003
Biopsy Forceps



253-370-253
Ball Electrode, 250mm length

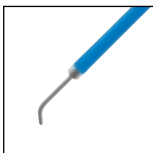

253-371-253
Needle Electrode, 250mm length



Ø 2.9mm ADOLESCENT CYSTOSCOPY



RZ Cystoscope, Ø 2.9mm
 253-829-000 0°
 253-829-030 30°

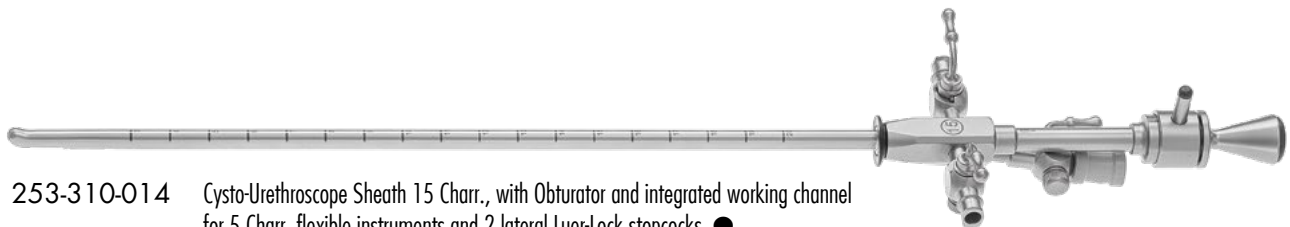

253-310-014 Cysto-Urethroscope Sheath 15 Charr., with Obturator and integrated working channel for 5 Charr. flexible instruments and 2 lateral Luer-Lock stopcocks ●

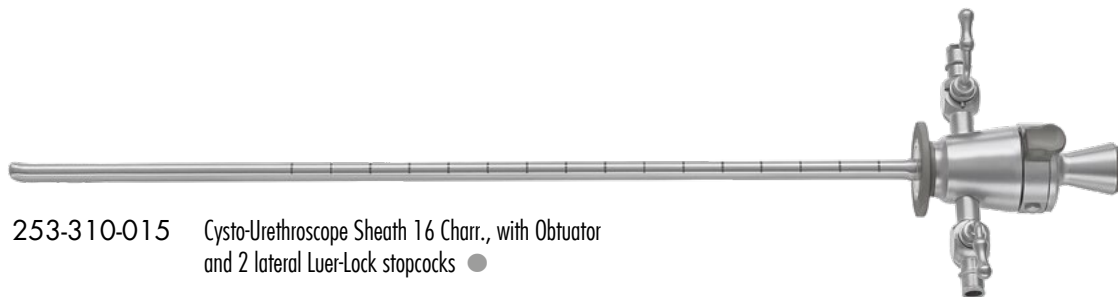

253-310-015 Cysto-Urethroscope Sheath 16 Charr., with Obturator and 2 lateral Luer-Lock stopcocks ●



1 253-310-100 Telescope bridge without channel
2 253-310-101 Telescope bridge with 1 channel for use with 253-310-014 and 5 Charr. flexible instruments



253-310-107 Albarran deflecting mechanism with 1 channel for 253-310-014, for use with one 5 Charr. instrument

Ø 2.0mm PEDIATRIC RESECTOSCOPE

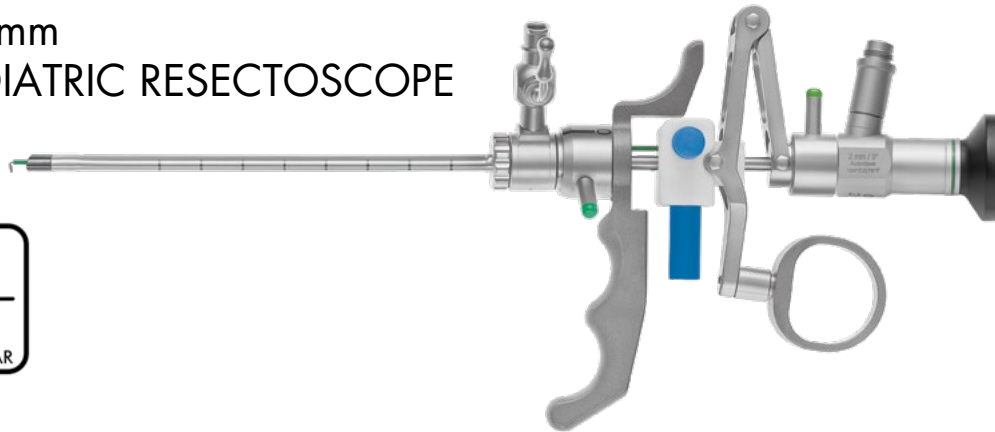

253-250-200 Passive working element for use with Ø 2.0mm RZ Fiber Cystoscope 253-219-100

RZ Pediatric Fiber Cystoscope Ø 2.0mm, 187.5mm length
253-219-100 0°
253-219-130 30°

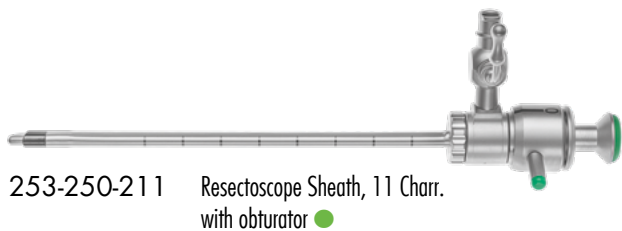
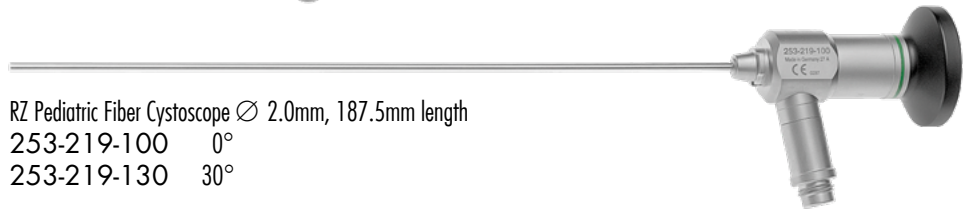

253-250-211 Resectoscope Sheath, 11 Charr. with obturator ●

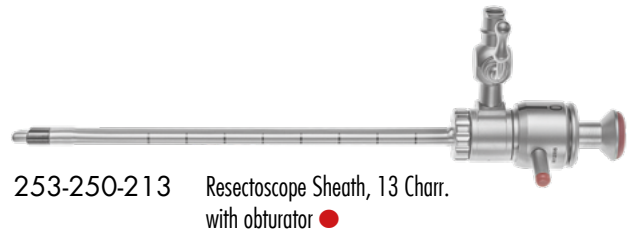

253-250-213 Resectoscope Sheath, 13 Charr. with obturator ●

Electrodes

11
CHARR.

13
CHARR.

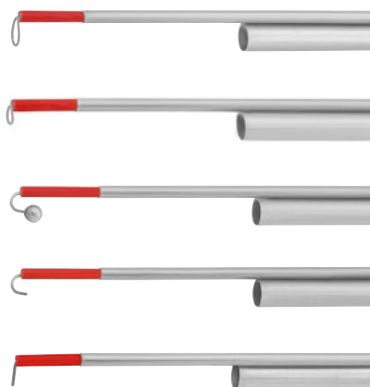

Cutting Loop

253-251-111

253-252-111

Coagulation Electrode, blunt

253-251-112

253-252-112

Hook Electrode with ball

253-251-113

253-252-113

Hook Electrode without ball

253-251-114

253-252-114

Needle Electrode, pointed

253-251-115

253-252-115

Ø 2.0mm PEDIATRIC URETHROTOME

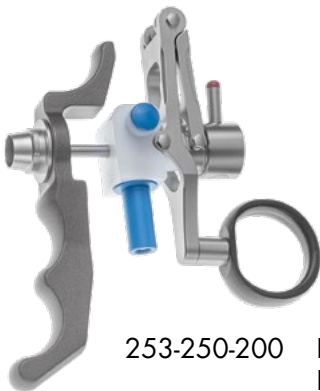
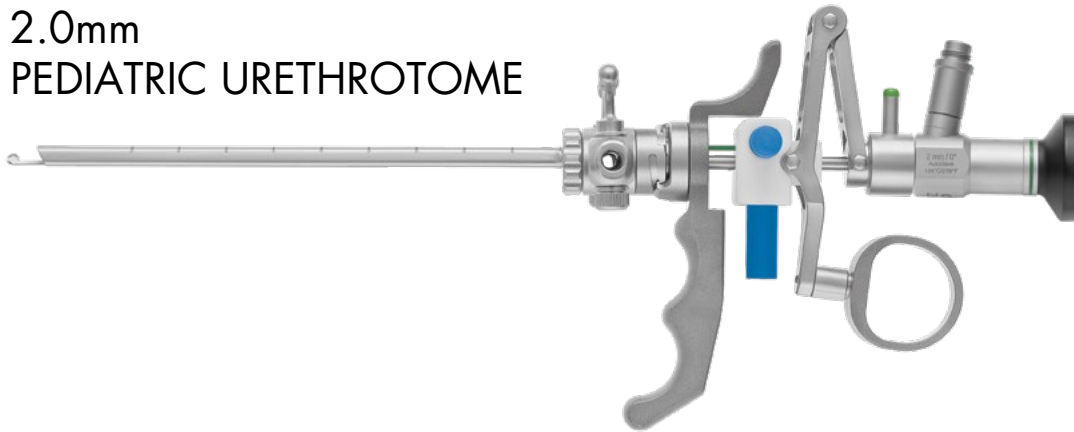

253-250-200 Passive working element for use with Ø 2.0mm RZ Fiber Cystoscope 253-219-100

RZ Pediatric Fiber Cystoscope Ø 2.0mm, 187.5mm working length
 253-219-100 0°
 253-219-130 30°

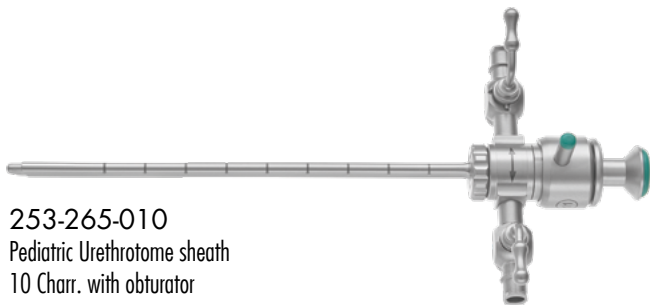
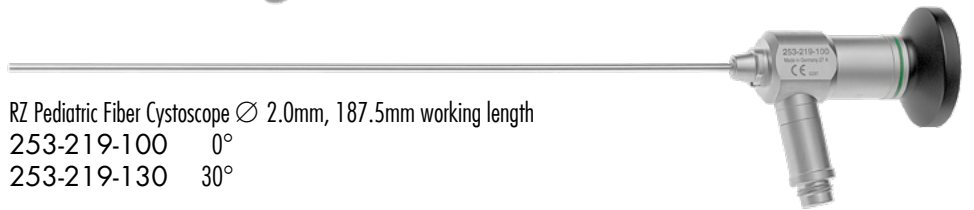

253-265-010
 Pediatric Urethrotome sheath
 10 Charr. with obturator



253-255-001 Bridge with 1 channel

Electrodes



Knife with straight cutting edge 253-265-101



Round knife 253-265-102



Sickle Knife 253-265-103



Hook Knife 253-265-104

RZ PEDIATRIC CYSTO-URETHRO-RENOSCOPE

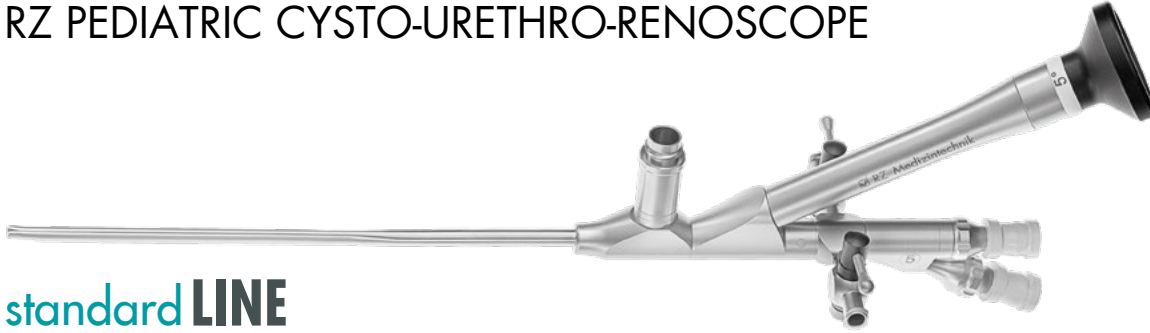

standard LINE

253-200-100 150mm

7.5
CHARR.

DISTAL

9.5
CHARR.

PROXIMAL

6.0
CHARR.

WORKING
CHANNEL*

* for use with instruments up to 5 Charr.

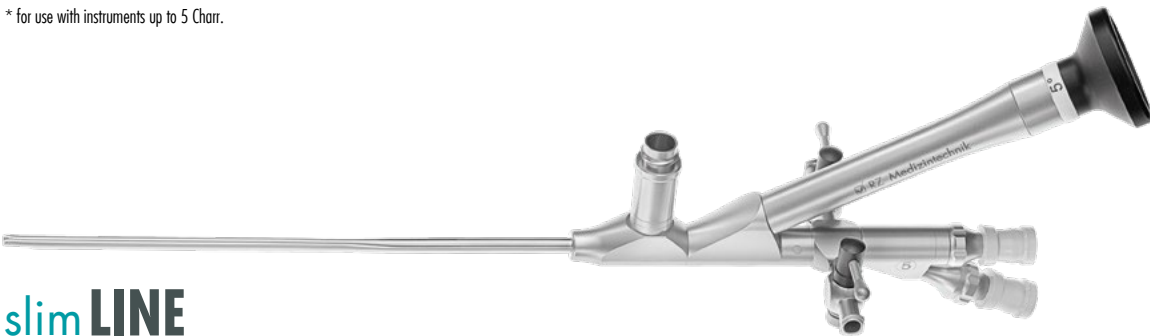

slim LINE

253-200-500 150mm

6.0
CHARR.

DISTAL

7.5
CHARR.

PROXIMAL

5.0
CHARR.

WORKING
CHANNEL*

* for use with instruments up to 4 Charr.

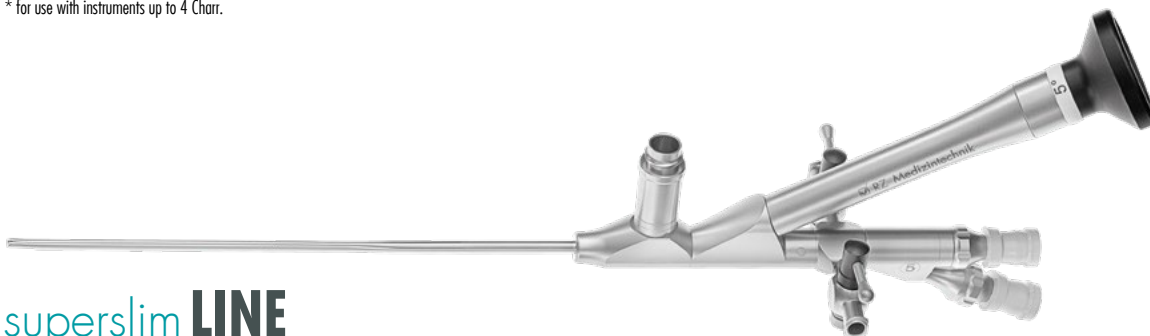

superslim LINE

253-200-600 150mm

4.5
CHARR.

DISTAL

6.0
CHARR.

PROXIMAL





3.5
CHARR.

WORKING
CHANNEL*

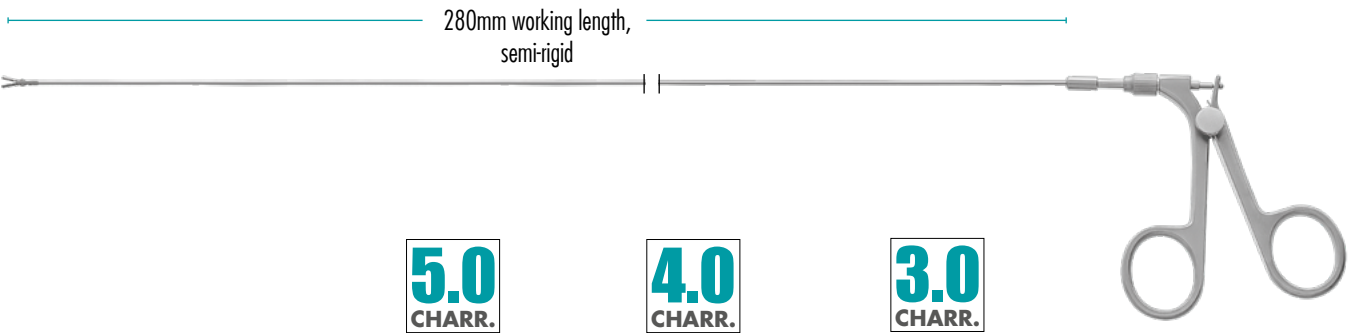

* for use with instruments up to 3 Charr.

INSTRUMENTS FOR PEDIATRIC CYSTO-URETHROTOMES

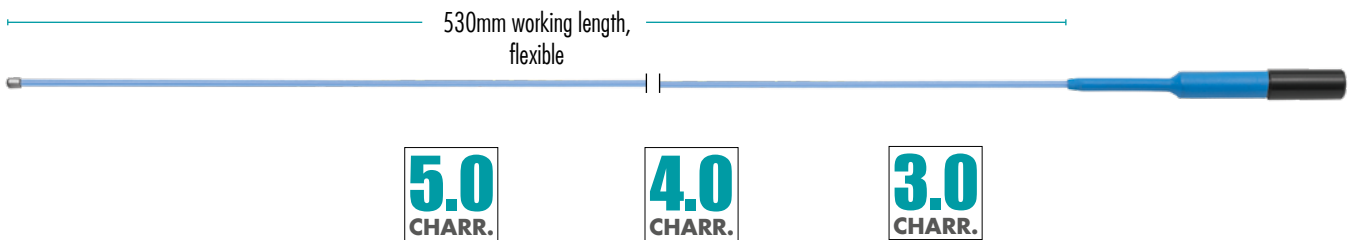

	5.0 CHARR.	4.0 CHARR.	3.0 CHARR.	
	253-200-128	253-204-128	253-203-128	Stone Grasping Forceps, double action jaws
	253-200-228	253-204-228	253-203-228	Large Stone Grasping Forceps, double action jaws
	253-200-328	253-204-328	253-203-328	Biopsy Forceps, double action
	253-200-428	253-204-428	253-203-428	Scissors, single action



	5.0 CHARR.	4.0 CHARR.	3.0 CHARR.	
	253-370-005	253-370-004	253-370-003	Ball Electrode
	253-371-005		253-371-003	Needle Electrode

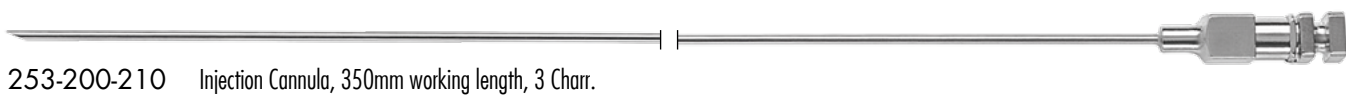

HIGH FREQUENCY CABLES

for RZ pediatric resectoscope systems, 4.5m length



253-610-001* with 5 mm plug for Erbe HF-unit

253-610-002* with 4 mm plug for Martin HF-unit

253-610-003* with 8 mm plug for Valleylab HF-unit

253-610-004* with 4 mm plug for older HF-units

700-501-453* SDS plug

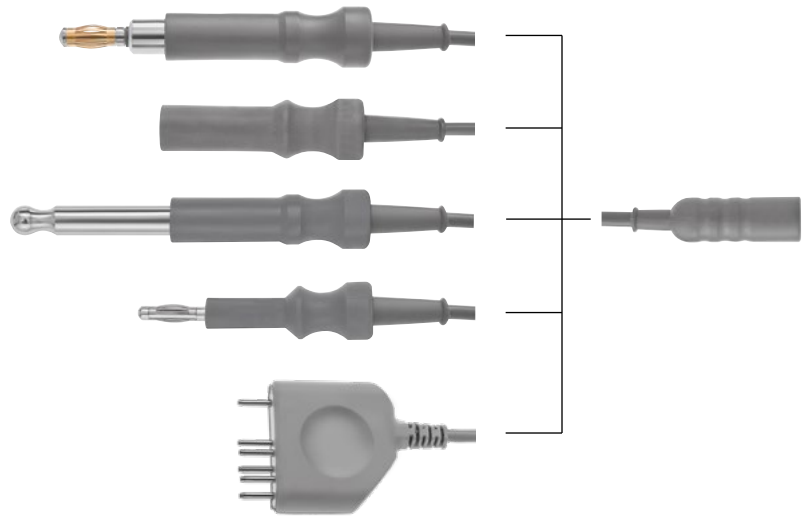

253-400-601 for Erbe HF-unit

253-400-602 for Martin HF-unit

700-500-453 SDS plug

253-400-606 for BOWA

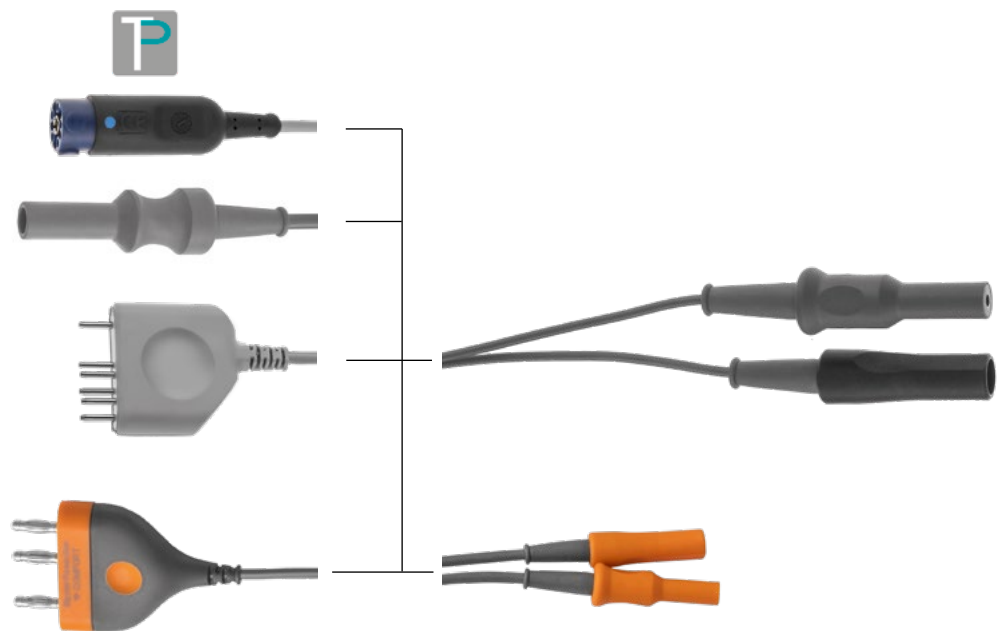

DEVICES AND FLEXIBLE INSTRUMENTS

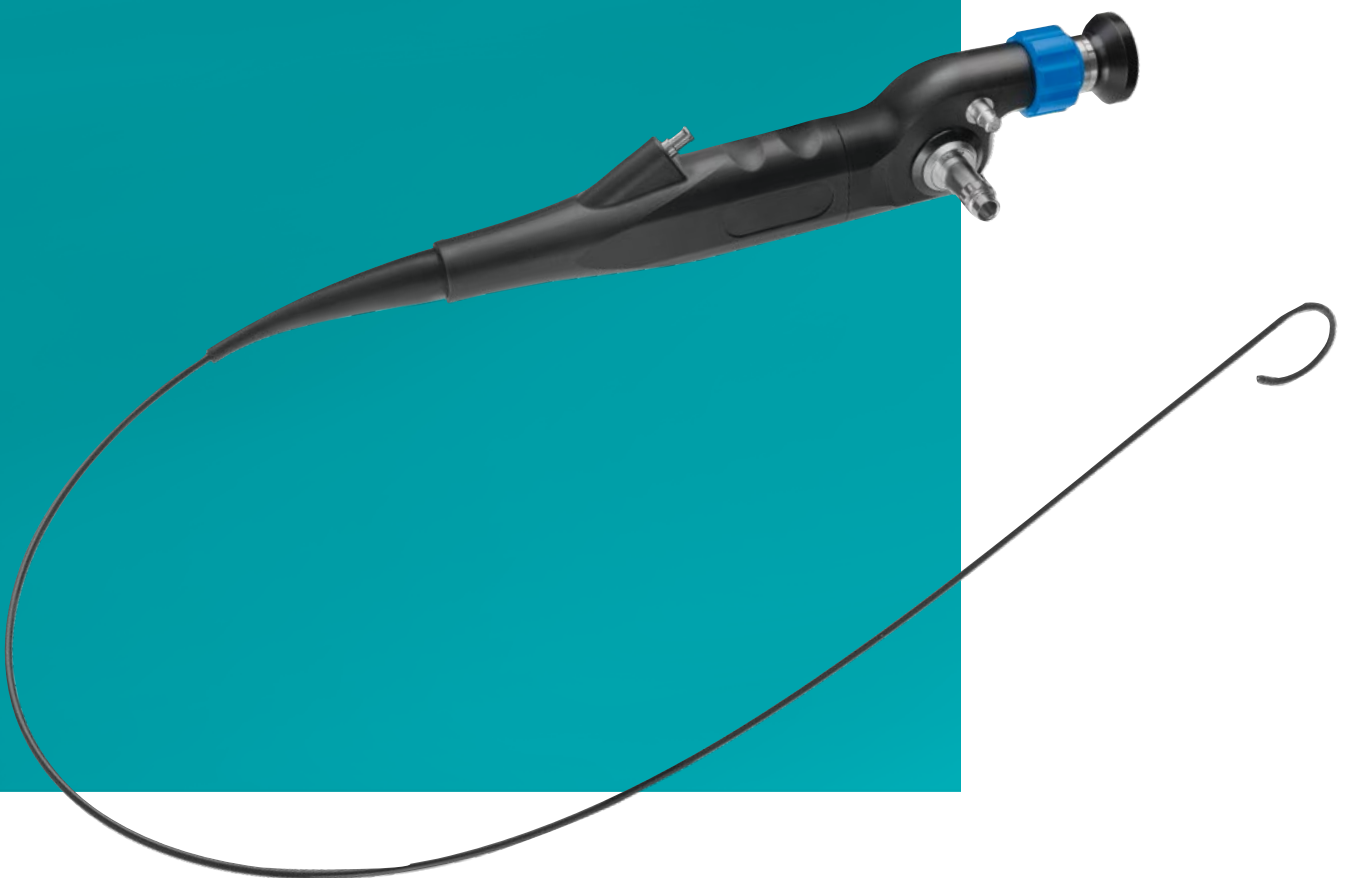

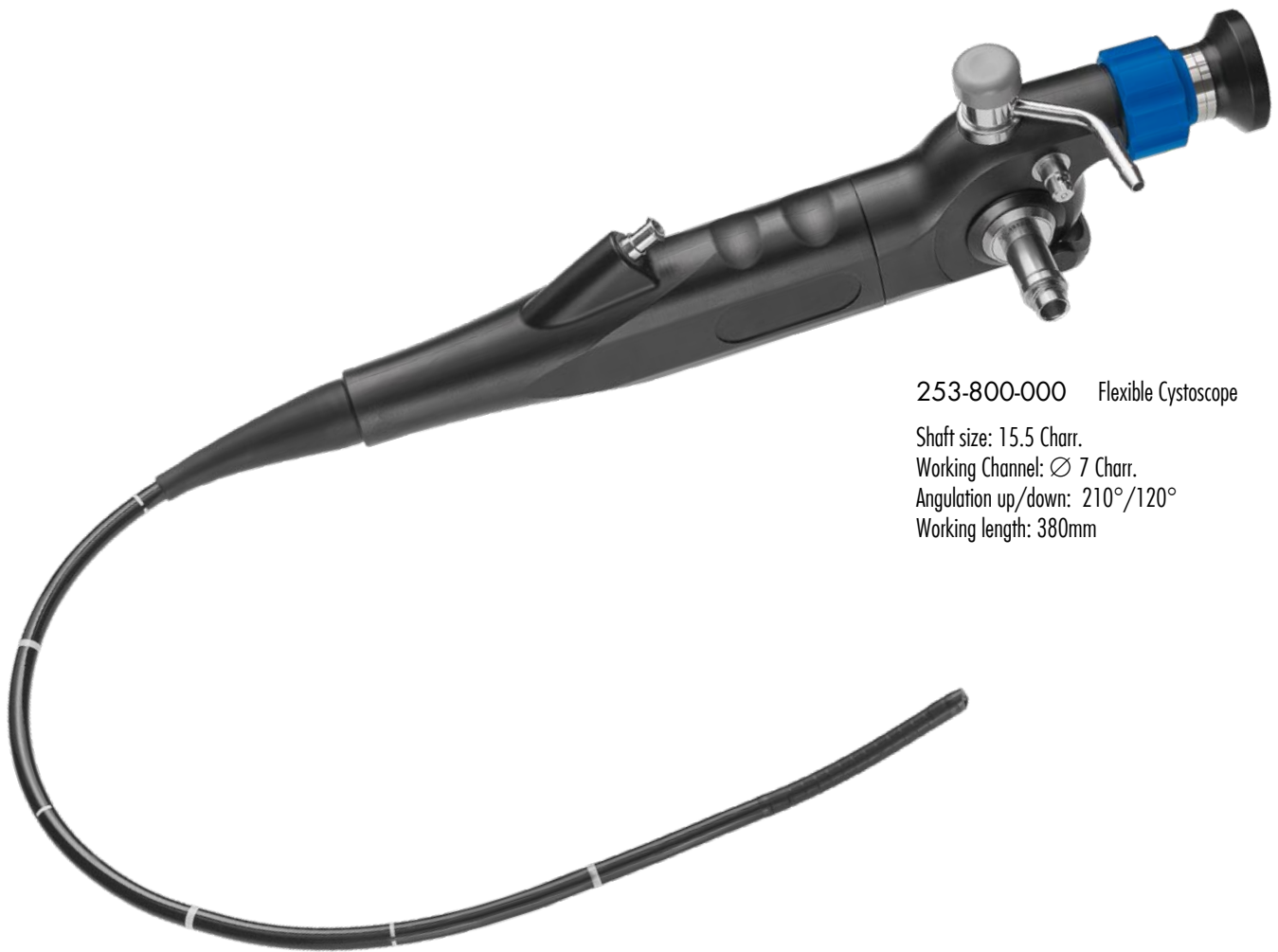

253-800-000 Flexible Cystoscope

Shaft size: 15.5 Charr.

Working Channel: \varnothing 7 Charr.

Angulation up/down: 210°/120°

Working length: 380mm



Shaft size: 15.5 Charr.
Slimline Sheath for
easy insertion



Angulation: 210°/120°



7 Charr. working
channel



Universal suction system



253-800-900 Flexible Uretero-Renoscope

Shaft size: 7.5 Charr.
 Working Channel: \varnothing 3.6 Charr.
 Angulation up/down: 275°/275°
 Working length: 680mm



Shaft size: 7.5 Charr.
 Slimline sheath for easy insertion



Angulation: 275° / 275°

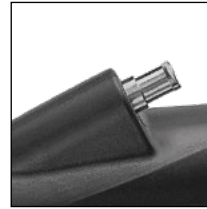

3.6 Charr. working channel



Ergonomic grip

Stone Baskets, tipless, ball shape, 120cm length, \varnothing 12mm, nitinol, sterile, single use

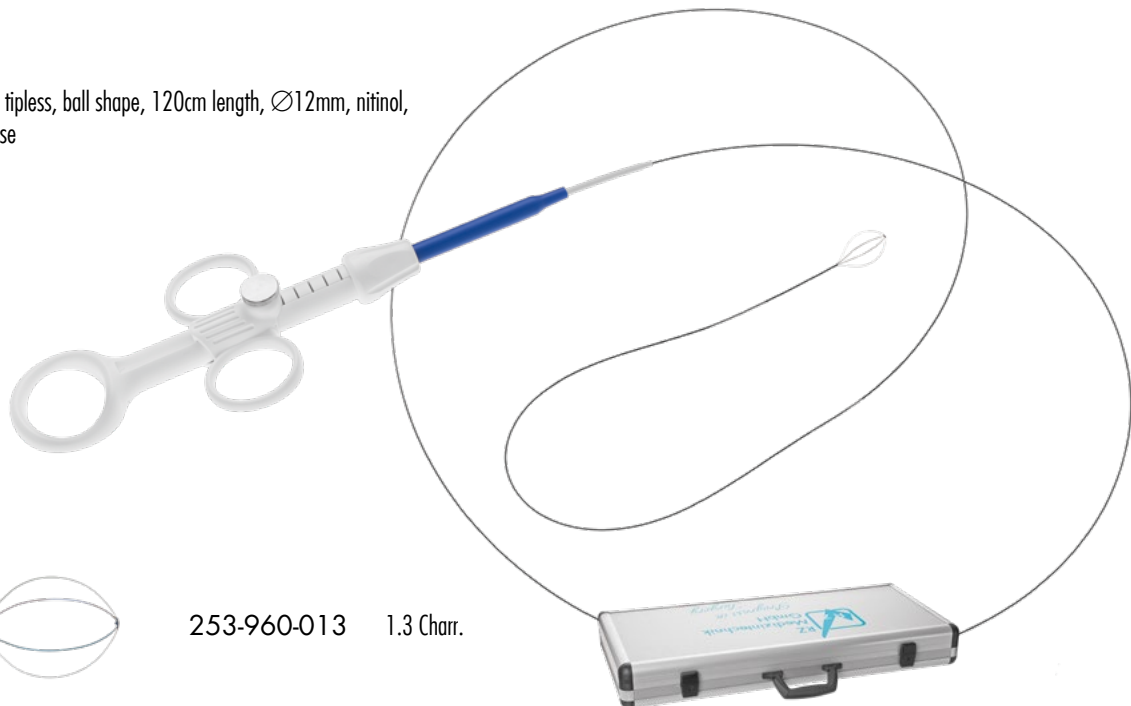

253-960-013 1.3 Charr.



253-960-019 1.9 Charr.

253-900-001
 Uretero-Renoscope carrying case

ACCESSORIES



SYRINGES & EVACUATORS

with Turn Lock connection to connect to RZ Cystoscope and Resectoscope sheaths



TOOMEY Bladder Syringe
253-000-850 50cc



Bladder Syringe		Spare Glass Cylinder	
253-000-975	75cc	253-000-976	75cc
253-000-900	100cc	253-000-901	100cc
253-000-950*	150cc	253-000-951	150cc



Elik Evacuator
253-500-000 with turn lock connection
253-500-001 with standard connection

- 1** 253-500-003 Rubber ball
- 2** 253-500-004 Glass body
- 3** 253-500-020 Turn Lock connector with silicone tube
- 4** 253-500-010 Standard connector with silicone tube

ADAPTORS & VALVES



300-011-181* Luer-Lock tube connector,
9mm



300-011-506* Luer-Lock tube connector,
6mm



300-011-184* Luer-Lock Tuohy
Borst Adapter

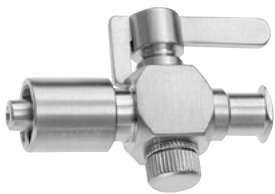

300-011-178 Luer-Lock one-way stop-cock
with spring screw cap



300-011-179* Luer-Lock tube connector
with stopcock



300-011-515* Luer-Lock one-way
stopcock



351-905-110 Silicone Valve, reusable, for
instruments up to $\varnothing 1.8\text{mm}$
(5.5Charr.), with LL-Connection,
10pcs. per package



Rubber sealing cap
301-701-100* Grey / universal
301-701-060 Green / $\varnothing 0.6\text{mm}$
301-701-030 Red / $\varnothing 0.3\text{mm}$



351-905-105 Disposable Silicone Valve
with Luer-Lock connection
for use with 3 - 10 Charr.
instruments, package with
10 pieces, sterile packed



300-400-900* Rubber Seal for
Luer-Lock connectors

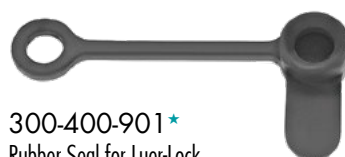

300-400-901* Rubber Seal for Luer-Lock
connectors

CATHETERS



Guyon Catheter Spanner & Introducer

- 1** 253-310-390* curved, 390mm
- 2** 253-310-391 straight, 390mm
- 253-310-392 straight, 455mm
- 253-310-393 straight, 510mm



320-603-455 Foley Catheter Spanner & Introducer, curved, 455mm



Catheter for male

- | | | | |
|-------------|-----------|-------------|-----------|
| 320-720-080 | 8 Charr. | 320-720-180 | 18 Charr. |
| 320-720-100 | 10 Charr. | 320-720-200 | 20 Charr. |
| 320-720-120 | 12 Charr. | 320-720-220 | 22 Charr. |
| 320-720-140 | 14 Charr. | 320-720-240 | 24 Charr. |
| 320-720-160 | 16 Charr. | | |



Catheter for female

- | | |
|-------------|-----------|
| 320-721-080 | 8 Charr. |
| 320-721-100 | 10 Charr. |
| 320-721-120 | 12 Charr. |
| 320-721-140 | 14 Charr. |
| 320-721-160 | 16 Charr. |
| 320-721-180 | 18 Charr. |
| 320-721-200 | 20 Charr. |
| 320-721-220 | 22 Charr. |
| 320-721-240 | 24 Charr. |

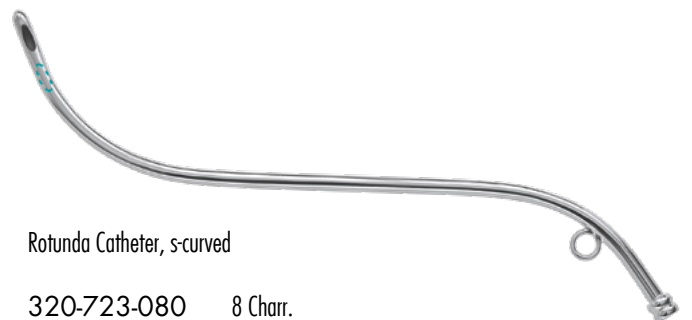

Rotunda Catheter, s-curved

- | | |
|-------------|-----------|
| 320-723-080 | 8 Charr. |
| 320-723-100 | 10 Charr. |
| 320-723-120 | 12 Charr. |
| 320-723-140 | 14 Charr. |
| 320-723-160 | 16 Charr. |
| 320-723-180 | 18 Charr. |
| 320-723-200 | 20 Charr. |
| 320-723-220 | 22 Charr. |
| 320-723-240 | 24 Charr. |

BOUGIES



Guyon Bougie, strongly curved

- 253-340-335* 8 Charr.
- 253-341-335 9 Charr.
- 253-342-335* 10 Charr.
- 253-343-335 11 Charr.
- 253-344-335* 12 Charr.
- 253-345-335* 14 Charr.
- 253-346-335* 16 Charr.
- 253-347-335* 18 Charr.
- 253-348-335* 20 Charr.

- | | |
|-----------------------|-----------------------|
| 253-349-335* 22Charr. | 253-354-335* 28Charr. |
| 253-350-335* 24Charr. | 253-355-335* 30Charr. |
| 253-351-335 25Charr. | 253-356-335 32Charr. |
| 253-352-335* 26Charr. | 253-357-335 34Charr. |
| 253-353-335 27Charr. | |

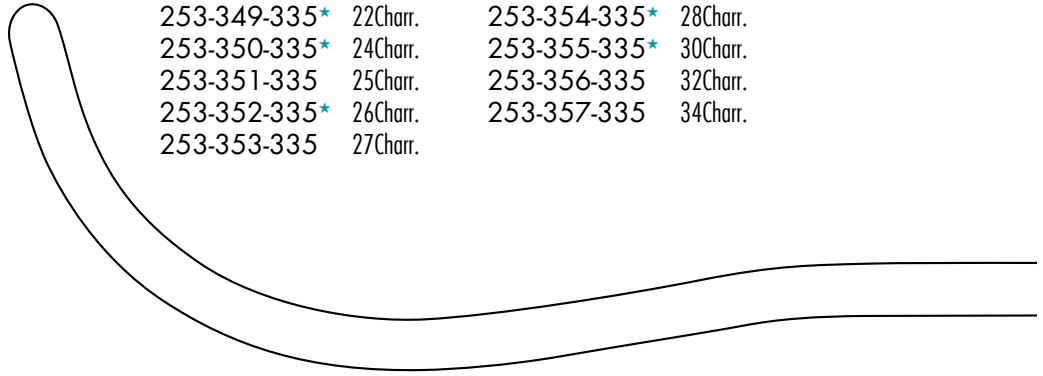

Van Buren Bougie, acutely curved

- 253-650-010* 10 Charr.
- 253-650-012* 12 Charr.
- 253-650-014* 14 Charr.
- 253-650-016* 16 Charr.
- 253-650-018* 18 Charr.
- 253-650-020* 20 Charr.
- 253-650-022* 22 Charr.

- 253-650-024* 24 Charr.
- 253-650-026* 26 Charr.
- 253-650-028* 28 Charr.
- 253-650-030* 30 Charr.
- 253-650-032 32 Charr.
- 253-650-034 34 Charr.
- 253-650-036 36 Charr.

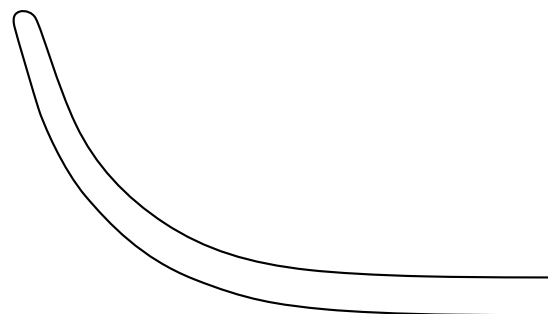

Dittel Bougie, slightly curved

- 253-320-335* 8 Charr.
- 253-321-335 9 Charr.
- 253-322-335* 10 Charr.
- 253-323-335 11 Charr.
- 253-324-335* 12 Charr.
- 253-325-335* 14 Charr.
- 253-326-335* 16 Charr.
- 253-327-335* 18 Charr.
- 253-328-335* 20 Charr.

- 253-329-335* 22 Charr.
- 253-330-335* 24 Charr.
- 253-331-335 25 Charr.
- 253-332-335* 26 Charr.
- 253-333-335 27 Charr.
- 253-334-335* 28 Charr.
- 253-335-335* 30 Charr.
- 253-336-335 32 Charr.
- 253-337-335 34 Charr.

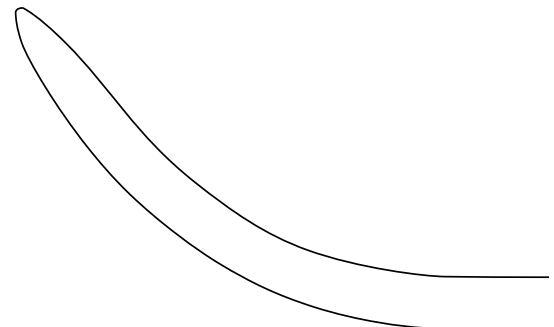

BOUGIES & DILATORS



OTIS Bougie à Boule
 253-370-009 9 - 12 - 15 - 18 Charr.
 253-370-021 21 - 24 - 27 - 30 Charr.



Dittel Bougie, straight

253-320-225	8 Charr.	253-329-225	22 Charr.
253-321-225	9 Charr.	253-330-225	24 Charr.
253-322-225	10 Charr.	253-331-225	25 Charr.
253-323-225	11 Charr.	253-332-225	26 Charr.
253-324-225	12 Charr.	253-333-225	27 Charr.
253-325-225	14 Charr.	253-334-225	28 Charr.
253-326-225	16 Charr.	253-335-225	30 Charr.
253-327-225	18 Charr.	253-336-225	32 Charr.
253-328-225	20 Charr.	253-337-225	34 Charr.



RZ Orifice Dilator
 253-375-015 15 - 30 Charr.



Ureteral Dilator, flexible, 500mm



253-920-090 9.0 Charr.



253-920-135 13.5 Charr.



253-920-105 10.5 Charr.



253-920-150 15.0 Charr.



253-920-120 12.0 Charr.

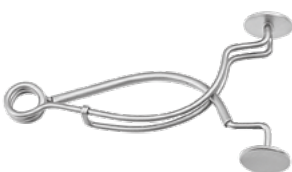

320-998-000 Stockmann Meatus Clamp, 8cm



320-999-000* Strauss Penis Seizing Forceps, 13cm

CLEANING

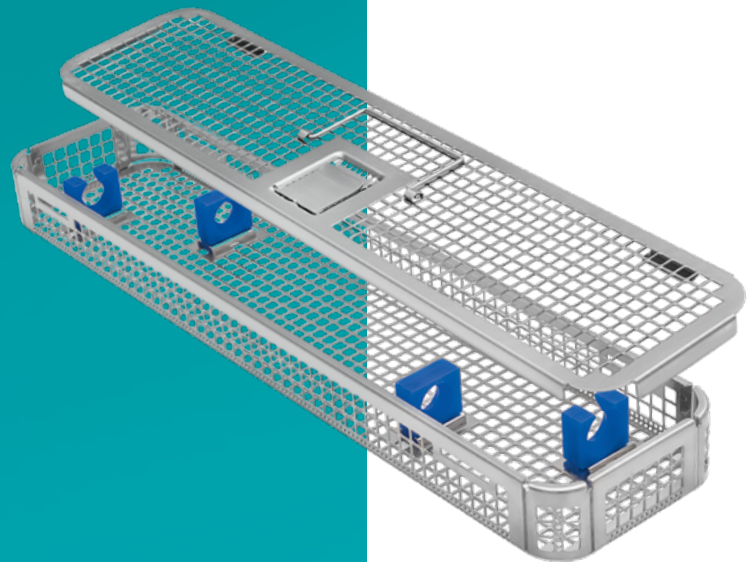

SAFE + CLEAN ENDOSCOPE PLASTIC CONTAINER with silicone bars on base and lid

600-505-000

Endoscopes	1 (∅ 1-10mm)
Endoscope length	max. 270mm
Dimensions	271 x 70 x 35mm

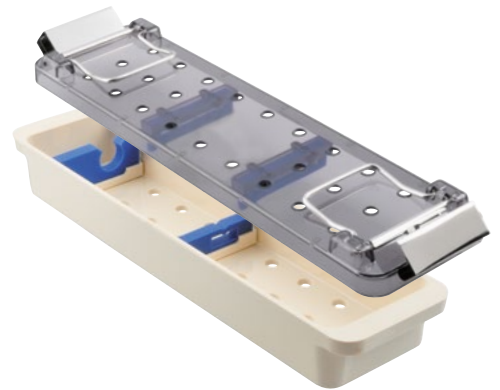

600-505-002

Endoscopes	max. 2
Endoscope length	max. 190mm
Dimensions	271 x 70 x 35mm

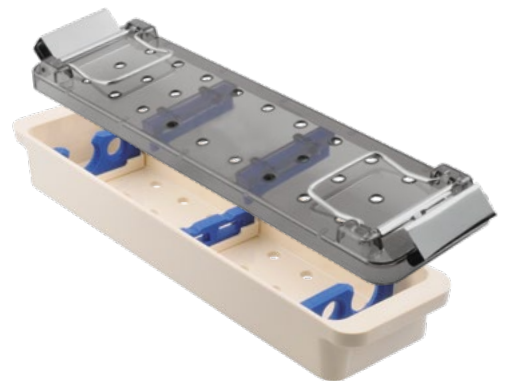

600-506-002*

Endoscopes	max. 2
Endoscope length	max. 390mm
Dimensions	394 x 70 x 35mm

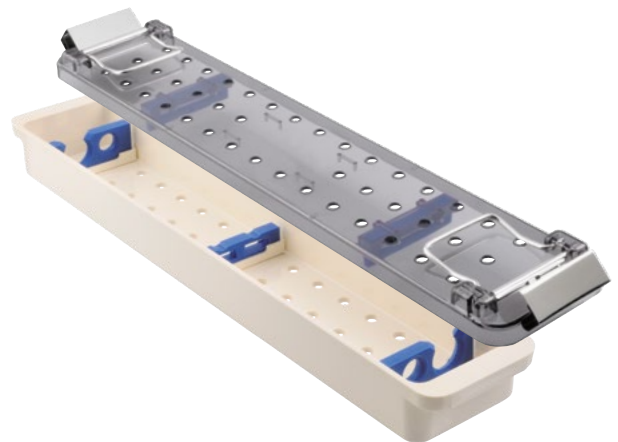

600-501-000

Endoscopes 1

600-501-002

Endoscopes max. 2

Endoscope length	max. 450mm
Dimensions	457 x 70 x 35mm

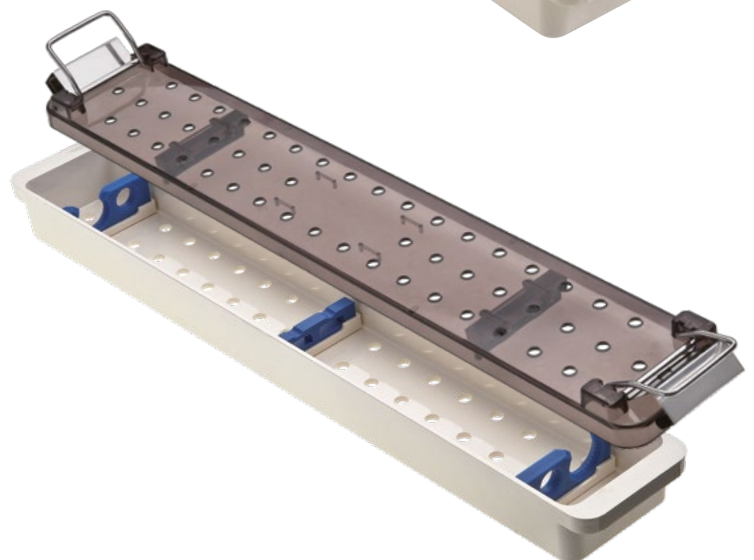

ENDOSCOPE & INSTRUMENT CONTAINERS

600-508-000 for scopes and light guide cables

Endoscopes	max. 3 (Ø 5-10mm)
Fiber Optic Light Cable	1
Endoscope length	max. 450mm
Dimensions	465 x 212 x 51mm

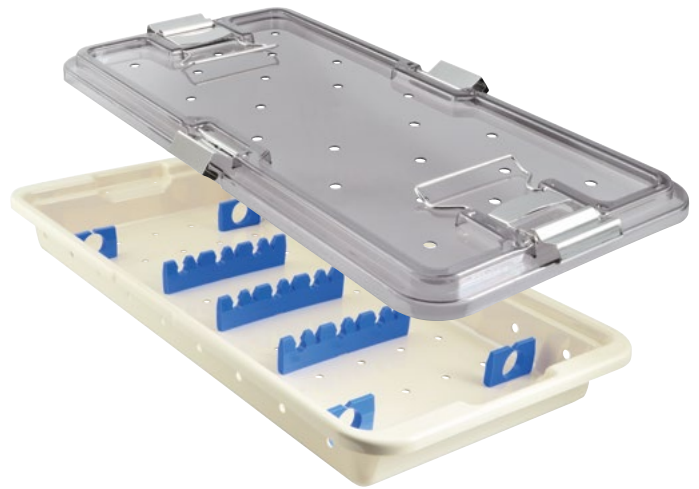

600-464-229 for fixation of instruments with rubber ties

Dimensions	464 x 229 x 51mm
------------	------------------

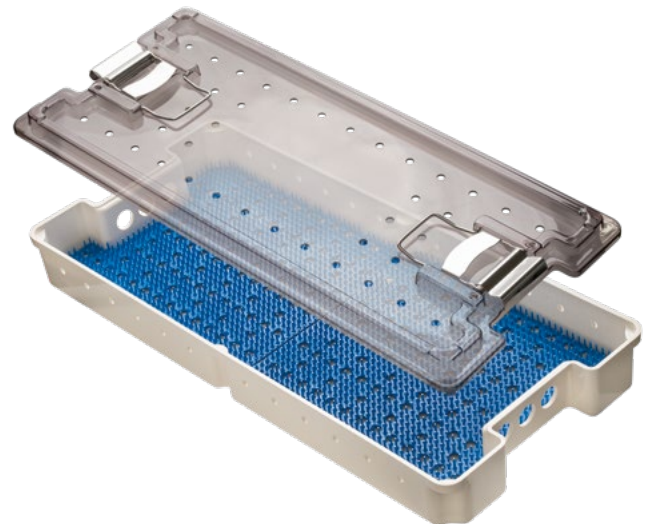

600-511-000 for instruments with rubber ties on 2 levels

Dimensions	502 x 239 x 102mm
------------	-------------------



ENDOSCOPE CLEANING BASKETS & CONTAINERS with silicone bars on base and lid

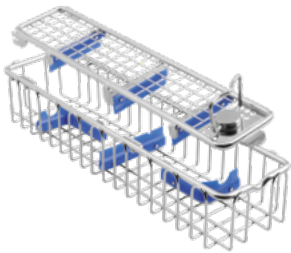

600-292-052*

Endoscopes	max. 2
Endoscope length	max. 190mm
Dimensions	290 x 80 x 52mm

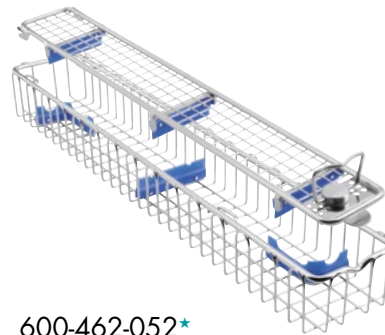

600-462-052*

Endoscopes	max. 2
Endoscope length	max. 350mm
Dimensions	460 x 80 x 52mm

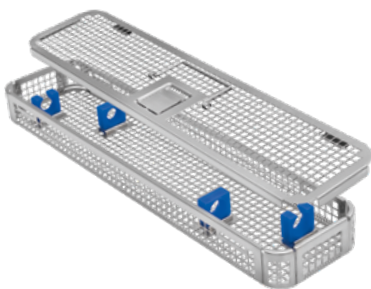

600-460-055	Endoscopes 1
600-460-056	Endoscopes max. 2
Endoscope length	max. 340mm
Dimensions	455 x 86 x 43mm



600-450-070	Endoscopes max. 2
Endoscope length	max. 330mm
Dimensions	450 x 70 x 70mm

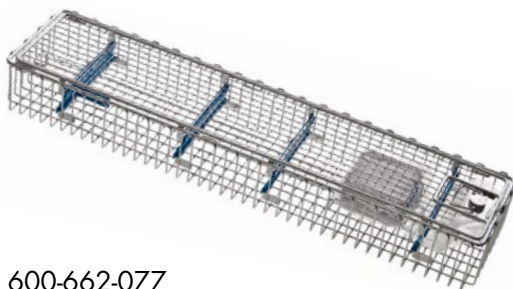

600-662-077
Endoscopic wire basket for URS
640 x 150 x 77mm

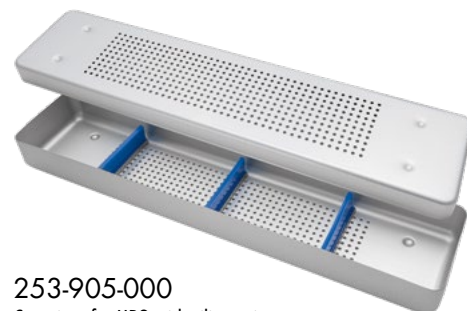

253-905-000
Container for URS with silicone inserts
640 x 140 x 60mm

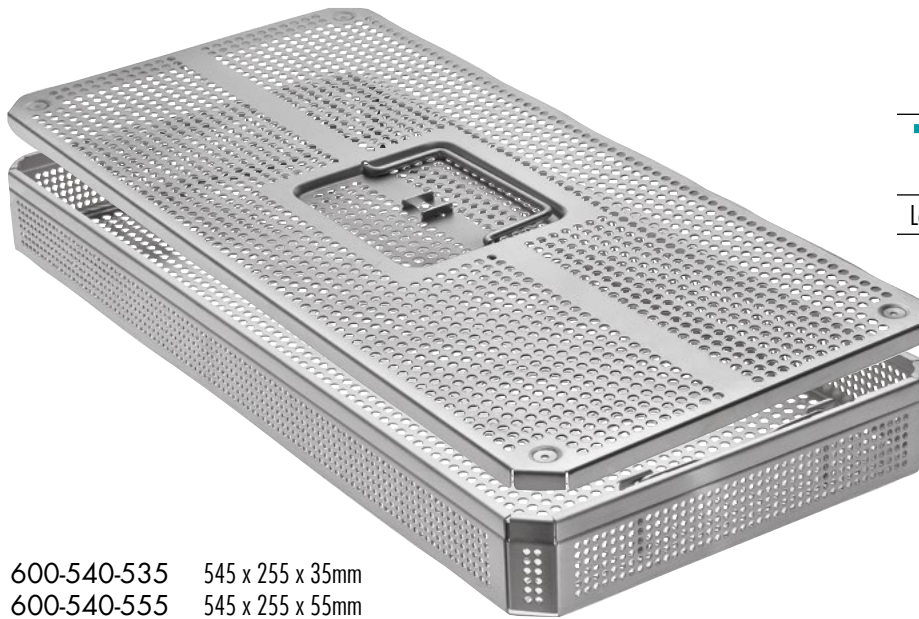

1/1	Stainless Steel Basket, round perforation, with lid
Length	545mm

- 600-540-535 545 x 255 x 35mm
- 600-540-555 545 x 255 x 55mm
- 600-540-575 545 x 255 x 75mm
- 600-540-605 545 x 255 x 105mm



- Lid only
- 600-540-500 545 x 255 mm



- Bottom only
- 600-540-530 545 x 255 x 30mm
- 600-540-550 545 x 255 x 50mm
- 600-540-570 545 x 255 x 70mm
- 600-540-600 545 x 255 x 100mm

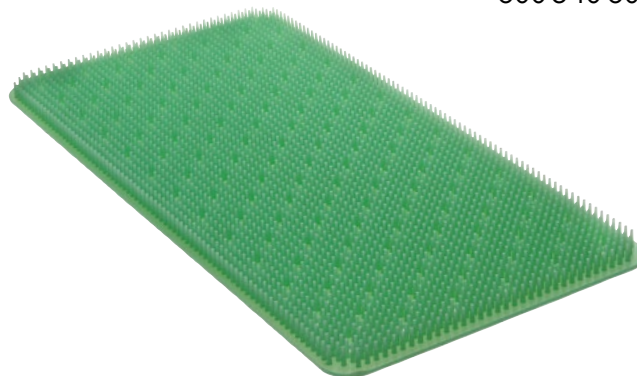

- 600-281-004 Silicone Mat green, 520 x 230mm

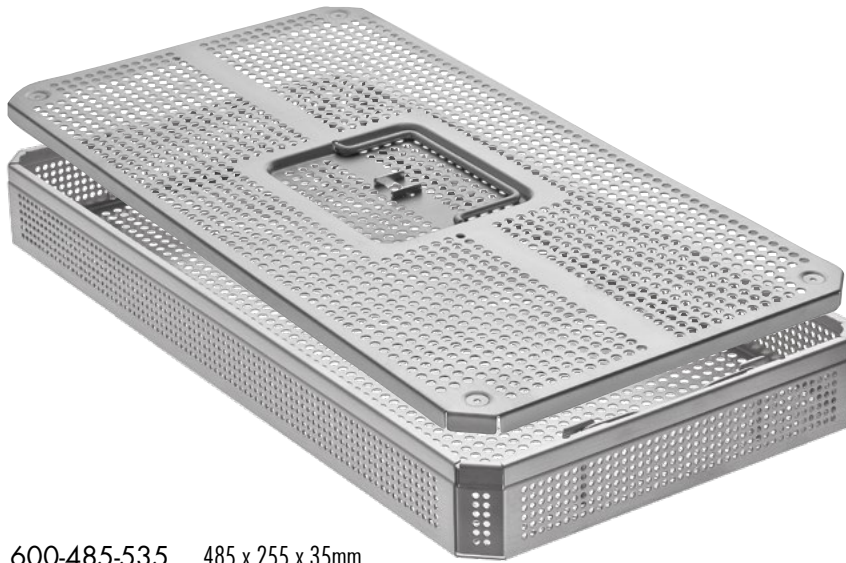

1/1

Stainless Steel Basket,
round perforation, with lid

Length

485mm

600-485-535 485 x 255 x 35mm
 600-485-555 485 x 255 x 55mm
 600-485-575 485 x 255 x 75mm
 600-485-605 485 x 255 x 105mm



Lid only
 600-485-500 485 x 255 mm

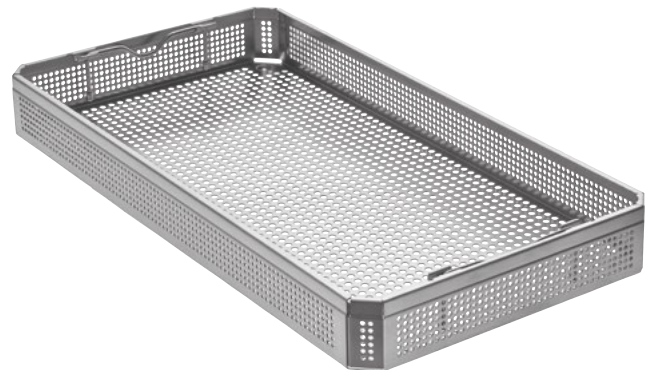

Bottom only
 600-485-530 485 x 255 x 30mm
 600-485-550 485 x 255 x 50mm
 600-485-570 485 x 255 x 70mm
 600-485-600 485 x 255 x 100mm

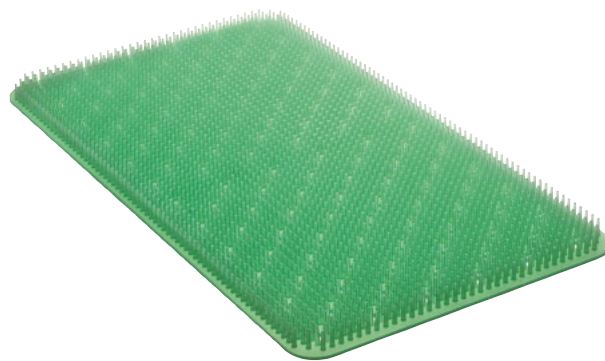

600-281-003 Silicone Mat green, 440 x 230mm

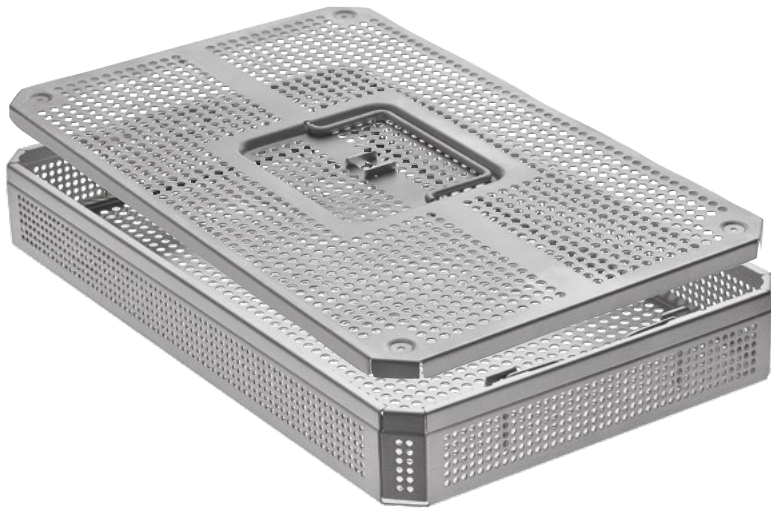

3/4

Stainless Steel Basket,
round perforation, with lid

Length

405mm

600-405-535 405 x 255 x 35mm
 600-405-555 405 x 255 x 55mm
 600-405-575 405 x 255 x 75mm
 600-405-605 405 x 255 x 105mm



Lid only
 600-405-500 405 x 255 mm

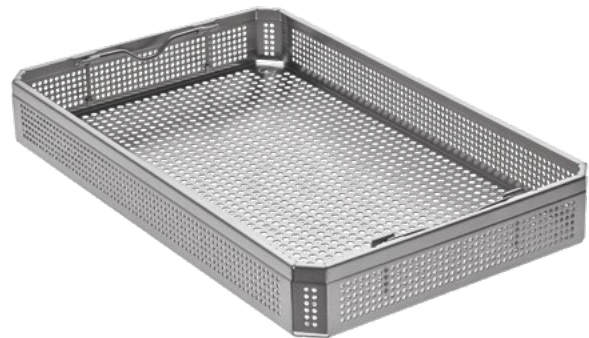

Bottom only
 600-405-530 405 x 255 x 30mm
 600-405-550 405 x 255 x 50mm
 600-405-570 405 x 255 x 70mm
 600-405-600 405 x 255 x 100mm

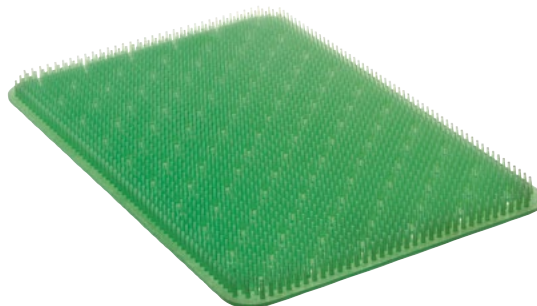

600-281-002 Silicone Mat green, 380 x 230mm



1/2

Stainless Steel Basket,
round perforation, with lid

Length

255mm

600-255-535 255 x 245 x 35mm
 600-255-555 255 x 245 x 55mm
 600-255-575 255 x 245 x 75mm
 600-255-605 255 x 245 x 105mm

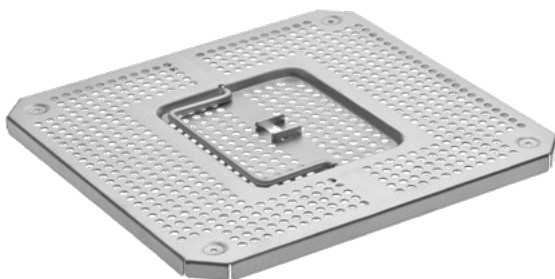

Lid only
 600-255-500 255 x 245 mm



Bottom only
 600-255-530 255 x 245 x 30mm
 600-255-550 255 x 245 x 50mm
 600-255-565 255 x 245 x 70mm
 600-255-600 255 x 245 x 100mm



600-281-001 Silicone Mat green, 220 x 230mm

Cleaning



600-100-000
RZ-Aquajet
Water Jet Pistol complete
with 9 tips and 1m pressure
tubing, with strap and
suspension hook



600-050-000
Hand brush, autoclavable
(10 pcs. per box)



600-950-100
RZ - Brush dispenser
for 10 brushes with suspension hook



700-900-220 Special Cotton for polishing metal sheaths and instruments

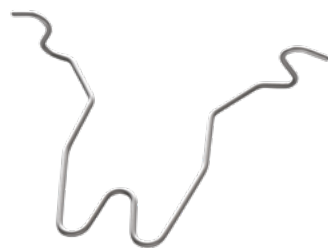

660-166-100
Holding Device for cleaning & sterilization



700-900-160
Instrument Oil in 50ml bottle



700-900-250
Oil Dispenser, 140mm



Cleaning brush (1 piece per box), 500mm length
300-135-905 for \varnothing 5 mm
300-135-910 for \varnothing 10 mm



300-215-000 Cleaning Brush, \varnothing 13mm, 215mm length, 60mm brush length



300-420-065 Cleaning Brush, \varnothing 3mm, 420mm length, 65mm brush length

EQUIPMENT



FLUID MANAGEMENT



Features:

- Versatile Irrigation Pump
- Pump leveling adjustment
- Pressure controlled roller pump

DELIVERY CONTAINS:

- Pump device
- Tubing set (253-910-001)
- Mains cable
- 2 Spare fuses
- Operating manual

253-910-000 Basic Irrigation Pump P1

Technical data

Line voltage	100-240 VAC
Power input	80VA
Irrigation power	0 - 1.0L/min
Pressure range	10 - 150mmHG
Measurements	380 x 130 x 400mm (WxHxD)
Weight	approx. 11kg

Accessories

253-910-001	Irrigation Tubing Set, silicone, autoclavable	non-sterile	included
253-910-002	Irrigation Tubing Set, PVC, 20 pieces, daily tube	sterile	optional
253-910-003	Patient tube, PVC, 2.5m, 40 pieces	sterile	optional

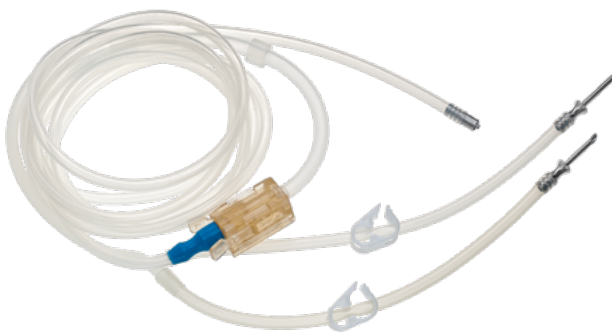

4K CAMERA SYSTEM



300-001-840 4K 3-Chip UHD-Camera K 4000

4K

Features:

- 4K UHD resolution with 3-chip technology
- Image algorithm enhancement of color and structure
- 4K video recording
- 4K image saving
- Camera head with 4 programmable buttons
- Boost function
- Fog reduction
- Freeze function
- 2.5x digital zoom
- 10 USER mode configurations
- Multilingual on screen menu
- SDI 4K Output
- Text generator (optional with keyboard)

DELIVERY CONTAINS:

- Main Unit (300-001-840)
- Camera head (300-001-841)
- HDMI cable
- USB Pen Drive
- Mains cable
- Operating manual

Technical data

Line voltage	100-240 VAC	Video outputs	1x HDMI 4K 1x HDMI FullHD 1x SDI 4K 1x SDI FullHD
Power consumption	60VA	Dimensions	Control unit: 355 x 103 x 350mm (WxHxD) Weight control unit: 6.2kg Weight camera head: 145g
Image sensor	3 MOS		
Resolution	3840 x 2160 pixels (4K)		
Index ratio	16:9		
N/N ratio	54db		

Accessories



300-001-841
UHD 3-Chip Camera Head
(included in the set)



300-001-615
Title generator keyboard, waterproof IP68
US-Layout, cable 1.8m, color: grey,
305x140x15mm, 600gr.



300-001-610
Footswitch for HD Cameras
cable length: 2m

FULL HD CAMERA SYSTEM



Features:

- Full HD camera with 3-chip MOS technology
- Pure Natural Colors technology
- Full HD video recording (F4 only)
- Full HD image saving (F4 only)
- Camera head with 3 programmable buttons
- Boost function
- Freeze function
- 2.5x digital zoom
- 3 USER mode configurations
- Multilingual on screen menu
- Different digital video outputs
- Text generator (optional with keyboard)

DELIVERY CONTAINS:

- Main Unit
- Camera head
- YPbPr/RGB cable
- 2x BNC cable
- Jack Cable
- HDMI - DVI cable
- HDMI cable
- S-Video cable
- USB Pen Drive (F4 only)
- Mains cable
- Operating manual

- 300-001-800 3 Chip HD-Camera F3
- 300-001-804 3 Chip HD-Camera F4 (with recording function)

FULL HD

Technical data

Line voltage	100-240 VAC
Power input	20W
Image sensor	3 MOS
Resolution	1920 x 1080 pixels (FullHD)
Image resolution	>1000 TV lines, horizontal
Index ratio	16:9
Min. sensitivity	< 3lx (1/1.4)
Shutter speed	1/50 (1/60) to 1/100.000sec

Video outputs (F4)	2 x HD SDI 1x HDMI / DVI 2x CVBS 1 x YPbPr / RGB 1 x Y/C (Pal/NTSC) 1x CVBS (Pal/NTSC)
--------------------	--

Video outputs (F3)	1 x HDMI / DVI 1 x YPbPr (Component) 1 x Y/C (Pal/NTSC) 1x CVBS (Pal/NTSC)
--------------------	---

Dimensions	Control unit: 380 x 120 x 360mm (WxHxD) Weight control unit: 11kg Weight camera head: 145g
------------	--

Accessories



300-001-802
High-End 3-MOS Camera Head
FullHD (included in the set)



300-001-615
Title generator keyboard, waterproof IP68
US-Layout, cable 1.8m, color: grey,
305x140x15mm, 600gr.



300-001-610
Footswitch for HD Cameras
cable length: 2m

FULL HD CAMERA SYSTEM



Features:

- Full HD camera with 1-chip MOS technology
- Natural color technology
- Full HD video recording (F2 Pro only)
- Full HD image saving (F2 Pro only)
- Camera head with 3 programmable buttons
- Boost function
- Freeze function
- 2.5x digital zoom
- 3 USER mode configurations
- Multilingual on screen menu
- HDMI video outputs
- Text generator (optional with keyboard)

300-001-600 HD-Camera F1
 300-001-601 HD-Camera F2 Pro (with recording function)

FULL HD

Technical data

Line voltage	100-240 VAC
Power input	F2 Pro: 30W / F1: 20W
Image sensor	1/3" MOS
Resolution	1920 x 1080 pixels (FullHD)
Image resolution	>1000 TV lines, horizontal
Index ratio	16:9
Min. sensitivity	< 3lx (1/1.4)

DELIVERY CONTAINS:

- Main Unit
- Camera head
- YPbPr/RGB cable
- 2x BNC cable
- HDMI - DVI cable
- HDMI cable
- S-Video cable
- Jack cable
- USB Pen Drive (F2 Pro only)
- Operating manual
- Mains cable

Video outputs (F2 Pro)	2 x HD SDI (optional) 1 x HDMI / DVI 1 x Y-Pb-Pr (Component) 1 x Video (PAL/NTSC) 1 x S-Video (PAL/NTSC)
Video outputs (F1)	1 x HDMI 1 x YPbPr / RGB 1 x S-Video (Y/C; Pal / NTSC) 1 x Video (CVBS; Pal / NTSC)
Dimensions	Control unit: 380 x 120 x 360mm (WxHxD) Weight control unit: 11kg Weight camera head: 105g

Accessories



300-001-602
 High-End 1/3" MOS Camera Head
 Full HD (included in the set)



300-001-615
 Title generator keyboard, waterproof IP68
 US-Layout, cable 1.8m, color: grey,
 305x140x15mm, 600gr.



300-001-610
 Footswitch for HD Cameras
 cable length: 2m

TV COUPLER



4K
FULL HD

300-001-823 f=14mm
300-001-824 f=25mm
300-001-825 f=28mm
c-mount, soakable



4K
FULL HD

250-015-030
Zoom-TV-Adapter
f=15 - 30mm
c-mount, soakable



4K
FULL HD

250-015-036
Zoom-TV-Adapter
f=15 - 36mm
c-mount, soakable



FULL HD

300-001-813 f=14mm
300-001-814 f=25mm
300-001-815 f=28mm
c-mount, soakable



FULL HD

250-020-025 F=25mm (splitting 90/10)
250-020-030 F=30mm (splitting 90/10)
Beamsplitter, allows simultaneous video
and direct views, c-mount, soakable

LED LIGHT SOURCE



Features:

- 6500K daylight color temperature
- 375 Watt equivalent output power
- > 20.000 hours lifetime
- Turret connector for the most common light cables (Olympus, Wolf, Gyrus ACMI, Storz)
- Manual or automatic light control
- Waterproof touch control panel
- Low heat conduction by improved LED technology
- Boost function: light increase of 20%

300-900-300 LUMEN LED 3 PRO Light Source, 110 - 230V



Technical data

Line voltage	100-240 VAC
Video input	1x Video, BNC
Protection class	1 (acc. IEC 60601-1) 1 (acc. MDD 93/42/EEC)
Safety class	BF
Standard	IEC 60601-1-2
Dimensions	380 x 120 x 360mm (WxHxD)
Weight	approx. 11kg

DELIVERY CONTAINS:

- Main Unit (300-900-300)
- BNC cable (optional)
- Mains cable
- Operating manual



- A **OLYMPUS**
- B **WOLF**
- C **GYRUS ACMI**
- D **STORZ**

Turret, multi connector

LED LIGHT SOURCE



Features:

- More than 20.000h lamp lifetime
- 180 Watt equivalent power output
- Manual or automatic light control
- Waterproof touch control panel
- Low heat conduction by improved LED technology
- Daylight color temperature 6000 – 6500° K for accurate color representation
- Boost function: light increase of 20%

300-900-180 LUMEN LED 1 Light Source



DELIVERY CONTAINS:

- Main Unit (300-900-180)
- BNC cable
- Mains cable
- Operating manual

Technical data

Line voltage	100-240 VAC
Power consumption	130VA
Video input	1x Video, 1x S-Video (Y/C) (automatic version only)
Protection class	1 (acc. IEC 60601-1) 1 (acc. MDD 93/42/EEC)
Safety class	BF
Dimensions	380 x 120 x 360mm (WxHxD)
Weight	approx. 11kg

HIGH TEMPERATURE LED/XENON LIGHT CABLES



Adaptor pieces to use with **endoscope**



250-042-000
RZ/Storz/Olympus



250-040-000
Wolf



250-041-000
ACMI/British Standard

XENON/LED Light Guide Cables
with melt and bending protection

250-025-230 Ø 2.5 mm, 2300 mm

250-025-300 Ø 2.5 mm, 3000 mm

250-035-180 Ø 3.5 mm, 1800 mm

250-035-230 Ø 3.5 mm, 2300 mm

250-035-300 Ø 3.5 mm, 3000 mm

250-048-180 Ø 4.8 mm, 1800 mm

250-048-230 Ø 4.8 mm, 2300 mm

250-048-300 Ø 4.8 mm, 3000 mm

Adaptor pieces to use with **light source**



250-039-000
RZ/Storz



250-038-000
ACMI/CUDA



250-048-000
Luxtec



250-051-000
Stryker



250-037-000
Wolf



250-044-000
Olympus



250-045-000
Olympus - Standard



250-052-000
Heine



250-059-000
Pentax



COMPATIBILITY NOTE:

A fiber optic cable with a large diameter should not be connected to a smaller diameter scope.
For example: Ø 4.8mm fiber optic cables connected to a Ø 2.9mm may risk high temperature at the light entry of the endoscope and may risk patient safety.

ELECTROSURGICAL GENERATOR



Features:

- Monopolar/bipolar cutting and coagulation
- Automatic identification of connected instruments
- Powerstart System simplifies the beginning of cutting process
- Automatic power regulation
- 105 different memory locations in 7 groups
- Various output configuration of the sockets available
- 10" Touchscreen
- Tiltable display
- Footswitch (optional)
- Available with Argon and / or the RZeal
- Real-time output monitoring

DELIVERY CONTAINS:

- Main Unit
- Mains Cable (Footswitch not included)

700-350-400 230V
 700-350-410 110V
 G400 ElectroSurgical Generator

Technical data

Line voltage	110-230 VAC
Power consumption	500W
Generator operation frequency	333kHz
Display	TFT 10"
Defibrillation impulse resistance	acc. to EN 60601-1
NEM system	neutral electrode control optical indication 7 levels required resistance < 240 Ω
Gas type	pure argon 4.8 (99,998%) or higher
Inlet gas pressure	0.25-0.4 [MPa]
Monopolar coagulation / cutting	200W / 400W
Bipolar coagulation / cutting	400W / 400W

Gas outflow	0.1-10 l/min, regulated 0.1 l/min in whole range
Pressure range	reducer (0.4 MPa) on argon cylinder
Vessel sealing system	9 effects/300W
AutoStop	automatic stop of sealing process after achieving the optimal effect
Dimensions	495 x 415 x 225mm (LxWxH)
Weight	12.2kg

Accessories



700-350-405
 2-Button-Footswitch, length: 5m

700-350-402
 3-Button-Footswitch, length: 5m, quick access key



Disposable Neutral Electrode hydrogel, split, for adults or children
 10x5 pcs. per package
 700-503-000 Adults
 700-503-001 Children



Cable for Disposable Neutral Electrode
 5m, RZ compatible only
 700-503-003

ELECTROSURGICAL GENERATOR



Features:

- Monopolar/bipolar cutting and coagulation
- Automatic instrument detection system
- Intuitive Touchscreen
- Automatic power regulation
- Configurable working modes
- Real-time parameter control
- Special endoscopic modes
- Bipolar resection
- Easy software update

700-340-400 230V
 700-340-410 110V
 G44 Electrosurgical Generator

DELIVERY CONTAINS:

- Main Unit • Mains Cable
 (Footswitch not included)

Technical data

Line voltage	110-240 VAC
Power consumption	1100VA
Generator operation frequency	333kHz
Display	TFT 7" WVGA
Spectrum result system	automatic power regulation
Monopolar coagulation	max. 200W (200Ω)
Monopolar cutting	max. 400W (100Ω)
Bipolar coagulation	max. 400W (25Ω)
Bipolar cutting	max. 330W (150Ω)

NEM system	neutral electrode control, optical indication, required resistance < 240 Ω
Dimensions	385 x 305 x 141mm (LxWxH)
Weight	7kg

Accessories



700-350-405
 2-Button-Footswitch, length: 5m

700-350-402
 3-Button-Footswitch, length: 5m, quick access key



Disposable Neutral Electrode
 hydrogel, split, for adults or children
 10x5 pcs. per package
 700-503-000 Adults
 700-503-001 Children



Cable for Disposable Neutral Electrode
 5m, RZ compatible only
 700-503-003

LITHOTRIPTER



Features:

- Pure mechanical energy transmission
- The smallest probe diameter of 0.6mm
- Auxiliary instruments can also be inserted
- Very simple handling and cleaning
- Compatible to other RZ and other instruments for the therapy of ureteric, renal and bladder stones
- Non-conductive hand piece to ensure safety for patients as well as users

253-750-100 L100 Lithotripter



DELIVERY CONTAINS:

- Main Unit (253-750-100)
- Operating manual • Mains cable

Technical data

Line voltage	115-230 VAC	Dimensions	254 x 113 x 305mm (WxHxD)
Pneumatic power source	3.5 – 6.5 bar, compressed medical air	Weight	6.5kg
Pulse rate control (ppm)	50 – 600 ppm 10 ppm increments between 50 - 100 ppm 50 ppm increments between 100 - 600 ppm		

Accessories



Litho Probe, 605mm working length

253-850-006	0.6mm	253-850-016	1.6mm
253-850-008	0.8mm	253-850-020	2.0mm, 450mm length
253-850-010	1.0mm	253-850-025	2.5mm, 450mm length



253-750-150
Footswitch



253-750-200
Hand piece, anodised



253-750-010
Air compressor, 4 bar maximum

L100 Lithotripter Modular System Chart

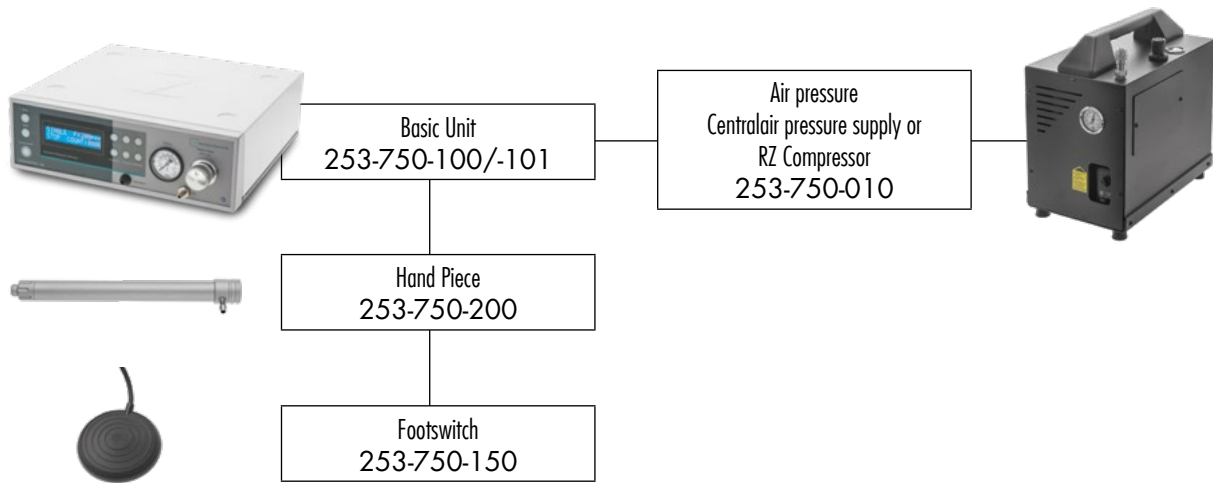

Handpiece + RZ Probes	Telescope + Sheaths	Auxillary Instruments
-----------------------	---------------------	-----------------------

URETEROSCOPY

	253-750-200	253-905-540	253-954-005
	253-850-006 /-008/-010/-012		

CYSTOSCOPY

	253-750-200	253-900-101	253-900-210
	253-850-020/-025	253-900-111 253-900-116	

PERCUTANEOUS NEPHROSCOPY

	253-750-200	253-900-100	253-900-205
	253-850-020/-025	253-900-110 253-900-115	



300-001-168
Endovue 32" HD Monitor

300-001-158
Endovue 24" HD Monitor

Technical data

Screen size	31.5" / 24" diagonal
Resolution	1920 x 1080
Aspect ratio	16:9
Viewing angle	178°
Numbers of colors	16.7 Million (8-bit)
Video Inputs	DVI-D, RGBS/VGA/YPbPr (HD-15 or DVI-I via adapter), S-Video, Composite
Video Outputs	DVI-D
Weight	8.8kg (300-001-168) 6.7kg (300-001-158)



300-001-232
Radiance 32" HD Monitor

300-010-226
Radiance 27" HD Monitor

Technical data

Screen size	32" / 27" diagonal
Resolution	1920 x 1080
Aspect ratio	16:9
Viewing angle	178°
Numbers of colors	1.07 Billion (10-bit)
Video Inputs	DVI-I and 3G-SDI Input/Output
Video Outputs	DVI-D
Weight	11.0kg (300-001-232) 8.9kg (300-010-226)



300-001-031
UHD 4K Monitor, 31"

Technical data

Screen size	31" diagonal
Resolution	4096 x 2160
Aspect ratio	17:9
Viewing angle	178°
Number of colors	1.08 Billion (10-bit)
Video Inputs	1 x HDMI 2.0 1 x DP 1.2 (SST) & 1 x DP 1.2 (MST) 1 x DVI (single link), 4 x SDI (3G)
Video Outputs	1 x DP 1.2 (SST) 1 x DVI (single link), 4 x SDI (3G)
Weight	10.5kg

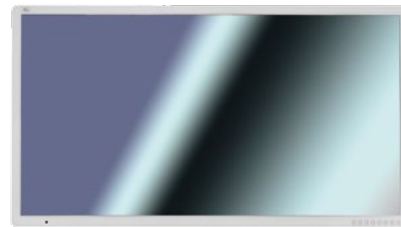

300-001-055
UHD 4K Monitor, 55"

Technical data

Screen size	55" diagonal
Resolution	3840 x 2160
Aspect ratio	16:9
Viewing angle	178°
Numbers of colors	1.08 Billion (10-bit)
Video Inputs	1 x HDMI 2.0, 2 x DP 1.2 (55T) 1 x DVI (single link), 2 x DVI (dual link) 4 x SOi (3G), 2 x SOi (12G)
Video Outputs	1 x DVI (single link), 1 x DP 1.2 (SST) 4 x SDI (3G), 2x SDI (12G)
Weight	37.35kg

RESECTION SIMULATOR / TRAINER

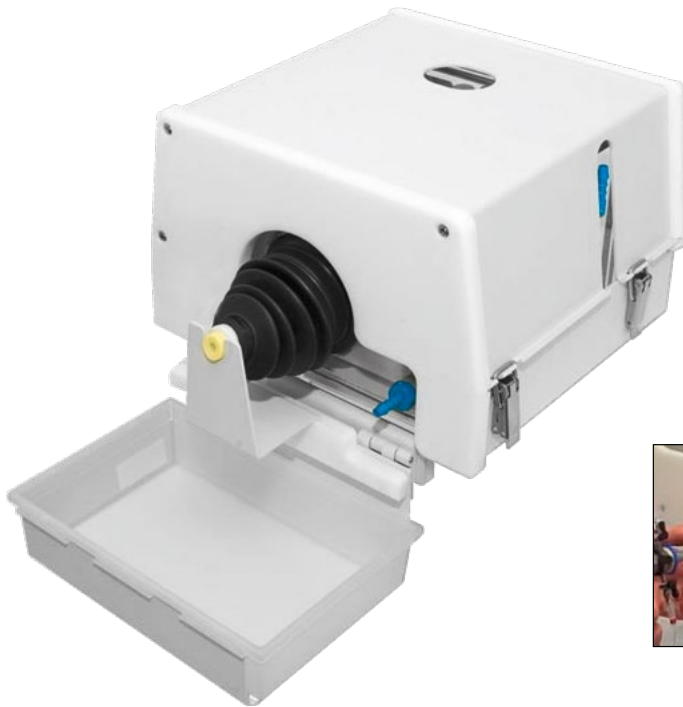

Features:

- Essential hand movements can be learned
- Anatomical substrate can be detected and removed by using the resectoscope
- Usage in workshops, exhibitions or at the customer's location

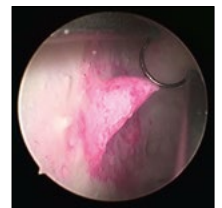
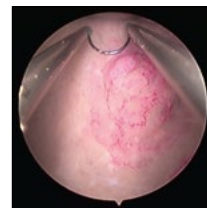

900-253-000 GIUSEPPE Urological Simulator / Trainer, prostate and bladder, incl. pump and accessories, without substrates

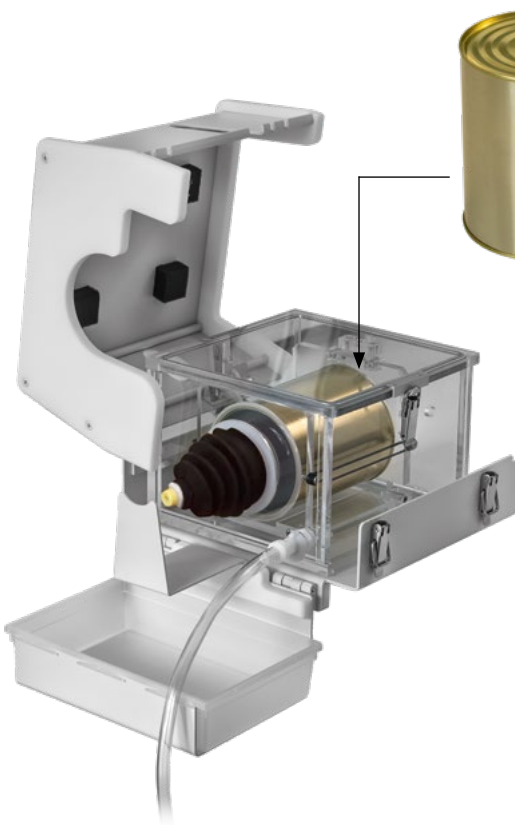

Urological Substrate with and without anatomical structures

- Realistic tissue
- Myomas and Polyps structures
- Close to reality environment

	Quantity	Storable
900-253-001 Anatomical structure of the prostate	12	6 months
900-253-002 Anatomical structure of the bladder	6	3 months
900-253-003 Without anatomical structure	12	12 months

250-015-030	130	253-000-220	25	253-000-555	52
250-015-036	130	253-000-222	25	253-000-666	48, 65
250-020-025	130	253-000-225	25	253-000-724	41
250-020-030	130	253-000-235	30	253-000-850	111
250-025-230	133	253-000-250	48	253-000-900	111
250-025-300	133	253-000-251	48, 65	253-000-901	111
250-035-180	133	253-000-256	5, 7, 12, 41, 62-81	253-000-950	2, 5, 13, 111
250-035-230	133	253-000-258	80, 81	253-000-951	111
250-035-300	133	253-000-266	41, 63	253-000-975	111
250-037-000	133	253-000-300	62, 63	253-000-976	111
250-038-000	133	253-000-301	10, 11, 63-67	253-200-007	98
250-039-000	133	253-000-302	12, 63, 64, 66, 67	253-200-009	98
250-040-000	133	253-000-305	62, 64	253-200-011	99
250-041-000	133	253-000-312	12, 62, 63	253-200-075	3, 99
250-042-000	133	253-000-316	62, 66	253-200-095	3, 99
250-044-000	133	253-000-318	11, 62, 67	253-200-100	104
250-045-000	133	253-000-319	10, 62, 66	253-200-128	105
250-048-000	133	253-000-320	64	253-200-200	4, 105
250-048-180	133	253-000-321	64	253-200-210	4, 105
250-048-230	133	253-000-322	64	253-200-228	105
250-048-300	133	253-000-323	64	253-200-328	105
250-051-000	133	253-000-330	64	253-200-428	105
250-052-000	133	253-000-331	64	253-200-500	104
250-059-000	133	253-000-332	64	253-200-600	4, 104
253-000-044	42	253-000-333	64	253-202-003	3, 98, 100
253-000-054	42	253-000-350	65	253-203-128	4, 105
253-000-084	5, 42	253-000-352	8, 10, 52, 62, 66	253-203-228	105
253-000-094	7, 42	253-000-356	41, 68, 80, 81	253-203-328	4, 105
253-000-100	26	253-000-358	80, 81	253-203-428	4, 105
253-000-101	26	253-000-362	66	253-204-003	3, 98, 100
253-000-102	2, 26	253-000-366	41	253-204-128	105
253-000-105	2, 26	253-000-400	7, 40	253-204-228	105
253-000-106	26	253-000-401	40	253-204-328	105
253-000-107	26	253-000-410	8, 52	253-204-428	105
253-000-108	26	253-000-411	52	253-219-100	6, 14, 99, 102, 103
253-000-117	25	253-000-501	53	253-219-130	3, 99, 102, 103
253-000-119	25	253-000-502	53	253-220-011	100
253-000-120	25	253-000-503	53	253-220-014	100
253-000-122	25	253-000-505	53	253-220-025	100
253-000-125	25	253-000-507	53	253-220-030	100
253-000-200	5, 13, 39, 73	253-000-524	41	253-221-000	98
253-000-201	39	253-000-541	8, 53	253-221-030	98
253-000-210	51	253-000-542	53	253-227-000	100
253-000-211	51	253-000-543	8, 53	253-227-030	100
253-000-217	25	253-000-545	8, 53	253-227-070	100
253-000-219	25	253-000-547	53	253-250-200	6, 14, 102, 103

253-250-211	6, 102	253-300-251	49	253-331-225	115
253-250-213	102	253-300-252	49	253-331-335	114
253-251-111	6, 102	253-300-253	49	253-332-225	115
253-251-112	6, 102	253-300-255	49	253-332-335	114
253-251-113	6, 102	253-300-256	49	253-333-225	115
253-251-114	102	253-300-257	49	253-333-335	114
253-251-115	6, 102	253-300-258	49	253-334-225	115
253-252-111	102	253-300-259	49	253-334-335	114
253-252-112	102	253-300-999	5, 7, 8, 9, 13, 74	253-335-225	115
253-252-113	102	253-310-014	101	253-335-335	114
253-252-114	102	253-310-015	101	253-336-225	115
253-252-115	102	253-310-017	24	253-336-335	114
253-255-001	14, 103	253-310-019	24	253-337-225	115
253-265-010	14, 103	253-310-020	24	253-337-335	114
253-265-101	14, 103	253-310-022	24	253-340-335	114
253-265-102	14, 103	253-310-025	24	253-341-335	114
253-265-103	103	253-310-100	101	253-342-335	114
253-265-104	14, 103	253-310-101	101	253-343-335	114
253-300-017	2, 24	253-310-107	101	253-344-335	114
253-300-019	24	253-310-390	113	253-345-335	114
253-300-020	24	253-310-391	113	253-346-335	114
253-300-022	2, 24	253-310-392	113	253-347-335	114
253-300-025	19, 24, 80	253-310-393	113	253-348-335	114
253-300-119	24	253-315-000	25	253-349-335	114
253-300-120	24	253-320-225	115	253-350-335	114
253-300-122	24	253-320-335	114	253-351-335	114
253-300-125	24	253-321-225	115	253-352-335	114
253-300-201	5, 43, 45	253-321-335	114	253-353-335	114
253-300-202	43	253-322-225	115	253-354-335	114
253-300-203	5, 43, 45	253-322-335	114	253-355-335	114
253-300-204	43	253-323-225	115	253-356-335	114
253-300-205	5, 43, 45	253-323-335	114	253-357-335	114
253-300-206	5, 43, 45	253-324-225	115	253-370-003	31, 105
253-300-207	43	253-324-335	114	253-370-004	105
253-300-208	43	253-325-225	115	253-370-005	2, 31, 105
253-300-209	44	253-325-335	114	253-370-007	2, 31
253-300-210	44	253-326-225	115	253-370-009	115
253-300-211	44	253-326-335	114	253-370-010	31
253-300-212	44	253-327-225	115	253-370-021	115
253-300-213	44	253-327-335	114	253-370-103	31
253-300-214	44	253-328-225	115	253-370-253	3, 4, 98, 100
253-300-215	44	253-328-335	114	253-371-003	31, 105
253-300-218	44	253-329-225	115	253-371-004	105
253-300-219	44	253-329-335	114	253-371-005	31, 105
253-300-220	44	253-330-225	115	253-371-007	31
253-300-222	43	253-330-335	114	253-371-253	3, 4, 98, 100

253-372-005	31	253-500-100	13	253-650-032	114
253-372-007	31	253-500-101	76	253-650-034	114
253-372-010	31	253-500-102	76	253-650-036	114
253-375-010	115	253-500-104	76	253-750-010	136, 137
253-375-015	115	253-500-105	76	253-750-100	20, 136, 137
253-400-200	46	253-500-106	76	253-750-150	20, 136, 137
253-400-201	7, 46	253-500-108	76	253-750-200	20, 136, 137
253-400-202	46	253-500-115	75	253-755-010	19, 78
253-400-203	7, 46	253-500-116	76	253-755-020	19, 78
253-400-204	46	253-500-125	75	253-755-030	19, 78
253-400-205	7, 46	253-500-221	13, 73	253-755-040	78
253-400-206	46	253-500-229	73	253-755-500	79
253-400-211	46	253-500-230	13, 73	253-760-000	19, 80
253-400-222	46	253-500-315	75	253-780-000	81
253-400-501	58	253-500-321	13, 73	253-800-000	108
253-400-502	58	253-500-325	13, 73	253-800-900	109
253-400-503	58	253-500-500	75	253-804-000	13, 19, 23, 38 62
253-400-504	58	253-500-561	13, 74		73, 78
253-400-505	58	253-500-562	74	253-804-012	23, 38, 62, 63,
253-400-506	58	253-500-563	13, 74		64, 70, 71
253-400-508	58	253-500-564	13, 74	253-804-030	2, 5, 7, 12, 19,
253-400-601	57, 106	253-500-581	76		23, 38, 62, 63, 64, 70, 71, 79, 80, 81
253-400-602	57, 106	253-500-582	76	253-804-070	23, 79
253-400-606	57, 106	253-580-007	30	253-804-530	48, 65
253-400-701	47	253-581-007	30	253-829-000	75, 101
253-400-702	47	253-581-045	29	253-829-012	66, 67
253-400-703	47	253-582-045	29	253-829-030	9, 66, 67, 101
253-400-704	47	253-582-055	29	253-850-006	20, 136, 137
253-420-100	2, 28	253-582-065	29	253-850-008	20, 136
253-421-100	28	253-584-005	30	253-850-010	20, 136
253-422-100	28	253-585-005	2, 15, 29, 96	253-850-012	20
253-423-100	28	253-610-001	31, 57, 106	253-850-016	20, 136
253-425-100	28	253-610-002	31, 57, 106	253-850-020	20, 136, 137
253-426-100	28	253-610-003	2-6, 31, 57, 106	253-850-025	136
253-427-100	28	253-610-004	31, 57, 106	253-870-023	70
253-428-100	12, 68	253-650-010	114	253-872-000	70
253-428-500	41	253-650-012	114	253-873-000	70
253-429-100	28	253-650-014	114	253-874-000	63, 71
253-430-100	80	253-650-016	114	253-900-000	86
253-431-100	28	253-650-018	114	253-900-001	109
253-500-000	2, 5, 19, 111	253-650-020	114	253-900-010	83, 96
253-500-001	111	253-650-022	114	253-900-100	87, 88, 137
253-500-003	111	253-650-024	114	253-900-101	87, 88, 137
253-500-004	111	253-650-026	114	253-900-105	87, 88
253-500-010	111	253-650-028	114	253-900-110	87, 137
253-500-020	111	253-650-030	114	253-900-111	87, 137

253-900-115	87, 137	253-900-900	2	253-952-005	15, 94
253-900-116	87, 137	253-900-901	5	253-952-455	16, 17, 85
253-900-120	88	253-900-902	13	253-953-003	95
253-900-121	12, 18, 62, 68, 88	253-900-903	15	253-953-004	94
253-900-130	18, 88	253-900-905	6	253-953-005	94
253-900-131	88	253-900-909	16	253-954-003	95
253-900-135	18, 88	253-900-911	7	253-954-004	94
253-900-136	88	253-900-918	3	253-954-005	15, 94, 137
253-900-140	16, 83	253-900-919	4	253-954-455	85
253-900-141	16, 84	253-900-920	12	253-955-003	95
253-900-142	16, 84	253-900-921	9	253-955-004	94
253-900-143	16, 84	253-900-922	14	253-955-005	94
253-900-145	16, 84	253-900-923	17	253-956-003	95
253-900-146	16, 84	253-900-924	18	253-956-004	94
253-900-147	16, 84	253-900-925	19	253-956-005	15, 94
253-900-148	16, 84	253-900-926	20	253-956-455	16, 17, 85
253-900-150	87	253-901-220	11, 62, 69	253-957-003	95
253-900-151	87	253-904-220	10, 11, 69	253-957-004	94
253-900-155	18, 89	253-905-000	96, 119	253-957-005	94
253-900-156	18, 89	253-905-220	10, 11, 62, 69	253-957-105	27
253-900-157	18, 89	253-905-400	83, 96	253-958-003	95
253-900-160	88	253-905-530	93	253-958-004	94
253-900-161	88	253-905-540	15, 93, 137	253-958-005	94
253-900-171	84	253-910-000	126	253-958-105	27
253-900-173	84	253-910-001	126	253-958-455	85
253-900-175	84	253-910-002	126	253-959-003	95
253-900-200	85, 89	253-910-003	126	253-959-005	94
253-900-201	18, 89	253-910-530	93	253-960-013	109
253-900-202	18, 89	253-910-540	93	253-960-019	109
253-900-205	90, 137	253-915-530	93	253-960-025	96
253-900-206	90	253-915-540	93	253-960-360	85
253-900-210	90, 137	253-920-090	115	253-961-102	32
253-900-211	90	253-920-105	115	253-961-103	32
253-900-212	90	253-920-120	115	253-962-003	96
253-900-213	90	253-920-135	115	253-990-800	32
253-900-238	90	253-920-150	115	300-001-031	138
253-900-239	90	253-940-005	29, 96	300-001-055	138
253-900-245	90	253-950-003	95	300-001-158	138
253-900-246	90	253-950-004	94	300-001-168	138
253-900-250	18, 90	253-950-005	15, 94	300-001-232	138
253-900-251	90	253-950-455	16, 17, 85	300-001-600	129
253-900-252	18, 90	253-951-003	95	300-001-601	129
253-900-253	90	253-951-004	94	300-001-602	129
253-900-815	86	253-951-005	94	300-001-610	127, 128, 129
253-900-830	17, 86	253-952-003	95	300-001-615	127, 128, 129
253-900-888	17, 86	253-952-004	94	300-001-800	128

300-001-802	128	320-721-220	113	351-829-030	8, 10, 11, 50, 54, 62
300-001-804	128	320-721-240	113	351-905-105	112
300-001-813	130	320-723-080	113	351-905-110	112
300-001-814	130	320-723-100	113	600-050-000	124
300-001-815	130	320-723-120	113	600-100-000	124
300-001-823	130	320-723-140	113	600-255-500	123
300-001-824	130	320-723-160	113	600-255-530	123
300-001-825	130	320-723-180	113	600-255-535	123
300-001-840	127	320-723-200	113	600-255-550	123
300-001-841	127	320-723-220	113	600-255-555	123
300-010-226	138	320-723-240	113	600-255-565	123
300-011-178	112	320-998-000	115	600-255-575	123
300-011-179	112	320-999-000	115	600-255-600	123
300-011-181	112	351-000-180	9, 55	600-255-605	123
300-011-184	10, 11, 12, 63-67, 112	351-000-185	9, 11, 55, 62, 67	600-281-001	123
300-011-506	112	351-000-186	55	600-281-002	122
300-011-515	112	351-000-195	55, 67	600-281-003	121
300-135-905	124	351-000-201	9, 56	600-281-004	120
300-135-910	124	351-000-202	56	600-292-052	119
300-215-000	32, 124	351-000-203	9, 56	600-405-500	122
300-400-900	112	351-000-205	9, 56	600-405-530	122
300-400-901	112	351-000-206	56	600-405-535	122
300-420-065	124	351-100-105	2, 27	600-405-550	122
300-900-180	132	351-100-107	27	600-405-555	122
300-900-300	131	351-100-109	27	600-405-570	122
301-701-030	92, 112	351-100-305	27	600-405-575	122
301-701-060	92, 112	351-100-307	27	600-405-600	122
301-701-100	32, 112	351-107-107	27	600-405-605	122
320-603-455	113	351-107-109	27	600-450-070	119
320-720-080	113	351-107-307	27	600-460-055	119
320-720-100	113	351-114-105	27	600-460-056	119
320-720-120	113	351-114-107	2, 27	600-462-052	119
320-720-140	113	351-114-109	27	600-464-229	118
320-720-160	113	351-114-305	27	600-485-500	121
320-720-180	113	351-114-307	27	600-485-530	121
320-720-200	113	351-120-105	27, 74	600-485-535	121
320-720-220	113	351-120-107	2, 27	600-485-550	121
320-720-240	113	351-120-109	27	600-485-555	121
320-721-080	113	351-120-305	27	600-485-570	121
320-721-100	113	351-120-307	27	600-485-575	121
320-721-120	113	351-124-107	27	600-485-600	121
320-721-140	113	351-124-307	27	600-485-605	121
320-721-160	113	351-400-200	9, 55	600-501-000	117
320-721-180	113	351-400-201	55	600-501-002	117
320-721-200	113	351-829-000	50, 54, 62	600-505-000	117
		351-829-012	50, 54, 62		

600-505-002	117
600-506-002	117
600-508-000	118
600-511-000	118
600-540-500	120
600-540-530	120
600-540-535	120
600-540-550	120
600-540-555	120
600-540-570	120
600-540-575	120
600-540-600	120
600-540-605	120
600-662-077	96, 119
600-950-100	124
660-166-100	124
700-340-400	135
700-340-410	135
700-350-400	134
700-350-402	134, 135
700-350-405	134, 135
700-350-410	134
700-500-453	7, 8, 9, 57, 106
700-501-453	31, 57, 106
700-503-000	134, 135
700-503-001	134, 135
700-503-003	134, 135
700-900-160	124
700-900-220	124
700-900-250	124
900-253-000	139
900-253-001	139
900-253-002	139
900-253-003	139

