





STIMULATE YOUR SENSES

At RZ Medizintechnik, patient health drives everything we do. Our mission is to support surgeons with innovative solutions that enable advanced, minimally invasive and tissue-preserving procedures. As a family-owned medical technology company with over 30 years of experience, we combine hands-on expertise with a strong focus on continuous innovation.

This is reflected in our portfolio: EESy instrumentation for endoscopic ear surgery, FINESS instruments designed for maximum precision in microsurgical ear procedures, and OSTRa – our mouth gag system for transoral robotic surgery.

Each solution is developed to meet the evolving demands of modern surgery – enhancing precision, improving usability, and supporting better patient outcomes. “Progress in Surgery” is more than a guiding principle. It’s what we deliver every day – for surgeons and their patients.



DEDICATED TO QUALITY

The quality of our products is the result of careful craftsmanship and advanced manufacturing. Each instrument is produced locally by experienced surgical instrument makers, combining expertise, precision, and state-of-the-art technology.

The result is long-lasting durability, reliable performance, and cost-effective use over time — along with a high level of safety for both patients and users in daily clinical practice.

All RZ Medizintechnik products are developed and manufactured in accordance with MDR requirements and FDA standards, meeting international expectations for safety, quality, and performance.



TABLE OF CONTENTS

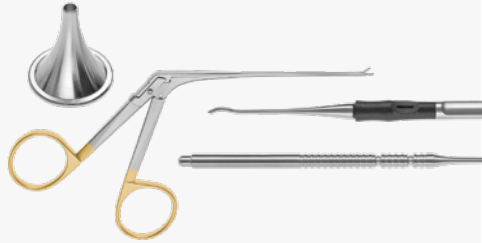

OTOLOGY

Page 7 - 90



RHINOLOGY

Page 91 - 180

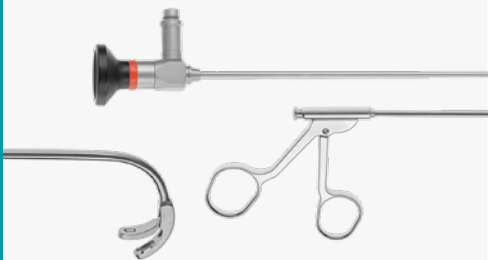

SINUSCOPY

Page 181 - 226

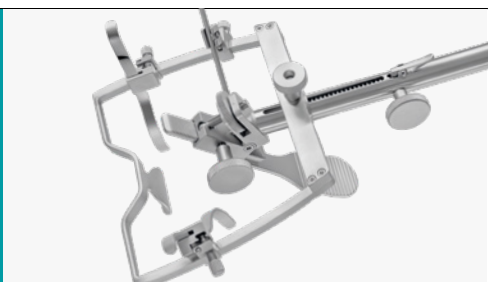

ORAL

Page 227 - 264



LARYNGOSCOPY

Page 265 - 302

INDEX

Page 302 - 322

OTOLOGY



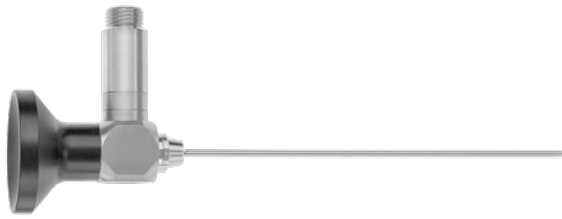
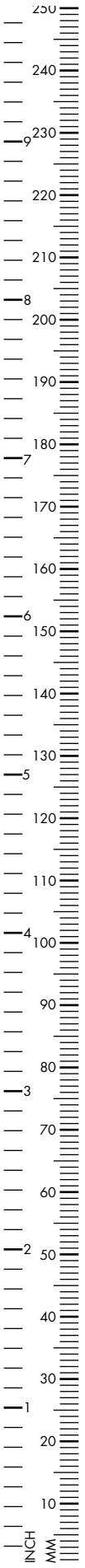

Otoscope, 100mm working length, Ø 1.9mm	
0°	410-019-100
30°	410-019-130



Otoscope, 75mm working length, Ø 2.7mm	
0°	410-027-000
30°	410-027-030
70°	410-027-070



Otoscope, 110mm working length, Ø 2.7mm	
0°	410-027-100
30°	410-027-130



Otoscope, 50mm working length, Ø 4.0mm	
0°	410-004-000
30°	410-004-030

LED PORTABLE LIGHT SOURCE

- Intensive Lightning (max. 1000 lumen)
- 4 adjustable brightness levels
- Water resistant (IPX8)
- Magnetic USB charger included
- Long lifetime battery

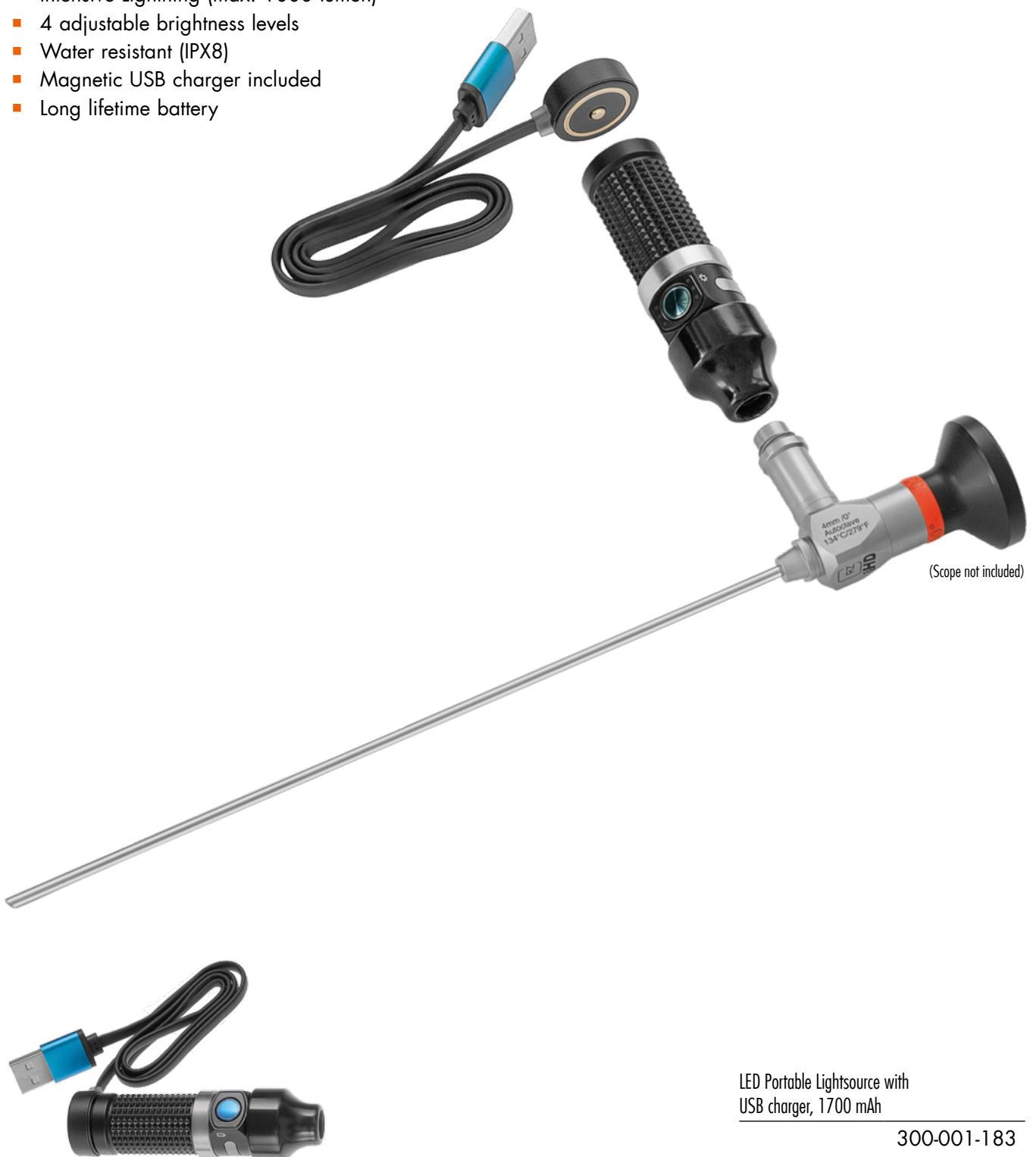



OP Headlight, black head band,
super light-weight, leather padded FO cable
bifurcated, top headbandg

100-102-100



Head Light with light cable for use with all
common light sources,
with leather pad at silicone band

100-103-100



LED Head light with Li-Ion battery,
head band with stepless regulation wheel,
including charger

100-103-400

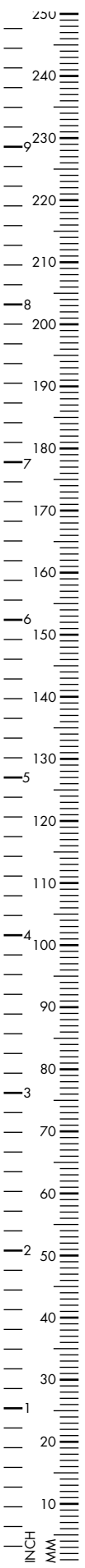



Flexible Arm, complete with holding rod,
without rotating clamp

A 251-010-000

Rotating clamp for flexible tension arm
attachable to operating table

B 251-010-100

Aural Specula Holder for flexible arm

C 251-010-200

Endoscope Clamp for flexible arm

D 251-010-300



SHEA

Ear Speculum Holder

410-900-000

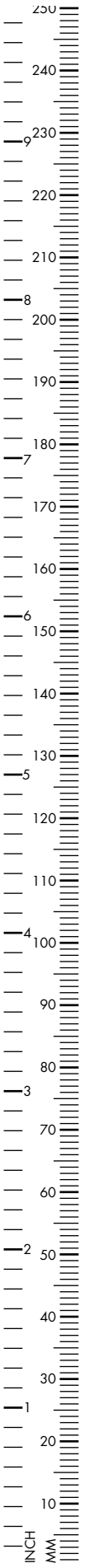

POLITZER

Aural Speculum, round, straight, 27mm length, stainless steel, for children

inner Ø 2.0mm	410-009-003
inner Ø 3.0mm	410-009-004
inner Ø 4.0mm	410-009-005
inner Ø 5.0mm	410-009-006



HARTMANN

Aural Speculum, round, straight, 27mm length, for children

inner Ø 3.0mm	410-019-003
inner Ø 4.0mm	410-019-004
inner Ø 5.0mm	410-019-005



TOYNBEE

Ear Speculum, stainless steel, round, straight, 36mm

inner Ø 3mm	410-014-004
inner Ø 4mm	410-014-005
inner Ø 5mm	410-014-006
inner Ø 6.5mm	410-014-007



HARTMANN

Aural Speculum, round, straight, 36mm length, for adults

outer Ø 3.0mm	410-019-030
outer Ø 4.0mm	410-019-040
outer Ø 5.0mm	410-019-050
outer Ø 6.0mm	410-019-060
outer Ø 7.5mm	410-019-075

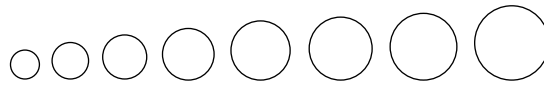
**BOUCHERON**

Ear Speculum, round, straight

30mm inner Ø 3.0mm	410-018-004
32mm inner Ø 3.5mm	410-018-005
34mm inner Ø 4.5mm	410-018-006
35mm inner Ø 5.1mm	410-018-007
35mm inner Ø 5.5mm	410-018-008
35mm inner Ø 6.5mm	410-018-009
36mm inner Ø 7.5mm	410-018-010
37mm inner Ø 9.0mm	410-018-085

**FARRIOR**

Aural Speculum, round, 43mm length, straight, stainless steel

inner Ø 3.3mm outer Ø 4.1mm	410-022-001
inner Ø 4.3mm outer Ø 5.1mm	410-022-002
inner Ø 4.8mm outer Ø 5.6mm	410-022-003
inner Ø 5.3mm outer Ø 6.1mm	410-022-004
inner Ø 5.8mm outer Ø 6.6mm	410-022-005
inner Ø 6.3mm outer Ø 7.1mm	410-022-006
inner Ø 6.7mm outer Ø 7.5mm	410-022-007
inner Ø 7.2mm outer Ø 8.0mm	410-022-008
inner Ø 7.7mm outer Ø 8.5mm	410-022-009

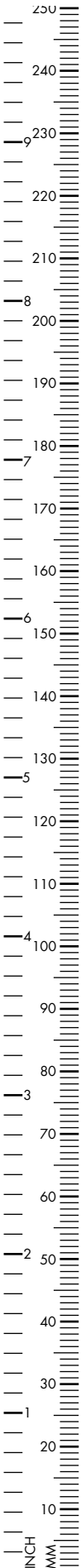

FARRIOR

Aural Speculum, round, 43mm length, straight, stainless steel, black finish

inner Ø 3.3mm	410-022-501
outer Ø 4.1mm	
inner Ø 4.3mm	410-022-502
outer Ø 5.1mm	
inner Ø 4.8mm	410-022-503
outer Ø 5.6mm	
inner Ø 5.3mm	410-022-504
outer Ø 6.1mm	
inner Ø 5.8mm	410-022-505
outer Ø 6.6mm	
inner Ø 6.3mm	410-022-506
outer Ø 7.1mm	
inner Ø 6.7mm	410-022-507
outer Ø 7.5mm	
inner Ø 7.2mm	410-022-508
outer Ø 8.0mm	
inner Ø 7.7mm	410-022-509
outer Ø 8.5mm	



FARRIOR

Oval, 20° oblique end, 43mm, stainless steel

inner Ø 3.0x4.0mm	410-023-001
outer Ø 3.8x4.8mm	
inner Ø 4.0x5.0mm	410-023-002
outer Ø 4.8x5.8mm	
inner Ø 4.5x5.5mm	410-023-003
outer Ø 5.3x6.3mm	
inner Ø 4.0x6.0mm	410-023-004
outer Ø 5.8x6.3mm	
inner Ø 5.5x6.5mm	410-023-005
outer Ø 6.3x7.3mm	
inner Ø 6.0x7.0mm	410-023-006
outer Ø 6.8x7.8mm	
inner Ø 6.5x7.5mm	410-023-007
outer Ø 7.3x8.3mm	
inner Ø 7.0x8.0mm	410-023-008
outer Ø 7.8x8.8mm	
inner Ø 7.5x8.5mm	410-023-009
outer Ø 8.3x9.3mm	



Oval, 20° oblique end, 43mm,
black finish

inner Ø 3.0x4.0mm outer Ø 3.8x4.8mm	410-023-501
inner Ø 4.0x5.0mm outer Ø 4.8x5.8mm	410-023-502
inner Ø 4.5x5.5mm outer Ø 5.3x6.3mm	410-023-503
inner Ø 5.0x6.0mm outer Ø 5.8x6.3mm	410-023-504
inner Ø 5.5x6.5mm outer Ø 6.3x7.3mm	410-023-505
inner Ø 6.0x7.0mm outer Ø 6.8x7.8mm	410-023-506
inner Ø 6.5x7.5mm outer Ø 7.3x8.3mm	410-023-507
inner Ø 7.0x8.0mm outer Ø 7.8x8.8mm	410-023-508
inner Ø 7.5x8.5mm outer Ø 8.3x9.3mm	410-023-509

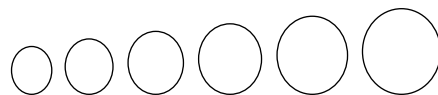

ZOELLNER

Oval, 20°, straight, 38mm, black finish

inner Ø 4.5x5.5mm outer Ø 5.5x6.5mm	410-132-001
inner Ø 5.5x6.5mm outer Ø 6.5x7.5mm	410-132-002
inner Ø 6.5x7.5mm outer Ø 7.5x8.5mm	410-132-003
inner Ø 7.5x8.5mm outer Ø 8.5x9.5mm	410-132-004
inner Ø 8.5x9.5mm outer Ø 9.5x10.5mm	410-132-005
inner Ø 9.5x10.5mm outer Ø 10.5x11.5mm	410-132-006

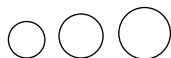

HOLMGREN

Self retaining, black finish

inner Ø 4mm outer Ø 5mm	410-032-050
inner Ø 5mm outer Ø 6mm	410-032-060
inner Ø 6mm outer Ø 7mm	410-032-070

**SCHWABER**Specula with hinge, 165mm, 6¹/₂"

30mm blades 170-786-030

50mm blades 170-786-050



Rack for 12 ear specula

111 x 83 x 37 mm 410-012-110

**BRUENINGS**Aural magnifier, anastigmatic, complete with:
1 diagnostic head 410-150-007, 1 operating
head, 6 ear specula, 1 rubber tube and
connection cone 410-150-008

Set of 6 sizes

Ø 5.3mm 410-150-100

Ø 6.5mm

Ø 7.5mm

Ø 8.0mm

Ø 9.0mm

Ø 12.0mm

**HARTMANN**

Tuning Fork

c 128	410-185-010
c2 512	410-185-210
c4 2048	410-185-410
c1 256	410-185-110
c3 1024	410-185-310
c5 4096	410-185-510

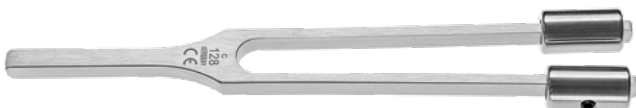
**HARTMANN**

Tuning Fork, with clamps

c 128	410-195-010
c1 256	410-195-110

**LUCAE**

Tuning Fork, with platform

c2 512	410-174-512
c3 1024	410-174-102



Tuning Fork, with platform

a1 440	410-190-440
--------	-------------

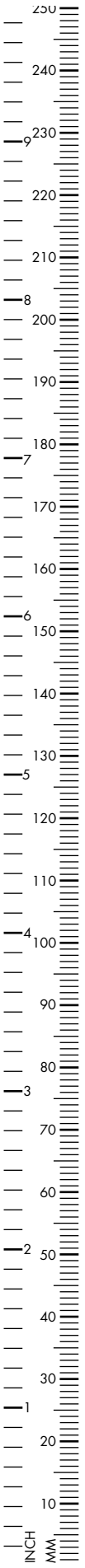

Aural Syringe, 10ml, all metal chromium plated, Luer-Lock attachment, consisting of:

Syringe, valve attachment, metal sinker, protection shield	410-800-100
Plastic tube, 600 mm outside 5mm, inside 2mm	410-800-020
Set with 4 tips	410-800-050
Complete set	410-800-000
Protection Shield	410-800-040
Metal Sinker	410-800-030
Valve Attachment	410-800-010



Ear Syringe, all metal, with conical and bulbous pipe

50ml	410-797-050
75ml	410-797-075
125ml	410-797-125



HARTMANN

Eustachian Catheter

Ø 2.0mm	410-276-072
Ø 2.5mm	410-276-074
Ø 3.0mm	410-276-076
Ø 3.5mm	410-276-078
Ø 4.0mm	410-276-080



WILLIAMS

Eustachian Catheter

	410-276-020
--	-------------

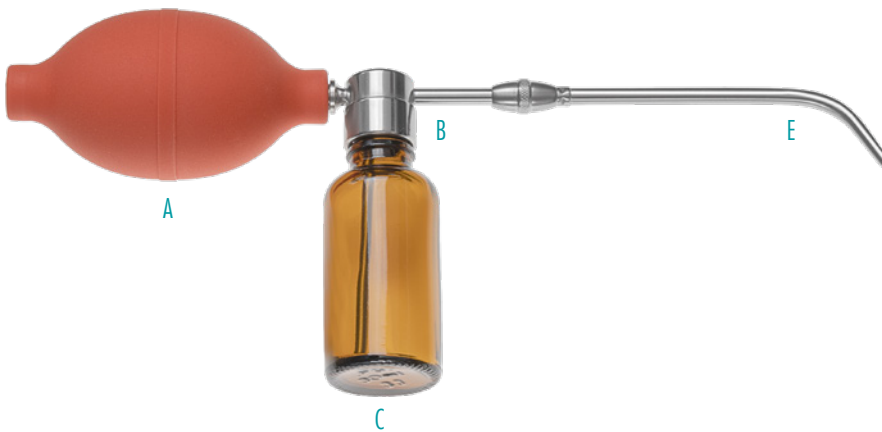

Atomizer, complete with 3 metal tips and rubber bulb

	410-205-000
--	-------------

Rubber bulb

A	410-205-100
---	-------------

Metal mounting

B	410-205-200
---	-------------

Spare bottle, 30ccm

C	410-205-300
---	-------------

Aural Cannula, straight tip, 100mm, 4"

D	410-205-001
---	-------------

Aural Cannula, curved tip, 125mm, 5"

E	410-205-002
---	-------------

Flushing Needle

F	410-797-200
---	-------------



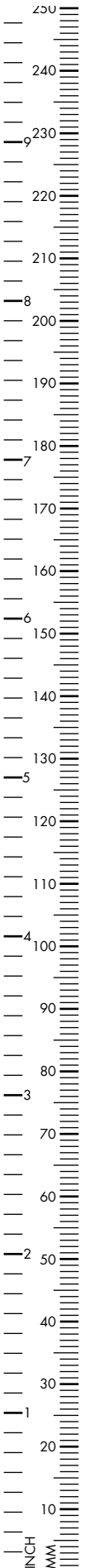

STACKE

Aural Probe, ring handle
 Ø 0.8mm

100mm, 5 1/2" 160-131-105



BOWMAN

Lacrimal Probe, buttoned up

0000/000	400-497-008
00/0	400-497-003
0/1	400-497-001
1/2	400-497-012
2/3	400-497-023
3/4	400-497-034
4/5	400-497-045
5/6	400-497-056
6/7	400-497-067
7/8	400-497-078



PICCOLO

Applicator, slender, round
 Ø 0.7mm

110mm, 4 1/2" 160-420-110



FARRELL

Applicator, round serrated end
 Ø 0.9mm

140mm, 5 1/2" 160-422-140

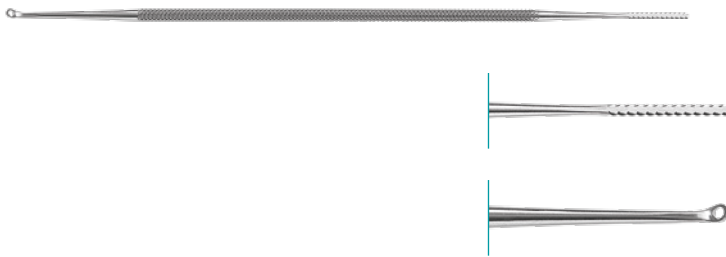

JOBSON-HORNE

Aural Probe, double-ended,
smooth ring and serrated end

180mm, 7" 160-255-180

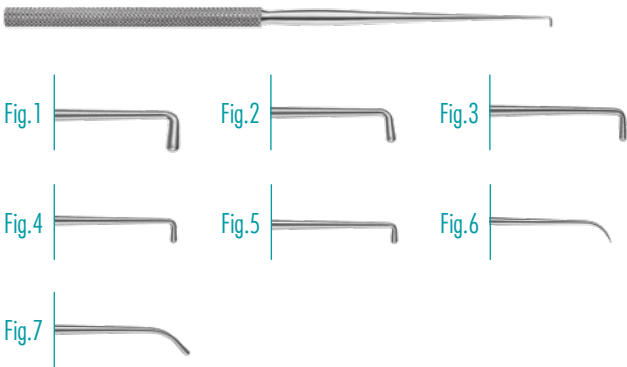

WAGENER

Hooklet, probe-ended, 140mm, 5^{1/2}"

Fig. 1	410-585-001
Fig. 2	410-585-002
Fig. 3	410-585-003
Fig. 4	410-585-004
Fig. 5	410-585-005
Fig. 6	410-585-006
Fig. 7	410-585-007



DAY

Ear Hook, 160mm, 6^{1/4}"

Fig. 1	410-584-001
Fig. 2	410-584-002

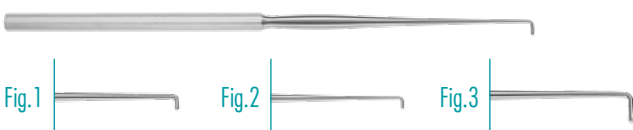

LUCAS

Ear Hook, probe-ended, 140mm, 5^{1/2}"

Fig. 1	410-586-141
Fig. 2	410-586-142
Fig. 3	410-586-143

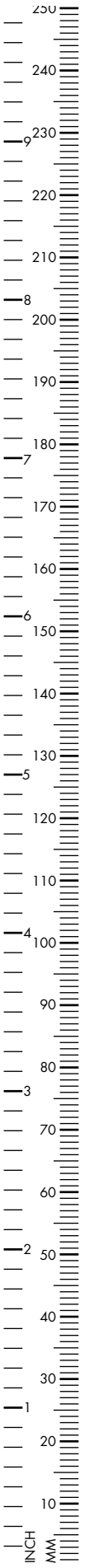

ZAUFAL-JANSEN

Aural hook, probe ended, 45° angled

150mm, 6" 410-583-150



ZAUFAL

Ear Leaver

160mm, 6 1/4" 410-583-145

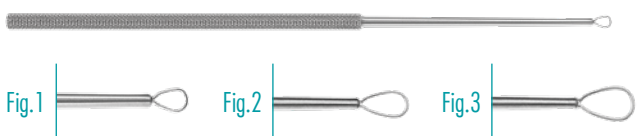

BILLEAU

Aural Loop, straight, 160mm, 6 1/4"

Fig. 1 410-580-001

Fig. 2 410-580-002

Fig. 3 410-580-003

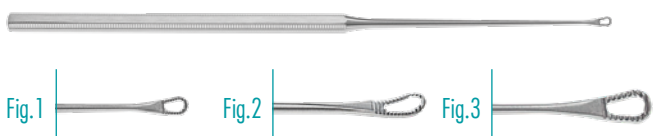

SNELLEN (WEBER-LOCH)

Aural Loop, curved, serrated, 160mm, 6 1/4"

Fig. 1 410-580-161

Fig. 2 410-580-162

Fig. 3 410-580-163



LANGENBECK

Aural loop, blunt, slightly curved

130mm, 5¹/₈" 410-580-130



BUCK

Aural Curette, 150mm, 6"
straight, blunt

Fig. 000, Ø 0.7mm 410-100-300

Fig. 00, Ø 1.2mm 410-100-000

Fig. 0, Ø 1.5mm 410-100-001

Fig. 1, Ø 2.0mm 410-100-002

Fig. 2, Ø 2.4mm 410-100-003

Fig. 3, Ø 2.7mm 410-100-004

straight, sharp

Fig. 000, Ø 0.7mm 410-101-300

Fig. 00, Ø 1.2mm 410-101-000

Fig. 0, Ø 1.5mm 410-101-001

Fig. 1, Ø 2.0mm 410-101-002

Fig. 2, Ø 2.4mm 410-101-003

Fig. 3, Ø 2.7mm 410-101-004

curved, blunt

Fig. 000, Ø 0.7mm 410-102-300

Fig. 00, Ø 1.2mm 410-102-000

Fig. 0, Ø 1.5mm 410-102-001

Fig. 1, Ø 2.0mm 410-102-002

Fig. 2, Ø 2.4mm 410-102-003

Fig. 3, Ø 2.7mm 410-102-004

curved, sharp

Fig. 000, Ø 0.7mm 410-103-300

Fig. 00, Ø 1.2mm 410-103-000

Fig. 0, Ø 1.5mm 410-103-001

Fig. 1, Ø 2.0mm 410-103-002

Fig. 2, Ø 2.4mm 410-103-003

Fig. 3, Ø 2.7mm 410-103-004

Fig.000



Fig.00



Fig.0



Fig.1



Fig.2



Fig.3



straight



curved



blunt



sharp



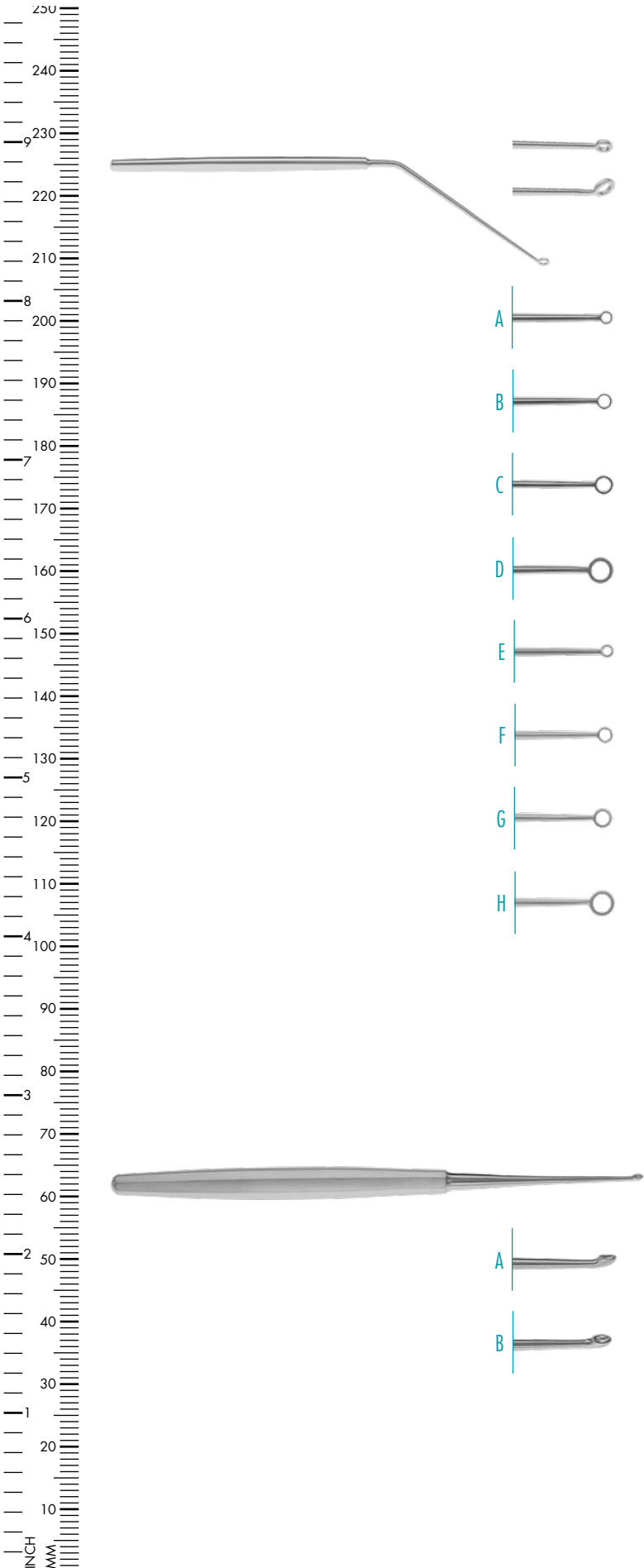

Ear Curette, angled shaft, blunt, 140mm, 5¹/₂" straight ring

A Fig. 0	410-105-000
B Fig. 1	410-105-001
C Fig. 2	410-105-002
D Fig. 3	410-105-003

35° upwards angled

E Fig. 0	410-105-350
F Fig. 1	410-105-351
G Fig. 2	410-105-352
H Fig. 3	410-105-353

Ear Canal Curette, sharp, 170mm, 6²/₃"

A Fig. 1, 1.8mm	410-108-001
B Fig. 2, 2.1mm	410-108-002

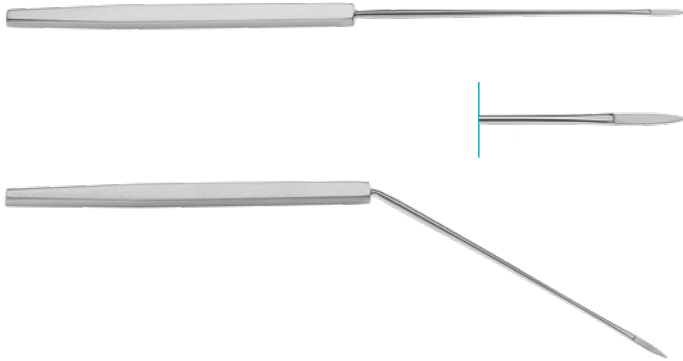

POLITZER

Ear Knife, straight

160mm, 6¹/₄" 410-034-160

curved

160mm, 6¹/₄" 410-035-160

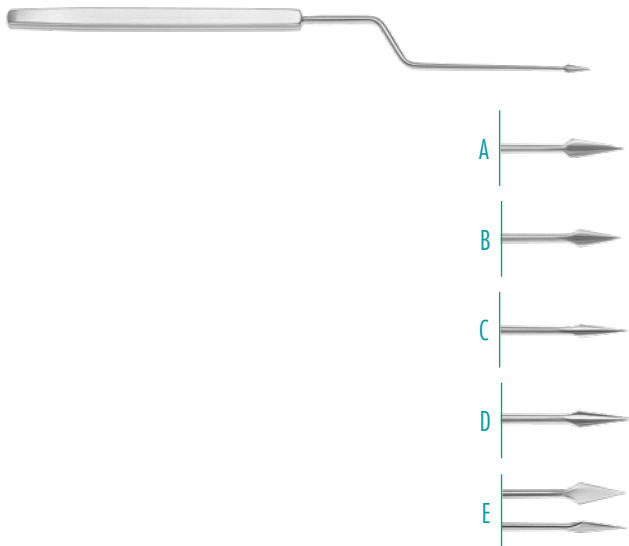

LUCAE

Tympanum Perforator, bayonet shape, for children, 180mm, 7"

A 1.5 x 3mm 410-031-180

for adults, 190mm, 7¹/₂"

B 2.0mm 410-032-180

C 1.8mm 410-032-182

D 1.5mm 410-032-181

for adults, horizontal shape

E 410-033-180



POLITZER

Tympanum Perforator, knee bent, 160mm working length

vertical 410-032-160

horizontal 410-033-160

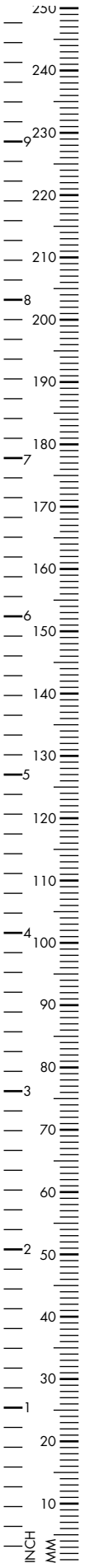

LUCAE

Aural Dressing Forceps, bayonet shaped

140mm, 5¹/₂"

410-391-140



TROELTSCH

Aural Dressing Forceps, delicate, small, serrated, 45mm working length

100mm, 4¹/₃"

410-375-100

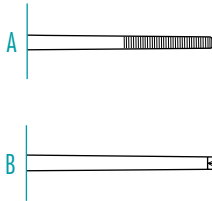

WILDE-TROELTSCH

Aural Dressing Forceps, 120mm, 4³/₄"

A serrated

410-375-120

B 1 x 2 teeth

410-377-120

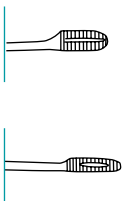

HARTMANN

Aural Tampon Forceps, strong pattern

120mm, 4³/₄"

410-230-140

delicate pattern

135mm, 5¹/₃"

410-230-120

**HARTMANN**

Ear Forceps, straight,
80mm working length

1.0 x 8.0mm	410-210-085
-------------	-------------

125mm working length	
----------------------	--

1.0 x 4.5mm	410-210-125
-------------	-------------

**DUCKBILL**

Ear Forceps, 80mm working length, straight

8mm, serrated	410-338-139
---------------	-------------

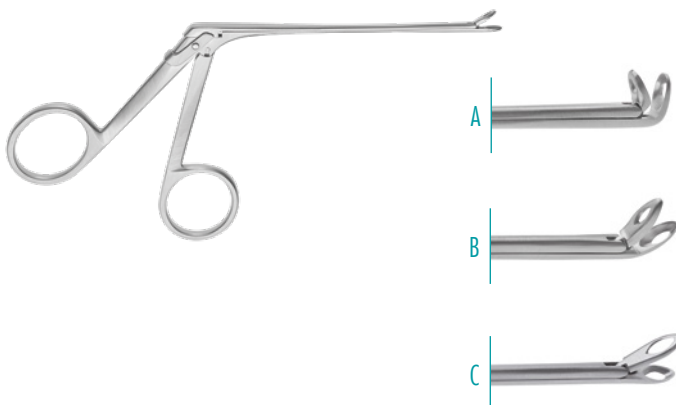
**STRUEMPEL**

Ear Forceps, 80mm working length

A 2.5 x 6.0mm, 90° upwards	410-338-132
-------------------------------	-------------

B 2.5 x 6.0mm, 45° upwards	410-338-133
-------------------------------	-------------

C 2.5 x 7.0mm, straight	410-338-134
----------------------------	-------------

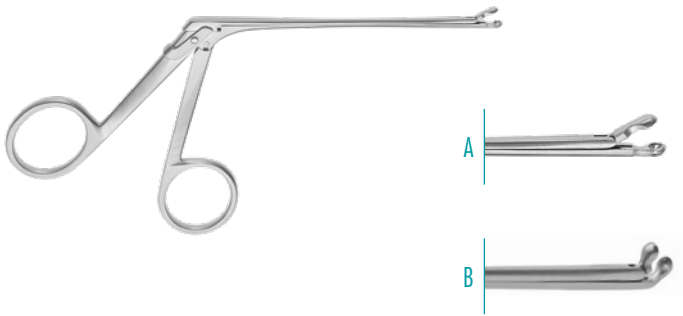
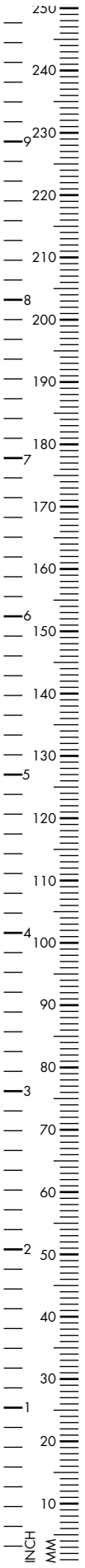

HARTMANN-HERZFELD

Ear Forceps, 80mm working length,

A straight

1.0mm spoon	410-338-131
2.0mm spoon	410-338-135
2.5mm spoon	410-338-136
3.0mm spoon	410-338-140

B curved upwards

2.0mm spoon	410-338-142
-------------	-------------

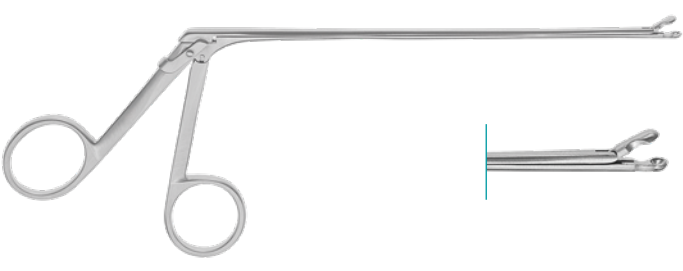

HARTMANN-HERZFELD

Ear Forceps, 125mm working length

2.0mm spoon	410-338-125
-------------	-------------

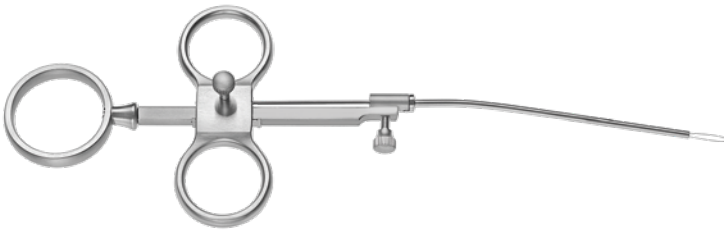
**KRAUSE**

Ear Polypus Snare

165mm, 6¹/₂"

410-410-160

**KRAUSE**

Aural Snare Wire, package of 100 pcs.

Ø 0.2mm

410-411-100

**MUCK**

Periosteal Knife

150mm, 6"

210-394-150

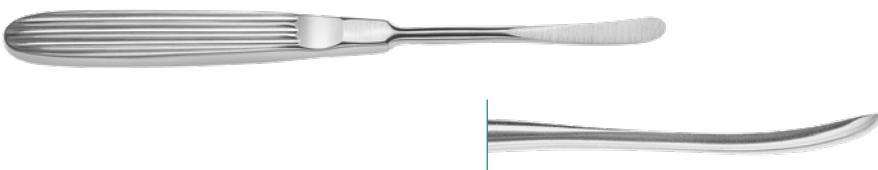
**OBWEGESER**Periosteal Elevator, 175mm, 6⁷/₈"

6mm

431-630-006

7mm

431-630-007

9mm

431-630-009

11mm

431-630-011

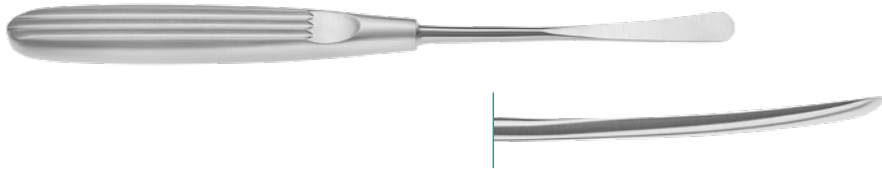
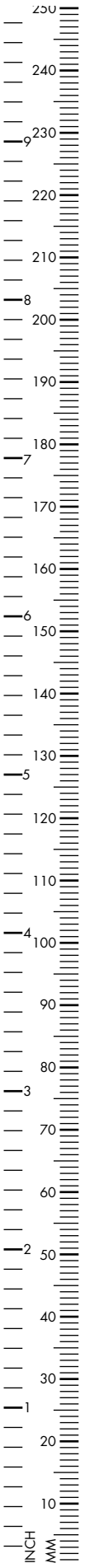

JANSEN

Raspatory, 195mm, 7²/₃"

9mm	431-629-009
11mm	431-629-011
14mm	431-629-014
16mm	431-629-016

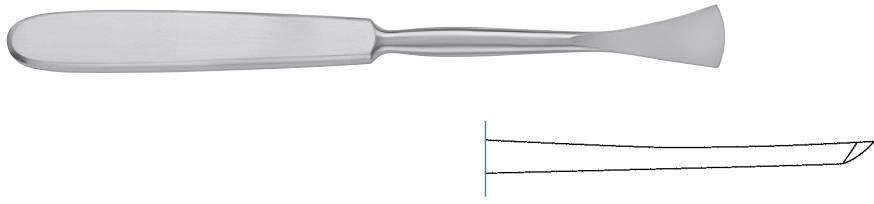

LANGENBECK

Raspatory, 16mm, hollow handle

190mm, 7 ¹ / ₂ "	210-303-190
--	-------------

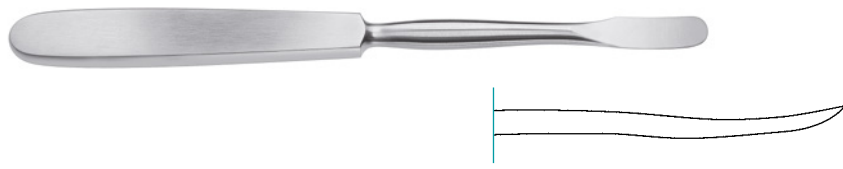

KRAEMER

Raspatory, 10mm, round blade

185mm, 7 ¹ / ₄ "	210-313-185
--	-------------

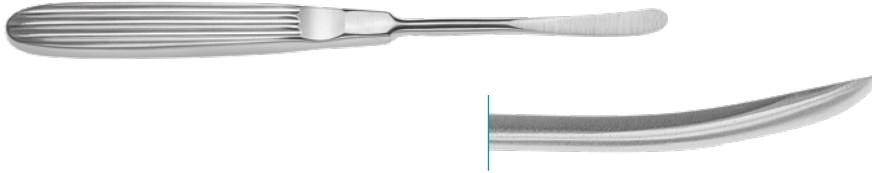
**OBWEGESER**Periosteal Elevator, curved, 175mm, 6⁷/₈"

7mm 431-630-007

9mm 431-630-009

11mm 431-630-011

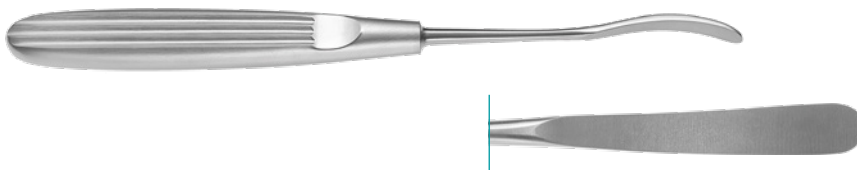
**EICKEN**

Periosteal Elevator

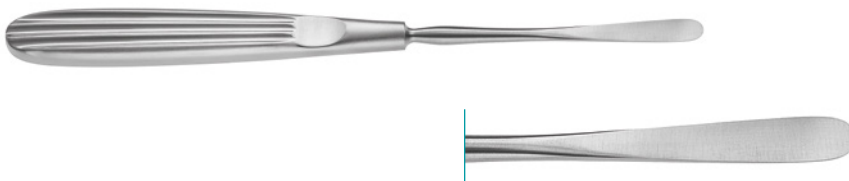
195mm, 7²/₃" 431-636-195**ERLANGEN**

Raspatory, 6mm wide, slightly curved

175mm, 6⁷/₈" 420-547-006

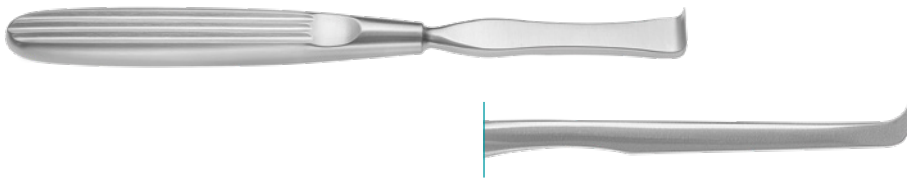
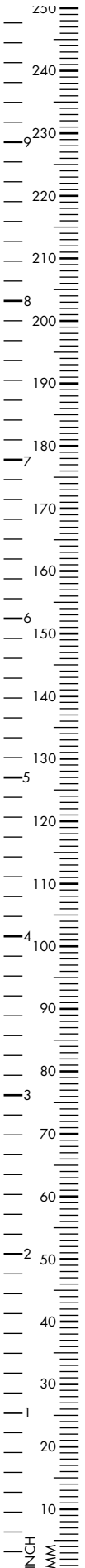

FARABEUF

Periosteal Elevator, 11mm, curved

180mm, 7" 210-311-180

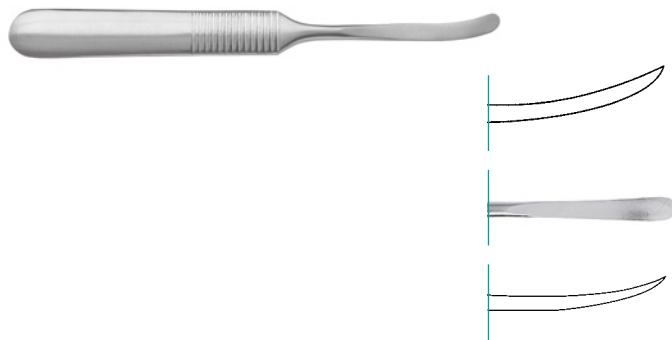

WILLIGER

Raspatory, 4mm

130mm, 5¹/₈" 210-434-130

160mm, 6¹/₄"

5mm 210-436-160

7mm 210-438-160



TRAUTMANN

Gouge, 140mm, 5¹/₂"

3mm 210-113-143

5mm 210-113-145

7mm 210-113-147

9mm 210-113-149



TRAUTMANN

Chisel, 140mm, 5¹/₂"

3mm 210-114-143

5mm 210-114-145

7mm 210-114-147

9mm 210-114-149

**COTTE**

Mallet, Ø 30mm, 1 side plain, 1 side convex
240g

190mm, 7^{1/2}" 210-240-180

**LUCAE**

Mallet, Ø 19mm
190mm, 7^{1/2}"

80g 210-230-190

140g 210-231-190

**COLLIN (LUCAE)**

Mallet, Ø 30mm
220g

200mm, 8" 210-220-200



Mallet, Ø 35mm, synthetic

240mm, 9¹/₂"

210-260-150

Mallet, anodized aluminium handle and head,
Ø 32mm

140g

225mm, 8⁷/₈"

210-264-220

Spare Discs, pair

210-264-221

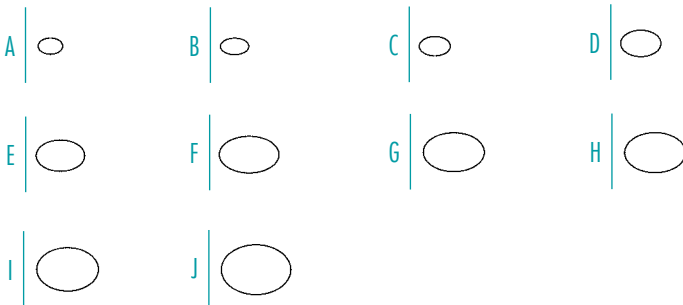

SPRATT

Bone Curette, oval, 170mm, 6²/₃"

A	#0000, 2.5mm	210-308-008
B	#000, 3.0mm	210-308-000
C	#00, 4.0mm	210-308-001
D	#0, 4.5mm	210-308-002
E	#1, 5.0mm	210-308-003
F	#2, 6.0mm	210-308-004
G	#3, 7.0mm	210-308-005
H	#4, 8.0mm	210-308-006
I	#5, 9.6mm	210-308-007
J	#6 11.5mm	210-308-009

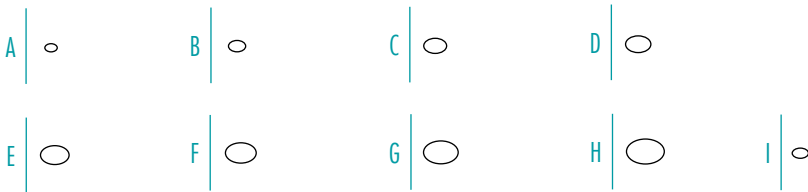

LEMPERT

Bone Curette, 200mm, 8"

A	#000000, 1mm	210-348-600
B	#00000, 1.5mm	210-348-500
C	#0000, 2.0mm	210-348-400
D	#000, 2.2mm	210-348-300
E	#00, 2.5mm	210-348-200
F	#0, 2.7mm	210-348-100
G	#1, 3.0mm	210-348-010
H	#2, 3.3mm	210-348-002
I	#1, 1.8mm	210-348-001

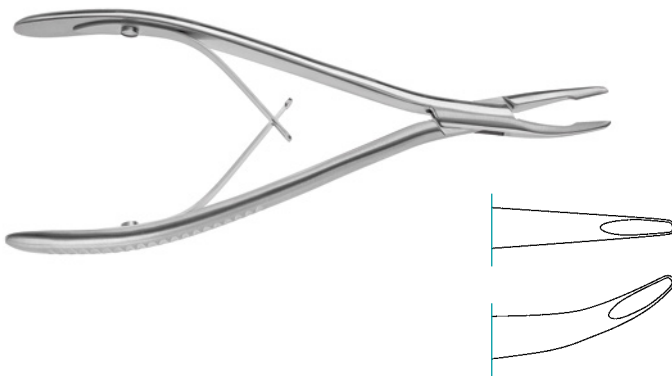
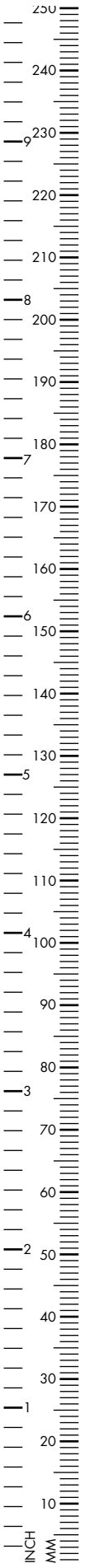

LEMPERT

Bone Rongeur, 160mm, 6¹/₄"

straight	210-770-160
curved	210-771-160

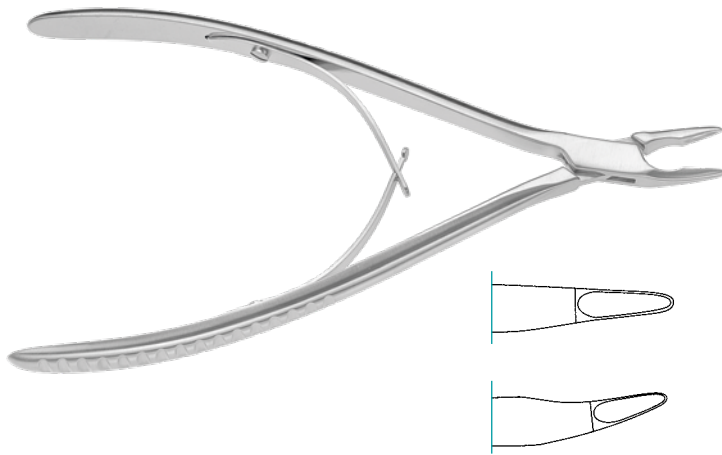

LEMPERT

Bone Rongeur, heavy pattern, 190mm, 7¹/₂"

straight	210-770-190
curved	210-771-190

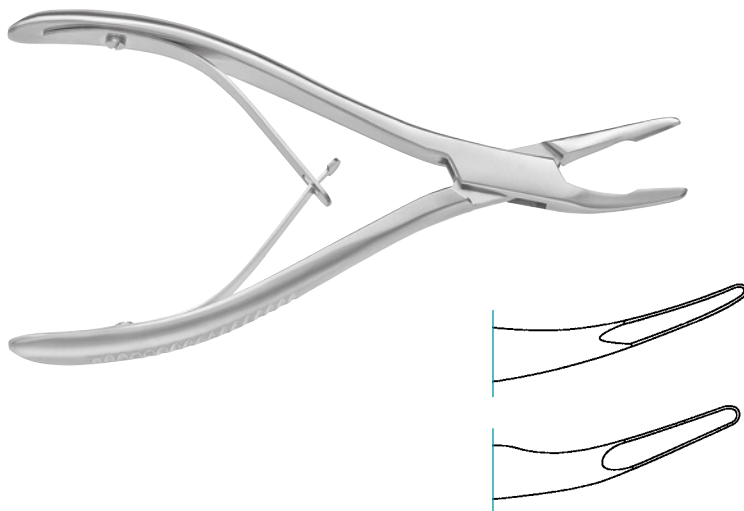

BEYER

Bone Rongeur, 3x16mm, 180mm, 7"

curved	210-830-180
strongly curved	210-831-180

**KERRISON**

Bone Punch, 90mm working length

3.0 x 9.0mm bite 410-245-000

85mm working length

4.0mm jaw 410-245-001

5.0mm jaw 410-245-002

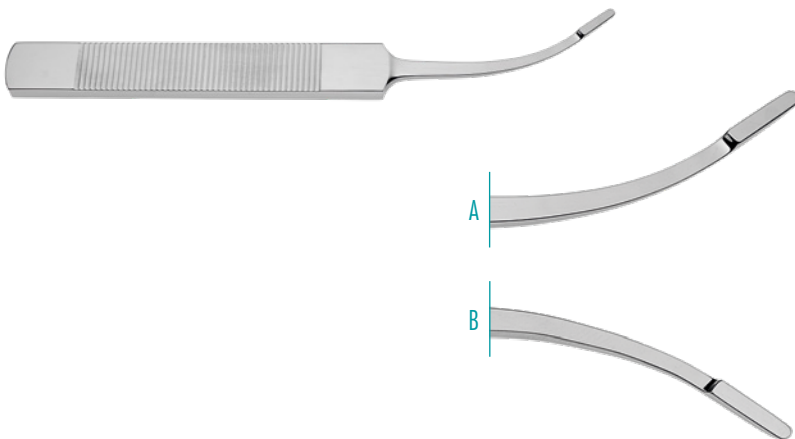
**STENSTROM**Ear Scraper, 160mm, 6¹/₄"

A curved left 410-033-130

B curved right 410-033-131

**DINGMANN**

Otobradars, left and right

160mm, 6¹/₄" 410-033-100

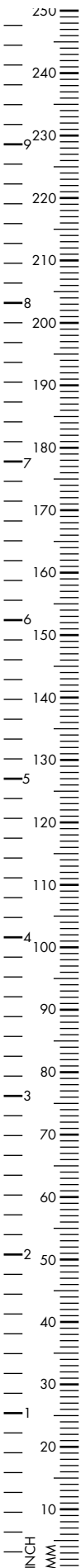

NIJMEGEN

Suction Tube, cylindrical with cone,
60mm working length

Ø 1.0mm	410-060-010
Ø 1.5mm	410-060-015
Ø 2.0mm	410-060-020
Ø 2.5mm	410-060-025
Ø 3.0mm	410-060-030
Ø 4.0mm	410-060-040



Suction Tube, knee bent,
90mm working length

Ø 1.0mm	410-090-010
Ø 1.5mm	410-090-015
Ø 2.0mm	410-090-020
Ø 3.0mm	410-090-030
Ø 4.0mm	410-090-040
Ø 5.0mm	410-090-050



Suction Tube, knee bent,
110mm working length

1.0mm	410-090-110
1.5mm	410-090-115
2.0mm	410-090-120
2.5mm	410-090-125
3.0mm	410-090-130
4.0mm	410-090-140
5.0mm	410-090-150



Suction Tube, malleable,
175mm working length

Ø 3.0mm 410-225-003



FERGUSSON

Suction tube, finger cut-off, stylet, Luer hub,
130mm, 5¹/₈"

Ø 1.5mm 165-625-005

Ø 2.0mm 165-625-006

Ø 2.5mm 165-625-008

Ø 3.0mm 165-625-010

Ø 4.0mm 165-625-012

Ø 5.0mm 165-625-015

180mm, 7"

Ø 1.5mm 165-525-005

Ø 2.0mm 165-525-006

Ø 2.5mm 165-525-008

Ø 3.0mm 165-525-010

Ø 4.0mm 165-525-012

Ø 5.0mm 165-525-015

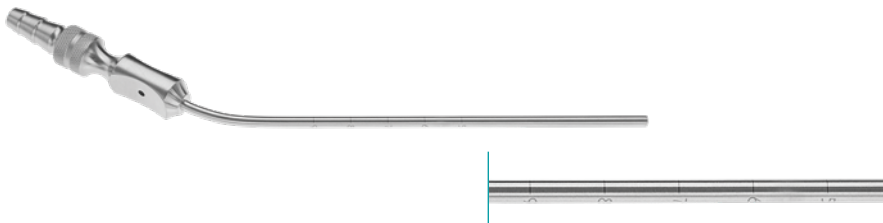

FRAZIER

Suction Tube, 100mm working length,
with length marking

5 Charr. 165-523-105

7 Charr. 165-523-107

9 Charr. 165-523-109



PLESTER

Suction Tube, 140mm working length

5 Charr. 165-725-005

7 Charr. 165-725-007

8 Charr. 165-725-008

9 Charr. 165-725-009

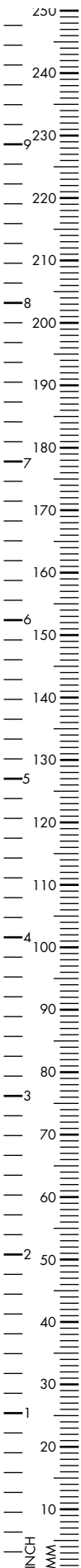
**HOUSE**

Suction Cannula, finger cut-off and stylet,
90mm, 3¹/₂"

Ø 0.9mm / Ø 0.7mm	252-140-003
Ø 1.2mm / Ø 0.9mm	252-140-004
Ø 1.5mm / Ø 1.2mm	252-140-005
Ø 1.5mm / Ø 1.8mm	252-140-006
Ø 2.5mm / Ø 2.0mm	252-140-007
Ø 3.0mm / Ø 2.0mm	252-140-008
Ø 4.5mm / Ø 2.0mm	252-140-009

WULLSTEIN

Suction Cannula, cylindrical, silver plated,
with stylet, olive with Luer hub, 160mm, 6¹/₄"

Ø 1.5mm	410-135-160
Ø 2.0mm	410-132-160
Ø 3.0mm	410-133-160

VERHOEVEN

Suction Cannula, straight,
100 mm working length

Ø 2.0mm	410-134-320
Ø 1.5mm	410-134-316
Ø 1.2mm	410-134-312

**VERHOEVEN**

Suction Tube, 100mm working length

Ø 2.0mm

curved up 410-134-120

curved down 410-134-220

110mm working length

Ø 1.6mm

curved up 410-134-116

curved down 410-134-216

**TALESHI**

Suction, 3 Charr.

40° upwards 410-133-143

40° downwards 410-133-243

70° upwards 410-133-173

70° downwards 410-133-273

5 Charr.

40° upwards 410-133-145

40° downwards 410-133-245

70° upwards 410-133-175

70° downwards 410-133-275

**BARON**

Suction Tube, finger cut-off, stylet,

75mm, 3"

3 Charr. 165-538-003

5 Charr. 165-538-005

7 Charr. 165-538-007

100mm, 4"

3 Charr. 165-539-003

5 Charr. 165-539-005

7 Charr. 165-539-007

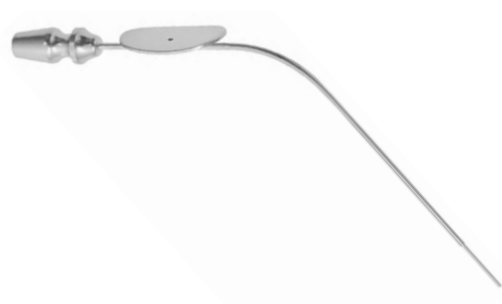
**SCHUKNECHT**Suction Tube, 135mm, 5¹/₃"

Ø 0.6mm 165-536-006

Ø 0.7mm 165-536-007

Ø 0.9mm 165-536-009

Ø 1.0mm 165-536-010

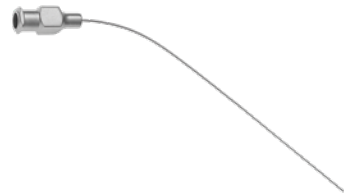
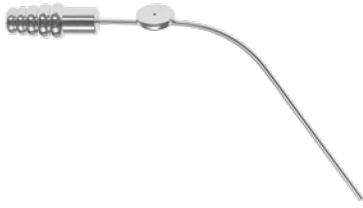
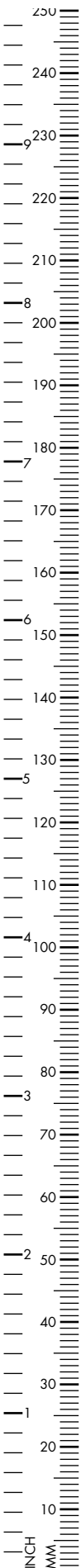
**BARNES**

Suction Tube, 50mm working length

Ø 1.5mm	410-150-015
Ø 1.7mm	410-150-017
Ø 2.0mm	410-150-020

HOUSE

Suction Adapter, finger cut-off, olive: Ø 7mm

51mm, 2 ¹ / ₈ "	420-195-000
---------------------------------------	-------------

WULLSTEIN

Aural Suction Handle, finger cut-off, Luer cone

	420-196-000
--	-------------

HOUSEAural Suction Cannula with Luer cone,
set with 2 pieces

Ø 0.5mm	420-196-005
Ø 0.6mm	420-196-006
Ø 0.7mm	420-196-007
Ø 0.8mm	420-196-008
Ø 0.9mm	420-196-009
Ø 1.0mm	420-196-010
Ø 1.2mm	420-196-012
Ø 1.5mm	420-196-015
Ø 2.0mm	420-196-020
Ø 2.5mm	420-196-025

**ROSEN**Suction Cannula, angled,
65mm working length

GA 9 Ø 3.0mm	410-133-005
GA 10 Ø 2.5mm	410-133-006
GA 13 Ø 2.2mm	410-133-007
GA 14 Ø 2.0mm	410-133-008
GA 15 Ø 1.8mm	410-133-009
GA 16 Ø 1.6mm	410-133-010
GA 17 Ø 1.5mm	410-133-013
GA 18 Ø 1.2mm	410-133-015
GA 19 Ø 1.0mm	410-133-018
GA 20 Ø 0.9mm	410-133-020
GA 21 Ø 0.8mm	410-133-025
GA 22 Ø 0.7mm	410-133-030
GA 24 Ø 0.6mm	410-133-035
GA 26 Ø 0.5mm	410-133-040

**VERHOEVEN**

Suction Tube, 60mm working length

Ø 1.6mm	410-134-016
Ø 1.2mm	410-134-012
Ø 0.9mm	410-134-009
Ø 0.7mm	410-134-007
Ø 0.6mm	410-134-006

Suction Tube, malleable,
80mm working length

Ø 0.5mm	410-138-005
Ø 0.7mm	410-138-007
Ø 1.0mm	410-138-010
Ø 1.2mm	410-138-012
Ø 1.5mm	410-138-015
Ø 2.0mm	410-138-020
Ø 2.5mm	410-138-025
Ø 3.0mm	410-138-030

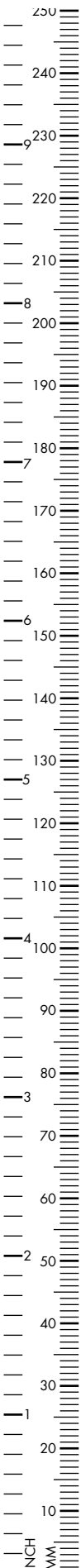
**ZOELLNER**

Suction Tube, s/s, tube with stilette,
175mm, 6⁷/₈"

Ø 8mm olive	410-267-100
Ø 8mm olive, with suction hole	410-267-101

**ZOELLNER**

Suction Tip, 55mm, 10 pcs. per package

Ø 1.2mm / 18swg	410-267-012
Ø 0.9mm / 20swg	410-267-009
Ø 0.8mm / 21swg	410-267-008
Ø 0.7mm / 22swg	410-267-007
Ø 0.6mm / 24swg	410-267-006
Ø 0.5mm / 25swg	410-267-005
Ø 0.4mm / 26swg	410-267-004

**FISCH**

Suction Tube, 145mm working length

Ø 1.2mm	410-269-012
Ø 1.5mm	410-269-015
Ø 2.0mm	410-269-020
Ø 2.2mm	410-269-022
Ø 2.5mm	410-269-025
Ø 3.0mm	410-269-030
Ø 5.0mm	410-269-050

EESy

The **EESy** instruments allows the surgeon to use the one-hand technique. The instruments are a suction – cutting – dissection combination. These gives you major benefits in ESS and reduce the limitations of the endoscopic approach.

With the **EESy** you have one hand for the scope and the other for the instrument. You avoid the constant change of instruments and suction devices.

With **EESy** Instruments, surgeons can choose between two ergonomic concepts—SoftGrip for enhanced handling comfort and Pure for a streamlined all-steel experience. Both systems are engineered to support precision and control in endoscopic ear surgery.

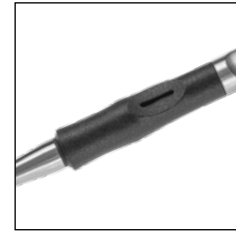

SoftGrip



Pure



Benefits:

- Different tips in one design keeps your handling consistent
- Mini working tips combines with suction cannulas
- Less blood or tissue parts in the field of view
- Instrument can be kept in the surgical field

EESy Endoscopic Ear Instruments

A 130mm working length SoftGrip

B 135mm working length Pure



Dissector, single curved,
3.0mm / 6.2mm, left

A 410-880-001

B 410-880-501



Dissector, single curved,
3.0mm / 6.2mm, right

A 410-880-002

B 410-880-502



Dissector, single curved,
0.6mm, Ø 1.0mm suction channel, left

A 410-880-003

B 410-880-503



Dissector, single curved,
0.6mm, Ø 1.0mm suction channel, right

A 410-880-004

B 410-880-504



Dissector, double curved,
3.0mm / 6.2mm, left

A 410-880-005

B 410-880-505



Dissector, double curved,
3.0mm / 6.2mm, right

A 410-880-006

B 410-880-506



Dissector
3.0mm / 6.2mm, left

A 410-880-007

B 410-880-507



Dissector
3.0mm / 6.2mm, right

A 410-880-008

B 410-880-508



Dissector
extra fine, left

A 410-880-009

B 410-880-509



Dissector
extra fine, right

A 410-880-010

B 410-880-510



Micro Hook
1.0mm/6.2mm, 45°

A 410-880-011



Micro Hook
1.5mm/6.2mm, 45°

A 410-880-012

B 410-880-512



Micro Hook
2.0mm/6.2mm, 45°

A 410-880-013

B 410-880-513

EESy Endoscopic Ear Instruments

A 130mm working length SoftGrip

B 135mm working length Pure

Round Knife
Ø 2.5mm/6.2mm, 45°

A 410-880-014

B 410-880-514

Round Knife
Ø 2.0mm/6.2mm, 45°

A 410-880-015

Round Knife
Ø 2.5mm/6.2mm, 45°

A 410-880-016

Knife, oval
2.5 x 3.5mm, left

A 410-880-017

B 410-880-517

Knife, oval
6.2mm, right

A 410-880-018

B 410-880-518

Sickle Knife
2.0mm, 35° curved

A 410-880-019

B 410-880-519

Curette
1.5 x 2.5mm, curved

A 410-880-020

Suction Finder
blunt

A 410-880-021

Suction Adaptor,
rotatable,
male, LuerLock

55° curved 410-880-000



Otoscope, Ø 3.0mm, 110mm

0°	410-130-000
30°	410-130-030
45°	410-130-045
70°	410-130-070

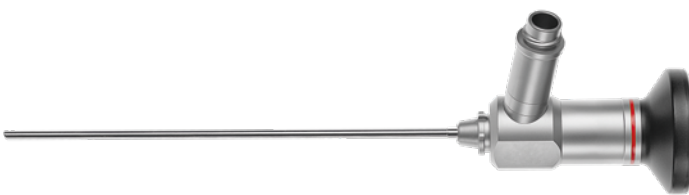

Ø 3.0mm, 140mm

0°	410-130-100
30°	410-130-130
45°	410-130-145
70°	410-130-170

Preyer Irrigation Tube for Endoscopic Ear Surgery

The irrigation tube is designed for intraoperative use during endoscopic ear surgery. It is guided alongside the endoscope to provide a controlled irrigation environment within the surgical field. Developed in collaboration with Prof. Dr. Preyer, the device addresses specific surgical needs observed in clinical practice.

The application of fluid plays a crucial role in the management of cholesteatoma, as the lesion becomes mobile under water and tends to rise. This behavior facilitates improved visualization and access, enabling more precise and efficient dissection. In combination with RZ **EESy** instruments, the irrigation tube supports atraumatic preparation and enhances surgical control, contributing to optimized procedural outcomes.

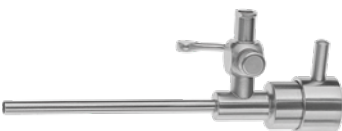

PREYER

Endoscope Irrigation Tube

for Ø 3.0mm, 110mm	410-880-356
for Ø 3.0mm, 140mm	410-880-387



Knife Handle #7
165mm, 6¹/₂" 110-130-077



Knife Handle #3
130mm, 5¹/₈" 110-110-003



WULLSTEIN
Raspatory
190mm, 7¹/₂" 410-329-190



BEALES
Raspatory, 165mm, 6¹/₂"
A 410-328-165
B spatula end 410-327-165

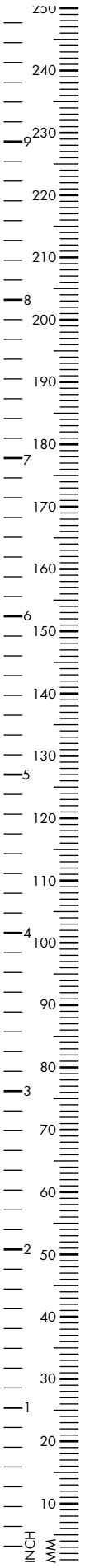

LEMPERT

Raspatory, narrow, 160mm, 6^{1/4}"

3mm	410-330-160
4mm	410-331-160



FISCH

Dura Elevator, 5mm

170mm, 6 ^{2/3} "	410-145-170
---------------------------	-------------



LEMPERT

Lempert Micro Ear Elevator,
slightly curved, 2mm

160mm, 6 ^{1/4} "	410-334-160
---------------------------	-------------

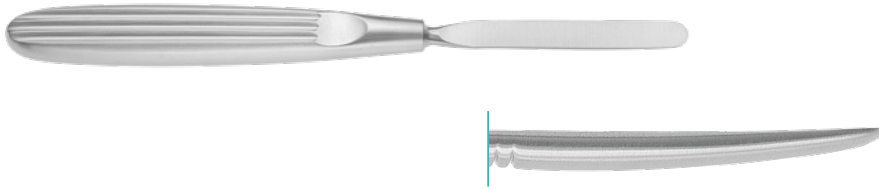
**PLESTER**

Raspatory, 180mm, 7"

8mm

410-146-180

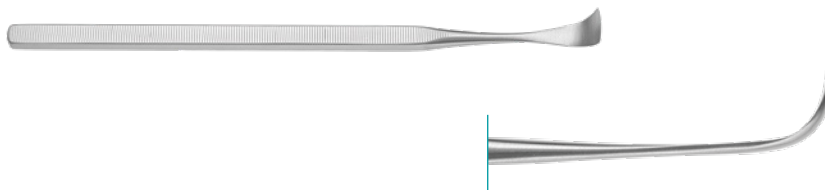
**FISCH**

Raspatory, 180mm, 7"

10mm

410-147-160

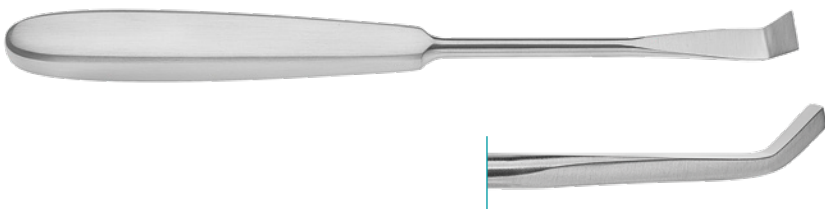

Periosteal Raspatory, 11mm

210mm, 8^{1/4}"

410-148-210

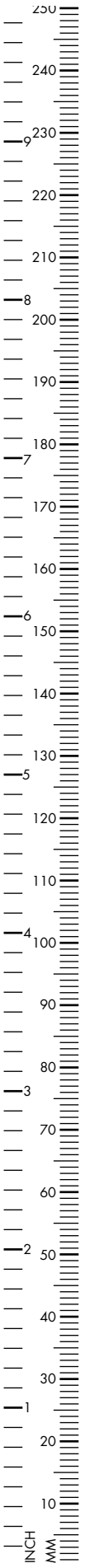

JANSEN

3x3 prongs, 100mm, 4"

sharp	170-720-100
blunt	170-723-100



BABY WEITLANER

2x3 teeth, 105mm, 4 1/8"

sharp	170-748-105
blunt	170-749-105
semi-sharp	170-750-105



WEITLANER

3x4 teeth, sharp

165mm, 6 1/2"	170-750-165
200mm, 8"	170-750-200



WULLSTEIN

Self-retaining Retractor, 3x3 prongs, 110mm, 4 1/3"

sharp	170-752-110
blunt	170-753-110



WULLSTEIN

Self-retaining Retractor, 3x3 prongs, 130mm, 5 1/8"

sharp	170-752-130
blunt	170-753-130



BELLUCCI

Self-retaining Retractor, 3x3 sharp teeth, angled arms

	170-759-130
--	-------------

**PERKINS**Antrum Retractor, 130mm, 5¹/₈"

serrated blade on right side, 3 teeth left	170-765-135
--	-------------

serrated blade on left side, 3 teeth right	170-766-135
--	-------------

**ADSON ANDERSON**4x4 teeth, curved arms, 195mm, 7³/₄"

sharp	170-732-200
-------	-------------

blunt	170-733-200
-------	-------------

**RZ**Self-retaining Retractor, articulating joints, 3 x 3 prongs, 170mm, 6²/₃"

semi-sharp	170-780-170
------------	-------------

sharp	170-781-170
-------	-------------

blunt	170-782-170
-------	-------------

**RZ**Self-retaining Retractor, 165mm, 6¹/₂"

left blade full, right side 3 prongs	170-780-165
--------------------------------------	-------------

right blade full, left side 3 prongs	170-781-165
--------------------------------------	-------------

**HOUSE**

Self-retaining Retractor, with hinge,
165mm, 6¹/₂"

left side full blade, right 3 prongs	170-783-165
right side full blade, left 3 prongs	170-784-165

**WEITLANER BECKMANN**

3x4 teeth, hinged arms, sharp

140mm, 5 ¹ / ₂ "	170-746-140
160mm, 6 ¹ / ₄ "	170-746-160
200mm, 8"	170-746-200
240mm, 9 ¹ / ₂ "	170-746-240

blunt

140mm, 5 ¹ / ₂ "	170-747-140
160mm, 6 ¹ / ₄ "	170-747-160
200mm, 8"	170-747-200
240mm, 9 ¹ / ₂ "	170-747-240

**PLESTER**

2 teeth, blunt, 110mm, 4¹/₃"

solid blade on right	170-760-110
solid blade on left	170-761-110

2x2 teeth, 105mm, 4¹/₈"

blunt	170-762-110
sharp	170-763-110

**PLESTER**

2x2 teeth, 130mm, 5¹/₈"

blunt	170-762-130
sharp	170-763-130

**SCOVILLE HAVERFIELD**

Spreader, rigid arms, without valves

171mm spread 170-906-000

hinged arms, without valves

171mm spread 170-906-001



Hook, blunt

51mm 170-906-102

75mm 170-906-104



Hook, with crossbar

51mm 170-906-106

75mm 170-906-108



Blade, toothed

26 x 63mm 170-906-122

51 x 63mm 170-906-124

32 x 66mm 170-906-126

26 x 89mm 170-906-128



Blade, forked, blunt

38 x 41mm 170-906-144

48 x 66mm 170-906-145

FINESS MICRO & NANO EAR FORCEPS

Designed for Precision in Otologic Microsurgery

The FINESS Micro and Nano Ear Forceps are developed for delicate procedures requiring exceptional control and atraumatic tissue handling. Micro models provide an optimal balance of stability and precision, while Nano models feature ultra-slimmer jaws and shafts to maximize visibility under the operating microscope.

Ergonomically designed rings, refined tactile feedback and precise mechanical action support confident handling during demanding microscopic procedures.

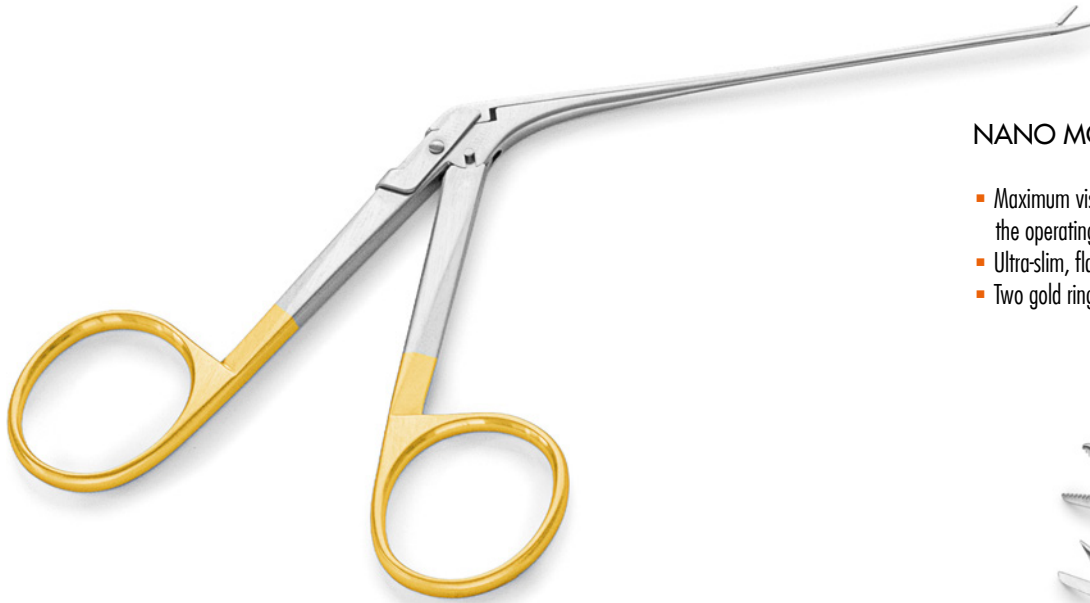

NANO MODELS

- Maximum visibility under the operating microscope
- Ultra-slim, flat jaws reduce visual obstruction
- Two gold rings for instant identification



FINESS

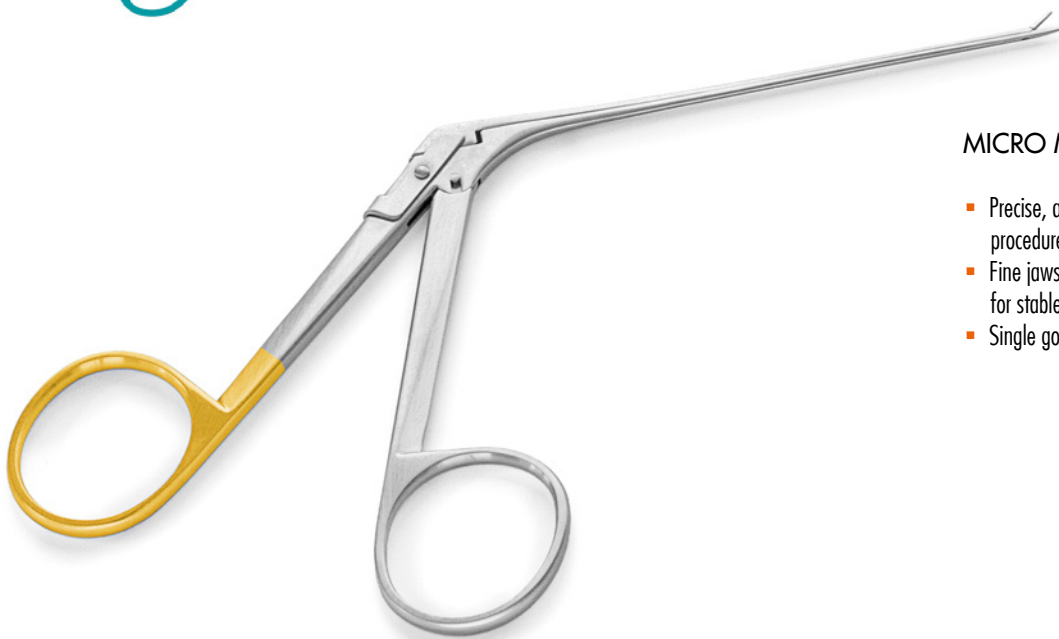

MICRO MODELS

- Precise, atraumatic control in delicate procedures
- Fine jaws and streamlined shaft for stable handling
- Single gold ring for instant identification

FINESS MICRO & NANO EAR FORCEPS



Nano Ear Forceps,
3.5mm long jaw, serrated

410-800-950



Nano Cup Forceps, 0.6mm

410-800-970



Nano Scissors

410-800-990



Micro Ear Forceps,
3.5mm long jaw, serrated

410-800-960



Micro Cup Forceps, 0.6mm

410-800-980

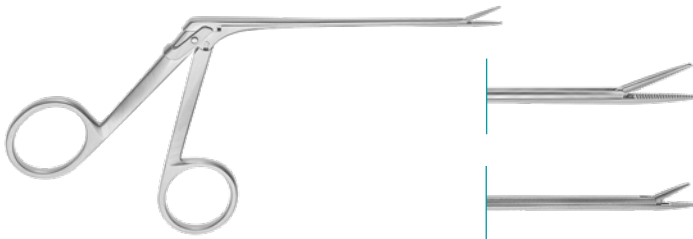
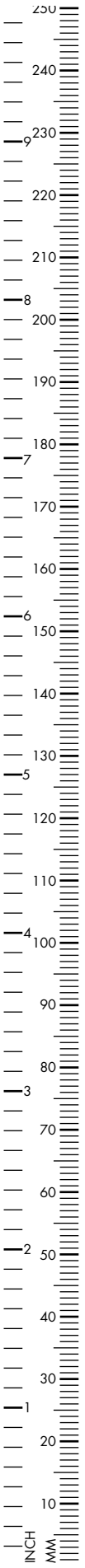

HARTMANN

Ear Forceps, 80mm working length, straight

1 x 8mm 410-210-085

125mm working length, straight

1 x 4.5mm 410-210-125

HARTMANN-WULLSTEIN

Ear Forceps, 80mm working length, straight

0.8 x 6.0mm 410-345-080

0.8 x 4.0mm 410-344-080

Ear Forceps, 80mm working length,

A Alligator, extra fine, 0.8 mm wide, straight

4.5mm jaw 410-335-800

B CERACUT®

4.5mm jaw 410-335-800CC

C smooth jaw

4.5mm jaw 410-335-700

D curved right

410-335-600

E curved left

410-335-500

F upcurved

410-335-400

G downcurved

410-335-300

H right curved

410-335-600

**HARTMANN**

Ear Forceps, 4.0mm long jaw,
serrated, self-closing

410-330-700

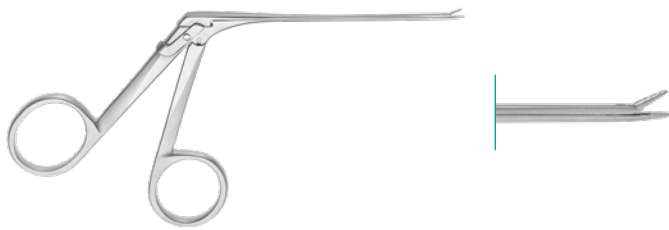

Ear Forceps, 80mm working length,
Alligator, extra fine, straight

0.8 x 3.0mm jaw 410-330-800

**DUCKBILL-WULLSTEIN**

Ear Forceps, extra delicate, smooth jaws

410-330-900

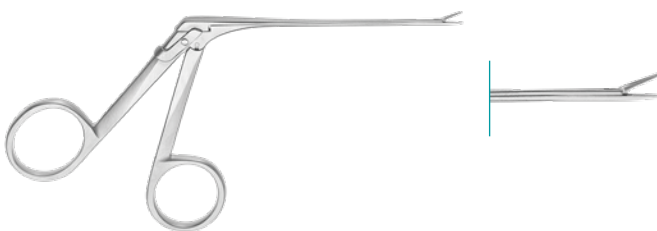
**FISCH**

Ear Forceps, very delicate, serrated,
1.5mm shaft, straight, 80mm working length

0.6 x 4.0mm 410-357-080

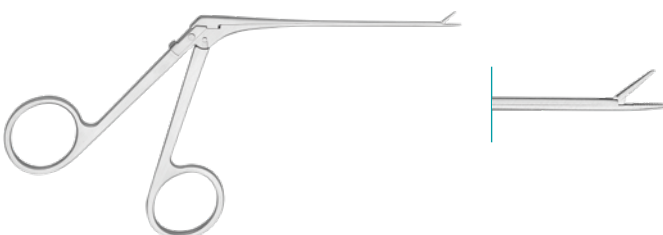
**FISCH**

Ear Forceps, very delicate, serrated,
1.5mm shaft, straight, 80mm working length

0.5 x 4.5mm 410-356-080

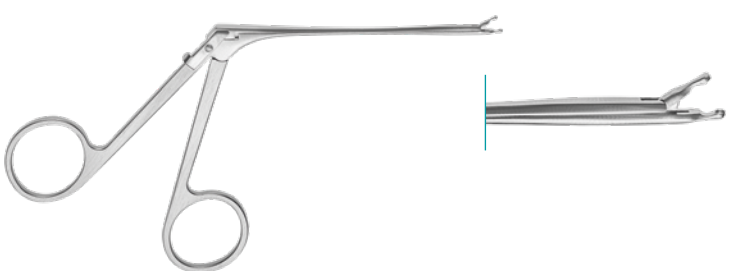
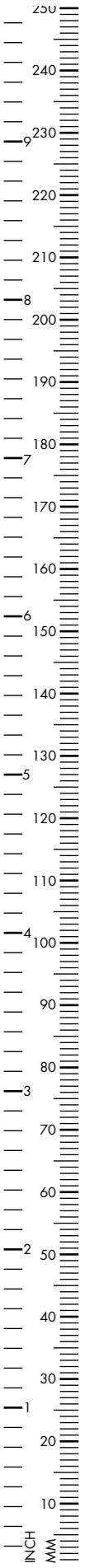

HARTMANN-WULLSTEIN

Ear Forceps, 80mm working length
straight, cup-shaped, round cup

1.0mm 410-346-080

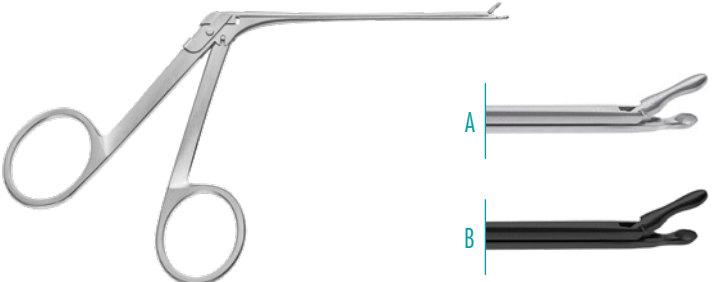

oval cups, 0.9mm wide,
fine model, 4.5mm jaw length

- A straight 410-341-500
- B CERACUT® 410-341-500CC
- C left curved 410-343-500
- D right curved 410-344-500
- E upwards curved 410-342-500
- F downwards curved 410-347-500

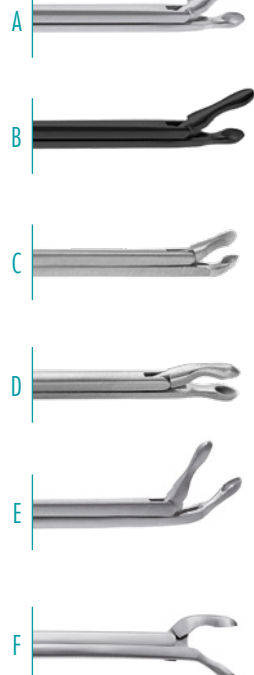

Micro Cupped Forceps, 0.5 x 1.0 mm,
extra fine, oval

straight 410-330-004



Micro Cupped Forceps, 0.8 x 1.3 mm,
fine, oval

- A curved downwards 410-330-002
- B curved upwards 410-330-003

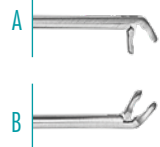

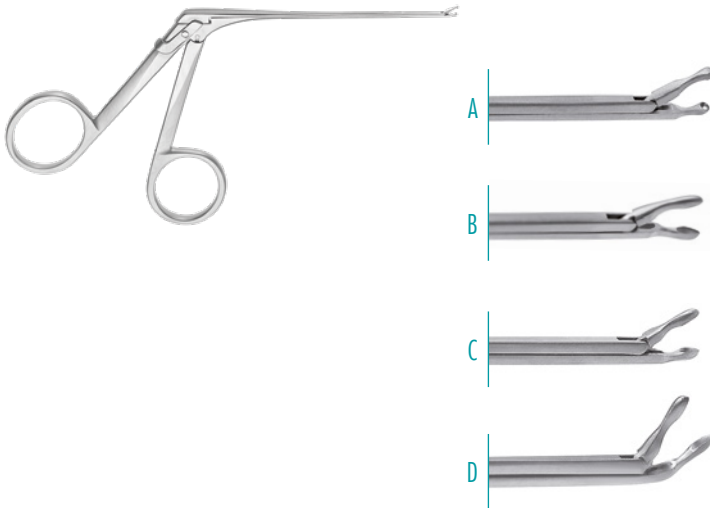

oval cups, 0.6mm wide,
4.5mm jaw

A straight	410-341-800
B right curved	410-344-800
C left curved	410-343-800
D 35° upwards	410-342-800



Micro Spoon Forceps, oval,
superfine, 0.5 x 1.0mm, 1.3 mm shaft

A straight	410-341-900
B upwards	410-342-900



BELLUCCI

Micro Ear Scissors, 8mm cutting blade

A stainless steel	410-350-200
B CeraCut®	410-352-080CC



BELLUCCI

Micro Ear Scissors, 4mm blade

curved upwards	410-351-700
----------------	-------------

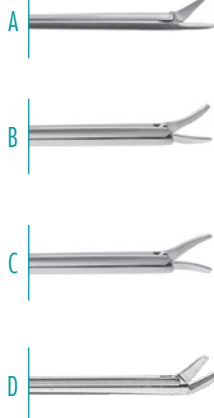
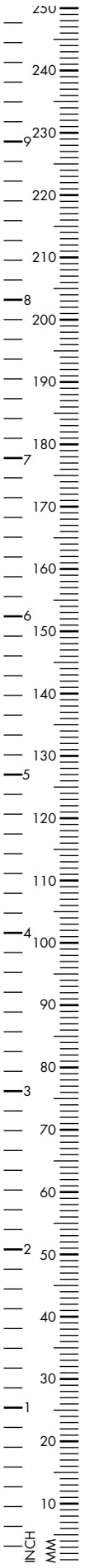

Middle model, 5.0mm blade length,
87mm working length

A straight	410-350-500
B left curved	410-352-500
C right curved	410-353-500
D 35° upcurved	410-351-500

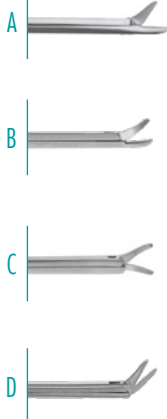

HOUSE BELLUCCI

Ear Scissors, fine model, 4.5mm blade

A straight	410-350-700
B left curved	410-352-700
C right curved	410-353-700
D curved up	410-351-700

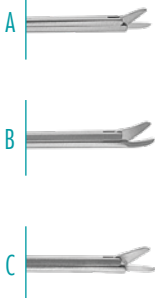

HOUSE BELLUCCI

Ear Scissors, extra fine

A straight	410-350-100
B left curved	410-352-100
C right curved	410-353-100



HOUSE BELLUCCI

Ear Scissors, extra fine, serrated blade,
3.5mm blade length

straight	410-351-800
----------	-------------



HOUSE BELLUCCI

Ear Scissors, superfine, 2.0mm blade length

straight	410-351-900
----------	-------------



Crurotomy Scissors,
80mm working length

A opening to left	410-250-001
-------------------	-------------

B opening to right	410-250-002
--------------------	-------------

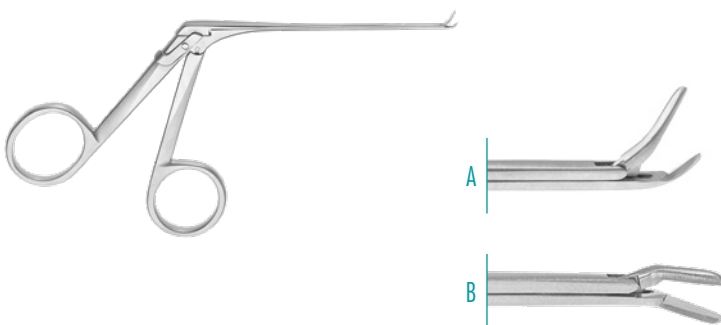

HOUGH

Nipper Forceps, angled, fine model

A 45° left	410-365-080
------------	-------------

B 45° right	410-366-080
-------------	-------------

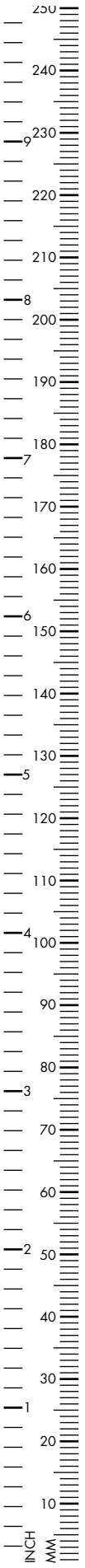

DIETER

Malleus Nipper, 80mm working length

A upwards cutting	410-300-100
B downwards cutting	410-301-100

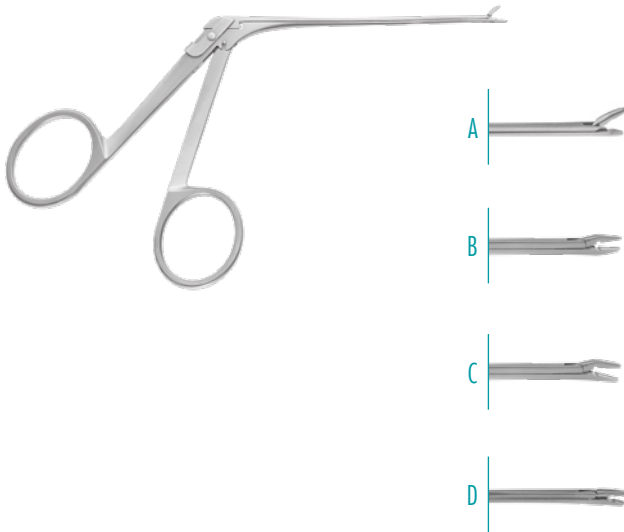

MC GEE

Malleus Crimper, fine model

A straight	410-359-200
B bent left	410-359-100
C bent right	410-359-300

HOUSE-MC GEE

Malleus Crimper

D superfine model	410-359-500
-------------------	-------------



MCGEE

Malleus Crimper, large model,
80mm working length

410-360-500



GREVEN

fine model

410-361-080

**VENT**

Tube Forceps, fine model

410-340-080

**KOS**

fine model

410-350-132

Micro Grasping Forceps, straight, jaw
with cross grooves, 1.4 x 4.0mm

straight

410-368-080

**SOFFERMANN**Needle Holder with ratchet, with sliding shaft,
serrated jaws, 4.5mm jaw

100mm working length 410-208-100

Aural forceps, tubular shaft, shaft 1.5mm, jaws 2.3mm
80mm working length



1 x 2 teeth
straight 410-342-100



serrated jaws
straight 410-342-110



Cup-Shaped Forceps, straight

Ø 1.0mm	410-343-110
Ø 1.5mm	410-343-210
Ø 2.0mm	410-343-310
Ø 2.5mm	410-343-410
Ø 1.5 x 0.8mm	410-343-510



Cup-Shaped Forceps,
angled up

Ø 1.0mm	410-343-120
Ø 1.5mm	410-343-220
Ø 2.0mm	410-343-320
Ø 2.5mm	410-343-420
Ø 1.5 x 0.8mm	410-343-520



Cup-Shaped Forceps,
curved right

Ø 1.0mm	410-343-130
Ø 1.5mm	410-343-230
Ø 2.0mm	410-343-330
Ø 2.5mm	410-343-430
Ø 1.5 x 0.8mm	410-343-530



Cup-Shaped Forceps,
curved left

Ø 1.0mm	410-343-140
Ø 1.5mm	410-343-240
Ø 2.0mm	410-343-340
Ø 2.5mm	410-343-440
Ø 1.5 x 0.8mm	410-343-540



straight
410-351-010



straight horizontal
410-351-020



angled up
410-351-030



angled up horizontal
410-351-040



curved right
410-351-050



curved left
410-351-060

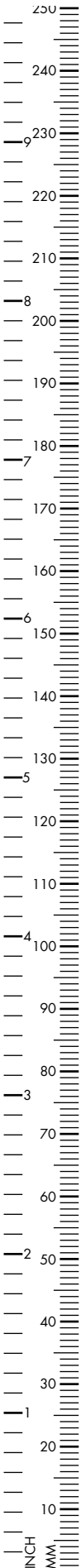

Aural Forceps, 0.9mm tubular shaft, 1.8mm jaws
80mm working length



straight

410-352-010



straight horizontal

410-352-020



angled up

410-352-030



angled up horizontal

410-352-040



curved right

410-352-050



curved left

410-352-060



1 x 2 teeth

straight

410-343-100



serrated

straight

410-341-100

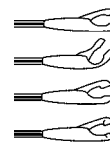

cup-shaped

straight

410-340-100

curved up

410-340-120

curved right

410-340-130

curved left

410-340-140

Micro Ear Instruments with tubular shaft
and LuerLock cleaning channel
80mm working length



HARTMANN
straight

0.8 x 3.5mm 410-330-000

HARTMANN
straight

1.0 x 5.0mm 410-335-00

HARTMANN
straight

1.5 x 6.0mm 410-321-000

WULLSTEIN
straight, oval cup spoon

0.9 x 1.0mm 410-341-000

WULLSTEIN
straight, oval cup spoon

0.8 x 1.3mm 410-345-000

WULLSTEIN
straight, round cup spoon

∅ 1.0 mm 410-346-000

BELLUCCI
Micro scissors, straight

5.0mm 410-350-000

BELLUCCI
Micro scissors, curved left

5.0mm 410-352-000

BELLUCCI
Micro scissors, curved right

5.0mm 410-353-000

MCGEE
Malleus Crimper

3.5mm jaw length 410-359-000

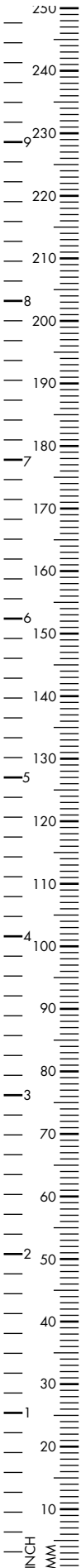

FINESS MICRO ROUND-HANDLE INSTRUMENTS

Precision, Control and Tactile Intelligence

The FINESS Micro Round-Handle Instruments are developed for surgeons who rely on precise tactile feedback and controlled micro-movements during otologic microsurgery.

The ergonomic round handle supports effortless rotation and accurate tip positioning, while integrated grooves enhance orientation and handling.

Combined with finely polished working ends and clear laser markings, the system delivers precision, efficiency and confidence under the microscope.



165mm working length

WULLSTEIN

Micro Hook, 90° angled

0.2mm	410-800-102
0.4mm	410-800-104
0.5mm	410-800-105
0.6mm	410-800-106
0.8mm	410-800-108
1.0mm	410-800-110
1.2mm	410-800-112
1.5mm	410-800-115
2.0mm	410-800-120
2.5mm	410-800-125
3.0mm	410-800-130
4.0mm	410-800-140

WULLSTEIN

Micro Hook, 45° angled

0.2mm	410-800-202
0.4mm	410-800-204
0.6mm	410-800-206
0.8mm	410-800-208
1.0mm	410-800-210
1.2mm	410-800-212
1.5mm	410-800-215
2.0mm	410-800-220
2.5mm	410-800-225

ROSEN

Round Knife, 45° angled

1.0mm	410-800-310
1.2mm	410-800-312
1.5mm	410-800-315
1.8mm	410-800-318
2.0mm	410-800-320
2.3mm	410-800-323
2.5mm	410-800-325
3.0mm	410-800-330

ROSEN

Round Knife, 90° angled

0.6mm	410-800-406
1.0mm	410-800-410
1.5mm	410-800-415
2.0mm	410-800-420
2.3mm	410-800-423
2.5mm	410-800-425

ROSEN

Round Knife, 0° angled

1.0mm	410-800-510
1.5mm	410-800-515
2.0mm	410-800-520
2.3mm	410-800-523
2.5mm	410-800-525
3.0mm	410-800-530

FINESS MICRO ROUND-HANDLE INSTRUMENTS

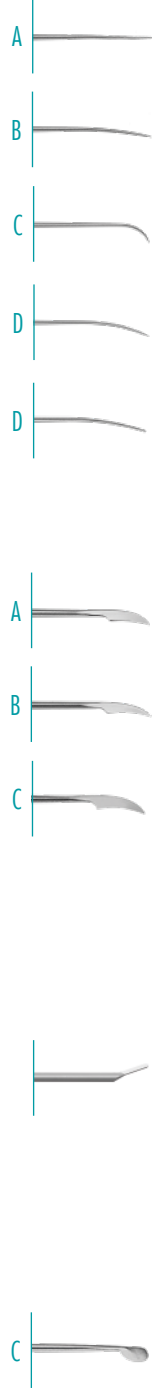
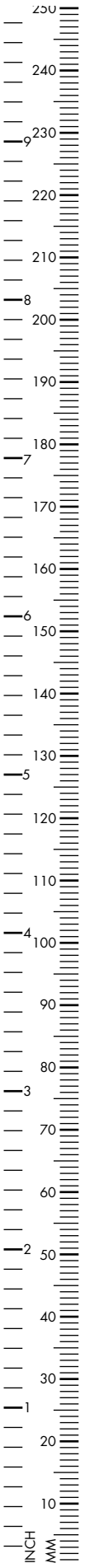

WULLSTEIN

Micro Needle

A	straight, sharp	410-800-600
B	very slightly curved, sharp	410-800-610
C	strongly curved, sharp	410-800-620
D	slightly curved, sharp	410-800-630
E	very slightly curved, blunt	410-800-640

WULLSTEIN

Sickle Knife

A	slightly curved	410-800-710
B	slightly curved, delicate	410-800-720
C	strongly curved	410-800-730

Incodostapedial Joint Knife

20°, 2.2mm	410-800-722
------------	-------------

PLESTER

Flap Knife, vertical, oval

3.5 x 2.5mm	410-800-732
-------------	-------------

FINESS MICRO ROUND-HANDLE INSTRUMENTS

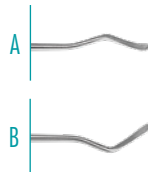

AUSTIN

Dissector

A right curved 410-800-801

B left curved 410-800-802



FISCH

Dissector, single curved

A right 410-800-811

B left 410-800-812

double curved

C right 410-800-821

D left 410-800-822



PREYER

Dissector, sinus tympani, circular marking

A right curved 410-800-831

B left curved 410-800-832



FISCH

Footplate Perforator

0.3mm 410-800-843

0.4mm 410-800-844

0.5mm 410-800-845

0.6mm 410-800-846

F FINESS MICRO ROUND-HANDLE INSTRUMENTS

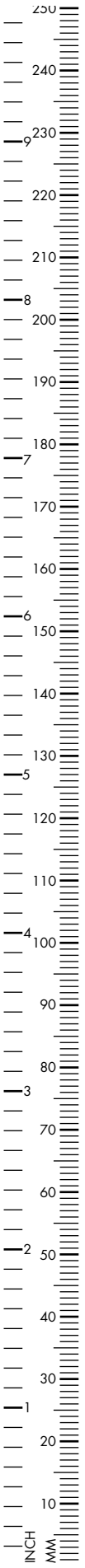

PLESTER

Footplate Hook

0.2mm	410-800-852
0.4mm	410-800-854
0.6mm	410-800-856



Hand burr, diamond, fine

0.7mm	410-800-877
-------	-------------



MOD. TÜBINGEN

Measuring Instrument for Stapes
Prosthesis with ball tip

4.5mm	410-138-045
-------	-------------



THOMASSIN

Dissector, single curved, double ended

180mm, 7"	410-800-901
-----------	-------------



THOMASSIN

Dissector, double curved, double ended

190mm, 7"	410-800-902
-----------	-------------



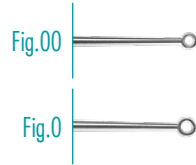

BUCK

Aural Curette

Fig. 00	410-103-000
Fig. 0	410-103-001



PLESTER

Flap Knife, round cutting, 160mm, 6^{1/4}"

2.4 x 3.0mm	410-124-160
2.4 x 3.5mm	410-092-001

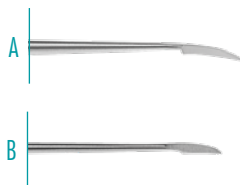

PLESTER

Sickle Knife, 160mm, 6^{1/4}"

A slightly curved	410-101-160
B straight	410-100-160



THOBURN

Sickle Knife, curved

160mm, 6 ^{1/4} "	410-103-160
---------------------------	-------------



BEALES

Tendon Knife

170mm, 6 ^{2/3} "	410-109-170
---------------------------	-------------

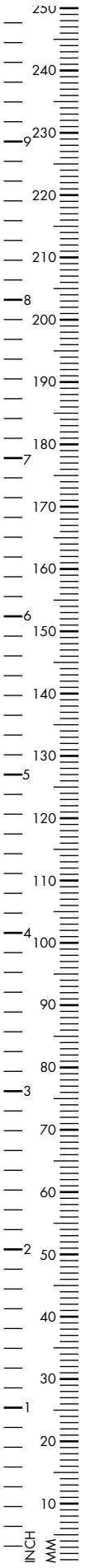

WULLSTEIN

Sickle Knife, delicate, slightly curved

410-105-160



FISCH

Tenotome, curved

410-107-160



KLEY

Knife

410-109-160



ROSEN

Knife and elevator, spear pointed blade

160mm, 6¹/₄" 410-093-160

**SEIFFERT**Salivial Duct Probe, \varnothing 0.9mm

180mm, 7"

410-045-180

**ROSEN**

Elevator, 15° angled tip, 12 x 1.5mm

160mm, 6¹/₄"

410-135-015

**DUCKBILL**

Elevator, 80mm working length

155mm, 6¹/₈"

410-000-155

**BEALES**

Elevator, 1.5mm

410-130-182

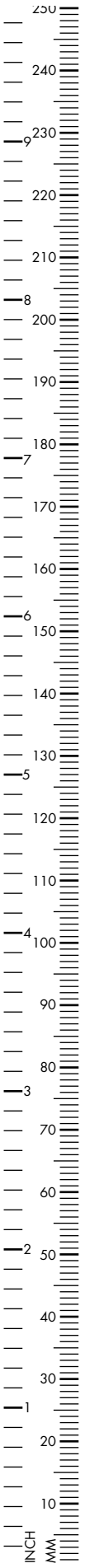

HUGHES
Stapes Mobilizer
165mm, 6¹/₂" 410-216-165



HUGHES
Elevator, 0.6mm
165mm, 6¹/₂" 410-216-166



HOUSE
Stapes Elevator, slightly angled, 12mm,
1mm wide
160mm, 6¹/₄" 410-135-050

**ROSEN**

Elevator, round edge, slightly curved, 1.8mm

160mm, 6^{1/4}" 410-135-051Graft holder and elevator,
2 x 6mm160mm, 6^{1/4}" 410-135-048Eardrum Mirror, 160mm, 6^{1/4}"

Ø 3mm 410-141-163

Ø 5mm 410-141-165



Seeker, 45°, angled

155mm, 6^{1/8}" 410-150-155

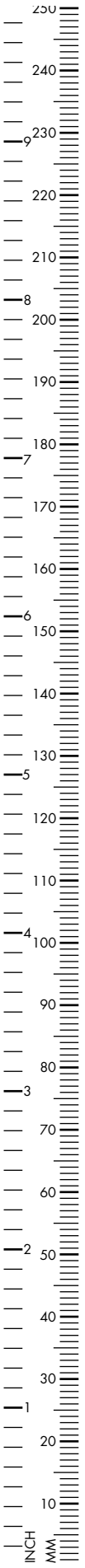

SHEA

Curette for tympanoplasty, sharp, oval cup, upwards cutting, 1.5 x 2.5mm, 160mm, 6¹/₄"

straight	410-046-160
knee bent	410-047-160

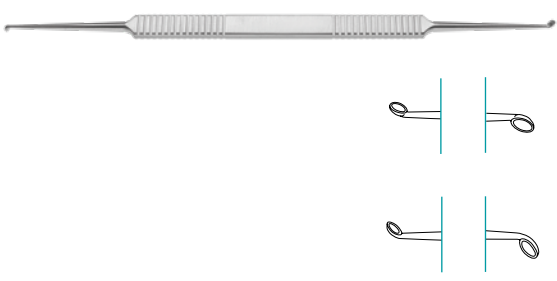

HOUSE

Curette for stapedectomy, sharp, double-ended, oval cup, 150mm, 6"

1.5 x 1.2mm	
slightly curved	410-044-001
strongly curved	410-044-003
1.5 x 1.8mm	
slightly curved	410-044-002
strongly curved	410-044-004



HOUSE

Curette, 20° curved, 150mm, 6"

2.2 x 3.8mm /	410-044-006
2.4 x 4.8mm	
2.6 x 3.5mm /	410-044-007
2.8 x 3.2mm	
0.6 x 0.8mm /	410-044-010
0.8mm x 1.0mm	

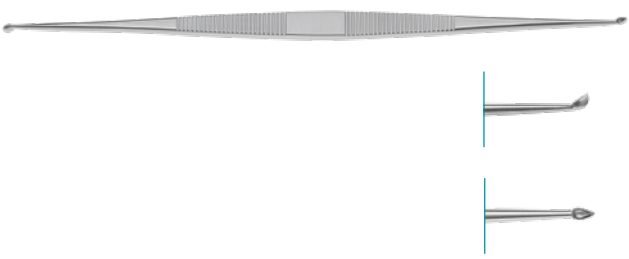

HOUSE

Curette, slightly bent, pointed, 1.6 x 3.0mm / 2.0 x 3.2mm

170mm, 6 ² / ₃ "	410-044-008
--	-------------

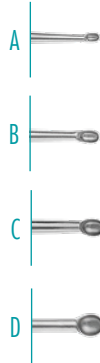

HOUSE

Double Spoon, slightly curved,
170mm, 6²/₃"

A Fig.0	410-044-100
1.0 x 1.6mm / 1.2 x 2.0mm	
B Fig.1	410-044-101
1.5 x 2.5mm / 1.8 x 2.8mm	
C Fig.2	410-044-102
2.2 x 3.0mm / 2.5 x 3.2mm	
D Fig.3	410-044-103
2.6 x 3.2mm / 2.8 x 3.5mm	



HOUSE-STAPES

Curette, double-ended,
2.2 x 3.0mm / 2.5 x 3.2mm
30° angled

170mm, 6 ² / ₃ "	410-044-150
--	-------------

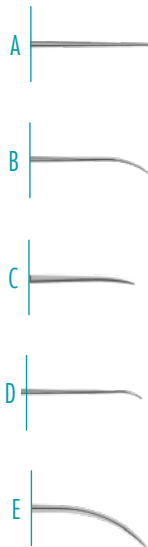

Micro Needle (perforator), 160mm, 6¹/₄"

A straight	
sharp	410-110-155
blunt	410-110-160
B slightly curved, long curvature	
	410-112-155
C slightly curved	
	410-111-155
D acute curved	
	410-114-155
E acute long curvature	
	410-116-155

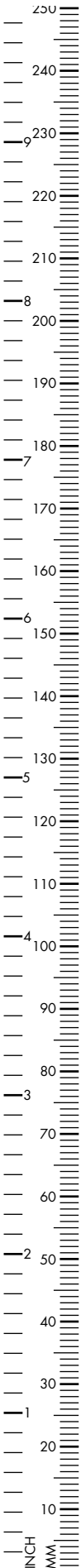

ROSEN

Round Cutting Knife, straight, 160mm, 6¹/₄"

1.0mm	410-128-010
1.5mm	410-128-015
2.0mm	410-128-020
2.5mm	410-128-025
3.0mm	410-128-030



ROSEN

Round Cutting Knife, slender, 160mm, 6¹/₄"

45° angled

Ø 1.0mm	410-118-010
Ø 1.2mm	410-118-012
Ø 1.5mm	410-118-015
Ø 1.8mm	410-118-018
Ø 2.0mm	410-118-020
Ø 2.3mm	410-118-023
Ø 2.6mm	410-118-026
Ø 2.8mm	410-118-028
Ø 3.0mm	410-118-030
Ø 3.5mm	410-118-035
Ø 4.0mm	410-118-040

90° angled

Ø 1.0mm	410-119-010
Ø 1.5mm	410-119-015
Ø 2.0mm	410-119-020
Ø 2.3mm	410-119-023
Ø 2.5mm	410-119-025

**PLESTER**

Wire Guide and Applicator, flat end, V-notch

160mm, 6^{1/4}" 410-216-160**PLESTER**

Aural scraper, 60° angled, 2.0mm

160mm, 6^{1/4}" 410-120-020**HEERMANN**

Hook, reverse cutting, 0.6mm

160mm, 6^{1/4}" 410-216-006

Micro Hook, slightly angled up tip

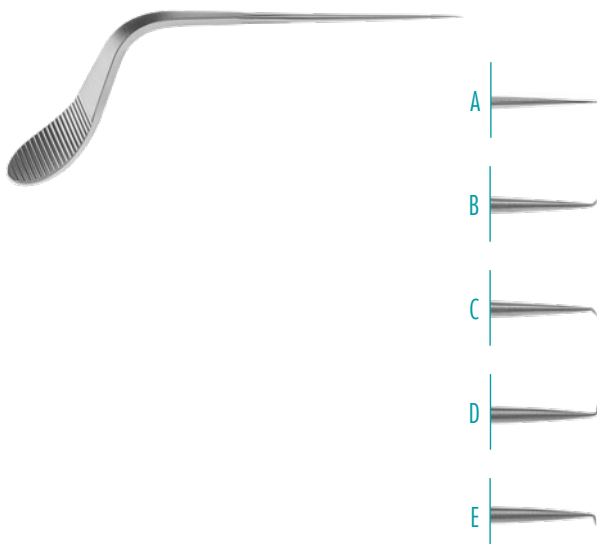
160mm, 6^{1/4}" 410-216-007**ZOELLNER**

Needle, 0.5mm tip

A straight 410-165-001

B 45° curved up 410-165-002

C 45° curved down 410-165-003

D 90° curved up 410-165-004

E 90° curved down 410-165-005

1.0 mm tip

B 45° curved up 410-165-006

C 45° curved down 410-165-007

D 90° curved up 410-165-008

E 90° curved down 410-165-009

WULLSTEIN

Micro Hook,
160mm, 6¹/₄"



25° angled

0.3mm	410-115-003
0.6mm	410-115-006
1.0mm	410-115-010

45° angled

0.2mm	410-117-002
0.3mm	410-117-003
0.4mm	410-117-004
0.6mm	410-117-006
0.8mm	410-117-008
1.0mm	410-117-010
1.2mm	410-117-012
1.5mm	410-117-015
2.0mm	410-117-020
2.5mm	410-117-025

90° angled

0.2mm	410-210-002
0.3mm	410-210-003
0.4mm	410-210-004
0.6mm	410-210-006
0.8mm	410-210-008
1.0mm	410-210-010
1.2mm	410-210-012
1.5mm	410-210-015
2.0mm	410-210-020
2.5mm	410-210-025

WULLSTEIN-COLOR

Micro Hook,
160mm, 6¹/₄"



90°

1.0mm, 5 orange rings	410-117-161
0.2mm, 1 orange ring	410-117-162
0.4mm, 2 orange rings	410-117-164
0.6mm, 3 orange rings	410-117-166
0.8mm, 4 orange rings	410-117-168

45°

1.0mm, 5 cyan rings	410-115-161
0.2mm, 1 cyan ring	410-115-162
0.4mm, 2 cyan rings	410-115-164
0.6mm, 3 cyan rings	410-115-166
0.8mm, 4 cyan rings	410-115-168

BARBARA

Needles and Hooks

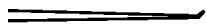
160mm 6¹/₄"

25° angled upwards

0.3mm	410-210-303
0.6mm	410-210-306
1.0mm	410-210-310

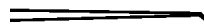

25° angled downwards

0.3mm	410-210-203
0.6mm	410-210-206
1.0mm	410-210-210



45° angled upwards

0.3mm	410-217-003
0.6mm	410-217-006
1.0mm	410-217-010

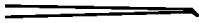

45° angled downwards

0.3mm	410-217-103
0.6mm	410-217-106
1.0mm	410-217-110



90° angled upwards

0.3mm	410-216-003
0.6mm	410-216-005
1.0mm	410-216-010



90° angled downwards

0.3mm	410-116-103
0.6mm	410-116-105
1.0mm	410-116-110



Knee bent, straight

410-113-155

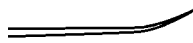

Knee bent, curved

410-115-153



retrograde angled upwards

0.5mm	410-116-205
1.0mm	410-116-210

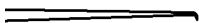

retrograde angled downwards

0.5mm	410-116-305
1.0mm	410-116-310

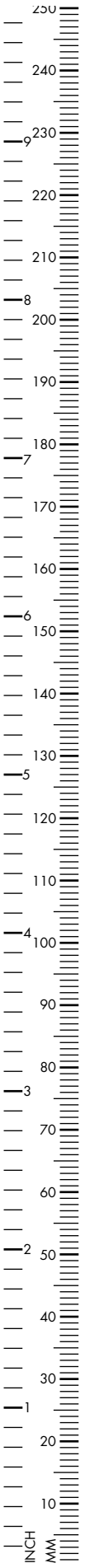

AUSTIN

Attic Dissector, 90° angled, blunt,
3mm

165mm, 6¹/₂" 410-157-090

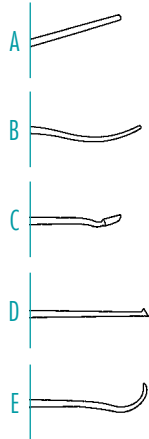

AUSTIN

165mm, 6¹/₂"

- | | |
|--------------------|-------------|
| A Elevator, 1.0mm | 410-157-001 |
| B Raspatory, 1.0mm | 410-157-002 |
| B Raspatory, 1.2mm | 410-157-003 |
| C Spoon | 410-157-004 |
| D Hook, 0.6mm | 410-157-005 |
| E Raspatory, 1.8mm | 410-157-006 |



FISCH

Excavator, narrow, 160mm, 6¹/₄"

- | | |
|----------------------|-------------|
| double curved, left | 410-135-060 |
| double curved, right | 410-135-061 |
| single curved, left | 410-135-062 |
| single curved, right | 410-135-063 |



FISCH

Dissector, 160mm, 6¹/₄"

- | | |
|---------------------|-------------|
| single curved right | 410-017-001 |
| single curved, left | 410-017-002 |



THOMASSIN

Dissector, double ended, double curved

180mm, 7" 410-162-180

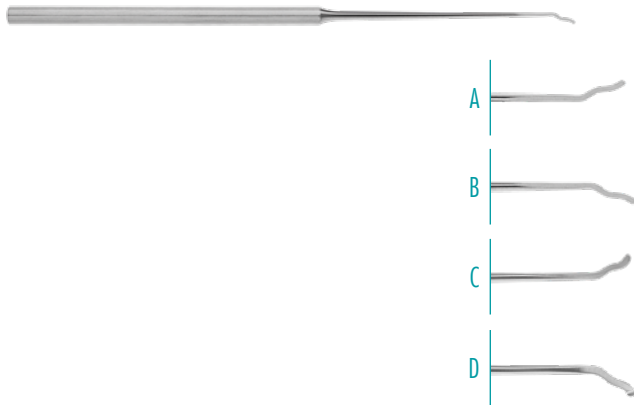

WHIRLY-BIRD

Knife, 15mm, 6",
0.75 x 5.0mm

A right curved	410-110-150
B left curved	410-110-151
1.0 x 5.0mm	
C right curved	410-110-152
D left curved	410-110-153

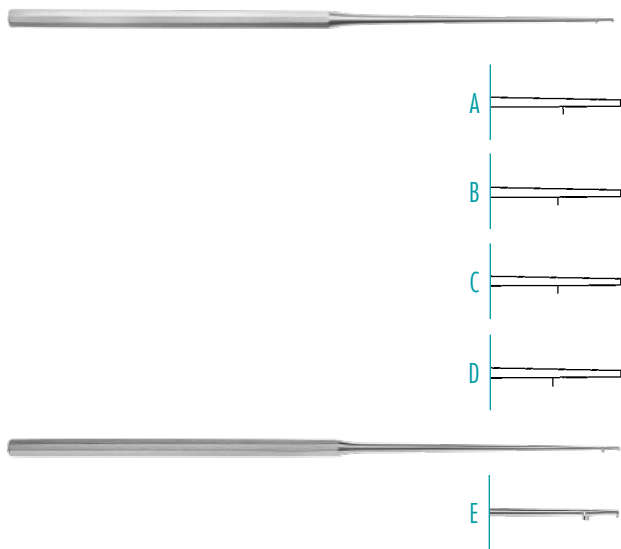

AUSTIN

Measuring Probe, 160mm, 6¹/₄"

A Mark 3.5mm	410-142-135
B Mark 4.5mm	410-142-140
C Mark 4.5mm	410-142-145
D Mark 5.0mm	410-142-150
E with 3 lengths	
Mark	410-142-166
3.5 / 4.0 / 4.5mm	



FISCH

Caliper, 165mm, 6¹/₂"

0.4mm	410-137-004
0.6mm	410-137-006
0.8mm	410-137-008



FISCH

Perforator, 165mm, 6¹/₂"

0.3mm	410-137-013
0.4mm	410-137-014
0.5mm	410-137-015
0.6mm	410-137-016
0.7mm	410-137-017
0.8mm	410-137-018

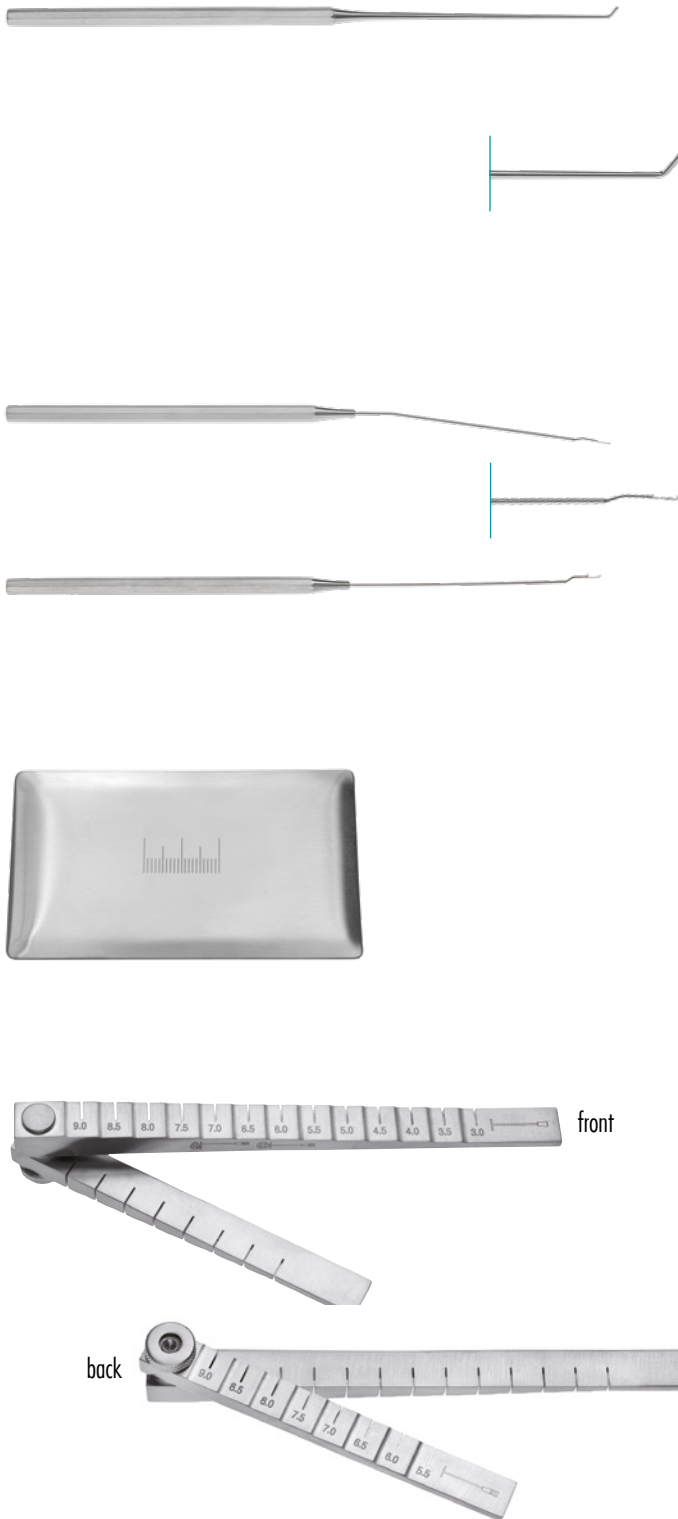
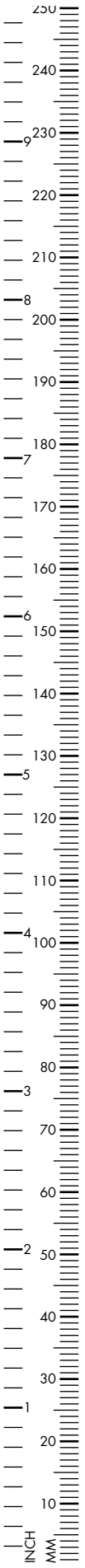

HOUSE

Reference Instrument, octagonal handle, 160mm, 6¹/₄"

2.5mm	410-138-250
2.7mm	410-138-275
3.0mm	410-138-300
3.2mm	410-138-325
3.5mm	410-138-350
3.7mm	410-138-375
4.0mm	410-138-400
4.2mm	410-138-425
4.5mm	410-138-450
4.7mm	410-138-475
5.0mm	410-138-500

FISCH

Reference instrument, 3.5/ 4.0/ 4.5mm, 160mm, 6¹/₄"

curved	410-142-161
straight	410-142-160

Preparation tray with mm scale, stainless steel

92 x 54mm	410-143-000
-----------	-------------

Universal Titanium Prosthesis Sizer, measuring from 2.5 until 9.0mm

410-155-800

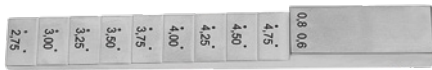

Piston Cutting Jig for Teflon Prosthesis

410-144-000



Measuring and cutting block for PTFE stapes prostheses, 0.4mm and 0.6mm

410-155-000



Tube Insertion Instrument

100mm, 4"
working length

410-223-010



Micro measuring probe for stapedectomy and tympanoplasty, 180mm, 7"

0-7mm

410-142-180

0-8mm, detachable

410-141-180

**HEERMANN**

Handle for holding special chisels and gouges
410-144-017 - 410-144-030

410-144-100

**HEERMANN**

Gouge

0.7mm 410-144-007

1.0mm 410-144-010

1.5mm 410-144-015

1.7mm 410-144-017

3.0mm 410-144-030

**HEERMANN**

Gouge

0.7mm 410-144-107

1.0mm 410-144-110

1.5mm 410-144-115

3.0mm 410-144-130

**HEERMANN**

Mallet, hollow handle, narrow head

195mm, 7³/₄" 410-144-200

**SCHUKNECHT**

Bending Device for Stapes Prosthesis

410-145-000

**SHEA**

Vein Press

16mm	410-153-016
30mm	410-153-030

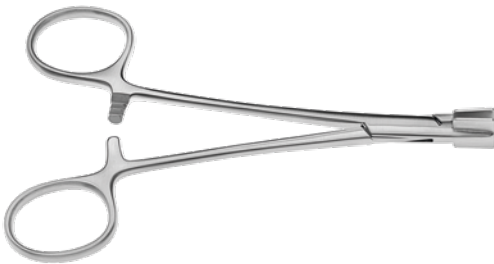

Vein Graft, press forceps, smooth square jaws
130mm, 5^{1/8}"

12x15mm	410-154-130
---------	-------------

160mm, 6 ^{1/4} "	
---------------------------	--

11x14mm	410-154-160
---------	-------------

180mm, 7"	
-----------	--

11x14mm	410-154-180
---------	-------------

22x30mm	410-156-180
---------	-------------

30x30mm	410-155-180
---------	-------------

**WÜRZBURG**

Rock leg holder, completely detachable

410-905-000



Micro Container with lid and bottom perforation, with textile «Longterm» filter

200 x 140 x 45mm	600-402-140
280 x 195 x 45mm	600-402-195
265 x 255 x 45mm	600-402-255
380 x 260 x 50mm	600-402-260

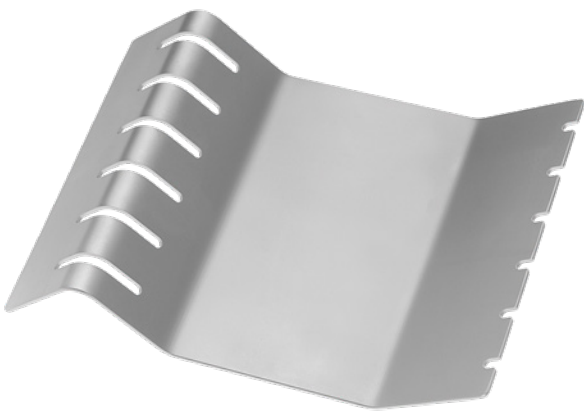

Instrument Rack for 6 ear forceps

600-150-005

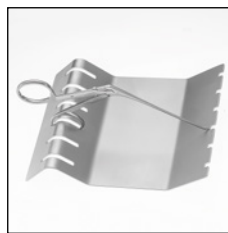

RHINOLOGY



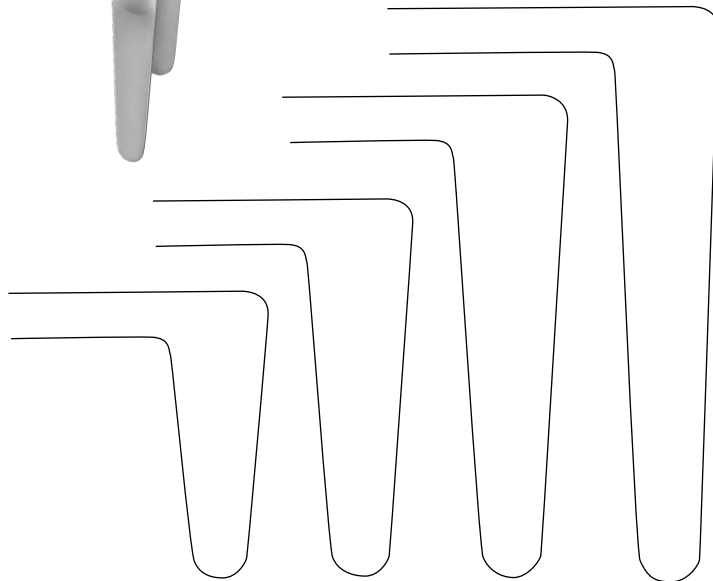
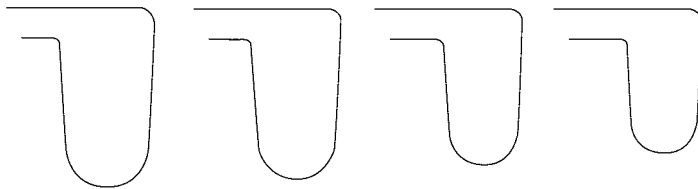
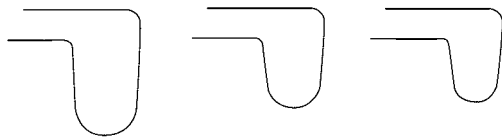
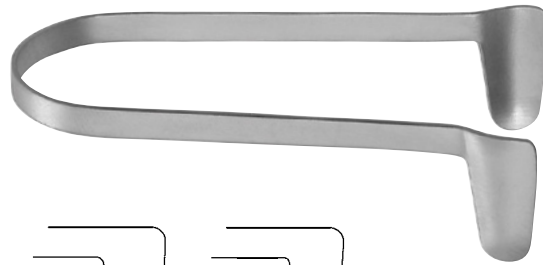
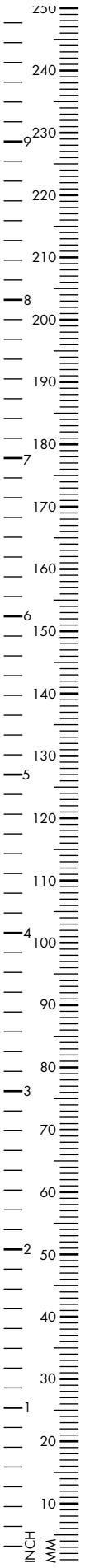

THUDICHUM (MARK HOVELL)

Nasal Specula, 70mm, 2 1/2"

8.5 x 6.0mm	420-050-001
9.0 x 7.0mm	420-050-002
12.5 x 8.0mm	420-050-003
15.0 x 8.5mm	420-050-004
18.0 x 10.0mm	420-050-006
19.5 x 10.5mm	420-050-007

insulated

8.5 x 6.0mm	420-050-101
9.0 x 7.0mm	420-050-102
12.5 x 8.0mm	420-050-103
15.0 x 8.5mm	420-050-104
18.0 x 10.0mm	420-050-106
19.5 x 10.5mm	420-050-107

ST. CLAIR THOMPSON

Nasal Specula, 73mm, 2 1/2"

38mm	420-052-001
50mm	420-052-002
65mm	420-052-003
75mm	420-052-004

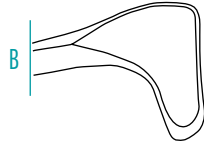
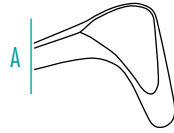
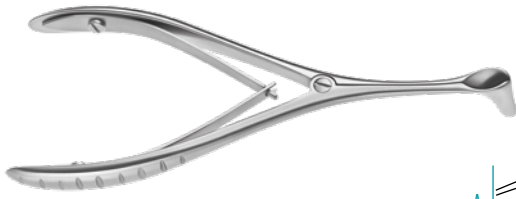

TIECK-HALLE

Nasal Specula, 135mm, 5¹/₃"

A Infants, 17.5mm 420-140-135

B Children, 21.0mm 420-142-135



BECKMANN

Nasal Specula, Infants, curved sidewards,
17.5mm

130mm, 5¹/₈" 420-147-140

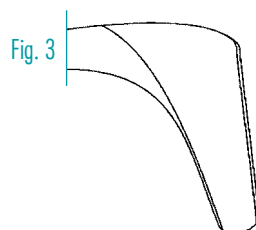
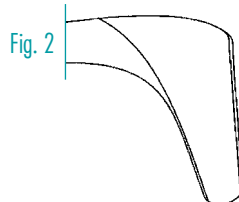

BECKMANN

Nasal Specula, 150mm, 6"

Fig. 1 22mm 420-148-150

Fig. 2 25mm 420-146-152

Fig. 3 28mm 420-146-153

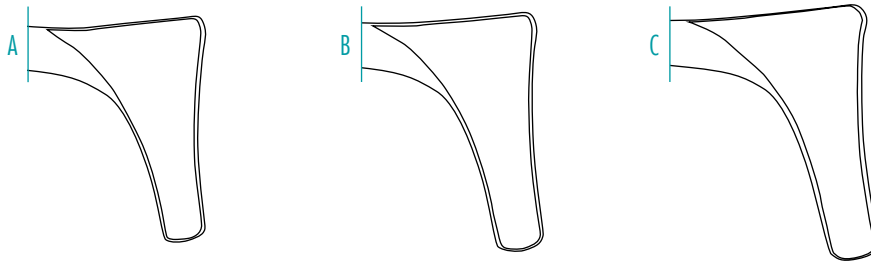
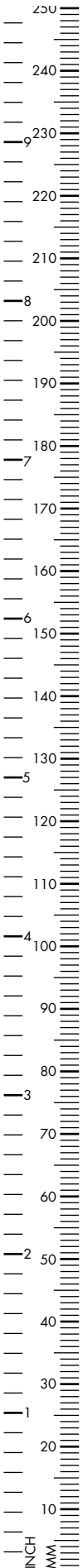

HARTMANN

Nasal Specula, 160mm, 6¹/₄"

A Fig. 1	420-119-001
29 x 7mm	
B Fig. 2	420-119-002
33 x 7mm	
C Fig. 3	420-119-003
35 x 7mm	

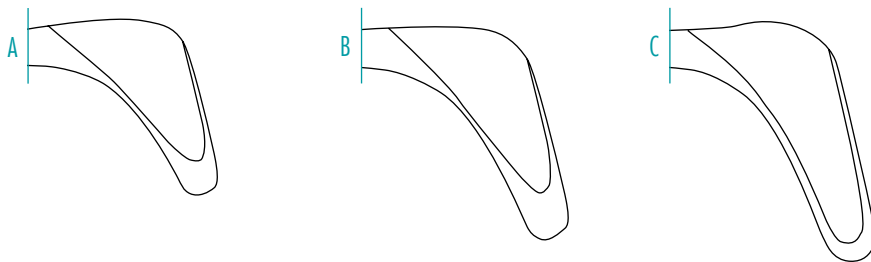

HARTMANN-HALLE

Nasal Specula, 155mm, 6¹/₈"

A Fig. 1, 27mm	420-121-150
B Fig. 2, 31mm	420-122-150
C Fig. 3, 37mm	420-123-150

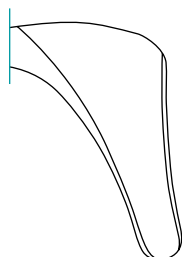

HARTMANN-HALLE

Nasal Speculum, tapered blade, aseptic joint, 155mm, 6¹/₈"

Fig. 2, 33mm	420-124-033
--------------	-------------

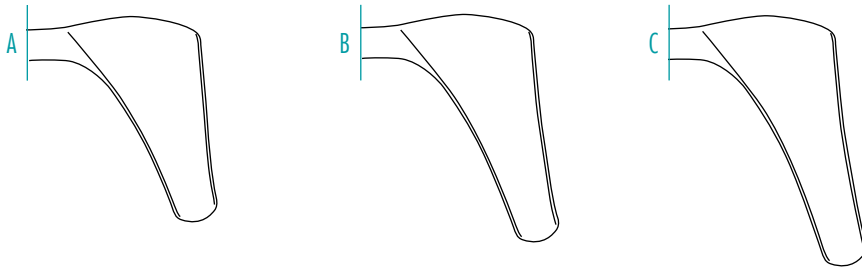

MOD. VIENNA

Nasal Specula, 130mm, 5¹/₈"

A Fig. 1	420-100-001
28 x 7mm	
B Fig. 2	420-100-002
30 x 7mm	
C Fig. 3	420-100-003
32 x 7mm	

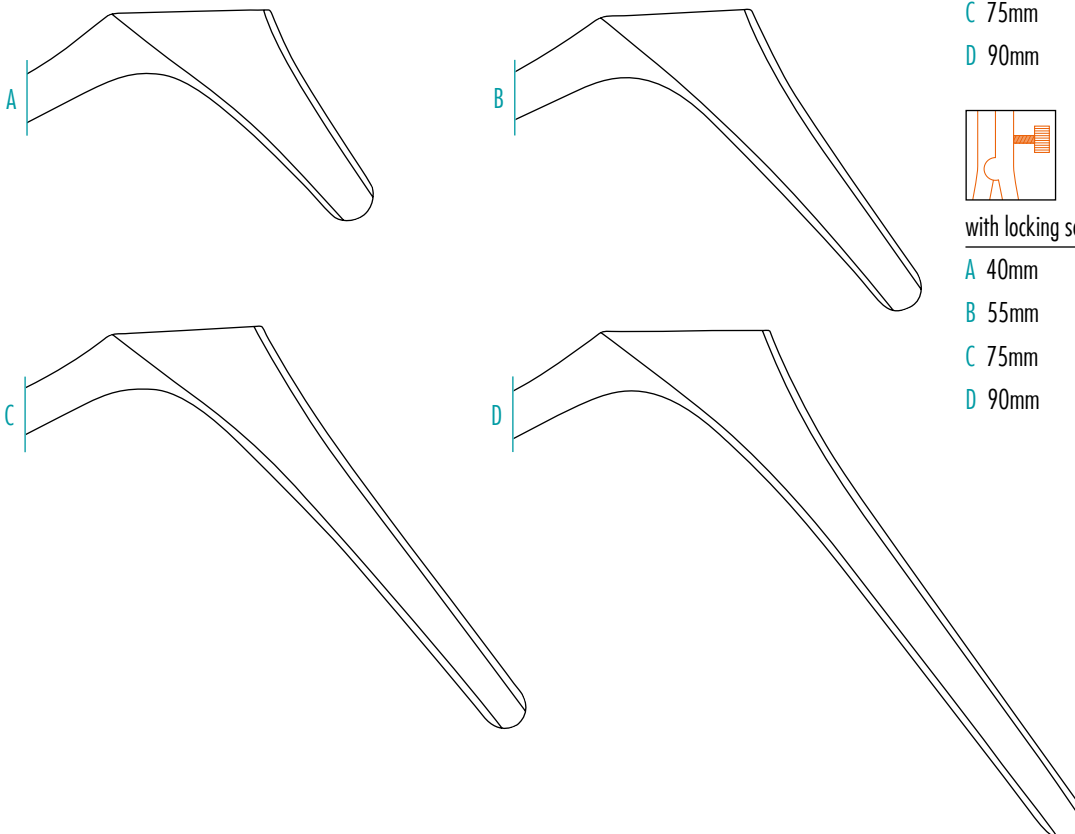

KILLIAN-STRUYCKEN

Nasal Speculum, aseptic joint, 140mm, 5¹/₂"

A 40mm	420-147-040
B 55mm	420-147-055
C 75mm	420-147-075
D 90mm	420-147-090



with locking screw

A 40mm	420-146-040
B 55mm	420-146-055
C 75mm	420-146-075
D 90mm	420-146-090

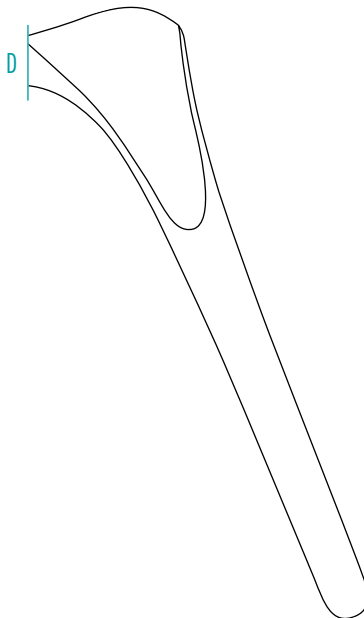
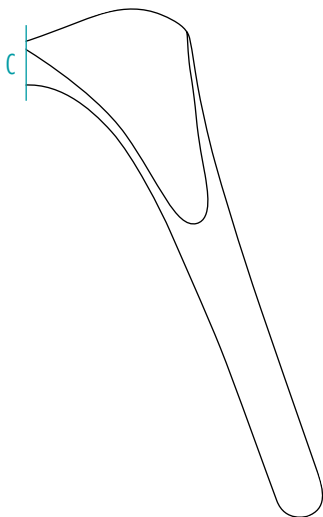
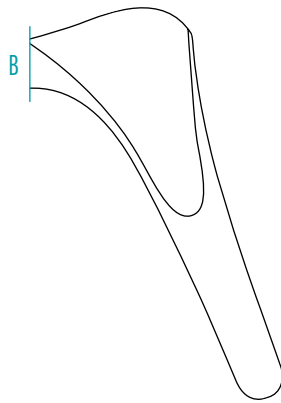
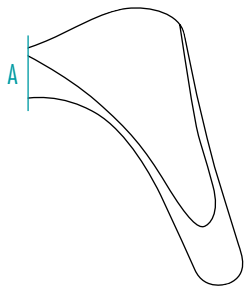

KILLIAN

Nasal Speculum, aseptic joint, 140mm, 5 1/2"

A 40mm	420-143-040
B 55mm	420-143-055
C 75mm	420-143-075
D 90mm	420-143-090

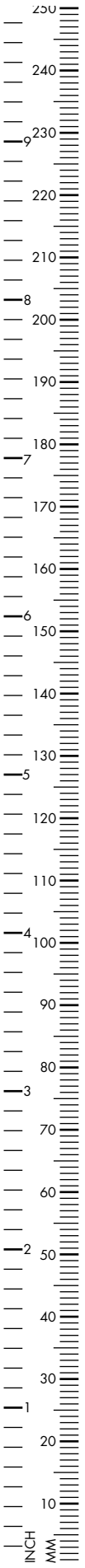

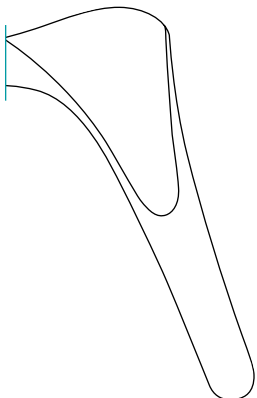
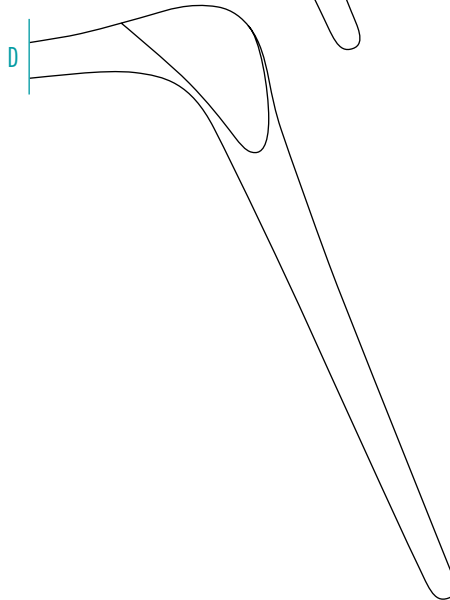
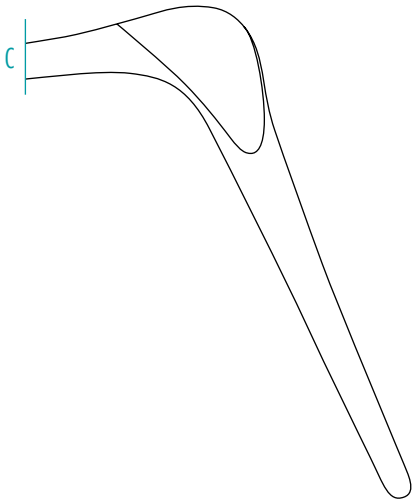
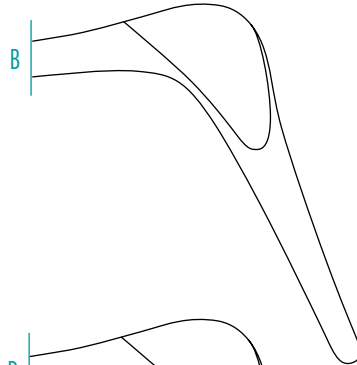
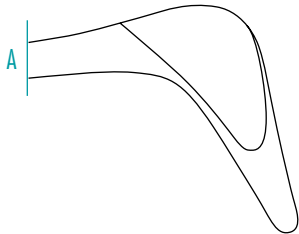

COTTLE

Nasal Speculum, aseptic joint, 130mm, 5¹/₈"

A	35mm	420-132-035
B	50mm	420-132-055
C	75mm	420-132-075
D	90mm	420-132-090



KILLIAN-WALTER

Nasal Speculum, thin blades, aseptic joint, 140mm, 5¹/₂"

	55mm	420-138-055
--	------	-------------

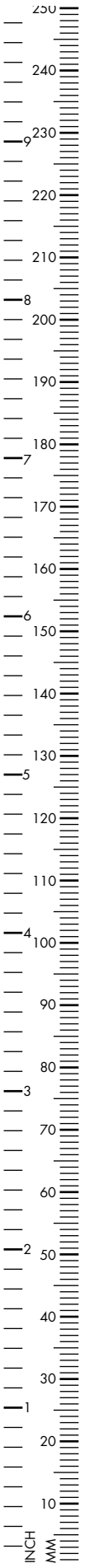

COTTLE

Nasal Speculum, aseptic joint, 130mm, 5¹/₈"

A	35mm	420-135-035
B	55mm	420-135-055
C	65mm	420-135-065
D	75mm	420-135-075
E	90mm	420-135-090

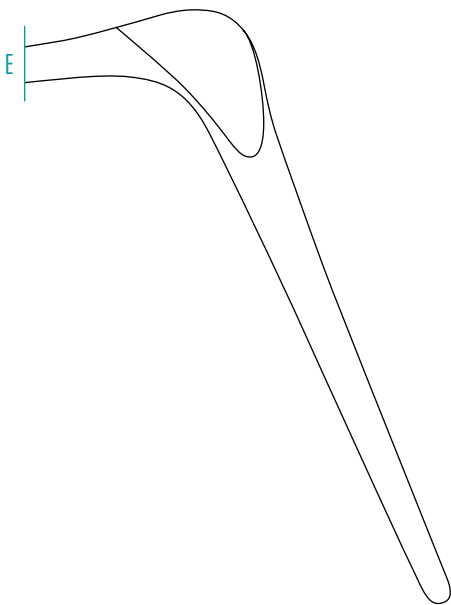
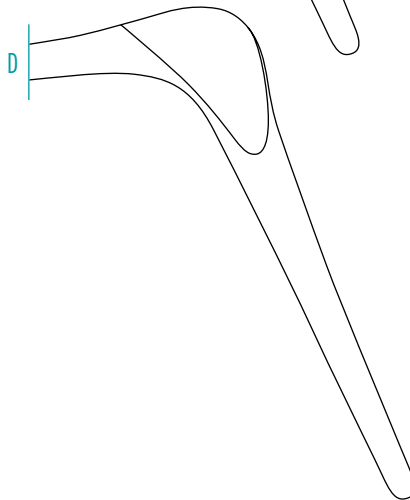
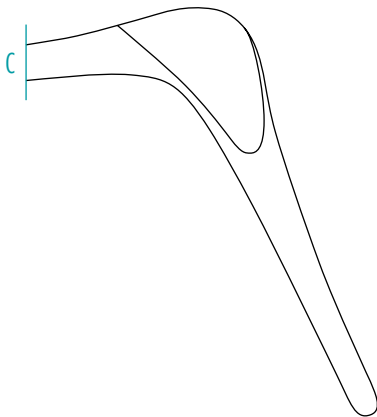
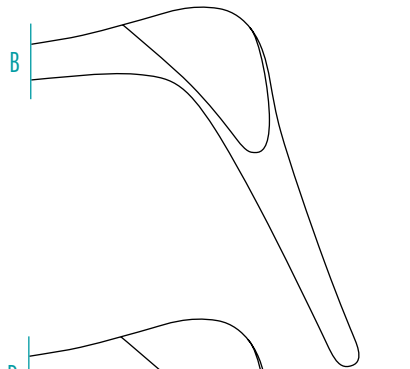
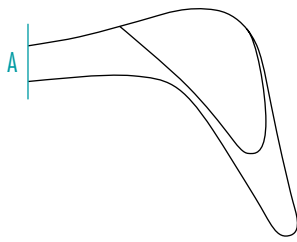

**COTTLE**

Nasal Speculum, aseptic joint,
with detachable cold light carrier,
140mm, 5^{1/2}"

A	40mm	420-743-040
B	55mm	420-743-055
C	75mm	420-743-075
D	90mm	420-743-090

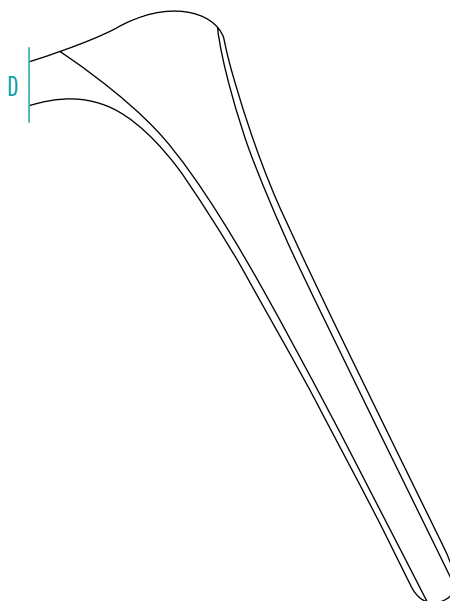
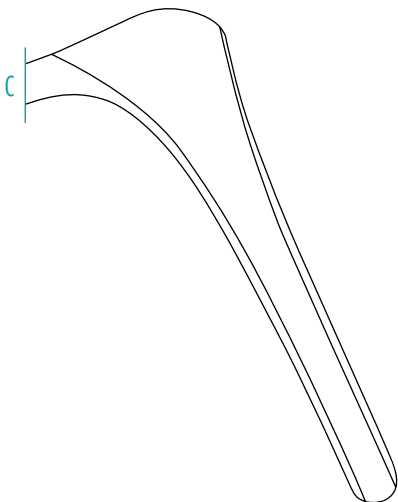
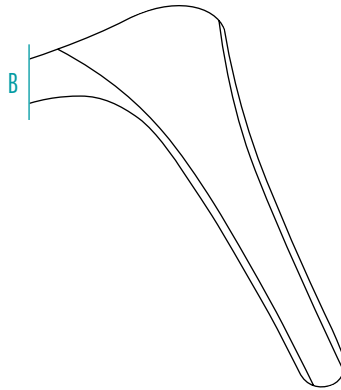
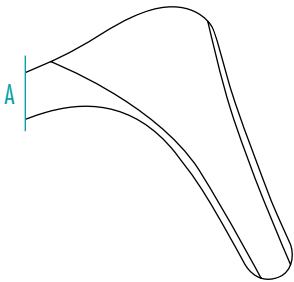

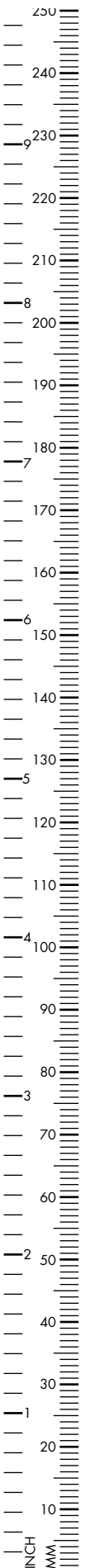

A



B



C



D



E

Flexible Arm, complete with holding rod,
without rotating clamp

A 251-010-000

Rotating clamp for flexible tension arm
attachable to operating table

B 251-010-100

Nasal Specula Clamp for flexible arm

C 251-010-400

AUFRICHT

Nasal Specula for flexible arm

D 251-010-500

AUFRICHT

Nasal Hook, 2 prongs, for flexible arm

E 251-010-600

**COTTLE MASING**

Nasal Specula for flexible arm

35mm	420-140-035
50mm	420-140-050
75mm	420-140-075
90mm	420-140-090
100mm	420-140-100

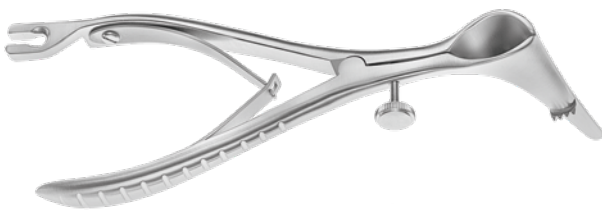
Sinus Specula for flexible arm,
with teeth

left: 55mm right: 35mm	420-150-001
left: 35mm right: 55mm	420-150-002
left: 65mm right: 45mm	420-150-003
left: 45mm right: 65mm	420-150-004
left: 75mm right: 35mm	420-150-005
left: 35mm right: 75mm	420-150-006
left: 75mm right: 40mm	420-150-007
left: 40mm right: 75mm	420-150-008

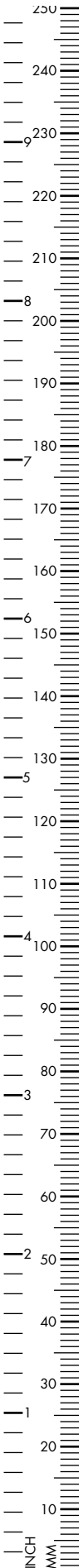

KILLIAN

Nasal Probe, slightly curved, Ø 1.5mm

165mm, 6¹/₂" 420-150-165



Nasal Probe, knee angled, Ø 1.4mm

160mm, 6¹/₄" 420-150-160



FARRELL

Applicator, triangulated serrated end, Ø 1.2mm

165mm, 6¹/₂" 160-426-165



Nasal Applicator, triangulated serrated end, Ø 1.1mm

160mm, 6¹/₄" 160-426-160



FARRELL (LATHBURY-UEBE)

Cotton Applicator, threaded, Ø 1.2mm

165mm, 6¹/₂" 160-420-165



Cotton Applicator, rough spiral end,
180mm, 7"

Ø 1.5mm 160-412-180

Ø 1.8mm 160-411-180



SIEBENMANN

Nasal Plugger

180mm, 7" 420-150-180



JANSEN

Nasal Dressing Forceps, bayonet shaped,
serrated jaws

160mm, 6^{1/4}" 410-395-160



GRUENWALD

Nasal Dressing Forceps, bayonet shaped,
serrated jaws

200mm, 8" 410-389-190



TROELTSCH (WILDE)

Nasal Dressing Forceps, knee bent

170mm, 6^{2/3}" 420-375-165

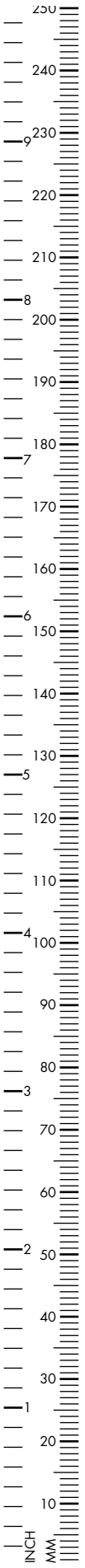

Suction Tube, 165mm, 6¹/₂"

Ø 3.0mm	410-165-030
Ø 3.5mm	410-165-035
Ø 4.5mm	410-165-045

Suction Tube, 195mm, 7²/₃"

Ø 4.5mm	410-195-045
---------	-------------



Nasal Suction Tube, Ø5mm, Ø6.5mm tip

180mm, 7"	165-064-160
-----------	-------------

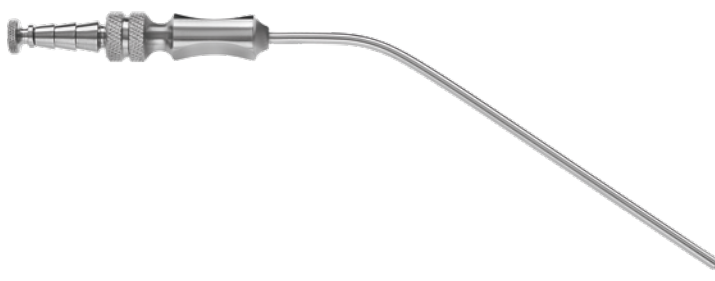

FRAZIER

Suction Tube, 190mm, 7¹/₂"

Ø 1.6mm, 5 Charr.	165-523-005
Ø 2.0mm, 6 Charr.	165-523-006
Ø 2.3mm, 7 Charr.	165-523-007
Ø 2.5mm, 8 Charr.	165-523-008
Ø 3.0mm, 9 Charr.	165-523-009
Ø 3.3mm, 10 Charr.	165-523-010
Ø 3.6mm, 11 Charr.	165-523-011
Ø 4.0mm, 12 Charr.	165-523-012
Ø 5.0mm, 15 Charr.	165-523-015

**HARTMANN**

Nasal Dressing Forceps

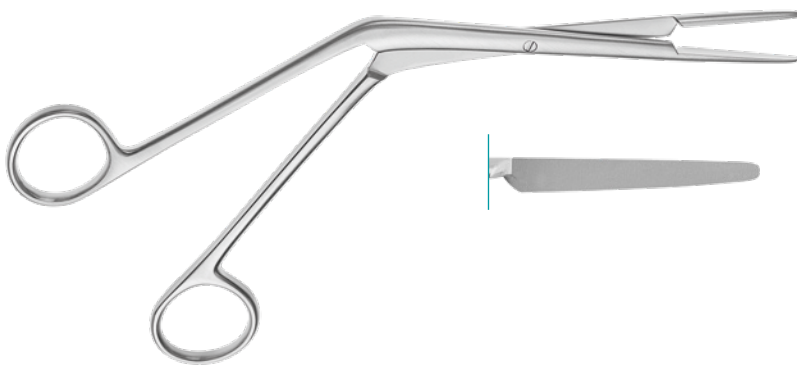
215mm, 8^{1/2}" 420-211-200175mm, 6^{7/8}" 420-211-160**LUBET-BARBON**

Polypus Forceps, smooth jaws

200mm, 8" 420-210-200

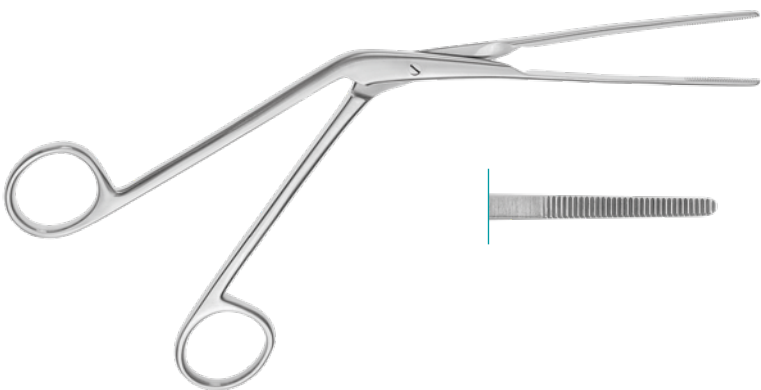
**WEST**

Nasal Dressing Forceps

200mm, 8" 420-411-200

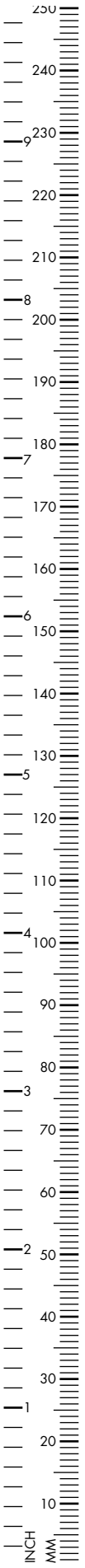

YANKAUER
Nasal Dressing Forceps

420-210-175



TILLEY
Nasal Dressing Forceps, serrated

130mm, 6¹/₄" 410-232-140

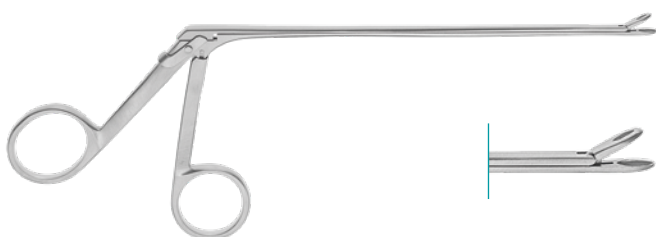

STRUEMPEL
Forceps, 2.5mm spoon

130mm, 6¹/₄" 410-338-234

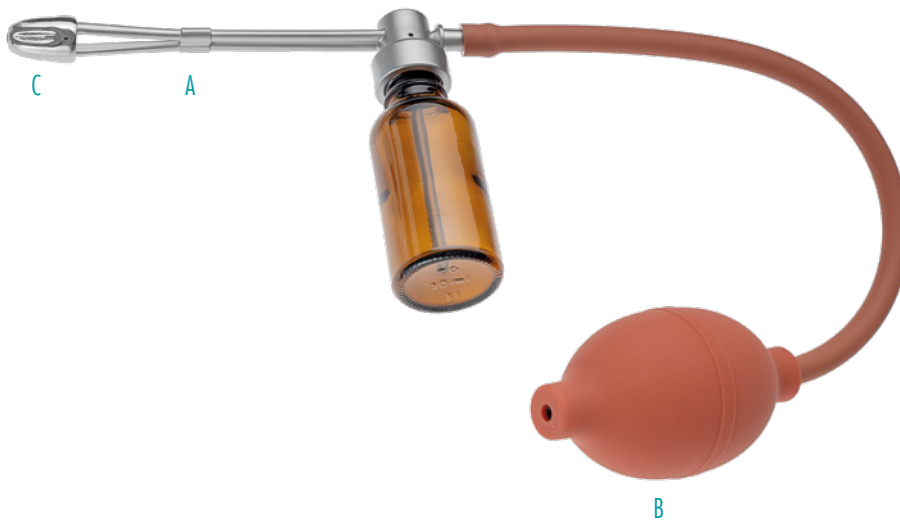

Universal Atomizer, complete set

410-228-000

A Liquid Atomizer only

410-228-050

B Rubber Bulb only

410-228-100

C Nose Guard only

410-228-010



GLATZEL

Nasal Mirror, 200 x 130mm

200 x 130mm

420-001-000

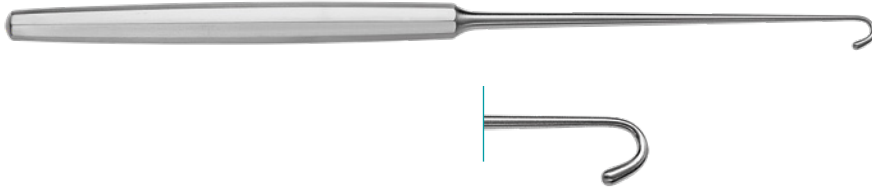
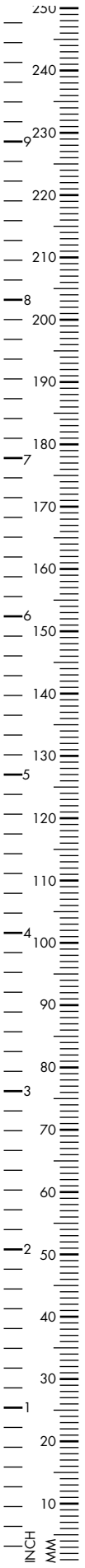

LANGE

Choana hook

230mm, 9"

420-413-230

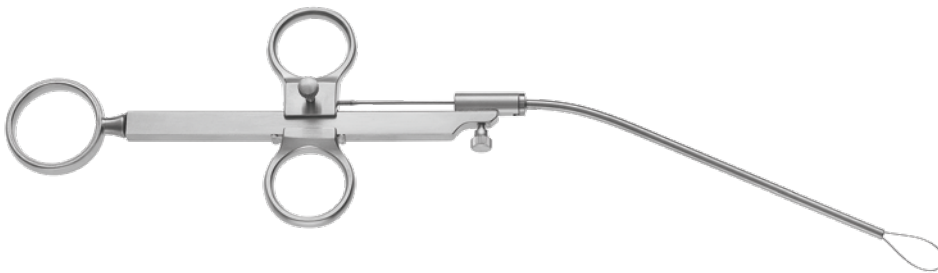

KRAUSE

Nasal Polypus Snare, knee bent

250mm, 9⁷/₈"

420-201-260

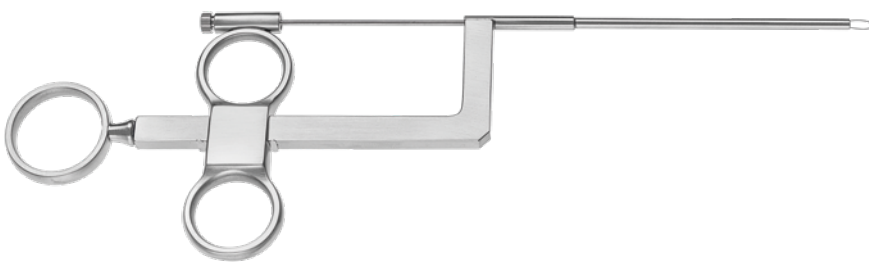

WILDE

Nasal Polypus Snare, bayonet shaped

250mm, 9⁷/₈"

410-270-250



Wire loops for nasal polyp snares,
package of 100pcs.

Ø 3.0mm 420-210-003



Snare Wire in coils, Ø 3.0mm,
1 coil of 10 meters

420-210-013

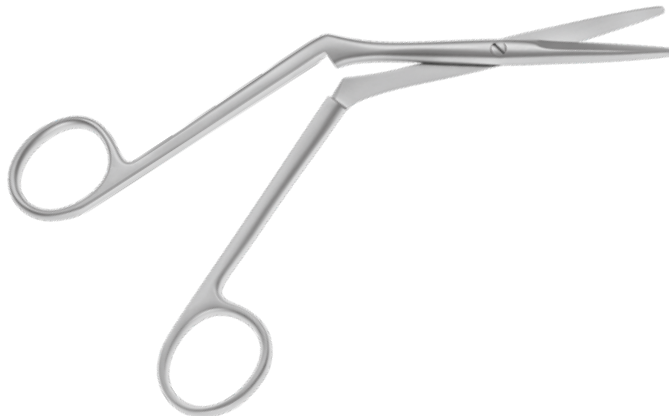

HEYMAN KNIGHT

Nasal Scissors, knee bent

180mm, 7" 120-283-180

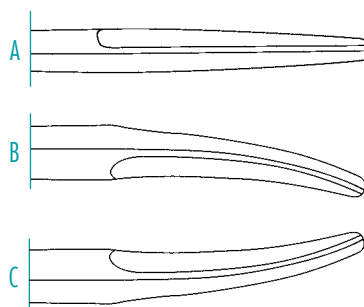
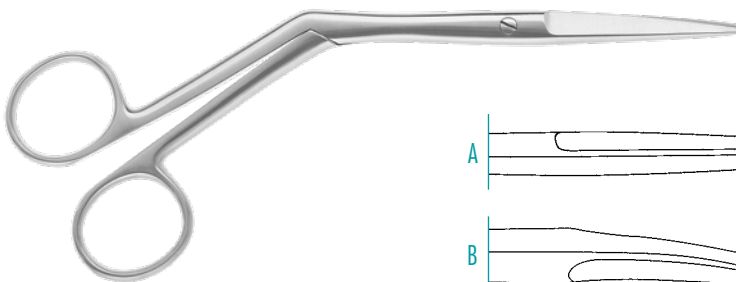

HEYMANN

Nasal Scissors, serrated upper blade,
190mm, 7^{1/2}"

A straight 120-284-180

B right curved 120-287-180

C left curved 120-285-180

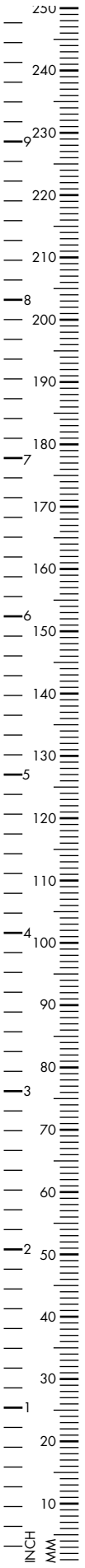

HEYMANN

TC Nasal Scissors, straight, serrated

195mm, 7³/₄"

120-585-180



KIRSTEIN

Nasal Scissors, serrated

180mm, 7"

120-285-175



OLIVECRONA

Nasal Scissors, serrated

230mm, 9"

120-208-230

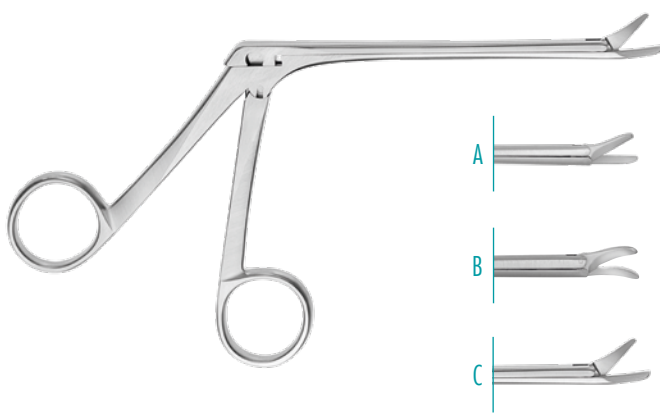

Nasal Scissors, serrated upper blade,
120mm, 4³/₄"

A straight 420-414-120

B right curved 420-415-120

C left curved 420-416-120

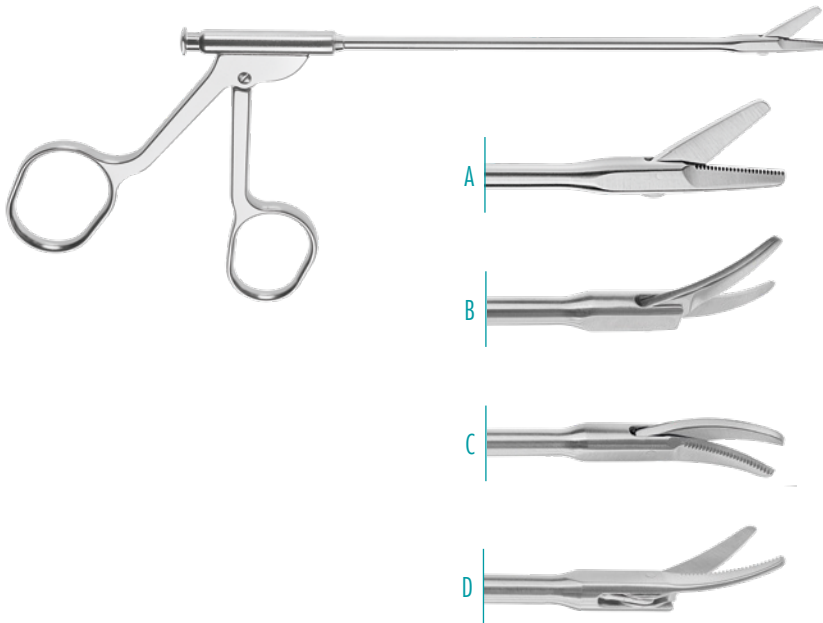

Nasal Scissors, Ø 3.5mm
130mm, 5¹/₈"

A straight	252-023-130
B left curved	252-024-130
C right curved	252-025-130
D curved up	252-026-130

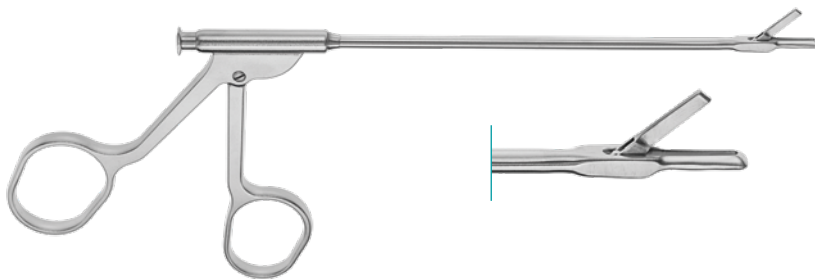

STRUYCKEN
Ethmoidal Forceps

130mm, 5 ¹ / ₈ "	252-003-130
--	-------------

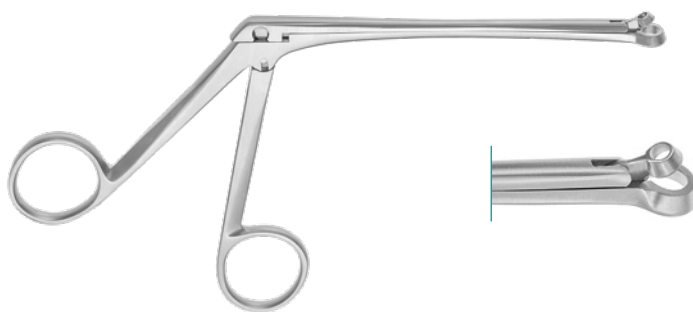

HARTMANN
Nasal Cutting Forceps, through-cutting,
120mm, 4³/₄"

5mm	420-407-005
7mm	420-407-007
9mm	420-407-009
11mm	420-407-011

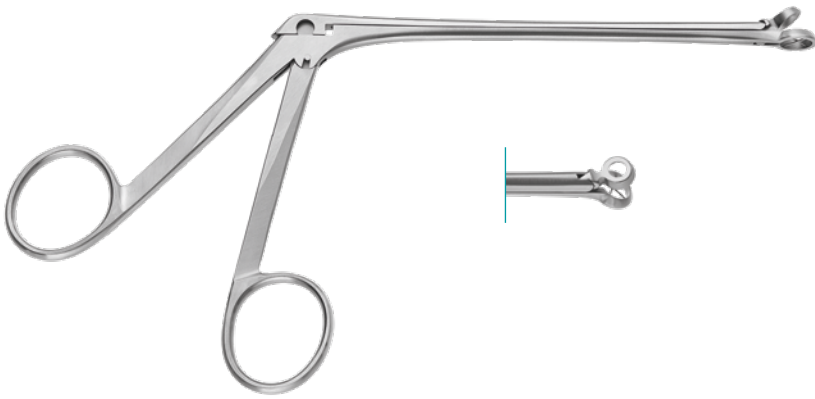
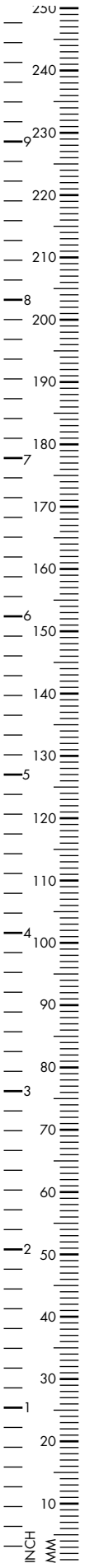

MELZER

Adenoid Punch, through cutting,
round, with basket, 140mm, 5¹/₂"

Fig. 1, 7mm	420-401-001
Fig. 2, 8mm	420-401-002



GRUENWALD-HENKE

Nasal Cutting Forceps, through-cutting,
120mm, 4³/₄"

Fig. 1, 3.5 x 11mm	420-405-120
Fig. 2, 2.0 x 9.5mm	420-406-120

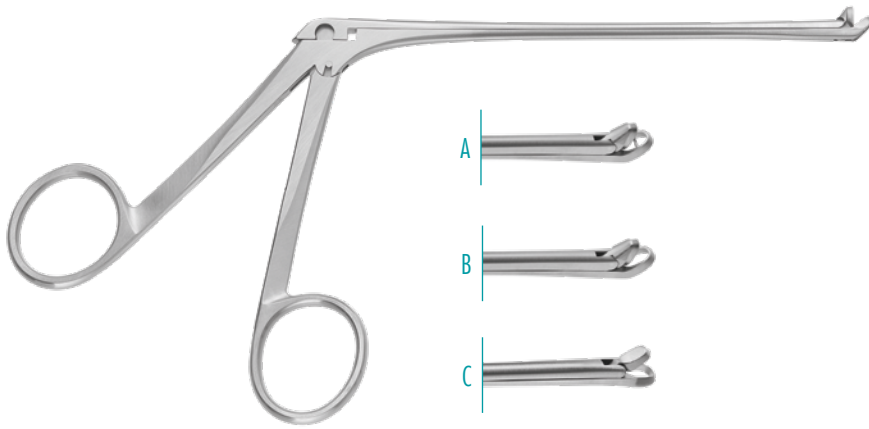

WATSON-WILLIAMS

Nasal Forceps, through-cutting, upcurved,
3mm bite, 140mm, 5½"

A	420-418-140
B	420-419-140
C	420-420-140

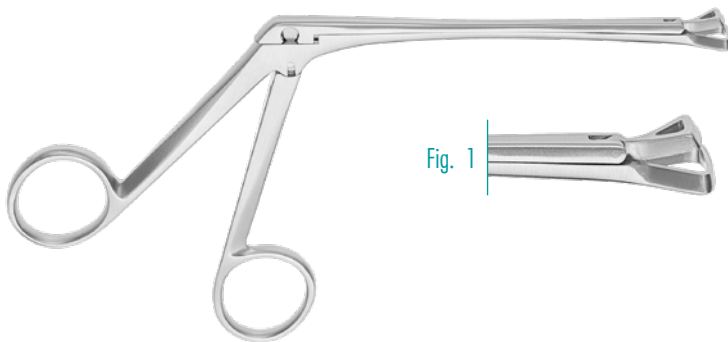

SCHMEDEN

Nasal Cutting Forceps, through-cutting,
120mm working length, 190mm, 7½"

Fig. 1	420-401-190
Fig. 2	420-402-190

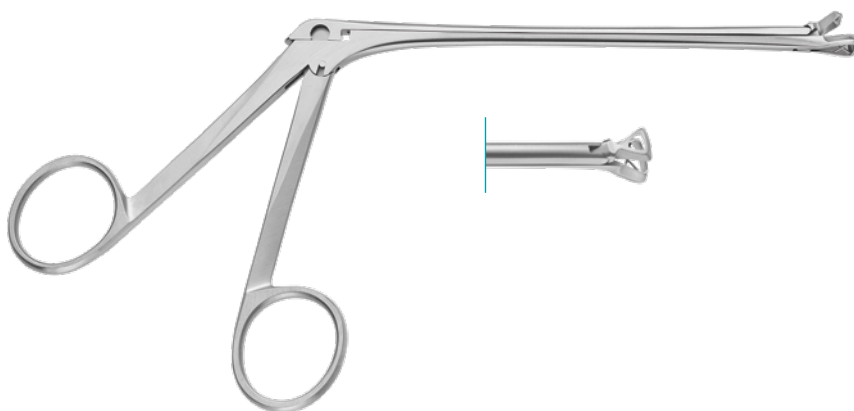

MELZER

Adenoid Forceps, through-cutting, triangular,
140mm, 5½"

Fig. 0, 6mm	420-401-100
Fig. 1, 7mm	420-401-101
Fig. 2, 8mm	420-401-102
Fig. 3, 10mm	420-401-103

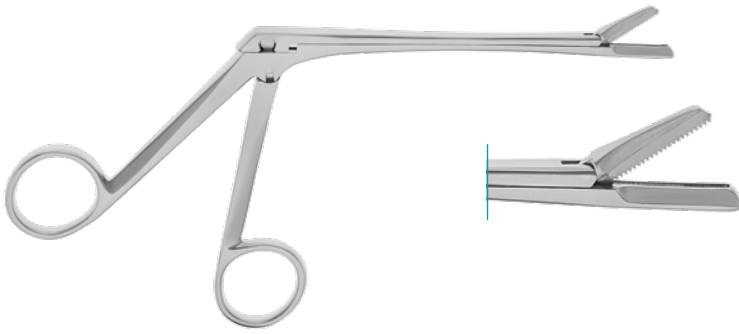
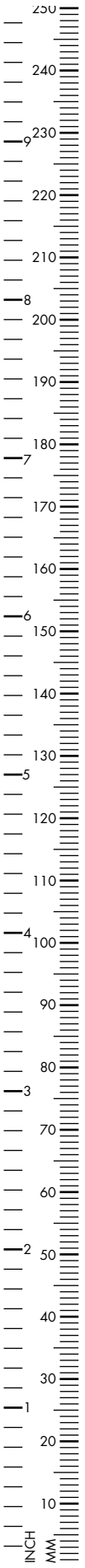

STRUYCKEN

Nasal Cutting Forceps, through-cutting

120mm, 4^{3/4}"

420-409-120

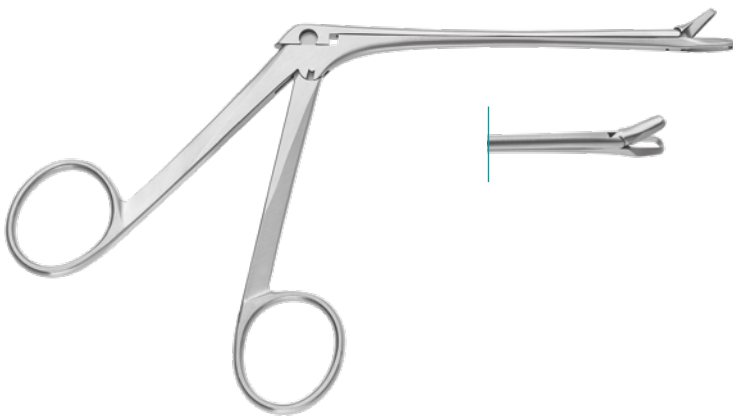

GRUENWALD

Nasal Forceps, oval bite, 115mm, 4^{1/2}"

Fig. 1, 3.0mm

420-421-001

Fig. 2, 3.5mm

420-421-002

Fig. 3, 4.0mm

420-421-003

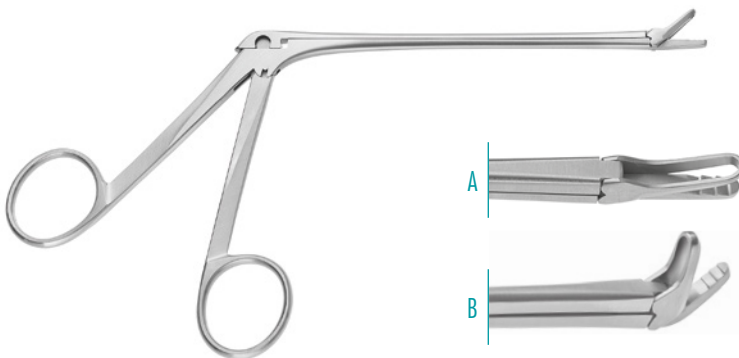

MYLES

Nasal Cutting Forceps, through-cutting,
130mm, 5^{1/8}"

A straight, flat

420-410-140

B 30° upcurved

420-413-140

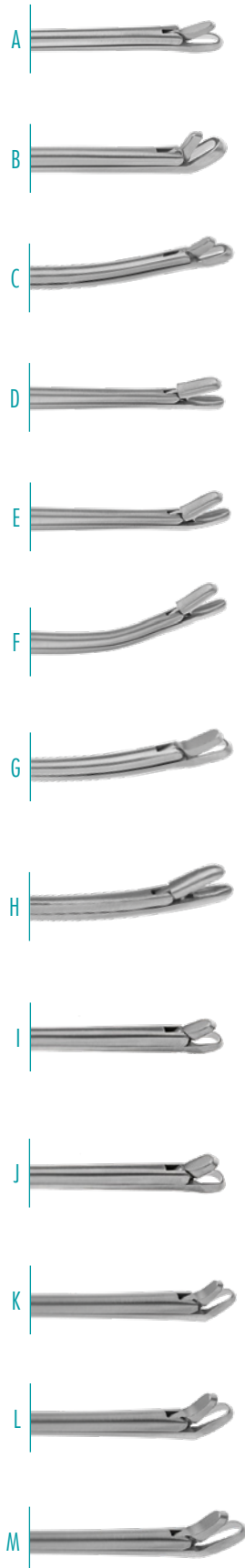
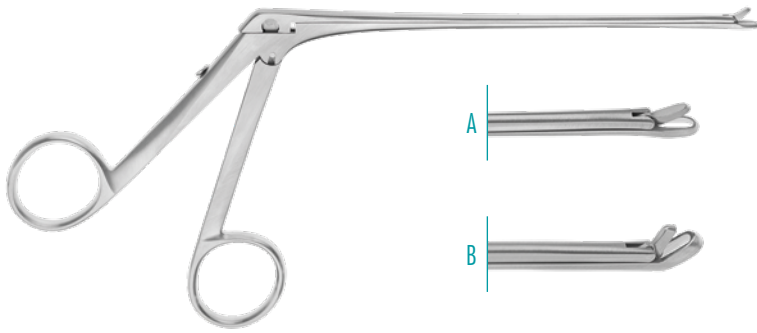
**MORIYAMA**Conchotom, through-cutting, 140mm, 5¹/₂"

A	Size 1, straight, delicate	252-200-001
B	Size 2, upcutting, delicate	252-200-002
C	Size 3, shaft upcurved, delicate	252-200-003
D	Size 4, straight, oval cups, delicate	252-200-004
E	Size 5, upwards, oval cups, delicate	252-200-005
F	Size 6, shaft upcurved, oval cups, delicate	252-200-006
G	Size 8, sheath upcurved	252-200-008
H	Size 9, shaft upwards, oval cups	252-200-009
I	Size 10, straight, small size, 115mm, 4 ¹ / ₂ "	252-200-010
J	Size 11, straight, large size, 115mm, 4 ¹ / ₂ "	252-200-011
K	Size 12, upwards, small size, 115mm, 4 ¹ / ₂ "	252-200-012
L	Size 13, upwards, medium size, 115mm, 4 ¹ / ₂ "	252-200-013
M	Size 14, upwards, large size, 115mm, 4 ¹ / ₂ "	252-200-014

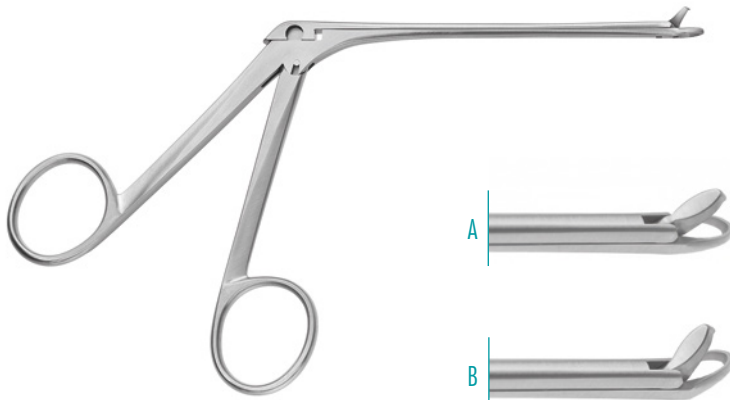
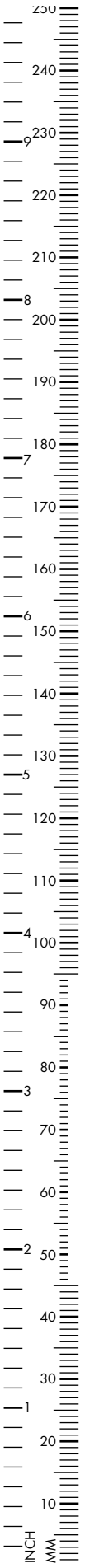

smooth

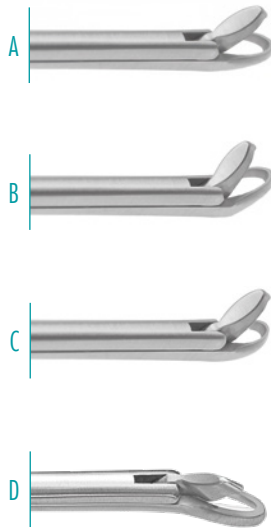

BLAKESLEY

Nasal Forceps, through cutting, smooth, 115mm, 4¹/₂"

A straight

2.0mm bite	252-200-110
2.5mm bite	252-200-111
3.0mm bite	252-200-112
3.5mm bite	252-200-113
4.0mm bite	252-200-114
5.0mm bite	252-200-115

B upcurved

2.0mm bite	252-201-110
2.5mm bite	252-201-111
3.0mm bite	252-201-112
3.5mm bite	252-201-113
4.0mm bite	252-201-114
5.0mm bite	252-200-115

C left curved

2.5mm bite	252-202-111
------------	-------------

D right curved

2.5mm bite	252-203-111
------------	-------------

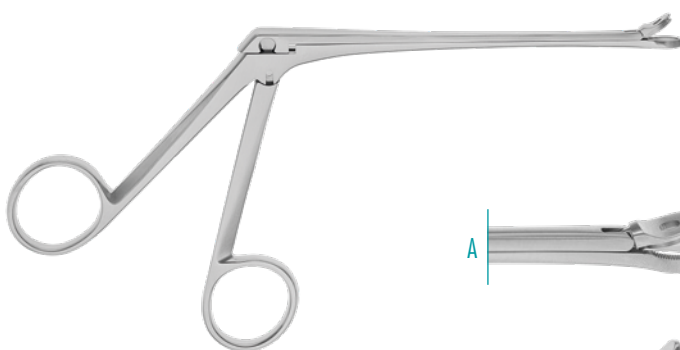

serrated

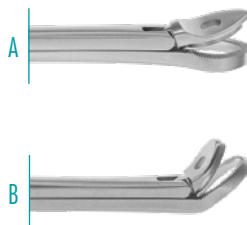

BLAKESLEY

Nasal Forceps, through cutting, serrated, 115mm, 4¹/₂"

A straight

2.0mm bite	252-204-110
2.5mm bite	252-204-111
3.0mm bite	252-204-112
3.5mm bite	252-204-113
4.0mm bite	252-204-114

B upcurved

2.0mm bite	252-205-110
2.5mm bite	252-205-111
3.0mm bite	252-205-112
3.5mm bite	252-205-113
4.0mm bite	252-205-114

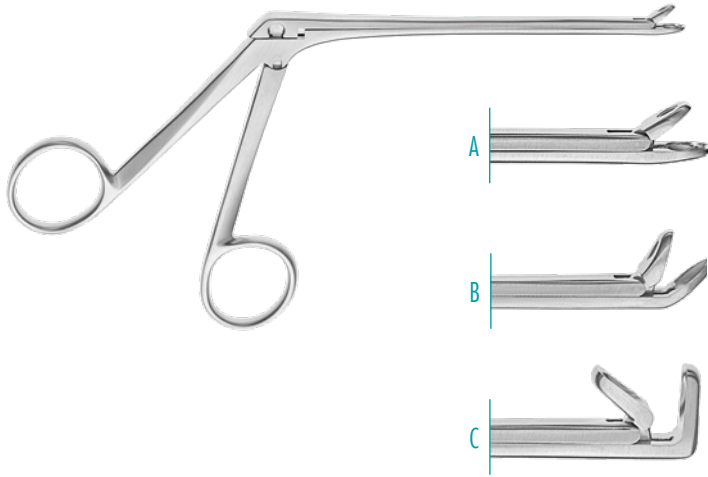

WEIL-BLAKESLEY

Ethmoidal Forceps, oval cup, fenestrated jaws, 120mm, 4"

A straight

Fig. 0, 3.0mm	252-000-120
Fig.1, 3.6mm	252-001-120
Fig.2, 4.2mm	252-002-120
Fig.3, 4.8mm	252-003-120
Fig.4, 5.6mm	252-004-120

B upwards curved

Fig. 0, 3.0mm	252-000-121
Fig.1, 3.6mm	252-001-121
Fig.2, 4.2mm	252-002-121
Fig.3, 4.8mm	252-003-121
Fig.4, 5.6mm	252-004-121

C 90° upwards curved

Fig. 0, 3.0mm	252-000-122
Fig.1, 3.6mm	252-001-122
Fig.2, 4.2mm	252-002-122
Fig.3, 4.8mm	252-003-122
Fig.4, 5.6mm	252-004-122

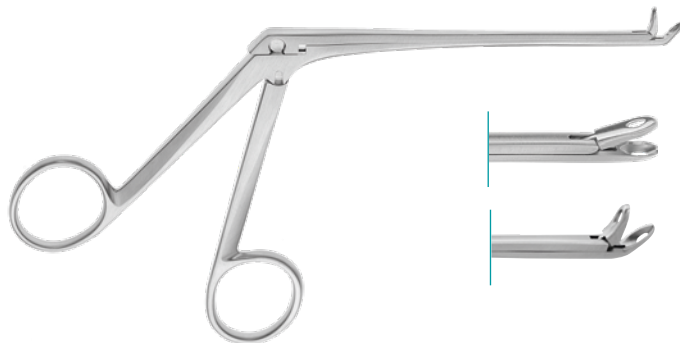

STRUEMPEL-VOSS

Ethmoidal Forceps, Ø2.5mm, 110mm, 4 1/3"

straight	252-144-121
upcurved jaws	252-000-111

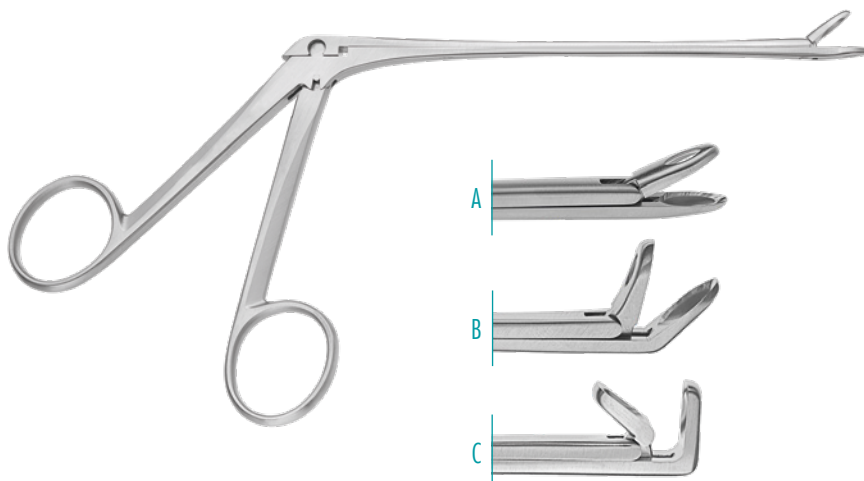

BLAKESLEY

Nasal Forceps, 150mm, 6"

A straight / 0°

Size 1, 3.5mm	252-035-150
Size 2, 4.0mm	252-040-150
Size 3, 5.0mm	252-050-150

B 45° upcurved

Size 1, 3.5mm	252-035-151
Size 2, 4.0mm	252-040-151

C 90° upcurved

Size 1, 3.5mm	252-035-152
Size 2, 4.0mm	252-040-152

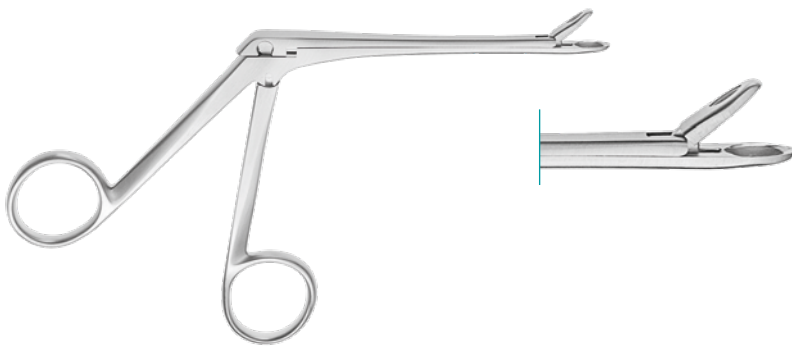
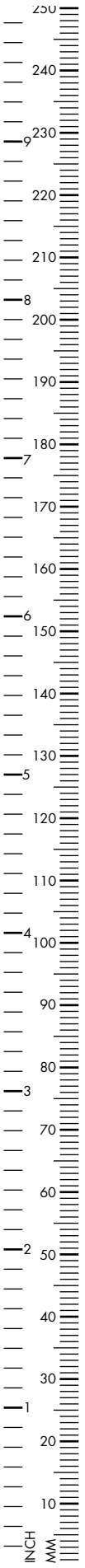

TILLEY HENCKEL

Ethmoid Punch, straight, 100mm, 4¹/₃"

Ø 4.5mm	252-022-045
Ø 5.5mm	252-022-055
Ø 6.5mm	252-022-065

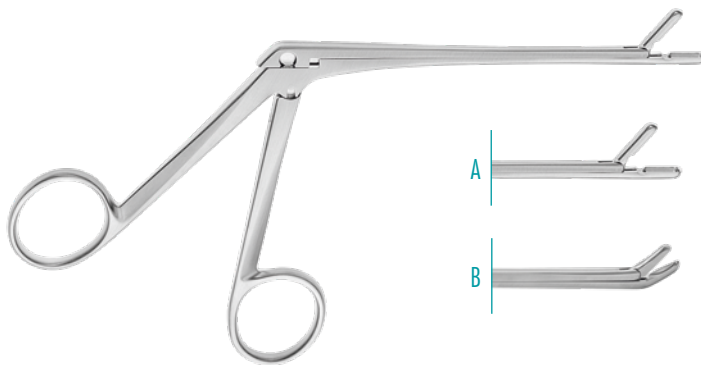

TAKAHASHI

Ethmoidal Forceps, oval, cup-shaped, 110mm, 4¹/₃"

A straight

2.5mm	252-410-130
3.0mm	252-410-131
4.0mm	252-410-132

150mm, 6"

3.0mm	252-410-151
-------	-------------

B upcurved, 110mm, 4¹/₃"

3.0mm	252-413-131
-------	-------------

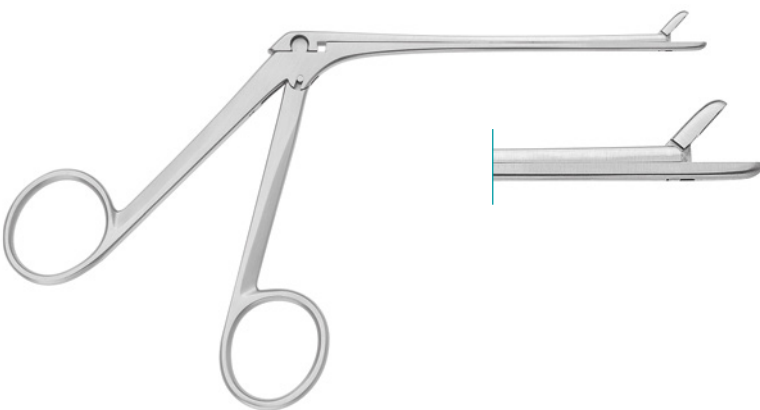

ST BARTS

Rongeur, 3mm, 110mm, 4¹/₃"

straight	252-536-115
curved up	252-537-115
curved down	252-538-115

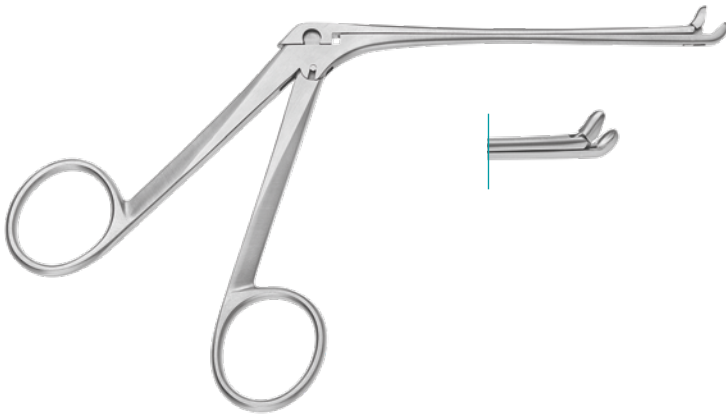
**BEAD**

Nasal Forceps, cup jaws, upturned

115mm, 4¹/₂"

252-425-115

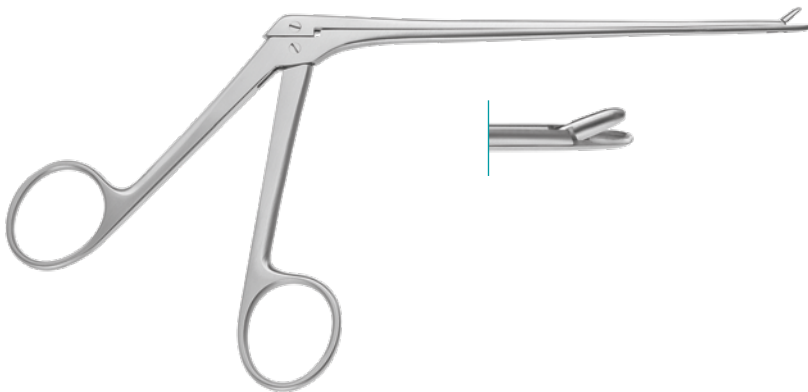

Ethmoidal Forceps, straight

140mm, 5¹/₂"

252-534-100

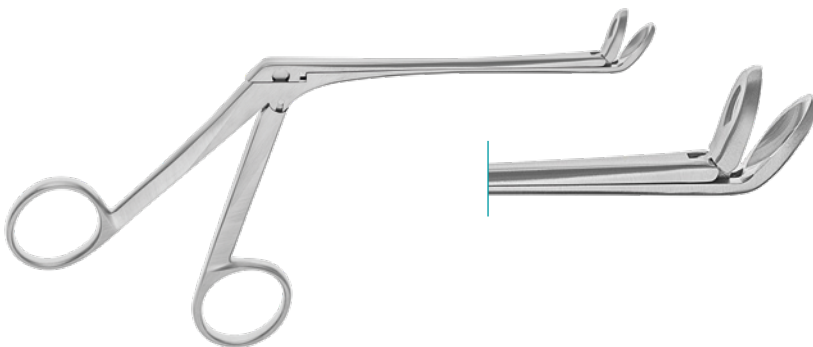
**BLAKESLEY**Conchotom with spoon, 6x14mm,
60° bent up115mm, 4¹/₂"

252-551-204

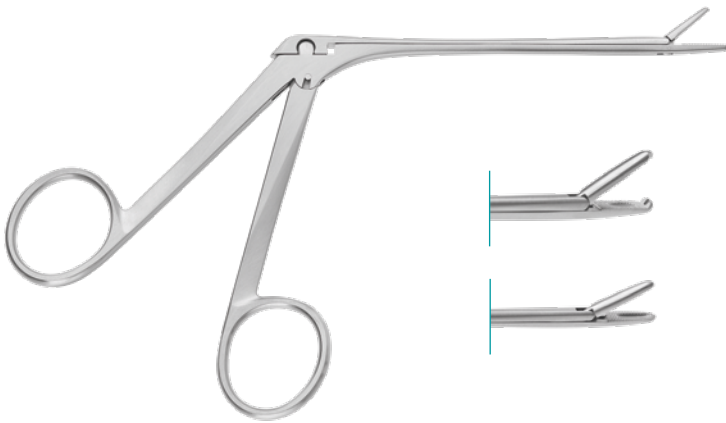
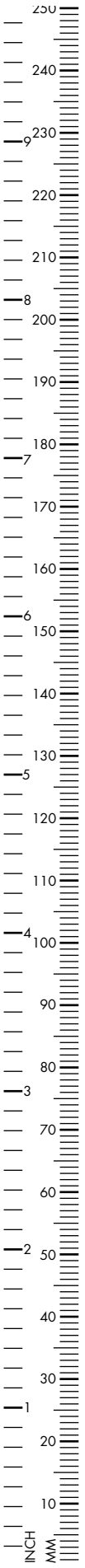

NOYES

Nasal Forceps, serrated jaws

serrated, 1x2 teeth	252-526-115
serrated	252-527-115

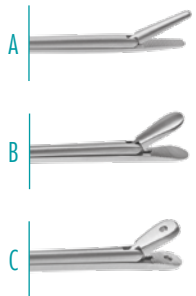
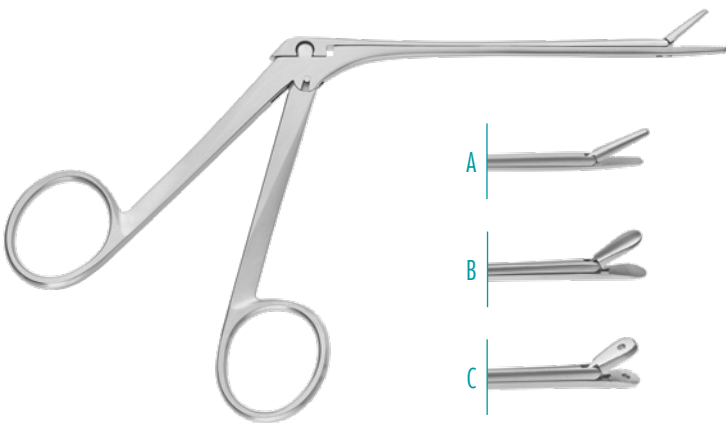

Nasal Forceps, serrated jaws

A MORGENSTEIN	252-528-115
B BLAKESLEY	252-529-115
C FERRIS-SMITH	252-530-115

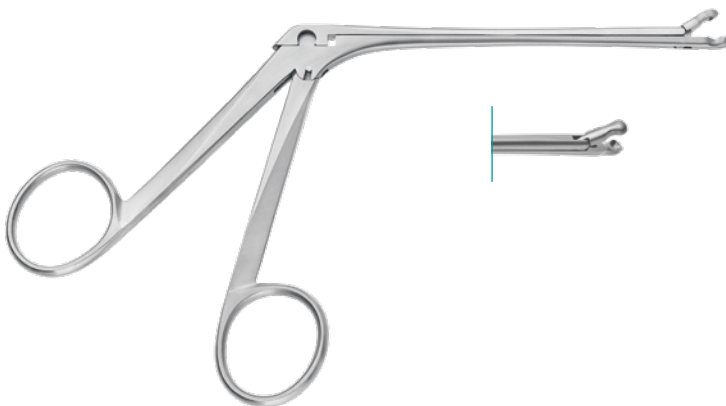

Sinus Cup Forceps, round cups, Ø 3.5mm

115mm, 4 1/2"	252-426-100
---------------	-------------

Zliders - slide to clean

The cleaning of complex surgical instruments requires different processes, compared to conventional reusable instruments. For the most difficult-to-clean instruments cleaning is done manually which makes it time and cost consuming.

The new solution to avoid complex and manual processes is the "one part detachable" instrument.



PRESS

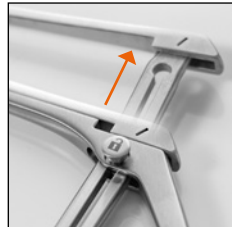

SLIDE



OPEN

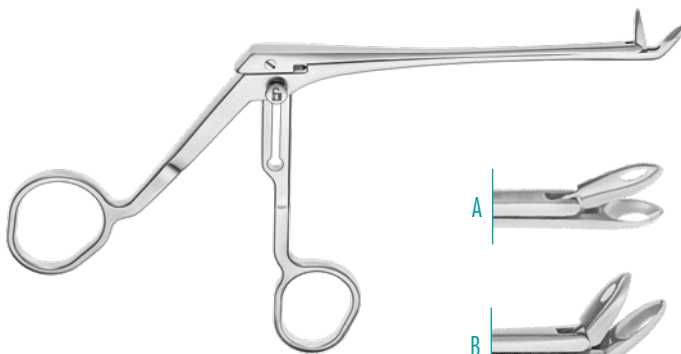

BLAKESLEY

Nasal Forceps, 120mm working length,

A straight

2.5mm	252-725-120
3.0mm	252-730-120
3.5mm	252-735-120
4.0mm	252-740-120
4.5mm	252-745-120

B 45° upwards

3.0mm	252-730-121
3.5mm	252-735-121
4.0mm	252-740-121

C 90° upwards

2.5mm	252-725-122
3.0mm	252-730-122
3.5mm	252-735-122
4.0mm	252-740-122

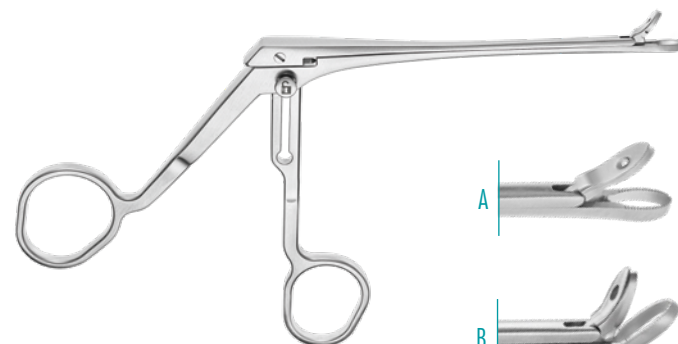

BLAKESLEY

Punch, 120mm working length,

A straight

1.9 x 4.0mm	252-720-120
2.5 x 6.0mm	252-726-120
3.0 x 7.0mm	252-731-120

B 45° upwards

1.9 x 4.0mm	252-721-120
2.5 x 6.0mm	252-727-120
3.0 x 7.0mm	252-732-120

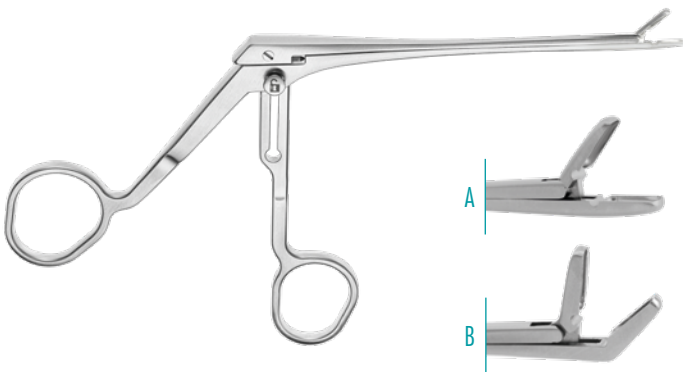
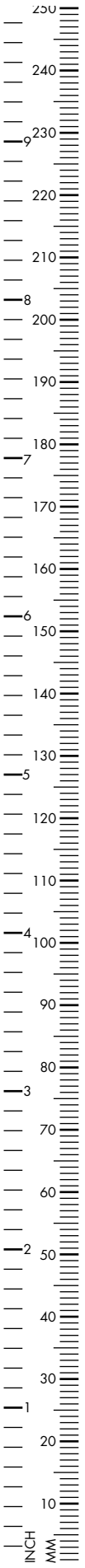

TAKAHASHI

Nasal Forceps, 125mm working length,

A straight

2.0 x 10.0mm	252-741-120
2.5 x 10.0mm	252-742-120
3.0 x 10.0mm	252-743-120
4.0 x 10.0mm	252-744-120

B 45° upwards, 120mm working length

2.0mm	252-741-121
2.5mm	252-742-121
3.0mm	252-743-121
4.0mm	252-744-121

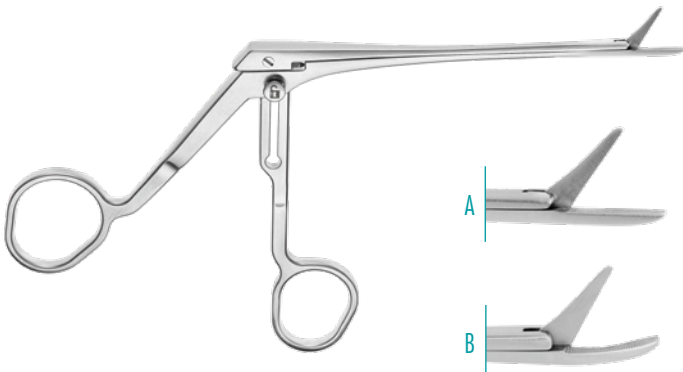

Nasal Scissors, 120mm working length,

A straight

4.0 x 3.0mm x 10.0mm	252-722-120
----------------------	-------------

B right

4.0 x 3.0mm x 10.0mm	252-723-120
----------------------	-------------

C left

4.0 x 3.0mm x 10.0mm	252-724-120
----------------------	-------------

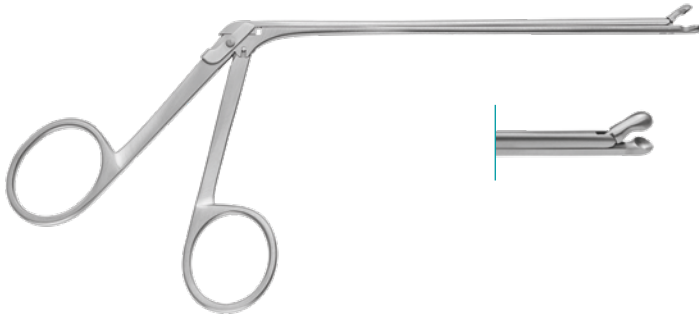
**HILDYARD**

Post-Nasal Forceps, 3.5mm biopsy cup

120mm, 4³/₄"

420-223-170

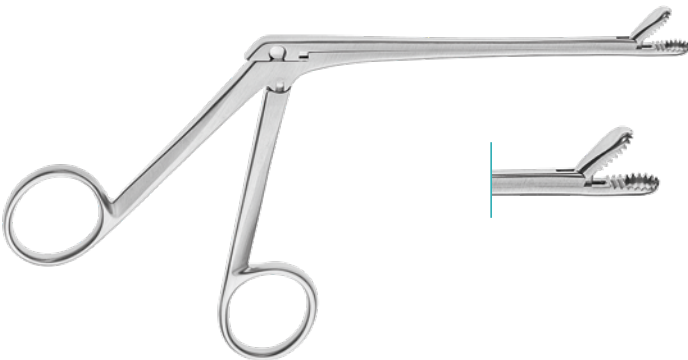
**WATSON-WILLIAMS**Ethmoidal Forceps for mucosa,
straight, serrated120mm, 4³/₄"

252-530-120

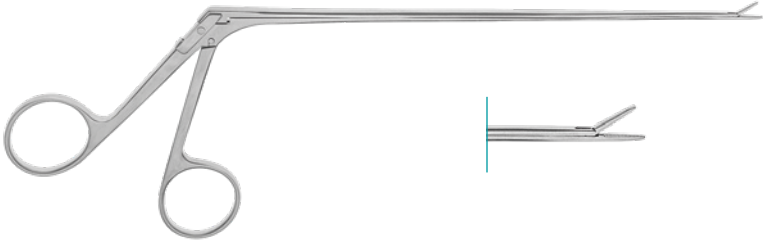
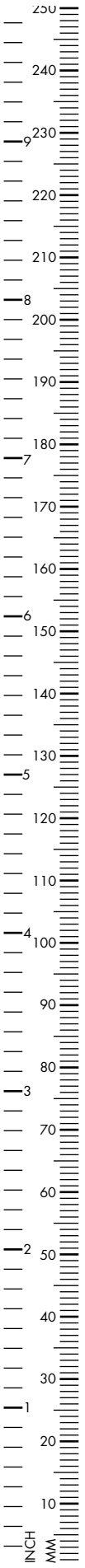

Grasping Forceps, fine serration
 150mm, 6" 252-160-150

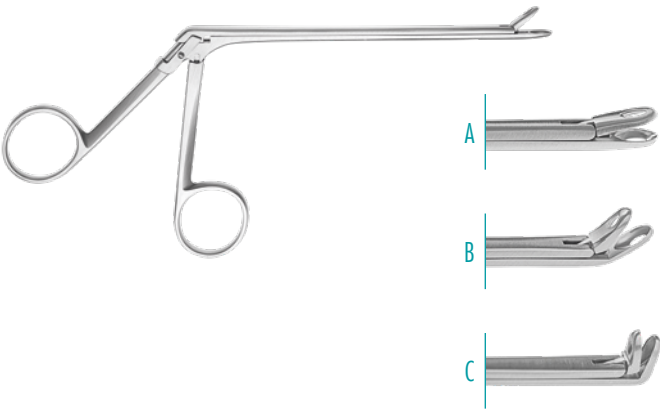

STRUEMPEL
 Nasal Forceps with oval fenestrated
 cupped jaws, 100mm, 4"
 A straight 252-031-120
 B 45° angled up 252-032-120
 C 90° angled up 252-033-120



BELLUCCI
 Scissors, straight
 100mm, 4" 252-034-120

**WATSON-WILLIAMS**Ethmoidal Forceps, 115mm, 4¹/₂"

Fig. 1, 6.5mm	252-529-120
Fig. 2, 9.5mm	252-531-120

**BRUENINGS**Septum Forceps, fenestrated, 190mm, 7¹/₂"

Size 1, 6.5mm	252-028-001
Size 2, 7.5mm	252-028-002
Size 3, 9.0mm	252-028-003
Size 4, 10.0mm	252-028-004

**CRAIG**Septum Bone Cutting and Breaking Forceps, sharp cup, 6mm, 165mm, 6¹/₂"

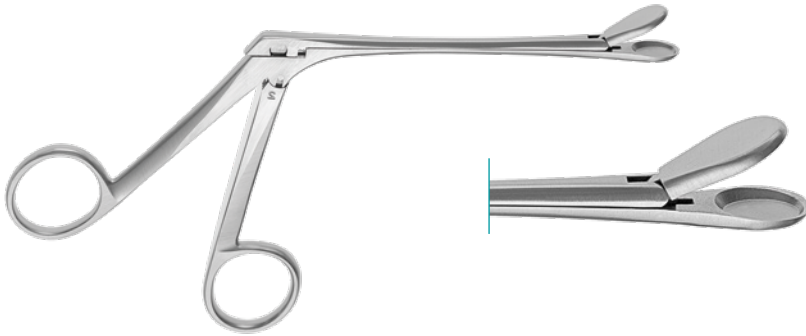
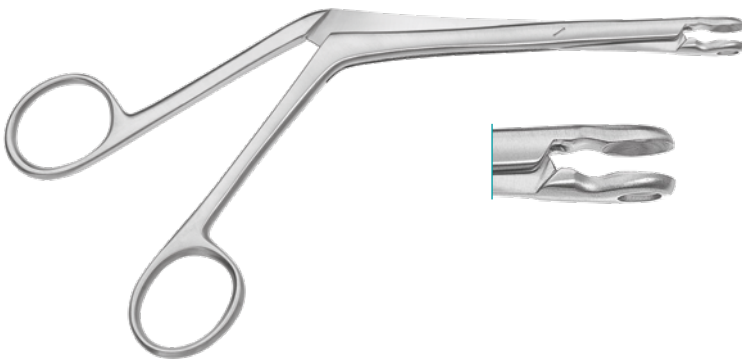
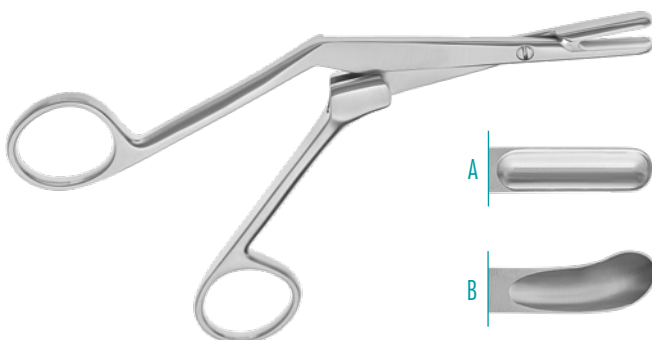
A straight

Oval cup	252-029-000
----------	-------------

B curved left

	252-029-500
--	-------------

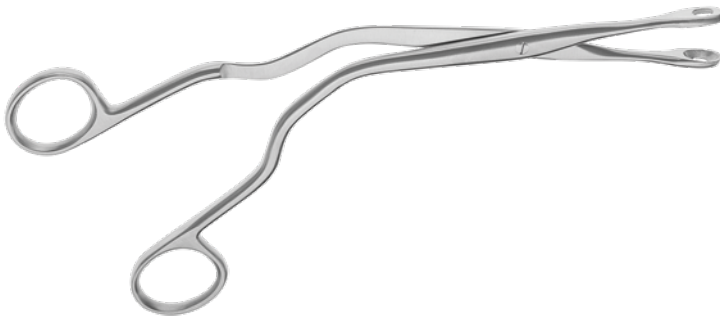
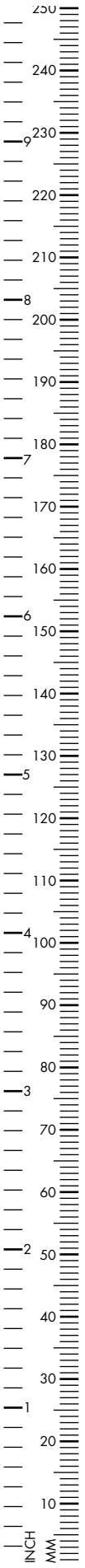

LUC

Septum Forceps with fenestrated jaws
190mm, 7¹/₂"

6.0mm	420-400-001
7.5mm	420-400-002



HEYMANN-KNIGHT

Septum Forceps, sharp oval cup

190mm, 7 ¹ / ₂ "	420-422-190
--	-------------



JANSEN-MIDDLETON

Nasal Forceps, 4x11mm, spoon jaws

170mm, 6 ² / ₃ "	252-032-190
--	-------------



JANSEN-MIDDLETON

Nasal Punch, through cutting, 210mm, 8¹/₄"

4 x 14mm	252-031-190
3 x 13mm	252-033-190

**BECKER**

Septum Scissors, double action, serrated

180mm, 7"

420-213-180

**CAPLAN**

Nasal Scissors, straight blade

220mm, 8^{2/3}"

120-286-220

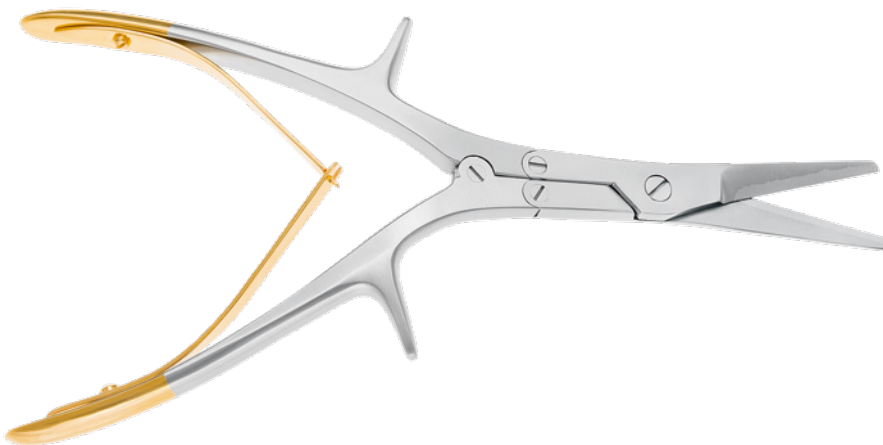
**GORNEY**

Nasal Scissors, straight blade

220mm, 8^{2/3}"

120-588-220

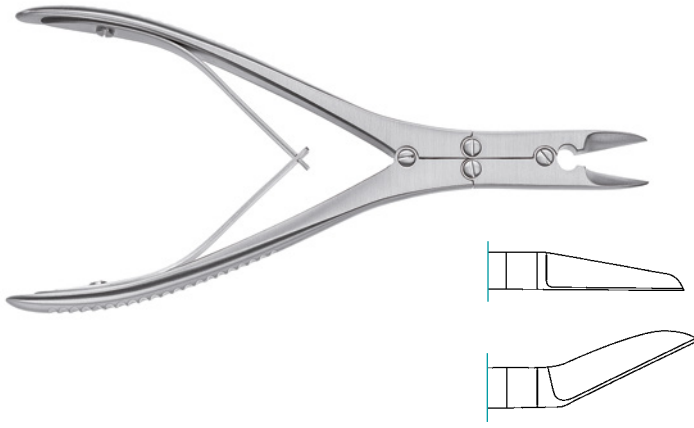
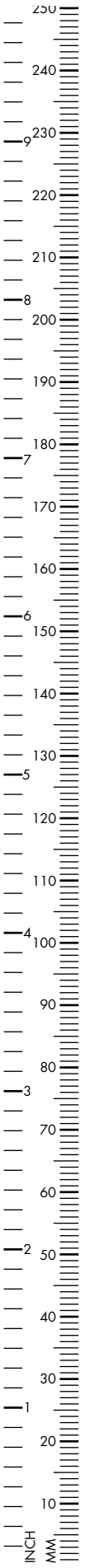

RUSKIN LISTON

Bone Cutting Forceps, double action,
170mm, 6²/₃"

straight	210-844-170
angled	210-843-170

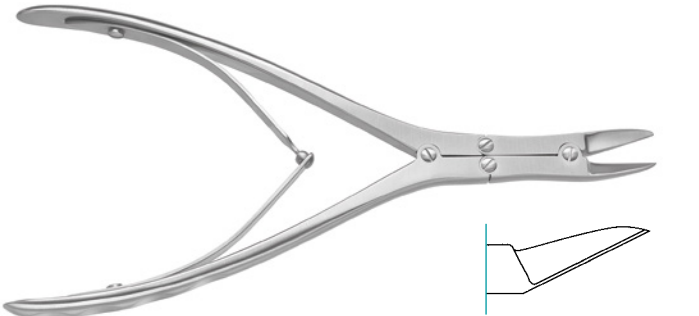

MCINDOE

Bone Cutting Forceps, double action

175mm, 6 ⁷ / ₈ "	210-880-175
--	-------------

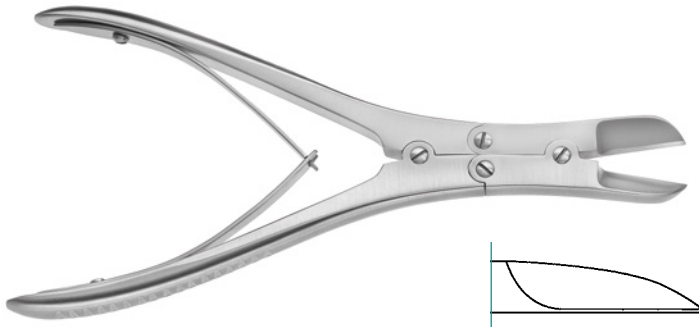

RUSKIN ROWLAND

Bone Cutting Forceps, double action, straight

180mm, 7"	210-855-180
-----------	-------------

**GUASTELLA**

Lateral Osteotomy Forceps

280mm, 11" 420-370-400

**KRESSNER**Crushing Forceps, kee-bent, 220mm, 8²/₃"

3mm 420-408-003

4mm 420-408-004

**RUBIN**Septum Morcelizer, double action,
straight205mm, 8¹/₈" 420-370-210190mm, 7¹/₂" 420-371-210

Protection Cap

420-370-212

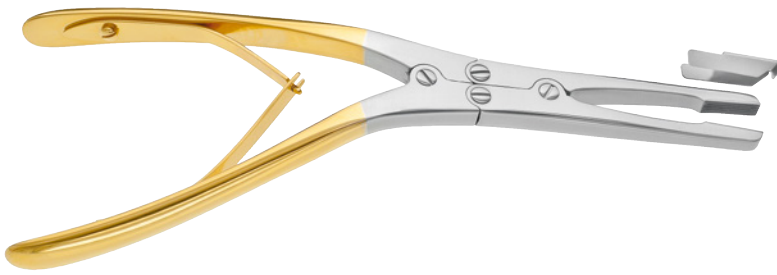
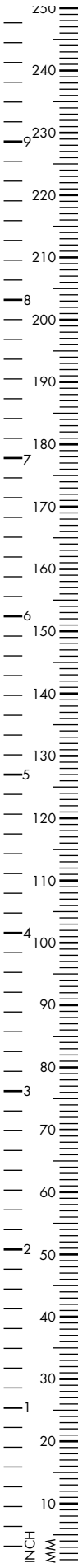

RUBIN
Septum Morselizer, double action, with guard
220mm, 8²/₃"

	420-220-220
Guard only	420-221-200

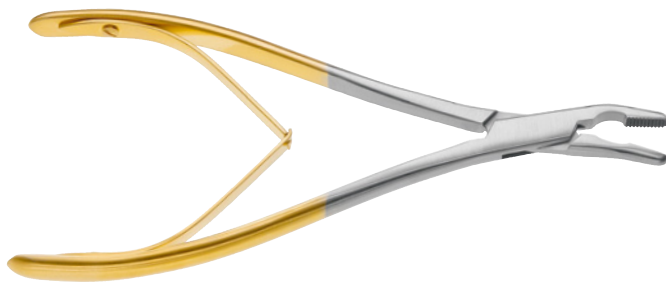

GUNTER
TC Lower Lateral Morselizer
180mm, 7"

	420-220-212
--	-------------



COTTLE-WALSHAM
Septum Forceps, aseptically lock
230mm, 9"

	420-450-230
--	-------------



COTTLE-WALSHAM
Septum Straightening Forceps, 230mm, 9"

A right	420-452-230
B left	420-451-230



**ASH**

Septum Straightening Forceps, curved

220mm, 8²/₃"

420-455-230

**BOIES**

Elevator for septum repositioning

170mm, 6²/₃"

420-557-170

**BOIES**

Nasal fracture elevator, 9mm tip

195mm, 7³/₄"

420-555-195

**GOLDMANN**

Septum elevator, round (displacer)

200mm, 8"

420-189-210

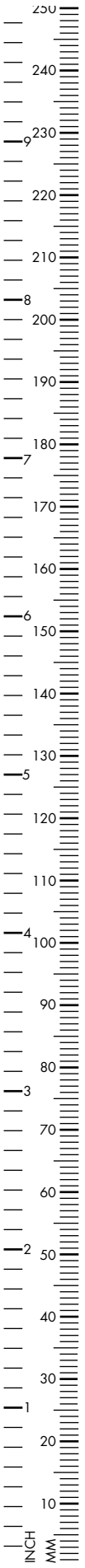

FREER
Mucosa Knife

150mm, 6" 420-195-150



COTTLE
Septum knife, stiff blade with rounded edge

140mm, 5 1/2" 420-213-140



JOSEPH
Button-End Knife, angled

165mm, 6 1/2" 420-209-175



JOSEPH
Nasal Knife, sharp, double-edge,
150mm, 6"

straight 420-190-003

curved 420-191-003



MASING
Cartilage Slitting Knife, curved blade, sharp

130mm, 5 1/8" 420-552-130



Skin Hook	
150mm, 6"	170-011-150



GRAEFF	
Micro Skin Hook, 125mm, 5"	
sharp	170-010-125



KILNER	
Skin Hook, sharp	
150mm, 6"	230-203-150



GILLIES	
Skin Hook, 180mm, 7"	
A small	230-205-180
B medium	230-207-180
C large	230-209-180

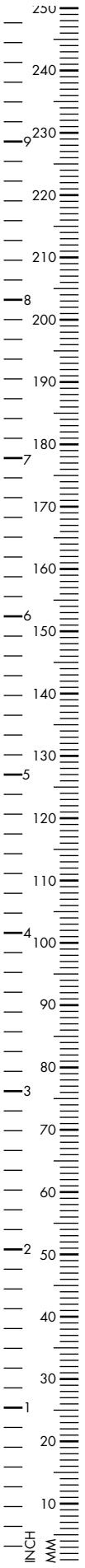

COTTLE

Nerve Hook, 168mm, 6²/₃"

180° retrograde curved 230-286-160

120° retrograde curved 230-285-160



FISCH

Hook, 90°, sharp, angled

185mm, 7¹/₄" 250-064-376

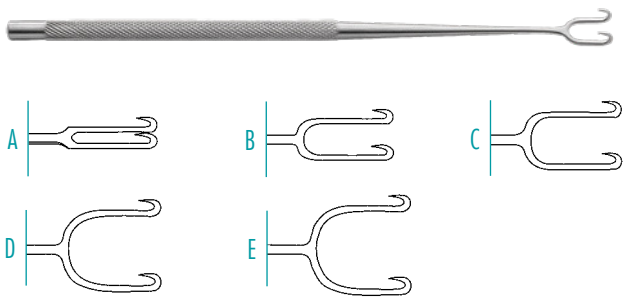

JOSEPH

Skin Hook, 2 prongs, 160mm, 6¹/₄"

A 2mm wide 170-014-002

B 5mm wide 170-014-005

C 7mm wide 170-014-007

D 10mm wide 170-014-010

E 12mm wide 170-014-012



Thumb Retractor, sharp, double hook, 8mm wide
 38mm working length 170-008-381



FREER
 Skin hook, 2 prongs, sharp
 150mm, 6" 230-220-001



COTTLE
 Nasal Retractor, 10mm wide
 130mm, 5 1/8" 420-187-130

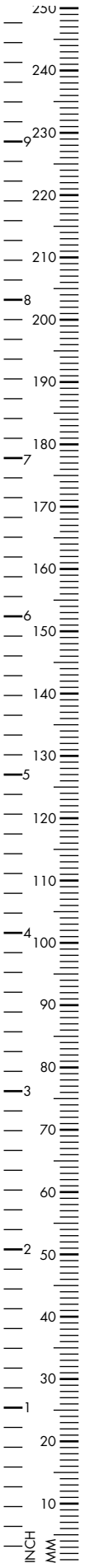

FOMON

Alar Retractor, 2 buttoned prongs

160mm, 6¹/₄" 230-280-160



FOMON

Alar Retractor, 2 buttoned prongs, insulated end

160mm, 6¹/₄" 230-780-160



COTTLE

Alar Retractor, 2 prongs, 140mm, 5¹/₂"
blunt/sharp

buttoned right 230-281-140

sharp/blunt

buttoned left 230-282-140

sharp/sharp

230-283-140



MASING

Alar Retractor, 6 x 12mm,
140mm, 5¹/₂"

420-520-140



insulated 420-520-141



COTTLE

Alar Retractor, 10 x 12mm,
140mm, 5¹/₂"

420-523-140

insulated 420-523-141

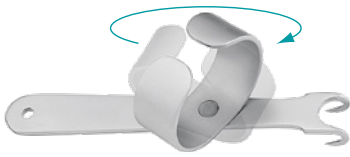
**RZ-NOSE**

RZ Nasal Retractor with Thimble Hook,
swivelling

85mm, 3¹/₃" 260-200-110

**KILNER**

Alar Retractor, 2 prongs, 10mm wide,
85mm, 3¹/₄"

sharp 420-184-100

blunt 420-185-100

**KILNER**

Alar Retractor, 2 sharp prongs, 13mm wide

85mm, 3¹/₄" 420-184-130

**RUBIN**

Hook, 7 x 5.5mm

sharp 420-187-155

blunt 420-187-255

**CONVERSE**

Alar Retractor, double-ended, 120mm, 4³/₄"

sharp 260-502-120

blunt 260-501-120

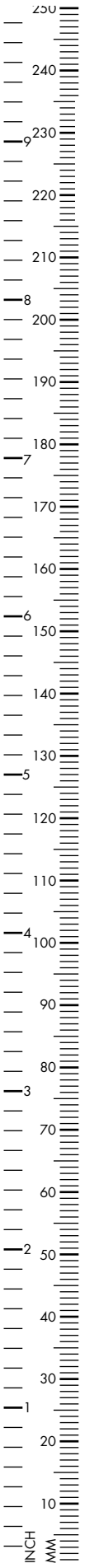

HARALD

Retractor, double-ended

420-186-140



KILNER

Double Hook

420-186-100



COTTLE-NEIVERT

Alar Retractor, saw and knife guide, 2 prongs, blunt

200mm, 8" 230-260-200



NEIVERT

Nasal Retractor, double-ended, with knife guide

160mm, 6 1/4" 170-036-180

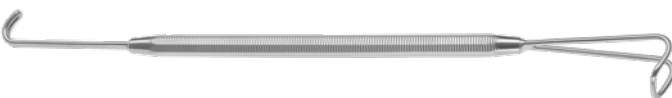

NEIVERT-RETTINGER

Nasal Hook

13mm 170-036-183

17mm 170-036-187

**WALTER**

Nasal Hook, 2 blunt prongs and blunt blade

135mm, 5¹/₃" 420-256-135**AUFRICHT**

Double-Ended Nasal Retractor, blunt

5mm / 42 x 7mm 420-260-005

8mm / 38 x 7mm 420-260-008

13mm / 38 x 7mm 420-260-013

13mm / 42 x 10mm 420-260-113

**MALINIAC**

Nasal Retractor, 9 x 45mm

100mm, 4" 420-652-100

with fiber optic light carrier

100mm, 4" 420-752-100

**CONVERSE**

Nasal Retractor, 11x44mm

110mm, 4¹/₃" 420-235-110

with fiber optic light carrier

100mm, 4" 420-236-110

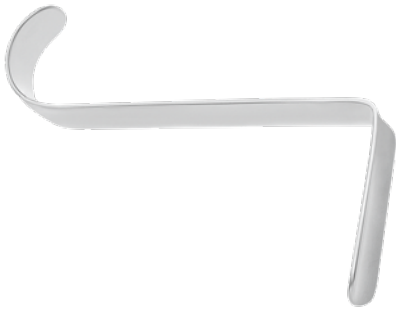
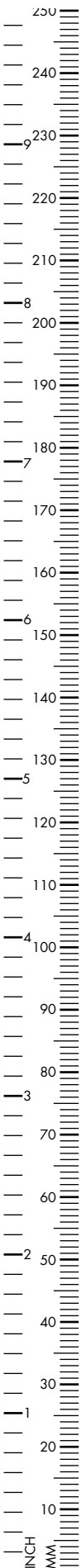
**CONVERSE**Nasal Retractor, 90mm, 3¹/₂"

10x20mm	420-237-095
12x30mm	420-238-095
12x40mm	420-239-090
12x50mm	420-239-095

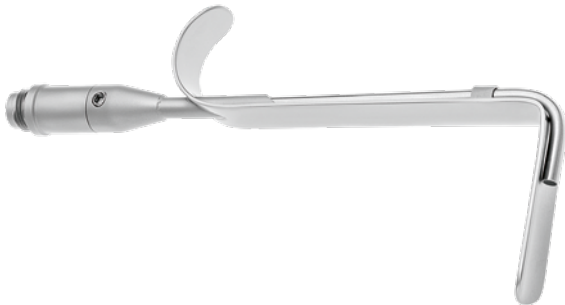
**CONVERSE**Nasal Retractor with fibre-optic light carrier, 90mm, 3¹/₂"

10x20mm	420-237-195
12x30mm	420-238-195
12x40mm	420-239-190
12x50mm	420-239-195

**AUFRICHT**Nasal Retractor, 160mm, 6¹/₄"

10 x 45mm	420-250-160
-----------	-------------

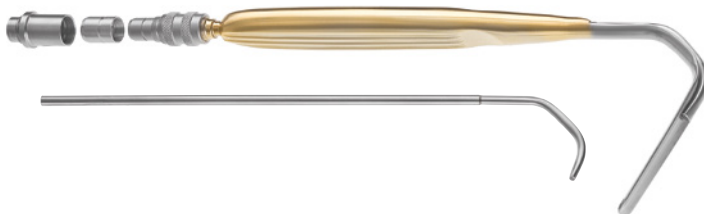
**AUFRICHT**

Nasal Retractor, with detachable fiber optic, 120°, 45mm blade

180mm, 7"	420-255-160
-----------	-------------



Dissector / Probe, double ended,
pointed tip / round cutting tip, 8mm

130mm, 5¹/₈" 420-546-130

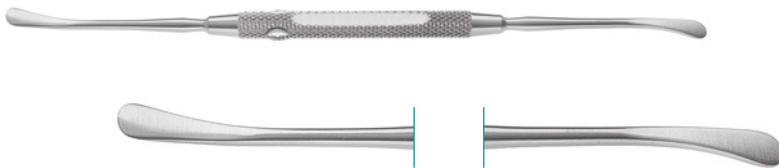

FREER
Septum Elevator, sharp/blunt, 5mm

185mm, 7¹/₄" 420-546-180

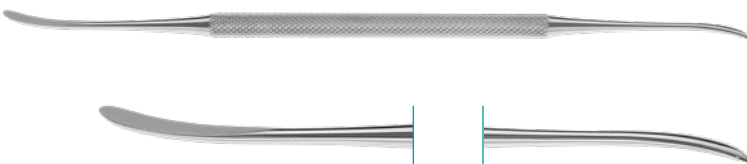

DANIEL
Elevator

420-546-200

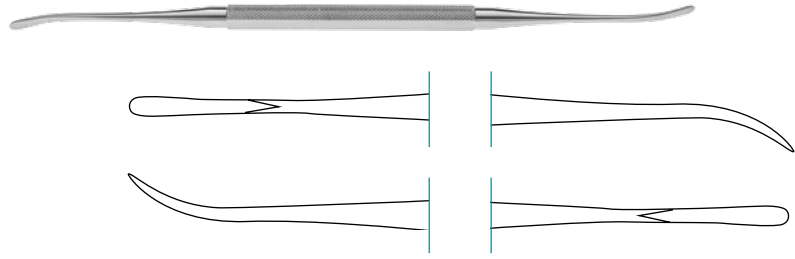
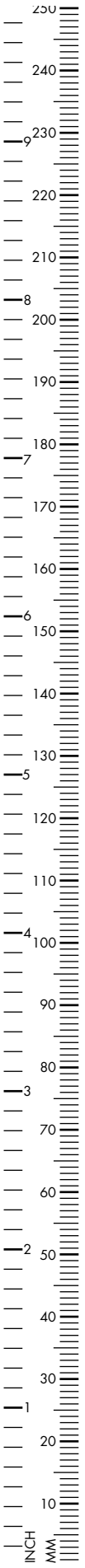

FREER-YASARGIL

Dissector, sharp

190mm, 7¹/₂"

420-548-180



FREER

Septum Elevator, double-ended,
semi-blunt/blunt

200mm, 8"

252-001-200



KLEINERT-KUTZ

Elevator and Dissector, double-ended,
blade A: 4.5mm / blade b: 3.0mm

180mm, 7"

420-554-178

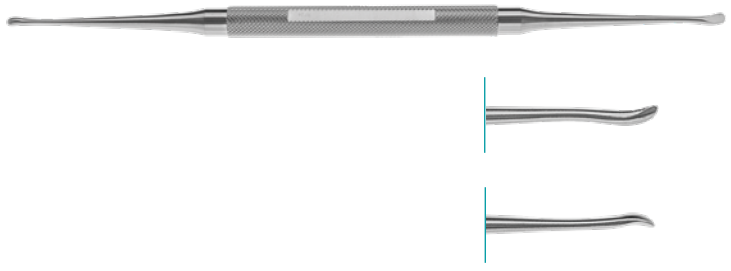

KLEINERT-KUTZ

Elevator and Dissector, double-ended,
blade A: 2.5mm / blade b: 3.0mm

190mm, 7¹/₂"

420-554-190

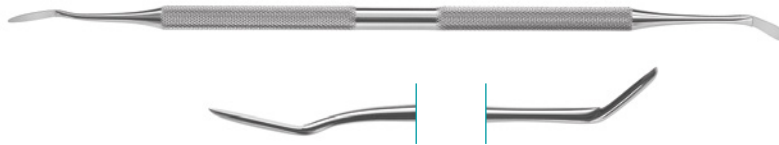
**FREER-LONG**Septum Elevator, double-ended,
sharp/sharp220mm, 8^{2/3}" 252-001-220**WOODSON**

Elevator, 2.4 / 4.0mm blade

200mm, 8" 420-556-200

**FREER-JOSEPH**

Septum Elevator, double-ended

200mm, 8" 420-555-200

**OBWEGESER-FREER**

Septum Elevator, double-ended

200mm, 8" 420-532-200

**HOWARTH**

Elevator, double-ended, sharp/blunt

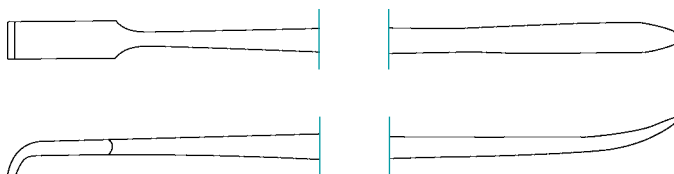
215mm, 8^{1/2}" 420-552-215

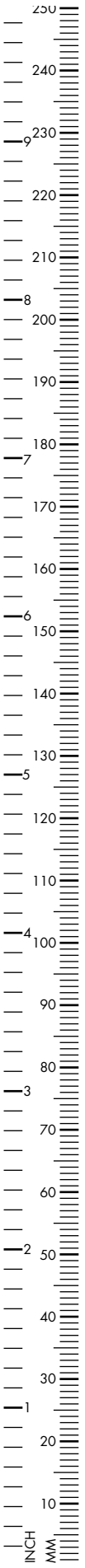

HARALDSSON

Suction Elevator

190mm, 7¹/₂"

420-390-190



RZ

Nasal Suction Dissector, Luer Lock,
Ø 8mm, 190mm, 7¹/₂"

sharp

420-310-190

blunt

420-311-190



NEGUS

Suction Dissector, blunt, 6mm

210mm, 8¹/₄"

420-395-205



GORNEY

Suction Raspatory, semi-sharp, 3mm

180mm, 7"

420-253-185

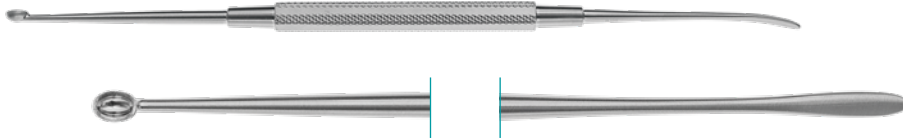

CARTER

Septum Elevator, double-ended

210mm, 8¹/₄" 420-551-210

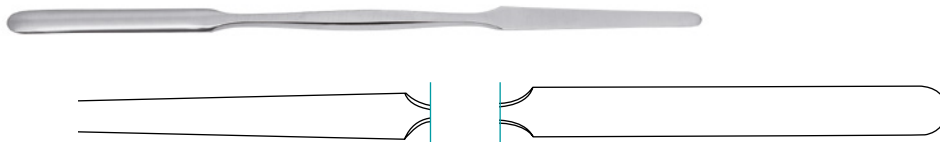

KILLIAN

Elevator, double-ended, sharp/blunt

185mm, 7¹/₄" 420-541-180

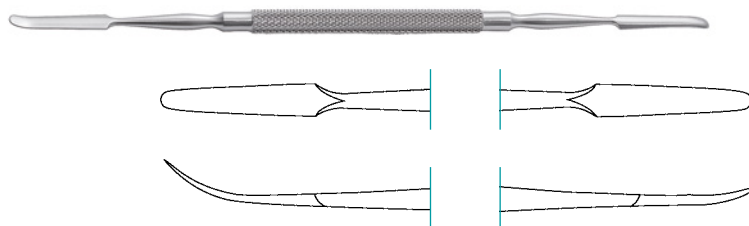

KILLIAN

Raspatory, 6mm, sharp/blunt

180mm, 7" 420-540-180



KILLIAN

Septum double-ended elevator,
shuffle-shaped, sharp/blunt

180mm, 7" 252-002-180

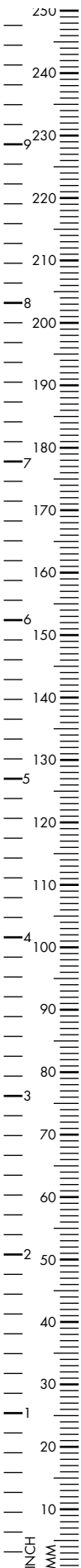
**MASING**

Elevator, double-ended, graduated, sharp/blunt

200mm, 8"

420-551-200

**COTTLE**

Perisosteal Elevator, double ended, graduated

220mm, 8²/₃"

420-553-220

**JOSEPH**Masing Septum Elevator, bayonet shaped,
slightly curved210mm, 8¹/₄"

420-550-210

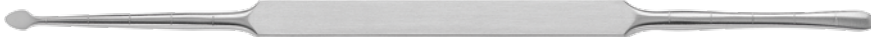
**COTTLE**Elevator, double-ended, graduated,
sharp/sharp

230mm, 9"

420-550-230

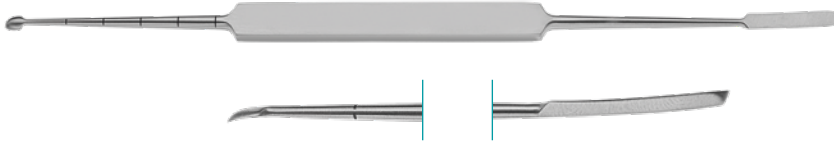
**COTTLE-JOSEPH**

Double Elevator

225mm, 8^{7/8}"

420-550-225

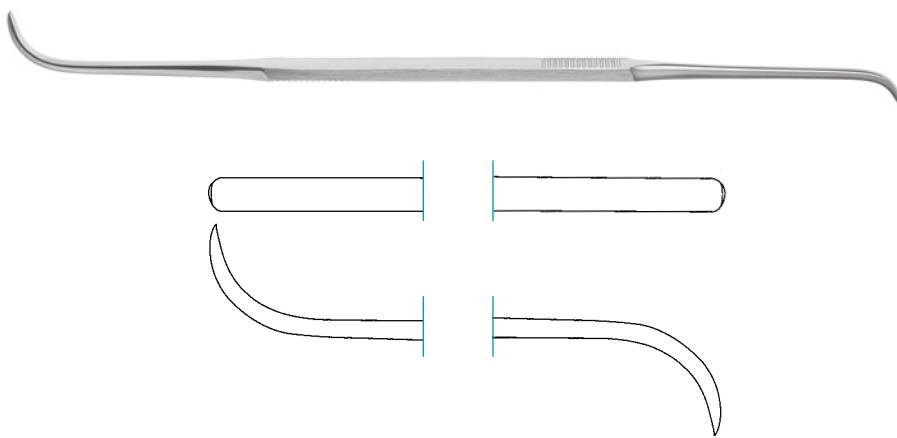
**COTTLE**

Elevator, double-ended, for tunneling

220mm, 8"

420-552-200

**PENNINGTON**

Elevator

210mm, 8^{1/4}"

420-543-210

**FREER**

Periosteal Elevator, double-ended, sharp

175mm, 6^{7/8}"

420-551-175

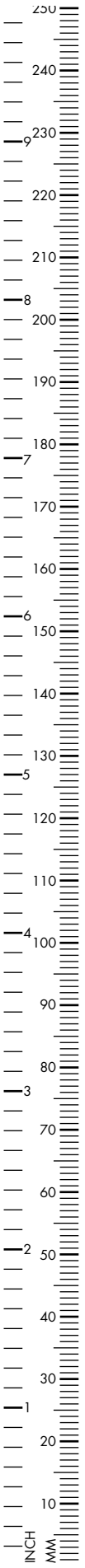

MCKENTY

Septum and Periosteal Elevator

220mm, 8²/₃"

420-539-220



MCKENTY

Raspatory, 150mm, 6"

4mm

420-547-004

5mm

420-547-005



JOSEPH

Periosteal elevator, slightly curved,

170mm, 6²/₃"

2mm

420-530-165

3mm

420-531-165

4mm

420-532-165

5mm

420-533-165

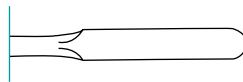

Raspatory, 170mm, 6²/₃"

6mm 210-439-006

8mm 210-439-008

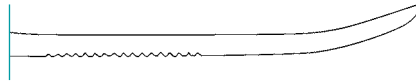
**PLESTER**

Raspatory, 8mm wide

180mm, 7" 410-336-180

**ERLANGEN**

Raspatory, 6mm wide, slightly curved

175mm, 6⁷/₈" 420-547-006**HALLE**

Raspatory, 4mm, blunt, slightly curved

180mm, 7" 420-544-165

**FREER**

Periosteal Elevator, 4mm

160mm, 6¹/₄" 420-551-180

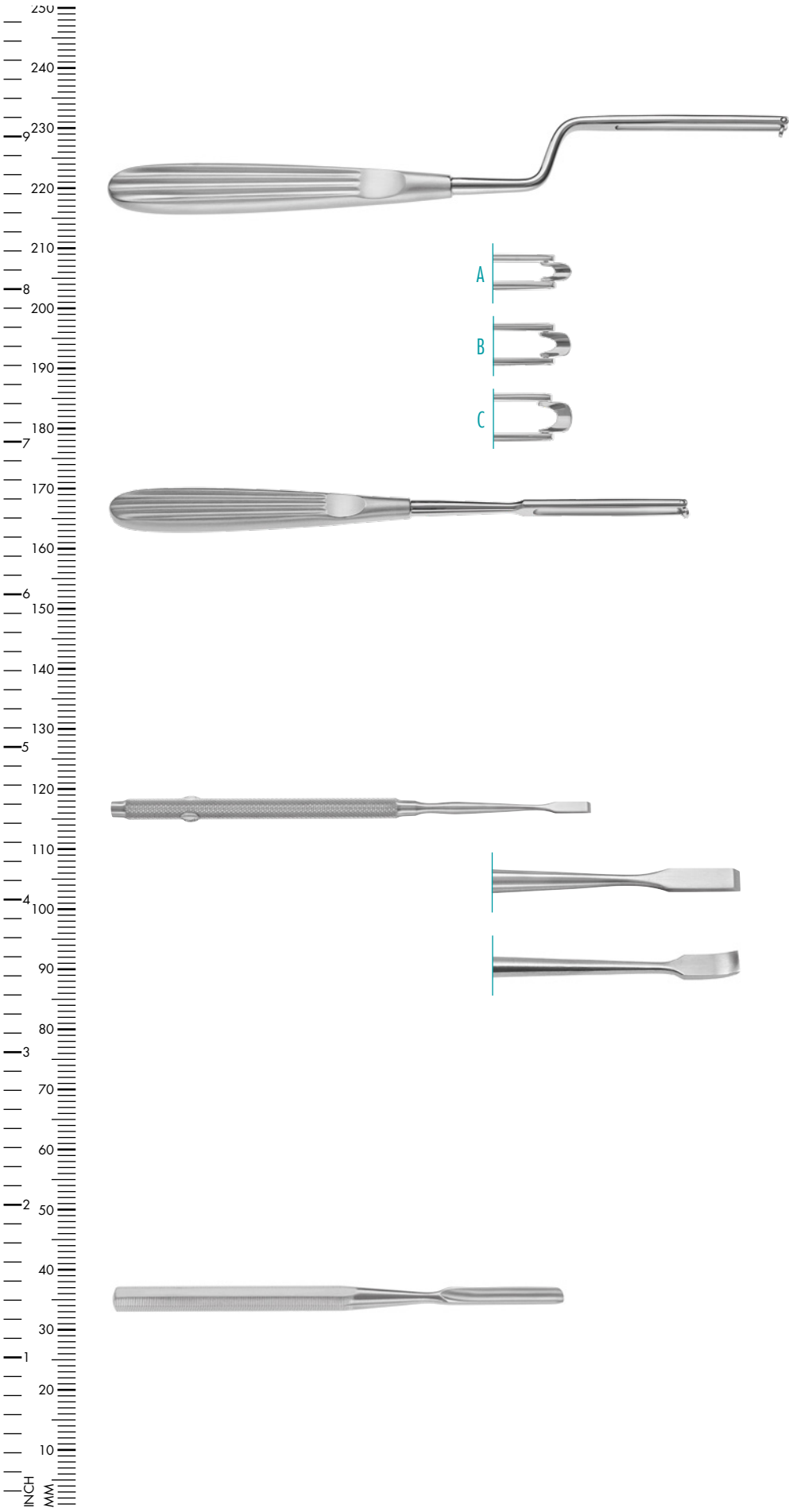

BALLENGER

Swivel knife, bayonet shaped, 210mm, 8¹/₄"

A 3mm	420-392-003
B 4mm	420-392-004
C 5mm	420-392-005

straight, 195mm, 7²/₃"

A 3mm	420-393-003
B 4mm	420-393-004
C 5mm	420-393-005

FREER

Septum Chisel, 4mm, 160mm, 6¹/₄"

straight	420-590-004
curved	420-591-004

FREER

Septum Gouge, straight, round cutting, 6mm

150mm, 6"	420-550-170
-----------	-------------

**BALLENGER**

Septum Gouge, with notch and cutting edge,
6mm

155mm, 6¹/₈" 420-595-170

**KILLIAN**

Septum Gouge, round cutting edge,
bayonet shaped, 6mm

170mm, 6²/₃" 420-552-170

**KILLIAN-CLAUS**

Septum Gouge with notch, bayonet shaped,
6mm

170mm, 6²/₃" 420-551-170

**COTTLE**

Chisel, graduated, 185mm, 7¹/₄"

3mm 210-488-003

4mm 210-488-004

6mm 210-488-006

7mm 210-488-007

9mm 210-488-009

12mm 210-488-012

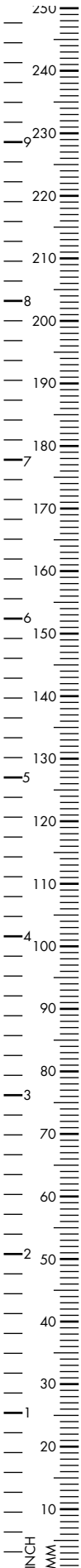

COTTLE

Chisel, curved, graduated, 6mm

180mm, 7"

210-486-006



COTTLE

Chisel, 4mm

180mm, 7"

210-475-004



COTTLE

Osteotome with depth marking, 180mm, 7"

4mm

210-487-004

7mm

210-487-007

8mm

210-487-008

10mm

210-487-010

12mm

210-487-012



COTTLE

185mm, 7 1/4"

4mm

210-472-004

6mm

210-472-006

7mm

210-472-007

9mm

210-472-009

12mm

210-472-012

**COTTLE**

Fishtail Osteotome, protecting ends,
double guarded, 8mm

180mm, 7" 210-486-008

**COTTLE**

Osteotome with guard and crossbar, 5mm

185mm, 7^{1/4}" 210-472-105

**COTTLE**

Fishtail osteotome, with crossbar,
with round cutting end, 16mm

180mm, 7" 210-486-016

**COTTLE-CINELLI**

Chisel, 185mm, 7^{1/4}"

10mm 210-474-010

12mm 210-474-012

14mm 210-474-014

16mm 210-474-016

**CINELLI**

Osteotome, double guarded, straight
160mm, 6^{1/4}"

8mm	420-589-008
10mm	420-589-010
12mm	420-589-012
14mm	420-589-014
16mm	420-589-016

**RUBIN**

Osteotome, 167mm, 6^{2/3}"

8mm	420-587-008
10mm	420-587-010
12mm	420-587-012
14mm	420-587-014
16mm	420-587-016

**FANOUS-GUBISCH**

Osteotome, straight, 4mm wide, with guard,
200mm, 8"

straight	420-640-001
right curved	420-640-002
left curved	420-640-003

**ANDERSON-NEIVERT**

Osteotome, 3.5mm, 205mm, 8^{1/8}"

straight	420-639-001
curved right	420-639-002
curved left	420-639-003

**SILVER**Osteotome, slender model, 185mm, 7¹/₄"

straight	420-460-001
left	420-460-002
right	420-460-003

**SILVER**

Osteotome, with guard, straight, 180mm, 7"

straight	420-459-001
left curved	420-459-002
right curved	420-459-003

**MASING**

Osteotome, with guard, 180mm, 7"

straight	420-459-101
right curved	420-459-102
left curved	420-459-103

**FRENCHAY**

Nasal Chisel with guard 180mm, 7"

curved left	420-491-001
curved right	420-491-002
straight	420-491-000

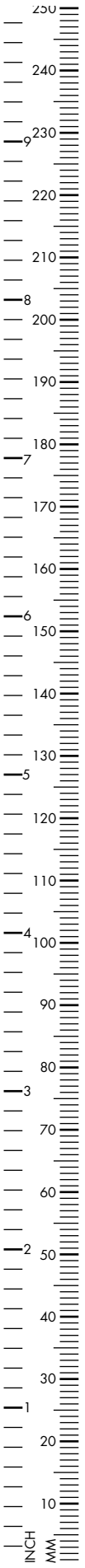

GUASTELLA

Osteotome, 180mm, 7"

left	420-472-002
right	420-472-003



MCINDOE

Osteotome, hard edge, mushroom head, 150mm, 6"

9mm	420-487-009
11mm	420-487-011
13mm	420-487-013
15mm	420-487-015



WALTER

Chisel with notch, double guarded, 190mm, 7 1/2"

3.0mm	420-582-003
4.5mm	420-582-045



WALTER

Osteotome, 190mm, 7 1/2"

A 2mm	420-580-002
B 3mm	420-580-003
C 4mm	420-580-004
D 7mm	420-580-007
E 9mm	420-580-009
F 12mm	420-580-012

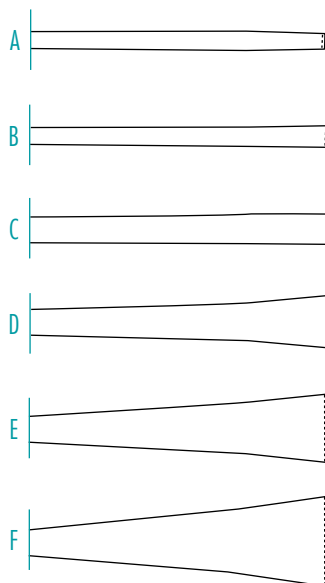

**SHEEHAN**Osteotome, 160mm, 6^{1/4}"

2mm	420-594-002
3mm	420-594-003
4mm	420-594-004
5mm	420-594-005
6mm	420-594-006
8mm	420-594-008
10mm	420-594-010
12mm	420-594-012

**RZ OSTEOTOME**

Osteotome, 180mm, 7"

2mm	420-568-002
3mm	420-568-003
4mm	420-568-004
5mm	420-568-005
6mm	420-568-006
7mm	420-568-007

**SHEEHAN**Osteotome, 90mm, 3^{1/2}"

1mm	420-594-002
-----	-------------

Mini Osteotome, CeraCut®, 175mm, 6^{7/8}"

2mm	420-702-175CC
3mm	420-703-175CC
4mm	420-704-175CC
6mm	420-706-175CC

**COTTLE**

Mallet, Ø 30mm, 1 side plain, 1 side convex
240g

190mm, 7¹/₂" 210-240-180

**LUCAE**

Mallet, Ø 19mm
190mm, 7¹/₂"

80g 210-230-190

140g 210-231-190

**COLLIN (LUCAE)**

Mallet, Ø 30mm
220g

200mm, 8" 210-220-200



Mallet, Ø 35mm, synthetic

240mm, 9¹/₂" 210-260-150



Mallet, anodized aluminium handle and head,
Ø 32mm
140g

225mm, 8⁷/₈" 210-264-220

Spare Discs, pair 210-264-221

**JOSEPH**Nasal Saw, 190mm, 7¹/₂"

straight	230-202-000
bayonet shaped, curved left	230-202-001
bayonet shaped, curved right	230-202-002

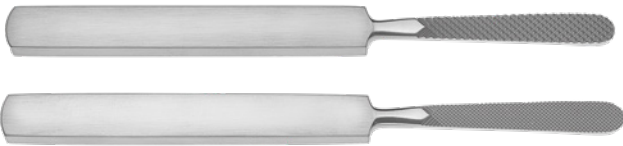
**JOSEPH**Nasal Rasp, cross-serrated, 160mm, 6¹/₄"

fine	420-605-160
coarse	420-606-160

**MALTZ**

Rasp, straight, 180mm, 7"

backward cutting	420-654-180
forward cutting	420-657-180

**MCINDOE**

Nasal Rasp, straight, backward cutting

180mm, 7"	420-655-180
-----------	-------------

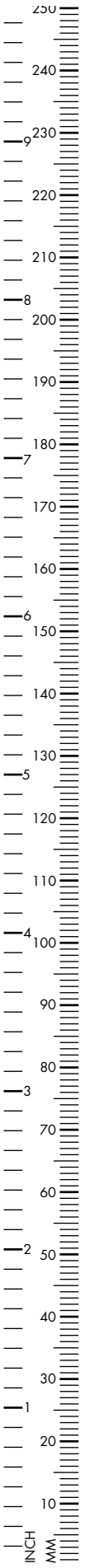

LEWIS

Nasal Rasp, 7mm wide tip

200mm, 8"

420-658-175



COTTLE

Nasal Rasp, backward cutting, straight

210mm, 8¹/₄"

420-670-210



AUFRICHT

Nasal Rasp, 90° cross-serrated,
9mm wide, 220mm, 8²/₃"

A backward cutting

420-650-001

B forward cutting

420-650-002

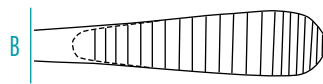
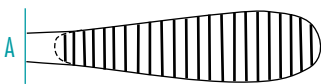

MILLER

Rasp, 90° cross-serrated, backwards cutting,
180mm, 7"

Fig. 1 8mm / 5mm

500-387-000

Fig. 2 6mm / 4mm

500-384-010

Fig. 3 6mm / 5mm

500-386-045

Fig. 1

Fig. 2

Fig. 3



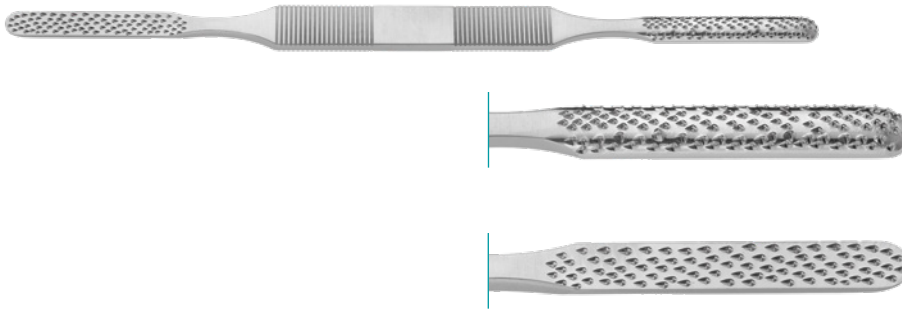

FOMON LIGHTWEIGHT

Rasp, double-ended, 7.0mm
215mm, 8¹/₂"

Coarse	420-662-001
Fine	420-662-002

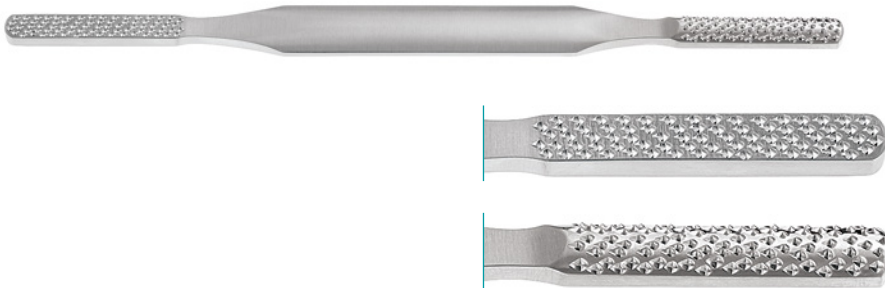

FOMON

Rasp, coarse, double-ended, 7.0mm / 8.0mm
215mm, 8¹/₂"

420-660-000

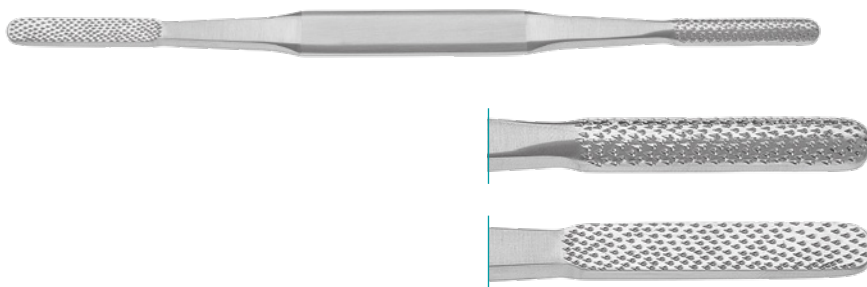

FOMON

Rasp, fine, round/flat
215mm, 8¹/₂"

420-661-000

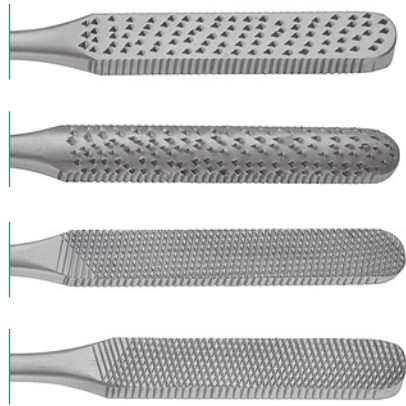
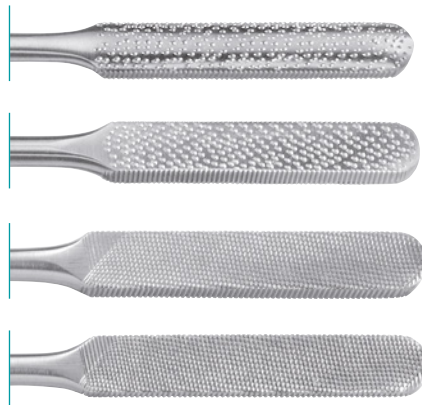
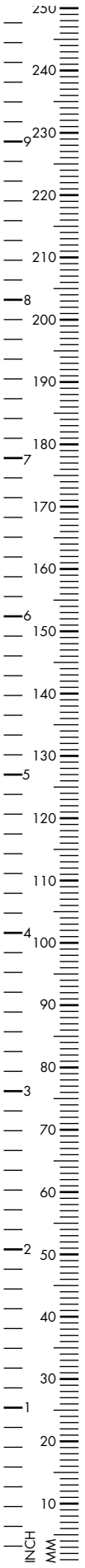

FOMON

Rasp, fine/coarse, double-ended, 4 sides

215mm, 8¹/₂"

420-661-100

KLEINERT KUTZ

Rasp, double-ended, 4 sides

220mm, 8²/₃"

420-656-000



MALTZ

Nasal Rasp, straight, backward cutting

180mm, 7"

420-672-000



MALTZ

TC Rasp,

165mm, 6 1/2"

Fig. 2

420-492-165

Fig. 3

420-493-165



PARKES

TC Rasp, straight, 8 x 39mm

210mm, 8 1/4"

Fig. 1

420-490-210

Fig. 2

420-491-210

Fig. 3

420-492-210

Fig. 4

420-493-210

Fig. 5

420-494-210



FOMON

TC Rasp, double-ended, 7 x 40mm

210mm, 8 1/4"

Fig. 1 / Fig. 2

420-660-219

Fig. 3 / Fig. 4

420-660-214

Fig. 5 / Fig. 6

420-660-216

Fig. 7 / Fig. 8

420-660-218

Fig. 9 / Fig. 10

420-660-200



Fig.1
0.8



Fig.2
1.1



Fig.3
1.3

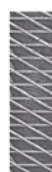

Fig.4
1.6



Fig.5
1.8



Fig.6
2.0



Fig.7
2.4



Fig.8
2.6



Fig.9
2.8



Fig.10
3.0

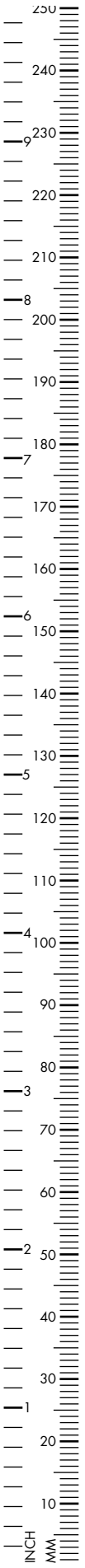

ASTON

Nasal Rasp, backward cutting, straight, 200mm, 8"

fine	420-480-200
coarse	420-488-200



AUFRICHT (PEET)

Nasal Rasp, 7 x 25mm fine, curved diamond jaws

200mm, 8"	420-650-101
-----------	-------------



PEET-COTTLE

Nasal Rasp, curved, diamond jaws

190mm, 7 1/2"	420-650-100
---------------	-------------

**PEET**

Convex Nasal Rasp, 25x8mm, straight
diamond jaws

190mm, 7¹/₂"

420-650-050

**COTTLE**

Rasp, 7x33mm, straight
diamond jaws

200mm, 8"

420-675-200

**FOMON**

Rasp, double-ended, convex on flat,
diamond jaws, 7 x 40mm

210mm, 8¹/₄"

420-653-000

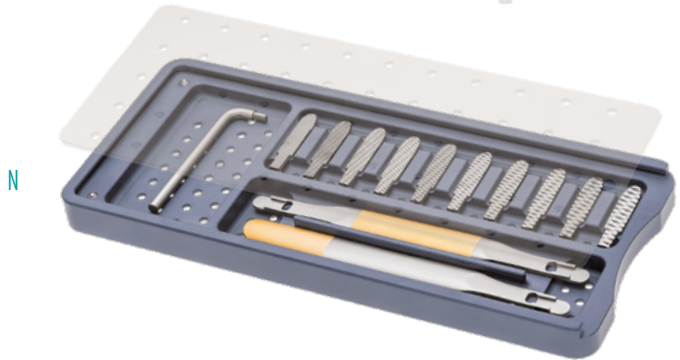
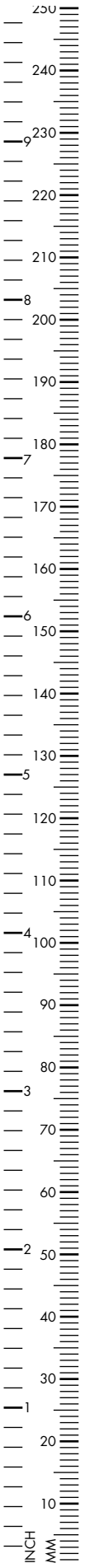

FOMON

Nasal Rasp Holder

A	double-ended	420-660-200
B	single-ended	420-660-100

FOMON

TC Insert

C	Fig. 1	420-660-101
D	Fig. 2	420-660-102
E	Fig. 3	420-660-103
F	Fig. 4	420-660-104
G	Fig. 5	420-660-105
H	Fig. 6	420-660-106
I	Fig. 7	420-660-107
J	Fig. 8	420-660-108
K	Fig. 9	420-660-109
L	Fig. 10	420-660-110

Fixation Key

M		420-660-150
----------	--	-------------

TC Nasal Rasp Set, complete in sterilization tray, incl. 10 inserts, 1 key and 2 handles (single+double)

N		420-660-500
----------	--	-------------

Wire Brush for cleaning rasps

165mm, 6 ¹ / ₂ "	260-500-001
--	-------------

**GIERTZ STILLE**

Rib Shears, double action

250mm, 9⁷/₈"

290-137-270

**DINGMANN**

Bone Holding Forceps, heavy pattern

190mm, 7¹/₂"

210-626-190

**LANGENBECK**

Bone Holding Forceps, 11mm wide

210mm, 8¹/₄"

210-722-210

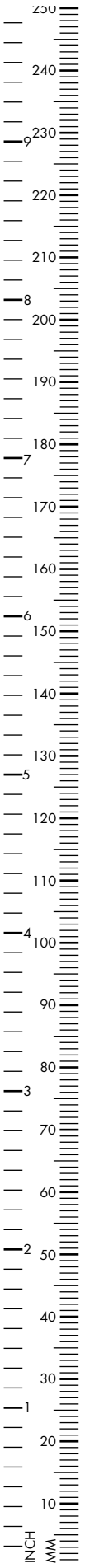

DOYEN

Rib Raspatory, 175mm, 6⁷/₈"

curved right	210-331-170
curved left	210-333-170



COTTLE

Bone Crusher with removal clip forceps,
28mm wide

420-365-000

Cartilage Crusher, 50mm wide

420-365-050

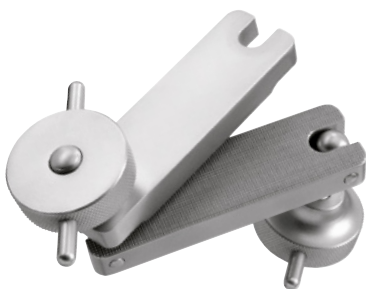

RZ

Cartilage Crusher

60 x 30mm	420-364-000
-----------	-------------

**TOLSDORF**

Bone crusher, inner part serrated, outer part
bottom plain, Ø 40mm

420-366-000



Plastic Plate, autoclavable

85 x 55mm 420-367-000



Plastic Plate, for preparation of bone grafts,
autoclavable

200x100x10mm 420-367-002

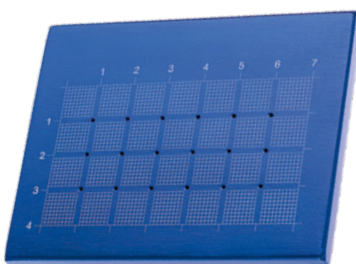
**SHEEN**

Cartilage Grid, aluminium, blue

70 x 40mm 260-761-000



Ruler, with mm inch markings

150mm, 6" 100-418-150

200mm, 8" 100-418-200

300mm, 12" 100-418-300

**CASTROVIEJO**

Caliper with locking screw, 0 - 15mm scale

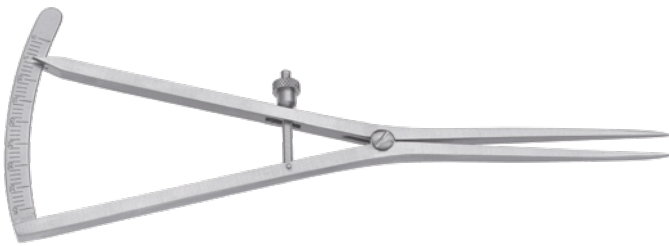
70mm, 2³/₄" 400-583-005**CASTROVIEJO**

Caliper with locking screw

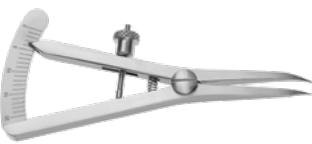
0 - 20mm, 400-583-007
85mm, 3¹/₄"0 - 40mm, 400-583-008
180mm, 7"**CASTROVIEJO**Caliper with locking screw, angled,
0 - 20mm scale70mm, 2³/₄" 400-583-009**JAMESON**Caliper with locking screw, graduated,
0 - 80 mm95mm, 3³/₄" 400-421-000**THORPE**Caliper with locking screw, graduated,
0 - 80 mm95mm, 3³/₄" 400-420-100

**NOLST TRENITÉ**

Glabella Rasp, 8mm wide

185mm, 7¹/₄"

420-700-400

**NOLST TRENITÉ**

Nasal Rasp, double-ended, 200mm, 8"

medium

420-700-501

medium/fine

420-700-502

**NOLST TRENITÉ**Micro Skin Hook, 155mm, 6¹/₈"

1 prong

420-700-001

2 prongs

420-700-002

**NOLST TRENITÉ**

Micro Skin Hook, 2 prongs, 10mm wide

420-700-210

**NOLST TRENITÉ**

Nasal Retractor, Aufrecht type

160mm, 6¹/₄"

420-700-200



BLAKESLEY (NOLST TRENITÉ)

Nasal Forceps, delicate, 3.5mm

85mm working length 420-700-700



NOLST TRENITÉ

Micro Osteotome, 185mm, 7¹/₄"

2.0mm	420-700-020
2.5mm	420-700-025
3.0mm	420-700-030
4.0mm	420-700-040
6.0mm	420-700-060



NOLST TRENITÉ

Micro Osteotome with guard, 185mm, 7¹/₄"

2.2mm	420-700-022
3.0mm	420-700-023
4.0mm	420-700-024



NOLST TRENITÉ

Micro Osteotome, 185mm, 7¹/₄"

10mm	420-700-100
12mm	420-700-120
14mm	420-700-140
16mm	420-700-160
18mm	420-700-180

**NOLST TRENITÉ**

Rhinoplasty Scissors, sharp, 100mm, 4"

straight 420-700-610

curved 420-700-611

**NOLST TRENITÉ**

Dissecting Scissors, Kilner type

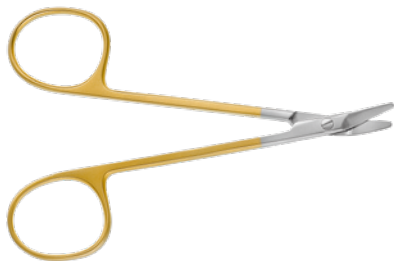
140mm, 5^{1/2}" 420-700-340**NOLST TRENITÉ**

Angled Scissors, Walter type

100mm, 4" 420-700-620

**NOLST TRENITÉ**

Halsey type

130mm, 5^{1/8}" 420-700-330

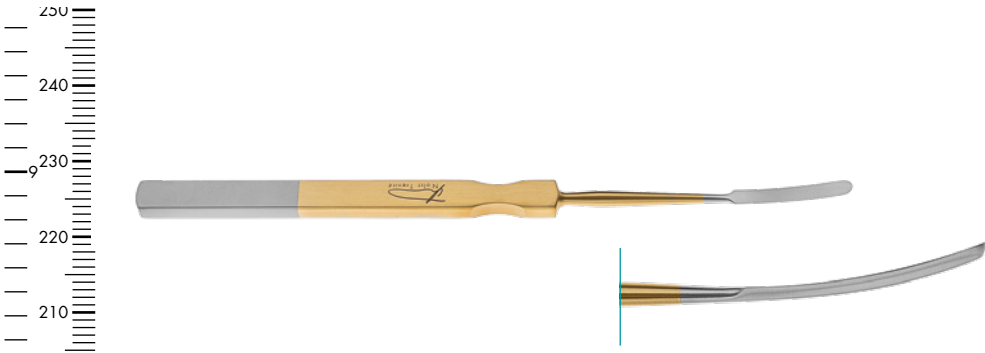

NOLST TRENITÉ
 Periosteal Elevator, Joseph Type, 3mm
 180mm, 7" 420-700-430

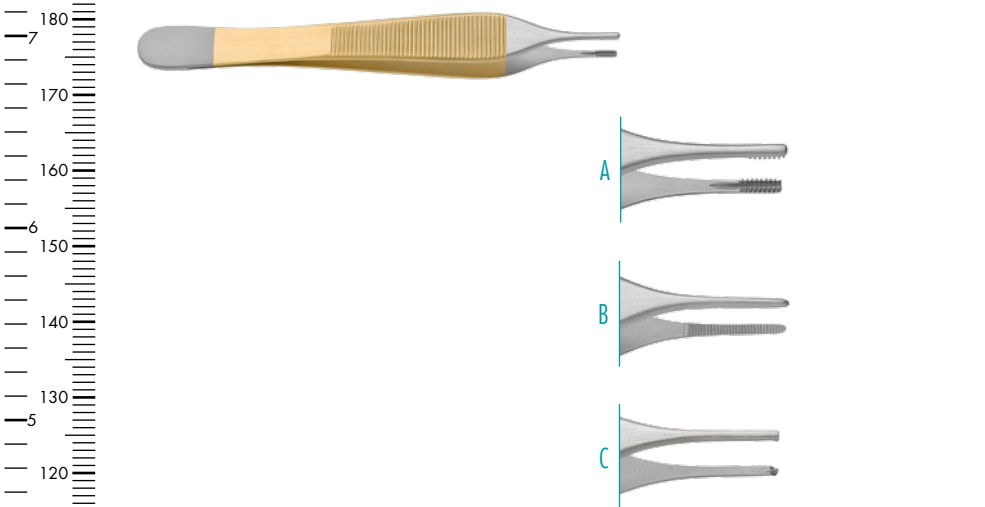

NOLST TRENITÉ
 Dressing/Tissue Forceps, 120mm, 4^{3/4}"

A Adson-Brown type	420-700-630
B Adson type	420-700-640
C Adson type	420-700-650

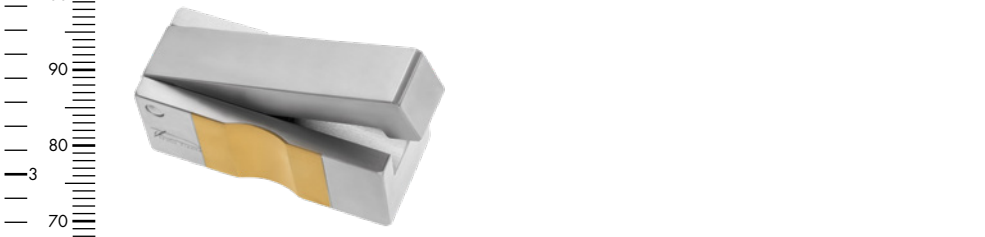

NOLST TRENITÉ
 Cartilage Crusher, Cottle type
420-700-777



NOLST TRENITÉ
 Mallet, Cottle type
420-700-888

INCH
MM



Bipolar electrode with flat plug,
105mm working length

A	700-420-002
B	700-420-001



Bipolar Suction Forceps, bayonet shaped,
200mm, 8"

1.4mm tip	700-600-201
2.0mm tip	700-600-202
230mm, 9"	
1.4mm tip	700-600-231
2.0mm tip	700-600-232
60° curved 210mm, 8 ¹ / ₄ "	
3.2mm tip	700-600-214
45° curved 210mm, 8 ¹ / ₄ "	
3.0mm tip	700-600-213



Bipolar Forceps, angled jaws, 2.0mm tip
180mm, 7"

	700-600-195
--	-------------



Bipolar Forceps, knee angled, pointed tip

165mm, 6 ¹ / ₂ "	700-600-160
220mm, 8 ² / ₃ "	700-600-220
0.5mm tip	
165mm, 6 ¹ / ₂ "	700-600-165
220mm, 8 ² / ₃ "	700-600-225
1.0mm tip	
165mm, 6 ¹ / ₂ "	700-600-161
220mm, 8 ² / ₃ "	700-600-221

NON-STICK FORCEPS

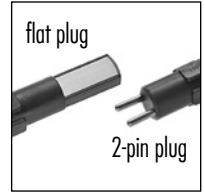

Straight		150mm		180mm		200mm	220mm
		straight tip	angled tip	straight tip	angled tip	straight tip	straight tip
0.3mm tip (point)	flat plug	700-610-150	700-611-150	700-610-180	700-611-180	700-610-200	700-610-220
	2-pin	700-612-150	700-613-150	700-612-180	700-613-180	700-612-200	700-620-220
0.6mm tip (blunt)	flat plug	700-620-150	700-621-150	700-620-180	700-621-180	700-620-200	700-620-220
	2-pin	700-622-150	700-623-150	700-622-180	700-623-180	700-622-200	700-622-220
1.0mm tip (blunt)	flat plug	700-630-150	700-631-150	700-630-180	700-631-180	700-630-200	700-630-220
	2-pin	700-632-150	700-633-150	700-632-180	700-633-180	700-632-200	700-632-220
2.0mm tip (blunt)	flat plug	700-640-150	700-641-150	700-640-180	700-641-180	700-640-200	700-640-220
	2-pin	700-642-150	700-643-150	700-642-180	700-643-180	700-642-200	700-642-220



JEWELER TYPE		110mm	
		straight tip	angled tip
0.25mm tip (point)	flat plug	700-601-710	700-601-730
	2-pin	700-601-711	700-601-731
0.6mm tip (blunt)	flat plug	700-601-712	700-601-732
	2-pin	700-601-713	700-601-733
1.0mm tip (blunt)	flat plug	700-601-714	700-601-734
	2-pin	700-601-715	700-601-735



straight tip

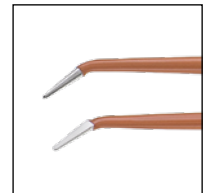

angled tip

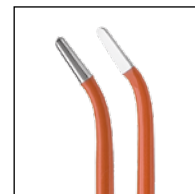

angled down tip

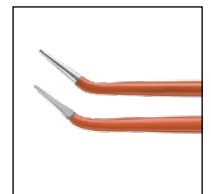

angled up tip

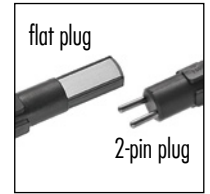

Bayonet Shape		180mm straight tip	200mm straight tip	220mm straight tip	240mm straight tip
0.3mm tip (point)	flat plug	700-650-180	700-650-200	700-650-220	700-650-240
	2-pin	700-652-180	700-652-200	700-652-220	700-652-240
0.6mm tip (blunt)	flat plug	700-660-180	700-660-200	700-660-220	700-660-240
	2-pin	700-662-180	700-662-200	700-662-220	700-662-240
1.0mm tip (blunt)	flat plug	700-670-180	700-670-200	700-670-220	700-670-240
	2-pin	700-672-180	700-672-200	700-672-220	700-672-240
2.0mm tip (blunt)	flat plug	700-680-180	700-680-200	700-680-220	700-680-240
	2-pin	700-682-180	700-682-200	700-682-220	700-682-240

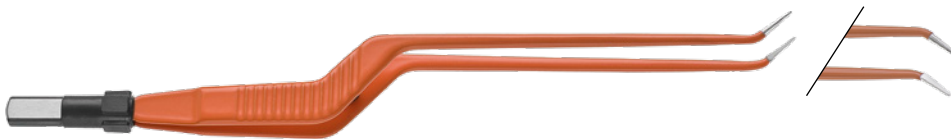

Bayonet Shape, angled up/angled down		200mm angled up tip	220mm angled up tip	200mm angled down tip	220mm angled down tip
1.0mm tip (blunt)	flat plug	700-670-201	700-670-221	700-670-203	700-670-223
	2-pin	700-672-201	700-672-221	700-672-203	700-672-223

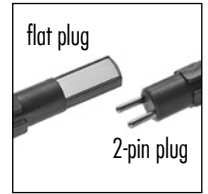

NON-STICK FORCEPS, ROUND HANDLE



Straight		150mm		180mm	
		straight tip	angled tip	straight tip	angled tip
0.3mm tip (point)	flat plug	700-010-150	700-011-150	700-010-180	700-011-180
	2-pin	700-012-150	700-013-150	700-012-180	700-013-180
0.6mm tip (blunt)	flat plug	700-020-150	700-021-150	700-020-180	700-021-180
	2-pin	700-022-150	700-023-150	700-022-180	700-023-180
1.0mm tip (blunt)	flat plug	700-030-150	700-031-150	700-030-180	700-031-180
	2-pin	700-032-150	700-033-150	700-032-180	700-033-180
2.0mm tip (blunt)	flat plug	700-040-150	700-041-150	700-040-180	700-041-180
	2-pin	700-042-150	700-043-150	700-042-180	700-043-180

Straight		200mm		225mm	
		straight tip	angled tip	straight tip	angled tip
0.3mm tip (point)	flat plug	700-010-200	700-011-200	700-010-220	700-011-220
	2-pin	700-012-200	700-013-200	700-012-220	700-013-220
0.6mm tip (blunt)	flat plug	700-020-200	700-021-200	700-020-220	700-021-220
	2-pin	700-022-200	700-023-200	700-022-220	700-023-220
1.0mm tip (blunt)	flat plug	700-030-200	700-031-200	700-030-220	700-031-220
	2-pin	700-032-200	700-033-200	700-032-220	700-033-220
2.0mm tip (blunt)	flat plug	700-040-200	700-041-200	700-040-220	700-041-220
	2-pin	700-042-200	700-043-200	700-042-220	700-043-220



straight tip

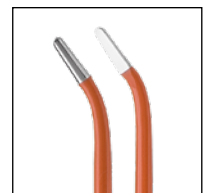

angled down tip

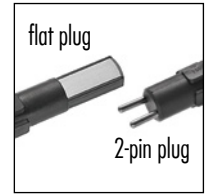

Bayonet		180mm straight tip	200mm straight tip
0.3mm tip (point)	flat plug	700-050-180	700-050-200
	2-pin	700-052-180	700-052-200
0.6mm tip (blunt)	flat plug	700-060-180	700-060-200
	2-pin	700-062-180	700-062-200
1.0mm tip (blunt)	flat plug	700-070-180	700-072-200
	2-pin	700-072-180	700-072-200
2.0mm tip (blunt)	flat plug	700-080-180	700-082-200
	2-pin	700-082-180	700-082-200
Bayonet		225mm straight tip	250mm straight tip
0.3mm tip (point)	flat plug	700-050-220	700-050-250
	2-pin	700-052-220	700-052-250
0.6mm tip (blunt)	flat plug	700-060-220	700-060-250
	2-pin	700-062-220	700-062-250
1.0mm tip (blunt)	flat plug	700-070-220	700-070-250
	2-pin	700-072-220	700-072-250
2.0mm tip (blunt)	flat plug	700-080-220	700-080-250
	2-pin	700-082-220	700-082-250



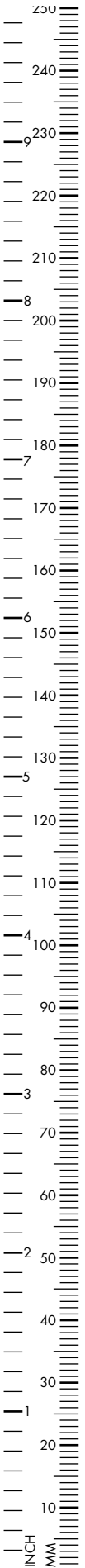

SINUSCOPY



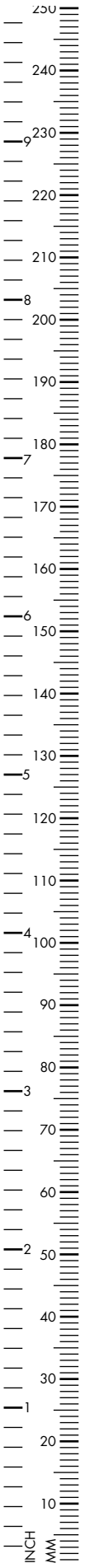

LICHTWITZ-BIER

Antrum Trocar Needle, 100mm, 4"

Ø 1.5mm	252-015-110
Ø 1.8mm	252-018-110
Ø 2.0mm	252-020-110



EICKEN

Antrum Trocar Needle, 105mm, 4¹/₈"

Ø 1.5mm	252-115-110
Ø 1.8mm	252-118-110
Ø 2.0mm	252-120-110
Ø 2.5mm	252-125-110



LICHTWITZ

Antrum Trocar, 85mm working length

Ø 1.8mm	165-052-018
---------	-------------

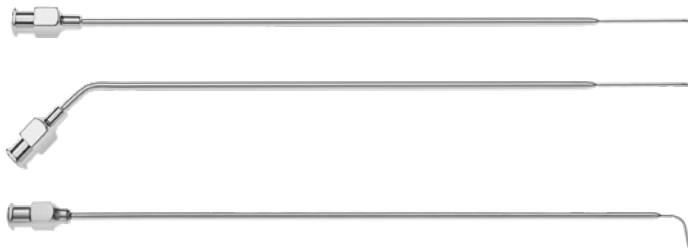

Septum Needle, with LuerLock attachment,
Ø 0.8mm

straight	252-005-170
angled	252-003-170
angled tip	252-004-170

**BABY-EICKEN**Antrum Cannula, 90mm, 3¹/₂"

1.2mm	252-009-012
1.5mm	252-009-015
2.0mm	252-009-020

**EICKEN**Antrum Cannula, slightly curved,
130mm, 5¹/₈"

Ø 2.5mm	252-025-150
Ø 3.0mm	252-025-151
Ø 4.0mm	252-025-152

**EICKEN**Antrum Cannula with central opening, curved,
140mm, 5¹/₂"

Ø 2.5mm	252-125-150
Ø 3.0mm	252-125-151
Ø 4.0mm	252-125-152

**EICKEN**Antrum Cannula, cut-off-hole, 150mm, 6"
strongly curved

Ø 2.5mm	252-225-150
Ø 3.0mm	252-225-151
Ø 4.0mm	252-225-152

slightly curved

Ø 2.5mm	252-325-150
Ø 3.0mm	252-325-151
Ø 4.0mm	252-325-152

slightly curved, malleable

Ø 2.5mm	252-425-150
Ø 3.0mm	252-425-151
Ø 4.0mm	252-425-152

**EICKEN**

Sinus Suction Tube with cut-off hole,
145mm, 5³/₄"

Ø 2.5mm	252-725-150
Ø 3.0mm	252-725-151
Ø 4.0mm	252-725-152

**PASQUINI**

Sinus Suction Tube with olive tip

Ø 2.5mm	252-825-150
Ø 3.0mm	252-825-151
Ø 4.0mm	252-825-152



Suction Tube straight, mit olive Ø 2.5mm,
without cut off hole, malleable

150mm, 6"	252-525-155
-----------	-------------

**FERGUSON**

Suction Tube, 180mm, 7"

Ø 1.6mm, 5 Charr.	165-525-005
Ø 2.0mm, 6 Charr.	165-525-006
Ø 2.3mm, 7 Charr.	165-525-007
Ø 2.5mm, 8 Charr.	165-525-008
Ø 3.0mm, 9 Charr.	165-525-009
Ø 3.3mm, 10 Charr.	165-525-010
Ø 3.6mm, 11 Charr.	165-525-011
Ø 4.0mm, 12 Charr.	165-525-012
Ø 5.0mm, 15 Charr.	165-525-015

**FRAZIER**

30° angled, with button tip, 100mm, 4"

6 Charr.	165-523-306
8 Charr.	165-523-308
10 Charr.	165-523-310
12 Charr.	165-523-312
15 Charr.	165-523-315

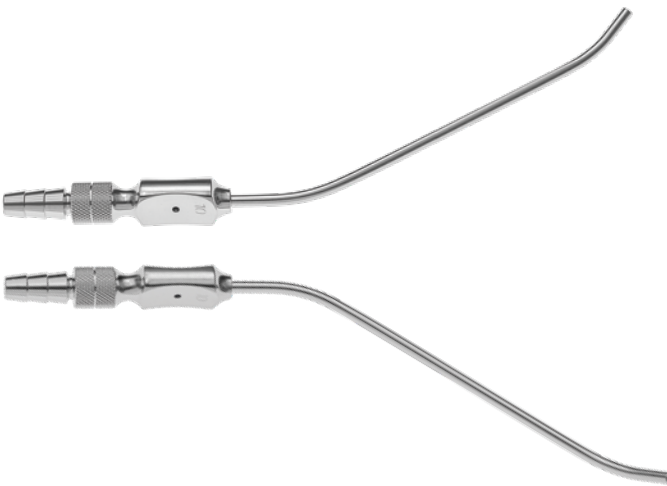
**FRAZIER**

10 Charr., 100mm, 4"

left curved	165-523-401
right curved	165-523-402

**KAHN-FRAZIER**10 Charr., s-shaped,
150mm / 6" working length

Fig. 1 slightly curved	165-523-511
Fig. 2 strongly curved	165-523-512



FISCH

Suction/Irrigation Tube, 2.5 x 2.0mm

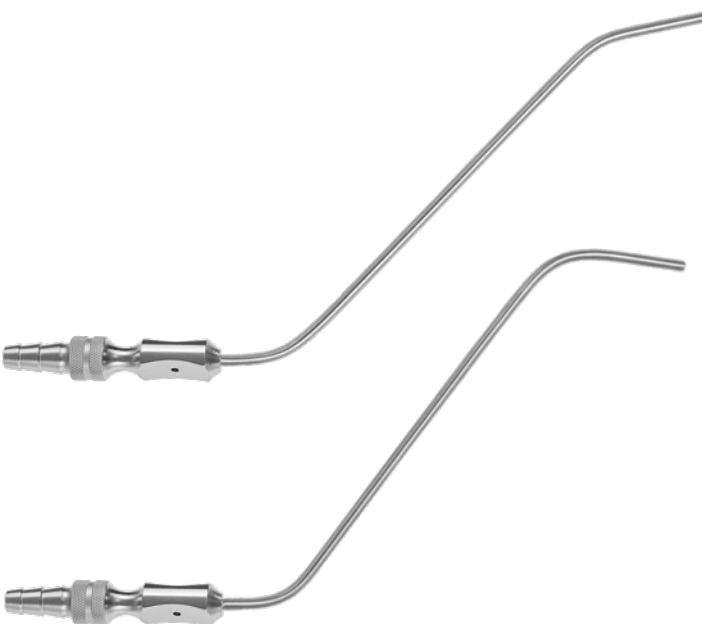
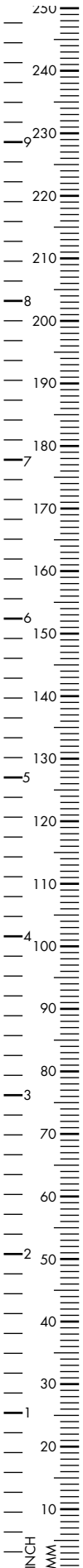
180mm, 7" 252-025-180



SIEBENMANN

Irrigation Antrum Cannula, blunt, Ø 2.5mm
130mm, 5 1/8"

inside opening 165-071-025

outside opening 165-072-025



RITTER

Frontal Sinus Bougie, 160mm, 6 1/4"

Ø 2.5 mm 252-043-025

Ø 3.0 mm 252-043-030

Ø 4.0 mm 252-043-040

Ø 5.0 mm 252-043-050



Antrum Trephine, american pattern

180mm, 7"

sharp 252-050-180

blunt 252-052-180



MUELLER

Antrum Rasp, diamond dusted tip,
205mm, 8 1/8" fine,

3mm 252-051-003

4mm 252-051-004

coarse

3mm 252-053-003

4mm 252-053-004

**KUHN-BOLGER**

Double Instrument, hook angled to the right

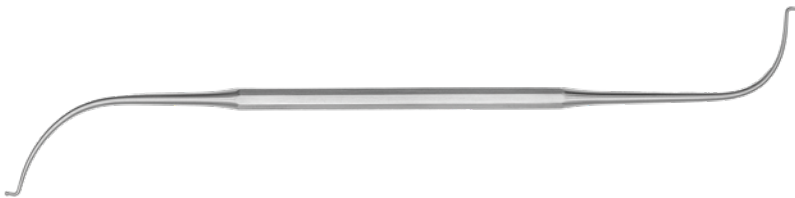
210mm, 8^{1/4}" 252-025-210**KUHN-BOLGER**Double Instrument, probes angled to side
70°/90°210mm, 8^{1/4}" 252-026-210Double Instrument, Ostium probe, double-ended
ball probe: 1.2mm / 2.0 mm210mm, 8^{1/4}" 252-025-190**FREER**Septum Elevator, double-ended,
semi-blunt/blunt

200mm, 8" 252-001-200

**SEWALL**

Antrum Elevator, blunt, 6mm

200mm, 8" 420-549-200

**PLESTER**

Sickle knife, slightly curved blade

160mm, 6^{1/4}" 410-101-160

Sickle knife, sharp, 200mm, 8"

sharp 252-205-190

blunt 252-215-190

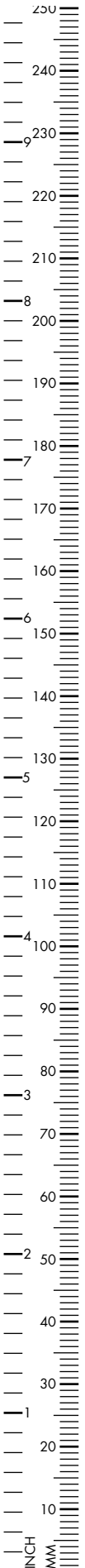

HALLE

Antrum Curette, malleable, 210mm, 8^{1/4}"

Fig. 1 252-081-210

Fig. 2 252-082-210

Fig. 3 252-083-210



Antrum Spoon, oval, 200mm, 8"

Fig. 1, 7mm 252-071-190

Fig. 2, 8mm 252-082-190

Fig. 3, 9mm 252-093-190



Antrum Spoon, 200mm, 8"

round, 45° curved 252-171-190

oval, small, curved 252-182-190

oval, large, 30° angled 252-193-190



PRATT

Ethmoid Curette, double-ended

190mm, 7^{1/2}" 252-008-190

**KUHN-BOLGER**Antrum Spoon, 190mm, 7^{1/2}"

55° curved 252-172-190

90° curved 252-173-190

**UFFENDORDE**Bone Curette, 170mm, 6^{2/3}"

45° angled right 210-345-007

45° angled left 210-347-007

**FAULKNER**

Antrum Curette

220mm, 8^{2/3}" 252-071-220**FAULKNER**Antrum Curette, malleable, 220mm, 8^{2/3}"

5 x 9mm ring 252-071-222

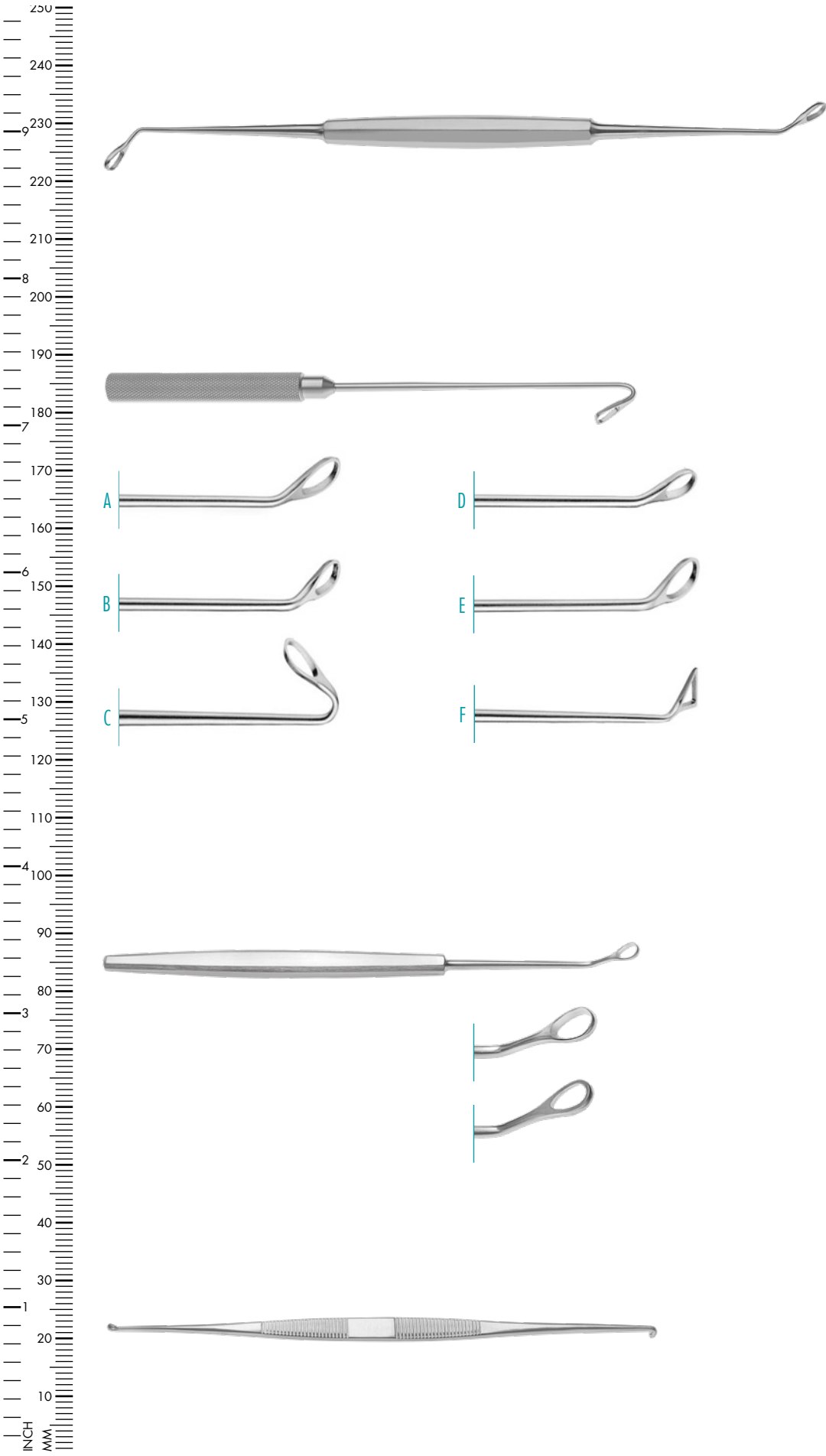

HALLE

Antrum Curette

245mm, 9²/₃"

252-072-063

COAKLEY

Antrum Curette, rigid shank, 170mm, 6²/₃"

- A Fig. 1 252-072-001
- B Fig. 2 252-072-002
- C Fig. 3 252-072-003
- D Fig. 4 252-072-004
- E Fig. 5 252-072-005
- F Fig. 6 252-072-006

COAKLEY

Antrum Curette, small size, 200mm, 8"

forward cutting 252-113-190

backward cutting 252-114-190

Curette, double-ended, oval, short curve 45°, semi-sharp, 2.2mm
other side: 90° long curve, 2.7mm

190mm, 7¹/₂" 252-027-190

**RIBBON**

Retractor, malleable

200 x 6mm	170-973-006
200 x 12mm	170-973-012
200 x 17mm	170-973-017
200 x 20mm	170-973-020
250 x 25mm	170-973-025

**TUFFIER**

Retractor, malleable

200 x 25mm	170-975-250
------------	-------------



Orbital Protector

235mm, 9 ¹ / ₄ "	252-042-235
--	-------------



Antrum Punch, 3.5 x 3.7mm bite,
110mm / 4¹/₃" working length

65° forward biting 252-150-110

30° upwards cutting 252-151-110



HAJEK-KOFLER

Sphenoid Punch, 3.5 x 3.7mm, 360° rotating

170mm, 6²/₃" 252-535-170



MCKENTY

Sphenoid Punch, rotating, through cutting,
1.8 x 2.0mm

120mm, 4³/₄" 252-147-120

1.6 x 2.0mm

170mm, 6²/₃" 252-146-170

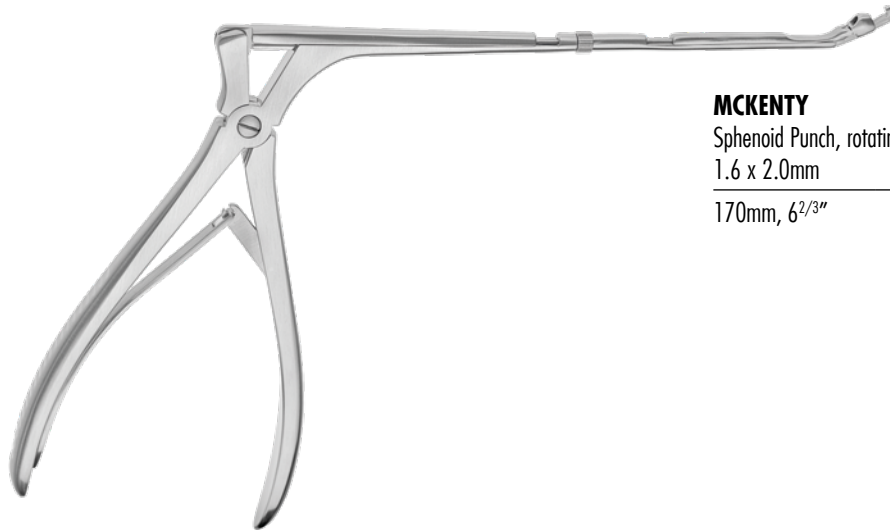
**MCKENTY**

Sphenoid Punch, rotating, upwards cutting,
1.6 x 2.0mm

170mm, 6²/₃" 252-151-170

**CITELLI**

Bone punch, 1.5 mm, through cutting

170mm, 6²/₃" 252-147-170

**BEYER**

Bone punch, 2.0 mm, through cutting

170mm, 6²/₃" 252-148-170

**HAJEK-KOFLER**

Bone Nibbler, 3.5 x 3.5mm,
140mm, 5¹/₂"

upbiting 252-145-001

downbiting 252-145-002

upbiting, backward 252-145-003

downbiting, backward 252-145-004

upbiting, forward 252-145-005

upbiting, 4.5 x 4.5mm 252-146-001



KERRISON

Punch, regular handle, superflat footplate



180mm, 7"
40° upwards cutting

1mm	250-400-181SF
1.5mm	250-400-189SF
2mm	250-400-182SF
3mm	250-400-183SF
4mm	250-400-184SF
5mm	250-400-185SF



180mm, 7"
40° downwards cutting

1mm	250-420-181SF
1.5mm	250-420-189SF
2mm	250-420-182SF
3mm	250-420-183SF
4mm	250-420-184SF
5mm	250-420-185SF

180mm, 7"
90° upwards cutting

1mm	250-411-181SF
2mm	250-411-182SF
3mm	250-411-183SF
4mm	250-411-184SF
5mm	250-411-185SF

180mm, 7"
90° downwards cutting

1mm	250-430-181SF
2mm	250-430-182SF
3mm	250-430-183SF
4mm	250-430-184SF
5mm	250-430-185SF

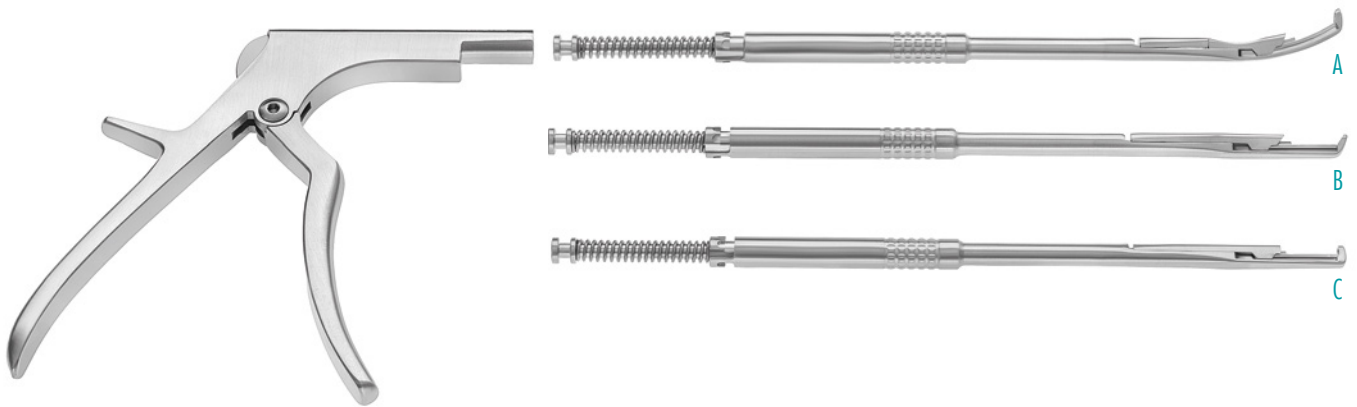

Handle only

250-245-000

A 360° Foraminotomy Punch
exchangeable shaft, ejector, thin footplate
40° angled

180mm, 7"		200mm, 8"	
2mm	250-280-182	2mm	250-280-202
3mm	250-280-183	3mm	250-280-203
4mm	250-280-184	4mm	250-280-204
5mm	250-280-185	5mm	250-280-205

B 360° Laminectomy Punch
exchangeable shaft, ejector, thin footplate
40° angled

180mm, 7"		200mm, 8"	
1mm	250-210-181	1mm	250-210-201
1.5mm	250-210-180	1.5mm	250-210-200
2mm	250-210-182	2mm	250-210-202
3mm	250-210-183	3mm	250-210-203
4mm	250-210-183	4mm	250-210-204
5mm	250-210-185	5mm	250-210-205

C 360° Laminectomy Punch
exchangeable shaft, ejector, thin footplate
90° angled

180mm, 7"		200mm, 8"	
1mm	250-245-181	1mm	250-245-201
1.5mm	250-245-180	1.5mm	250-245-200
2mm	250-245-182	2mm	250-245-202
3mm	250-245-183	3mm	250-245-203
4mm	250-245-184	4mm	250-245-204
5mm	250-245-185	5mm	250-245-205

All instruments are available with CERACUT® coating. Code number + CC (e.g. 250-400-181CC)



Frontal Sinus Punch Forceps, 40° upbiting forward, 2mm, 70° upturned shaft, 140mm, 5 1/2"

2mm bite	252-499-175
3mm bite	252-500-175



Frontal Ostium nasal forceps, 140mm, 5 1/2"

3x3mm, 5mm	252-499-140
2x2mm, 5mm	252-500-140
5x5mm, 5mm	252-501-140

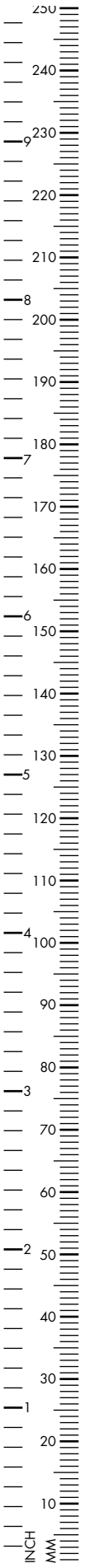



Sinuscope, autoclavable, Ø 4mm,
180mm, 7"

● 0°	252-104-000
● 30°	252-104-030
● 45°	252-104-045
● 70°	252-104-070

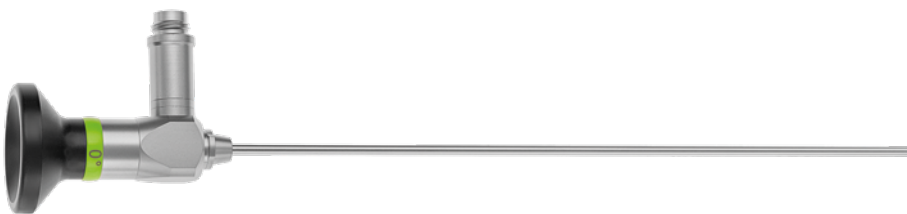

Sinuscope, autoclavable, Ø 2.7mm,
180mm, 7"

● 0°	252-127-000
● 30°	252-127-030
● 70°	252-127-070



Sinuscope, autoclavable, Ø 2.7mm,
110mm, 4¹/₃"

● 0°	252-127-200
● 30°	252-127-230

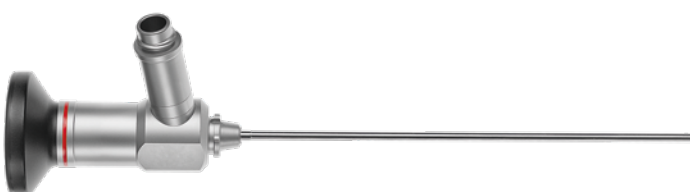

Sinuscope, Ø 3.0mm,
140mm, 5¹/₂"

0°	252-130-000
30°	252-130-030
45°	252-130-045
70°	252-130-070

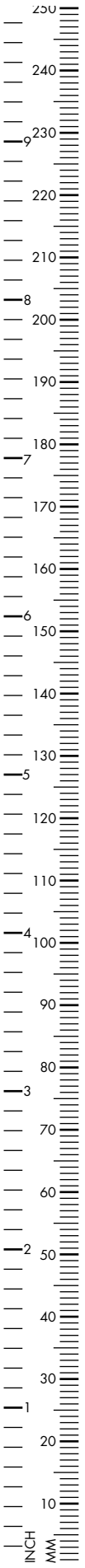

Flat Handle for Sinusscopes, 120mm, 4^{3/4}"

for Ø 4.0mm	251-104-001
for Ø 2.7mm	251-127-001



Round Handle for Sinusscopes, 120mm, 4^{3/4}"

for Ø 4.0mm	251-104-002
for Ø 2.7mm	251-127-002

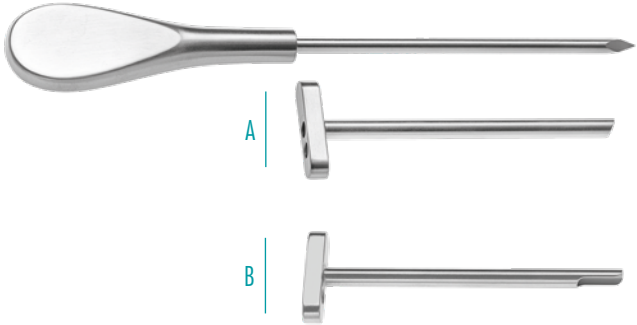

Sinuscopy Trocar and Sheath, Ø 5.2mm, 85mm working length, sharp for 4mm scopes

A oblique end	251-104-120
B duckbill tip	251-105-120

for 2.7mm scopes

A oblique end	251-127-120
---------------	-------------



Biopsy and Grasping Forceps,
3 x 6mm oval cup

90mm, 3¹/₂" 252-503-090

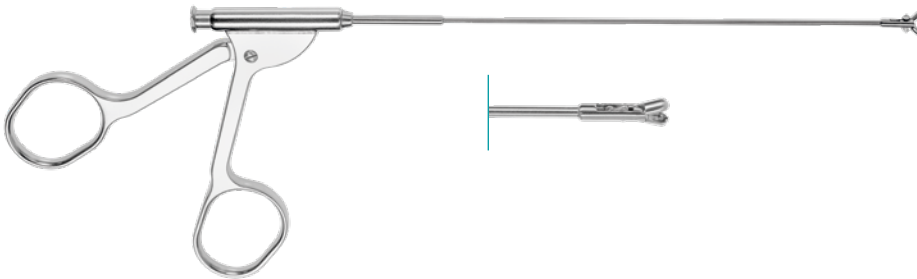

Biopsy and Grasping Forceps, delicate pattern,
3 mm oval cup

140mm, 5¹/₂" 252-503-140



Biopsy and Grasping Forceps, malleable shaft,
4mm biopsy cup, vertical opening

180mm, 7" 252-174-180

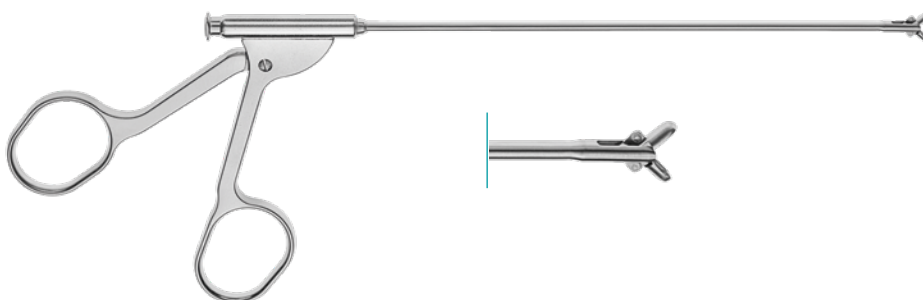

Biopsy and Grasping Forceps,
3mm round cup, straight

150mm, 6" 252-503-150

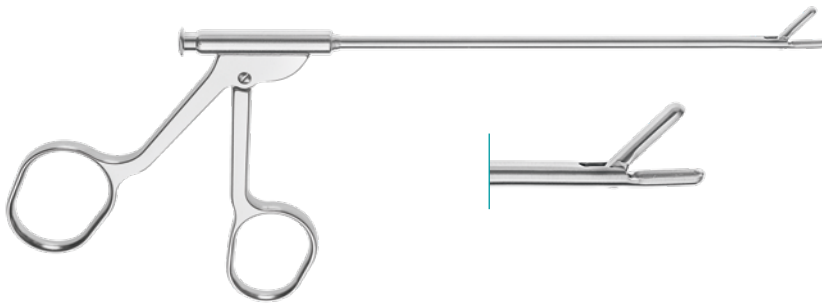
**TAKAHASHI**

Ethmoidal Forceps, 3 x 10mm

130mm, 5¹/₈"

252-002-130

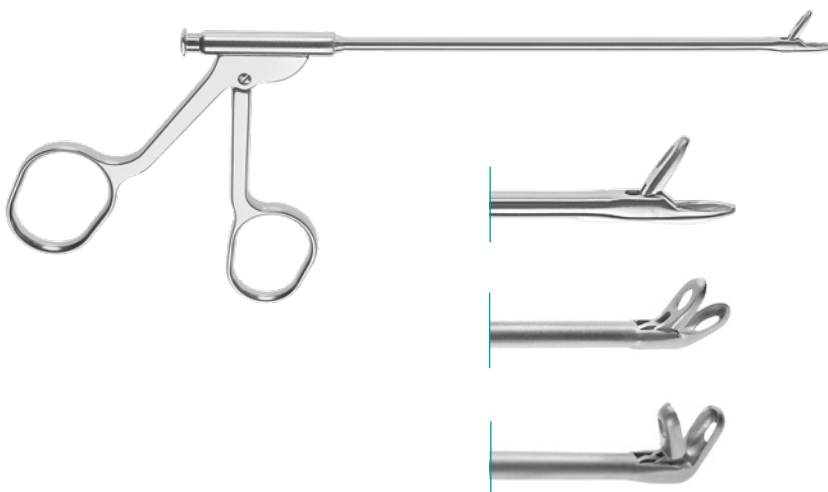
**BLAKESLEY**Ethmoidal Forceps, straight, 130mm, 5¹/₈"

Size 0, 2.5mm

252-034-130

Size 1, 3.0mm

252-034-131

Size 2, 3.5mm

252-034-132

Size 3, 4.0mm

252-034-133

Size 4, 5.0mm

252-034-134

Size 5, 6.0mm

252-034-135

BLAKESLEY-WILDE

45° curved up

Size 0, 2.5mm

252-035-130

Size 1, 3.0mm

252-035-131

Size 2, 3.5mm

252-035-132

Size 3, 4.0mm

252-035-133

Size 4, 5.0mm

252-035-134

Size 5, 6.0mm

252-035-135

BLAKESLEY-WILDE

90° curved up

Size 0, 2.5mm

252-037-130

Size 1, 3.0mm

252-037-131

Size 2, 3.5mm

252-037-132

Size 3, 4.0mm

252-037-133

Size 4, 5.0mm

252-037-134

Size 5, 6.0mm

252-037-135

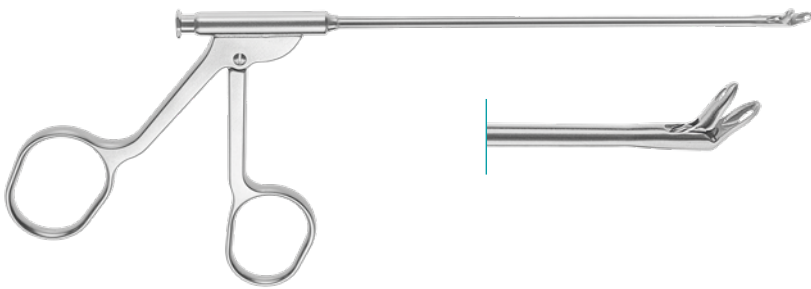
**STRUEMPEL-VOSS**

Ethmoidal Forceps, 90° curved to the right,
45° upwards, 130mm, 5¹/₈"

Size 1	252-036-131
Size 2	252-036-132

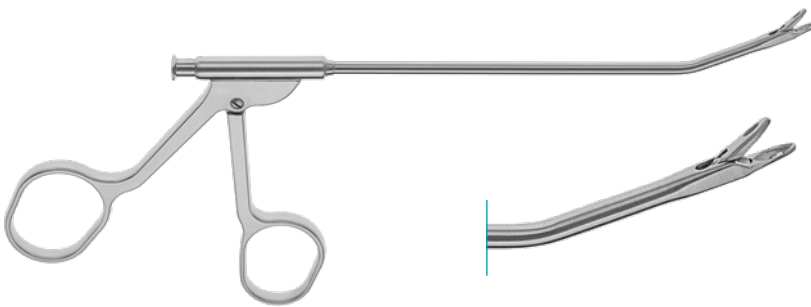
**BLAKESLEY**

Spoon Forceps, 2.7mm straight,
130mm working length

25°	252-234-130
45°	252-234-131

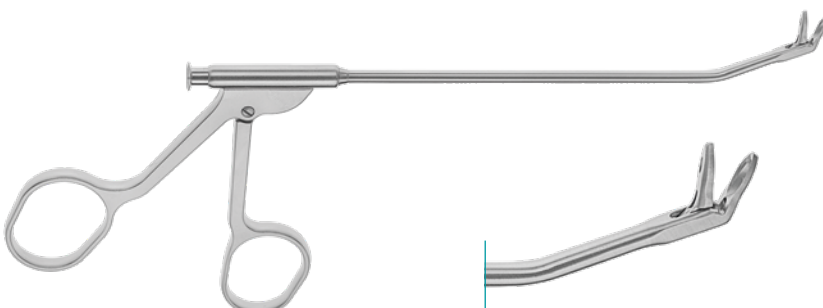
**BLAKESLEY**

Spoon Forceps, 45° curved up
130mm working length

2.7mm	252-235-130
3.0mm	252-235-131
3.5mm	252-235-132

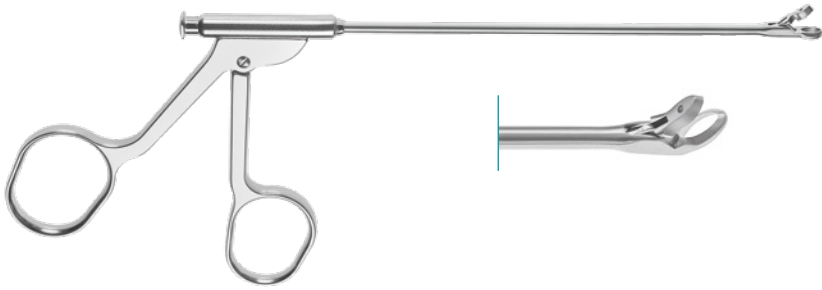
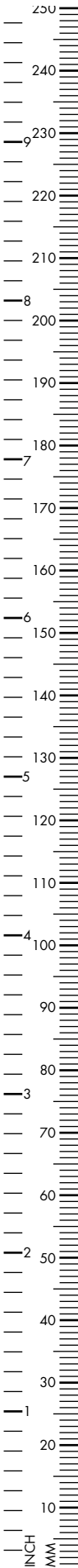

BLAKESLEY

Ethmoidal Forceps, straight, 130mm, 5¹/₈"

Fig. 0, 3.0mm 252-004-130

Fig. 1, 3.5mm 252-004-131

Fig. 2, 4.0mm 252-004-132

45° curved up

Fig. 0, 3.0mm 252-014-130

Fig. 1, 3.5mm 252-014-131

Fig. 2, 4.0mm 252-014-132

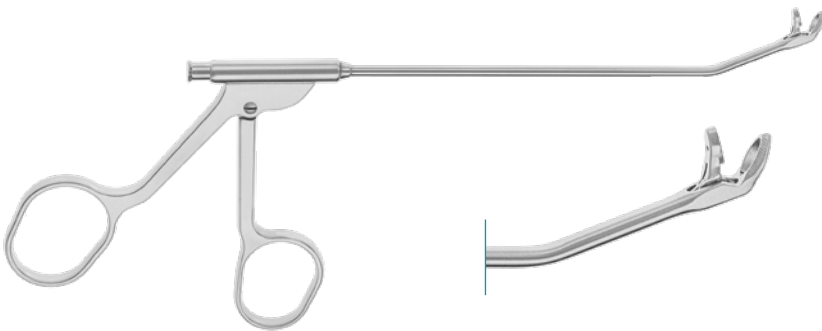

BLAKESLEY

Spoon Forceps, cutting, 2.7mm,
45° angled up, sheath 25° bent up

130mm, 5¹/₈" 252-214-130

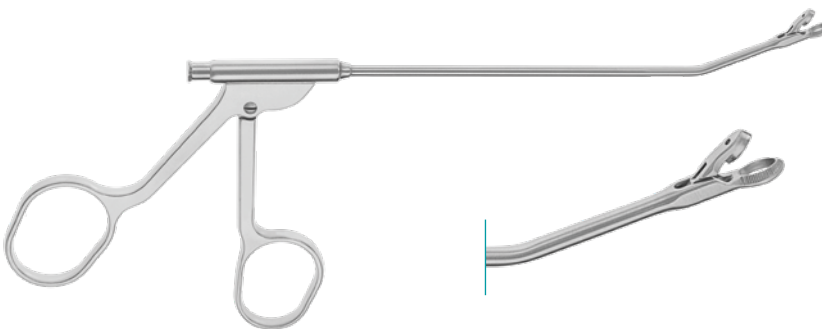

BLAKESLEY

Spoon Forceps, cutting, 2.7mm,
straight sheath, sheath 25° bent up

252-204-130

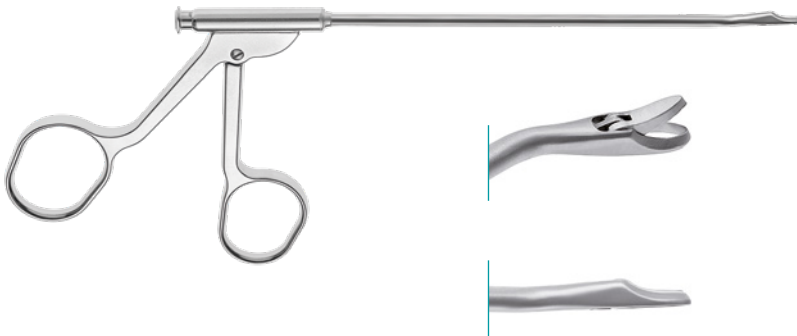
**BLAKESLEY**

Ethmoidal Forceps, through-cutting,
115mm, 4¹/₂"

30° curved left	252-401-025
30° curved right	252-403-025

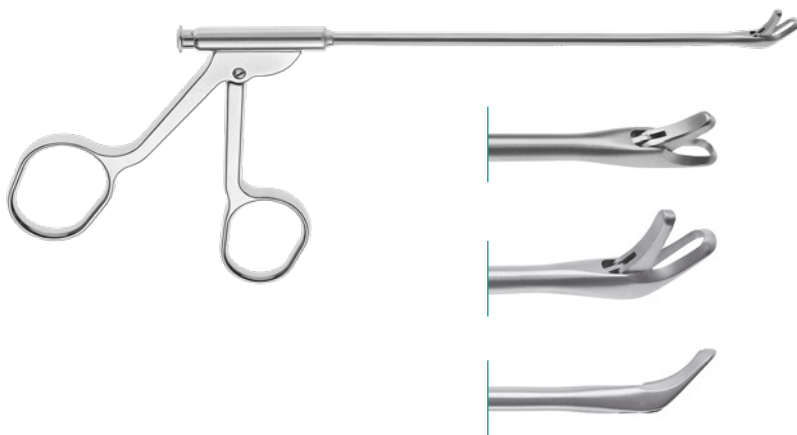
**DUCKBILL**

Duckbill Punch, straight,
130mm, 5¹/₈" working length

Fig. 0, 2.0mm bite	252-206-000
Fig. 1, 2.5mm bite	252-206-001
Fig. 2, 3.0mm bite	252-206-002

upwards curved

Fig. 0, 2.0mm bite	252-207-000
Fig. 1, 2.5mm bite	252-207-001
Fig. 2, 3.0mm bite	252-207-002

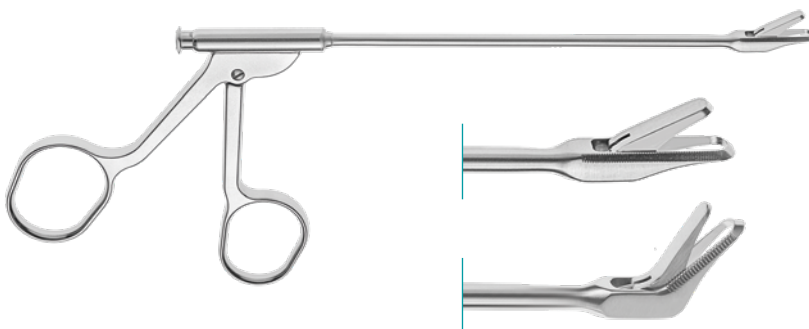
**GRUENWALD-HENKE**

Nasal Forceps, through-cutting,
130mm, 5¹/₈" working length
straight

8.0 x 3.0mm	252-013-130
11.5 x 3.5mm	252-014-135

upcurved

8.0 x 3.0mm	252-013-145
11.5 x 3.5mm	252-014-145

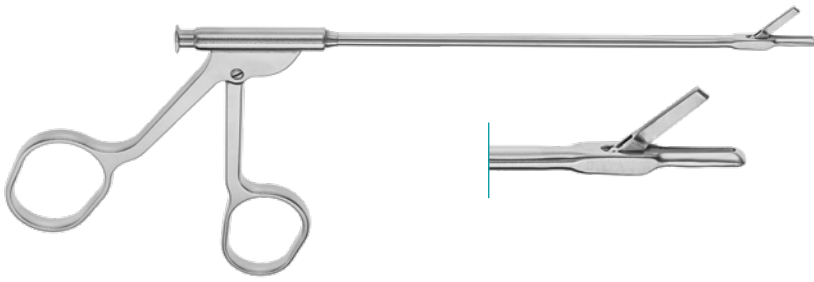
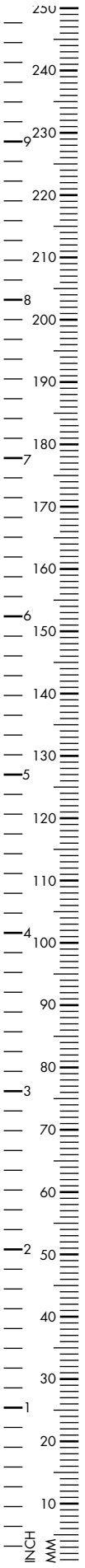

STRUYCKEN

Ethmoidal Forceps

130mm, 5¹/₈"

252-003-130

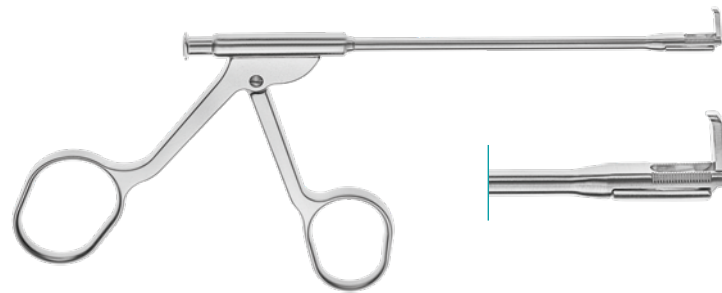

OSTROM

Antrum punch, 2.5mm bite, backwards cutting, 100mm, 4" working length

upside cutting

252-015-100

right side cutting

252-115-100

left side cutting

252-215-100

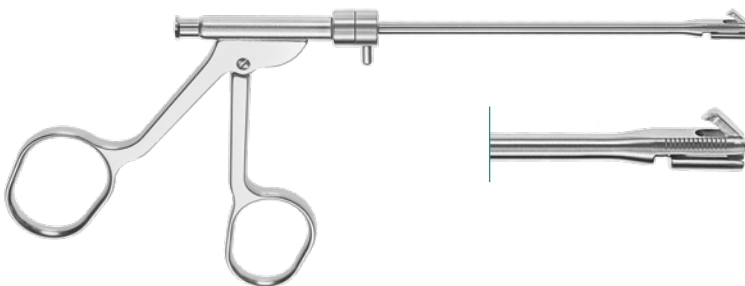

OSTROM

Antrum punch, 2.5mm bite, backwards cutting, 360° rotatable,

100mm, 4" working length

252-315-100

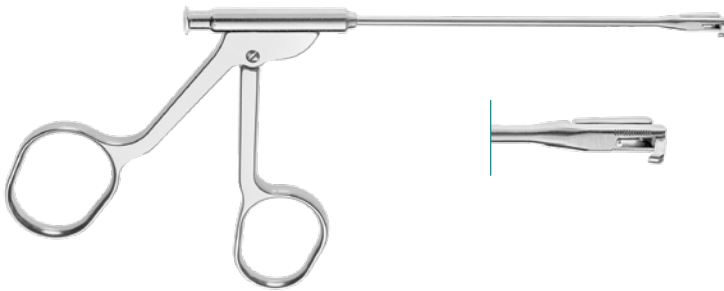
**OSTROM**

Antrum punch, 1.5mm bite, backwards cutting,
100mm, 4" working length

upside cutting	252-010-100
right side cutting	252-110-100
left side cutting	252-210-100

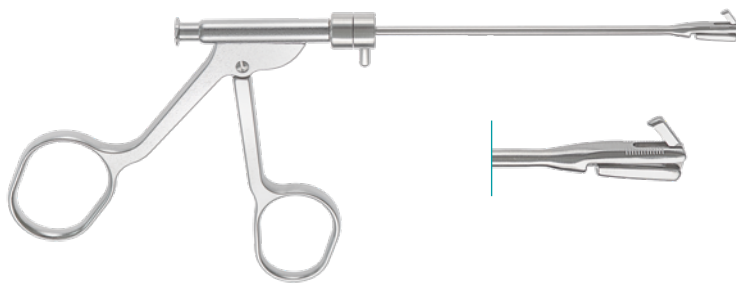
**OSTROM**

Antrum punch, 1.5mm bite, backwards cutting,
360° rotatable

100mm, 4" working length	252-310-100
-----------------------------	-------------

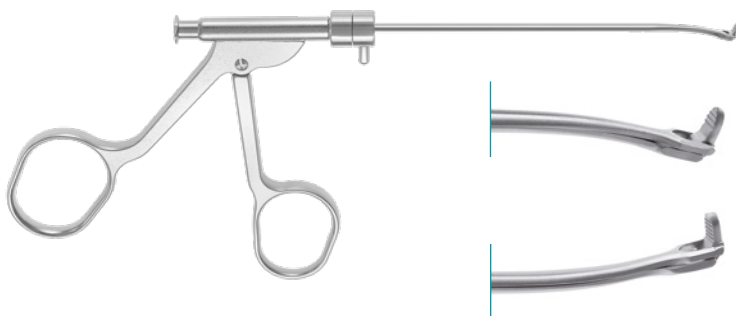
**OSTROM**

Ethmoidal Forceps, rotating, micro bite
100mm, 4"

curved down	252-315-200
curved up	252-315-300

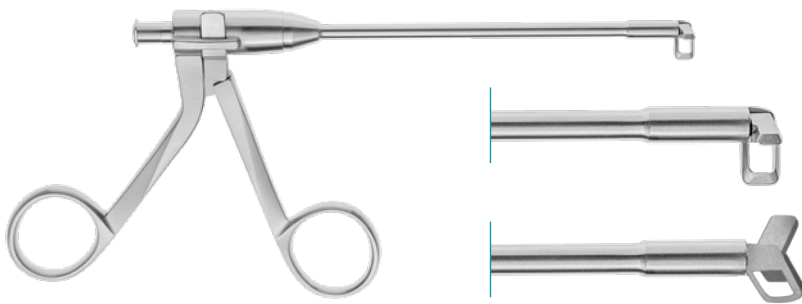
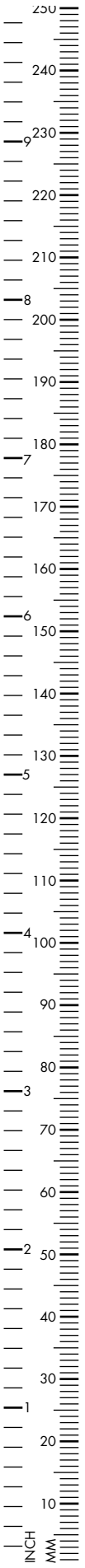

SIDECUTTER

Antrum punch, 3.5mm bite,
100mm, 4" working length

downward right cutting	252-171-100
downward left cutting	252-173-100

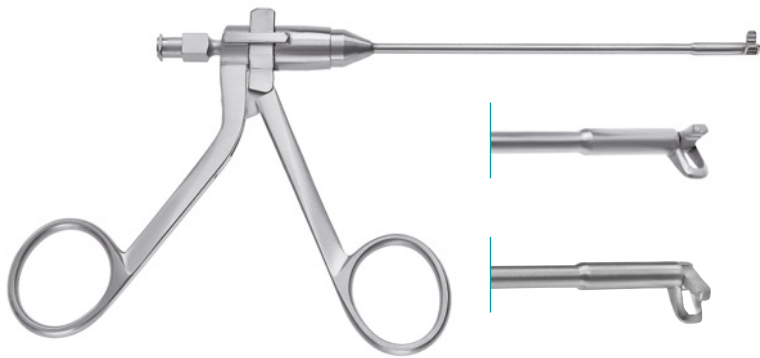

SIDECUTTER

Antrum punch, 2.5mm bite,
100mm, 4" working length

left cutting	252-173-700
right cutting	252-171-700
downward right cutting	252-171-300
downward left cutting	252-173-300

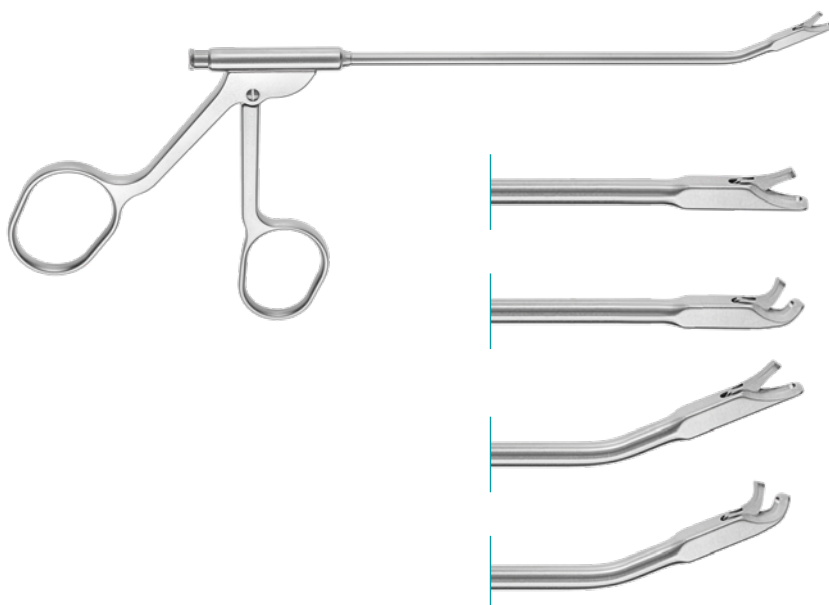

Nasal Forceps, 1.5mm, thru-cutting,
with LuerLock, 130mm, 5^{1/8}" working length

straight shaft	252-020-130
jaws 45° angled up	252-019-130
straight jaws, 30° curved up	252-017-130
30° curved up, jaws 45° angled up	252-015-130

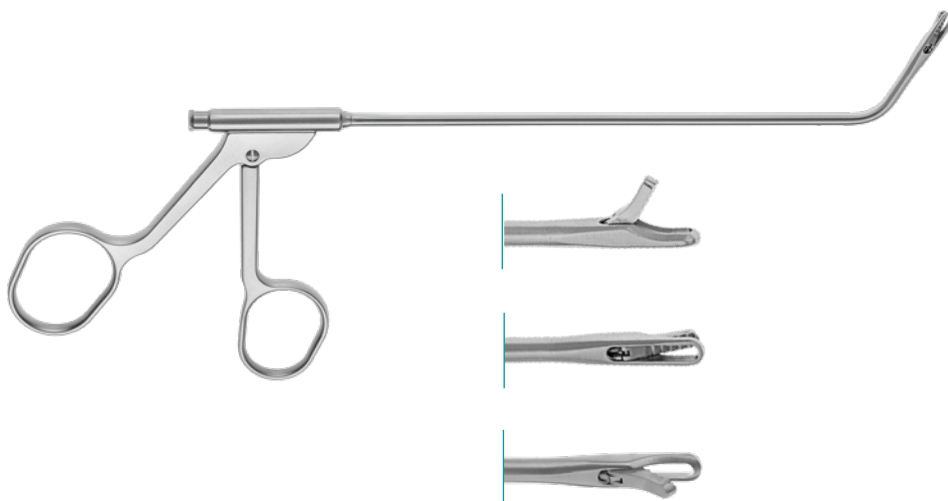

NICOLAI

Antrum Forceps, 2mm bite, 65° curved up

backward opening	252-477-141
left opening	252-477-142
right opening	252-477-143



HEUWIESER

Antrum Grasping Forceps, 90° curved, 130mm, 5¹/₈"

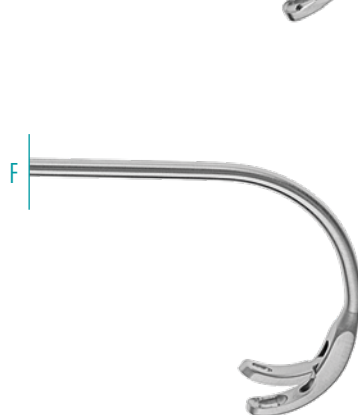

A 120° backward opening	252-410-112
B 120° right opening	252-410-113
C 120° left opening	252-410-111
D 120° upwards angled	252-410-110
E 115° curved, 140° backward opening	252-410-114
F 140° curved, 155° backward opening	252-410-115

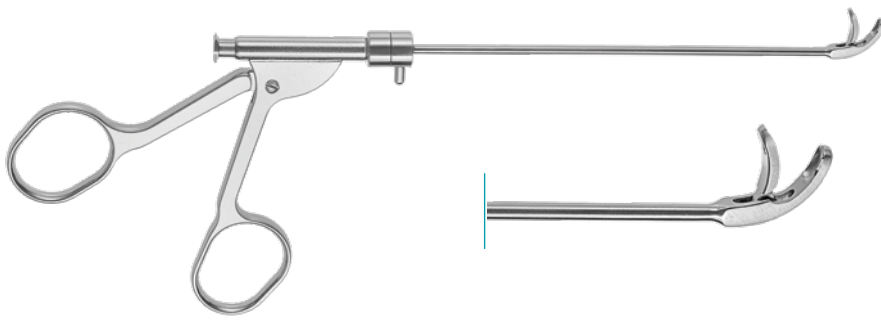
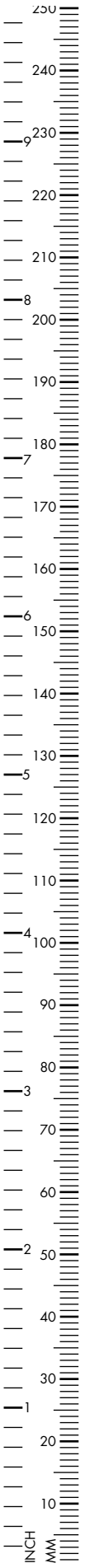

HEUWIESER

Antrum Grasping Forceps, rotating,
130mm, 5¹/₈"

120° curved, 90° backward opening 252-411-112

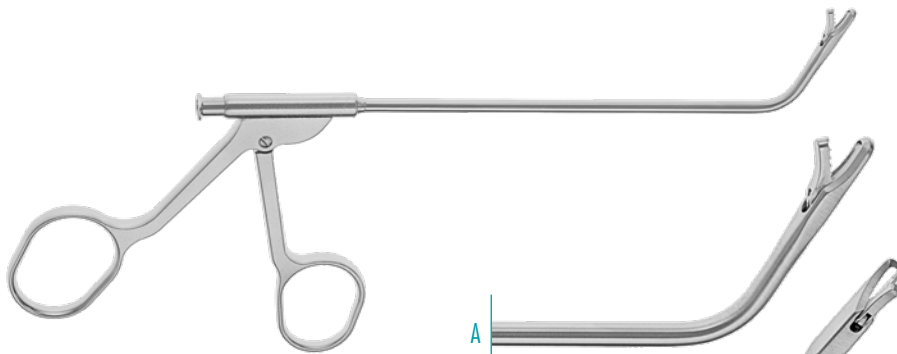

GRÜNWALD

Sinuscopy Forceps, 70° curved up,
2.0mm cut, 130mm, 5¹/₈"

A upside opening 252-600-070

B right side cutting 252-601-070

C left side cutting 252-602-070



KUHN

Ethmoidal Forceps, 60° curved up,
1.5mm cut, through-cutting,
120mm, 4³/₄"

A left 252-415-121

B right 252-415-122

C vertical opening 252-415-120

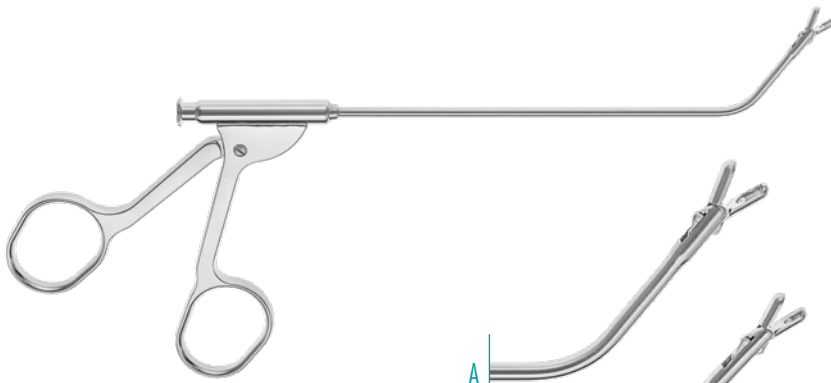

A

B

C

D

KUHN-BOLGERGiraffe Forceps, 55° angled up,
130mm, 5^{1/8}"

A vertical action, 3x6 mm 252-343-120

A vertical action, 2x4 mm 252-342-120

C horizontal action, 3x6 mm 252-353-120

D horizontal action, 2x4 mm 252-352-120



A

B

C

D

RZGiraffe Biopsy Forceps, 4x8mm
130mm, 5^{1/8}"

A 110°, vertical opening 252-570-120

B 70°, vertical opening 252-470-120

C 110°, horizontal opening 252-770-120

D 70°, horizontal opening 252-670-120

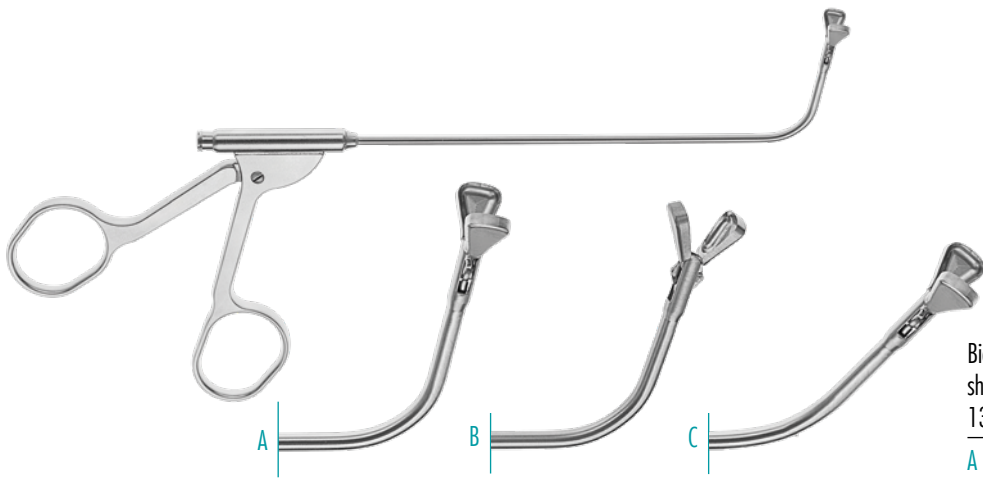

Biopsy Forceps, horizontal opening,
shaft 80° upcurved, pear-shaped
130mm, 5¹/₈"

A horizontal opening	252-473-130
B vertical opening	252-472-130
C 45° horizontal opening	252-471-130

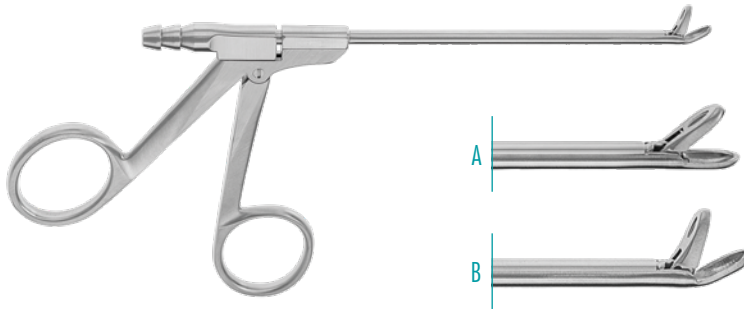

BLAKESLEY

Suction Punch, 3.5mm jaw,
Ø 4.0mm shaft

A straight	252-022-100
B curved up	252-122-100

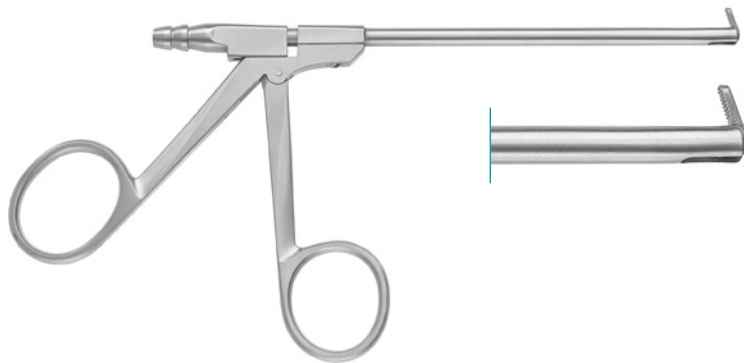

OSTROM

Suction Punch, 2.5mm jaw
Ø 5.0mm shaft

upside	252-015-500
right	252-015-520
left	252-015-510

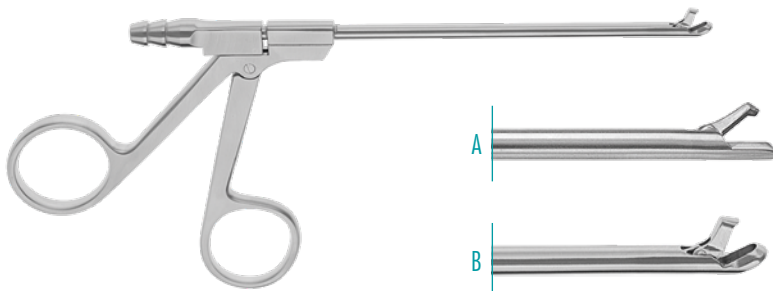

GRUENWALD

Suction Punch, 2.0mm jaw
Ø 4.0mm shaft, through-cutting

A straight	252-502-100
B upcurved	252-502-145

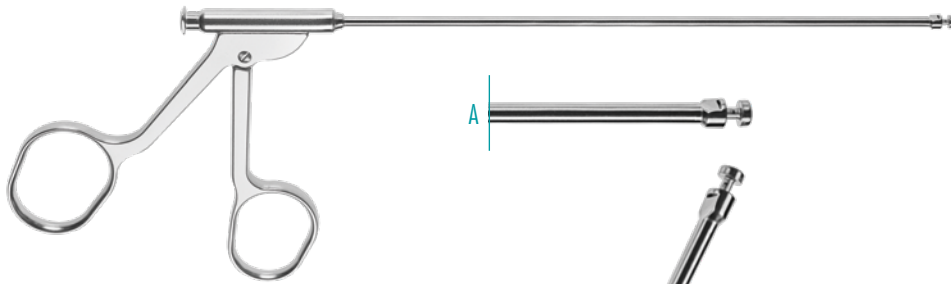

STAMMBERGER

Circular Punch, 160mm, 6¹/₄"

A straight

Ø 3.5mm 252-533-170

Ø 4.5mm 252-536-170

B 65° curved up

Ø 3.5mm 252-534-170

Ø 4.5mm 252-537-170



Circular Punch, 60° curved up, oval,
Ø 3.5mm

160mm, 6¹/₄" 252-537-335

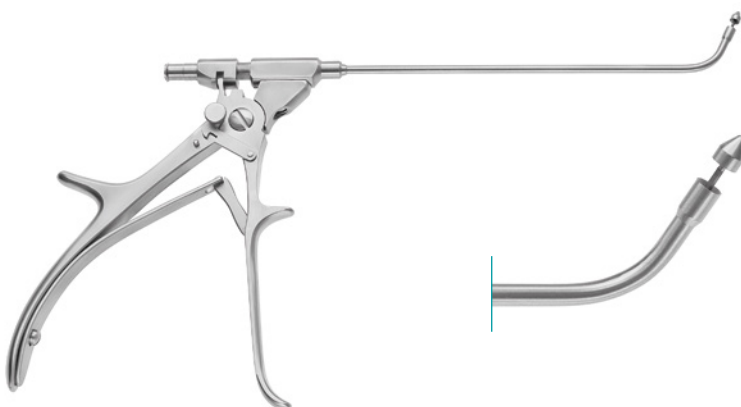

Circular Punch, 70° upturned shaft,
with Luer-Lock

Ø 3.5mm 252-534-270

Ø 4.5mm 252-537-270

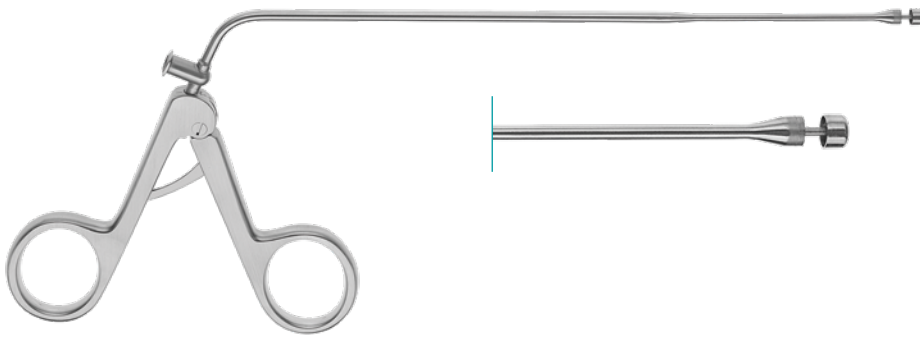

Circular Punch, straight, with Luer-Lock
180mm working length

Ø 3.5mm	252-536-235
Ø 4.5mm	252-536-245

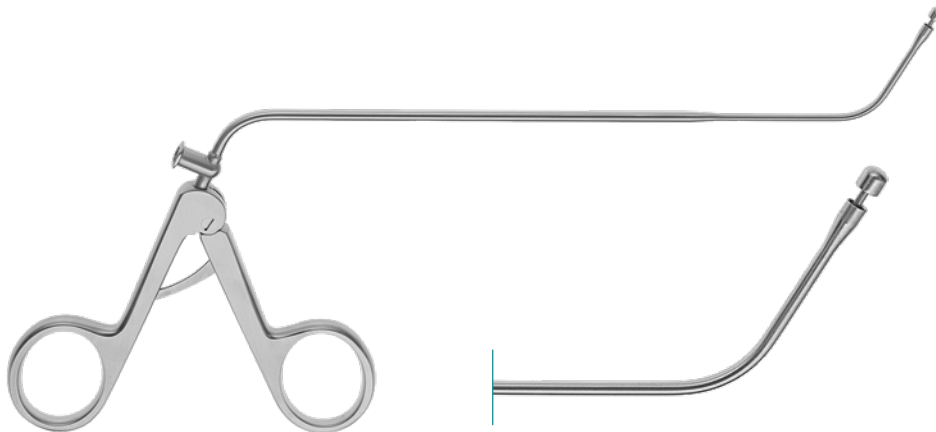

Circular Punch, 60° upcurved, with Luer-Lock
180mm working length

Ø 3.5mm	252-536-435
Ø 4.5mm	252-536-445

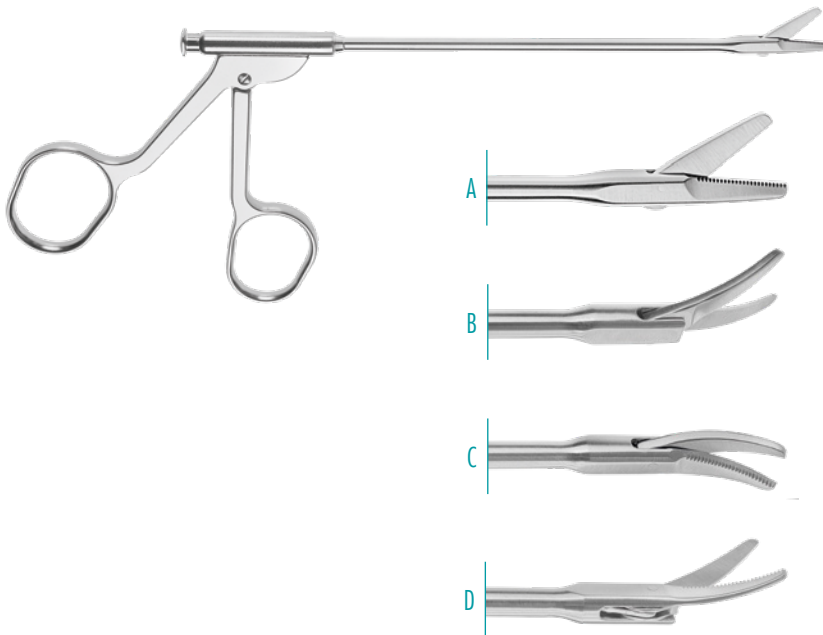

Nasal Scissors, Ø 3.5mm
130mm, 5¹/₈"

A straight	252-023-130
B left curved	252-024-130
C right curved	252-025-130
D curved up	252-026-130



OLIVECRONA

Nasal Scissors, serrated

230mm, 9"	120-208-230
-----------	-------------

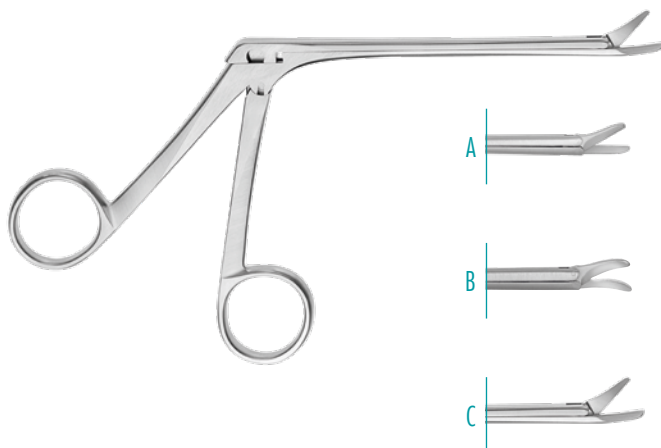

Nasal Scissors, serrated upper blade,
120mm, 4³/₄"

A straight	420-414-120
B right curved	420-415-120
C left curved	420-416-120

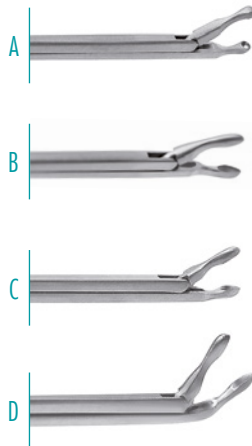
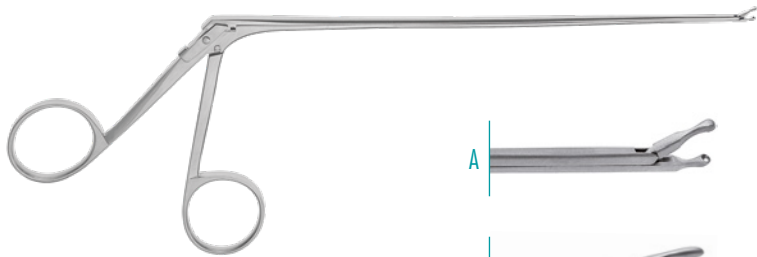
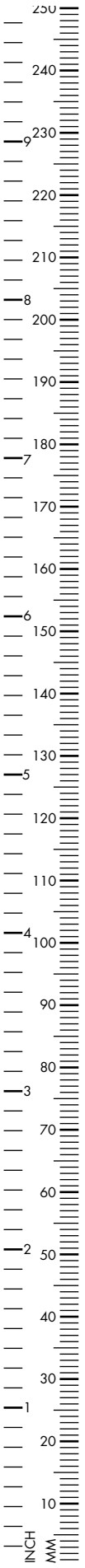

Oval Cup Forceps, 0.6mm jaw
160mm working length

A straight	252-810-160
B right curved	252-811-160
C left curved	252-813-160
D 45° upwards angled	252-815-160

190mm working length

A straight	252-810-190
B right curved	252-811-190
C left curved	252-813-190
D 45° upwards angled	252-815-190

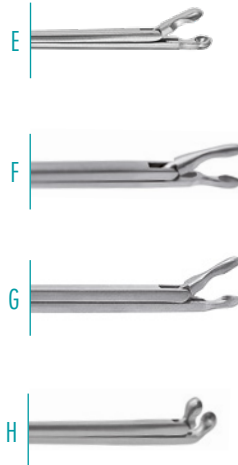
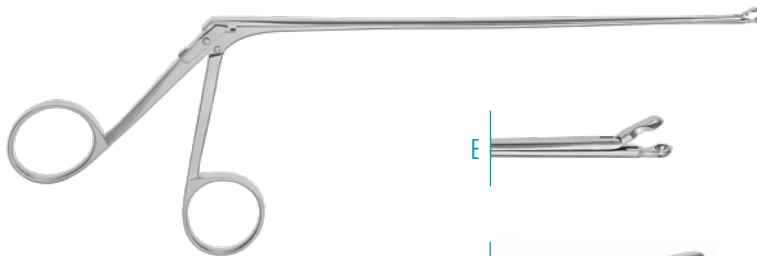

Oval Cup Forceps, 2.5mm jaw
160mm working length

E straight	252-816-160
F right curved	252-817-160
G left curved	252-818-160
H 45° upwards angled	252-819-160

190mm working length

E straight	252-816-190
F right curved	252-817-190
G left curved	252-818-190
H 45° upwards angled	252-819-190

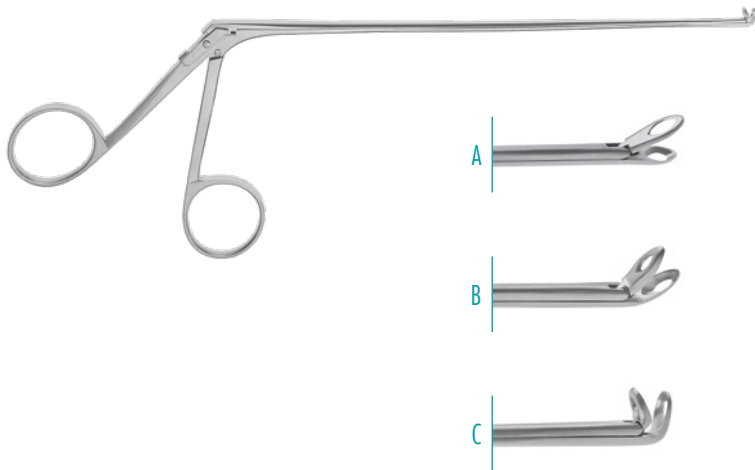
**STRÜMPEL**

Forceps, 2.5 x 7.0mm jaw,
160mm working length

A straight	252-820-160
B 60° upwards	252-821-160
C 90° upwards	252-823-160

190mm working length

A straight	252-820-190
B 60° upwards	252-821-190
C 90° upwards	252-823-190

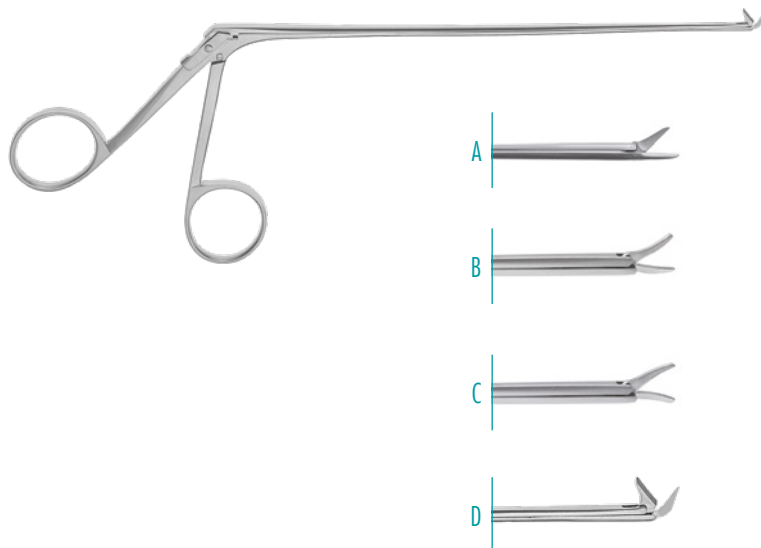

Scissors, 5mm blade,
160mm working length

A straight	252-830-160
B right curved	252-831-160
C left curved	252-833-160
D upwards angled	252-835-160

190mm working length

A straight	252-830-190
B right curved	252-831-190
C left curved	252-833-190
D upwards angled	252-835-190

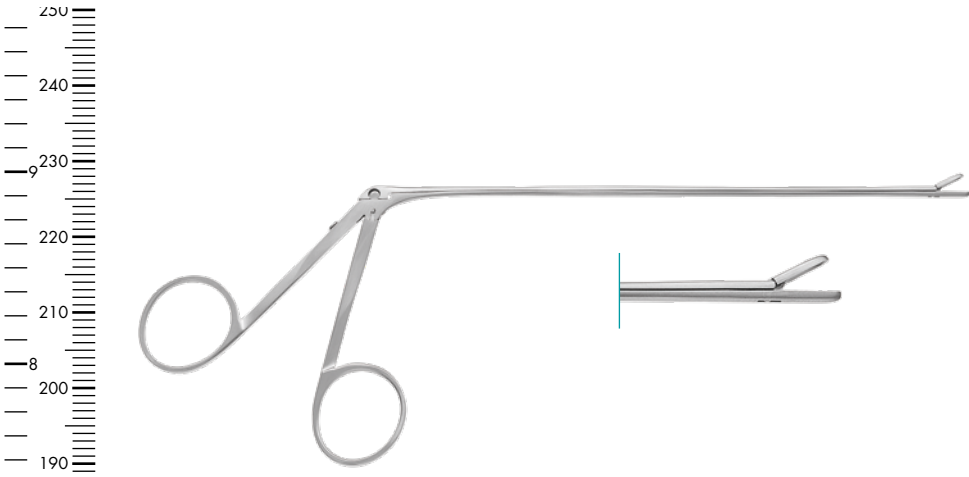

DECKER

Rongeur, fine model, 2x6mm jaw
150mm, 6"

straight	250-066-817
left curved	250-066-824
right curved	250-066-827



DECKER

Rongeur, 2x6mm jaw, straight

150mm, 6"	250-067-817
-----------	-------------

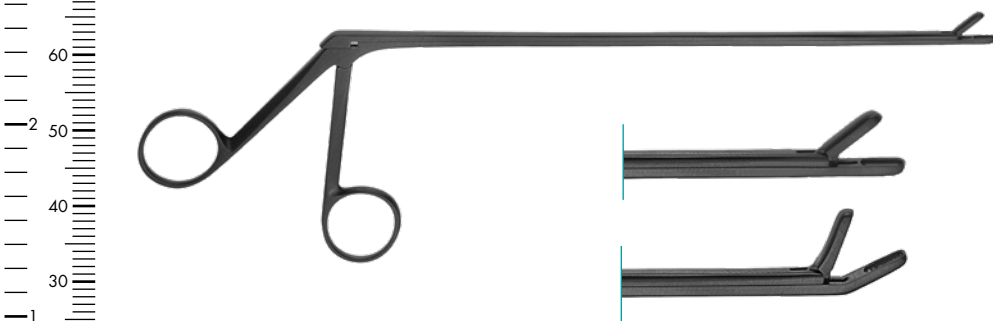

Micro Rongeur, CERA-CUT®
2mm jaw, 170mm, 6²/₃"

straight	250-300-170CC
upcurved	250-301-170CC

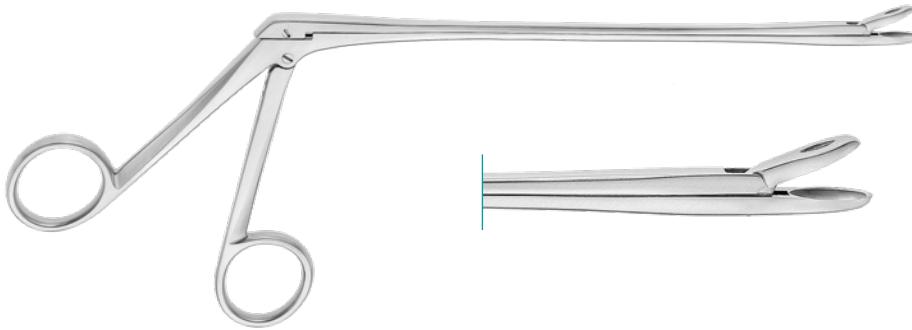
**WEIL BLAKESLEY**Rongeur, fenestrated jaw,
180mm, 7", straight

3.0mm 252-030-180

3.5mm 252-035-180

4.0mm 252-040-180

upwards angled

3.0mm 252-030-181

3.5mm 252-035-181

4.0mm 252-040-181

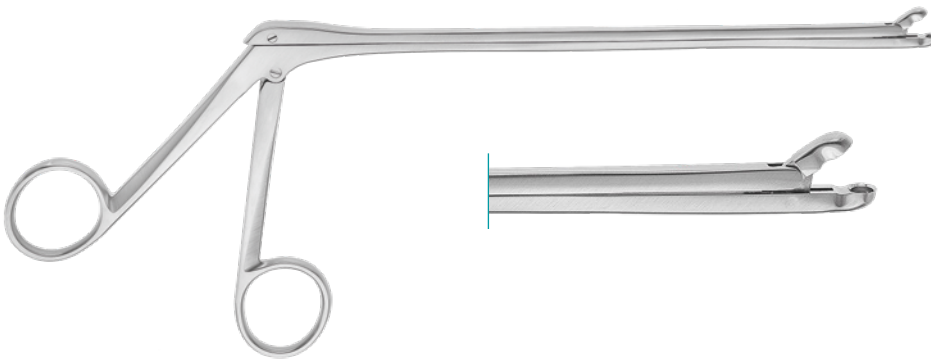
**YASARGIL**Rongeur, 190mm, 7^{1/2}"

Ø2.2mm 250-066-599

Ø3.5mm 250-066-600

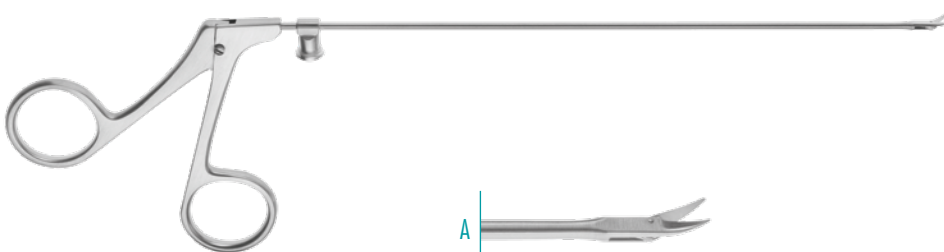
Micro Instrument with Luer-Lock
160mm, 6^{1/4}" working length**A**
Micro Scissors

250-064-223

**B NICOLA**
Micro Forceps, Ø 2.5mm

250-064-222

**C YASARGIL NICOLA**
Micro Grasping Forceps, 1mm conical jaw

250-064-224

**D NICOLA**
Micro Scissors, straight

250-064-226

**CUSHING LANDOLT**

Specula for transsphenoidal hypophysectomy,
black finishing

70 x 15mm	250-150-100
90 x 15mm	250-150-101
100 x 15mm	250-150-102

**PAPAERO CASPAR**

Specula for trans-sphenoidal hypophysectomy,
stainless steel

80 x 11mm	250-150-589
90 x 13mm	250-150-590
100 x 15mm	250-150-591

black finishing

80 x 11mm	250-150-689
90 x 13mm	250-150-690
100 x 15mm	250-150-691

Key for specula

250-150-592



Transnasal Speculum, stainless steel, matted

80 x 9mm	250-150-280
90 x 9mm	250-150-290
100 x 9mm	250-150-300

**LANDOLT**

Spreader for specula

210mm, 8 ¹ / ₄ "	250-150-210
--	-------------

BAYOSPHERE

Micro Instruments, bayonet-shaped, 100mm working length



A

B



Micro Spoon Forceps

A vertical

2mm	252-800-102
4mm	252-800-104
6mm	252-800-106

B horizontal

2mm	252-800-112
4mm	252-800-114
6mm	252-800-116



A

B

C

D

E



Micro Scissors

A sharp, straight	252-800-200
B sharp, left curved	252-800-201
C sharp, right curved	252-800-203
D sharp, horizontal	252-800-204
E blunt, straight	252-800-210

BAYOSPHERE

Micro Instruments, bayonet-shaped, 100mm working length



Micro Grasping Forceps

A	0.5mm, smooth	252-800-405
B	3.0mm, serrated	252-800-430
C	0.75mm, left curved	252-800-475



Micro Needle Holder

A	2x6mm, straight	252-800-510
B	1x6mm, left curved	252-800-511



YASARGIL Clip Applying Forceps

A	Standard Clips	252-800-810
B	Mini Clips	252-800-820

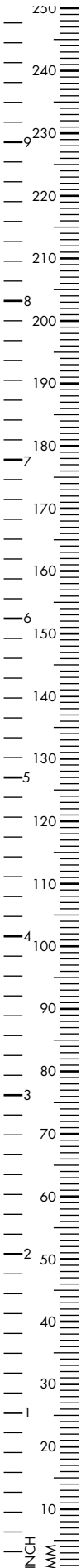



HARDY

Ring Curette, bayonet-shaped, 240mm, 9¹/₂"

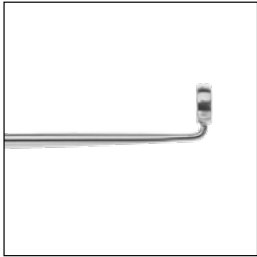

upwards angled

Ø 3mm 250-066-500
Ø 5mm 250-066-501

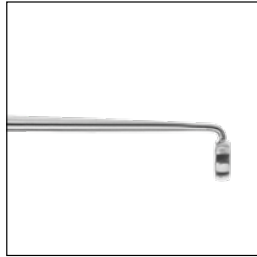

downwards angled

Ø 3mm 250-066-502
Ø 5mm 250-066-503

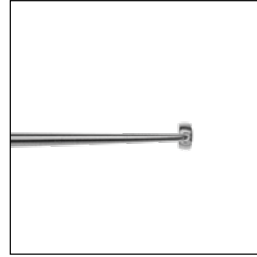

90° curved left

Ø 3mm 250-066-504
Ø 5mm 250-066-505



45° curved right

Ø 3mm 250-066-506
Ø 5mm 250-066-507

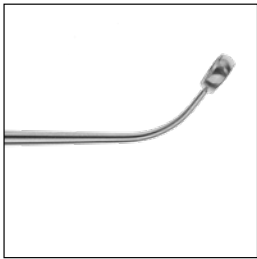

left curved

Ø 5mm 250-066-508

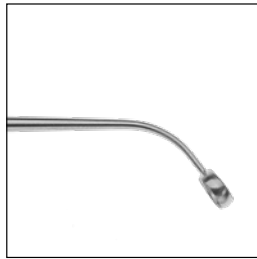

right curved

Ø 5mm 250-066-509

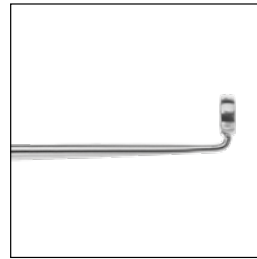

260mm, 10¹/₄" malleable

Ø 4mm 250-066-631
Ø 6mm 250-066-632



RAY

Ring Curette, 190mm, 7¹/₂"

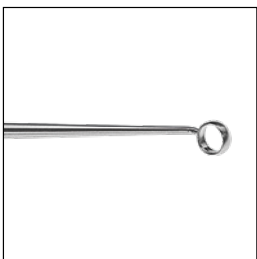

45° horizontal curved

Ø 4mm 250-066-611

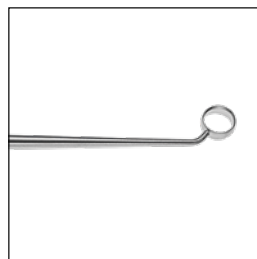

45° vertically curved

Ø 4mm 250-066-614

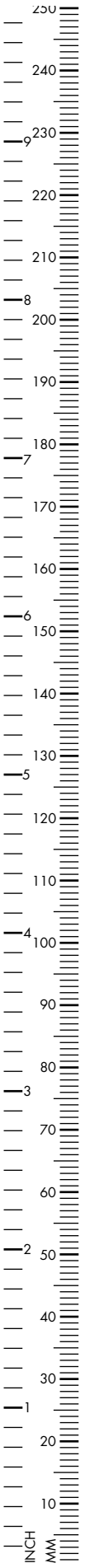

NICOLA
Ring Curette, 210mm, 8 1/4"

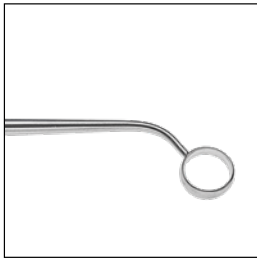

cutting to right
Ø 6.5mm 250-066-616

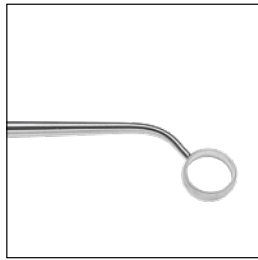

cutting to left
Ø 6.5mm 250-066-617

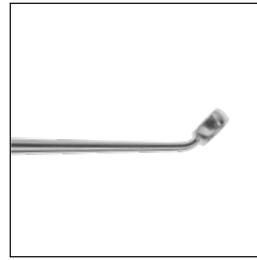

curved up
Ø 6.5mm 250-066-618

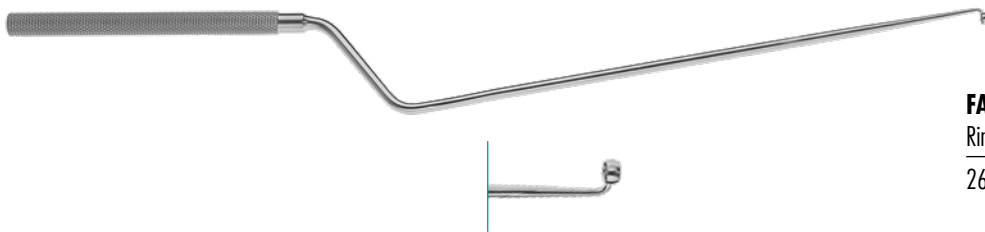

FAHLBUSCH
Ring Curette, 90°, Ø 2.5mm, malleable
260mm, 10 1/4" 250-066-637

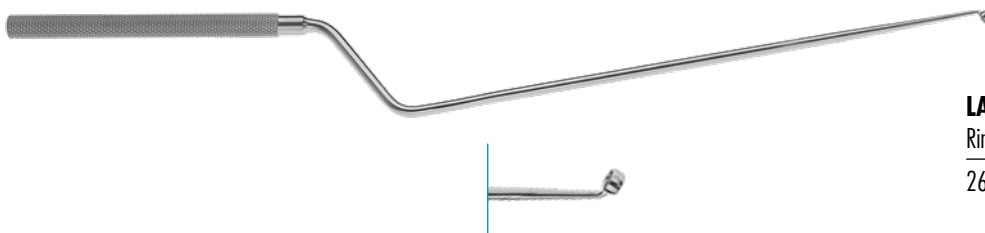

LANDOLT-REULEN
Ring Curette, 45°, Ø 2.5mm
260mm, 10 1/4" 250-066-642

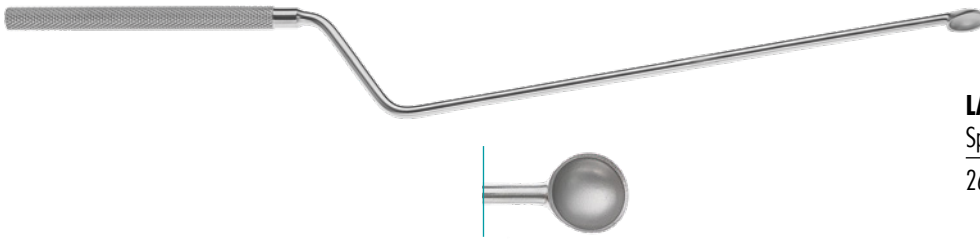
**LANDOLT**

Spoon, malleable

260mm, 10¹/₄"

250-066-628

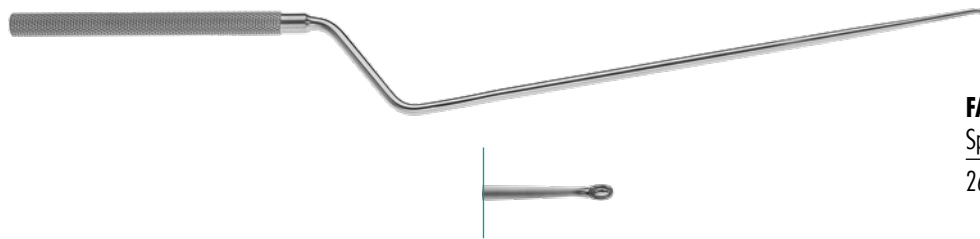
**FAHLBUSCH**

Spoon, malleable

260mm, 10¹/₄"

250-066-635

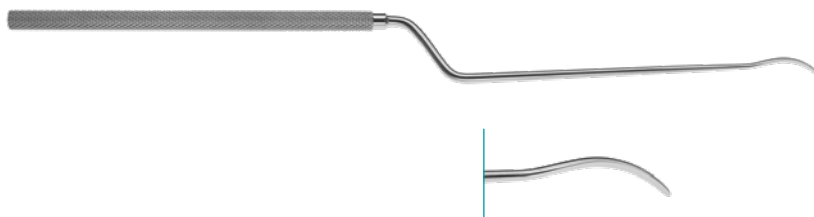
**NICOLA**

Raspatory, 2mm

215mm, 8¹/₂"

250-066-619

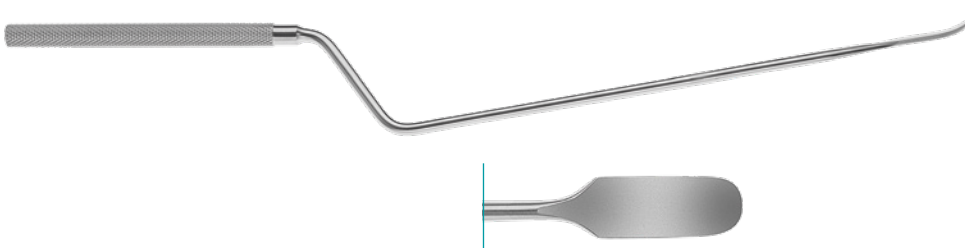
**LANDOLT**

Raspatory, malleable

260mm, 10¹/₄"

250-066-627

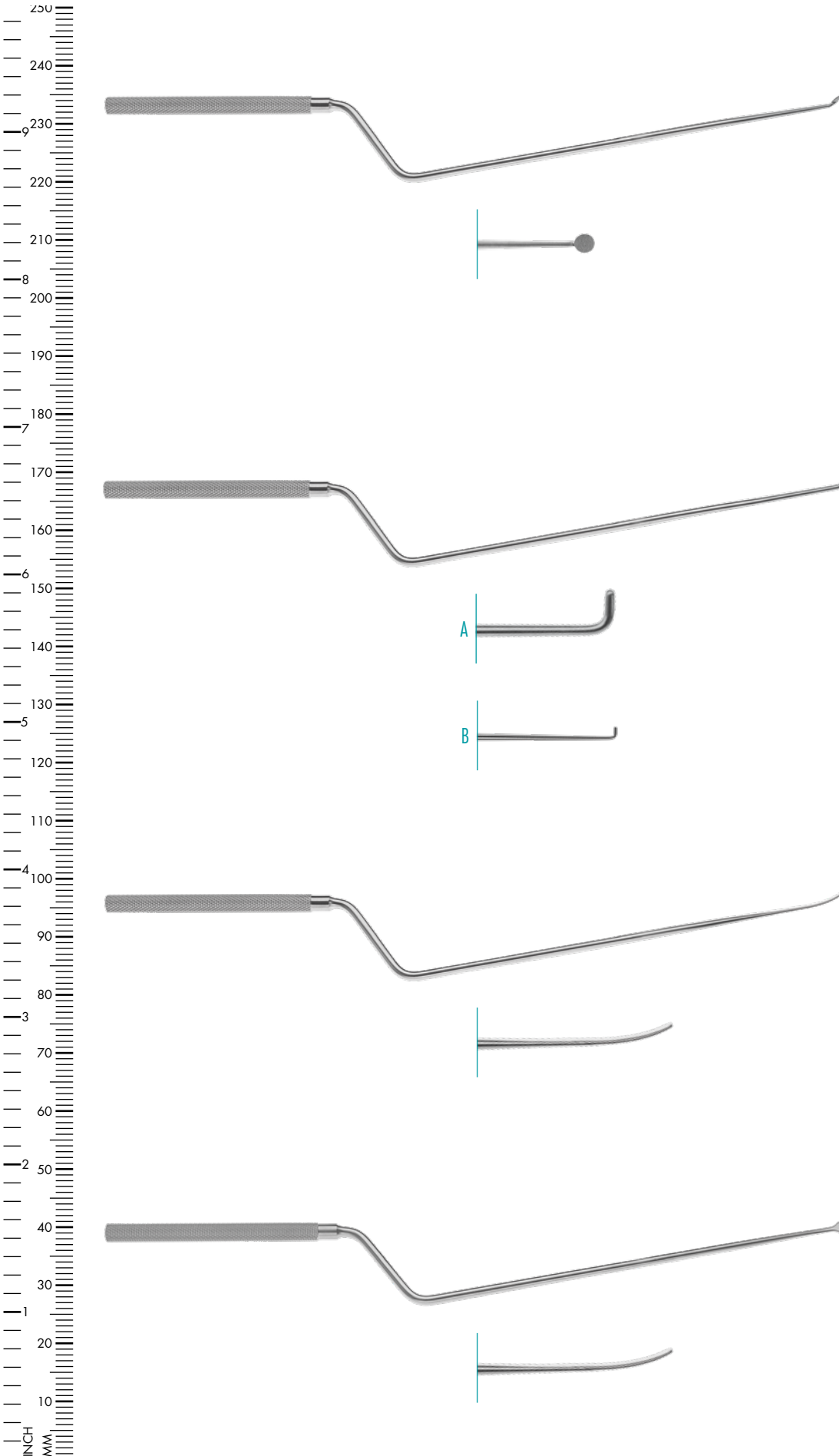

LANDOLT-REULEN

Raspatory, 260mm, 10^{1/4}"
malleable

Ø 2.2mm 250-066-640

LANDOLT

Hook, blunt

A 260mm, 10^{1/4}" 250-066-629

LANDOLT-REULEN

Hook, blunt

B 260mm, 10^{1/4}" 250-066-643

LANDOLT-REULEN

Dissector, Ø 2.0mm

260mm, 10^{1/4}" 250-066-644

HOSOBUCHI

Fork Spatula

260mm, 10^{1/4}" 250-066-630



HARDY

Enucleator, blunt, 245mm, 9²/₃"

A curved left 250-066-620

B curved right 250-066-621

HARDY-FAHLENBUSCH

Enucleator, fine, sharpened inner edge, 245mm, 9²/₃"

C curved left 250-066-608

D curved right 250-066-609



LANDOLT

Enucleator, malleable, 260mm, 10¹/₄" blunt

A right 250-066-625

B left 250-066-655

sharp

A right 250-066-626

B left 250-066-656

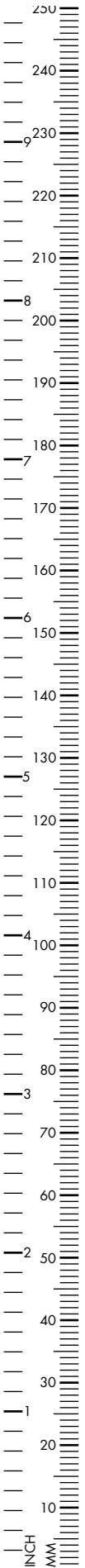

ORAL



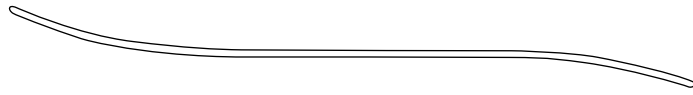
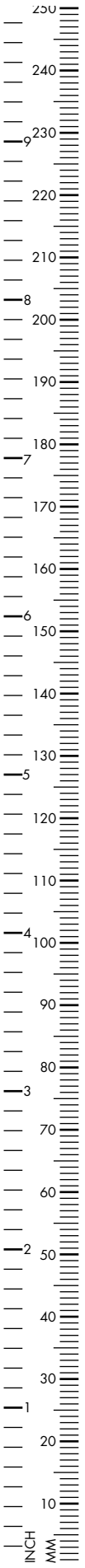

BUCHWALD

Tongue Depressor, 23 x 18mm

180mm, 7"

430-361-190



MAYO

Tongue Depressor, 23 x 19mm

170mm, 6²/₃"

430-362-170



BRUENINGS

Tongue Depressor

190mm, 7¹/₂"

430-385-190



MINNESOTA

Cheek Retractor, 14mm and 20mm wide,
double-ended

155mm, 6¹/₈"

430-155-000

**MORITZ-SCHMIDT**

Tongue Depressor

190mm, 7¹/₂"

430-397-190

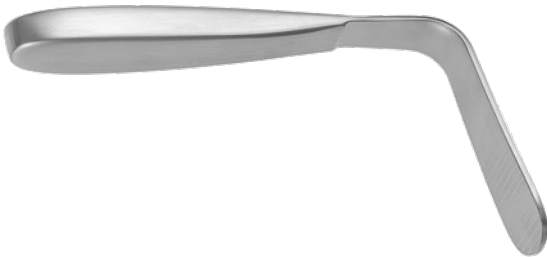
**TOBOLD**

Tongue Depressor

145mm, 5³/₄"

430-349-145

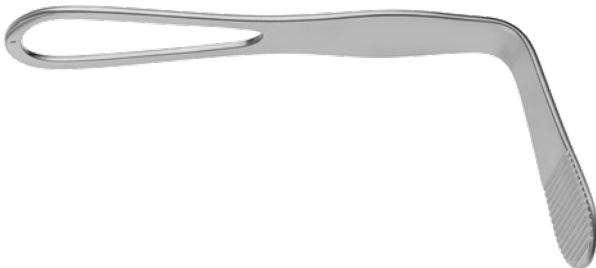
**HARTMANN**

Tongue Depressor, fenestrated handle

150mm, 6"

430-271-150

**WIEDER**

Tongue Depressor, fenestrated blade

125mm, 5"

30mm blade

430-297-140

36mm blade

430-297-150

**STIERLEN**

Tongue Depressor

55mm	430-350-005
70mm	430-350-007
90mm	430-350-009
100mm	430-350-010

**HEISTER**

Mouth Gag

130mm, 5 ¹ / ₈ "	430-150-130
--	-------------

**DOYEN-JANSEN**

Mouth Gag, children

120mm, 5 ¹ / ₈ "	430-140-110
--	-------------

adults

140mm, 5 ¹ / ₂ "	430-140-140
--	-------------

**DENHARDT**

Mouth Gag, silicone inserts, interchangeable

120mm, 4 ³ / ₄ "	430-142-120
--	-------------

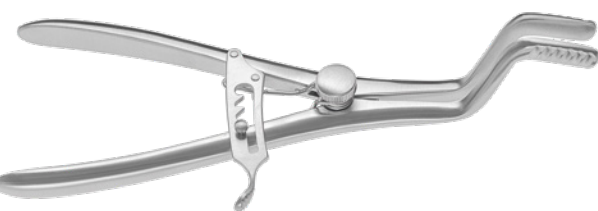
**ROSER-KOENIG**

Mouth Gag

160mm, 6 ¹ / ₄ "	430-144-160
--	-------------

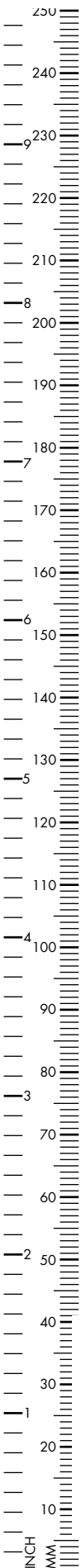

**JENNINGS**

Mouth Gag

90mm, 3 ¹ / ₂ "	430-250-090
110mm, 4 ¹ / ₃ "	430-250-110
130mm, 5 ¹ / ₈ "	430-250-130
150mm, 6"	430-250-150

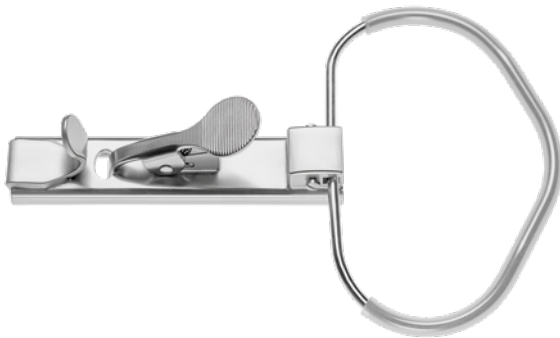
**MC IVOR**

Mouth Gag, frame only

430-256-010

**DAVIS-MEYER**

Mouth Gag, frame only

right	430-130-500
left	430-130-510



Sliding Tooth Hook

430-130-520



Palate Blade, for 430-130-500

430-130-560

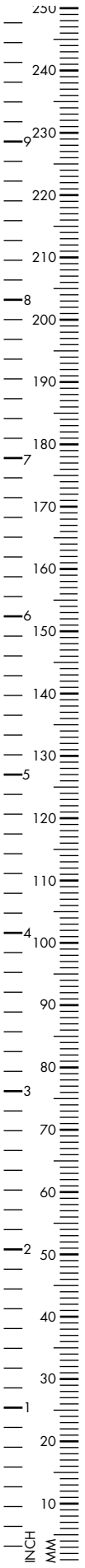

DAVIS-BOYLE

Mouth Gag, adults

left	430-310-010
right	430-310-011



Silicone Caps for Davis-Boyle mouth gag

430-310-012



DAVIS-BOYLE

Mouth Gag, small pattern for adolescent

430-310-009

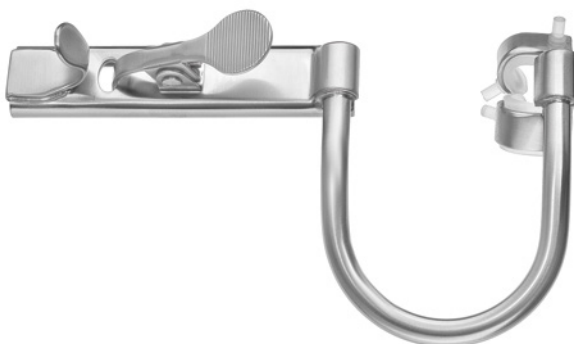

DAVIS-BOYLE

Mouth Gag, children

430-310-110

**KILNER-DOUGHTY**

Mouth Gag, left

430-315-010

**DINGMANN**

Mouth Gag, set with 3 blades

430-327-000

Mouth Gag only

430-327-004

Blades

24 x 62mm

430-327-001

28 x 65mm

430-327-002

31 x 75mm

430-327-003



OSTRA LARYNGO-PHARYNGOSCOPE RETRACTOR

- **Wide range of blades**
Tongue, vallecular and laryngeal
- **Adaptable design**
Accommodates different anatomical conditions and surgical techniques
- **Open lateral frame**
Enables free movement for robotic instruments and camera, ensuring an unobstructed view
- **Independent blade adjustment**
Precise control of angle and depth for customized exposure.
- **Secure fixation**
Fully compatible with the RZ Retractor Holder Set

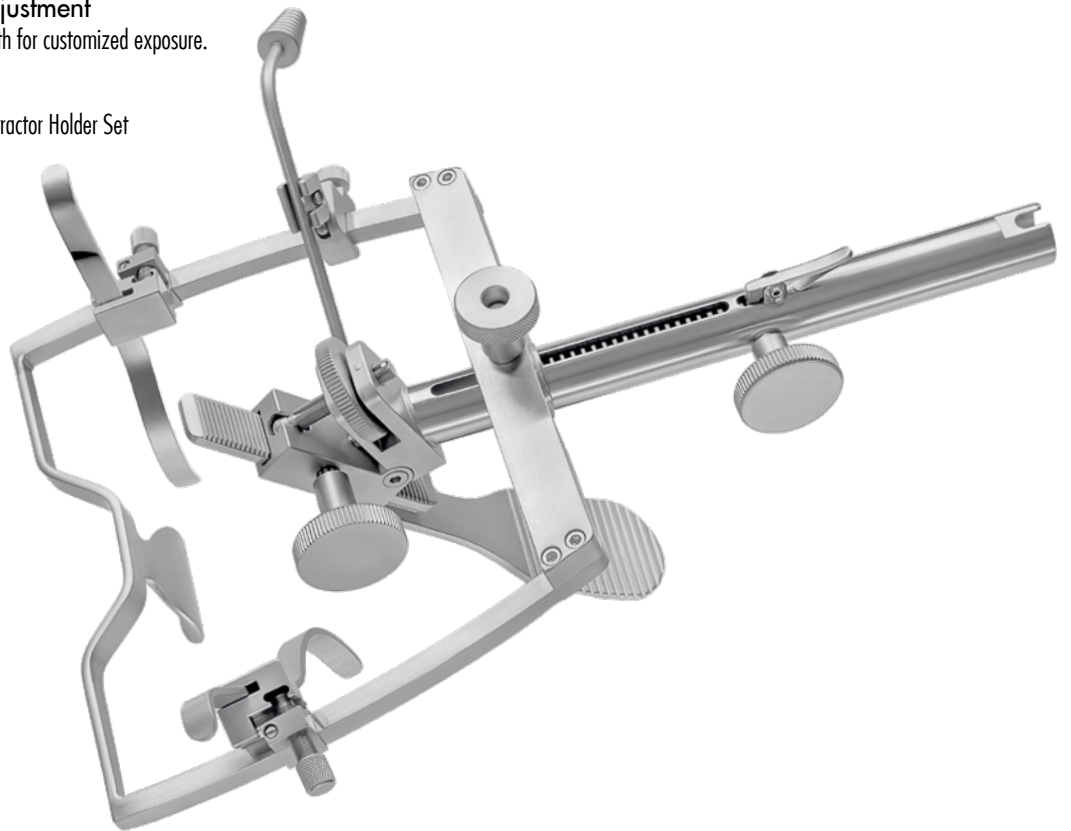

NATHANSON

Retractor Arm Set with table clamp

Table Clamp	170-801-503
single arm	170-801-501
double arm	170-801-502



- **Secure table fixation**
- **90° / 360° positioning flexibility**
- **Quick-lock attachment**

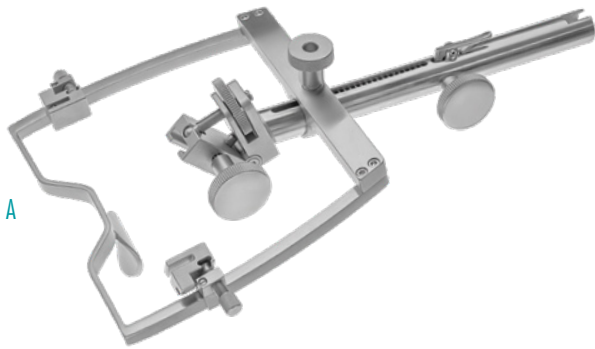

A



B



D



F



H



J



L



N



C



E



G



I



K



M

RZ OSTRÄLaryngo-Pharyngoscope Retractor,
complete set

430-326-000

A Basic frame
with adaptor 430-326-100B Adaptor for
Retractor Holder Set
170-801-501 430-326-002C Adaptor For Chest
Support 430-326-003D TORS blade,
small, left 430-326-004D TORS blade,
small, right 430-326-005E TORS blade,
large, left 430-326-006E TORS blade,
large, right 430-326-007F Tongue blade,
curved 430-326-008G Tongue blade,
curved, open right 430-326-009G Tongue blade,
curved, open left 430-326-010H Mandible blade,
110mm 430-326-011I Laryngeal blade,
170mm, concave 430-326-012J Diverticle blade,
concave, working
length 22 cm 430-326-013K Cheek retractor,
curved 430-326-014L Light clip, with
lateral cable connection 430-326-015M Adaptor for suction
tube or tumor grasping
forceps 430-326-016N Suction tube for
smoke, Ø4x170 mm 430-326-017

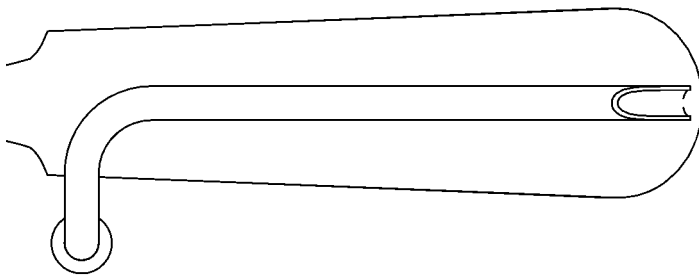
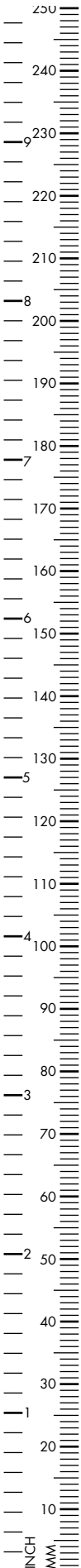

DAVIS-BOYLE

Tongue Blade, without anaesthesia channel

21 x 30mm	430-257-001
with anaesthesia channel	
23 x 65mm	430-257-002
24 x 80mm	430-257-003
25 x 93mm	430-257-004
26 x 108mm	430-257-005



DAVIS-BOYLE

Tongue Blade

25 x 65mm	430-310-001
25 x 75mm	430-310-002
25 x 90mm	430-310-003
25 x 102mm	430-310-004



MC IVOR

Tongue Blade

23 x 55mm	430-256-001
25 x 65mm	430-256-002
26 x 75mm	430-256-003



HERBERHOLD

Tongue Blade

Fig. 1, 29 x 61mm	430-298-001
Fig. 2, 33 x 70mm	430-298-002
Fig. 3, 38 x 79mm	430-298-003
Fig. 4, 41 x 94mm	430-298-004

**DAVIS-MEYER**Tongue Blade, with tubing set
for anaesthesia channel

29 x 70mm	430-130-070
30 x 75mm	430-130-075
31 x 80mm	430-130-080
32 x 85mm	430-130-085
33 x 95mm	430-130-095
34 x 100mm	430-130-100
34 x 105mm	430-130-105

**KILNER-DOUGHTY**

Tongue Blade

28 x 65mm	430-315-001
23 x 75mm	430-315-002
37 x 80mm	430-315-003

**RUSSEL-DAVIS**

Tongue Blade, with groove

28 x 65mm	430-309-001
32 x 75mm	430-309-002
37 x 80mm	430-309-003
41 x 94mm	430-309-004
46 x 103mm	430-309-005

very narrow pattern

18 x 57mm	430-309-006
22 x 67mm	430-309-007
25 x 75mm	430-309-008
27 x 85mm	430-309-009

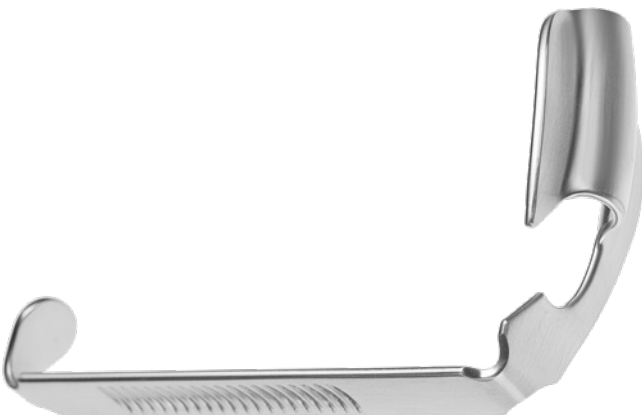

Tongue Blade, with groove

28 x 65mm	430-129-001
32 x 75mm	430-129-002
37 x 80mm	430-129-003

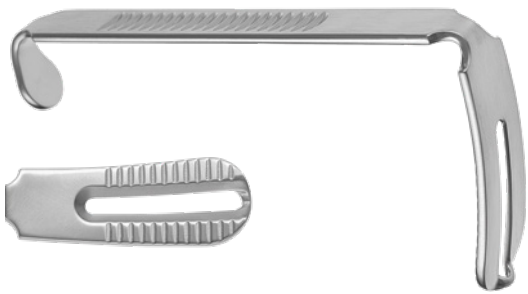
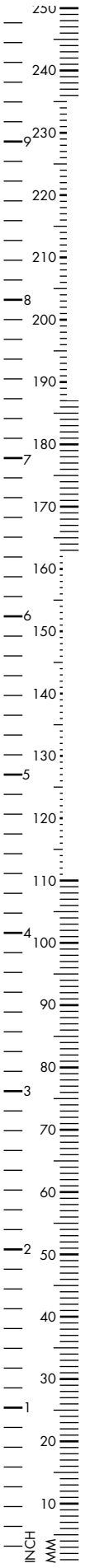

DOUGHTY

Tongue Blade, with slot

23 x 65mm	430-320-065
24 x 80mm	430-320-075
25 x 93mm	430-320-090
26 x 108mm	430-320-102
26 x 114mm	430-320-115

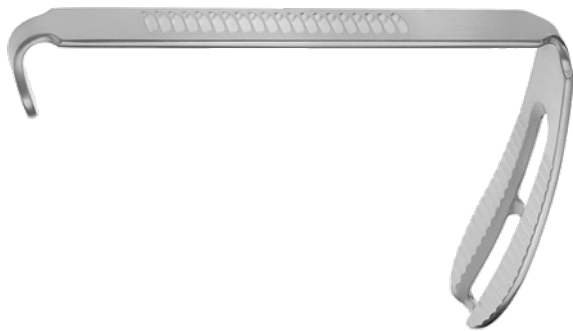

WÜRZBURG

Tongue Blade, slotted

136 x 71mm	430-325-001
136 x 77mm	430-325-002
136 x 86mm	430-325-003
136 x 96mm	430-325-004
136 x 106mm	430-325-005

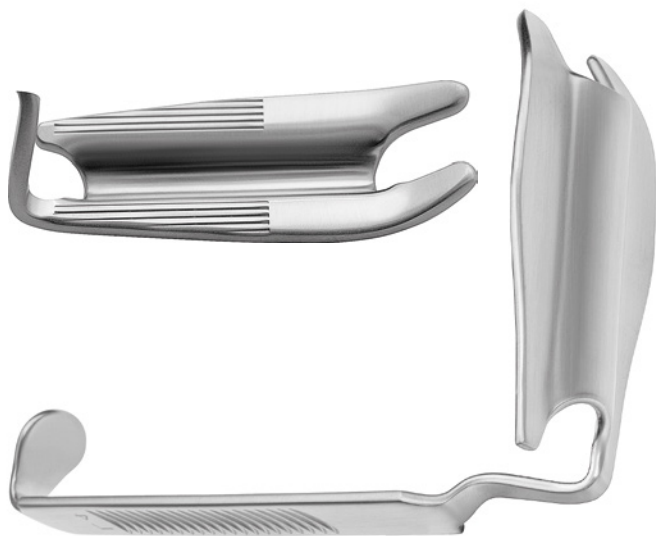

Tongue Blade, left

25 x 58mm	430-000-002
27 x 72mm	430-000-003
34 x 87mm	430-000-004
37 x 95mm	430-000-005

right

25 x 58mm	430-010-002
27 x 72mm	430-010-003
34 x 87mm	430-010-004
37 x 95mm	430-010-005



NEGUS
Chest Support

430-320-000

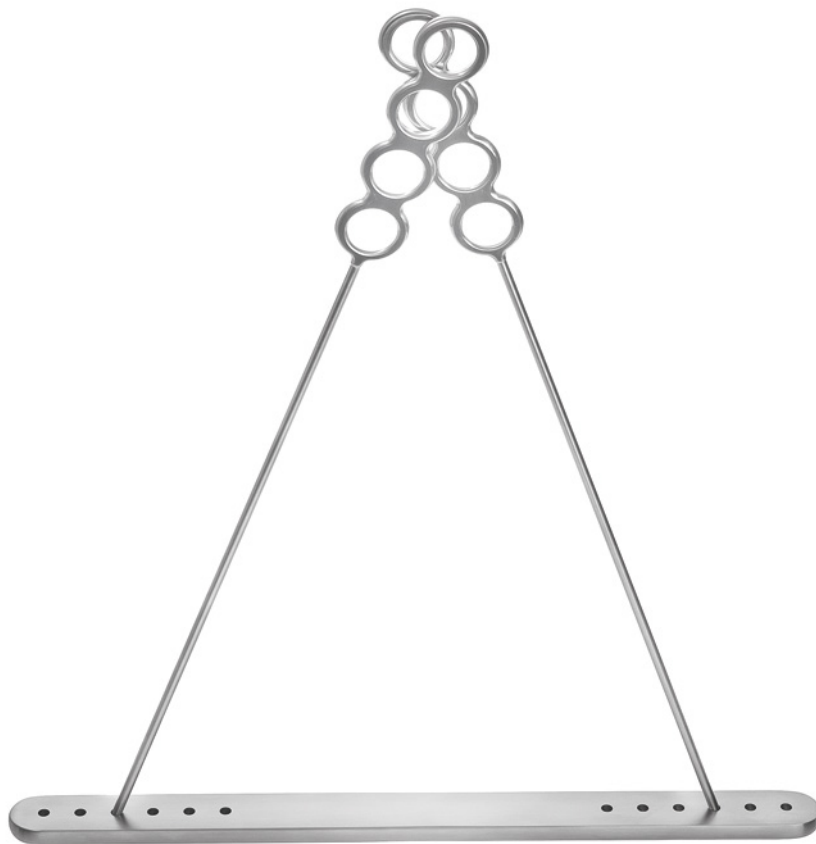

DRAFFIN
Holder for mouth gag, complete:
2 bars and plate

430-355-000

Bars only, pair

430-355-001

Magauran Plate

430-355-002

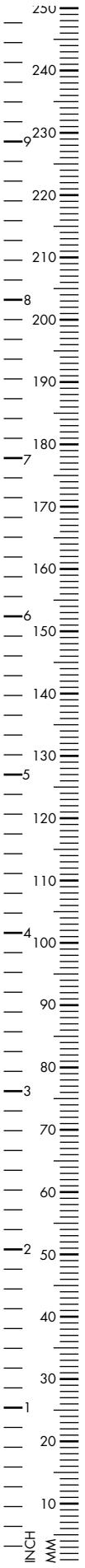

SEIFERT

Salivary duct probe, silver plated, \varnothing 1.0mm

180mm, 7" 410-045-180



BOWMAN

Lacrimal Probe, buttoned up

0000/000 400-497-008

00/0 400-497-003

0/1 400-497-001

1/2 400-497-012

2/3 400-497-023

3/4 400-497-034

4/5 400-497-045

5/6 400-497-056

6/7 400-497-067

7/8 400-497-078



WILDER

Dilator

Fig. 1 400-713-001

Fig. 2 400-713-002

Fig. 3 400-713-003



PERWITZSCHKY

Salivary Scissors

100mm, 4" 420-100-100



**PERWITZSCHKY**

Salival Scissors

100mm, 4"

420-100-100



Scalpel Handle No.7

165mm, 6 1/2"

110-130-077



Scalpel Handle No.3L

210mm, 6 1/4"

110-116-033

**FISCHER**

Tonsil Knife, serrated blade

225mm, 8 7/8"

430-656-190

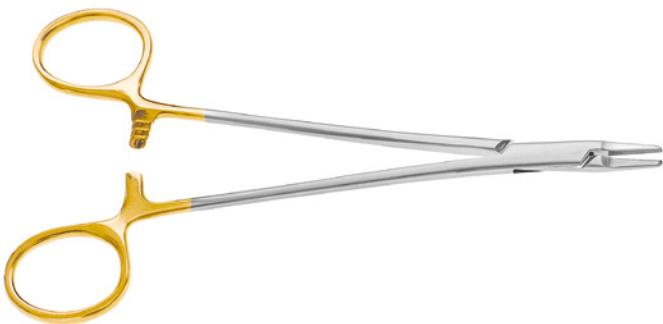
**RYDER**

TC Needle Holder, 2.0mm tip, serrated jaw, straight

180mm, 7"

180-560-180

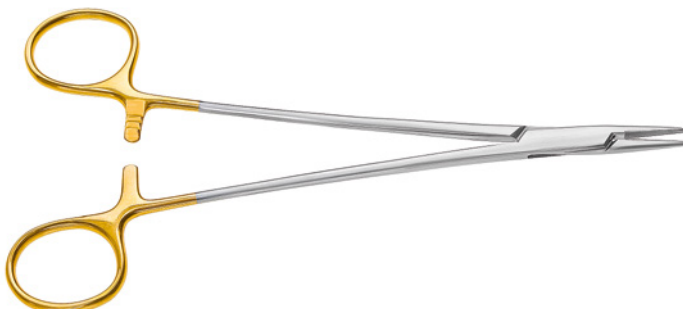
**DEBAKEY**

TC Needle Holder, serrated, straight

180mm, 7"

180-548-180

**NAGER**

Uvula Retractor

210mm, 8¹/₄"

430-524-210

**HOFER**

Uvula Retractor

240mm, 9¹/₂"

430-300-230

**SCHÖNBORN**

Uvula Retractor, 13 x 6mm

210mm, 8¹/₄"

430-245-200

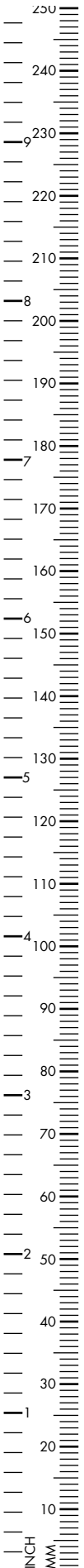

**BECKMANN**Adenoid Curette, straight, 220mm, 8^{2/3}"

Fig. 1, 8mm	420-220-010
Fig. 2, 10mm	420-220-020
Fig. 3, 12mm	420-220-030
Fig. 4, 14mm	420-220-040
Fig. 5, 16mm	420-220-050
Fig. 6, 18mm	420-220-060
Fig. 7, 19.5mm	420-220-070

**BECKMANN**Adenoid Curette, curved, 220mm, 8^{2/3}"

Fig. 1, 8mm	420-221-010
Fig. 2, 10mm	420-221-020
Fig. 3, 12mm	420-221-030
Fig. 4, 14mm	420-221-040
Fig. 5, 16mm	420-221-050
Fig. 6, 18mm	420-221-060
Fig. 7, 19.5mm	420-221-070

**BARNHILL**Adenoid Curette, 220mm, 8^{2/3}"

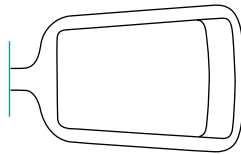
Fig. 0	420-222-000
Fig. 1	420-222-001
Fig. 2	420-222-002
Fig. 3	420-222-003
Fig. 4	420-222-004

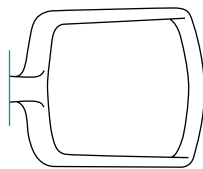

LA FORCE

Adenotome, 230mm, 9"

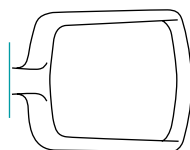
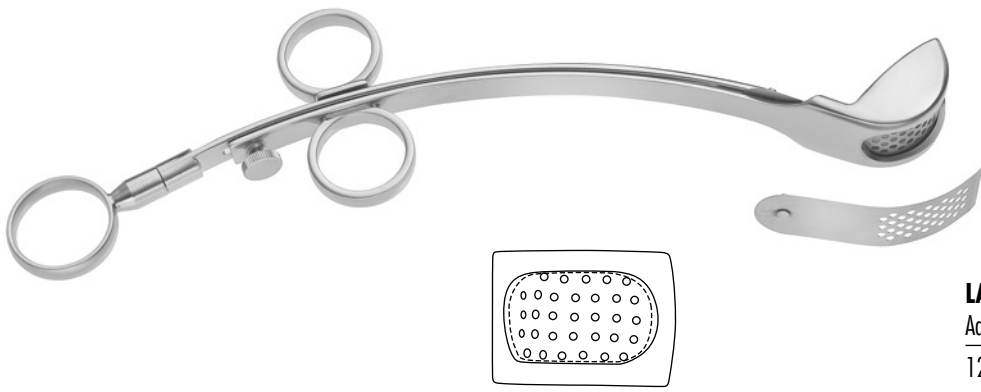
12mm	420-226-001
16mm	420-226-002
18mm	420-226-003

Spare Blades

for 420-226-001	420-226-101
for 420-226-002	420-226-102
for 420-226-003	420-226-103



SHAMBOUGH

Adenotome

Fig. 1, 13mm	420-228-000
Fig. 2, 16mm	420-228-000
Fig. 3, 19mm	420-229-100

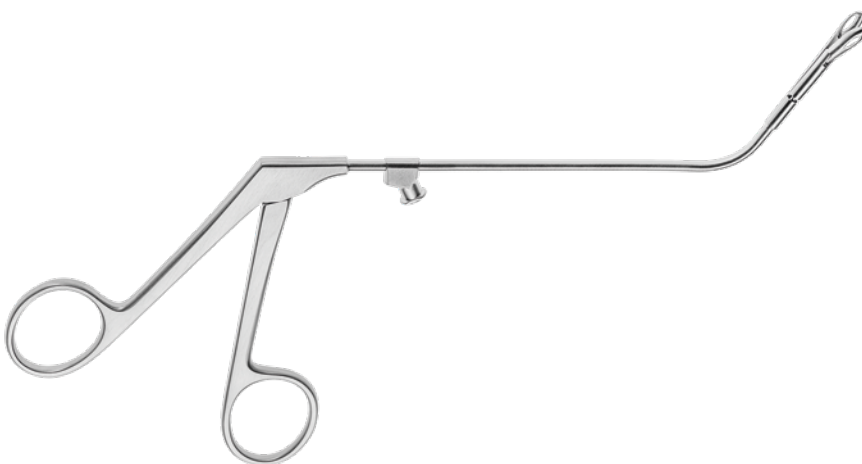

JATHO

Nasopharynx Forceps

240mm, 9 1/2"	420-395-240
---------------	-------------



JURASZ

Adenoid Cutting Forceps, children

190mm, 7¹/₂" 420-396-190

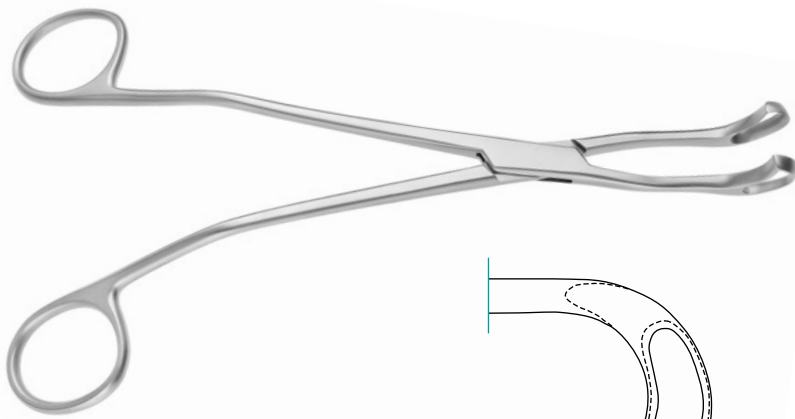

JURASZ

Adenoid Cutting Forceps, 210mm, 8¹/₄"

Fig. 1 420-397-210

Fig. 2 420-398-210

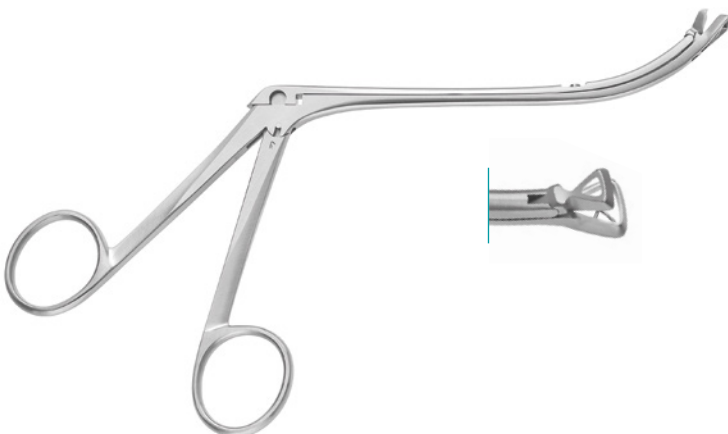

RONIS

Adenoid Forceps, through cutting, upcurved shaft, triangular bite, 130mm working length

Fig. 0, 6mm 420-391-000

Fig. 1, 7mm 420-391-001

Fig. 2, 8mm 420-391-002

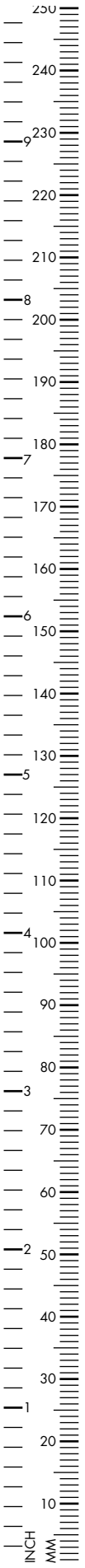

KING

Adenoid Forceps, through cutting, downcurved shaft, triangular bite, 130mm working length

Fig. 1, 7mm 420-391-115

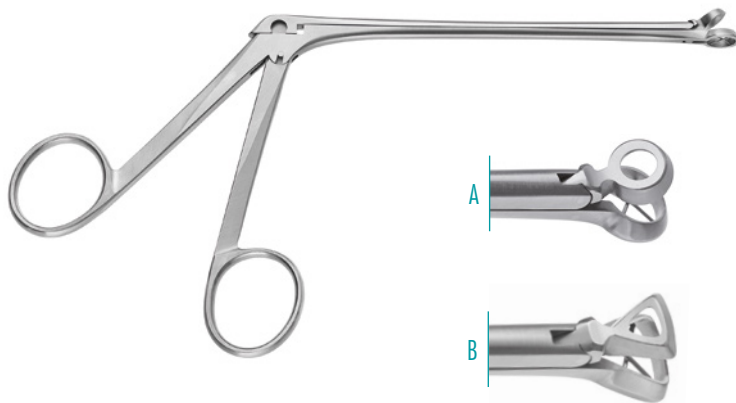

MELZER

A Adenoid Forceps, through cutting, round, 140mm, 5 1/2"

Fig. 1, 7mm 420-401-001
Fig. 2, 8mm 420-401-002

B through cutting, triangular

Fig. 0, 6mm 420-401-100
Fig. 1, 7mm 420-401-101
Fig. 2, 8mm 420-401-102
Fig. 3, 10mm 420-401-103

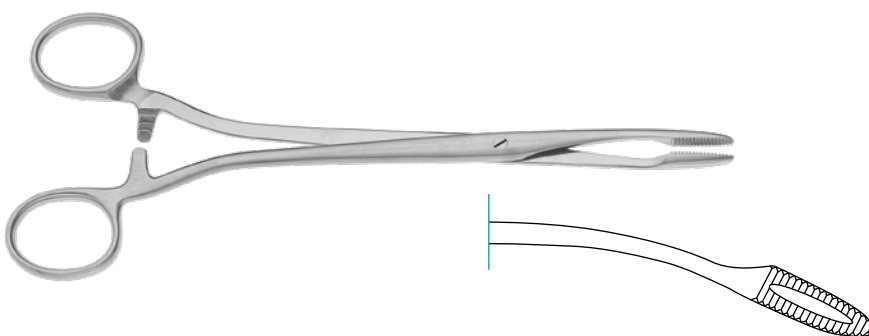

DUPLAY

Dressing Forceps, 200mm, 8"

straight 150-130-200
curved 150-131-200

**DUPLAY**

Nasopharyngeal Sponge Holding Forceps,
s-shaped

190mm, 7¹/₂"

420-398-190

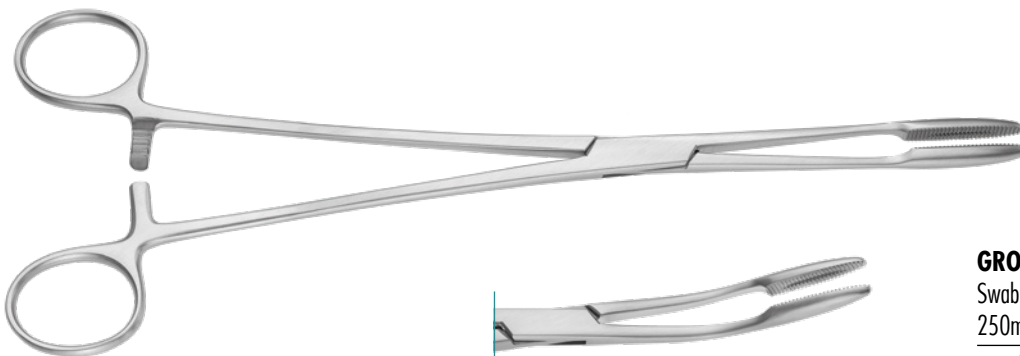
**GROSS MAIER**

Swab Forceps, serrated, straight,
250mm, 9⁷/₈"

straight

150-030-250

curved

150-031-250

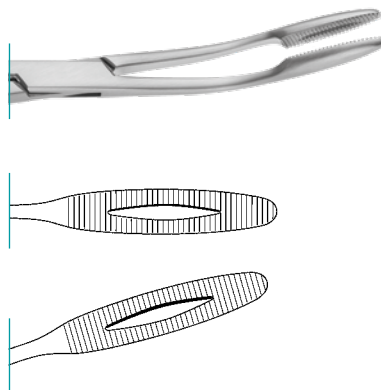

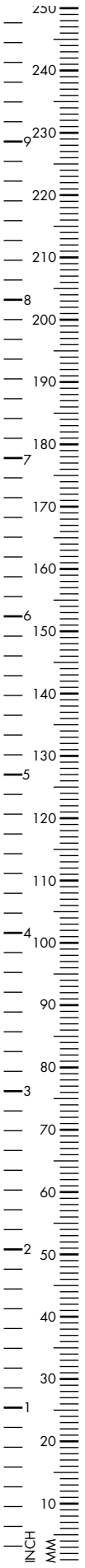

Dressing Forceps, serrated
200mm, 8" 130-010-200



Standard Dressing Forceps, delicate, straight
200mm, 8" 130-014-200



Tissue Forceps, 1x2 teeth
200mm, 8" 130-110-200



Tissue Forceps, 1x2 teeth, delicate
200mm, 8" 130-120-200

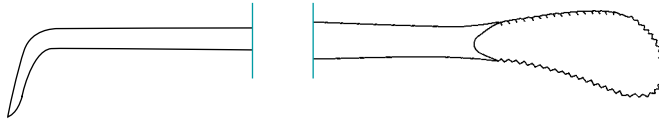

HENKE

Tonsil Dissector / Pillar Retractor,
235mm, 9¹/₄"

12mm	430-600-230
17mm	430-601-230

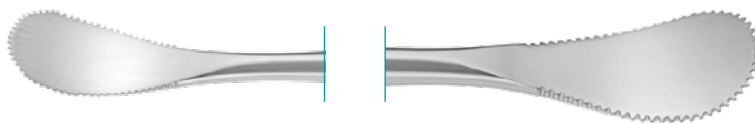

HENKE

Tonsil Dissector, double-ended
12mm / 18mm

230mm, 9"	430-602-230
-----------	-------------

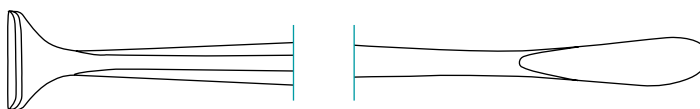

HURD

Tonsil Dissector / Pillar Retractor,
215mm, 8¹/₂"

7.5mm	430-600-215
10mm	430-601-220

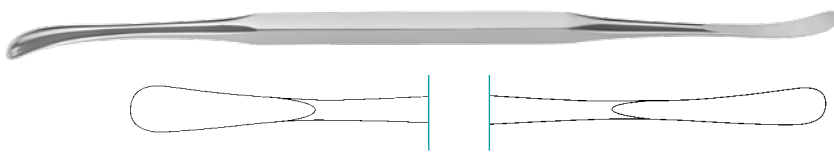
**ALDERDICE**

Tonsil Dissector

220mm, 8²/₃"

430-510-220

**LOPEZ-REINKE**

Tonsil Suction Dissector

235mm, 9¹/₄"

430-670-235

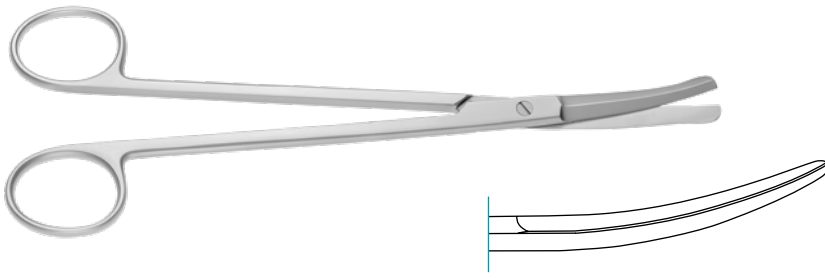
**GOOD**

Tonsil Scissors

190mm, 7¹/₂"

120-217-190

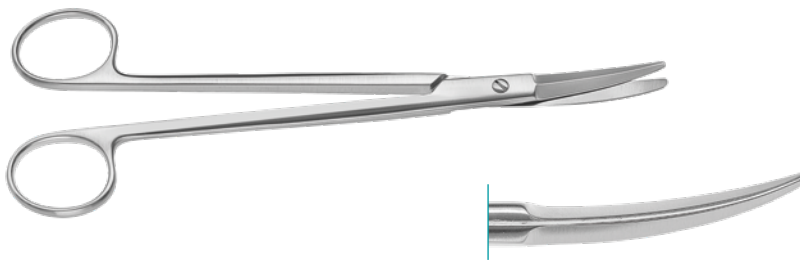
**PRINCE**

Tonsil Scissors

175mm, 6⁷/₈"

120-213-175

**BOETTCHER**

Tonsil Scissors, sharp

180mm, 7"

120-207-180

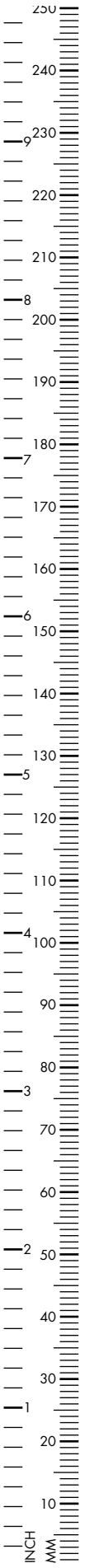

BOETTCHER

Tonsill Scissors, curved, 180mm, 7"

120-209-180

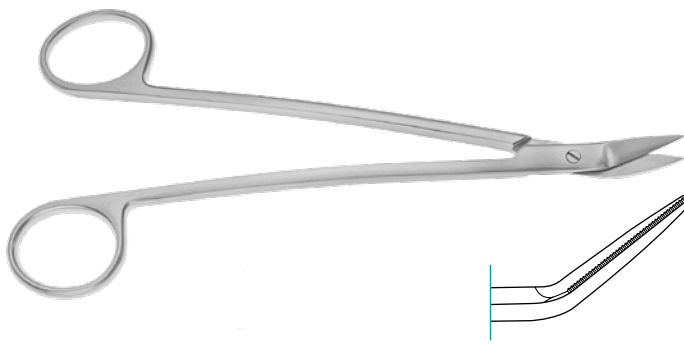

DEAN

Tonsil Scissors, angled upwards, serrated blades

170mm, 6²/₃"

120-213-170

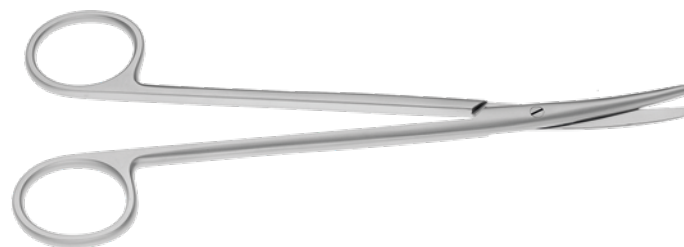

METZENBAUM NELSON

blunt, curved

180mm, 7" 120-111-180

200mm, 8" 120-111-200

230mm, 9" 120-111-230

Supercut

180mm, 7" 121-111-180

200mm, 8" 121-111-200

230mm, 9" 121-111-230

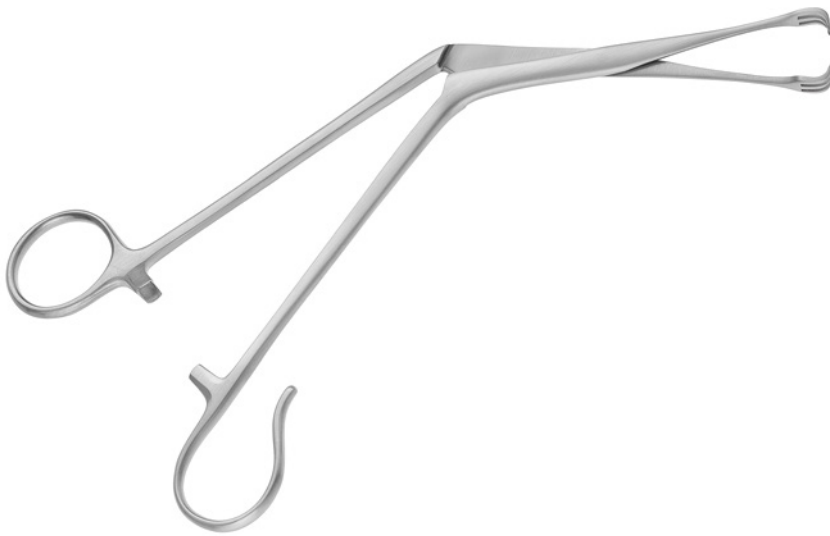
**TIVNEN-TYDING**

Tonsil Seizing Forceps, 3x3 teeth, 1 open ring

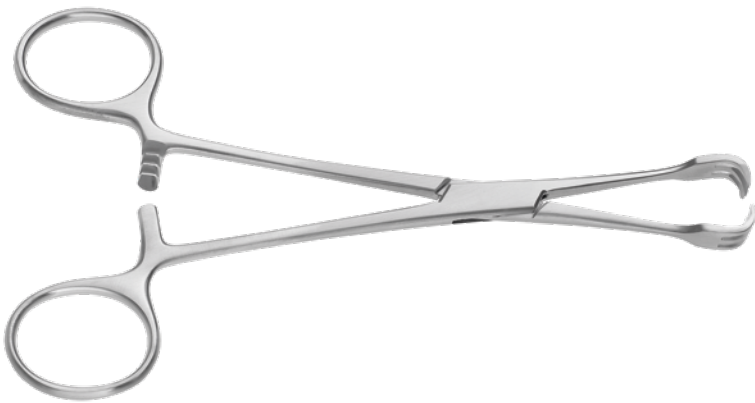
210mm, 8^{1/4}" 430-631-002**LAHEY**

Goitre Seizing Forceps

200mm, 8" 440-030-200

**MUSEUX**

Tonsil Holding Forceps, 2x2 teeth

200mm, 8" 140-602-200

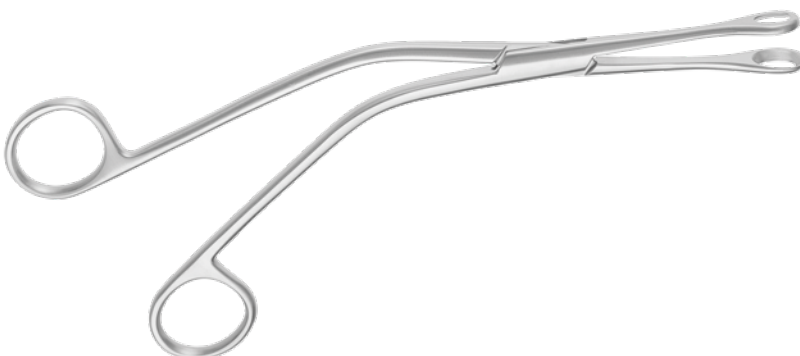
**DENIS-BROWNE**

Tonsil Holding Forceps, 10mm

200mm, 8" 420-427-200

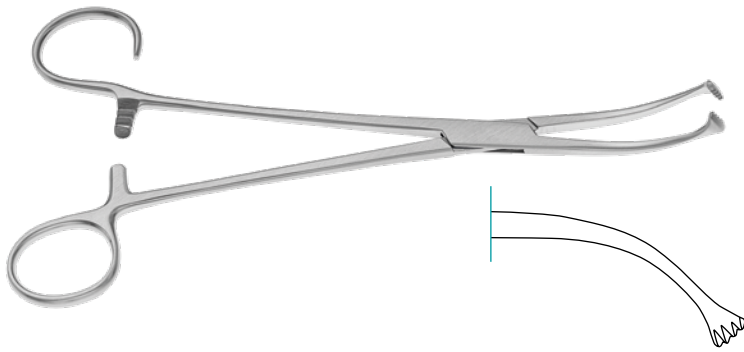
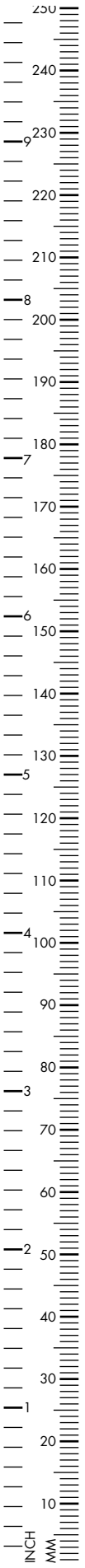

COLVER

Tonsil Seizing Forceps, curved

190mm, 7¹/₂"

140-626-190

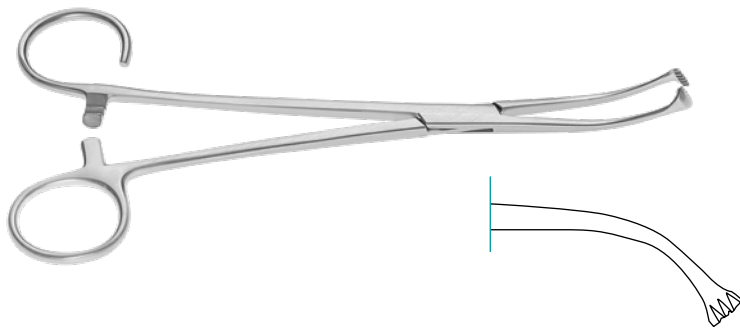

WHITE

Tonsil Holding Forceps

180mm, 7"

140-620-180

235mm, 9¹/₄"

140-620-235

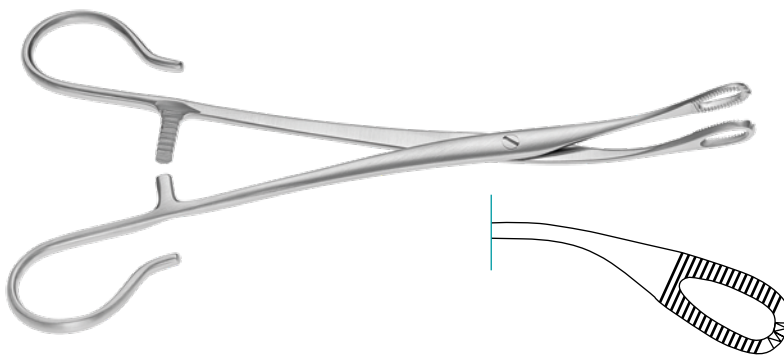

BLOHMKE

Tonsil Holding Forceps

200mm, 8"

140-625-200

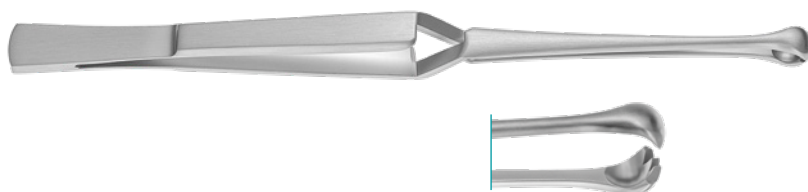

MARSCHIK

Tonsil Grasping Forceps

220mm, 8²/₃"

430-620-220

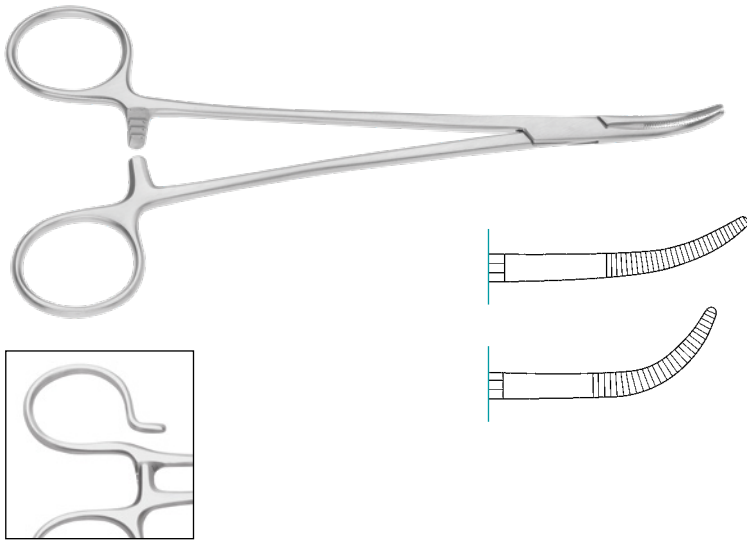

SCHNIDT SAWTELL

Tonsil Seizing Forceps, slightly curved

190mm, 7^{1/2}" 140-628-190

strongly curved

190mm, 7^{1/2}" 140-629-190

slightly curved, with one open ring

190mm, 7^{1/2}" 140-630-190

strongly curved, with one open ring

190mm, 7^{1/2}" 140-631-190

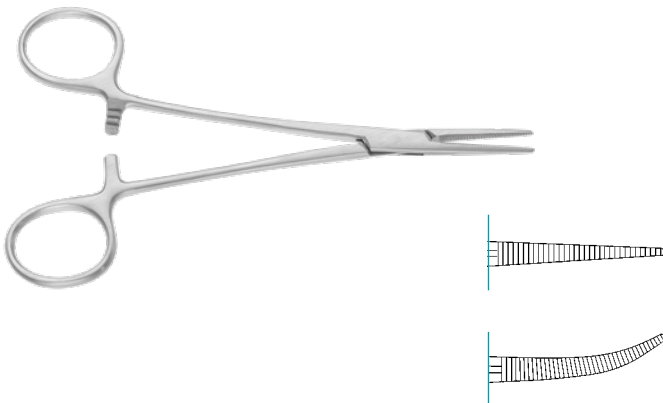

HALSTEAD MOSQUITO

Hemostatic Forceps, serrated, 180mm, 7"

straight 140-254-180

curved 140-255-180

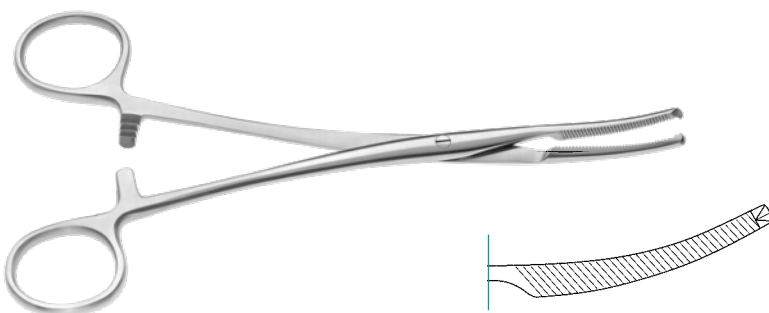

MIKULICZ

Peritoneal Forceps, curved, 1x2 teeth

180mm, 7" 140-548-180

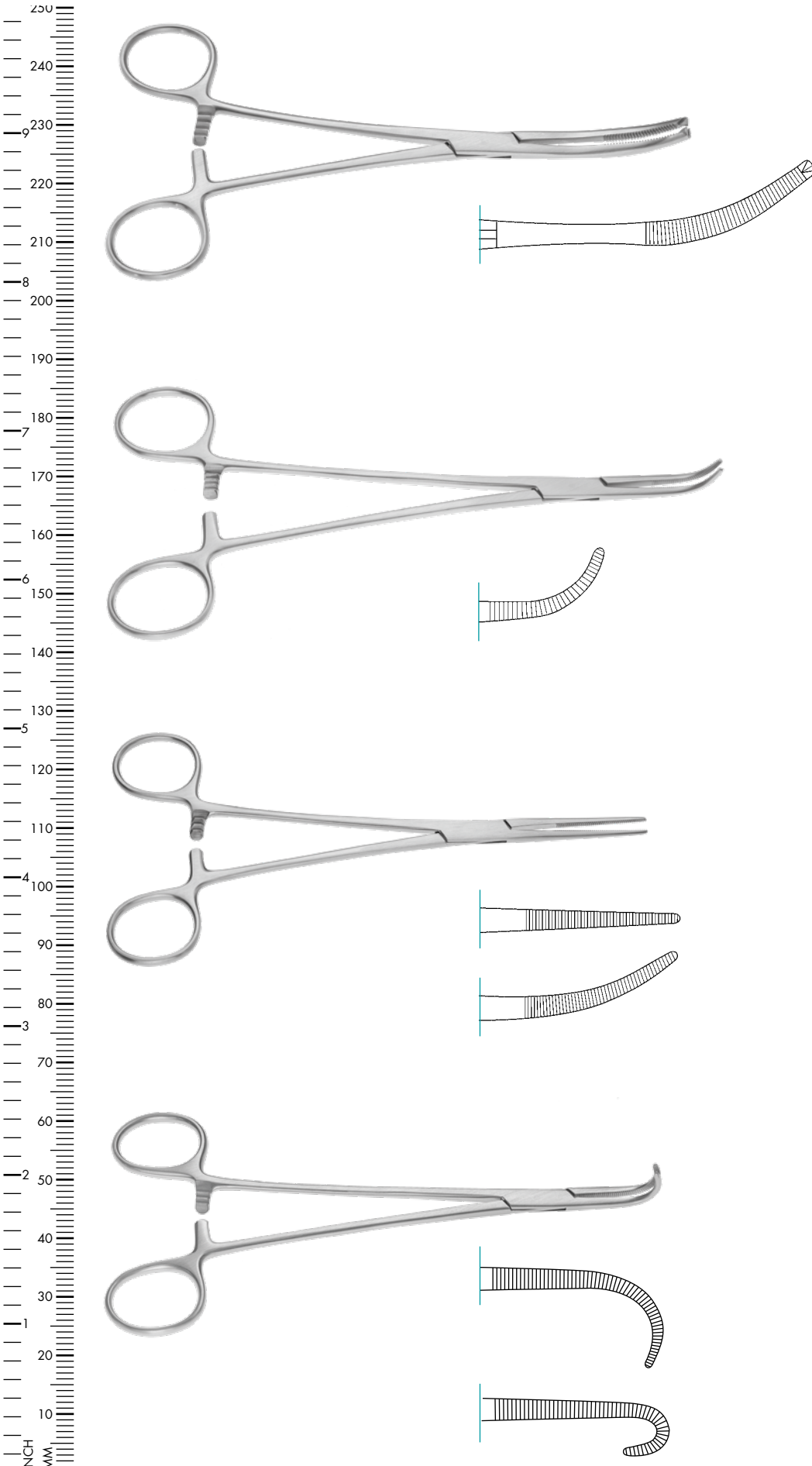

MIKULICZ

Peritoneal Forceps, strongly curved, 1x2 teeth
200mm, 8" 140-549-200

OVERHOLT

Dissecting and Ligature Forceps,
fully serrated, curved
Fig. 0, 195mm, 7^{3/4}" 140-443-001

BIRKETT

Hemostatic Forceps, serrated, 185mm, 7^{1/4}"
straight 140-368-185
curved 140-369-185

NEGUS

Tonsil Artery Forceps, serrated, 190mm, 7^{1/2}"
slightly curved 140-625-190
strongly curved 140-627-190

**BRUENINGS**

Tonsil Snare

270mm, 10²/₃"

430-605-270

**EVES**

Tonsil Snare with ratchet

285mm, 11¹/₄"

430-604-280

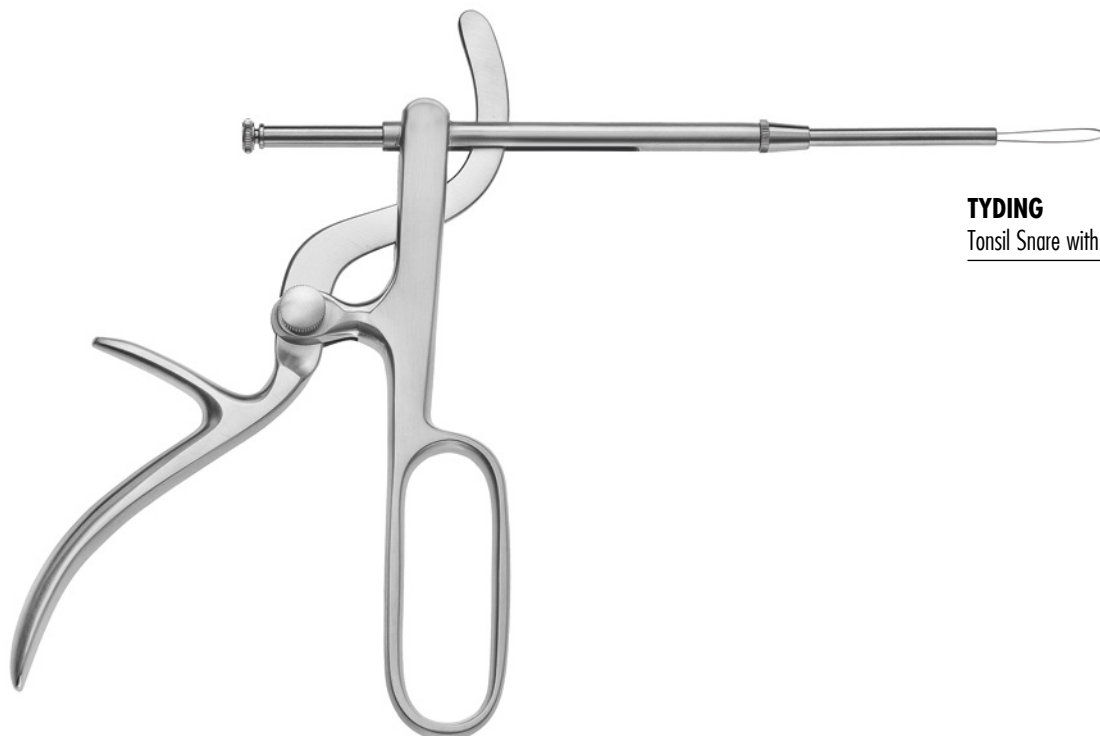
**TYDING**

Tonsil Snare with detachable straight tip

430-620-000

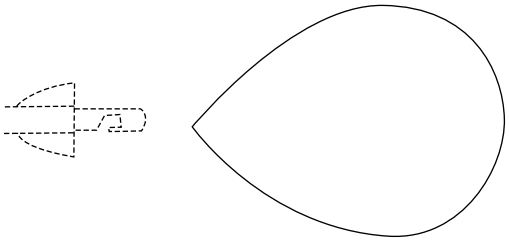
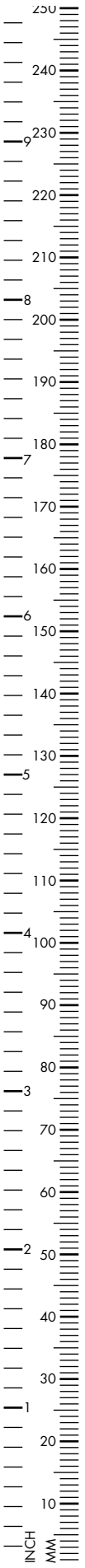

Wire Loop, package of 100 pieces

Ø 0.4mm x 40mm	430-606-040
Ø 0.4mm x 50mm	430-607-040



Wire Cutting Scissors, serrated,
120mm, 4^{3/4}"

	120-265-120
TC	120-565-120

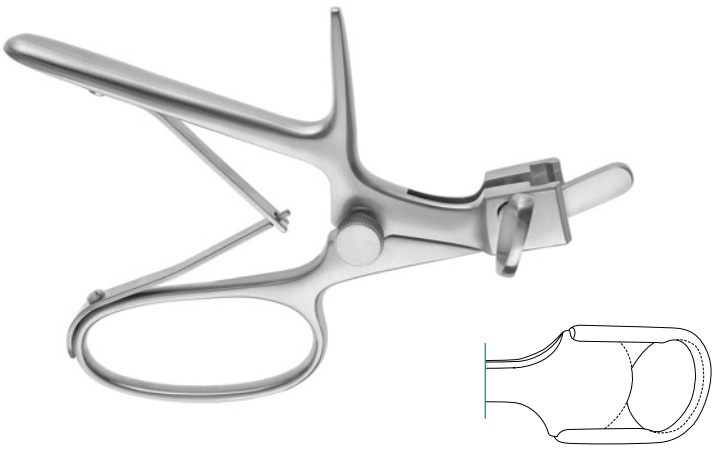

SLUDER-BALLENGER

Tonsillotome Handle for blades
430-650-001 - 430-650-003

	430-650-100
--	-------------

Blades

Fig. 1	430-650-001
Fig. 2	430-650-002
Fig. 3	430-650-003

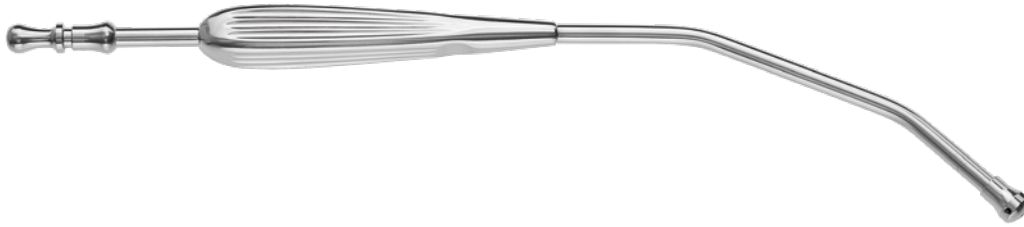
**YANKAUER**

Suction Tube

270mm, 10^{7/8}"

165-543-270

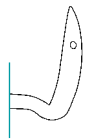
**HURD**Ligature Needle, 210mm, 8^{1/4}"

right

180-719-210

left

180-718-210

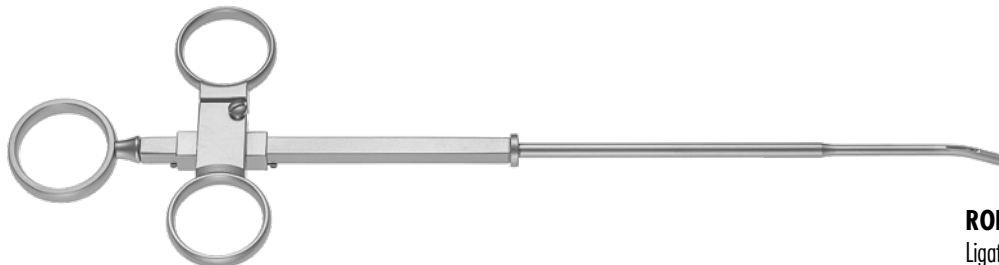
**ROEDER**

Ligature Instrument

260mm, 10^{1/4}"

430-500-260

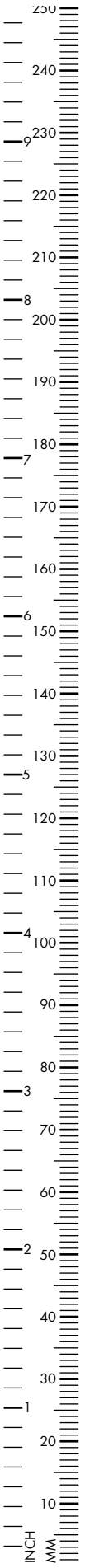

NEGUS

Knot Tier

205mm, 8¹/₈"

430-505-205



LUNIATSCHEK

Gauze Packer, 2mm

190mm, 7¹/₂"

430-602-175

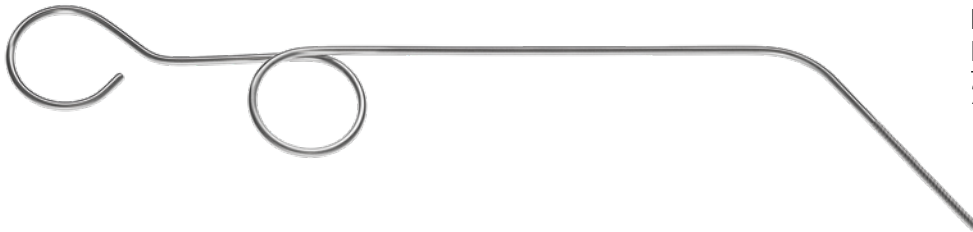

HARTMANN

Postnasal Applicator, spiral end, Ø 2.3mm

220mm, 8²/₃"

160-481-200

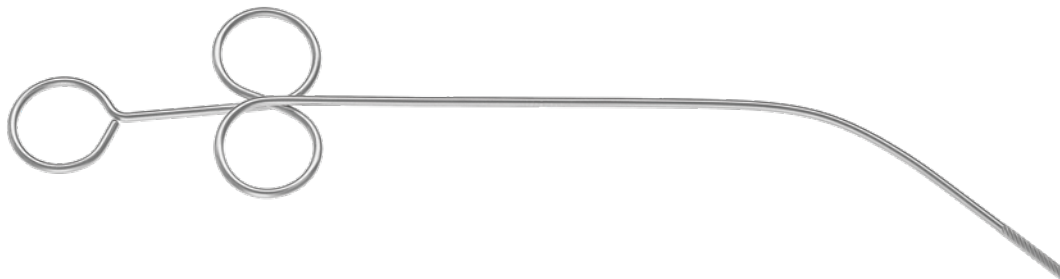

FEIN

Postnasal Applicator

280mm, 11"

160-495-280



Laryngeal Mirror, hexagonal handle,
180mm, 7"

∅ 6mm, Fig. 000	230-330-006
∅ 8mm, Fig. 00	230-330-008
∅ 10mm, Fig. 0	230-330-010
∅ 12mm, Fig. 1	230-330-012
∅ 14mm, Fig. 2	230-330-014
∅ 16mm, Fig. 3	230-330-016
∅ 18mm, Fig. 4	230-330-018
∅ 20mm, Fig. 5	230-330-020
∅ 22mm, Fig. 6	230-330-022
∅ 24mm, Fig. 7	230-330-024
∅ 26mm, Fig. 8	230-330-026
∅ 28mm, Fig. 9	230-330-028
∅ 30mm, Fig. 10	230-330-030



Laryngeal mirror, insert only,
120mm, 4³/₄"

∅ 6mm, Fig. 000	230-329-006
∅ 8mm, Fig. 00	230-329-008
∅ 10mm, Fig. 0	230-329-010
∅ 12mm, Fig. 1	230-329-012
∅ 14mm, Fig. 2	230-329-014
∅ 16mm, Fig. 3	230-329-016
∅ 18mm, Fig. 4	230-329-018
∅ 20mm, Fig. 5	230-329-020
∅ 22mm, Fig. 6	230-329-022
∅ 24mm, Fig. 7	230-329-024
∅ 26mm, Fig. 8	230-329-026
∅ 28mm, Fig. 9	230-329-028
∅ 30mm, Fig. 10	230-329-030



Mirror Handle with set screw

110mm, 4 ¹ / ₃ "	230-331-110
--	-------------

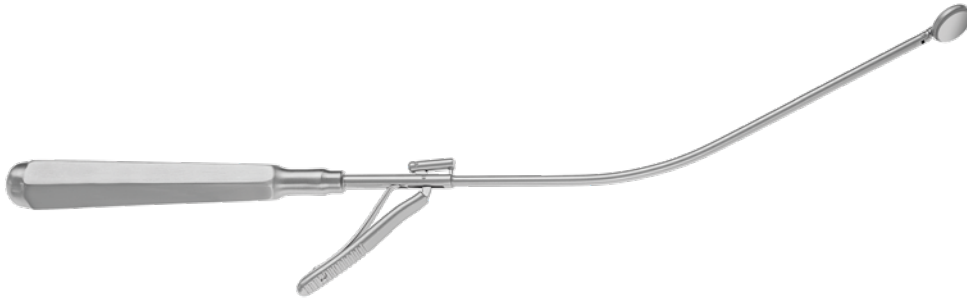
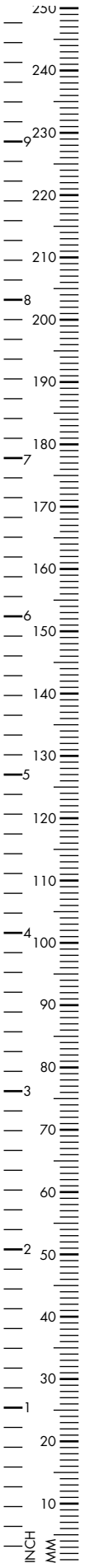

MICHEL

Rhinoscopic mirror with interchangeable mirror inserts, 250mm, 9⁷/₈"

Ø 12mm	430-788-012
Ø 14mm	430-788-014
Ø 16mm	430-788-016
Ø 18mm	430-788-018

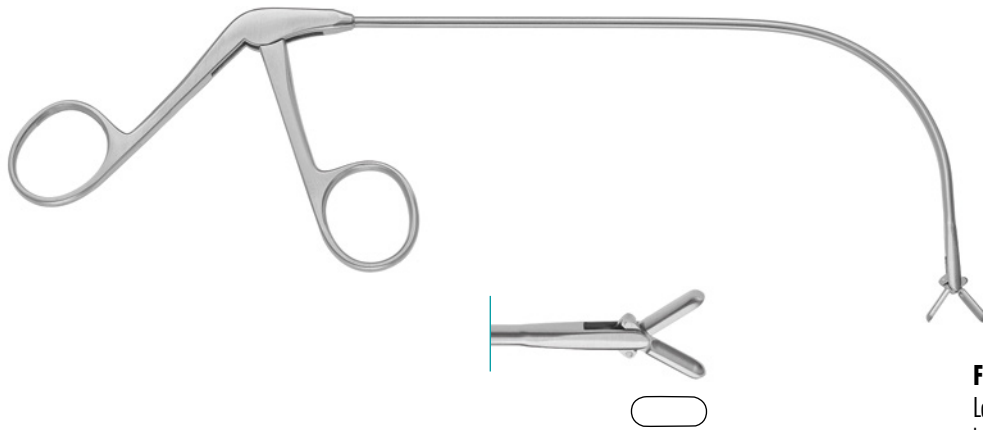

FRAENKEL

Laryngeal Forceps, double action, longitudinal oval jaws

170mm, 6 ² / ₃ "	430-813-050
--	-------------

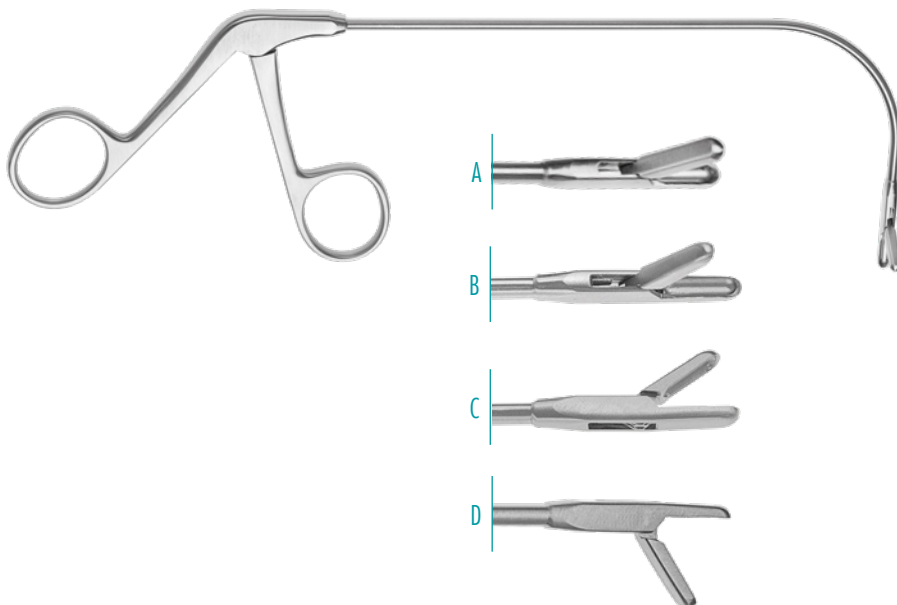

JURASZ

Laryngeal Polypus Forceps, 220mm, 8²/₃"

A opening to right	430-813-010
B opening to left	430-813-020
C opening downwards	430-813-030
D opening upwards	430-813-040

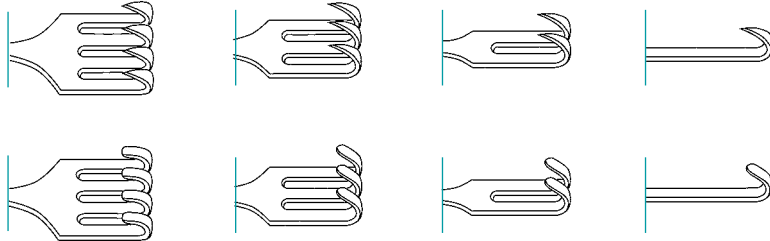

Hand Held Retractor, 160mm, 6¹/₄"
sharp

1 prong	170-074-161
2 prongs	170-074-162
3 prongs	170-074-163
4 prongs	170-074-164

blunt

1 prong	170-075-161
2 prongs	170-075-162
3 prongs	170-075-163
4 prongs	170-075-164

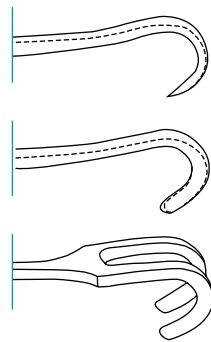

Tracheal Hook, 160mm, 6¹/₄"

sharp	170-005-001
blunt	170-005-002
2 prongs, blunt	170-005-003



LABORDE

Tracheal Dilator

140mm, 5 ¹ / ₂ "	440-130-140
--	-------------

**TROUSSEAU**

Tracheal Dilator

120mm, 4³/₄" 440-120-120140mm, 5¹/₂" 440-120-140**KOCHER**

Goitre Director with hole

160mm, 6¹/₄" 440-221-160

LARYNGOSCOPY



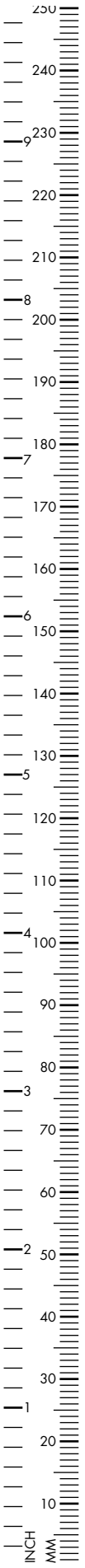

Naso-Pharyngo-Laryngoscope, flexible,
300mm working length

Ø 2.2mm	100-500-220
Ø 2.8mm	100-500-280
Ø 3.2mm	100-500-320
Ø 3.4mm	100-500-340



Naso-Pharyngo-Laryngoscope, flexible,
300mm working length,
with working channel

Ø 2.8mm	100-500-285
Ø 1.2mm working channel	
Ø 3.8mm	100-500-385
Ø 1.4mm working channel	



Laryngoscope, Ø 10mm, 90°
160mm working length

270mm, 10²/₃" 100-800-090

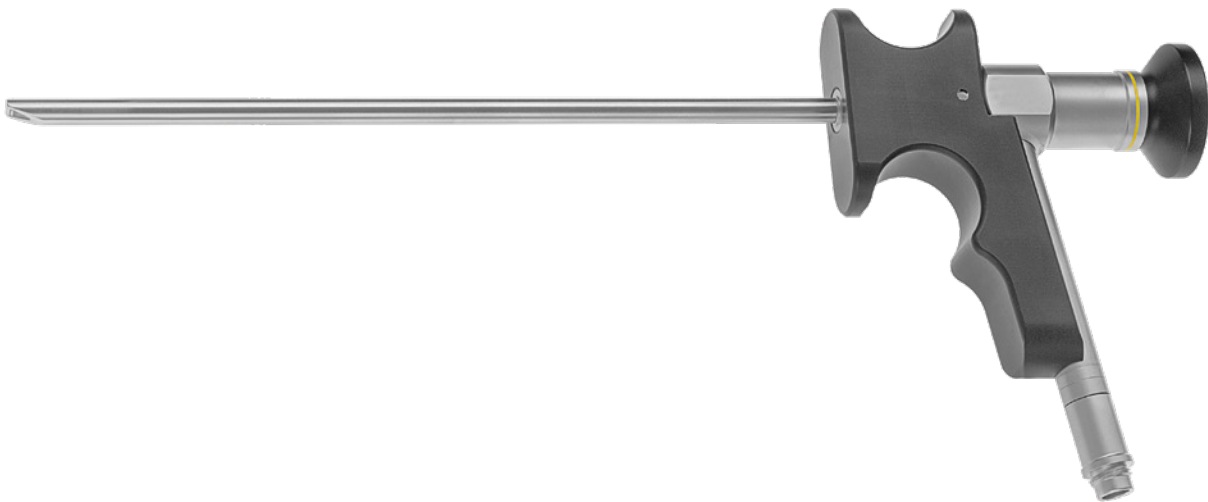

Laryngoscope with handle,
70° angle of view, 190mm, 7¹/₂"

Ø 5mm 100-805-070

Ø 6mm 100-806-070

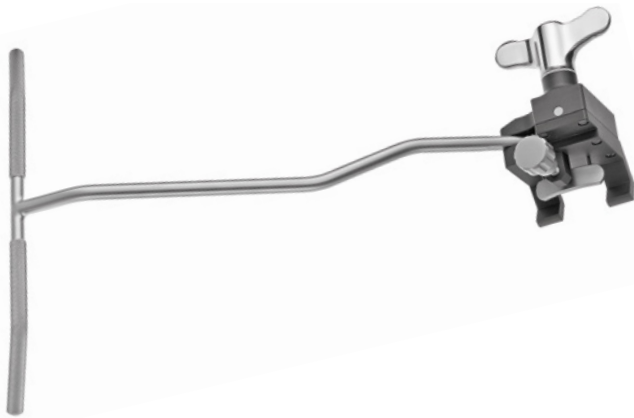
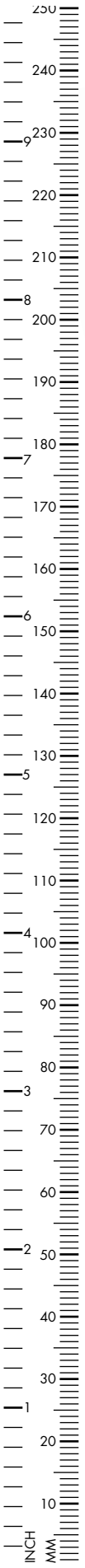

LEWY

Chest Support, for Operating Laryngoscopes

340mm, 13¹/₂" 100-500-102



Laryngoscope Handle, detachable,
for LEWY Chest Support
and Operating Laryngoscopes

100-512-000



Chest Support, complete,
for Operating Laryngoscopes

Ø95mm / Adult 100-500-100

Ø95mm / Children 100-500-101



Support Rod, with ring

340mm, 13¹/₂" 100-500-113

240mm, 9¹/₂" 100-500-111



Joint for Chest Support

100-500-110



Supporting Table for Chest Support,
complete set

100-500-150

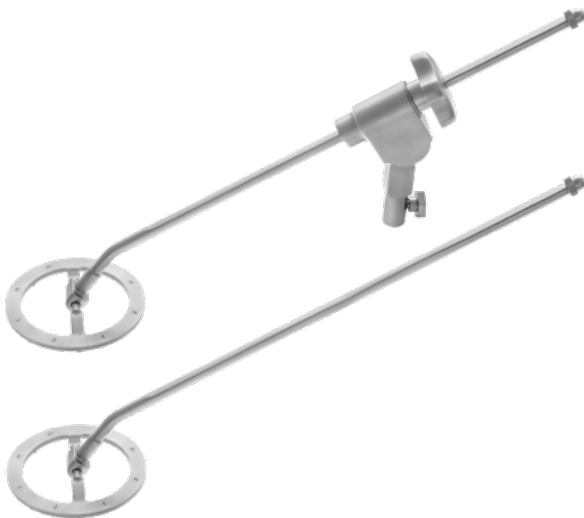

Chest Support, complete,
for Operating Laryngoscopes

Ø90mm 100-500-200

Support Rod

340mm, 13¹/₂" 100-500-210

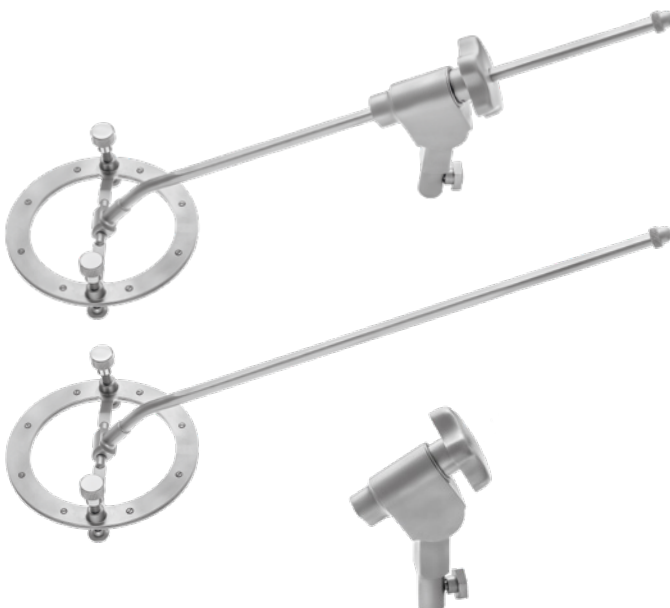

Chest Support, complete,
for Operating Laryngoscopes

Ø120mm 100-500-400

Support Rod

340mm, 13¹/₂" 100-500-410

Joint for Chest Support

100-500-420

**HOLINGER**

Laryngoscope, complete with light carrier

small, Newborn, 90mm, 3 ¹ / ₂ "	100-510-000
--	-------------

small, Babies, 120mm, 4 ³ / ₄ "	100-510-001
--	-------------

large, Children, 170mm, 6 ² / ₃ "	100-510-002
--	-------------

large, Adult, 180mm, 7"	100-510-003
----------------------------	-------------

spare light carrier

Newborn	100-510-100
---------	-------------

Babies	100-510-101
--------	-------------

Children	100-510-102
----------	-------------

Adult	100-510-103
-------	-------------

**JACKSON**

Laryngoscope, complete with light carrier

small, Newborn, 90mm, 3 ¹ / ₂ "	100-505-000
--	-------------

small, Babies, 125mm, 8"	100-505-001
-----------------------------	-------------

large, Children, 170mm, 6 ² / ₃ "	100-505-002
--	-------------

large, Adult, 180mm, 7"	100-505-003
----------------------------	-------------

spare light carrier

Newborn	100-505-100
---------	-------------

Babies	100-505-101
--------	-------------

Children	100-505-102
----------	-------------

Adult	100-505-103
-------	-------------

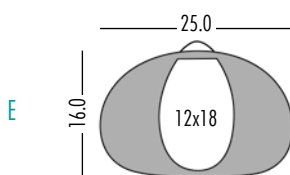
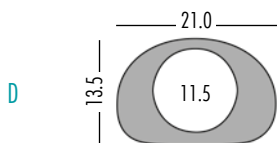
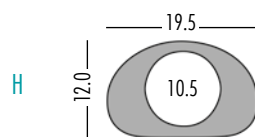
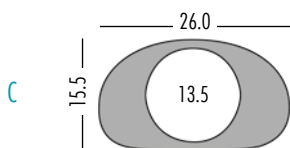
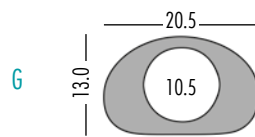
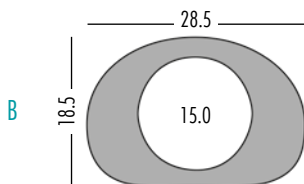
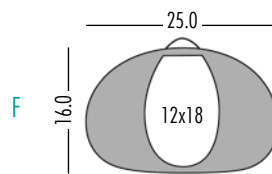
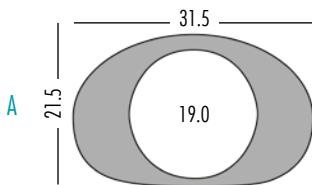
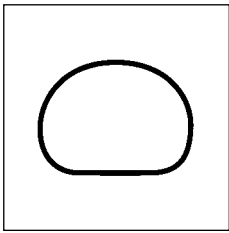

KLEINSASSER

Operation Laryngoscope

A extra large, Adults, 170mm, 6 ² / ₃ "	100-500-008
B extra large, Adults, 170mm, 6 ² / ₃ "	100-500-005
C medium, Adults, 170mm, 6 ² / ₃ "	100-500-004
D small, Adults, 180mm, 7"	100-500-003
E medium, anterior Adults, 170mm, 6 ² / ₃ "	100-500-006
F medium, long neck, Adults 220mm, 8 ² / ₃ "	100-500-007
G small, Children, 150mm, 6"	100-500-002
H small, Infants, 130mm, 5"	100-500-001

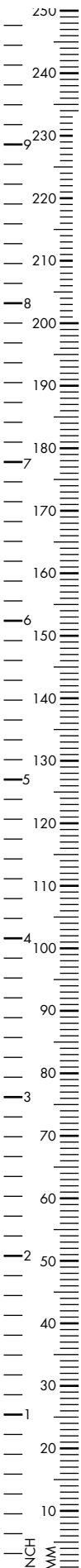

Fiber Optic Light Carrier
for
100-500-001/100-500-002
100-500-201/100-500-202

75mm, 3" 100-500-019

for
100-500-003 - 100-500-008
100-500-203 - 100-500-208

140mm, 5^{1/2}" 100-500-020



Fiber Optic Light Carrier, large
for
100-500-007 & 100-500-207

100-500-021



Suction Tube, \varnothing 3mm
for
100-500-001/100-500-002

90mm, 3^{1/2}" 100-500-080

for
100-500-003/100-500-008

125mm, 5" 100-500-075



Injection Cannula
for
100-500-001 - 100-500-008
100-500-201 - 100-500-208

85mm, 3^{1/4}" 100-500-050

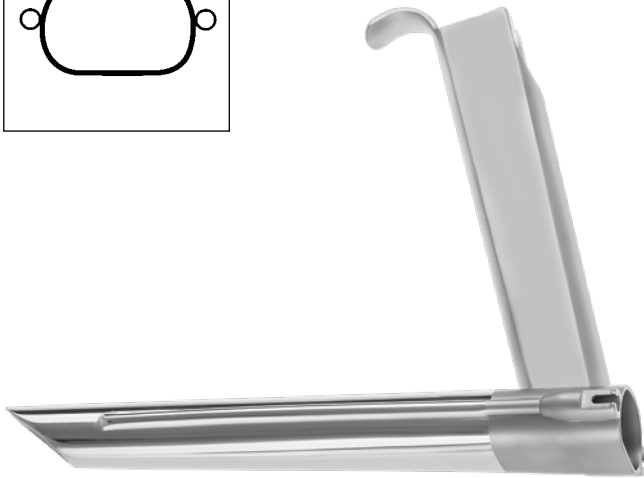
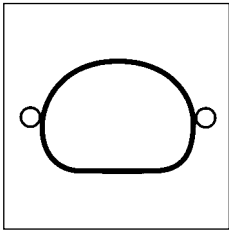

KLEINSASSER-LASER

Operation Laryngoscope

A extra large, Adults, 170mm, 6 ² / ₃ "	100-500-537
B extra large, Adults, 170mm, 6 ² / ₃ "	100-500-536
C medium, Adults, 170mm, 6 ² / ₃ "	100-500-535
D small, Adults, 180mm, 7"	100-500-534
E medium, anterior Adults, 170mm, 6 ² / ₃ "	100-500-533
F small, Children, 150mm, 6"	100-500-532
G small, Infants, 130mm, 5"	100-500-531

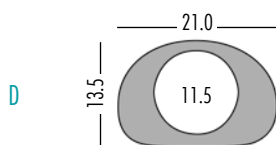
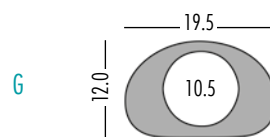
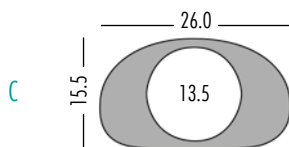
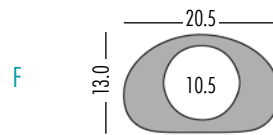
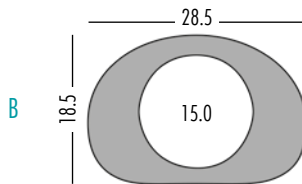
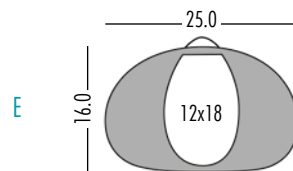
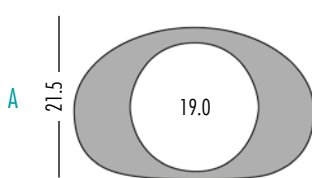

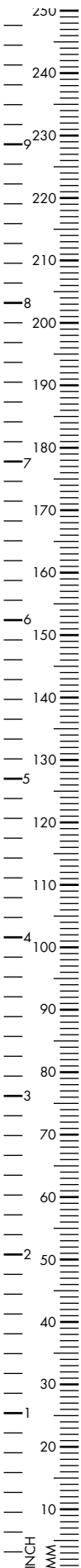

Fiber Optic Light Carrier
for
100-500-562 / 100-500-564

120mm, 4^{3/4}" 100-500-538



Fiber Optic Light Carrier
for
100-500-532

140mm, 5^{1/2}" 100-500-539

for
100-500-533 - 100-500-537

140mm, 5^{1/2}" 100-500-540



Suction Tube
for
100-500-531

120mm, 4^{3/4}" 100-500-541

for
100-500-532

140mm, 5^{1/2}" 100-500-532

for
100-500-533 - 100-500-537

160mm, 6^{1/4}" 100-500-543



KLEINSASSER, B-L.

Operation Laryngoscope

A Children 115mm, 4 ¹ / ₂ "	100-500-552
B Infants 95mm, 3 ³ / ₄ "	100-500-551

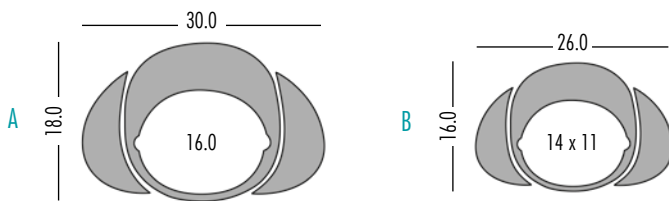

Fiber Optic Light Carrier
for
100-500-563

65mm, 2 ¹ / ₂ "	100-500-556
---------------------------------------	-------------



Suction Tube
for
100-500-552 / 100-500-551

65mm, 2 ¹ / ₂ "	100-500-558
---------------------------------------	-------------



KLEINSASSER, L.

Operation Laryngoscope

A large, Adults 150mm, 6"	100-500-555
B large, Adults 170mm, 6 ² / ₃ "	100-500-554
C small, Children 110mm, 4 ¹ / ₃ "	100-500-553

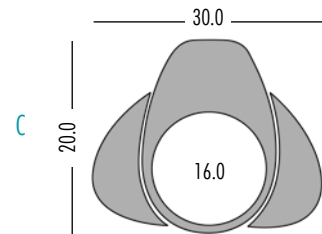
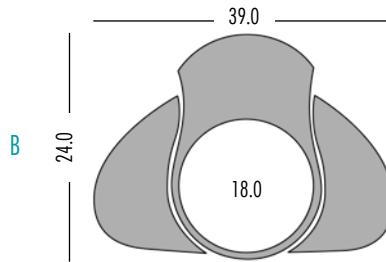
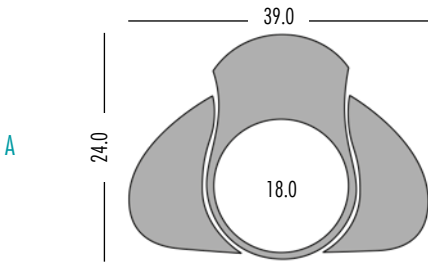

Fiber Optic Light Carrier
for

100-500-553 - 100-500-555

75mm, 3"	100-500-557
----------	-------------



Suction Tube
for

100-500-553

70mm, 2 ³ / ₄ "	100-500-559
---------------------------------------	-------------

for

100-500-555 / 100-500-554

85mm, 3 ¹ / ₄ "	100-500-560
---------------------------------------	-------------



Injection Cannula
for

100-500-553 - 100-500-555

85mm, 3 ¹ / ₄ "	100-500-561
---------------------------------------	-------------

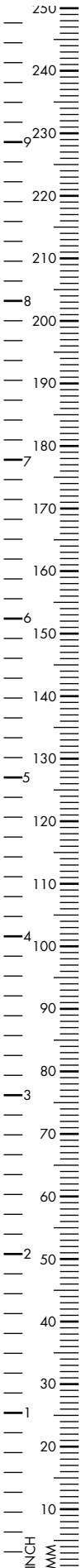



KLEINSASSER, B.

Operation Laryngoscope

A medium, Children 100-500-564
150mm, 6"

B small, Children 100-500-563
115mm, 4 1/2"

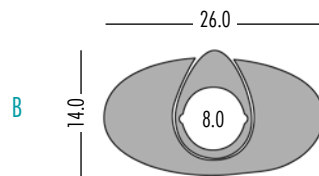
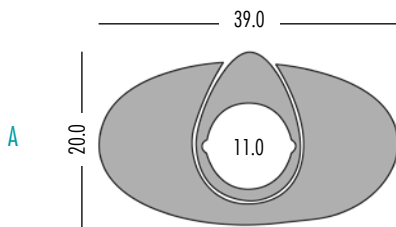

KLEINSASSER, B. - P

Operation Laryngoscope

medium, Children 100-500-562
150mm, 6"

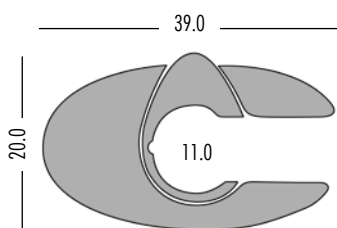



Fiber Optic Light Carrier
for
100-500-562 / 100-500-564

120mm, 4^{3/4}" 100-500-538

for
100-500-563

65mm, 2^{1/2}" 100-500-556



Fiber Optic Light Carrier
for
100-500-531

120mm, 4^{3/4}" 100-500-541



Suction Tube
for
100-500-552 / 100-500-551

65mm, 2^{1/2}" 100-500-558



Light Clip

100-500-576



Injection Cannula, malleable,
135mm, 5^{1/3}"

Ø 2mm 100-500-574

Ø 3mm 100-500-575

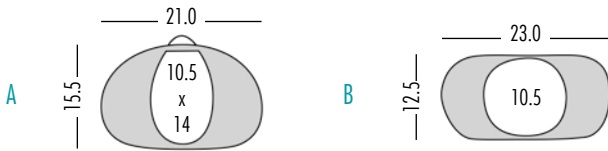

KLEINSASSER, B. - S.

Operation Laryngoscope

A slender, Adult 100-500-573
170mm, 6²/₃"

B extra - slender, Adult 100-500-572
150mm, 6"

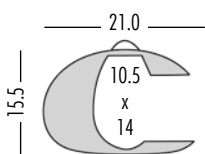

KLEINSASSER, B. - P. - S.

Operation Laryngoscope

slender, Adult 100-500-571
170mm, 6²/₃"

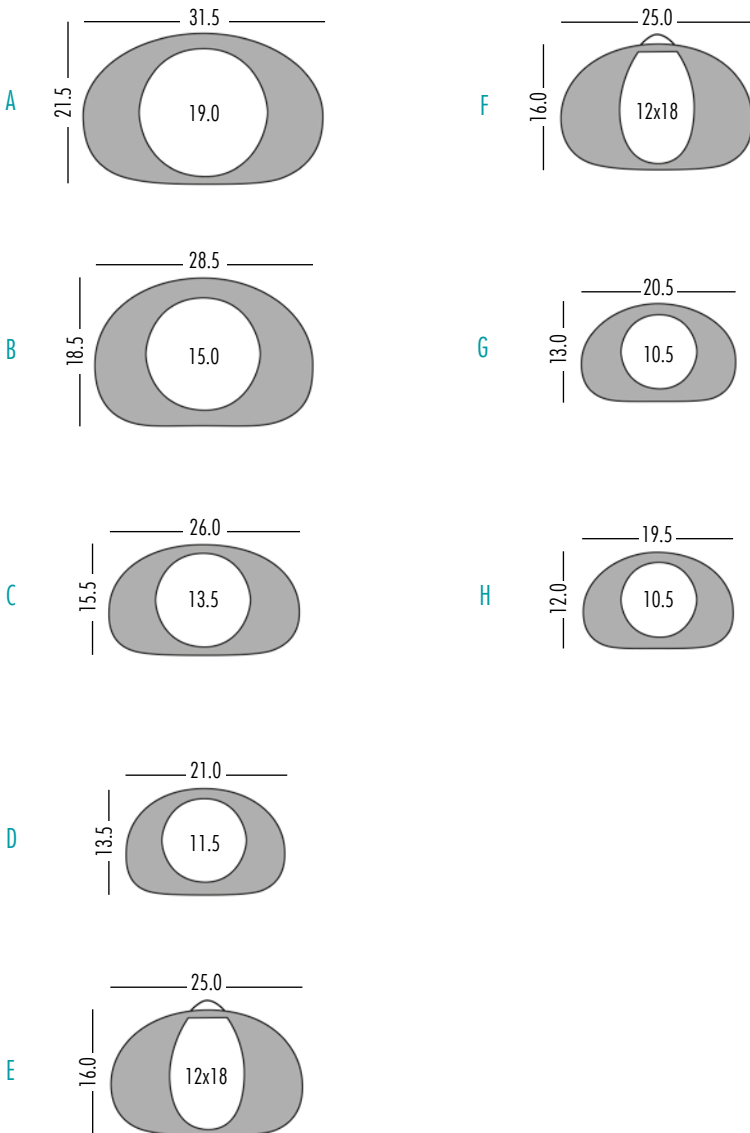

Operation Laryngoscope, spreadable

A extra large, Adults, 170mm, 6 ² / ₃ "	100-500-208
B extra large, Adults, 170mm, 6 ² / ₃ "	100-500-205
C medium, Adults, 170mm, 6 ² / ₃ "	100-500-204
D small, Adults, 180mm, 7"	100-500-203
E medium, anterior Adults, 180mm, 7"	100-500-206
F medium, long neck Adults, 220mm, 8 ² / ₃ "	100-500-207
G small, Children, 150mm, 6"	100-500-202
H small, Infants, 130mm, 5"	100-500-201



Fiber Optic Light Carrier
for
100-500-001/100-500-002
100-500-201/100-500-202

75mm, 3" 100-500-019

for
100-500-003 - 100-500-008
100-500-203 - 100-500-208

140mm, 5¹/₂" 100-500-020



Suction Tube, \varnothing 3mm
for
100-500-001/100-500-002

90mm, 3¹/₂" 100-500-080

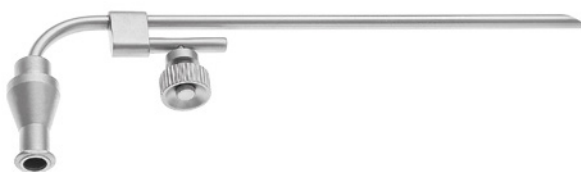

Injection Cannula
for
100-500-001 - 100-500-008
100-500-201 - 100-500-208

85mm, 3¹/₄" 100-500-050



Operation Laryngoscope, spreadable

A extra large, Adults,	100-500-583
180mm, 7"	
B Adolescent / Adults,	100-500-582
180mm, 7"	
C small, Children,	100-500-581
135mm, 5 ¹ / ₃ "	

PROXIMAL

DISTAL

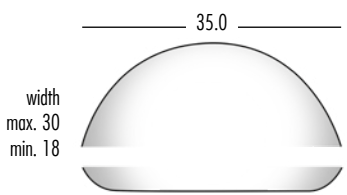

A

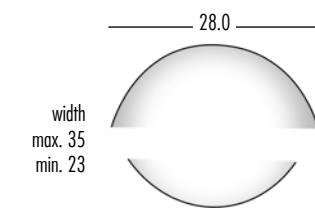
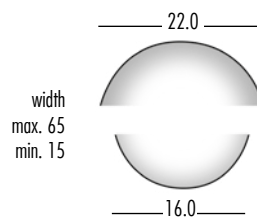

B

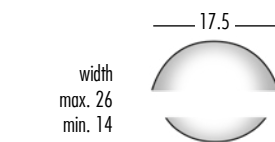
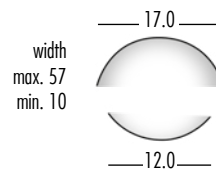

C

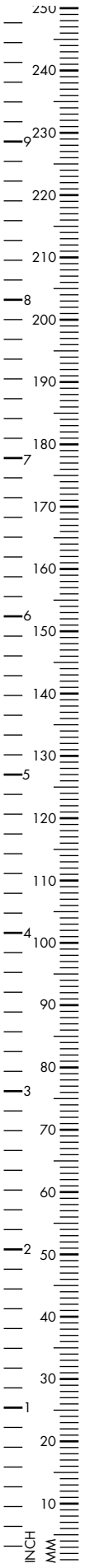
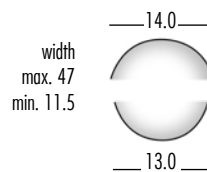



Fiber Optic Light Carrier
for
100-500-583 / 100-500-582

120mm, 4 ^{3/4} "	100-500-584
---------------------------	-------------

for
100-500-581

100mm, 4"	100-500-585
-----------	-------------



Suction Tube
for
100-500-583 / 100-500-582

100mm, 4"	100-500-586
-----------	-------------

for
100-500-581

120mm, 4 ^{3/4} "	100-500-587
---------------------------	-------------



Injection Cannula
for
100-500-583 / 100-500-582

70mm, 2 ^{3/4} "	100-500-588
--------------------------	-------------

Cupped Forceps

Round cupped, jaws, conical tubular shaft,
working length: 230mm, 9"



straight

2mm	100-700-001
4mm	100-700-101

curved upwards

2mm	100-700-002
4mm	100-700-102

curved left

2mm	100-700-003
4mm	100-700-103

curved right

2mm	100-700-004
4mm	100-700-104

curved upwards right

2mm	100-700-005
-----	-------------

curved upwards left

2mm	100-700-006
-----	-------------

horizontal curved right opening

2mm	100-700-007
-----	-------------

horizontal curved left opening

2mm	100-700-008
-----	-------------

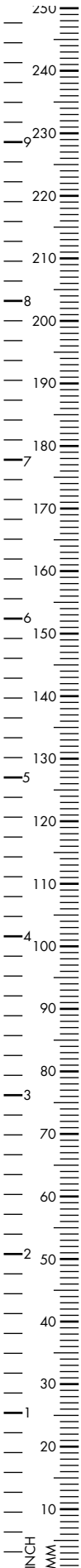

Alligator Forceps

conical tubular shaft, 2mm,
working length: 230mm, 9"



straight

100-700-020



curved right

100-700-021



curved left

100-700-022



curved upwards

100-700-023



triangular jaws, curved upwards right

100-700-024



triangular jaws, curved upwards left

100-700-025



triangular jaws, straight

100-700-026

Micro Laryngeal Scissors

conical tubular shaft, 2mm,
working length: 230mm, 9"

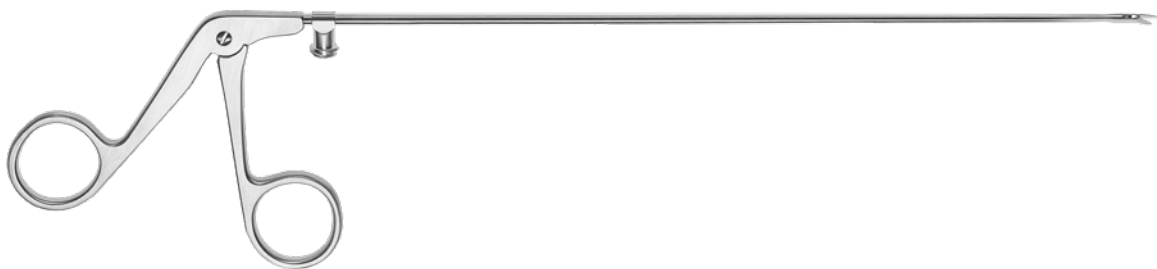

straight

100-700-050



45° upcurved

100-700-051



curved right

100-700-052



curved left

100-700-053



straight, horizontal cutting

100-700-054

Laryngeal Instruments

distal end angled up, conical tubular shaft,
working length: 230mm, 9"

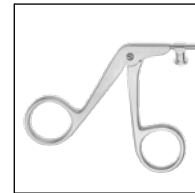
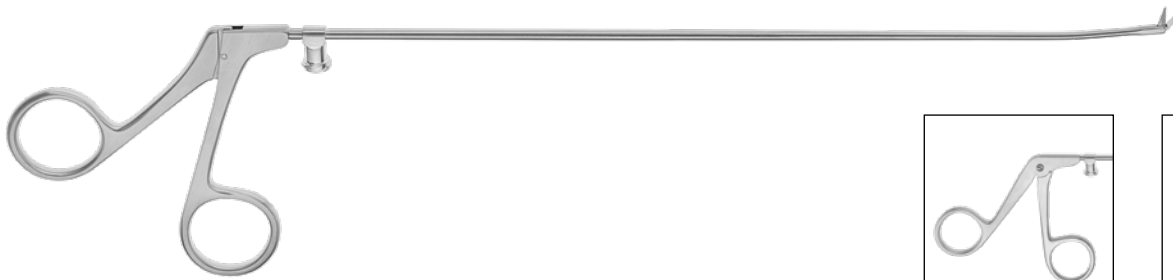

Regular Handle



Handle with thumb control



straight

100-715-001

with thumb control

100-725-001



curved upwards

100-715-002

with thumb control

100-725-002



curved right

100-715-003

with thumb control

100-725-003



curved left

100-715-004

with thumb control

100-725-004



Scissors, straight

100-715-005

with thumb control

100-725-005



Scissors, 45° curved upwards

100-715-006

with thumb control

100-725-006



Scissors, curved right

100-715-007

with thumb control

100-725-007



Scissors, curved left

100-715-008

with thumb control

100-725-008

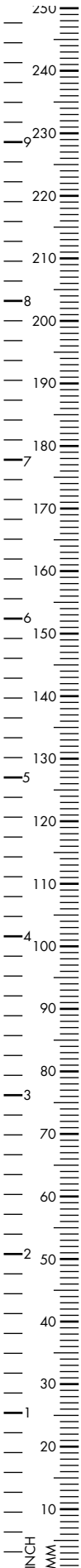

Laryngeal Instruments, 360° rotatable

with LuerLock, working length: 235mm, 9¹/₄"

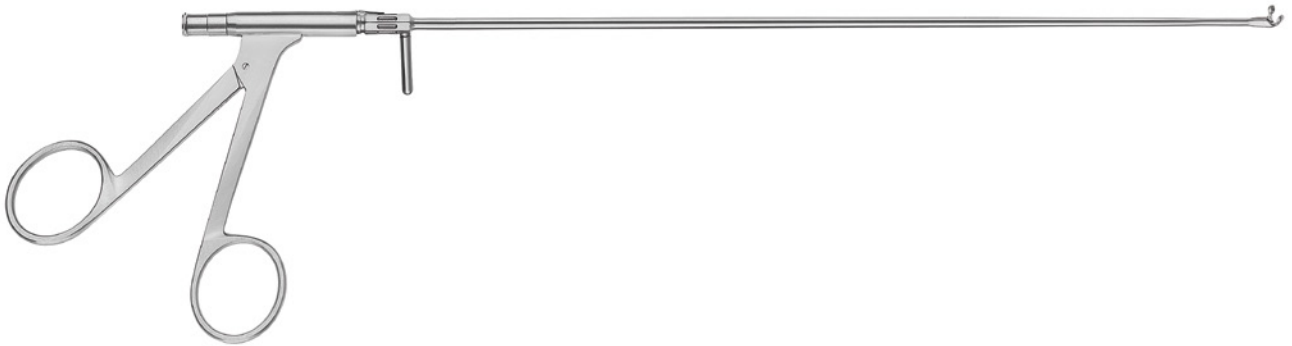

straight
 2mm 100-700-501
 1mm 100-700-511



curved upwards
 2mm 100-700-502
 1mm 100-700-512



curved right
 2mm 100-700-503
 1mm 100-700-513



curved left
 2mm 100-700-504
 1mm 100-700-514



straight
 100-700-520



curved upwards
 100-700-523



curved right
 100-700-521



curved upwards
 100-700-524



curved left
 100-700-522



straight
 100-700-550



curved upwards
 100-700-551



curved right
 100-700-552



curved left
 100-700-553

Mini Laryngeal Instruments

conical tubular shaft, working length: 230mm, 9"



straight

1mm 100-710-001



curved upwards

1mm 100-710-002



curved right

1mm 100-710-003



curved left

1mm 100-710-004



curved upwards right

1mm 100-710-005



curved upwards left

1mm 100-710-006



straight

100-710-020



curved right

100-710-021



curved left

100-710-022



curved upwards

100-710-023



curved upwards right

100-710-024



curved upwards left

100-710-025



straight

100-710-050



angled 45°

100-710-051



curved right

100-710-052



curved left

100-710-053

KLEINSASSER

Pediatric Laryngeal Instruments

conical tubular shaft, working length: 180mm, 7"

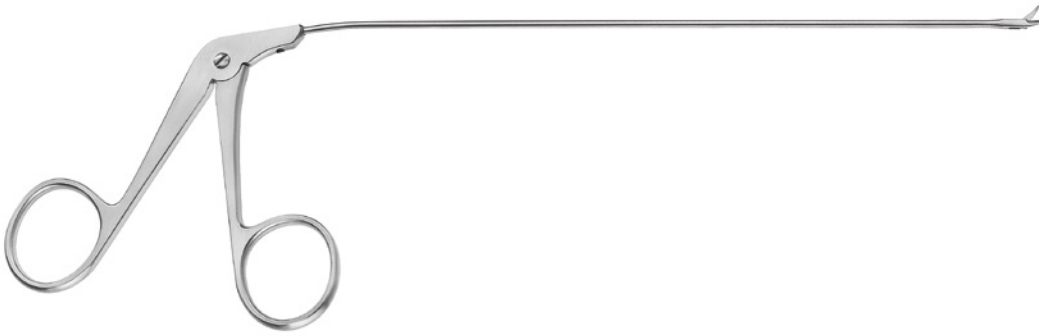

straight

- | | |
|-----|-------------|
| 2mm | 100-712-001 |
| 3mm | 100-712-002 |



curved upwards

- | | |
|-----|-------------|
| 2mm | 100-712-003 |
| 3mm | 100-712-004 |



straight

100-712-005



curved upwards

100-712-013



straight

100-712-006



45° angled

100-712-007



curved right

100-712-008



curved left

100-712-009

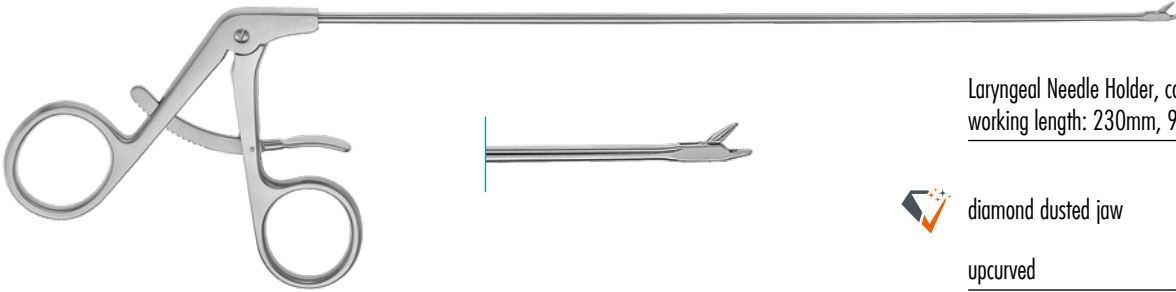
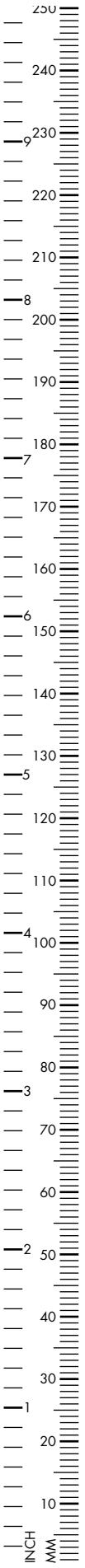

Laryngeal Needle Holder, conical tubular shaft,
working length: 230mm, 9"



diamond dusted jaw 100-700-210

upcurved 100-700-230

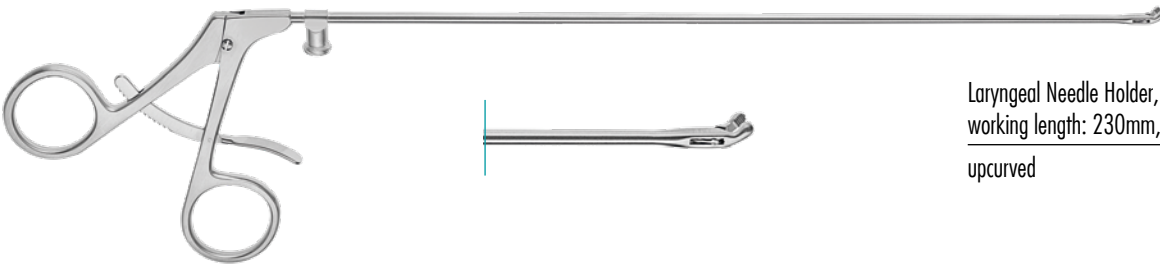

Laryngeal Needle Holder, conical tubular shaft,
working length: 230mm, 9"

upcurved 100-700-230

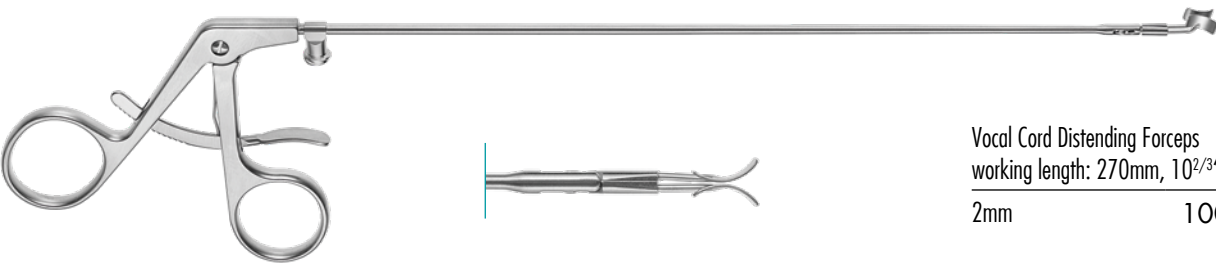

Vocal Cord Distending Forceps
working length: 270mm, 10²/₃"

2mm 100-700-270

Laryngeal Instruments for Microsurgery

total length: 250mm, 9^{7/8}"



Knife, round, 45° angled

Ø 2.5mm 100-850-001



Knife, round, vertical cutting

100-850-002



Knife, oval, straight

100-850-003



Knife, sickle shaped

100-850-004



Knife, golfstick-shaped

100-850-005



Hook, with probe end blunt

100-850-006



Hook sharp

100-850-007



Ligature needle curved right

100-850-008



Ligature Needle curved left

100-850-009



Elevator with suction channel

100-850-010



Knot guide

100-850-011



Hook with probe end 90° angled

100-850-012



Elevator, slightly curved

100-850-013



Elevator, 90° curved

100-850-014



Knife, straight, lance-shaped

100-850-015



100-850-000
Handle only

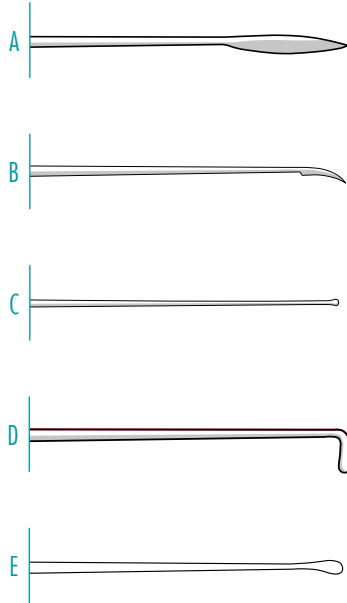
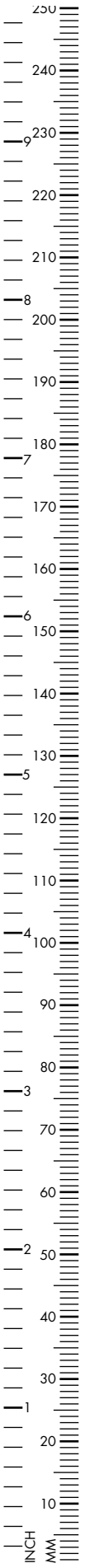

JAKO-TYPE

295mm, 11²/₃"

- | | |
|---|-------------|
| A Laryngeal Knife,
8mm blade length | 100-853-295 |
| B Laryngeal
Sickle Knife,
8mm blade length | 100-854-295 |
| C Laryngeal Probe,
straight | 100-855-300 |
| D Laryngeal Probe,
90° angled | 100-856-300 |
| A Micro Dissector
blunt, 4mm wide | 100-857-300 |

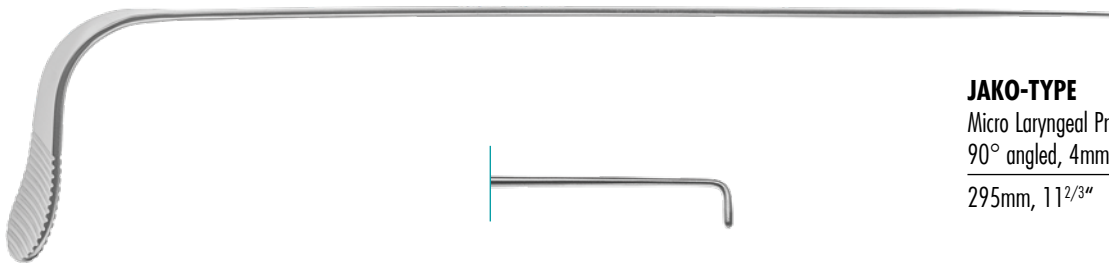

JAKO-TYPE

Micro Laryngeal Probe, thumb handle,
90° angled, 4mm

295mm, 11²/₃" 100-860-300

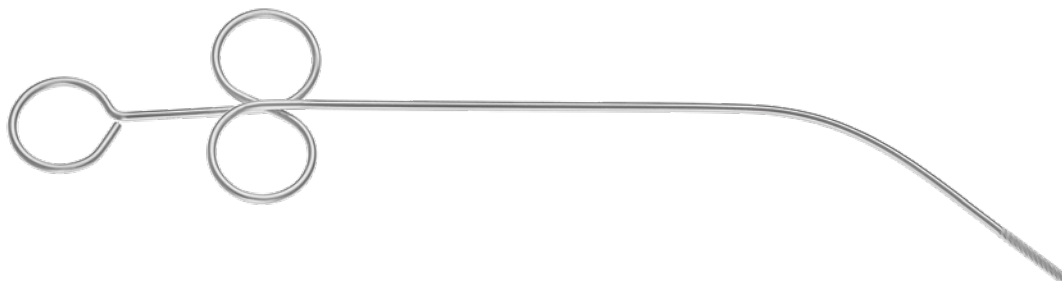

Cotton Applicator, twist end serrated,
Ø 2.3mm

280mm, 11" 100-864-280

Suction Tube, 250mm, 9⁷/₈"

Ø 2.0mm	100-860-020
Ø 2.5mm	100-860-025
Ø 3.0mm	100-860-030

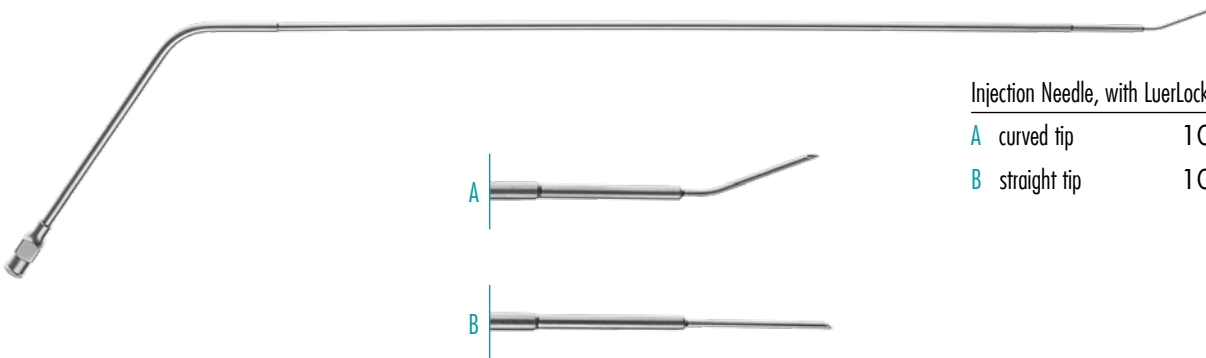

Injection Needle, with LuerLock

A curved tip	100-861-001
B straight tip	100-861-002

Suction/Coagulation Cannula, insulated,
monopolar connection, angled

2.5mm, 280mm, 11"	100-862-030
5.0mm, 270mm, 10 ² / ₃ "	100-864-030

Laser Laryngeal Suction Tubes

with laser protector and smoke channel,
230mm, 9"



round, upwards angled

- Ø 3mm 100-850-503
- Ø 4mm 100-850-504
- Ø 5mm 100-850-505
- Ø 7mm 100-850-547



oval, straight, distal opening left side

100-850-505



oval, straight, distal opening right side

100-850-512



bayonet shaped, distal opening left side

100-850-531



bayonet shaped, distal opening right side

100-850-532



square shaped, distal opening left side

100-850-521



square shaped, distal opening right side

100-850-522



Suction Tube

Ø 2.5mm 100-860-525



Suction Tube, lateral perforated

Ø 3.5mm 100-860-630



Suction Tube, distal closed, lateral perforated

Ø 3.0mm 100-860-730



Teeth Protector, silicone

100-870-100

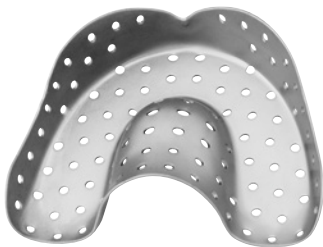

Teeth Protector, metal

Fig. 0 / Children 100-870-000

Fig. 1 100-870-001

Fig. 2 100-870-002

Fig. 3 100-870-003



Bronchoscopy forceps, tubular shaft,
double-action jaws



Foreign Body Forceps, alligator jaws
Ø 2.0mm shaft

250mm, 9 ⁷ / ₈ "	100-720-001
350mm, 13 ³ / ₄ "	100-720-011



Universal Biopsy and Grasping Forceps
Ø 2.0mm shaft

250mm, 9 ⁷ / ₈ "	100-720-002
350mm, 13 ³ / ₄ "	100-720-012



Biopsy Cup Forceps, straight, round cup
Ø 2.0mm shaft

250mm, 9 ⁷ / ₈ "	100-720-003
350mm, 13 ³ / ₄ "	100-720-013



Grasping Forceps, fenestrated jaw
Ø 2.0mm shaft

250mm, 9 ⁷ / ₈ "	100-720-004
350mm, 13 ³ / ₄ "	100-720-014



Foreign Body, alligator jaws
Ø 2.5mm shaft

350mm, 13 ³ / ₄ "	100-720-021
500mm, 19 ³ / ₄ "	100-720-031



Universal Biopsy and Grasping Forceps
Ø 2.5mm shaft

350mm, 13 ³ / ₄ "	100-720-022
500mm, 19 ³ / ₄ "	100-720-032



Grasping Forceps, fenestrated jaw
Ø 2.5mm shaft

350mm, 13 ³ / ₄ "	100-720-024
500mm, 19 ³ / ₄ "	100-720-034

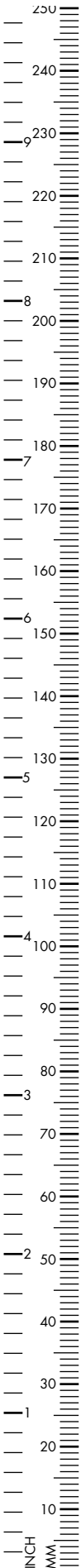

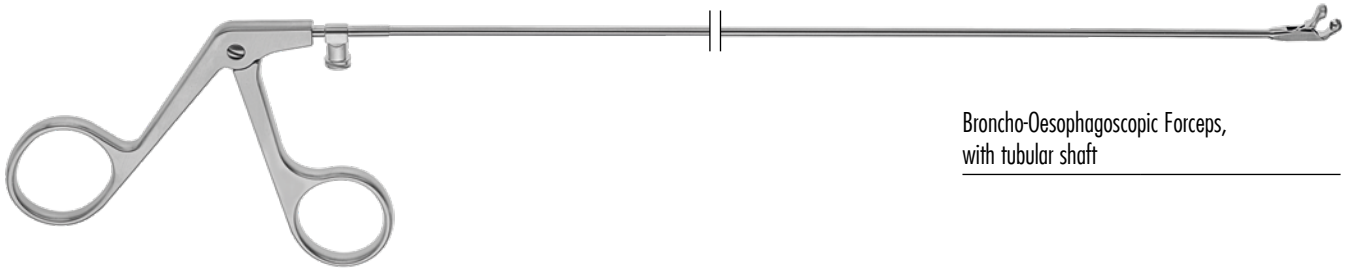

Broncho-Oesophagoscopic Forceps,
with tubular shaft



Grasping Forceps, serrated
Ø 2.5mm shaft

400mm, 15 ^{3/4} "	100-720-402
500mm, 19 ^{1/2} "	100-720-502
600mm, 23 ^{1/2} "	100-720-602
Ø 1.5mm shaft	
350mm, 13 ^{3/4} "	100-720-302



Grasping Forceps, serrated, fenestrated
Ø 2.5mm shaft

400mm, 15 ^{3/4} "	100-720-403
500mm, 19 ^{1/2} "	100-720-503
600mm, 23 ^{1/2} "	100-720-603
Ø 1.5mm shaft	
350mm, 13 ^{3/4} "	100-720-303



Alligator teeth
Ø 2.5mm shaft

400mm, 15 ^{3/4} "	100-720-404
500mm, 19 ^{1/2} "	100-720-504
600mm, 23 ^{1/2} "	100-720-604
Ø 1.5mm shaft	
350mm, 13 ^{3/4} "	100-720-304



Cupped Forceps, straight
Ø 2.5mm shaft

400mm, 15 ^{3/4} "	100-720-405
500mm, 19 ^{1/2} "	100-720-505
600mm, 23 ^{1/2} "	100-720-605
Ø 1.5mm shaft	
350mm, 13 ^{3/4} "	100-720-305



Cupped Forceps, horizontal upcurved
Ø 2.5mm shaft

400mm, 15 ^{3/4} "	100-720-406
500mm, 19 ^{1/2} "	100-720-506
600mm, 23 ^{1/2} "	100-720-606
Ø 1.5mm shaft	
350mm, 13 ^{3/4} "	100-720-306



Cupped Forceps, vertical upcurved
Ø 2.5mm shaft

400mm, 15 ^{3/4} "	100-720-407
500mm, 19 ^{1/2} "	100-720-507
600mm, 23 ^{1/2} "	100-720-607
Ø 1.5mm shaft	
350mm, 13 ^{3/4} "	100-720-307



Cupped Forceps, right curved
Ø 2.5mm shaft

400mm, 15 ^{3/4} "	100-720-408
500mm, 19 ^{1/2} "	100-720-508
600mm, 23 ^{1/2} "	100-720-608
Ø 1.5mm shaft	
350mm, 13 ^{3/4} "	100-720-308



Cupped Forceps, left curved
Ø 2.5mm shaft

400mm, 15 ^{3/4} "	100-720-409
500mm, 19 ^{1/2} "	100-720-509
600mm, 23 ^{1/2} "	100-720-609
Ø 1.5mm shaft	
350mm, 13 ^{3/4} "	100-720-309

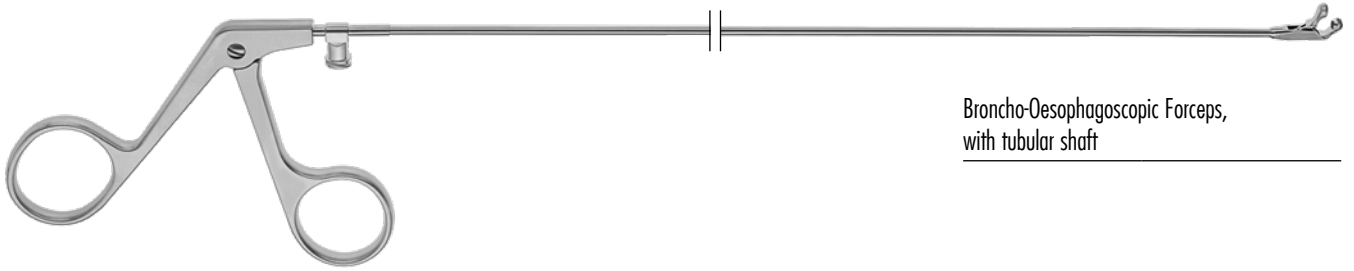

Broncho-Oesophagoscopic Forceps,
with tubular shaft



Cupped Forceps, oblong, straight
Ø 2.5mm shaft

400mm, 15 ³ / ₄ "	100-720-410
500mm, 19 ¹ / ₂ "	100-720-510
600mm, 23 ¹ / ₂ "	100-720-610



Cupped Forces, oval, straight
Ø 2.5mm shaft

400mm, 15 ³ / ₄ "	100-720-411
500mm, 19 ¹ / ₂ "	100-720-511
600mm, 23 ¹ / ₂ "	100-720-611



Cupped Forces, oval, straight
Ø 1.5mm shaft

400mm, 15 ³ / ₄ "	100-720-412
500mm, 19 ¹ / ₂ "	100-720-512
600mm, 23 ¹ / ₂ "	100-720-612
Ø 1.5mm shaft	
350mm, 13 ³ / ₄ "	100-720-312



Cupped Forceps, oval, serrated, straight
Ø 2.5mm shaft

400mm, 15 ³ / ₄ "	100-720-413
500mm, 19 ¹ / ₂ "	100-720-513
600mm, 23 ¹ / ₂ "	100-720-613
Ø 1.5mm shaft	
350mm, 13 ³ / ₄ "	100-720-313

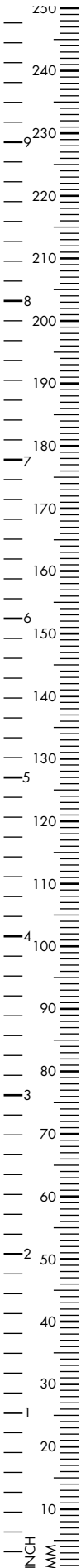

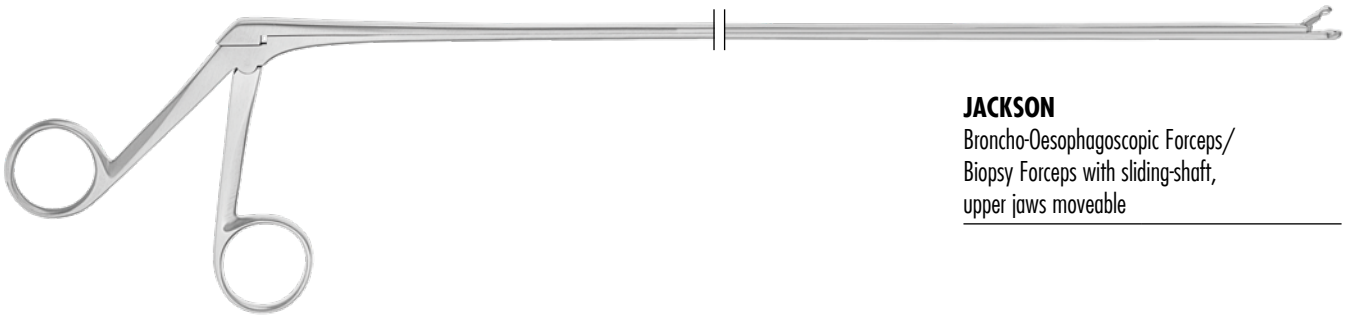
**JACKSON**

Broncho-Oesophagoscopic Forceps/
Biopsy Forceps with sliding-shaft,
upper jaws moveable



serrated

300mm, 11 ⁷ / ₈ "	100-750-301
400mm, 15 ³ / ₄ "	100-750-401
500mm, 19 ¹ / ₂ "	100-750-501
600mm, 23 ¹ / ₂ "	100-750-601



1x2 teeth

300mm, 11 ⁷ / ₈ "	100-750-302
400mm, 15 ³ / ₄ "	100-750-402
500mm, 19 ¹ / ₂ "	100-750-502
600mm, 23 ¹ / ₂ "	100-750-602



Alligator teeth

300mm, 11 ⁷ / ₈ "	100-750-303
400mm, 15 ³ / ₄ "	100-750-403
500mm, 19 ¹ / ₂ "	100-750-503
600mm, 23 ¹ / ₂ "	100-750-603

cupped jaws, straight
Ø 2.0mm

300mm, 11 ⁷ / ₈ "	100-750-304
400mm, 15 ³ / ₄ "	100-750-404
500mm, 19 ¹ / ₂ "	100-750-504
600mm, 23 ¹ / ₂ "	100-750-604

cupped jaws, upcurved
Ø 2.0mm

300mm, 11 ⁷ / ₈ "	100-750-306
400mm, 15 ³ / ₄ "	100-750-406
500mm, 19 ¹ / ₂ "	100-750-506
600mm, 23 ¹ / ₂ "	100-750-606



spoon, oblong, straight

300mm, 11 ⁷ / ₈ "	100-750-308
400mm, 15 ³ / ₄ "	100-750-408
500mm, 19 ¹ / ₂ "	100-750-508
600mm, 23 ¹ / ₂ "	100-750-608

cupped jaws, straight
Ø 4.0mm

300mm, 11 ⁷ / ₈ "	100-750-305
400mm, 15 ³ / ₄ "	100-750-405
500mm, 19 ¹ / ₂ "	100-750-505
600mm, 23 ¹ / ₂ "	100-750-605

cupped jaws, straight
Ø 4.0mm

300mm, 11 ⁷ / ₈ "	100-750-307
400mm, 15 ³ / ₄ "	100-750-407
500mm, 19 ¹ / ₂ "	100-750-507
600mm, 23 ¹ / ₂ "	100-750-607



punch, angular

300mm, 11 ⁷ / ₈ "	100-750-309
400mm, 15 ³ / ₄ "	100-750-409
500mm, 19 ¹ / ₂ "	100-750-509
600mm, 23 ¹ / ₂ "	100-750-609

punch, round

300mm, 11 ⁷ / ₈ "	100-750-310
400mm, 15 ³ / ₄ "	100-750-410
500mm, 19 ¹ / ₂ "	100-750-510
600mm, 23 ¹ / ₂ "	100-750-610

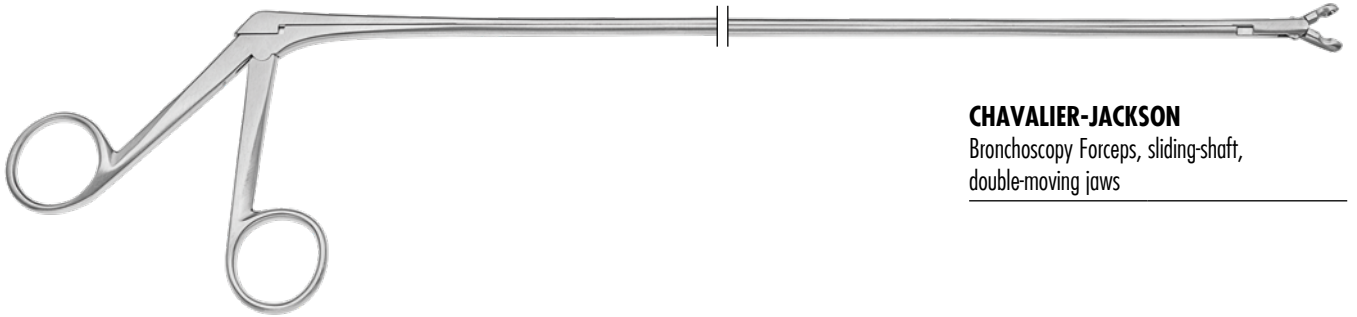

CHAVALIER-JACKSON
Bronchoscopy Forceps, sliding-shaft,
double-moving jaws



Grasping Forceps, serrated jaw

300mm, 11 ⁷ / ₈ "	100-755-305
400mm, 15 ³ / ₄ "	100-755-405
500mm, 19 ¹ / ₂ "	100-755-505
600mm, 23 ¹ / ₂ "	100-755-605



Grasping Forceps, serrated jaw

300mm, 11 ⁷ / ₈ "	100-755-304
400mm, 15 ³ / ₄ "	100-755-404
500mm, 19 ¹ / ₂ "	100-755-504
600mm, 23 ¹ / ₂ "	100-755-604



Cupped Forceps

300mm, 11 ⁷ / ₈ "	100-755-310
400mm, 15 ³ / ₄ "	100-755-410
500mm, 19 ¹ / ₂ "	100-755-510
600mm, 23 ¹ / ₂ "	100-755-610

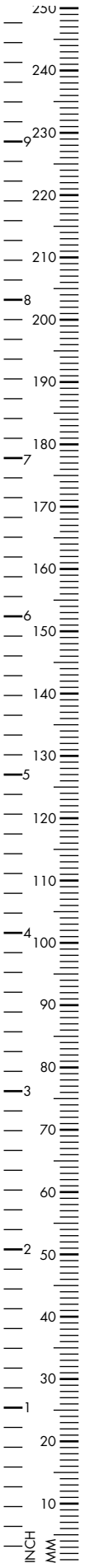

INDEX



A**ADSON ANDERSON**

Self-Retaining Retractor 53

ALDERDICE

Tonsil Dissector 250

ANDERSON-NEIVERT

Osteotome 154

ASH

Septum Straightening Forceps 131

ASTON

Nasal Rasp 164

AUFRICHT

Nasal Specula 100

Nasal Hook 100

Nasal Rasp 160

AUFRICHT

Nasal Retractor 139, 140

AUFRICHT (PEET)

Nasal Rasp 164

AUSTIN

Dissector 71

Attic Dissector 84

Elevator 84

Raspatory 84

Spoon 84

Hook 84

Measuring Probe 85

B**BABY WEITLANER**

Self-Retaining Retractor 52

BABY-EICKEN

Antrum Cannula 183

BALLENGER

Swivel knife 150

Septum Gouge 151

BARBARA

Needles and Hooks 83

BARNES

Suction Tube 42

BARNHILL

Adenoid Curette 243

BARON

Suction Tube 41

BAYOSPHERE

Micro Instruments 219, 220

BEAD

Nasal Forceps 119

BEALES

Raspatory 49

Tendon Knife 73

Elevator 75

BECKER

Septum Scissors 127

BECKMANN

Nasal Specula 93

Adenoid Curette 243

BELLUCCI

Self-Retaining Retractor 53

Micro Ear Scissors 61

Micro Ear Instruments 68

Scissors 124

BEYER

Bone Rongeur 36

Bone punch 193

BILLEAU

Aural Loop 22

BIRKETT

Hemostatic Forceps 256

BLAKESLEY

Nasal Forceps 116, 117, 120, 121

Conchotom 119

Punch 121

Ethmoidal Forceps 200, 202, 203

Spoon Forceps 201, 202

Suction Punch 210

BLAKESLEY (NOLST TRENTÉ)

Nasal Forceps 172

BLAKESLEY-WILDE

Ethmoidal Forceps 45° curved up 200

Ethmoidal Forceps 90° curved up 200

BLOHMKE

Tonsil Holding Forceps 254

BOETTCHER

Tonsil Scissors 251, 252

BOIES

Elevator 131

BOUCHERON

Ear Speculum 13

BOWMAN

Lacrimal Probe 20, 240

BRUENINGS

Aural Magnifier 16

Septum Forceps 125

Tongue Depressor 228

Tonsil Snare 257

BUCHWALD

Tongue Depressor 226

BUCK

Aural Curette 23, 73

C**CAPLAN**

Nasal Scissors 127

CARTER

Septum Elevator 145

CASTROVIEJO

Caliper 170

CHAVALIER-JACKSON

Bronchoscopy Forceps 300

CINELLI

Osteotome 154

CITELLI

Bone punch 193

COAKLEY

Antrum Curette 190

COLLIN (LUCAE)

Mallet 33, 158

COLVER

Tonsil Seizing Forceps 254

CONVERSE

Alar Retractor	137
Nasal Retractor	139, 140

COTTLE

Mallet	33, 158
Nasal Speculum	97
Septum knife	132
Nerve Hook	134
Nasal Retractor	135
Alar Retractor	136
Periosteal Elevator	146
Elevator	146, 147
Chisel	151, 152
Osteotome	152, 153
Nasal Rasp	160
Rasp	165
Bone Crusher	168

COTTLE MASING

Nasal Specula	101
---------------	-----

COTTLE-CINELLI

Chisel	153
--------	-----

COTTLE-JOSEPH

Double Elevator	147
-----------------	-----

COTTLE-NEIVERT

Alar Retractor	138
----------------	-----

COTTLE-WALSHAM

Septum Forceps	130
----------------	-----

CRAIG

Septum Forceps	125
----------------	-----

CUSHING LANDOLT

Specula	218
---------	-----

D**DANIEL**

Elevator	141
----------	-----

DAVIS-BOYLE

Mouth Gag	232
Tongue Blade	236

DAVIS-MEYER

Mouth Gag	231
Tongue Blade	237

DAY

Ear Hook	21
----------	----

DEAN

Tonsil Scissors	252
-----------------	-----

DEBAKEY

TC Needle Holder	241
------------------	-----

DECKER

Rongeur	216
---------	-----

DENHARDT

Mouth Gag	230
-----------	-----

DENIS-BROWNE

Tonsil Holding Forceps	253
------------------------	-----

DIETER

Malleus Nipper	64
----------------	----

DINGMANN

Otobrader	37
Bone Holding Forceps	167
Mouth Gag	233

DOUGHTY

Tongue Blade	238
--------------	-----

DOYEN

Rib Raspatory	168
---------------	-----

DOYEN-JANSEN

Mouth Gag	230
-----------	-----

DRAFFIN

Holder	239
--------	-----

DUCKBILL

Ear Forceps	27
Elevator	75
Punch	203

DUCKBILL-WULLSTEIN

Ear Forceps	59
-------------	----

DUPLAY

Dressing Forceps	246
Nasopharyngeal orceps	247

E**EICKEN**

Periosteal Elevator	31
Antrum Trocar Needle	182
Antrum Cannula	183
Sinus Suction Tube	184

ERLANGEN

Raspatory	31, 149
-----------	---------

EVES

Tonsil Snare with ratchet	257
---------------------------	-----

F**FAHLBUSCH**

Ring Curette	222
Spoon	223

FANOUS-GUBISCH

Osteotome	154
-----------	-----

FARABEUF

Periosteal Elevator	32
---------------------	----

FARRELL

Applicator	20, 102
------------	---------

FARRELL (LATHBURY-UEBE)

Cotton Applicator	102
-------------------	-----

FARRIOR

Aural Speculum	13, 14
----------------	--------

FAULKNER

Antrum Curette	189
----------------	-----

FEIN

Postnasal Applicator	260
----------------------	-----

FERGUSON

Suction Tube	39, 184
--------------	---------

FERRIS-SMITH

Nasal Forceps	120
---------------	-----

FISCH

Suction Tube	44, 186
Dura Elevator	50
Raspatory	51
Ear Forceps	59
Dissector	71, 84
Footplate Perforator	71
Tenotome	74
Excavator	84
Caliper	85
Perforator	85
Reference Instrument	86
Hook	134

FISCHER

Tonsil Knife	241
--------------	-----

FOMON

Alar Retractor	136
TC Rasp	163
Rasp	161, 162, 165
Nasal Rasp Holder	166

FRAENKEL

Laryngeal Forceps	262
-------------------	-----

FRAZIER

Suction Tube	39, 104, 185
--------------	--------------

FREER

Mucosa Knife	132
Skin hook	135
Septum Elevator	141, 142, 187
Periosteal Elevator	147, 149
Septum Chisel	150
Septum Gouge	150

FREER-JOSEPH

Septum Elevator	143
-----------------	-----

FREER-LONG

Septum Elevator	143
-----------------	-----

FREER-YASARGIL

Dissector	142
-----------	-----

FRENCHAY

Nasal Chisel	155
--------------	-----

G**GIERTZ STILLE**

Rib Shears	167
------------	-----

GILLIES

Skin Hook	133
-----------	-----

GLATZEL

Nasal Mirror	107
--------------	-----

GOLDMANN

Septum Elevator	131
-----------------	-----

GOOD

Tonsil Scissors	251
-----------------	-----

GORNEY

Nasal Scissors	127
Suction Raspatory	144

GRAEFE

Micro Skin Hook	133
-----------------	-----

GREVEN

Ear Forceps	64
-------------	----

GROSS MAIER

Swab Forceps	247
--------------	-----

GRUENWALD

Nasal Forceps	103, 114
Sinuscopy Forceps	208
Suction Punch	210

GRUENWALD-HENKE

Nasal Forceps	112, 203
---------------	----------

GUASTELLA

Lateral Osteotomy Forceps	129
Osteotome	156

GUNTER

Lateral Morselizer	130
--------------------	-----

H**HAJEK-KOFLER**

Sphenoid Punch	192
Bone Nibbler	193

HALLE

Raspatory	149
Antrum Curette	188, 190

HALSTEAD MOSQUITO

Hemostatic Forceps	255
--------------------	-----

HARALD

Retractor	138
-----------	-----

HARALDSSON

Suction Elevator	144
------------------	-----

HARDY

Ring Curette	221
Enucleator	225

HARDY FAHLENBUSCH

Enucleator	225
------------	-----

HARTMANN

Aural Speculum	12
Tuning Fork	17
Eustachian Catheter	19
Aural Tampon Forceps	26
Ear Forceps	27, 58, 59
Micro Ear Instruments	68
Nasal Specula	94

Nasal Dressing Forceps	105
Nasal Cutting Forceps	111
Tongue Depressor	229
Postnasal Applicator	260

HARTMANN-HALLE

Nasal Specula	94
---------------	----

HARTMANN-HERZFELD

Ear Forceps	28
-------------	----

HARTMANN-WULLSTEIN

Ear Forceps	58, 60
-------------	--------

HEERMANN

Hook	81
Gouge	88
Mallet	88

HEISTER

Mouth Gag	230
-----------	-----

HENKE

Tonsil Dissector / Pillar Retractor	249
Tonsil Dissector	249

HERBERHOLD

Tongue Blade	236
--------------	-----

HEUWIESER

Antrum Grasping Forceps	207, 208
-------------------------	----------

HEYMAN KNIGHT

Nasal Scissors	109
----------------	-----

HEYMANN

Nasal Scissors	109, 110
----------------	----------

HEYMANN-KNIGHT

Septum Forceps	126
----------------	-----

HILDYARD

Post-Nasal Forceps	123
--------------------	-----

HOFER

Uvula Retractor	242
-----------------	-----

HOLINGER

Laryngoscope	270
--------------	-----

HOLMGREN

Self Retaining Retractor	15
--------------------------	----

HOSOBUCHI

Fork Spatula	224
--------------	-----

HOUGH

Nipper Forceps 63

HOUSE

Suction Cannula 40
 Suction Adapter 42
 Aural Suction Cannula 42
 Self Retaining Retractor 54
 Stapes Elevator 76
 Curette 78
 Double Spoon 78
 Reference Instrument 86

HOUSE BELLUCCI

Ear Scissors 62, 63

HOUSE-MC GEE

Malleus Crimper 64

HOUSE-STAPES

Curette 79

HOWARTH

Elevator 143

HUGHES

Stapes Mobilizer 76
 Elevator 76

HURD

Tonsil Dissector / Pillar Retractor 249
 Ligature Needle 259

J**JACKSON**

Laryngoscope 270
 Broncho-Oesophagoscopic Forceps 299

JAKO-TYPE

Micro Laryngeal Probe 292

JAMESON

Caliper 170

JANSEN

Raspatory 30
 Self Retaining Retractor 52
 Nasal Dressing Forceps 103

JANSEN-MIDDLETON

Nasal Forceps 126
 Nasal Punch 126

JATHO

Nasopharynx Forceps 244

JENNINGS

Mouth Gag 231

JOBSON-HORNE

Aural Probe 21

JOSEPH

Button-End Knife 132
 Nasal Knife 132
 Skin Hook 134
 Septum Elevator 146
 Periosteal Elevator 148
 Nasal Saw 159
 Nasal Rasp 159

JURASZ

Adenoid Cutting 245
 Laryngeal Polypus Forceps 262

K**KAHN-FRAZIER**

Suction Tube 185

KERRISON

Punch 37, 194

KILLIAN

Nasal Speculum 96, 98, 99
 Nasal Probe 102
 Elevator 145
 Raspatory 145
 Septum Elevator 145
 Septum Gouge 151

KILLIAN-CLAUS

Septum Gouge 151

KILLIAN-STRUYPCKEN

Nasal Speculum 95

KILLIAN-WALTER

Nasal Speculum 97

KILNER

Skin Hook 133
 Alar Retractor 137
 Double Hook 138

KILNER-DOUGHTY

Mouth Gag 233
 Tongue Blade 237

KING

Adenoid Forceps 246

KIRSTEIN

Nasal Scissors 110

KLEINERT KUTZ

Rasp 162
 Elevator and Dissector 142

KLEINSASSER

Operation Laryngoscope 271, 273, 275,
 277, 279,
 Pediatric Laryngeal Instruments 289

KLEY

Knife 74

KOCHER

Goitre Director with hole 264

KRAEMER

Raspatory 30

KRAUSE

Ear Polypus Snare 29
 Aural Snare Wire 29
 Nasal Polypus Snare, knee bent 108

KRESSNER

Crushing Forceps 129

KUHN

Ethmoidal Forceps 208

KUHN-BOLGER

Antrum Spoon 189
 Giraffe Forceps 209
 Double Instrument 187

L**LA FORCE**

Adenotome 244

LABORDE

Tracheal Dilator 263

LAHEY

Goitre Seizing Forceps 253

LANDOLT

Spreader	218
Spoon	223
Raspatory	223
Hook	224
Enucleator	225

LANDOLT-REULEN

Ring Curette	222
Raspatory	224
Hook	224
Dissector	224

LANGE

Choana hook	108
-------------	-----

LANGENBECK

Aural Loop	23
Raspatory	30
Bone Holding Forceps	167

LEMPERT

Bone Curette	35
Bone Rongeur	36
Raspatory	50
Micro Ear Elevator	50

LEWIS

Nasal Rasp	160
------------	-----

LICHTWITZ

Antrum Trocar	182
---------------	-----

LICHTWITZ-BIER

Antrum Trocar Needle	182
----------------------	-----

LOPEZ-REINKE

Tonsil Suction Dissector	250
--------------------------	-----

LUBET-BARBON

Polypus Forceps	105
-----------------	-----

LUC

Septum Forceps	126
----------------	-----

LUCAE

Tuning Fork	17
Ear Hook	21
Tympanum Perforator	25
Aural Dressing Forceps	26
Mallet	33, 158

LUNIATSCHEK

Gauze Packer	260
--------------	-----

M**MALINIAC**

Nasal Retractor	139
-----------------	-----

MALTZ

Rasp	159, 163
------	----------

MARSCHIK

Tonsil Grasping Forceps	254
-------------------------	-----

MASING

Cartilage Knife	132
Alar Retractor	136
Elevator	146
Osteotome	155

MAYO

Tongue Depressor	228
------------------	-----

MC GEE

Malleus Crimper	64, 68
Micro Ear Instruments	68

MC IVOR

Mouth Gag	231
Tongue Blade	236

MCINDOE

Bone Cutting Forceps	128
Osteotome	156
Nasal Rasp	159

MCKENTY

Raspatory	148
Sphenoid Punch	192, 193

MELZER

Adenoid Punch	112
Adenoid Forceps	113, 246

METZENBAUM NELSON

Tonsil Scissors	252
-----------------	-----

MICHEL

Rhinoscopic mirror	262
--------------------	-----

MIKULICZ

Periteneal Forceps	255, 256
--------------------	----------

MILLER

Rasp	160
------	-----

MINNESOTA

Cheek Retractor	228
-----------------	-----

MOD. TÜBINGEN

Measuring Instrument	72
----------------------	----

MOD. VIENNA

Nasal Specula	95
---------------	----

MORGENSTEIN

Nasal Forceps	120
---------------	-----

MORITZ-SCHMIDT

Tongue Depressor	229
------------------	-----

MORIYAMA

Conchotom	115
-----------	-----

MUCK

Periosteal Knife	29
------------------	----

MUELLER

Antrum Rasp	186
-------------	-----

MUSEUX

Tonsil Holding Forceps	253
------------------------	-----

MYLES

Nasal Cutting Forceps	114
-----------------------	-----

N**NAGER**

Uvula Retractor	242
-----------------	-----

NATHANSON

Retractor Arm	234
---------------	-----

NEGUS

Suction Dissector	144
Chest Support	239
Tonsil Artery Forceps	256
Knot Tier	260

NEIVERT

Nasal Retractor	138
-----------------	-----

NEIVERT-RETTINGER

Nasal Hook	138
------------	-----

NICOLA

Micro Forceps	217
Micro Scissors	217
Ring Curette	222
Raspatory	223

NICOLAI

Antrum Forceps	207
----------------	-----

NIJMEGEN

Suction Tube 38

NOLST TRENIÉ

Glabella Rasp 171
 Nasal Rasp 171
 Micro Skin Hook 171
 Nasal Retractor 171
 Micro Osteotome 172
 Rhinoplasty Scissors 173
 Dissecting Scissors 173
 Angled Scissors 173
 Periosteal Elevator 174
 Dressing/Tissue Forceps 174
 Cartilage Crusher 174
 Mallet 174

NOYES

Nasal Forceps 120

O**OBWEGESER**

Periosteal Elevator 29
 Periosteal Elevator, curved 31

OBWEGESER-FREER

Septum Elevator 143

OLIVECRONA

Nasal Scissors 110, 213

OSTROM

Antrum Punch 204, 205
 Ethmoidal Forceps 205
 Suction Punch 210

OVERHOLT

Dissecting and Ligature Forceps 256

P**PAPAVERO CASPAR**

Specula 218

PARKES

TC Rasp 163

PASQUINI

Sinus Suction 184

PEET

Nasal Rasp 165

PEET-COTTLE

Nasal Rasp 164

PENNINGTON

Elevator 148

PERKINS

Antrum Retractor 53

PERWITZSCHKY

Salival Scissors 240, 241

PICCOLO

Applicator 20

PLESTER

Suction Tube 39
 Raspatory 149
 Sickle Knife 187
 Raspatory 51
 Self Retaining Retractor 54
 Flap Knife 70
 Footplate Hook 72
 Flap Knife 73
 Sickle Knife 73
 Wire Guide and Applicator 81
 Aural scraper 81

POLITZER

Aural Speculum 12
 Ear Knife 25
 Tympanum Perforator 25

PRATT

Ethmoid Curette 188

PREYER

Dissector 71

PRINCE

Tonsil Scissors 251

R**RAY**

Ring Curette 221

RIBBON

Retractor 191

RITTER

Frontal Sinus Bougie 186

ROEDER

Ligature Instrument 259

RONIS

Adenoid Forceps 245

ROSEN

Suction Cannula 43
 Round Knife 69
 Knife and elevator 74
 Elevator 75, 77
 Round Cutting Knife 80

ROSEN-KOENIG

Mouth Gag 230

RUBIN

Septum Morcelizer 129, 130
 Hook 137
 Osteotome 154

RUSKIN LISTON

Bone Cutting Forceps 128

RUSKIN ROWLAND

Bone Cutting Forceps 128

RUSSEL-DAVIS

Tongue Blade 237

RYDER

TC Needle Holder 241

RZ

Self-retaining Retractor 54
 Nasal Suction Dissector 144
 Cartilage Crusher 168
 Giraffe Biopsy Forceps 209
 Osteotome 157
 Laryngo-Pharyngoscope Retractor 235
 Nasal Retractor 137

S**SCHMEDEN**

Nasal Cutting Forceps 113

SCHNIDT SAWTELL

Tonsil Seizing Forceps 255

SCHUKNECHT

Suction Tube 41
 Bending Device 88

SCHWABER

Specula with hinge 16

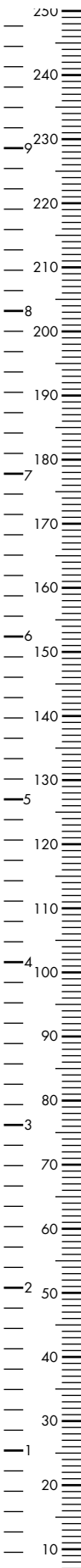
	<p>SCHÖNBORN Uvula Retractor 242</p> <p>SCOVILLE HAVERFIELD Spreader 55</p> <p>SEIFERT Salival duct probe 75, 240</p> <p>SEWALL Antrum Elevator 187</p> <p>SHAMBOUGH Adenotome 244</p> <p>SHEA Ear Speculum Holder 11 Curette 78 Vein Press 89</p> <p>SHEEHAN Osteotome 157</p> <p>SHEEN Cartilage Grid 169</p> <p>SIEBENMANN Nasal Plugger 103 Irrigation Antrum Cannula 186</p> <p>SILVER Osteotome 155</p> <p>SLUDER-BALLENGER Tonsillotome Handle 258</p> <p>SNELLEN (WEBER-LOCH) Aural Loop 22</p> <p>SOFFERMANN Needle Holder 65</p> <p>SPRATT Bone Curette 35</p> <p>ST. BARTS Rongeur 118</p> <p>ST. CLAIR THOMPSON Nasal Specula 92</p> <p>STACKE Aural Probe 20</p> <p>STAMMBERGER Circular Punch 211</p>	<p>STENSTROM Ear Scraper 37</p> <p>STIERLEN Tongue Depressor 230</p> <p>STRUEMPEL Ear Forceps 27 Forceps 106, 215 Nasal Forceps 124</p> <p>STRUEMPEL-VOSS Ethmoidal Forceps 117, 201</p> <p>STRUYCKEN Ethmoidal Forceps 111, 204 Nasal Cutting Forceps 114</p> <p>T</p> <p>TAKAHASHI Ethmoidal Forceps 118, 200 Nasal Forceps 122</p> <p>TALESHI Suction Tube 41</p> <p>THOBNURN Sickle Knife 73</p> <p>THOMASSIN Dissector 72, 84</p> <p>THORPE Caliper 170</p> <p>THUDICHUM (MARK HOVELL) Nasal Specula 92</p> <p>TIECK-HALLE Nasal Specula 93</p> <p>TILLEY Nasal Forceps 106</p> <p>TILLEY HENCKEL Ethmoid Punch 118</p> <p>TIVNEN-TYDING Tonsil Seizing Forceps 253</p> <p>TOBOLD Tongue Depressor 229</p>	<p>TOLSDORF Bone crusher 169</p> <p>TOYNBEE Ear Speculum 12</p> <p>TRAUTMANN Gouge 32 Chisel 32</p> <p>TROELTSCH Aural Dressing Forceps 26</p> <p>TROELTSCH (WILDE) Nasal Dressing Forceps 103</p> <p>TROUSSEAU Tracheal Dilator 264</p> <p>TUFFIER Retractor 191</p> <p>TYDING Tonsil Snare 257</p> <p>U</p> <p>UFFENORDE Bone Curette 189</p> <p>V</p> <p>VENT Tube Forceps 65</p> <p>VERHOEVEN Suction Tube 41, 43</p> <p>W</p> <p>WAGENER Hooklet 21</p> <p>WALTER Nasal Hook 139 Chisel 156 Osteotome 156</p> <p>WATSON-WILLIAMS Nasal Forceps 113 Ethmoidal Forceps 123, 125</p>
---	---	--	---

WEIL-BLAKESLEY

Ethmoidal Forceps	117
Rongeur	217

WEITLANER

2x3 teeth	52
-----------	----

WEITLANER BECKMANN

Self-Retaining Retractor	54
--------------------------	----

WEST

Nasal Dressing Forceps	105
------------------------	-----

WHIRLY-BIRD

Knife	85
-------	----

WHITE

Tonsil Holding Forceps	254
------------------------	-----

WIEDER

Tongue Depressor	229
------------------	-----

WILDE

Nasal Polypus Snare	108
---------------------	-----

WILDE-TROELTSCH

Aural Dressing Forceps	26
------------------------	----

WILDER

Dilator	240
---------	-----

WILLIAMS

Eustachian Catheter	19
---------------------	----

WILLIGER

Raspatory	32
-----------	----

WOODSON

Elevator	143
----------	-----

WULLSTEIN

Suction Cannula	40
Aural Suction Handle	42
Raspatory	49

WULLSTEIN-COLOR

Micro Hook	82
------------	----

WÜRZBURG

Rock leg holder	89
Tongue Blade	238

Y**YANKAUER**

Nasal Dressing Forceps	106
Suction Tube	259

YASARGIL

Rongeur	217
---------	-----

YASARGIL-NICOLA

Micro Grasping Forceps	217
------------------------	-----

Z**ZAUFAL**

Ear Leaver	22
------------	----

ZAUFAL-JANSEN

Aural hook	22
------------	----

ZOELLNER

Aural Speculum	15
Suction Tip	44
Needle	81

250	100-102-100	10	100-500-531	273, 274, 278	100-505-102	270
240	100-103-100	10	100-500-532	273, 274	100-505-103	270
	100-103-400	10	100-500-533	273, 274	100-510-000	270
230	100-418-150	169	100-500-534	273	100-510-001	270
	100-418-200	169	100-500-535	273	100-510-002	270
220	100-418-300	169	100-500-536	273	100-510-003	270
	100-500-001	271, 272, 281	100-500-537	273, 274	100-510-100	270
210	100-500-002	271, 272, 281	100-500-538	274, 278	100-510-101	270
8	100-500-003	271, 272, 281	100-500-539	274	100-510-102	270
200	100-500-004	271	100-500-540	274	100-510-103	270
	100-500-005	271	100-500-541	274, 278	100-512-000	268
190	100-500-006	271	100-500-543	274	100-700-001	284
	100-500-007	271, 272	100-500-551	275, 278	100-700-002	284
7	100-500-008	271, 272, 281	100-500-552	275, 278	100-700-003	284
	100-500-019	272, 281	100-500-553	276	100-700-004	284
170	100-500-020	272, 281	100-500-554	276	100-700-005	284
	100-500-021	272	100-500-555	276	100-700-006	284
160	100-500-050	272, 281	100-500-556	275, 278	100-700-007	284
6	100-500-075	272	100-500-557	276	100-700-008	284
150	100-500-080	272, 281	100-500-558	275, 278	100-700-020	285
	100-500-100	268	100-500-559	276	100-700-021	285
	100-500-101	268	100-500-560	276	100-700-022	285
130	100-500-102	268	100-500-561	276	100-700-023	285
5	100-500-110	268	100-500-562	274, 277, 278	100-700-024	285
120	100-500-111	268	100-500-563	275, 277, 278	100-700-025	285
	100-500-113	268	100-500-564	274, 277, 278	100-700-026	285
110	100-500-150	269	100-500-571	279	100-700-050	285
	100-500-200	269	100-500-572	279	100-700-051	285
4	100-500-201	272, 280, 281	100-500-573	279	100-700-052	285
100	100-500-202	272, 280, 281	100-500-574	278	100-700-053	285
	100-500-203	272, 280, 281	100-500-575	278	100-700-054	285
	100-500-204	280	100-500-576	278	100-700-101	284
3	100-500-205	280	100-500-581	282, 283	100-700-102	284
	100-500-206	280	100-500-582	282, 283	100-700-103	284
70	100-500-207	272, 280	100-500-583	282, 283	100-700-104	284
	100-500-208	272, 280, 281	100-500-584	283	100-700-200	290
60	100-500-210	269	100-500-585	283	100-700-210	290
	100-500-220	266	100-500-586	283	100-700-230	290
2	100-500-280	266	100-500-587	283	100-700-270	290
	100-500-285	266	100-500-588	283	100-700-501	287
40	100-500-320	266	100-505-000	270	100-700-502	287
	100-500-340	266	100-505-001	270	100-700-503	287
30	100-500-385	266	100-505-002	270	100-700-504	287
1	100-500-400	269	100-505-003	270	100-700-511	287
20	100-500-410	269	100-505-100	270	100-700-512	287
10	100-500-420	269	100-505-101	270	100-700-513	287
INCH						
MM						

100-700-514	287	100-720-003	296	100-720-603	297
100-700-520	287	100-720-004	296	100-720-604	297
100-700-521	287	100-720-011	296	100-720-605	297
100-700-522	287	100-720-012	296	100-720-606	297
100-700-523	287	100-720-013	296	100-720-607	297
100-700-524	287	100-720-014	296	100-720-608	297
100-700-550	287	100-720-021	296	100-720-609	297
100-700-551	287	100-720-022	296	100-720-610	298
100-700-552	287	100-720-024	296	100-720-611	298
100-700-553	287	100-720-031	296	100-720-612	298
100-710-001	288	100-720-032	296	100-720-613	298
100-710-002	288	100-720-034	296	100-725-001	286
100-710-003	288	100-720-302	297	100-725-002	286
100-710-004	288	100-720-303	297	100-725-003	286
100-710-005	288	100-720-304	297	100-725-004	286
100-710-006	288	100-720-305	297	100-725-005	286
100-710-020	288	100-720-306	297	100-725-006	286
100-710-021	288	100-720-307	297	100-725-007	286
100-710-022	288	100-720-308	297	100-725-008	286
100-710-023	288	100-720-309	297	100-750-301	299
100-710-024	288	100-720-312	298	100-750-302	299
100-710-025	288	100-720-313	298	100-750-303	299
100-710-050	288	100-720-402	297	100-750-304	299
100-710-051	288	100-720-403	297	100-750-305	299
100-710-052	288	100-720-404	297	100-750-306	299
100-710-053	288	100-720-405	297	100-750-307	299
100-712-001	289	100-720-406	297	100-750-308	299
100-712-002	289	100-720-407	297	100-750-309	299
100-712-003	289	100-720-408	297	100-750-310	299
100-712-004	289	100-720-409	297	100-750-401	299
100-712-005	289	100-720-410	298	100-750-402	299
100-712-006	289	100-720-411	298	100-750-403	299
100-712-007	289	100-720-412	298	100-750-404	299
100-712-008	289	100-720-413	298	100-750-405	299
100-712-009	289	100-720-502	297	100-750-406	299
100-712-013	289	100-720-503	297	100-750-407	299
100-715-001	286	100-720-504	297	100-750-408	299
100-715-002	286	100-720-505	297	100-750-409	299
100-715-003	286	100-720-507	297	100-750-410	299
100-715-004	286	100-720-508	297	100-750-501	299
100-715-005	286	100-720-509	297	100-750-502	299
100-715-006	286	100-720-510	298	100-750-503	299
100-715-007	286	100-720-511	298	100-750-504	299
100-715-008	286	100-720-512	298	100-750-505	299
100-720-001	296	100-720-513	298	100-750-506	299
100-720-002	296	100-720-602	297	100-750-507	299

250	100-750-508	299	100-850-505	294	120-286-220	127
240	100-750-509	299	100-850-512	294	120-287-180	109
	100-750-510	299	100-850-521	294	120-565-120	258
230	100-750-601	299	100-850-522	294	120-585-180	110
	100-750-602	299	100-850-531	294	120-588-220	127
220	100-750-603	299	100-850-532	294	121-111-180	252
	100-750-604	299	100-850-547	294	121-111-200	252
210	100-750-605	299	100-853-295	292	121-111-230	252
8	100-750-606	299	100-854-295	292	130-010-200	248
200	100-750-607	299	100-855-300	292	130-014-200	248
	100-750-608	299	100-856-300	292	130-110-200	248
190	100-750-609	299	100-857-300	292	130-120-200	248
	100-750-610	299	100-860-020	293	140-254-180	255
7	100-755-304	300	100-860-025	293	140-255-180	255
	100-755-305	300	100-860-030	293	140-368-185	256
170	100-755-310	300	100-860-300	292	140-369-185	256
	100-755-404	300	100-860-525	294	140-443-001	256
160	100-755-405	300	100-860-630	294	140-548-180	255
6	100-755-410	300	100-860-730	294	140-549-200	256
150	100-755-504	300	100-861-001	293	140-602-200	253
	100-755-505	300	100-861-002	293	140-620-180	254
140	100-755-510	300	100-862-030	293	140-620-235	254
	100-755-604	300	100-864-030	293	140-625-190	256
130	100-755-605	300	100-864-280	292	140-625-200	254
5	100-755-610	300	100-870-000	295	140-626-190	254
120	100-800-090	267	100-870-001	295	140-627-190	256
	100-805-070	267	100-870-002	295	140-628-190	255
110	100-806-070	267	100-870-003	295	140-629-190	255
4	100-850-000	291	100-870-100	295	140-630-190	255
100	100-850-001	291	110-110-003	49	140-631-190	255
90	100-850-002	291	110-116-033	241	150-030-250	247
	100-850-003	291	110-130-077	49, 241	150-031-250	247
80	100-850-004	291	120-111-180	252	150-130-200	246
3	100-850-005	291	120-111-200	252	150-131-200	246
70	100-850-006	291	120-111-230	252	160-131-105	20
	100-850-007	291	120-207-180	251	160-255-180	21
60	100-850-008	291	120-208-230	110, 213	160-411-180	103
50	100-850-009	291	120-209-180	252	160-412-180	103
2	100-850-010	291	120-213-170	252	160-420-110	20
	100-850-011	291	120-213-175	251	160-420-165	102
40	100-850-012	291	120-217-190	251	160-422-140	20
	100-850-013	291	120-265-120	258	160-426-160	102
30	100-850-014	291	120-283-180	109	160-426-165	102
1	100-850-015	291	120-284-180	109	160-481-200	260
20	100-850-503	294	120-285-175	110	160-495-280	260
10	100-850-504	294	120-285-180	109	165-052-018	182

165-064-160	104	165-625-008	39	170-750-200	52
165-071-025	186	165-625-010	39	170-752-110	52
165-072-025	186	165-625-012	39	170-752-130	52
165-523-005	104	165-625-015	39	170-753-110	52
165-523-006	104	165-725-005	39	170-753-130	52
165-523-007	104	165-725-007	39	170-759-130	52
165-523-008	104	165-725-008	39	170-760-110	54
165-523-009	104	165-725-009	39	170-761-110	54
165-523-010	104	170-005-001	263	170-762-110	54
165-523-011	104	170-005-002	263	170-762-130	54
165-523-012	104	170-005-003	263	170-763-110	54
165-523-015	104	170-008-381	135	170-763-130	54
165-523-105	39	170-010-125	133	170-765-135	53
165-523-107	39	170-011-150	133	170-766-135	53
165-523-109	39	170-014-002	134	170-780-165	53
165-523-306	185	170-014-005	134	170-780-170	53
165-523-308	185	170-014-007	134	170-781-165	53
165-523-310	185	170-014-010	134	170-781-170	53
165-523-312	185	170-014-012	134	170-782-170	53
165-523-315	185	170-036-180	138	170-783-165	54
165-523-401	185	170-036-183	138	170-784-165	54
165-523-402	185	170-036-187	138	170-786-030	16
165-523-511	185	170-074-161	263	170-786-050	16
165-523-512	185	170-074-162	263	170-801-501	234, 235
165-525-005	39, 184	170-074-163	263	170-801-502	234
165-525-006	39, 184	170-074-164	263	170-801-503	234
165-525-007	184	170-075-161	263	170-906-000	55
165-525-008	39, 184	170-075-162	263	170-906-001	55
165-525-009	184	170-075-163	263	170-906-102	55
165-525-010	39, 184	170-075-164	263	170-906-104	55
165-525-011	184	170-720-100	52	170-906-106	55
165-525-012	39, 184	170-723-100	52	170-906-108	55
165-525-015	39, 184	170-732-200	53	170-906-122	55
165-536-006	41	170-733-200	53	170-906-124	55
165-536-007	41	170-746-140	54	170-906-126	55
165-536-009	41	170-746-160	54	170-906-128	55
165-536-010	41	170-746-200	54	170-906-144	55
165-538-003	41	170-746-240	54	170-906-145	55
165-538-005	41	170-747-140	54	170-973-006	191
165-538-007	41	170-747-160	54	170-973-012	191
165-539-003	41	170-747-200	54	170-973-017	191
165-539-005	41	170-747-240	54	170-973-020	191
165-539-007	41	170-748-105	52	170-973-025	191
165-543-270	259	170-749-105	52	170-975-250	191
165-625-005	39	170-750-105	52	180-548-180	241
165-625-006	39	170-750-165	52	180-560-180	241

250	180-718-210	259	210-438-160	32	230-209-180	133
240	180-719-210	259	210-439-006	149	230-220-001	135
	210-113-143	32	210-439-008	149	230-260-200	138
230	210-113-145	32	210-472-004	152	230-280-160	136
	210-113-147	32	210-472-006	152	230-281-140	136
220	210-113-149	32	210-472-007	152	230-282-140	136
	210-114-143	32	210-472-009	152	230-283-140	136
210	210-114-145	32	210-472-012	152	230-285-160	134
8	210-114-147	32	210-472-105	153	230-286-160	134
200	210-114-149	32	210-474-010	153	230-329-006	261
	210-220-200	33, 158	210-474-012	153	230-329-008	261
190	210-230-190	33, 158	210-474-014	153	230-329-010	261
	210-231-190	33, 158	210-474-016	153	230-329-012	261
7	210-240-180	33, 158	210-475-004	152	230-329-014	261
	210-260-150	34, 158	210-486-006	152	230-329-016	261
170	210-264-220	34, 158	210-486-008	153	230-329-018	261
	210-264-221	34, 158	210-486-016	153	230-329-020	261
160	210-303-190	30	210-487-004	152	230-329-022	261
6	210-308-000	35	210-487-007	152	230-329-024	261
150	210-308-001	35	210-487-008	152	230-329-026	261
	210-308-002	35	210-487-010	152	230-329-028	261
140	210-308-003	35	210-487-012	152	230-329-030	261
	210-308-004	35	210-488-003	151	230-330-006	261
130	210-308-005	35	210-488-004	151	230-330-008	261
5	210-308-006	35	210-488-006	151	230-330-010	261
120	210-308-007	35	210-488-007	151	230-330-012	261
	210-308-008	35	210-488-009	151	230-330-014	261
110	210-308-009	35	210-488-012	151	230-330-016	261
4	210-311-180	32	210-626-190	167	230-330-018	261
100	210-313-185	30	210-722-210	167	230-330-020	261
90	210-331-170	168	210-770-160	36	230-330-022	261
	210-333-170	168	210-770-190	36	230-330-024	261
3	210-345-007	189	210-771-160	36	230-330-026	261
	210-347-007	189	210-771-190	36	230-330-028	261
70	210-348-001	35	210-830-180	36	230-330-030	261
	210-348-002	35	210-831-180	36	230-331-110	261
60	210-348-010	35	210-843-170	128	230-780-160	136
2	210-348-100	35	210-844-170	128	250-064-222	217
50	210-348-200	35	210-855-180	128	250-064-223	217
	210-348-300	35	210-880-175	128	250-064-224	217
40	210-348-400	35	230-202-000	159	250-064-226	217
	210-348-500	35	230-202-001	159	250-064-376	134
30	210-348-600	35	230-202-002	159	250-066-500	221
1	210-394-150	29	230-203-150	133	250-066-501	221
20	210-434-130	32	230-205-180	133	250-066-502	221
10	210-436-160	32	230-207-180	133	250-066-503	221

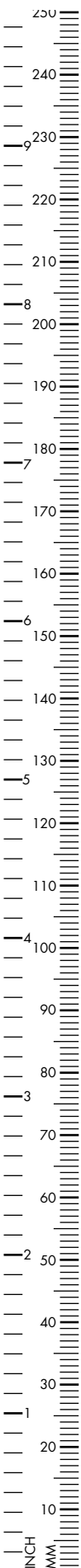

250-066-504	221	250-150-590	218	250-411-181	194
250-066-505	221	250-150-591	218	250-411-182	194
250-066-506	221	250-150-592	218	250-411-183	194
250-066-507	221	250-150-689	218	250-411-184	194
250-066-508	221	250-150-690	218	250-411-185	194
250-066-509	221	250-150-691	218	250-420-181	194
250-066-599	217	250-210-180	195	250-420-182	194
250-066-600	217	250-210-181	195	250-420-183	194
250-066-608	225	250-210-182	195	250-420-184	194
250-066-609	225	250-210-183	195	250-420-185	194
250-066-611	221	250-210-185	195	250-420-189	194
250-066-614	221	250-210-200	195	250-430-181	194
250-066-616	222	250-210-201	195	250-430-182	194
250-066-617	222	250-210-202	195	250-430-183	194
250-066-618	222	250-210-203	195	250-430-184	194
250-066-619	223	250-210-204	195	250-430-185	194
250-066-620	225	250-210-205	195	251-010-000	11, 100
250-066-621	225	250-245-000	195	251-010-100	11, 100
250-066-625	225	250-245-180	195	251-010-200	11
250-066-626	225	250-245-181	195	251-010-300	11
250-066-627	223	250-245-182	195	251-010-400	100
250-066-628	223	250-245-183	195	251-010-500	100
250-066-629	224	250-245-184	195	251-010-600	100
250-066-630	224	250-245-185	195	251-104-001	198
250-066-631	221	250-245-200	195	251-104-002	198
250-066-632	221	250-245-201	195	251-104-120	198
250-066-635	223	250-245-202	195	251-105-120	198
250-066-637	222	250-245-203	195	251-127-001	198
250-066-640	224	250-245-204	195	251-127-002	198
250-066-642	222	250-245-205	195	251-127-120	198
250-066-643	224	250-280-182	195	252-000-111	117
250-066-644	224	250-280-183	195	252-000-120	117
250-066-655	225	250-280-184	195	252-000-121	117
250-066-656	225	250-280-185	195	252-000-122	117
250-066-817	216	250-280-202	195	252-001-120	117
250-066-824	216	250-280-203	195	252-001-121	117
250-066-827	216	250-280-204	195	252-001-122	117
250-067-817	216	250-280-205	195	252-001-200	142, 187
250-150-100	218	250-300-170	216	252-001-220	143
250-150-101	218	250-301-170	216	252-002-120	117
250-150-102	218	250-400-181	194, 195	252-002-121	117
250-150-210	218	250-400-182	194	252-002-122	117
250-150-280	218	250-400-183	194	252-002-130	200
250-150-290	218	250-400-184	194	252-002-180	145
250-150-300	218	250-400-185	194	252-003-120	117
250-150-589	218	250-400-189	194	252-003-121	117

250	252-003-122	117	252-025-210	187	252-040-152	117
240	252-003-130	111, 204	252-026-130	111, 213	252-040-180	217
	252-003-170	182	252-026-210	187	252-040-181	217
230	252-004-120	117	252-027-190	190	252-042-235	191
	252-004-121	117	252-028-001	125	252-043-025	186
220	252-004-122	117	252-028-002	125	252-043-030	186
	252-004-130	202	252-028-003	125	252-043-040	186
210	252-004-131	202	252-028-004	125	252-043-050	186
8	252-004-132	202	252-029-000	125	252-050-150	117
200	252-004-170	182	252-029-500	125	252-050-180	186
	252-005-170	182	252-030-180	217	252-051-003	186
190	252-008-190	188	252-030-181	217	252-051-004	186
	252-009-012	183	252-031-120	124	252-052-180	186
7	252-009-015	183	252-031-190	126	252-053-003	186
	252-009-020	183	252-032-120	124	252-053-004	186
170	252-010-100	205	252-032-190	126	252-071-190	188
	252-013-130	203	252-033-120	124	252-071-220	189
160	252-013-145	203	252-033-190	126	252-071-222	189
6	252-014-130	202	252-034-120	124	252-072-001	190
	252-014-131	202	252-034-130	200	252-072-002	190
140	252-014-132	202	252-034-131	200	252-072-003	190
	252-014-135	203	252-034-132	200	252-072-004	190
130	252-014-145	203	252-034-133	200	252-072-005	190
5	252-015-100	204	252-034-134	200	252-072-006	190
120	252-015-110	182	252-034-135	200	252-072-063	190
	252-015-130	206	252-035-130	200	252-081-210	188
110	252-015-500	210	252-035-131	200	252-082-190	188
	252-015-510	210	252-035-132	200	252-082-210	188
4	252-015-520	210	252-035-133	200	252-083-210	188
100	252-017-130	206	252-035-134	200	252-093-190	188
90	252-018-110	182	252-035-135	200	252-104-000	197
	252-019-130	206	252-035-150	117	252-104-030	197
80	252-020-110	182	252-035-151	117	252-104-045	197
3	252-020-130	206	252-035-152	117	252-104-070	197
70	252-022-045	118	252-035-180	217	252-110-100	205
	252-022-055	118	252-035-181	217	252-113-190	190
60	252-022-065	118	252-036-131	201	252-114-190	190
2	252-022-100	210	252-036-132	201	252-115-100	204
50	252-023-130	111, 213	252-037-130	200	252-115-110	182
	252-024-130	111, 213	252-037-131	200	252-118-110	182
40	252-025-130	111, 213	252-037-132	200	252-120-110	182
30	252-025-150	183	252-037-133	200	252-122-100	210
1	252-025-151	183	252-037-134	200	252-125-110	182
20	252-025-152	183	252-037-135	200	252-125-150	183
	252-025-180	186	252-040-150	117	252-125-151	183
10	252-025-190	187	252-040-151	117	252-125-152	183

252-127-000	197	252-200-004	115	252-225-151	183
252-127-030	197	252-200-005	115	252-225-152	183
252-127-070	197	252-200-006	115	252-234-130	201
252-127-200	197	252-200-008	115	252-234-131	201
252-127-230	197	252-200-009	115	252-235-130	201
252-130-000	197	252-200-010	115	252-235-131	201
252-130-030	197	252-200-011	115	252-235-132	201
252-130-045	197	252-200-012	115	252-310-100	205
252-130-070	197	252-200-013	115	252-315-100	204
252-140-003	40	252-200-014	115	252-315-200	205
252-140-004	40	252-200-110	116	252-315-300	205
252-140-005	40	252-200-111	116	252-325-150	183
252-140-006	40	252-200-112	116	252-325-151	183
252-140-007	40	252-200-113	116	252-325-152	183
252-140-008	40	252-200-114	116	252-342-120	209
252-140-009	40	252-200-115	116	252-343-120	209
252-144-121	117	252-201-110	116	252-352-120	209
252-145-001	193	252-201-111	116	252-353-120	209
252-145-002	193	252-201-112	116	252-401-025	203
252-145-003	193	252-201-113	116	252-403-025	203
252-145-004	193	252-201-114	116	252-410-110	207
252-145-005	193	252-202-111	116	252-410-111	207
252-146-001	193	252-203-111	116	252-410-112	207
252-146-170	192	252-204-110	116	252-410-113	207
252-147-120	192	252-204-111	116	252-410-114	207
252-147-170	193	252-204-112	116	252-410-115	207
252-148-170	193	252-204-113	116	252-410-130	118
252-150-110	192	252-204-114	116	252-410-131	118
252-151-110	192	252-204-130	202	252-410-132	118
252-151-170	193	252-205-110	116	252-410-151	118
252-160-150	124	252-205-111	116	252-411-112	208
252-171-100	206	252-205-112	116	252-413-131	118
252-171-190	188	252-205-113	116	252-415-120	208
252-171-300	206	252-205-114	116	252-415-121	208
252-171-700	206	252-205-190	187	252-415-122	208
252-172-190	189	252-206-000	203	252-425-115	119
252-173-100	206	252-206-001	203	252-425-150	183
252-173-190	189	252-206-002	203	252-425-151	183
252-173-300	206	252-207-000	203	252-425-152	183
252-173-700	206	252-207-001	203	252-426-100	120
252-174-180	199	252-207-002	203	252-470-120	209
252-182-190	188	252-210-100	205	252-471-130	210
252-193-190	188	252-214-130	202	252-472-130	210
252-200-001	115	252-215-100	204	252-473-130	210
252-200-002	115	252-215-190	187	252-477-141	207
252-200-003	115	252-225-150	183	252-477-142	207

250	252-477-143	207	252-724-120	122	252-800-820	220
240	252-499-140	196	252-725-120	121	252-810-160	214
	252-499-175	196	252-725-122	121	252-810-190	214
230	252-500-140	196	252-725-150	184	252-811-160	214
	252-500-175	196	252-725-151	184	252-811-190	214
220	252-501-140	196	252-725-152	184	252-813-160	214
	252-502-100	210	252-726-120	121	252-813-190	214
210	252-502-145	210	252-727-120	121	252-815-160	214
8	252-503-090	199	252-730-120	121	252-815-190	214
200	252-503-140	199	252-730-121	121	252-816-160	214
	252-503-150	199	252-730-122	121	252-816-190	214
190	252-525-155	184	252-731-120	121	252-817-160	214
	252-526-115	120	252-732-120	121	252-817-190	214
180	252-527-115	120	252-735-120	121	252-818-160	214
7	252-528-115	120	252-735-121	121	252-818-190	214
170	252-529-115	120	252-735-122	121	252-819-160	214
	252-529-120	125	252-740-120	121	252-819-190	214
160	252-530-115	120	252-740-121	121	252-820-160	215
6	252-530-120	123	252-740-122	121	252-820-190	215
150	252-531-120	125	252-741-120	122	252-821-160	215
	252-533-170	211	252-741-121	122	252-821-190	215
140	252-534-100	119	252-742-120	122	252-823-160	215
	252-534-170	211	252-742-121	122	252-823-190	215
130	252-534-270	211	252-743-120	122	252-825-150	184
5	252-535-170	192	252-743-121	122	252-825-151	184
120	252-536-115	118	252-744-120	122	252-825-152	184
	252-536-170	211	252-744-121	122	252-830-160	215
110	252-536-235	212	252-745-120	121	252-830-190	215
4	252-536-245	212	252-770-120	209	252-831-160	215
100	252-536-435	212	252-800-102	219	252-831-190	215
90	252-536-445	212	252-800-104	219	252-833-160	215
	252-537-115	118	252-800-106	219	252-833-190	215
80	252-537-170	211	252-800-112	219	252-835-160	215
3	252-537-270	211	252-800-114	219	252-835-190	215
70	252-537-335	211	252-800-116	219	260-200-110	137
	252-538-115	118	252-800-200	219	260-500-001	166
60	252-551-204	119	252-800-201	219	260-501-120	137
2	252-570-120	209	252-800-203	219	260-502-120	137
50	252-600-070	208	252-800-204	219	260-761-000	169
40	252-601-070	208	252-800-210	219	290-137-270	167
	252-602-070	208	252-800-405	220	300-001-183	9
30	252-670-120	209	252-800-430	220	400-420-100	170
1	252-720-120	121	252-800-475	220	400-421-000	170
20	252-721-120	121	252-800-510	220	400-497-001	20, 240
	252-722-120	122	252-800-511	220	400-497-003	20, 240
10	252-723-120	122	252-800-810	220	400-497-008	20, 240
INCH						
MM						

400-497-012	20, 240	410-022-001	13	410-032-180	25
400-497-023	20, 240	410-022-002	13	410-032-181	25
400-497-034	20, 240	410-022-003	13	410-032-182	25
400-497-045	20, 240	410-022-004	13	410-033-100	37
400-497-056	20, 240	410-022-005	13	410-033-130	37
400-497-067	20, 240	410-022-006	13	410-033-131	37
400-497-078	20, 240	410-022-007	13	410-033-160	25
400-583-005	170	410-022-008	13	410-033-180	25
400-583-007	170	410-022-009	13	410-034-160	25
400-583-008	170	410-022-501	14	410-035-160	25
400-583-009	170	410-022-502	14	410-044-001	78
400-713-001	240	410-022-503	14	410-044-002	78
400-713-002	240	410-022-504	14	410-044-003	78
400-713-003	240	410-022-505	14	410-044-004	78
410-000-155	75	410-022-506	14	410-044-006	78
410-004-000	8	410-022-507	14	410-044-007	78
410-004-030	8	410-022-508	14	410-044-008	78
410-009-003	12	410-022-509	14	410-044-010	78
410-009-004	12	410-023-001	14	410-044-100	79
410-009-005	12	410-023-002	14	410-044-101	79
410-009-006	12	410-023-003	14	410-044-102	79
410-012-110	16	410-023-004	14	410-044-103	79
410-014-004	12	410-023-005	14	410-044-150	79
410-014-005	12	410-023-006	14	410-045-180	75, 240
410-014-006	12	410-023-007	14	410-046-160	78
410-014-007	12	410-023-008	14	410-047-160	78
410-017-001	84	410-023-009	14	410-060-010	38
410-017-002	84	410-023-501	15	410-060-015	38
410-018-004	13	410-023-502	15	410-060-020	38
410-018-005	13	410-023-503	15	410-060-025	38
410-018-006	13	410-023-504	15	410-060-030	38
410-018-007	13	410-023-505	15	410-060-040	38
410-018-008	13	410-023-506	15	410-090-010	38
410-018-009	13	410-023-507	15	410-090-015	38
410-018-010	13	410-023-508	15	410-090-020	38
410-018-085	13	410-023-509	15	410-090-030	38
410-019-003	12	410-027-000	8	410-090-040	38
410-019-004	12	410-027-030	8	410-090-050	38
410-019-005	12	410-027-070	8	410-090-110	38
410-019-030	12	410-027-100	8	410-090-115	38
410-019-040	12	410-027-130	8	410-090-120	38
410-019-050	12	410-031-180	25	410-090-125	38
410-019-060	12	410-032-050	15	410-090-130	38
410-019-075	12	410-032-060	15	410-090-140	38
410-019-100	8	410-032-070	15	410-090-150	38
410-019-130	8	410-032-160	25	410-092-001	73

250	410-093-160	74	410-110-155	79	410-118-030	80
240	410-100-000	23	410-110-160	79	410-118-035	80
	410-100-001	23	410-111-155	79	410-118-040	80
230	410-100-002	23	410-112-155	79	410-119-010	80
	410-100-003	23	410-113-155	83	410-119-015	80
220	410-100-004	23	410-114-155	79	410-119-020	80
	410-100-160	73	410-115-003	82	410-119-023	80
210	410-100-300	23	410-115-006	82	410-119-025	80
8	410-101-000	23	410-115-010	82	410-120-020	81
200	410-101-001	23	410-115-153	83	410-124-160	73
	410-101-002	23	410-115-161	82	410-128-010	80
190	410-101-003	23	410-115-162	82	410-128-015	80
	410-101-004	23	410-115-164	82	410-128-020	80
180	410-101-160	73, 187	410-115-166	82	410-128-025	80
7	410-101-300	23	410-115-168	82	410-128-030	80
170	410-102-000	23	410-116-103	83	410-130-000	48
	410-102-001	23	410-116-105	83	410-130-030	48
160	410-102-002	23	410-116-110	83	410-130-045	48
6	410-102-003	23	410-116-155	79	410-130-070	48
150	410-102-004	23	410-116-205	83	410-130-100	48
	410-102-300	23	410-116-210	83	410-130-130	48
140	410-103-000	23, 73	410-116-305	83	410-130-145	48
130	410-103-001	23, 73	410-116-310	83	410-130-170	48
5	410-103-002	23	410-117-002	82	410-130-182	75
120	410-103-003	23	410-117-003	82	410-132-001	15
	410-103-004	23	410-117-004	82	410-132-002	15
110	410-103-160	73	410-117-006	82	410-132-003	15
4	410-103-300	23	410-117-008	82	410-132-004	15
100	410-105-000	24	410-117-010	82	410-132-005	15
	410-105-001	24	410-117-012	82	410-132-006	15
90	410-105-002	24	410-117-015	82	410-132-160	40
	410-105-003	24	410-117-020	82	410-133-005	43
3	410-105-160	74	410-117-025	82	410-133-006	43
70	410-105-350	24	410-117-161	82	410-133-007	43
	410-105-351	24	410-117-162	82	410-133-008	43
60	410-105-352	24	410-117-164	82	410-133-009	43
	410-105-353	24	410-117-166	82	410-133-010	43
2	410-107-160	74	410-117-168	82	410-133-013	43
50	410-108-001	24	410-118-010	80	410-133-015	43
40	410-108-002	24	410-118-012	80	410-133-018	43
	410-109-160	74	410-118-015	80	410-133-020	43
30	410-109-170	73	410-118-018	80	410-133-025	43
1	410-110-150	85	410-118-020	80	410-133-030	43
20	410-110-151	85	410-118-023	80	410-133-035	43
	410-110-152	85	410-118-026	80	410-133-040	43
10	410-110-153	85	410-118-028	80	410-133-143	41
INCH						
MM						

410-133-145	41	410-138-045	72	410-150-100	16
410-133-160	40	410-138-250	86	410-150-155	77
410-133-173	41	410-138-275	86	410-153-016	89
410-133-175	41	410-138-300	86	410-153-030	89
410-133-243	41	410-138-325	86	410-154-130	89
410-133-245	41	410-138-350	86	410-154-160	89
410-133-273	41	410-138-375	86	410-154-180	89
410-133-275	41	410-138-400	86	410-155-000	87
410-134-006	43	410-138-425	86	410-155-180	89
410-134-007	43	410-138-450	86	410-155-800	86
410-134-009	43	410-138-475	86	410-156-180	89
410-134-012	43	410-138-500	86	410-157-001	84
410-134-016	43	410-141-163	77	410-157-002	84
410-134-116	41	410-141-165	77	410-157-003	84
410-134-120	41	410-141-180	87	410-157-004	84
410-134-216	41	410-142-135	85	410-157-005	84
410-134-220	41	410-142-140	85	410-157-006	84
410-134-312	40	410-142-145	85	410-157-090	84
410-134-316	40	410-142-150	85	410-162-180	84
410-134-320	40	410-142-160	86	410-165-001	81
410-135-015	75	410-142-161	86	410-165-002	81
410-135-048	77	410-142-166	85	410-165-003	81
410-135-050	76	410-142-180	87	410-165-004	81
410-135-051	77	410-143-000	86	410-165-005	81
410-135-060	84	410-144-000	87	410-165-006	81
410-135-061	84	410-144-007	88	410-165-007	81
410-135-062	84	410-144-010	88	410-165-008	81
410-135-063	84	410-144-015	88	410-165-009	81
410-135-160	40	410-144-017	88	410-165-030	104
410-137-004	85	410-144-030	88	410-165-035	104
410-137-006	85	410-144-100	88	410-165-045	104
410-137-008	85	410-144-107	88	410-174-102	17
410-137-013	85	410-144-110	88	410-174-512	17
410-137-014	85	410-144-115	88	410-185-010	17
410-137-015	85	410-144-130	88	410-185-110	17
410-137-016	85	410-144-200	88	410-185-210	17
410-137-017	85	410-145-000	88	410-185-310	17
410-137-018	85	410-145-170	50	410-185-410	17
410-138-005	43	410-146-180	51	410-185-510	17
410-138-007	43	410-147-160	51	410-190-440	17
410-138-010	43	410-148-210	51	410-195-010	17
410-138-012	43	410-150-007	16	410-195-045	104
410-138-015	43	410-150-008	16	410-195-110	17
410-138-020	43	410-150-015	42	410-205-000	19
410-138-025	43	410-150-017	42	410-205-001	19
410-138-030	43	410-150-020	42	410-205-002	19

250	410-205-100	19	410-245-001	37	410-335-600	58
240	410-205-200	19	410-245-002	37	410-335-700	58
	410-205-300	19	410-250-001	63	410-335-800	58
230	410-208-100	65	410-250-002	63	410-336-180	149
	410-210-002	82	410-267-004	44	410-338-125	28
220	410-210-003	82	410-267-005	44	410-338-131	28
	410-210-004	82	410-267-006	44	410-338-132	27
210	410-210-006	82	410-267-007	44	410-338-133	27
8	410-210-008	82	410-267-008	44	410-338-134	27
200	410-210-010	82	410-267-009	44	410-338-135	28
	410-210-012	82	410-267-012	44	410-338-136	28
190	410-210-015	82	410-267-100	44	410-338-139	27
	410-210-020	82	410-267-101	44	410-338-140	28
7	410-210-025	82	410-269-012	44	410-338-142	28
	410-210-085	27, 58	410-269-015	44	410-338-234	106
170	410-210-125	27, 58	410-269-020	44	410-340-080	65
	410-210-203	83	410-269-022	44	410-340-100	67
160	410-210-206	83	410-269-025	44	410-340-120	67
6	410-210-210	83	410-269-030	44	410-340-130	67
150	410-210-303	83	410-269-050	44	410-340-140	67
	410-210-306	83	410-270-250	108	410-341-000	68
140	410-210-310	83	410-276-020	19	410-341-100	67
5	410-216-003	83	410-276-072	19	410-341-500	60
130	410-216-005	83	410-276-074	19	410-341-800	61
120	410-216-006	81	410-276-076	19	410-341-900	61
	410-216-007	81	410-276-078	19	410-342-100	66
110	410-216-010	83	410-276-080	19	410-342-110	66
4	410-216-160	81	410-300-100	64	410-342-500	60
100	410-216-165	76	410-301-100	64	410-342-800	61
	410-216-166	76	410-321-000	68	410-342-900	61
90	410-217-003	83	410-327-165	49	410-343-100	67
	410-217-006	83	410-328-165	49	410-343-110	66
3	410-217-010	83	410-329-190	49	410-343-120	66
70	410-217-103	83	410-330-000	68	410-343-130	66
	410-217-106	83	410-330-002	60	410-343-140	66
60	410-217-110	83	410-330-003	60	410-343-210	66
	410-223-010	87	410-330-004	60	410-343-220	66
2	410-225-003	39	410-330-160	50	410-343-230	66
	410-228-000	107	410-330-700	59	410-343-240	66
40	410-228-010	107	410-330-800	59	410-343-310	66
	410-228-050	107	410-330-900	59	410-343-320	66
30	410-228-100	107	410-331-160	50	410-343-330	66
1	410-230-120	26	410-334-160	50	410-343-340	66
20	410-230-140	26	410-335-300	58	410-343-410	66
	410-232-140	106	410-335-400	58	410-343-420	66
10	410-245-000	37	410-335-500	58	410-343-430	66
INCH						
MM						

410-343-440	66	410-356-080	59	410-800-010	18
410-343-500	60	410-357-080	59	410-800-020	18
410-343-510	66	410-359-000	68	410-800-030	18
410-343-520	66	410-359-100	64	410-800-040	18
410-343-530	66	410-359-200	64	410-800-050	18
410-343-540	66	410-359-300	64	410-800-100	18
410-343-800	61	410-359-500	64	410-800-102	69
410-344-080	58	410-360-500	64	410-800-104	69
410-344-500	60	410-361-080	64	410-800-105	69
410-344-800	61	410-365-080	63	410-800-106	69
410-345-000	68	410-366-080	63	410-800-108	69
410-345-080	58	410-368-080	65	410-800-110	69
410-346-000	68	410-375-100	26	410-800-112	69
410-346-080	60	410-375-120	26	410-800-115	69
410-347-500	60	410-377-120	26	410-800-120	69
410-350-000	68	410-389-190	103	410-800-125	69
410-350-100	62	410-391-140	26	410-800-130	69
410-350-132	65	410-395-160	103	410-800-140	69
410-350-200	61	410-410-160	29	410-800-202	69
410-350-500	62	410-411-100	29	410-800-204	69
410-350-700	62	410-580-001	22	410-800-206	69
410-351-010	66	410-580-002	22	410-800-208	69
410-351-020	66	410-580-003	22	410-800-210	69
410-351-030	66	410-580-130	23	410-800-212	69
410-351-040	66	410-580-161	22	410-800-215	69
410-351-050	66	410-580-162	22	410-800-220	69
410-351-060	66	410-580-163	22	410-800-225	69
410-351-500	62	410-583-145	22	410-800-310	69
410-351-700	61, 62	410-583-150	22	410-800-312	69
410-351-800	63	410-584-001	21	410-800-315	69
410-351-900	63	410-584-002	21	410-800-318	69
410-352-000	68	410-585-001	21	410-800-320	69
410-352-010	67	410-585-002	21	410-800-323	69
410-352-020	67	410-585-003	21	410-800-325	69
410-352-030	67	410-585-004	21	410-800-330	69
410-352-040	67	410-585-005	21	410-800-406	69
410-352-050	67	410-585-006	21	410-800-410	69
410-352-060	67	410-585-007	21	410-800-415	69
410-352-080	61	410-586-141	21	410-800-420	69
410-352-100	62	410-586-142	21	410-800-423	69
410-352-500	62	410-586-143	21	410-800-425	69
410-352-700	62	410-797-050	18	410-800-510	69
410-353-000	68	410-797-075	18	410-800-515	69
410-353-100	62	410-797-125	18	410-800-520	69
410-353-500	62	410-797-200	19	410-800-523	69
410-353-700	62	410-800-000	18	410-800-525	69

250	410-800-530	69	410-880-012	46	420-052-004	92
240	410-800-600	70	410-880-013	46	420-100-001	95
	410-800-610	70	410-880-014	47	420-100-002	95
230	410-800-620	70	410-880-015	47	420-100-003	95
	410-800-630	70	410-880-016	47	420-100-100	240, 241
220	410-800-640	70	410-880-017	47	420-119-001	94
	410-800-710	70	410-880-018	47	420-119-002	94
210	410-800-720	70	410-880-019	47	420-119-003	94
8	410-800-722	70	410-880-020	47	420-121-150	94
200	410-800-730	70	410-880-021	47	420-122-150	94
	410-800-732	70	410-880-356	48	420-123-150	94
190	410-800-801	71	410-880-387	48	420-124-033	94
	410-800-802	71	410-880-501	46	420-132-035	97
7	410-800-811	71	410-880-502	46	420-132-055	97
	410-800-812	71	410-880-503	46	420-132-075	97
170	410-800-821	71	410-880-504	46	420-132-090	97
	410-800-822	71	410-880-505	46	420-135-035	98
160	410-800-831	71	410-880-506	46	420-135-055	98
6	410-800-832	71	410-880-507	46	420-135-065	98
150	410-800-843	71	410-880-508	46	420-135-075	98
	410-800-844	71	410-880-509	46	420-135-090	98
	410-800-845	71	410-880-510	46	420-138-055	97
130	410-800-846	71	410-880-512	46	420-140-035	101
5	410-800-852	72	410-880-513	46	420-140-050	101
120	410-800-854	72	410-880-514	47	420-140-075	101
	410-800-856	72	410-880-517	47	420-140-090	101
110	410-800-877	72	410-880-518	47	420-140-100	101
4	410-800-901	72	410-880-519	47	420-140-135	93
100	410-800-902	72	410-900-000	11	420-142-135	93
	410-800-950	57	410-905-000	89	420-143-040	96
90	410-800-960	57	420-001-000	107	420-143-055	96
	410-800-970	57	420-050-001	92	420-143-075	96
3	410-800-980	57	420-050-002	92	420-143-090	96
	410-800-990	57	420-050-003	92	420-146-040	95
70	410-880-000	47	420-050-004	92	420-146-055	95
	410-880-001	46	420-050-006	92	420-146-075	95
60	410-880-002	46	420-050-007	92	420-146-090	95
	410-880-003	46	420-050-101	92	420-146-152	93
2	410-880-004	46	420-050-102	92	420-146-153	93
	410-880-005	46	420-050-103	92	420-147-040	95
40	410-880-006	46	420-050-104	92	420-147-055	95
	410-880-007	46	420-050-106	92	420-147-075	95
30	410-880-008	46	420-050-107	92	420-147-090	95
1	410-880-009	46	420-052-001	92	420-147-140	93
	410-880-010	46	420-052-002	92	420-148-150	93
20	410-880-011	46	420-052-003	92	420-150-001	101
10						
INCH						
MM						

420-150-002	101	420-220-030	243	420-260-113	139
420-150-003	101	420-220-040	243	420-310-190	144
420-150-004	101	420-220-050	243	420-311-190	144
420-150-005	101	420-220-060	243	420-364-000	168
420-150-006	101	420-220-070	243	420-365-000	168
420-150-007	101	420-220-212	130	420-365-050	168
420-150-008	101	420-220-220	130	420-366-000	169
420-150-160	102	420-221-010	243	420-367-000	169
420-150-165	102	420-221-020	243	420-367-002	169
420-150-180	103	420-221-030	243	420-370-210	129
420-184-100	137	420-221-040	243	420-370-212	129
420-184-130	137	420-221-050	243	420-370-400	129
420-185-100	137	420-221-060	243	420-371-210	129
420-186-100	138	420-221-070	243	420-375-165	103
420-186-140	138	420-221-200	130	420-390-190	144
420-187-130	135	420-222-000	243	420-391-000	245
420-187-155	137	420-222-001	243	420-391-001	245
420-187-255	137	420-222-002	243	420-391-002	245
420-189-210	131	420-222-003	243	420-391-115	246
420-190-003	132	420-222-004	243	420-392-003	150
420-191-003	132	420-223-170	123	420-392-004	150
420-195-000	42	420-226-001	244	420-392-005	150
420-195-150	132	420-226-002	244	420-393-003	150
420-196-000	42	420-226-003	244	420-393-004	150
420-196-005	42	420-226-101	244	420-393-005	150
420-196-006	42	420-226-102	244	420-395-205	144
420-196-007	42	420-226-103	244	420-395-240	244
420-196-008	42	420-228-000	244	420-396-190	245
420-196-009	42	420-229-100	244	420-397-210	245
420-196-010	42	420-235-110	139	420-398-190	247
420-196-012	42	420-236-110	139	420-398-210	245
420-196-015	42	420-237-095	140	420-400-001	126
420-196-020	42	420-237-195	140	420-400-002	126
420-196-025	42	420-238-095	140	420-401-001	112, 246
420-201-260	108	420-238-195	140	420-401-002	112, 246
420-209-175	132	420-239-090	140	420-401-100	113, 246
420-210-003	109	420-239-095	140	420-401-101	113, 246
420-210-013	109	420-239-190	140	420-401-102	113, 246
420-210-175	106	420-239-195	140	420-401-103	113, 246
420-210-200	105	420-250-160	140	420-401-190	113
420-211-160	105	420-253-185	144	420-402-190	113
420-211-200	105	420-255-160	140	420-405-120	112
420-213-140	132	420-256-135	139	420-406-120	112
420-213-180	127	420-260-005	139	420-407-005	111
420-220-010	243	420-260-008	139	420-407-007	111
420-220-020	243	420-260-013	139	420-407-009	111

250	420-407-011	111	420-492-210	163	420-568-002	157
240	420-408-003	129	420-493-165	163	420-568-003	157
	420-408-004	129	420-493-210	163	420-568-004	157
230	420-409-120	114	420-494-210	163	420-568-005	157
	420-410-140	114	420-520-140	136	420-568-006	157
220	420-411-200	105	420-520-141	136	420-568-007	157
	420-413-140	114	420-523-140	136	420-580-002	156
210	420-413-230	108	420-523-141	136	420-580-003	156
8	420-414-120	110, 213	420-530-165	148	420-580-004	156
200	420-415-120	110, 213	420-531-165	148	420-580-007	156
	420-416-120	110, 213	420-532-165	148	420-580-009	156
190	420-418-140	113	420-532-200	143	420-580-012	156
	420-419-140	113	420-533-165	148	420-582-003	156
7	420-420-140	113	420-539-220	148	420-582-045	156
	420-421-001	114	420-540-180	145	420-587-008	154
170	420-421-002	114	420-541-180	145	420-587-010	154
	420-421-003	114	420-543-210	147	420-587-012	154
160	420-422-190	126	420-544-165	149	420-587-014	154
6	420-427-200	253	420-546-130	141	420-587-016	154
150	420-450-230	130	420-546-180	141	420-589-008	154
	420-451-230	130	420-546-200	141	420-589-010	154
140	420-452-230	130	420-547-004	148	420-589-012	154
	420-455-230	131	420-547-005	148	420-589-014	154
5	420-459-001	155	420-547-006	31, 149	420-589-016	154
120	420-459-002	155	420-548-180	142	420-590-004	150
	420-459-003	155	420-549-200	187	420-591-004	150
110	420-459-101	155	420-550-170	150	420-594-002	157
	420-459-102	155	420-550-210	146	420-594-003	157
4	420-459-103	155	420-550-225	147	420-594-004	157
100	420-460-001	155	420-550-230	146	420-594-005	157
	420-460-002	155	420-551-170	151	420-594-006	157
90	420-460-003	155	420-551-175	147	420-594-008	157
80	420-472-002	156	420-551-180	149	420-594-010	157
3	420-472-003	156	420-551-200	146	420-594-012	157
70	420-480-200	164	420-551-210	145	420-595-170	151
	420-487-009	156	420-552-130	132	420-605-160	159
60	420-487-011	156	420-552-170	151	420-606-160	159
	420-487-013	156	420-552-200	147	420-639-001	154
2	420-487-015	156	420-552-215	143	420-639-002	154
40	420-488-200	164	420-553-220	146	420-639-003	154
	420-490-210	163	420-554-178	142	420-640-001	154
30	420-491-000	155	420-554-190	142	420-640-002	154
	420-491-001	155	420-555-195	131	420-640-003	154
1	420-491-002	155	420-555-200	143	420-650-001	160
20	420-491-210	163	420-556-200	143	420-650-002	160
10	420-492-165	163	420-557-170	131	420-650-050	165
INCH						
MM						

420-650-100	164	420-700-120	172	430-130-100	237
420-650-101	164	420-700-140	172	430-130-105	237
420-652-100	139	420-700-160	172	430-130-500	231
420-653-000	165	420-700-180	172	430-130-510	231
420-654-180	159	420-700-200	171	430-130-520	231
420-655-180	159	420-700-210	171	430-130-560	231
420-656-000	162	420-700-330	173	430-140-110	230
420-657-180	159	420-700-340	173	430-140-140	230
420-658-175	160	420-700-400	171	430-142-120	230
420-660-000	161	420-700-430	174	430-144-160	230
420-660-100	166	420-700-501	171	430-150-130	230
420-660-101	166	420-700-502	171	430-155-000	228
420-660-102	166	420-700-610	173	430-245-200	242
420-660-103	166	420-700-611	173	430-250-090	231
420-660-104	166	420-700-620	173	430-250-110	231
420-660-105	166	420-700-630	174	430-250-130	231
420-660-106	166	420-700-640	174	430-250-150	231
420-660-107	166	420-700-650	174	430-256-001	236
420-660-108	166	420-700-700	172	430-256-002	236
420-660-109	166	420-700-777	174	430-256-003	236
420-660-110	166	420-700-888	174	430-256-010	231
420-660-150	166	420-702-175	157	430-257-001	236
420-660-200	163, 166	420-703-175	157	430-257-002	236
420-660-214	163	420-704-175	157	430-257-003	236
420-660-216	163	420-706-175	157	430-257-004	236
420-660-218	163	420-743-040	99	430-257-005	236
420-660-219	163	420-743-055	99	430-271-150	229
420-660-500	166	420-743-075	99	430-297-140	229
420-661-000	161	420-743-090	99	430-297-150	229
420-661-100	162	420-752-100	139	430-298-001	236
420-662-001	161	430-000-002	238	430-298-002	236
420-662-002	161	430-000-003	238	430-298-003	236
420-670-210	160	430-000-004	238	430-298-004	236
420-672-000	163	430-000-005	238	430-300-230	242
420-675-200	165	430-010-002	238	430-309-001	237
420-700-001	171	430-010-003	238	430-309-002	237
420-700-002	171	430-010-004	238	430-309-003	237
420-700-020	172	430-010-005	238	430-309-004	237
420-700-022	172	430-129-001	237	430-309-005	237
420-700-023	172	430-129-002	237	430-309-006	237
420-700-024	172	430-129-003	237	430-309-007	237
420-700-025	172	430-130-070	237	430-309-008	237
420-700-030	172	430-130-075	237	430-309-009	237
420-700-040	172	430-130-080	237	430-310-001	236
420-700-060	172	430-130-085	237	430-310-002	236
420-700-100	172	430-130-095	237	430-310-003	236

250	430-310-004	236	430-350-007	230	431-630-006	29
240	430-310-009	232	430-350-009	230	431-630-007	29, 31
	430-310-010	232	430-350-010	230	431-630-009	29, 31
230	430-310-011	232	430-355-000	239	431-630-011	29, 31
	430-310-012	232	430-355-001	239	431-636-195	31
220	430-310-110	232	430-355-002	239	440-030-200	253
	430-315-001	237	430-361-190	228	440-120-120	264
210	430-315-002	237	430-362-170	228	440-120-140	264
8	430-315-003	237	430-385-190	228	440-130-140	263
200	430-315-010	233	430-397-190	229	440-221-160	264
	430-320-000	239	430-500-260	259	500-384-010	160
190	430-320-065	238	430-505-205	260	500-386-045	160
	430-320-075	238	430-510-220	250	500-387-000	160
7	430-320-090	238	430-524-210	242	600-150-005	90
	430-320-102	238	430-600-215	249	600-402-140	90
170	430-320-115	238	430-600-230	249	600-402-195	90
	430-325-001	238	430-601-220	249	600-402-255	90
160	430-325-002	238	430-601-230	249	600-402-260	90
6	430-325-003	238	430-602-175	260	700-010-150	178
150	430-325-004	238	430-602-230	249	700-010-180	178
	430-325-005	238	430-604-280	257	700-010-200	178
140	430-326-000	235	430-605-270	257	700-010-220	178
5	430-326-002	234, 235	430-606-040	258	700-011-150	178
	430-326-003	235	430-607-040	258	700-011-180	178
120	430-326-004	235	430-620-000	257	700-011-200	178
	430-326-005	235	430-620-220	254	700-011-220	178
110	430-326-006	235	430-631-002	253	700-012-150	178
4	430-326-007	235	430-650-001	258	700-012-180	178
100	430-326-008	235	430-650-002	258	700-012-200	178
	430-326-009	235	430-650-003	258	700-012-220	178
90	430-326-010	235	430-650-100	258	700-013-150	178
	430-326-011	235	430-656-190	241	700-013-180	178
3	430-326-012	235	430-670-235	250	700-013-200	178
	430-326-013	235	430-788-012	262	700-013-220	178
70	430-326-014	235	430-788-014	262	700-020-150	178
	430-326-015	235	430-788-016	262	700-020-180	178
60	430-326-016	235	430-788-018	262	700-020-200	178
2	430-326-017	235	430-813-010	262	700-020-220	178
50	430-326-100	235	430-813-020	262	700-021-150	178
40	430-327-000	233	430-813-030	262	700-021-180	178
	430-327-001	233	430-813-040	262	700-021-200	178
30	430-327-002	233	430-813-050	262	700-021-220	178
1	430-327-003	233	431-629-009	30	700-022-150	178
20	430-327-004	233	431-629-011	30	700-022-180	178
	430-349-145	229	431-629-014	30	700-022-200	178
10	430-350-005	230	431-629-016	30	700-022-220	178

700-023-150	178	700-060-220	179	700-601-735	176
700-023-180	178	700-060-250	179	700-610-150	176
700-023-200	178	700-062-180	179	700-610-180	176
700-023-220	178	700-062-200	179	700-610-200	176
700-030-150	178	700-062-220	179	700-610-220	176
700-030-180	178	700-062-250	179	700-611-150	176
700-030-200	178	700-070-180	179	700-611-180	176
700-030-220	178	700-070-220	179	700-612-150	176
700-031-150	178	700-070-250	179	700-612-180	176
700-031-180	178	700-072-180	179	700-612-200	176
700-031-200	178	700-072-200	179	700-613-150	176
700-031-220	178	700-072-220	179	700-613-180	176
700-032-150	178	700-072-250	179	700-620-150	176
700-032-180	178	700-080-180	179	700-620-180	176
700-032-200	178	700-080-220	179	700-620-200	176
700-032-220	178	700-080-250	179	700-620-220	176
700-033-150	178	700-082-180	179	700-621-150	176
700-033-180	178	700-082-200	179	700-621-180	176
700-033-200	178	700-082-220	179	700-622-150	176
700-033-220	178	700-082-250	179	700-622-180	176
700-040-150	178	700-420-001	175	700-622-200	176
700-040-180	178	700-420-002	175	700-622-220	176
700-040-200	178	700-600-160	175	700-623-150	176
700-040-220	178	700-600-161	175	700-623-180	176
700-041-150	178	700-600-165	175	700-630-150	176
700-041-180	178	700-600-195	175	700-630-180	176
700-041-200	178	700-600-201	175	700-630-200	176
700-041-220	178	700-600-202	175	700-630-220	176
700-042-150	178	700-600-213	175	700-631-150	176
700-042-180	178	700-600-214	175	700-631-180	176
700-042-200	178	700-600-220	175	700-632-150	176
700-042-220	178	700-600-221	175	700-632-180	176
700-043-150	178	700-600-225	175	700-632-200	176
700-043-180	178	700-600-231	175	700-632-220	176
700-043-200	178	700-600-232	175	700-633-150	176
700-043-220	178	700-601-710	176	700-633-180	176
700-050-180	179	700-601-711	176	700-640-150	176
700-050-200	179	700-601-712	176	700-640-180	176
700-050-220	179	700-601-713	176	700-640-200	176
700-050-250	179	700-601-714	176	700-640-220	176
700-052-180	179	700-601-715	176	700-641-150	176
700-052-200	179	700-601-730	176	700-641-180	176
700-052-220	179	700-601-731	176	700-642-150	176
700-052-250	179	700-601-732	176	700-642-180	176
700-060-180	179	700-601-733	176	700-642-200	176
700-060-200	179	700-601-734	176	700-642-220	176

250	700-643-150	176
240	700-643-180	176
	700-650-180	177
230	700-650-200	177
	700-650-220	177
220	700-650-240	177
	700-652-180	177
210	700-652-200	177
	700-652-220	177
200	700-652-240	177
	700-660-180	177
190	700-660-200	177
	700-660-220	177
180	700-660-240	177
	700-662-180	177
170	700-662-200	177
	700-662-220	177
160	700-662-240	177
	700-670-180	177
150	700-670-200	177
	700-670-201	177
140	700-670-203	177
	700-670-220	177
130	700-670-221	177
	700-670-223	177
120	700-670-240	177
	700-672-180	177
110	700-672-200	177
	700-672-201	177
100	700-672-203	177
	700-672-220	177
90	700-672-221	177
	700-672-223	177
80	700-672-240	177
	700-680-180	177
70	700-680-200	177
	700-680-220	177
60	700-680-240	177
	700-682-180	177
50	700-682-200	177
	700-682-220	177
40	700-682-240	177
30		
20		
10		
1		
20		
10		
INCH		
MM		